



CITY

60362



2

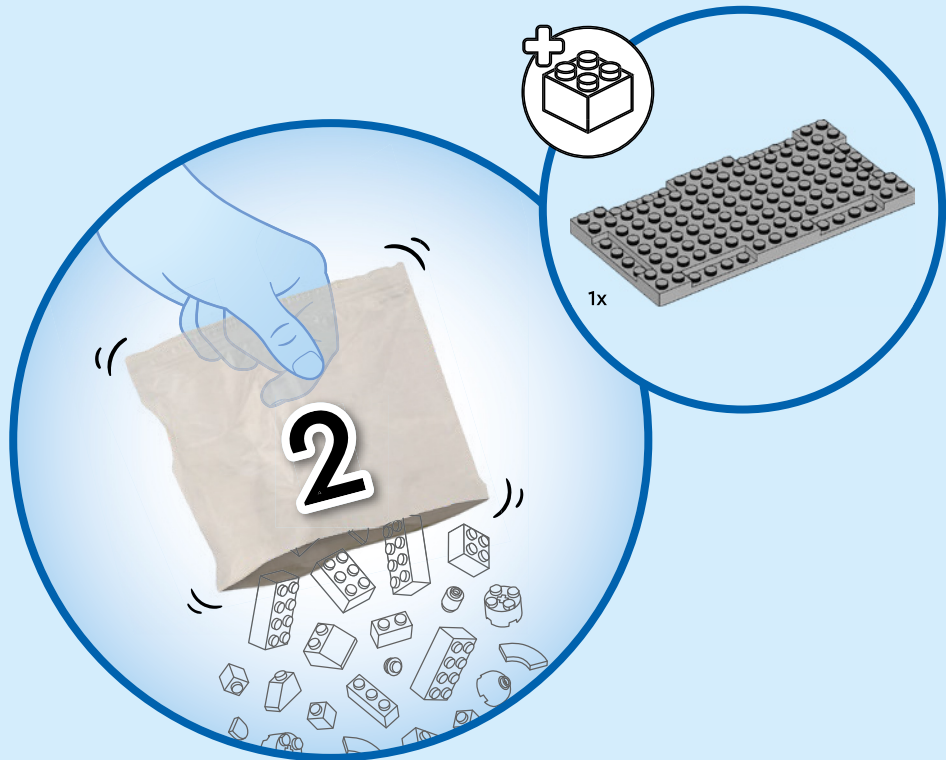

1

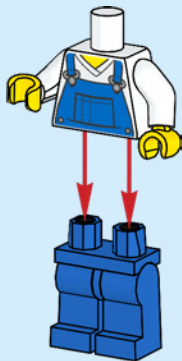

2



3



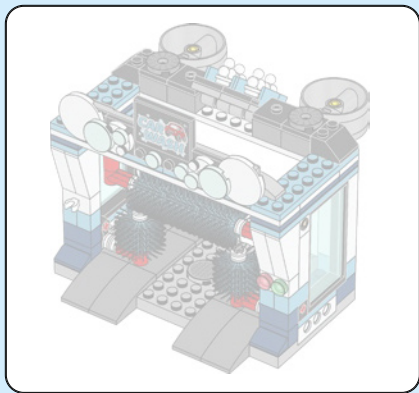

1

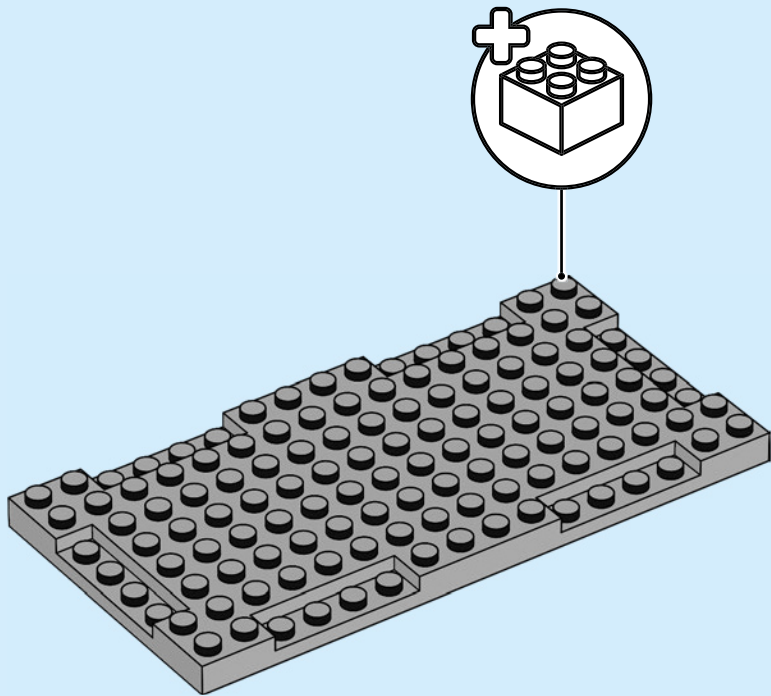



2x

2

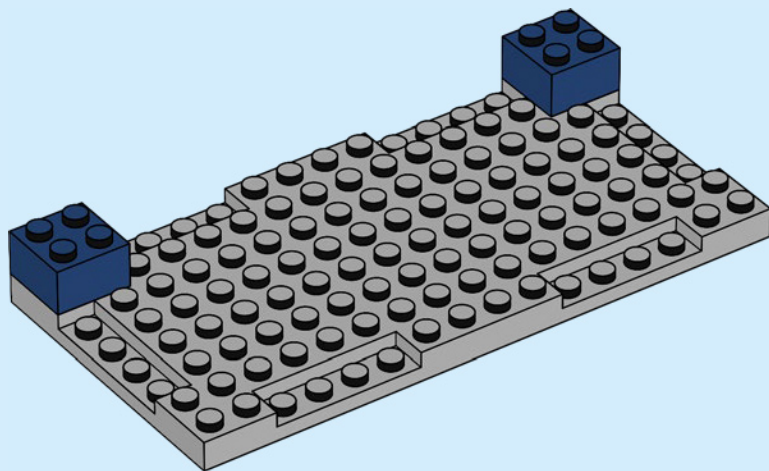

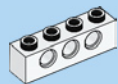

2x

3

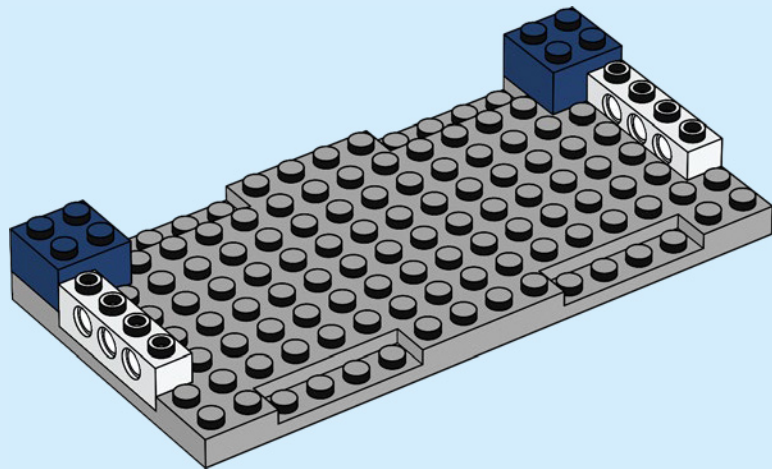

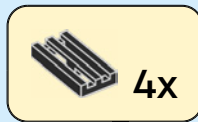
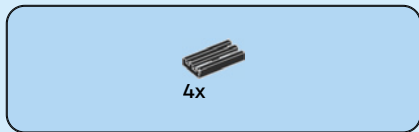

4

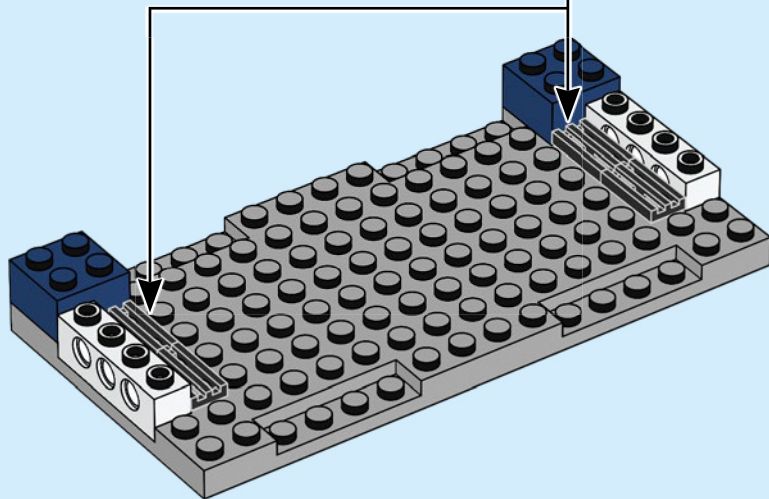



2x

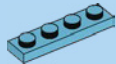

2x

5

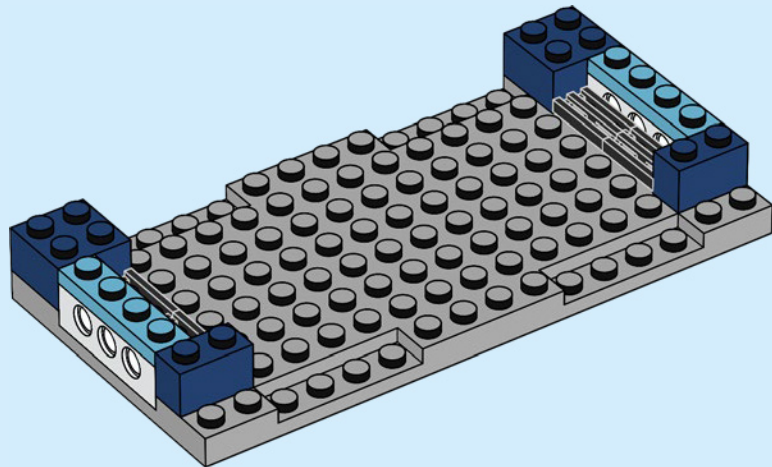





2x

6

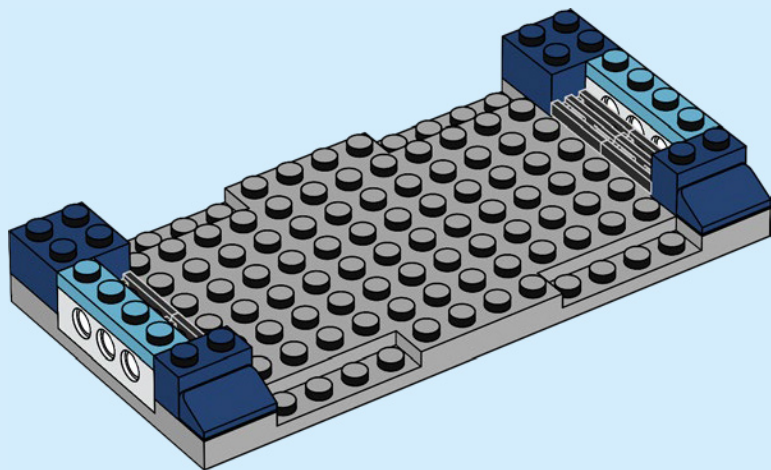

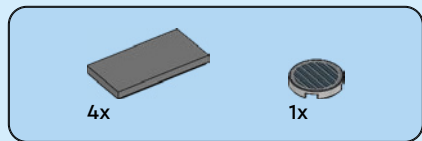

7

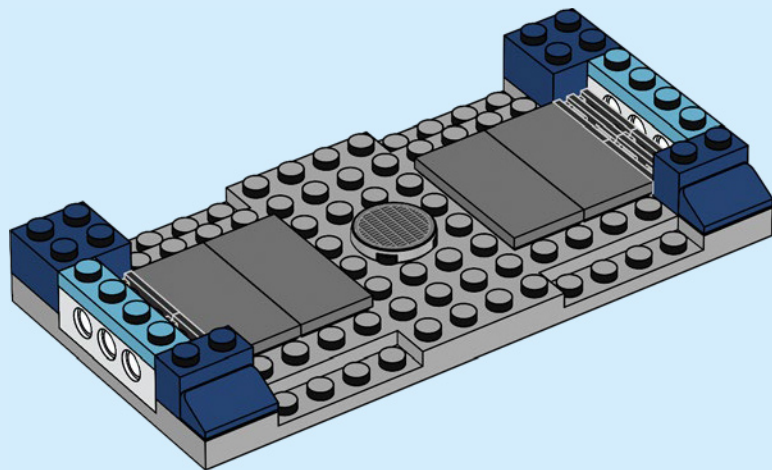

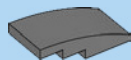

8x

8

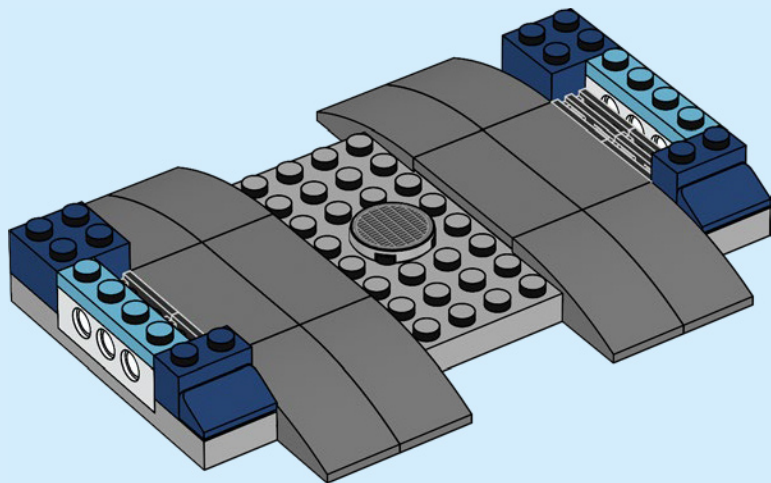

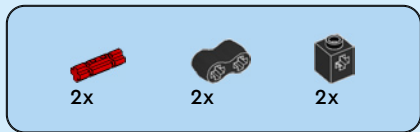

9

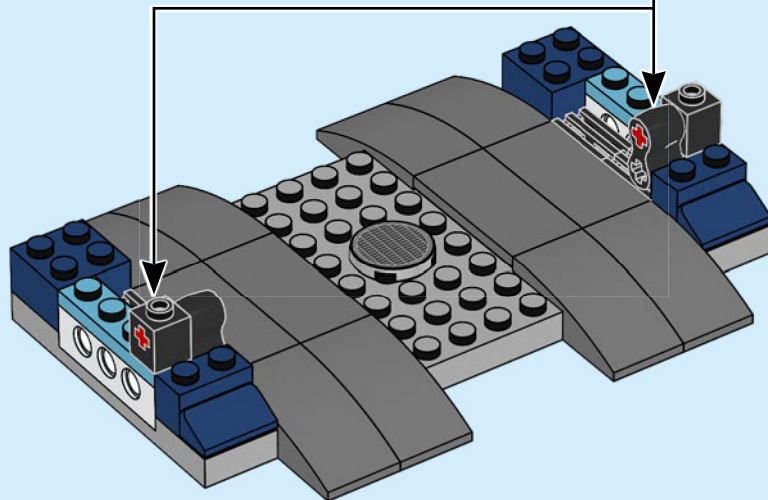
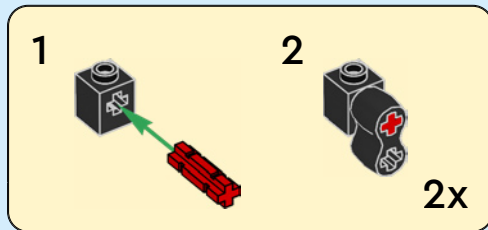

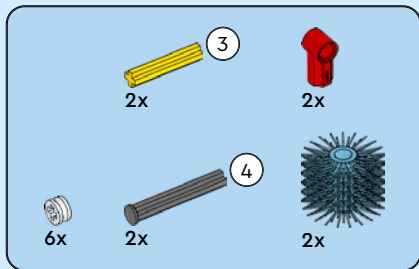
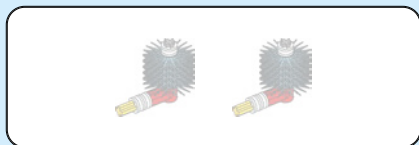

10

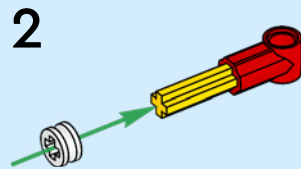
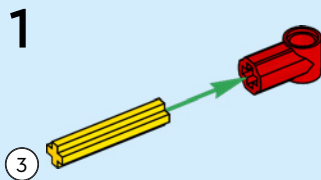
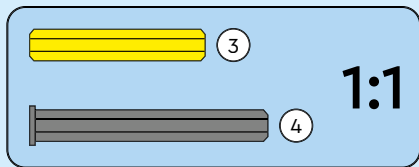

3

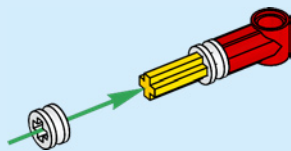

4

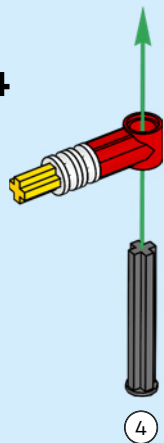

5

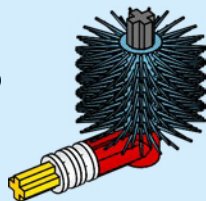

6

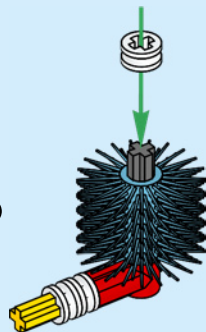

2x



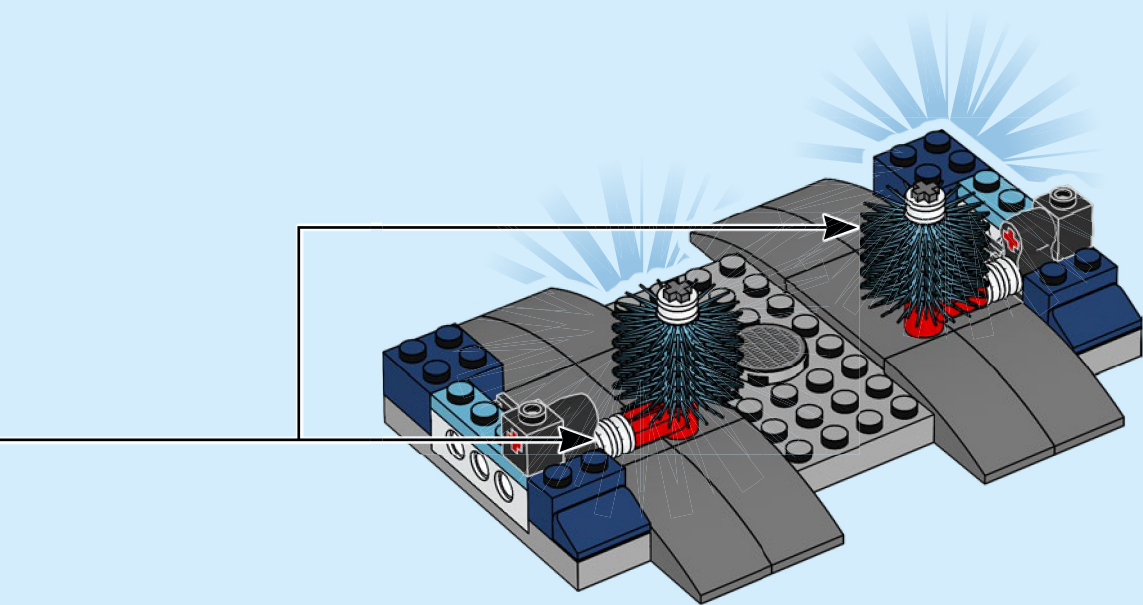



2x

11

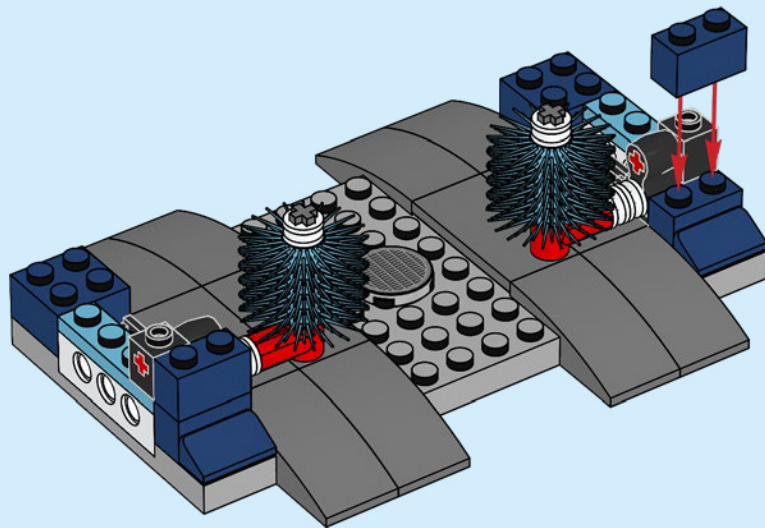





2x



2x

# 12

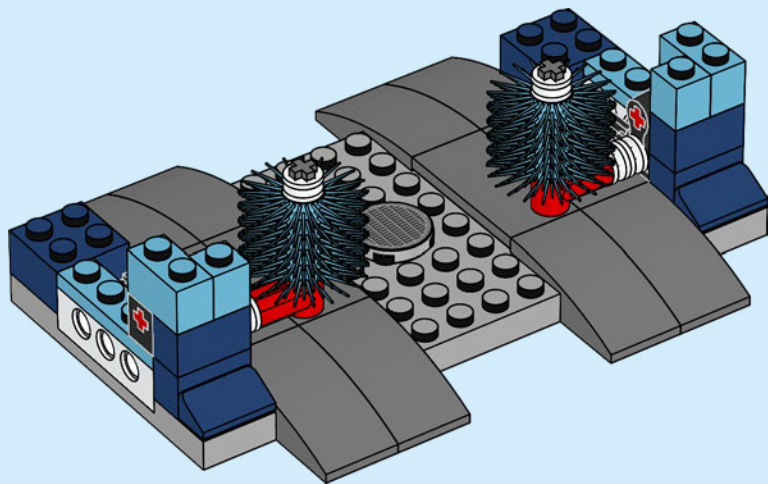



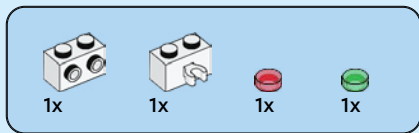

13

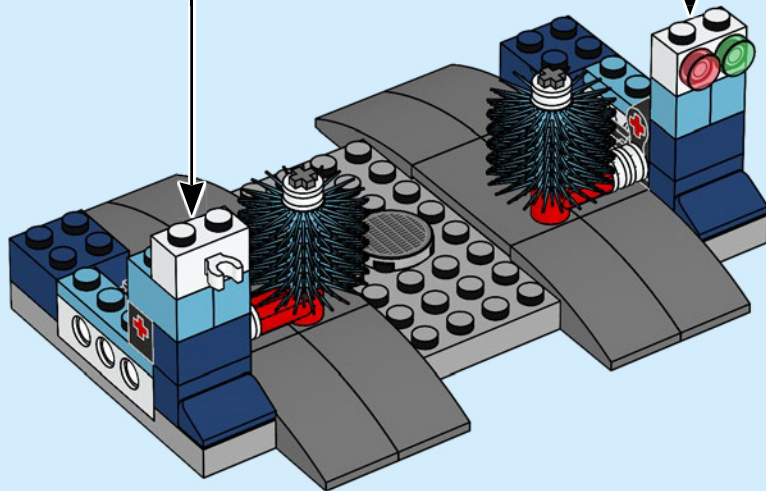
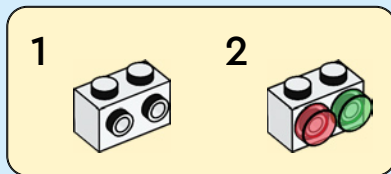
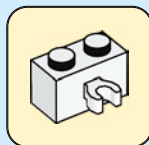



4x

14

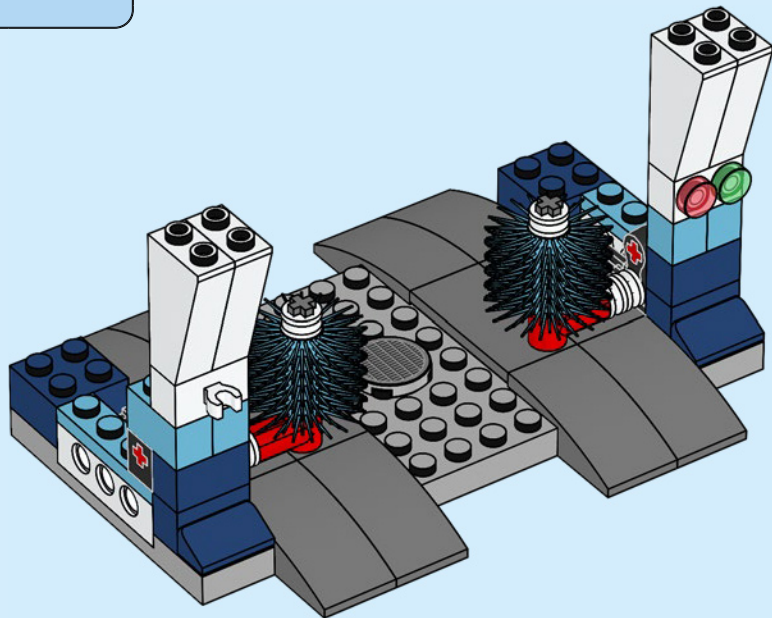

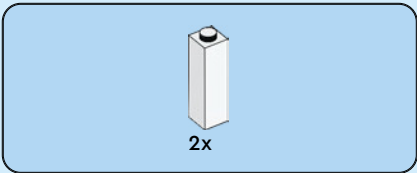

15

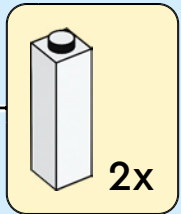
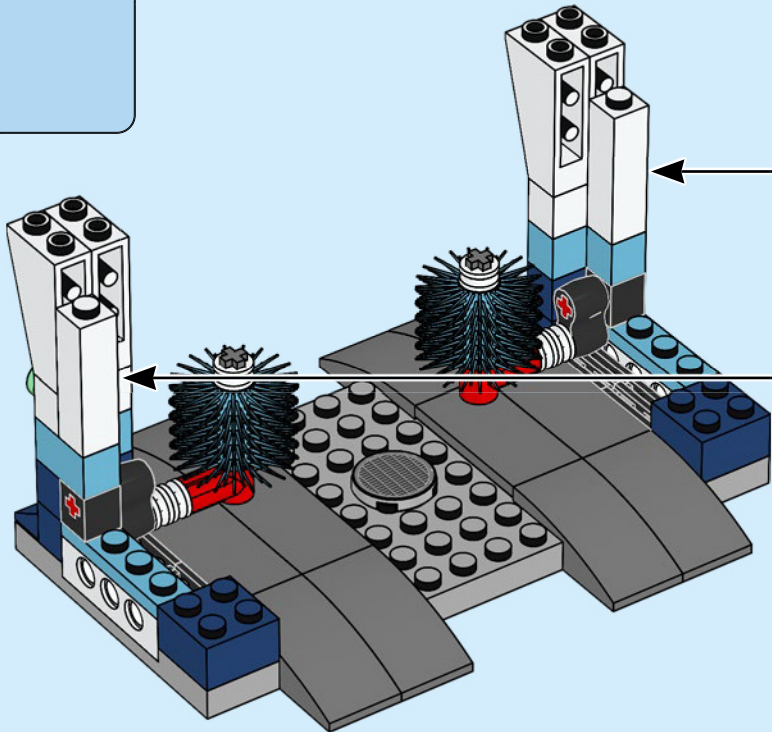

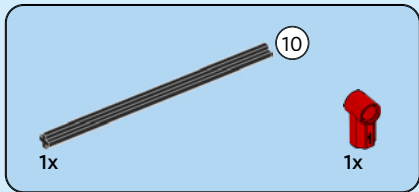
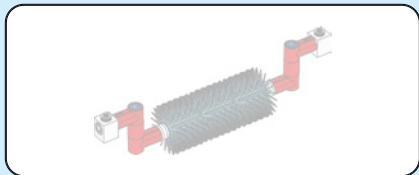

16

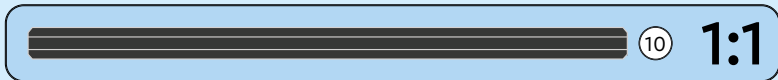
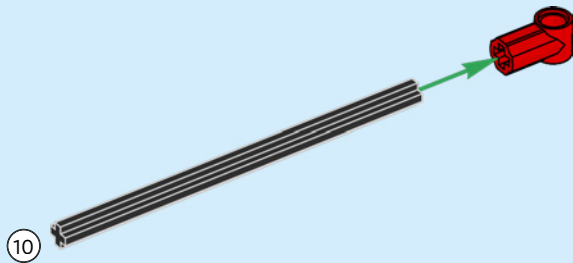



1x

17

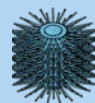
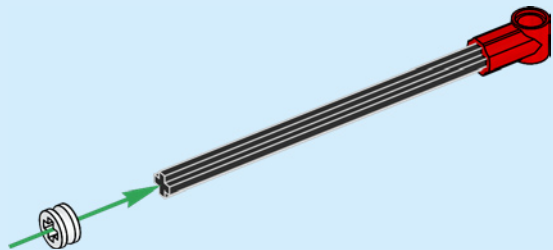

3x

18

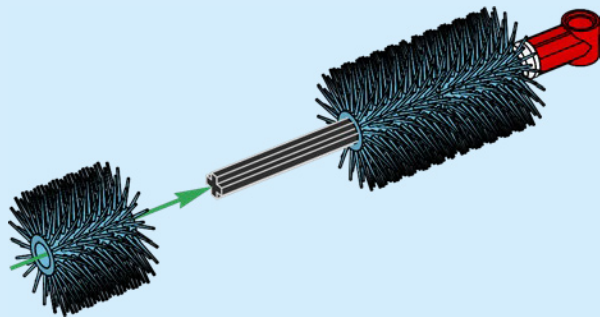



1x

19

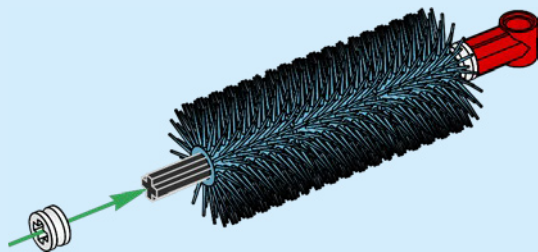





1x

20

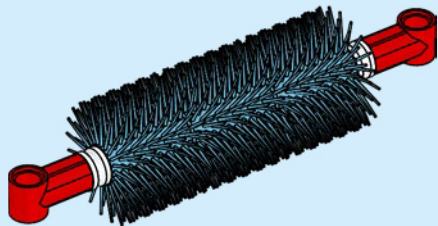

2x

21

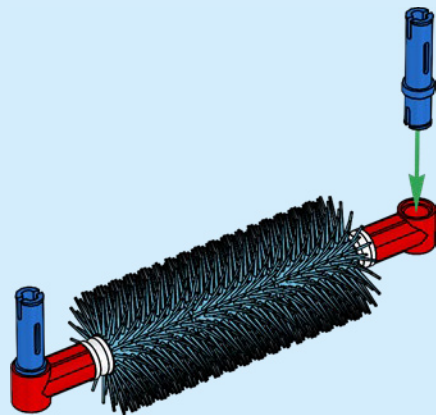



2x

22

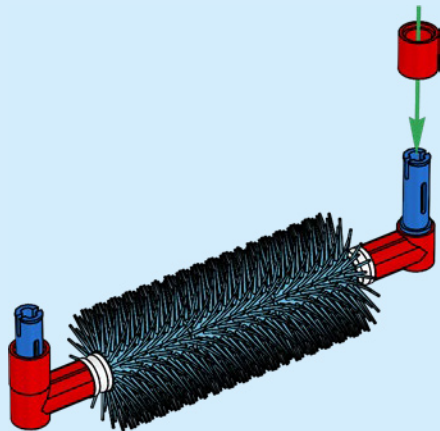



2x

23

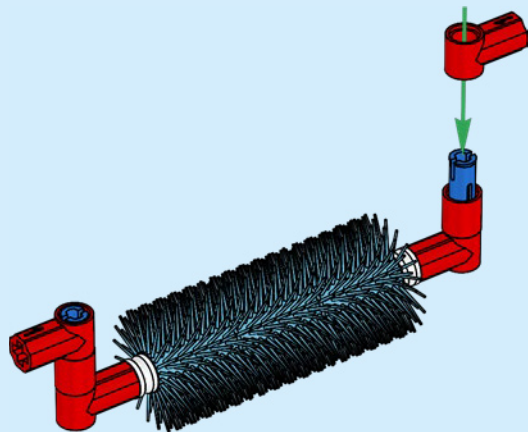

2x

24

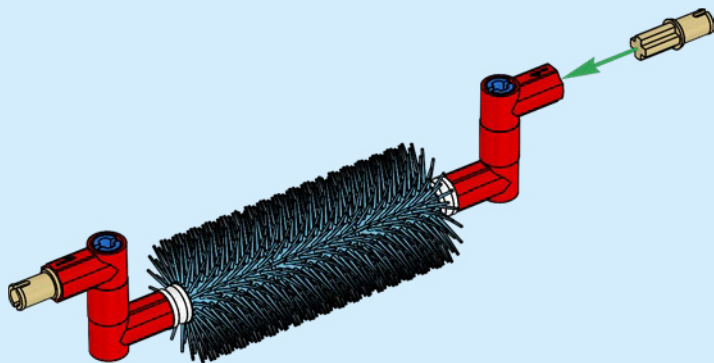



2x

25

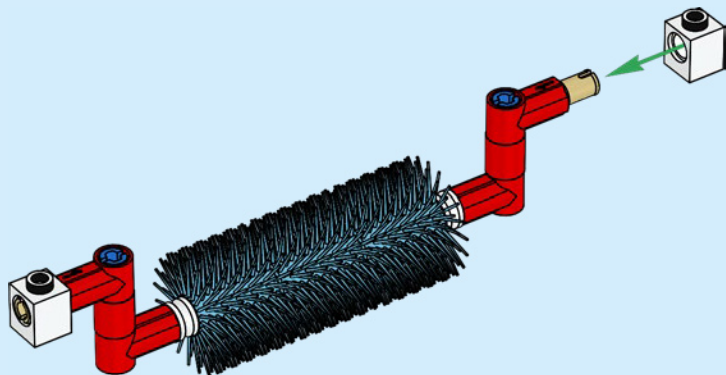

26

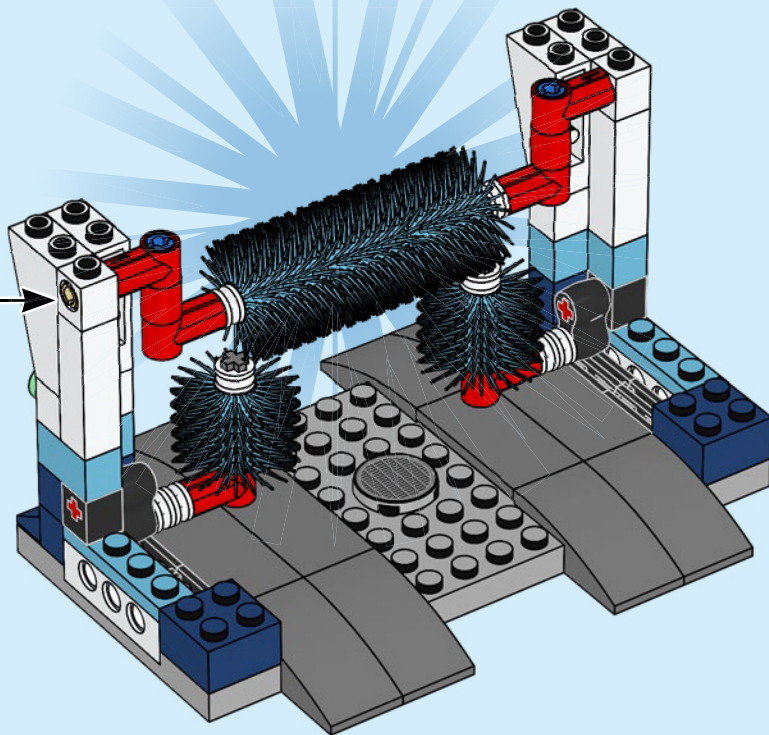

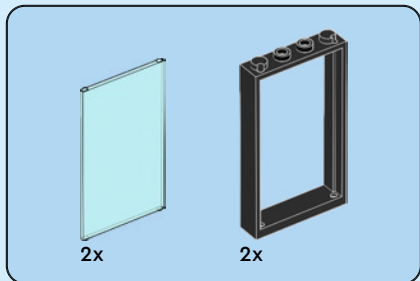

27

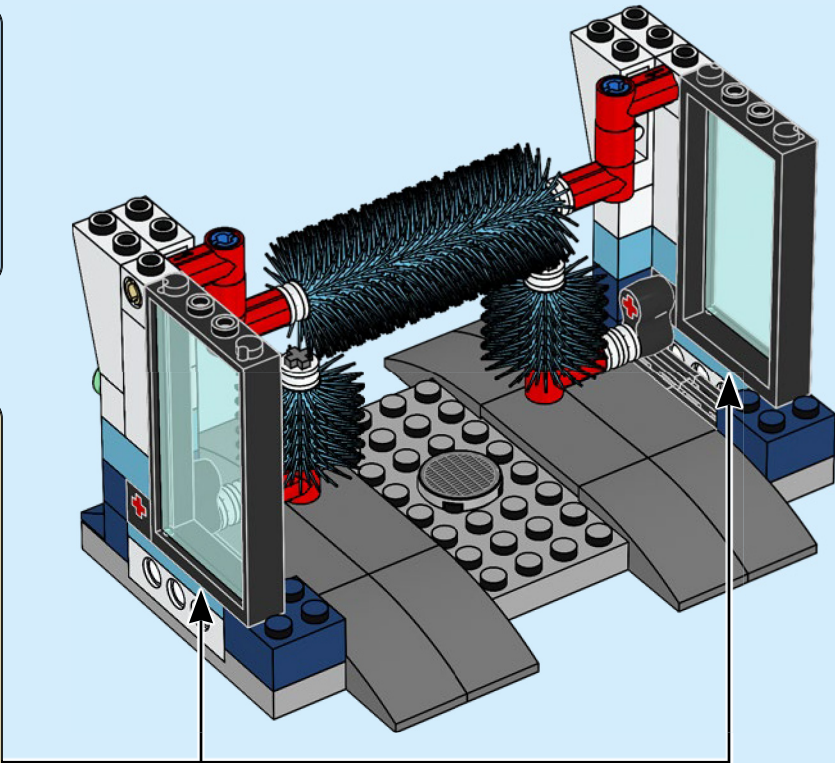
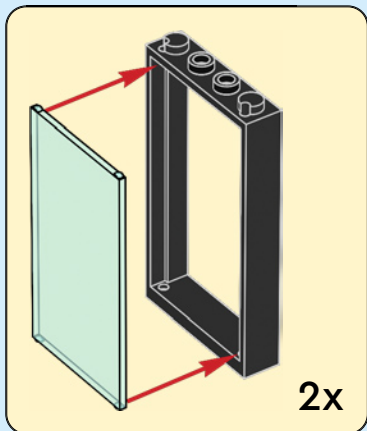

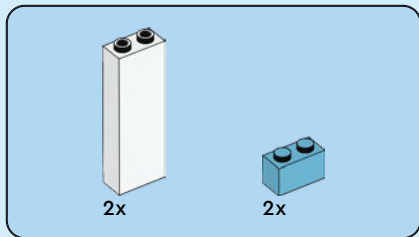

28

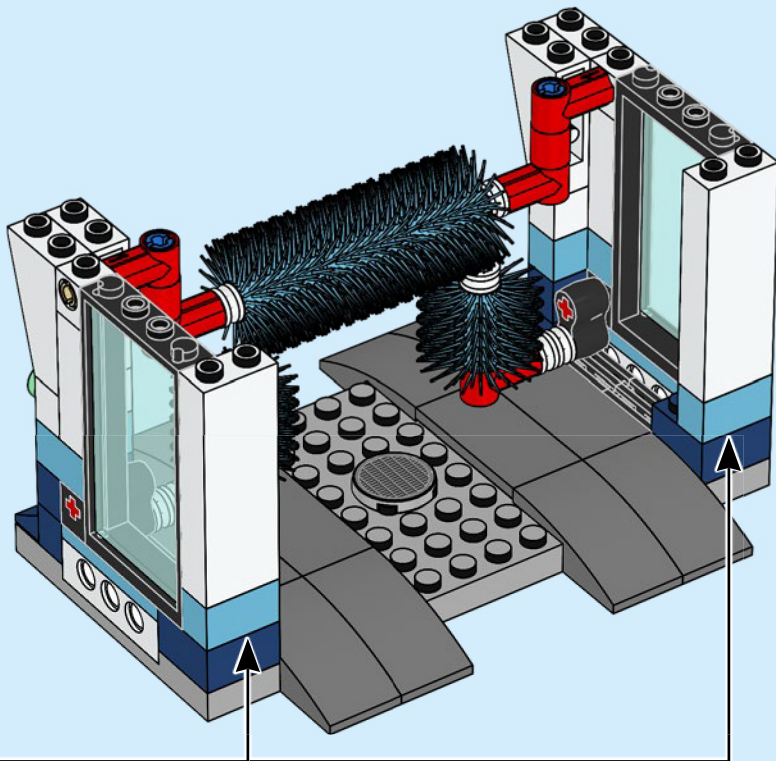
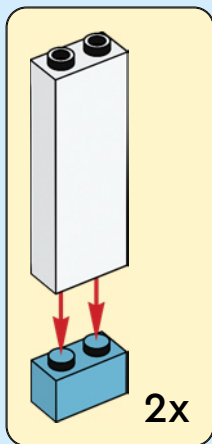

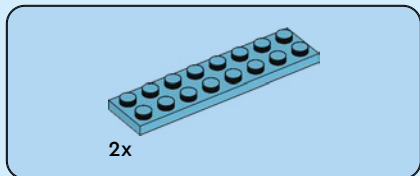

29

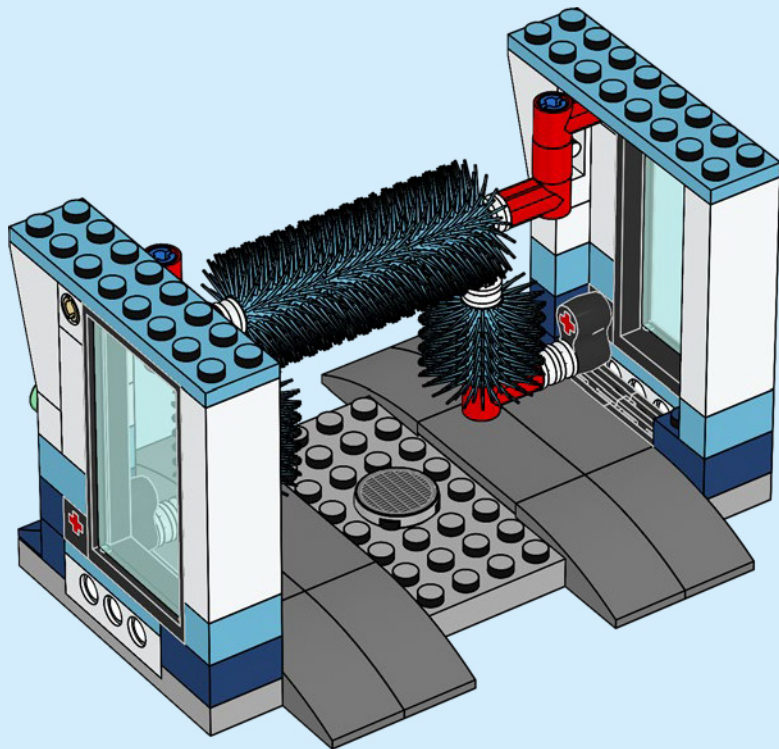



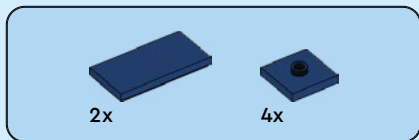

30

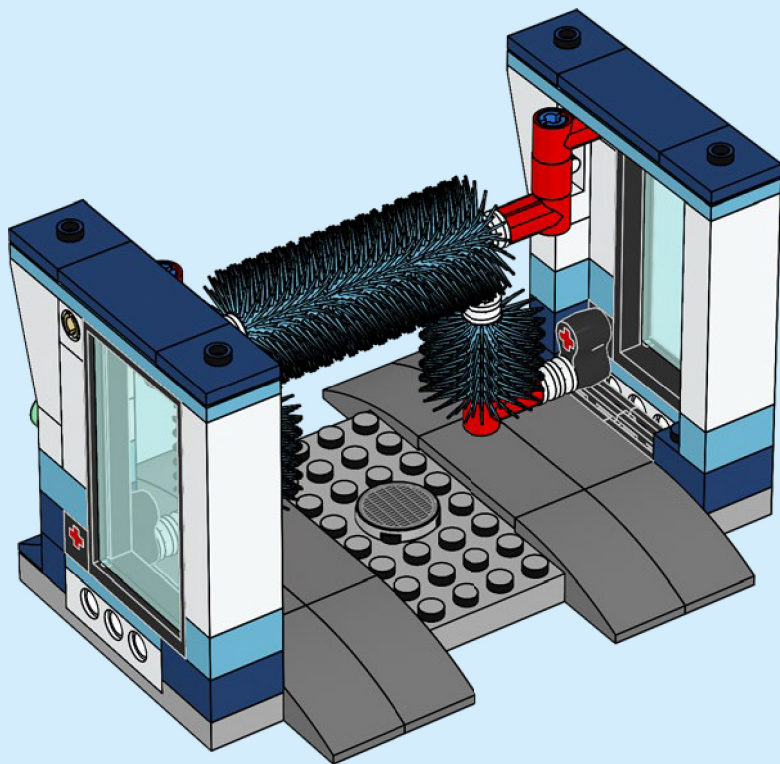



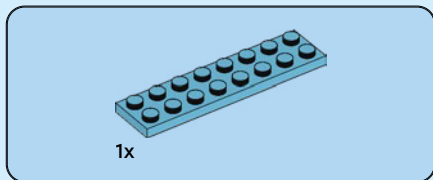
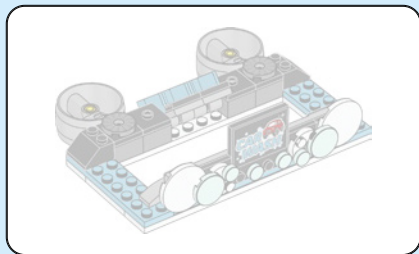

31

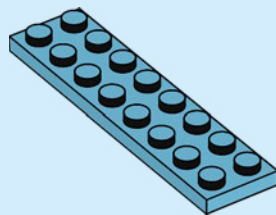

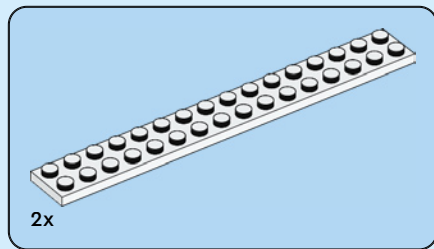

32

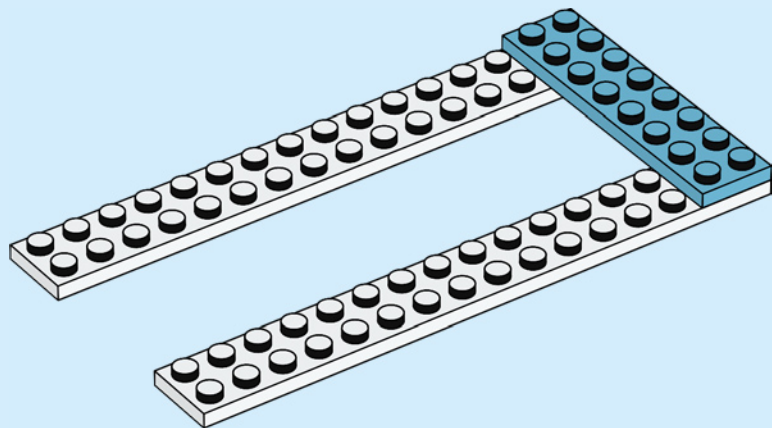

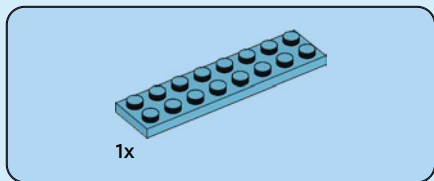

33

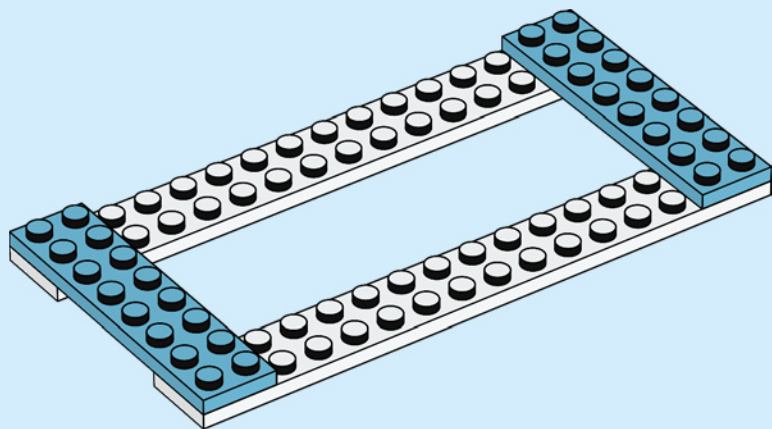



2x

34



2x

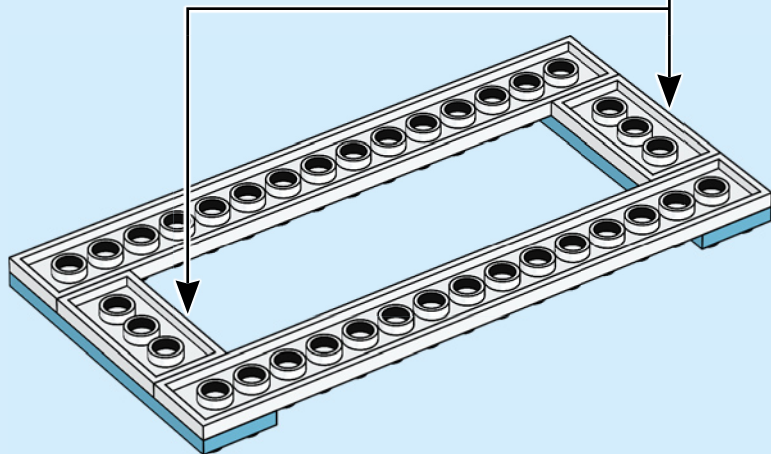

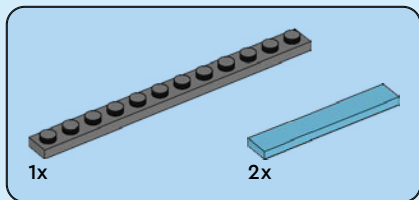

35

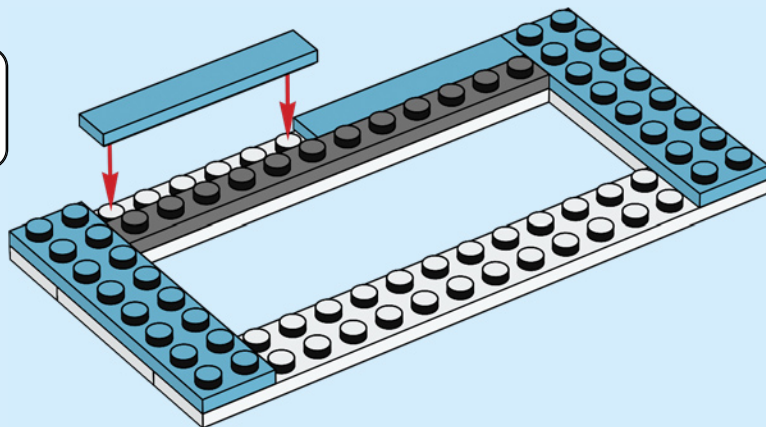



2x

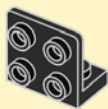

2x

36

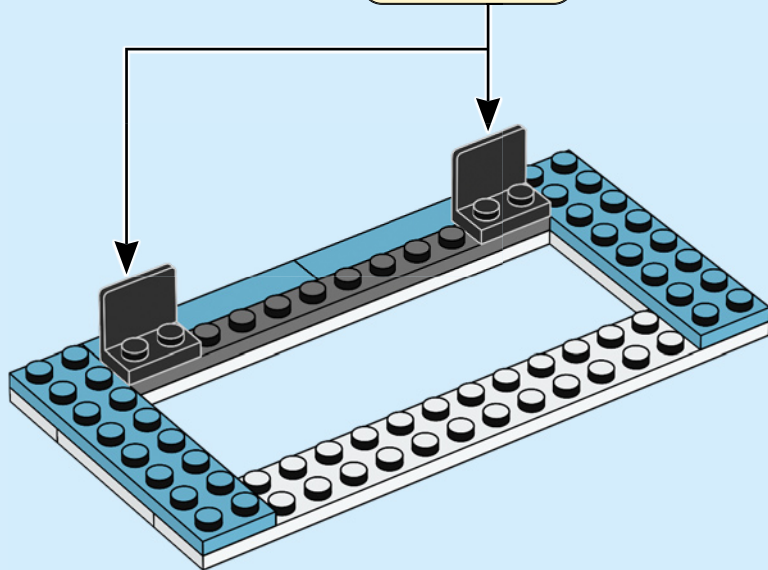



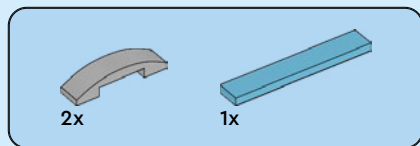

37

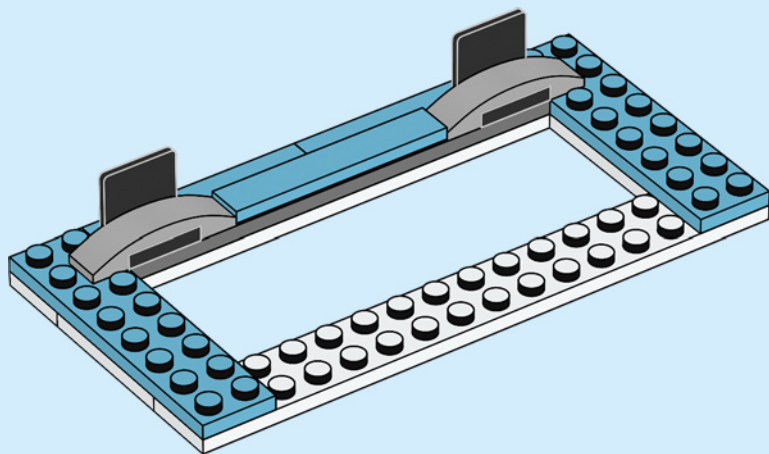



2x

38

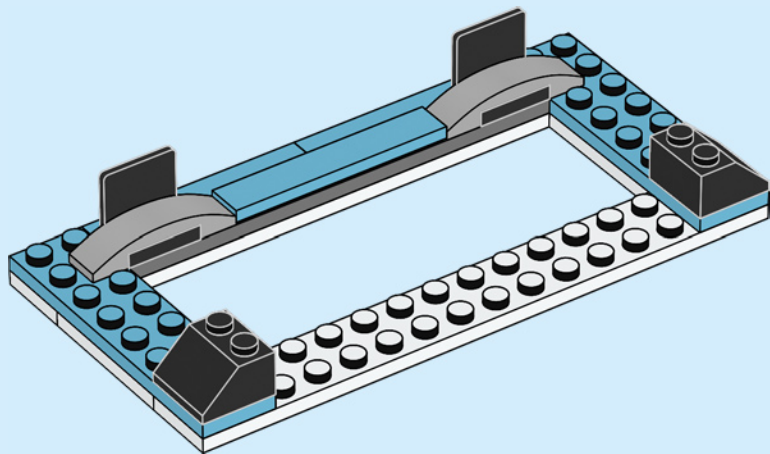

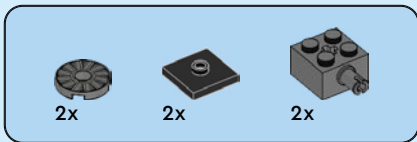

39

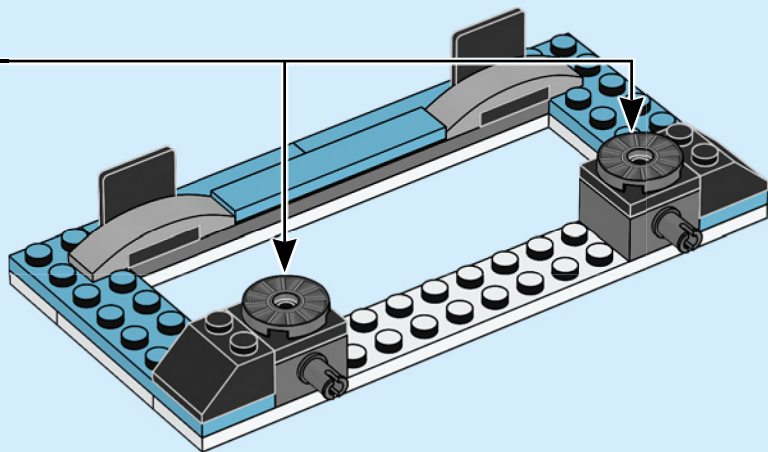
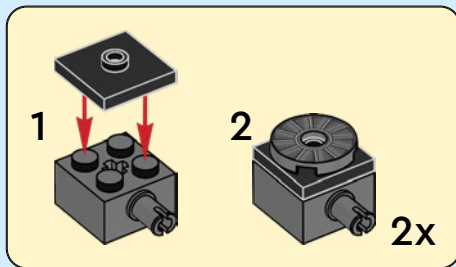

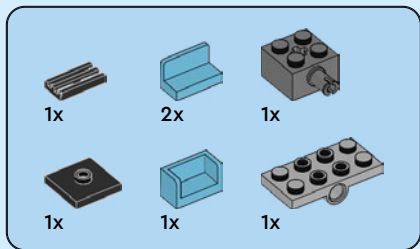

# 40

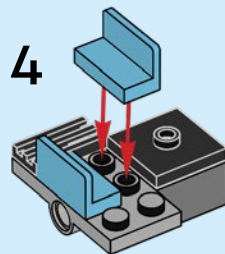
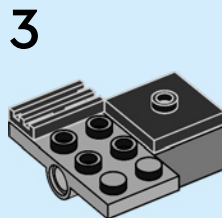
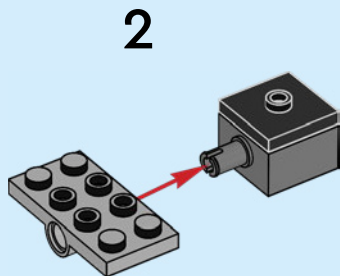
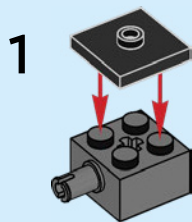

5

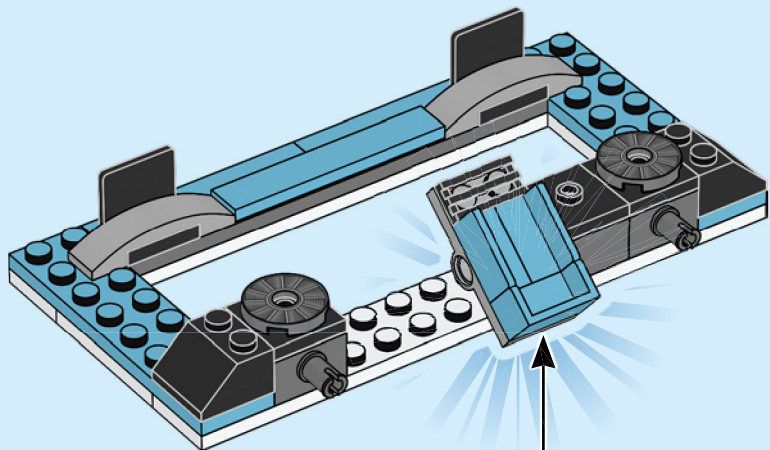
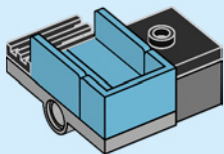

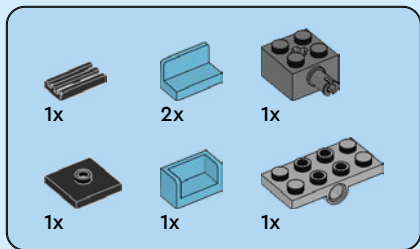

# 41

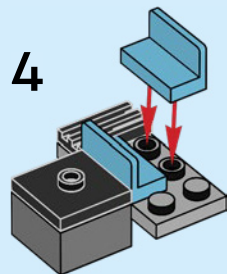
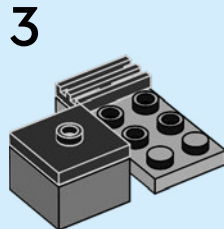
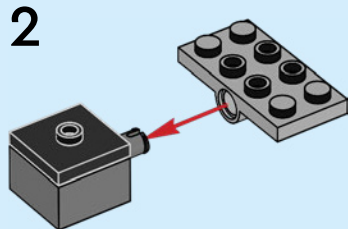
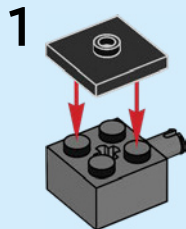

5

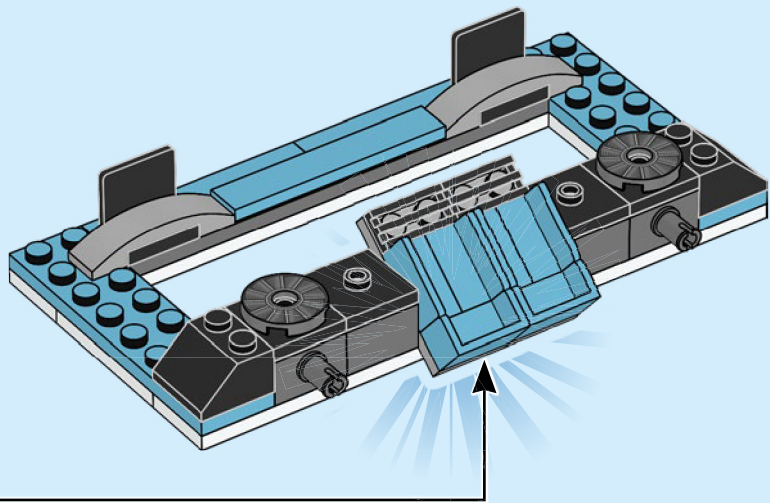
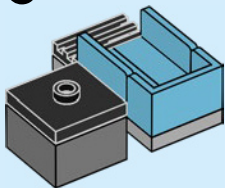

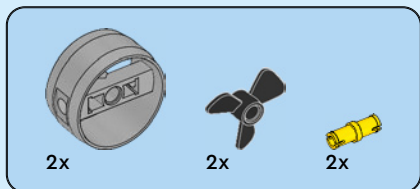

42

1

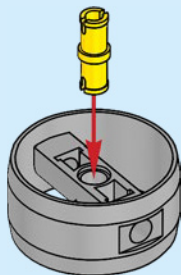

2

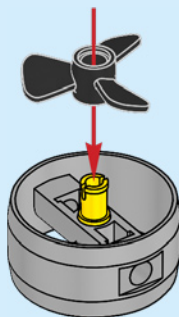

2x



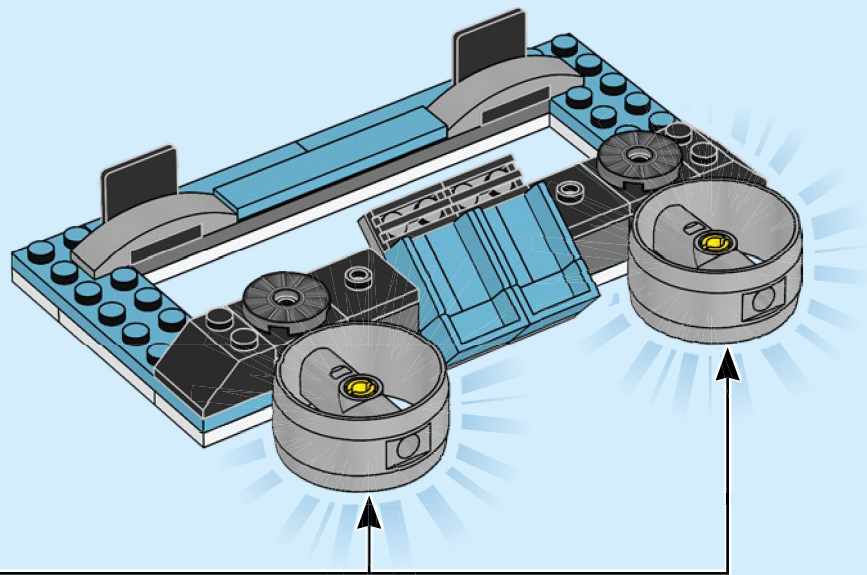

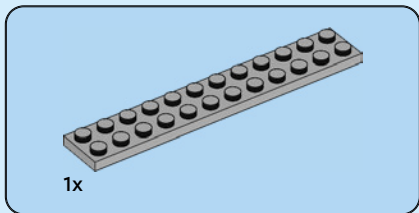
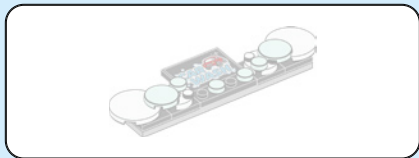

43

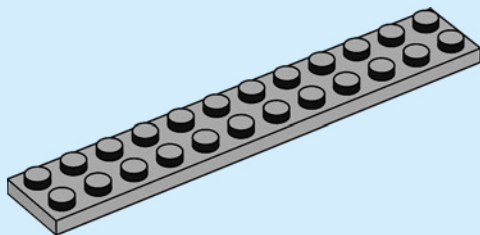



4x

44

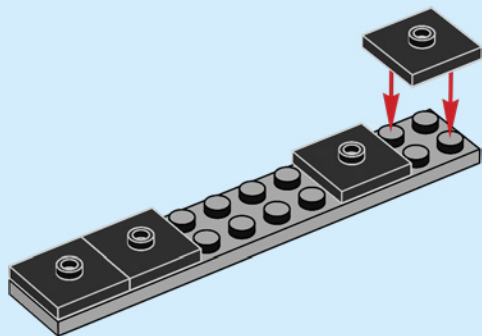

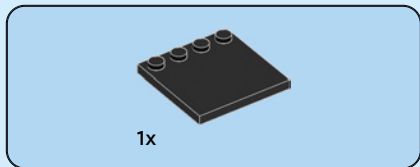

45

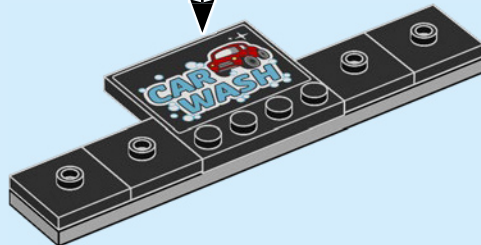
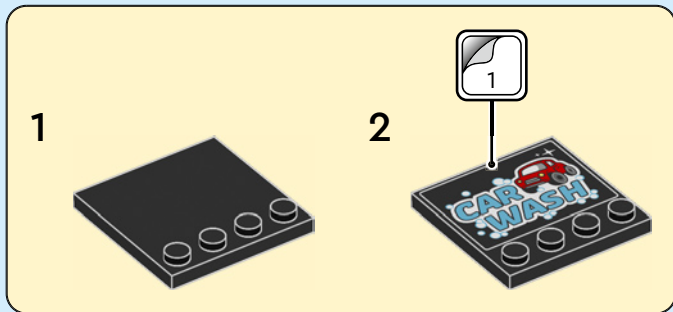



46



47





2x

48

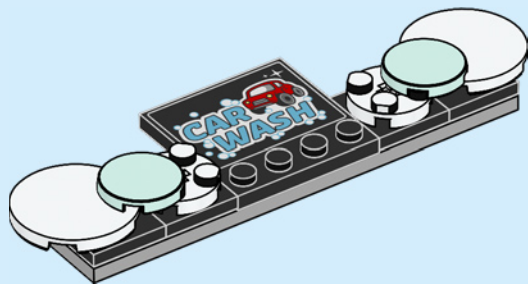

4x

49

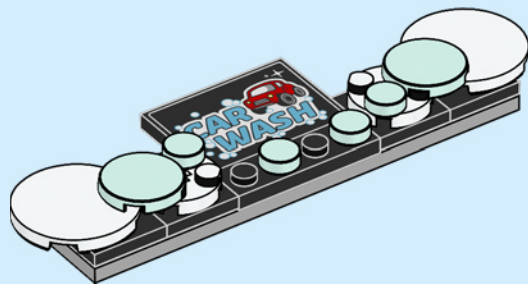

50

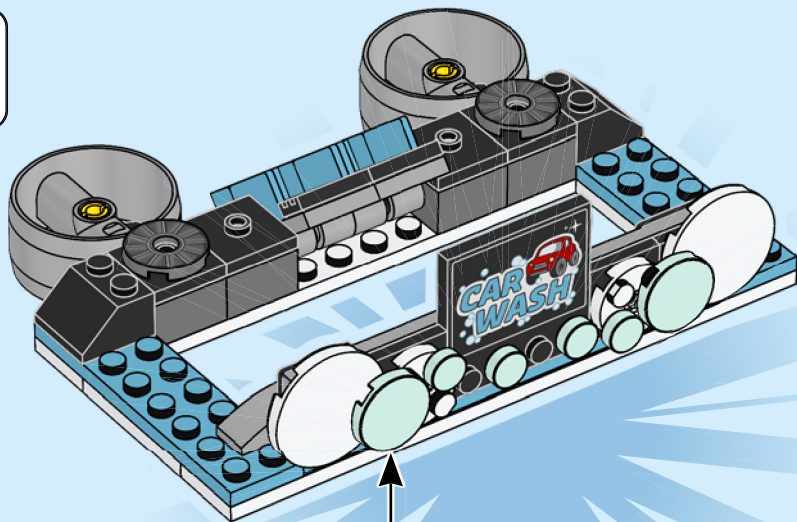

51

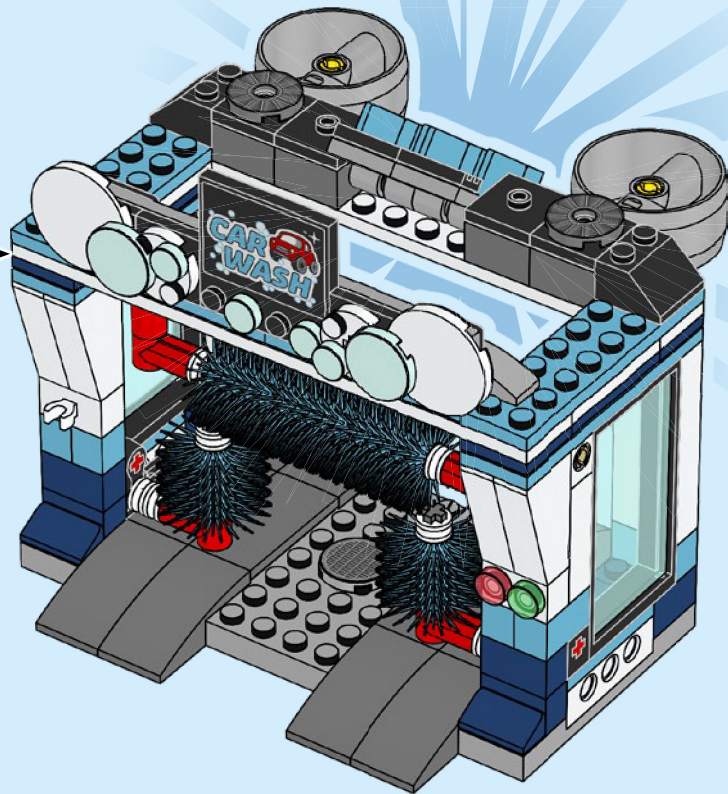





4x

52



4x

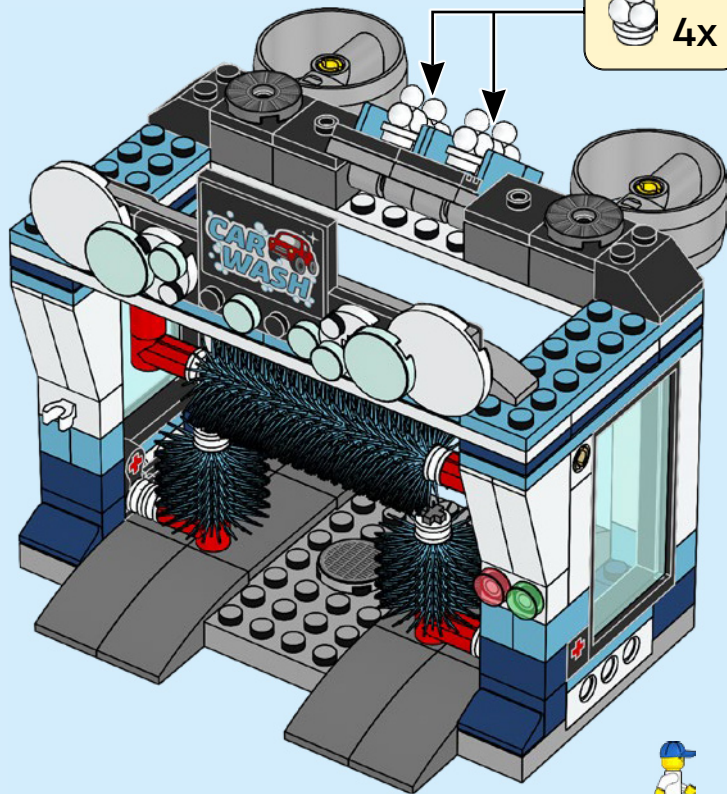

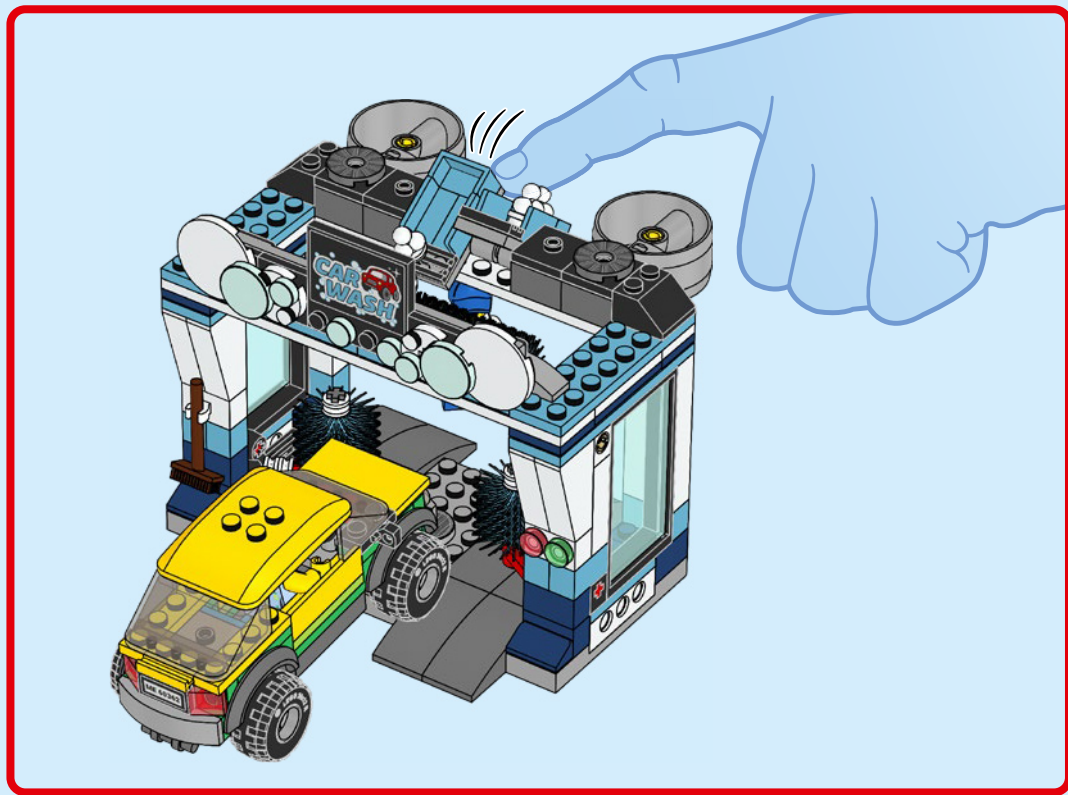

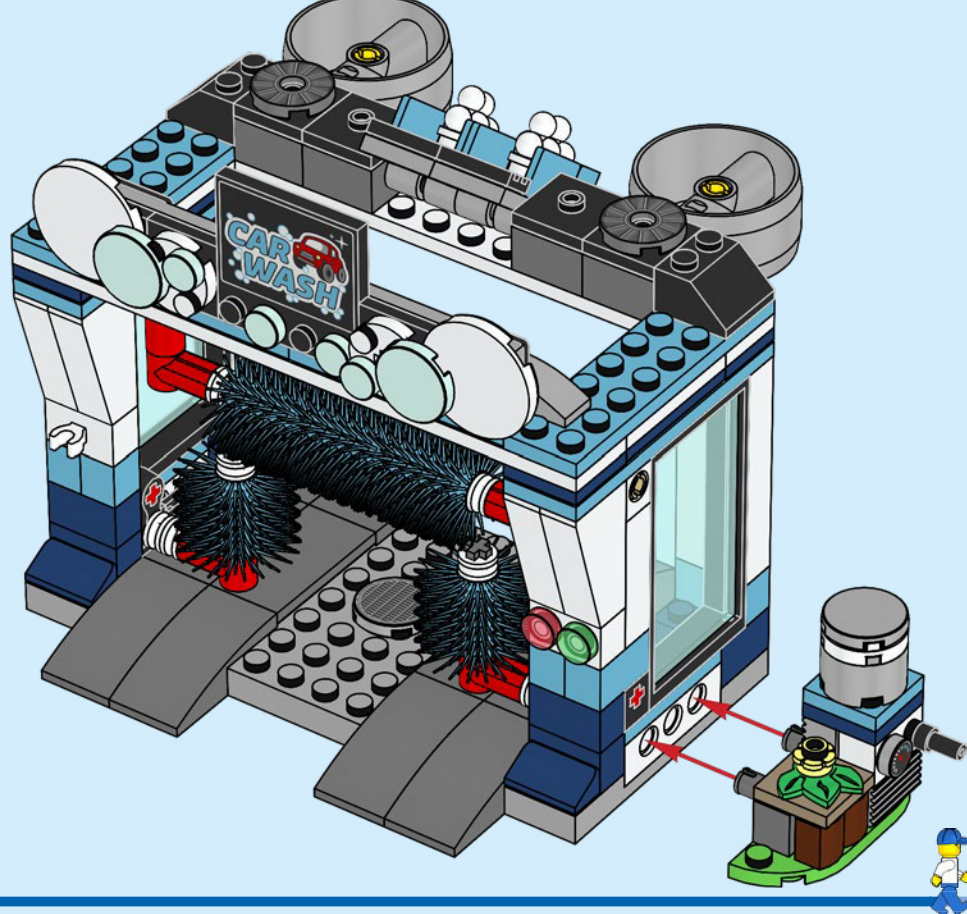

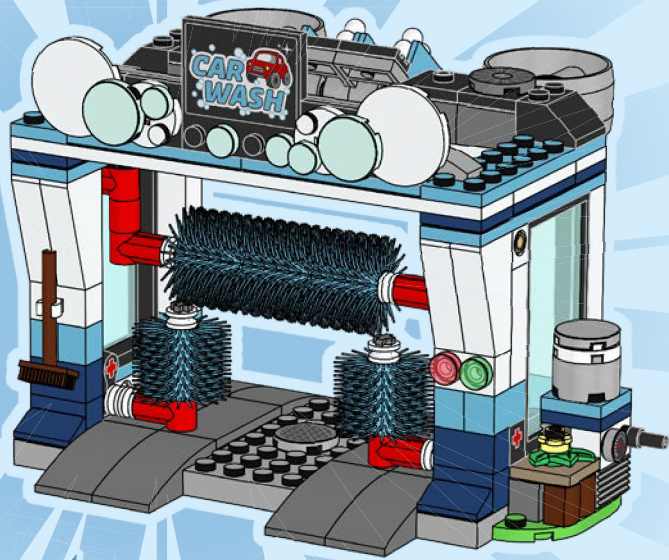
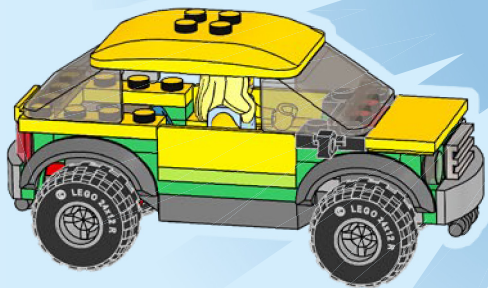



# CITY

60362



60380



60366



60364



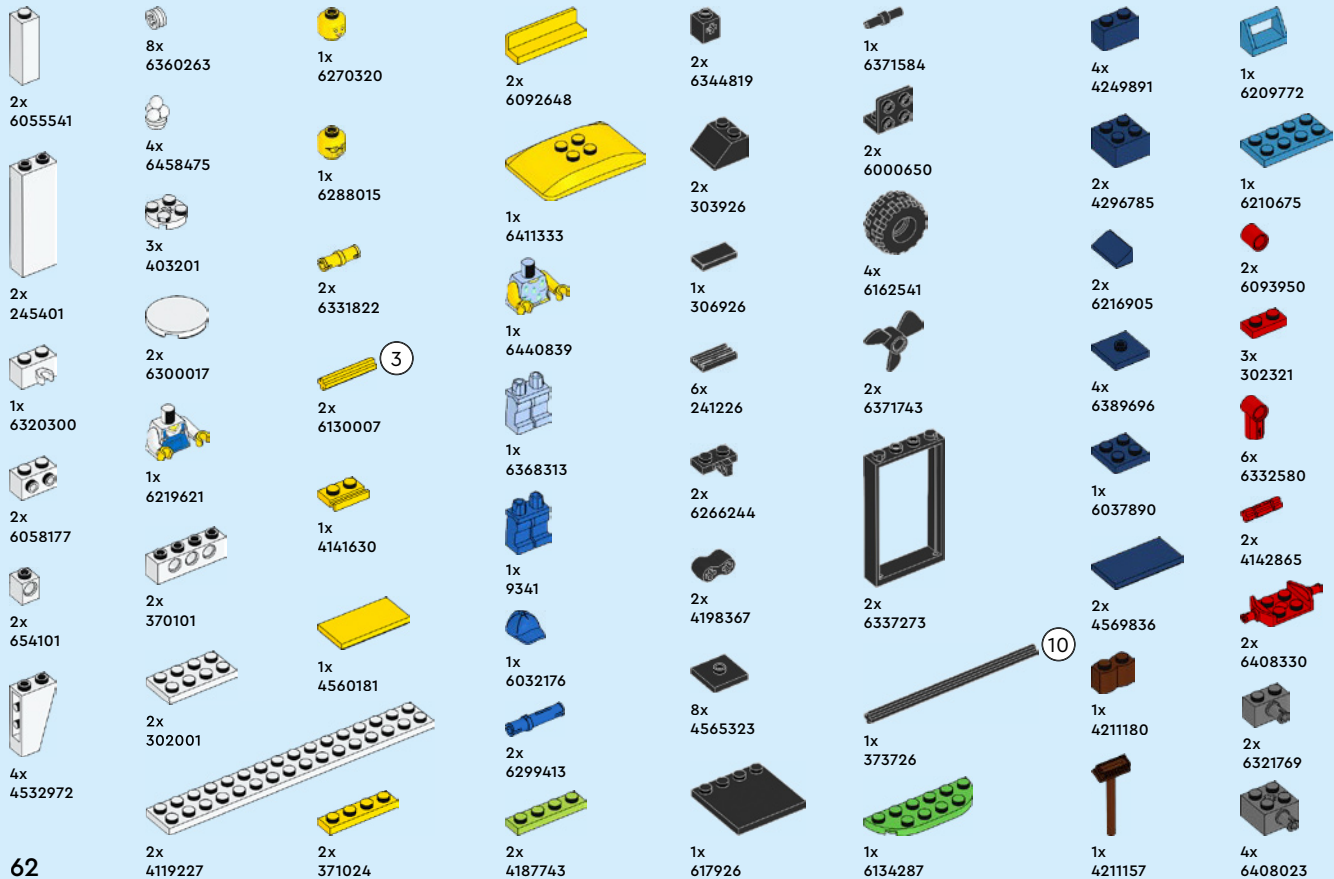



2x  
4210660



2x  
6117346



4x  
6170503



4

2x  
6083620

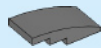

8x  
6005668



4x  
4560184



1x  
6133611

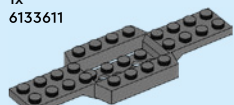

1x  
4259673



2x  
4619652



4x  
6092674



2x  
4625032



2x  
6248486



4x  
6146228



5x  
6440059



2x  
6070757

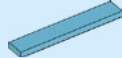

3x  
6185309



4x  
6253666



1x  
4619636



2x  
4211383



1x  
4211526



2x  
4211419



2x  
6176242

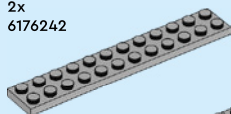

1x  
4211360

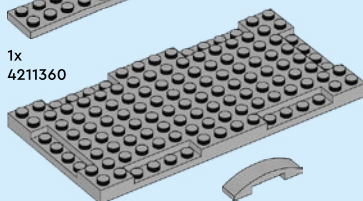

1x  
6417816



1x  
6329581



1x  
6052204



1x  
6052200



4x  
4211764



1x  
4226995



2x  
4507052



1x  
6426463



1x  
4549990



2x  
6126075



1x  
6229130



4x  
4107758



2x  
6440061



2x  
6440061

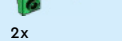

2x  
6440061



2x  
6440061

2x  
6440061



2x  
4666579



4x  
6322818



2x  
6096948

2x  
6096948



2x  
6256060

2x  
6256060

2x  
6256060

2x  
6256060



2x  
6245252



1x  
6258607



1x  
6274742



2x  
6274744

2x  
6274744

2x  
6274744

2x  
6274744

2x  
6274744

 [LEGO.com/service](https://www.LEGO.com/service)



YOU COULD **WIN**



Scan this QR code or go to **LEGO.COM/PRODUCTFEEDBACK** and give us your short feedback about this LEGO® set for a chance to win a cool LEGO prize.

Terms and Conditions apply\*



**EN: YOU COULD WIN.** Terms and Conditions apply\* **DE: Du könntest GEWINNEN.** Es gelten die Teilnahmebedingungen\* **FR: Tu pourrais GAGNER.** Des conditions s'appliquent\* **IT: Potresti VINCERE tu.** Termini e condizioni sono applicabili\* **ES: Puedes GANAR.** Aplican términos y condiciones\* **PT: Poderá GANHAR.** Aplicam-se termos e condições\* **ZH: 轻松获奖. 条款和条件适用\*** **PL: Szansa na WYGRANĄ.** Obowiązują warunki korzystania\* **CS: Máte šanci VYHRÁT.** Platí všeobecné smluvní podmínky\* **SK: Máte šancu VYHRAŤ.** Platia všeobecné zmluvné podmienky\* **HU: TE IS NYERHETSZ.** Felhasználási feltételek érvényesek\* **RO: Ai putea CÂȘTIGA.** Se aplică termenii și condiții\* **BG: Можете да СПЕЧЕЛИТЕ.** Има определени правила и условия\* **LV: Tu vari LAIMĒT.** Ir spēkā noteikumi un nosacījumi.\* **ET: Sul on võimalus VÕITA.** Kehtivad tingimused\* **LT: Jūs galite LAIMĖTI.** Taikomos sąlygos\*

\*[LEGO.com/productfeedback-terms](https://www.lego.com/productfeedback-terms)

LEGO and the LEGO logo are trademarks of the/sont des marques de commerce du/  
son marcas registradas de LEGO Group. ©2023 The LEGO Group.

6466283