



CITY

60165



 LEGO.com/city





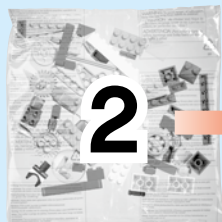
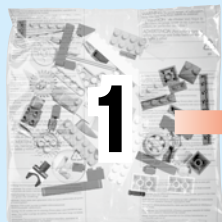

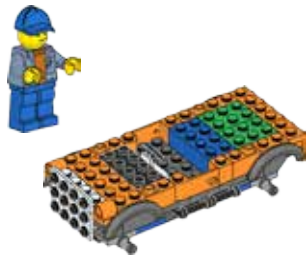

1



2



3





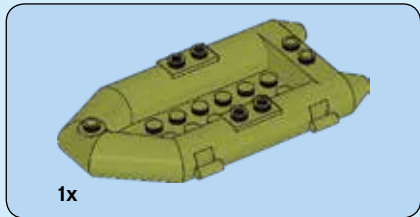

1

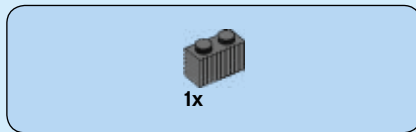
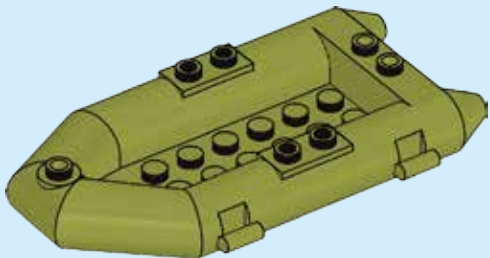

2

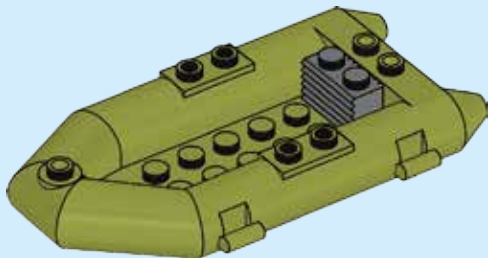



1x



2x

3

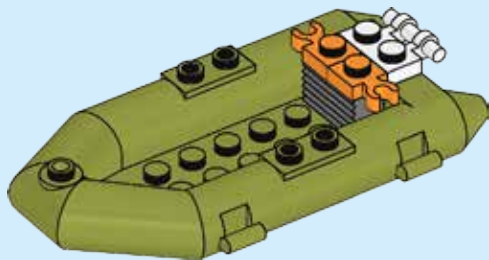



1x

4

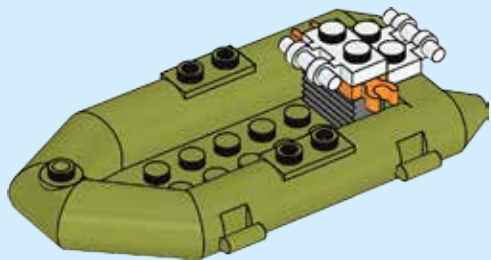

1x

5

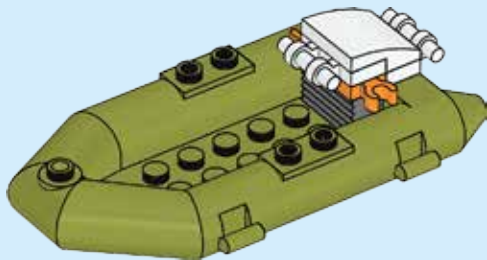



1x



1x

6

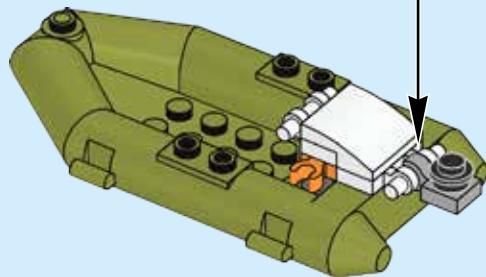
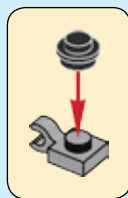



7

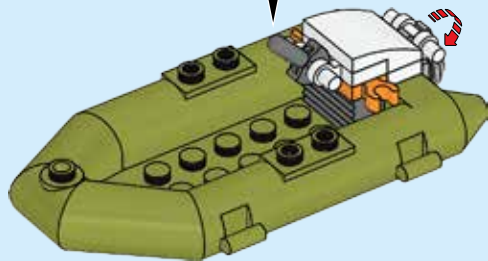

8



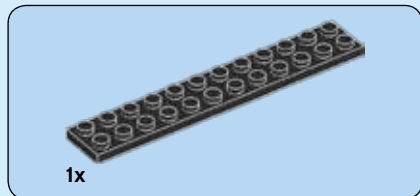

1

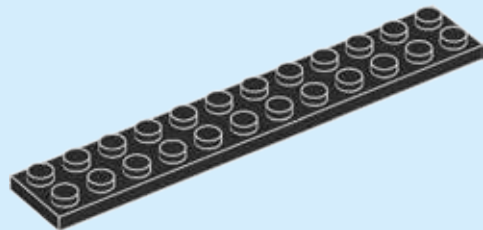

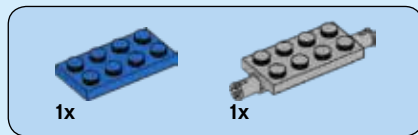

2

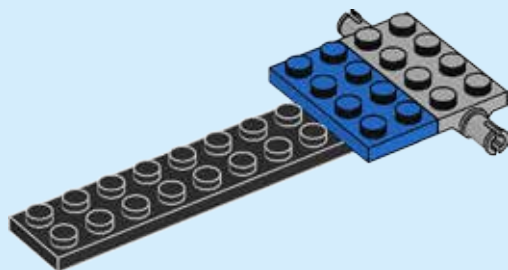

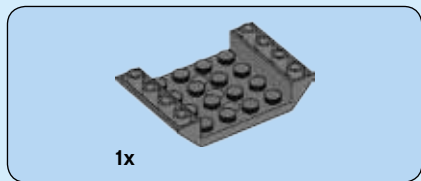

3

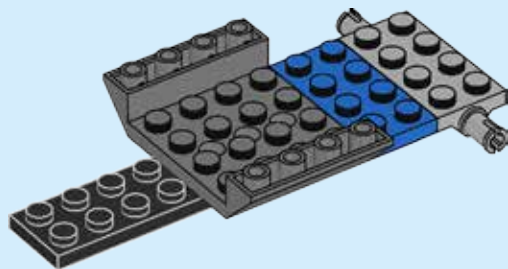

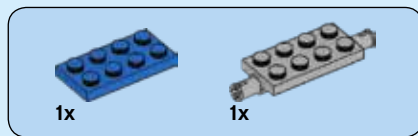

4

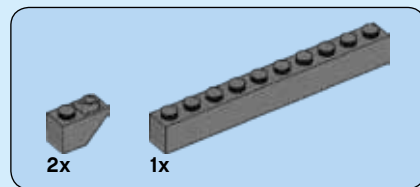
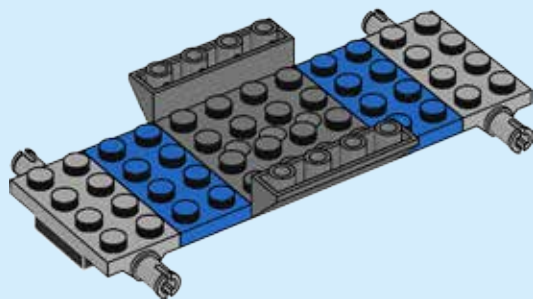

5

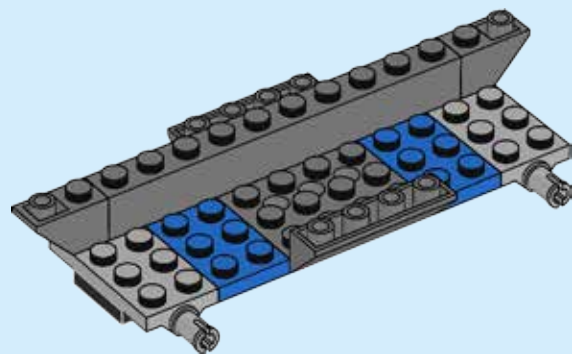

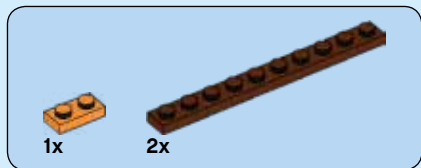

6

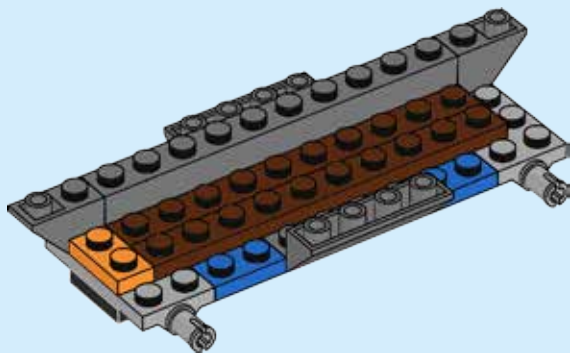



1x

7

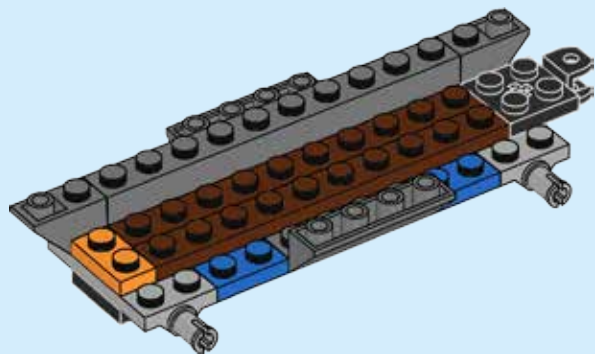

1x

8

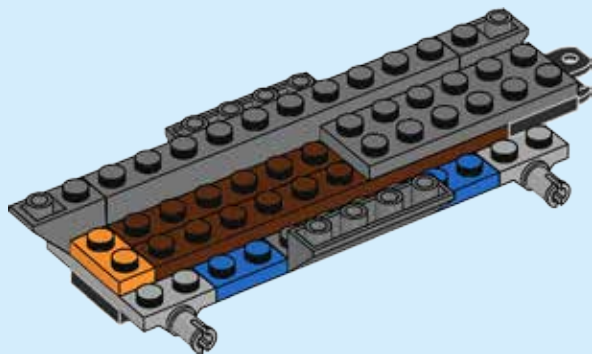



1x

9

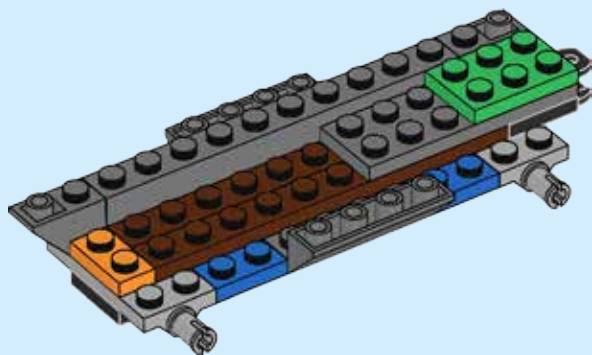

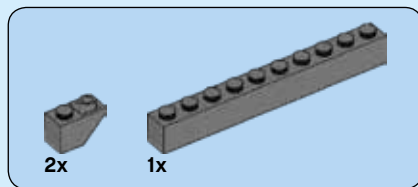

10

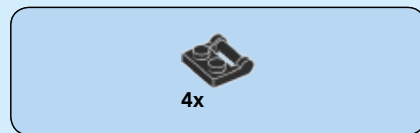
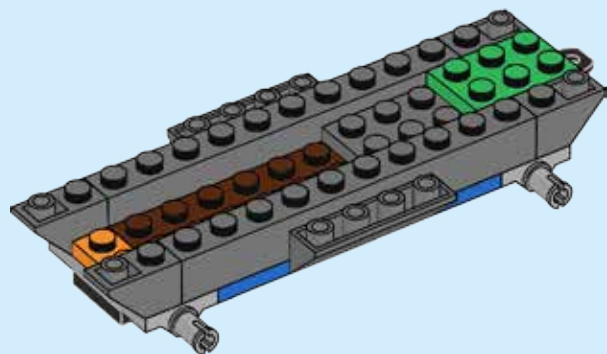

11

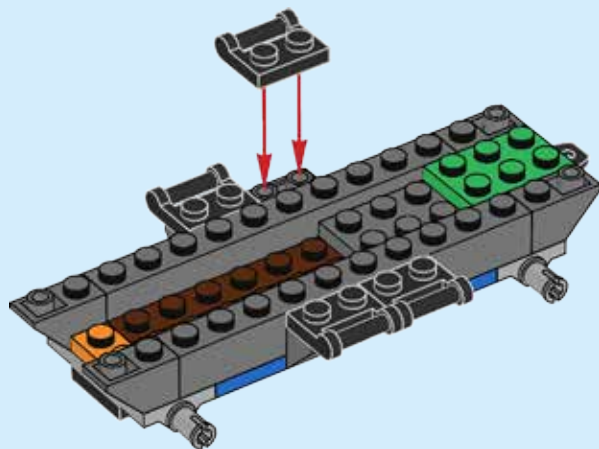



1x

12

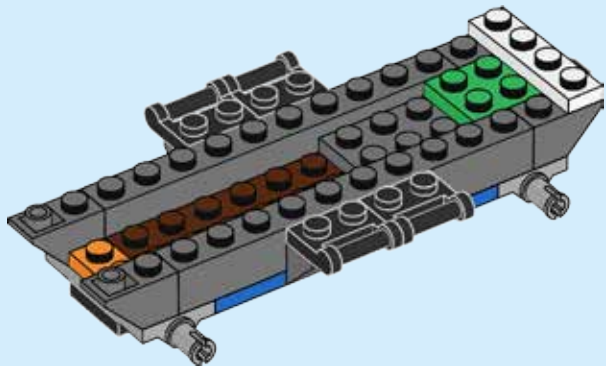

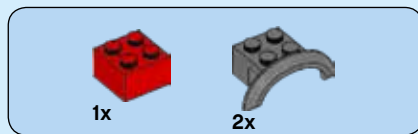

13

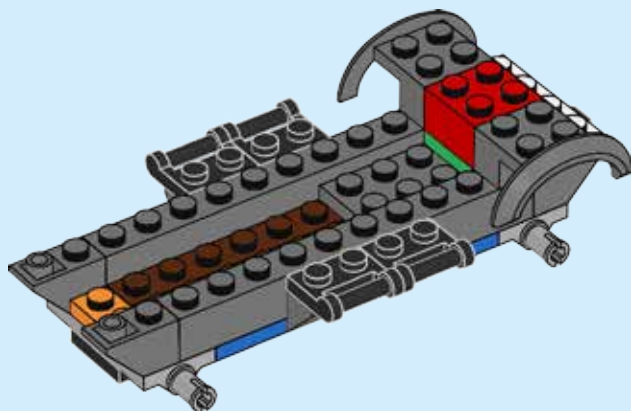

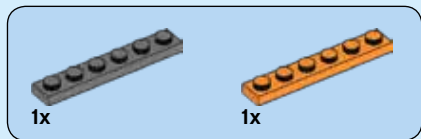

14

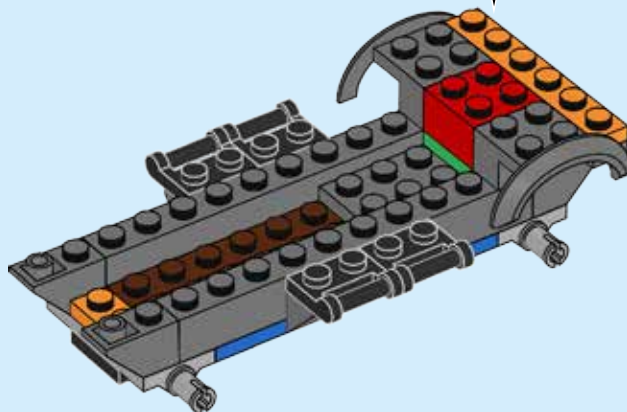
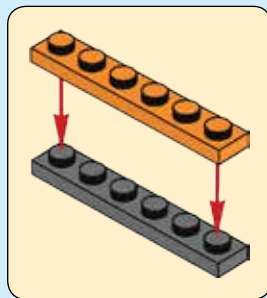



1x

15

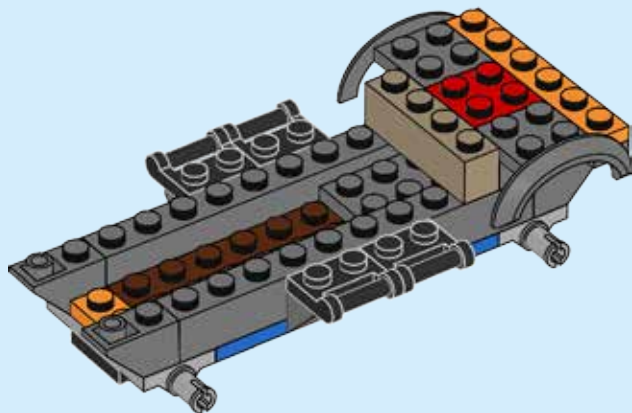

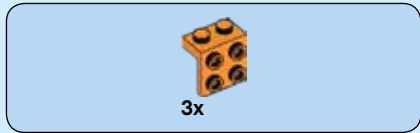

16

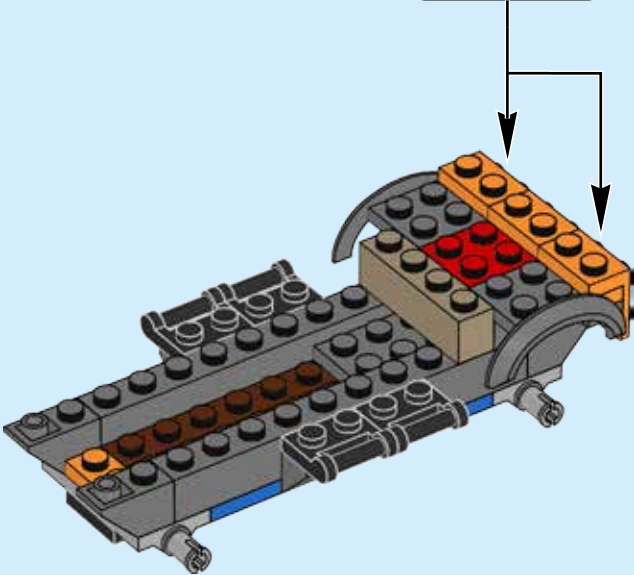



2x

17

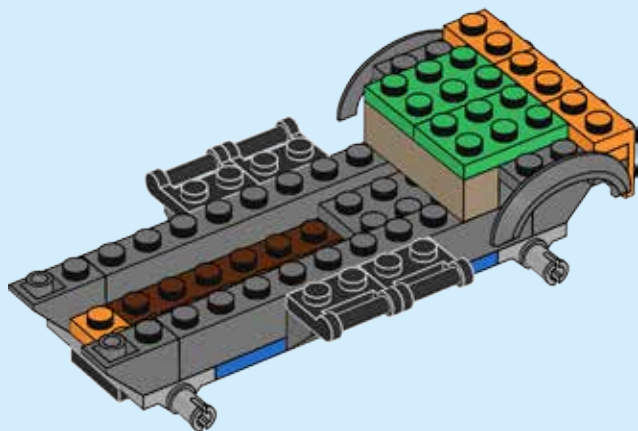

2x

18

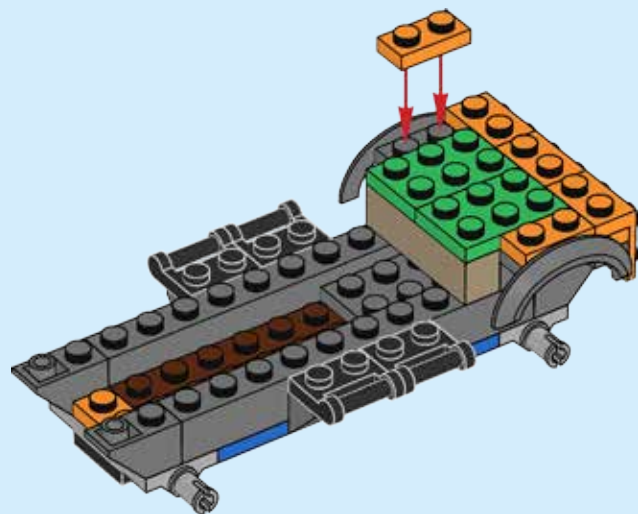



3x

19

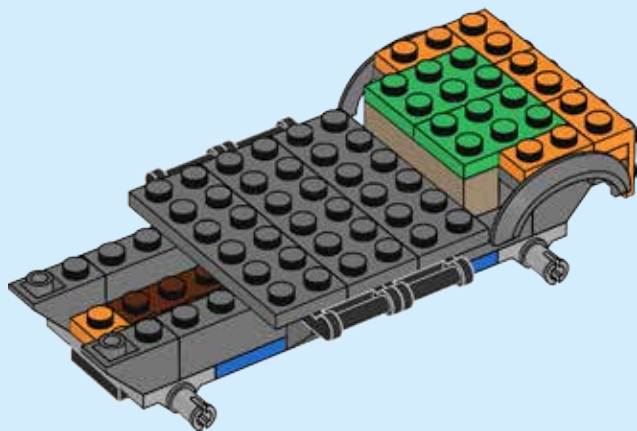



1x

20

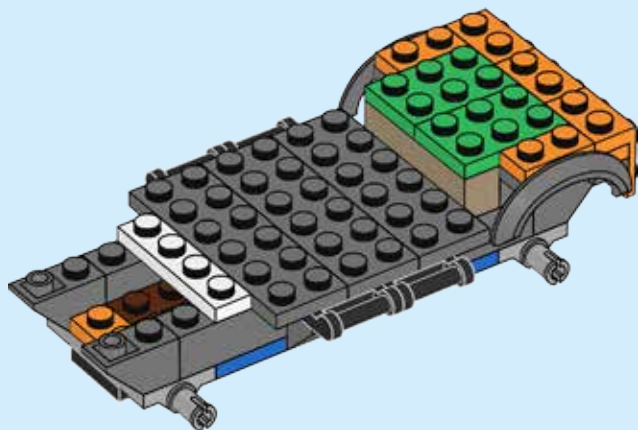

2x



2x

21

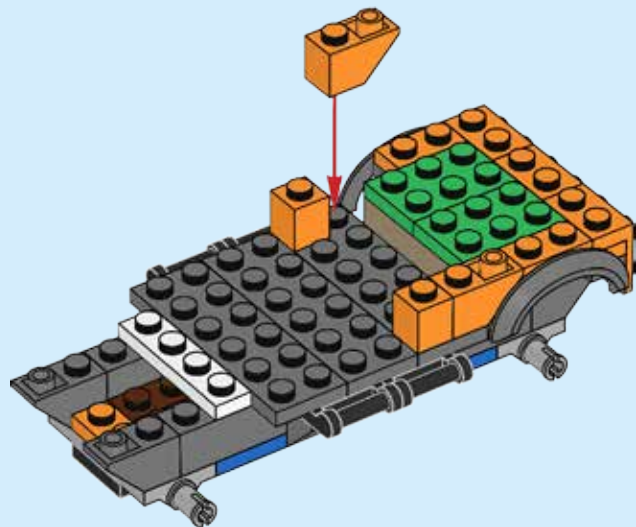

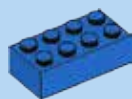

1x

22

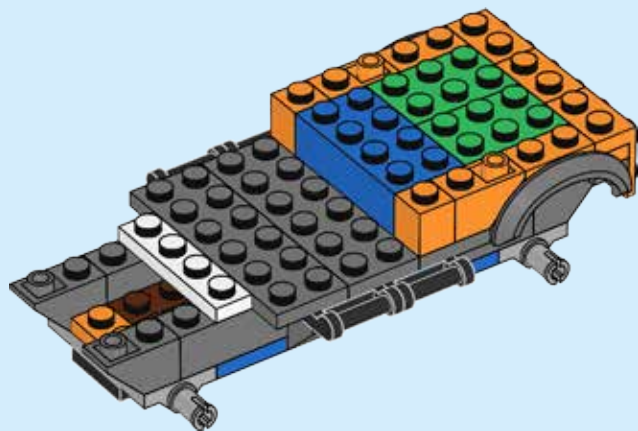

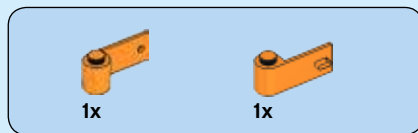

23

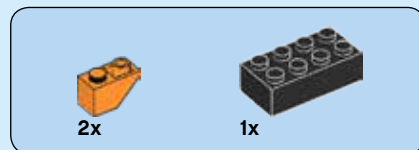
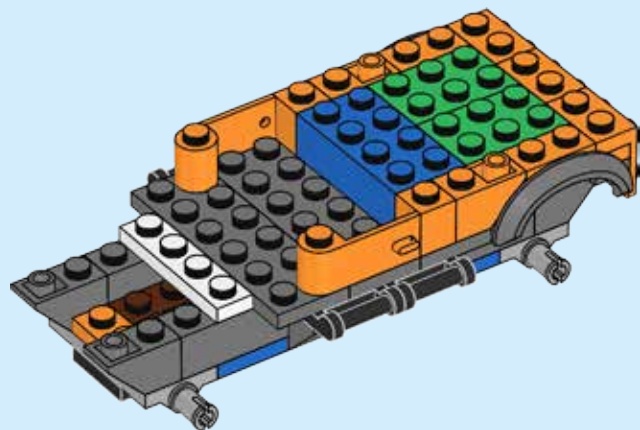

24

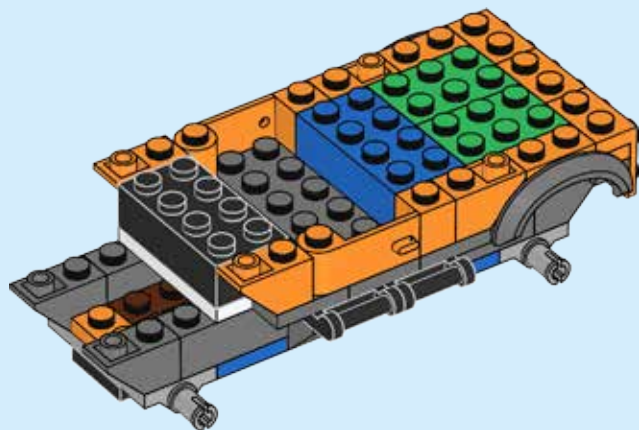



1x

25

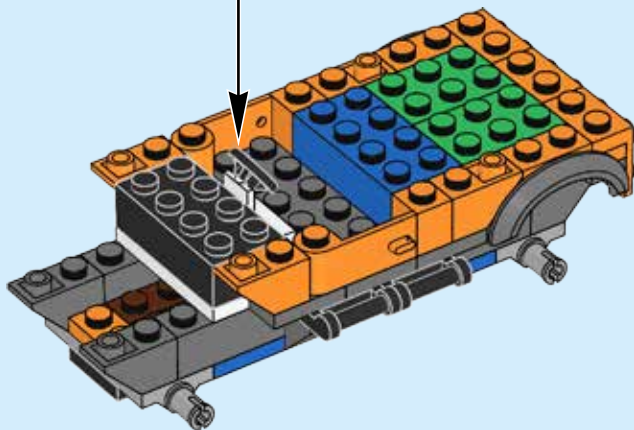
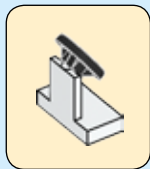



2x

26

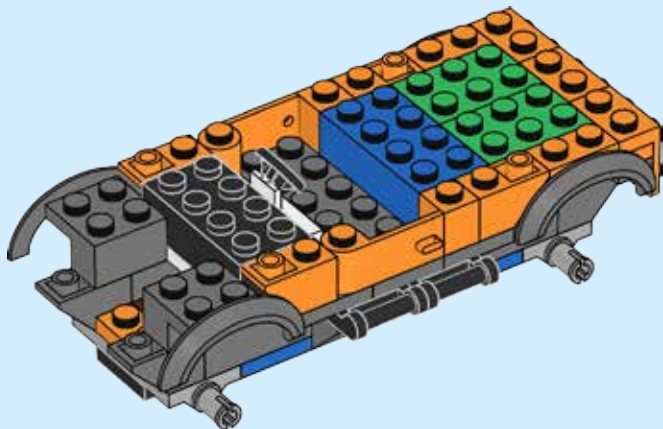



1x

27

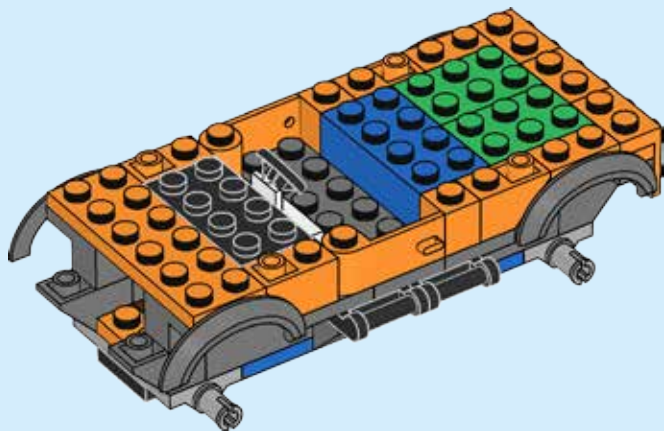



1x

28

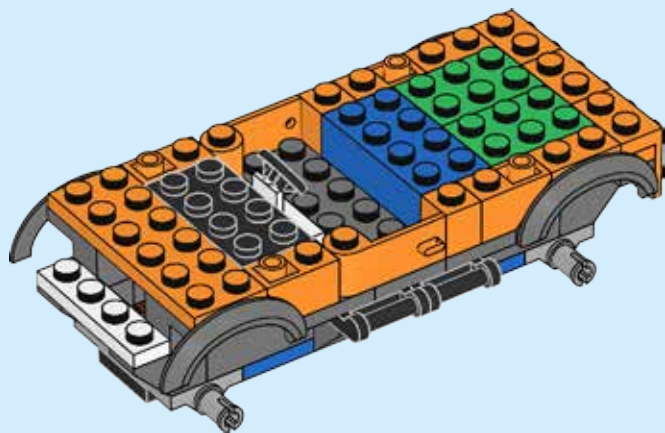

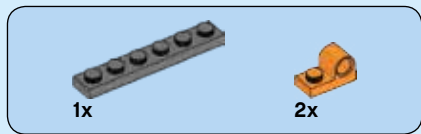

29

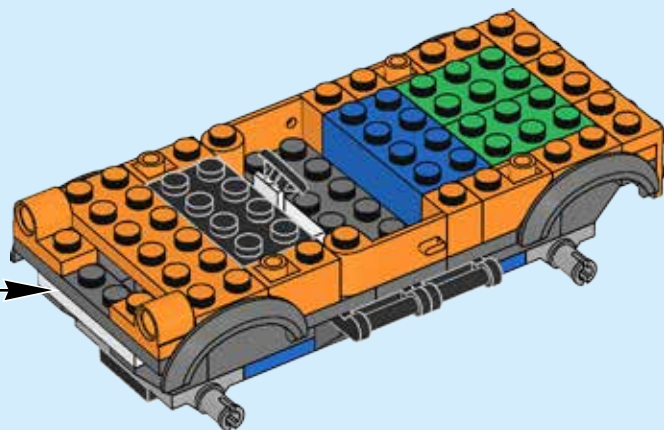
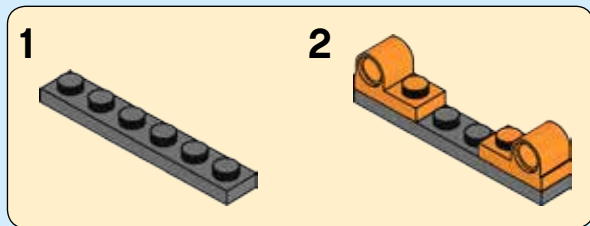



1x

30

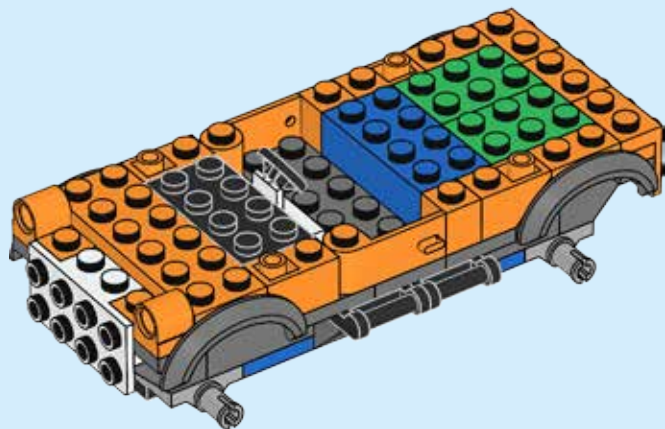



2x

31

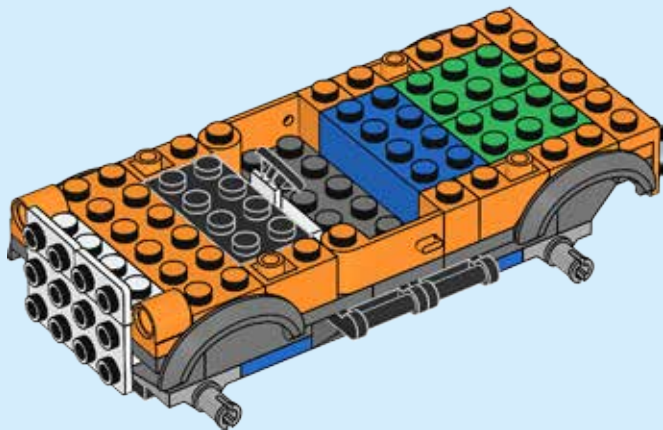

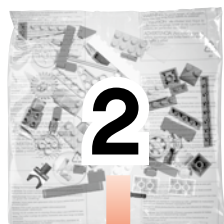

2x



1x

32

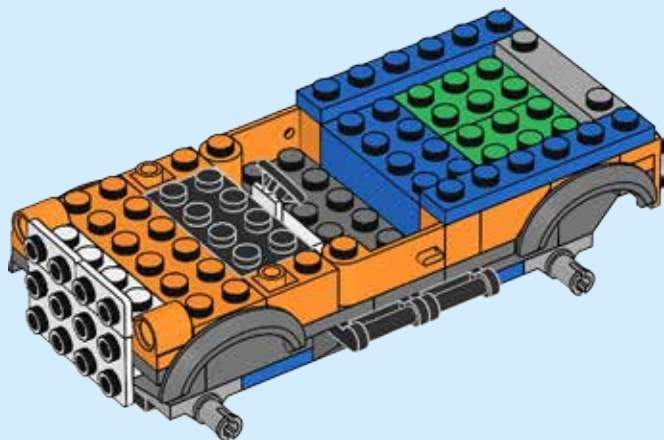

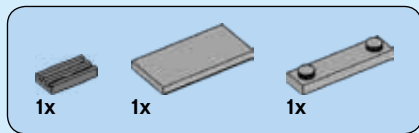

33

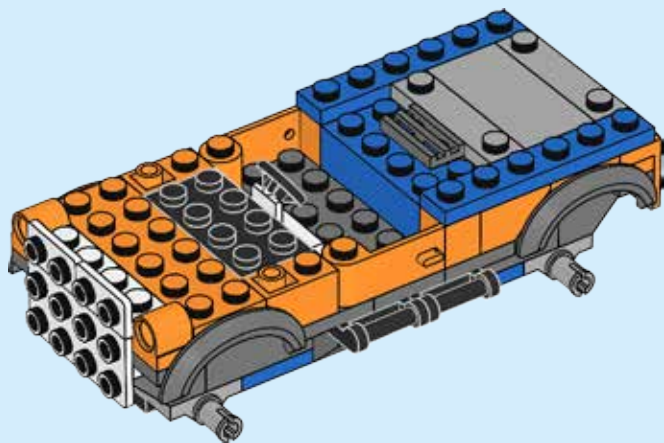



2x



2x

34

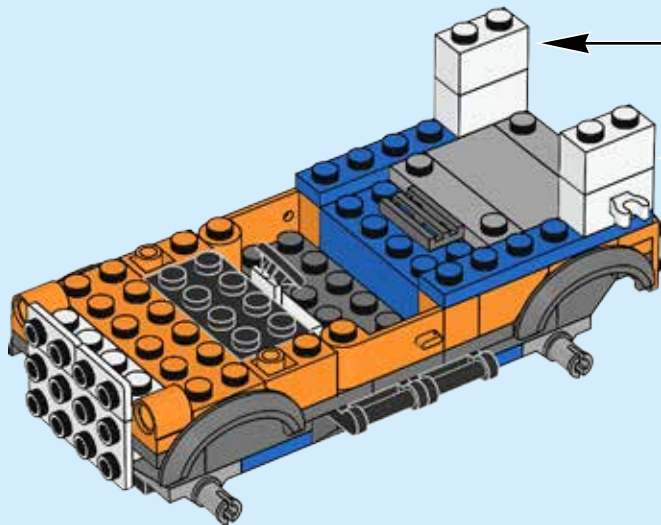
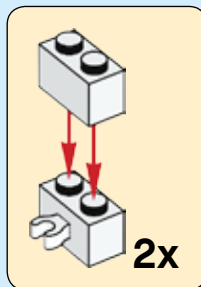

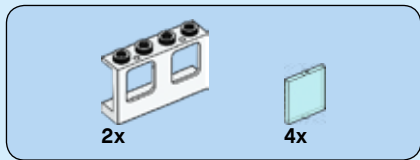

35

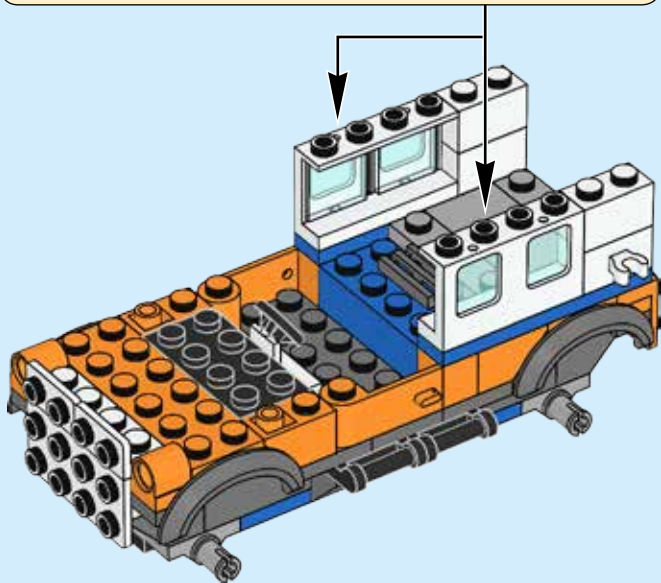
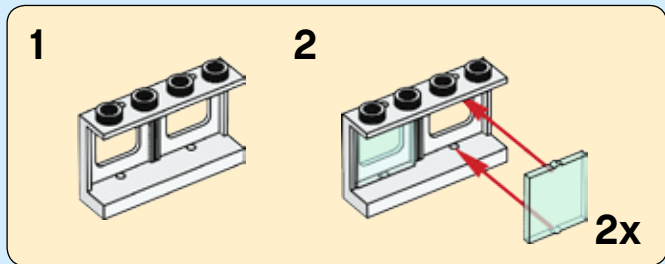



1x



2x

36

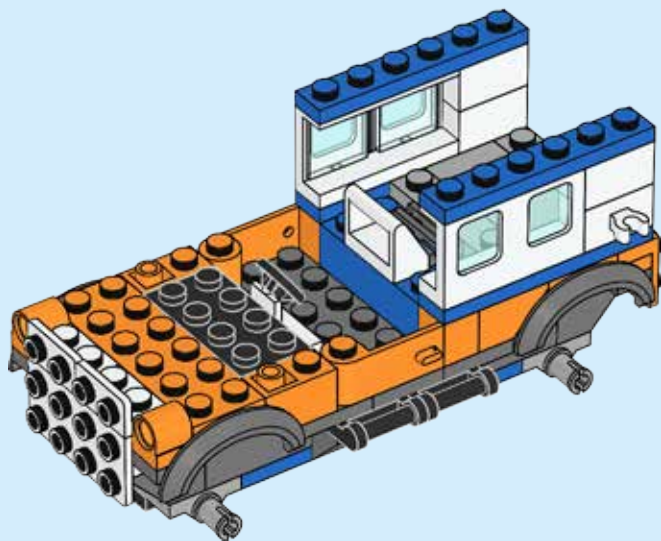



1x



2x

37

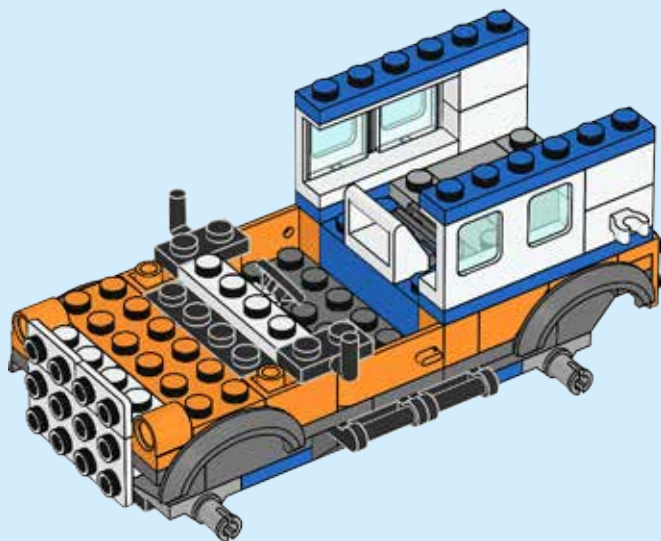



1x



2x

38

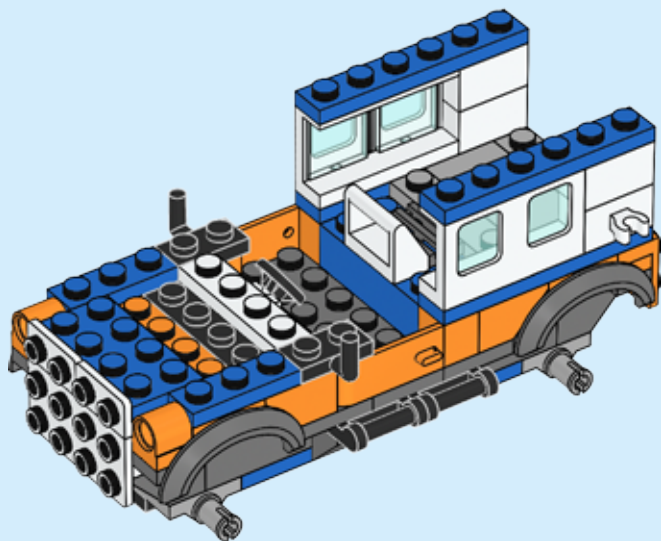



2x

39

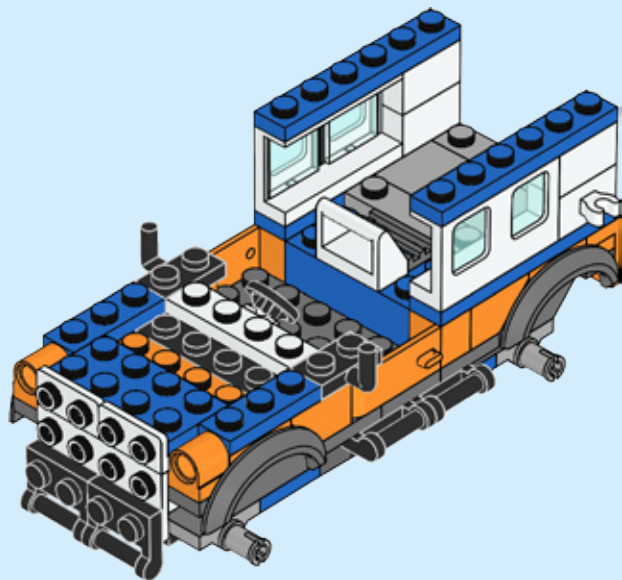



4x

40

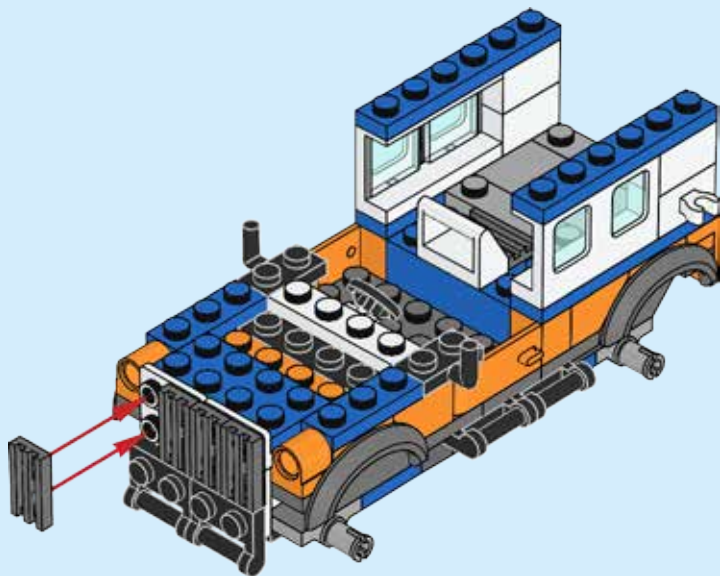



1x

41

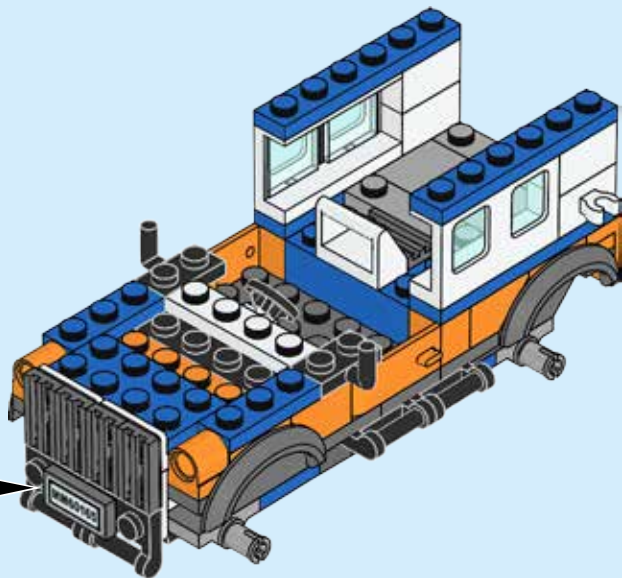

1

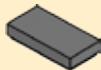

2





2x

42

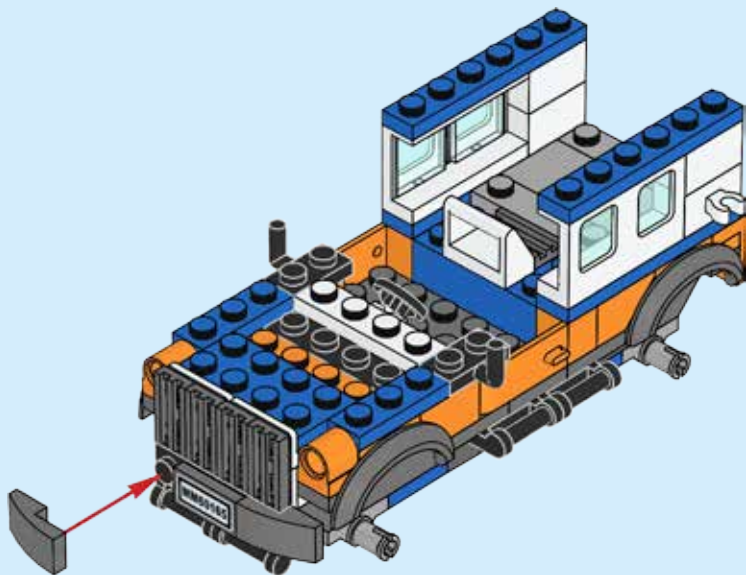



2x



2x



2x

43

1



2



3

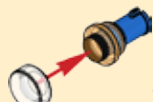

2x

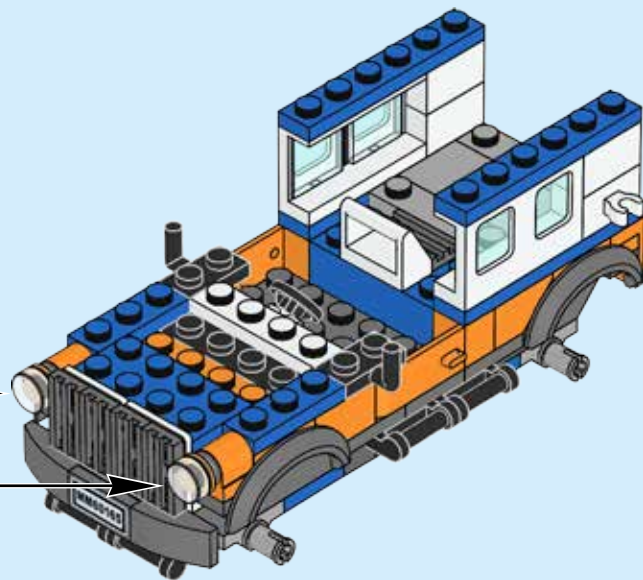



1x

44

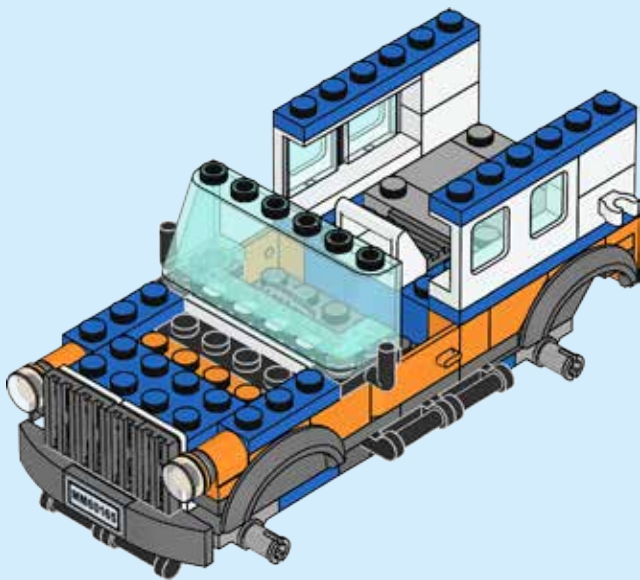



2x

45

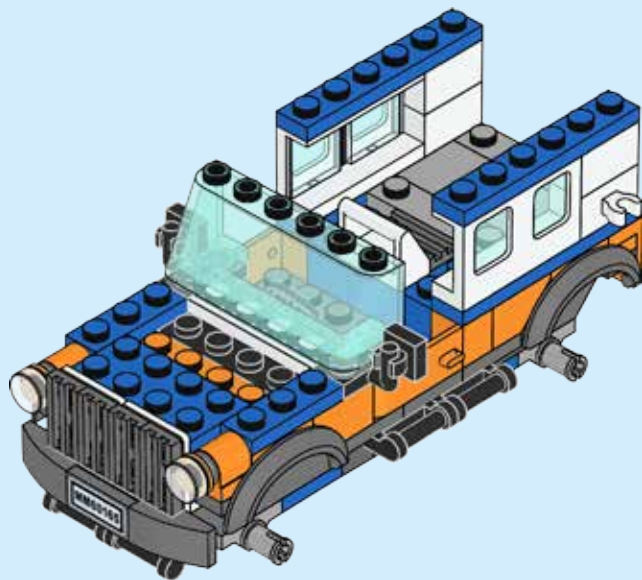

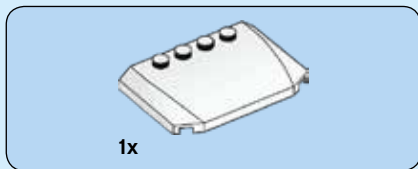

46

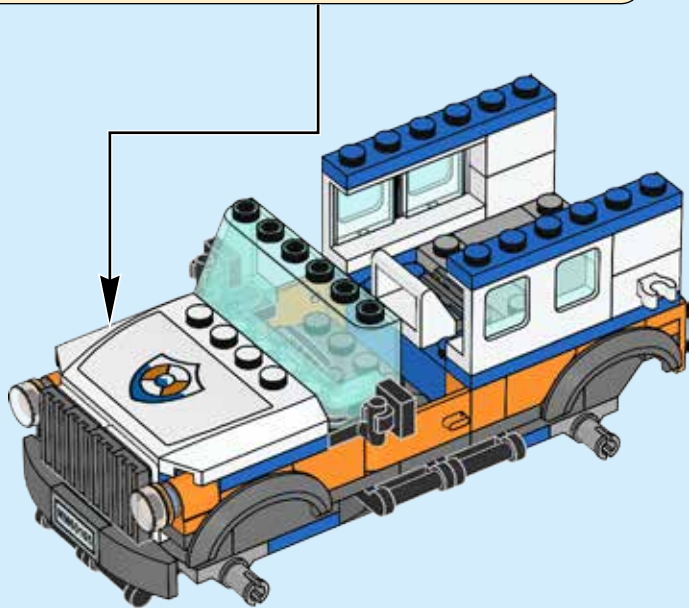
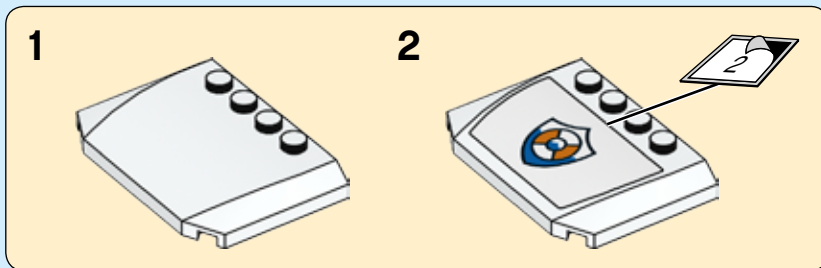



4x



2x

47

1

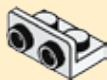

2

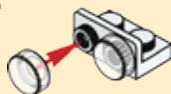

2x

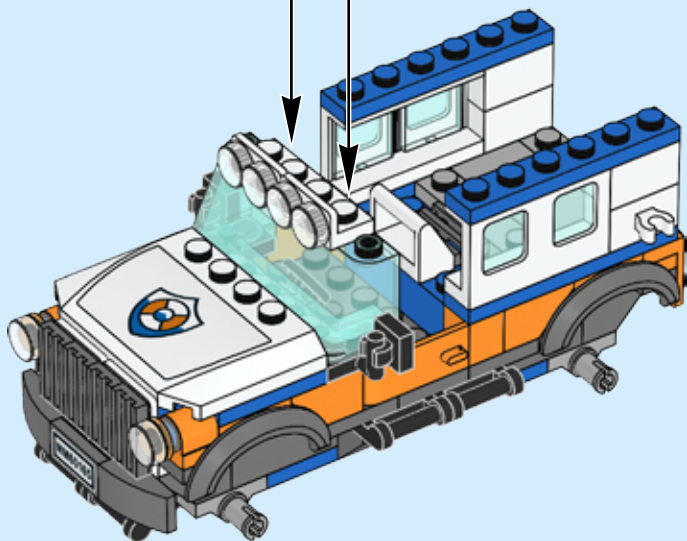

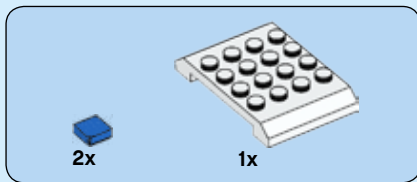

48

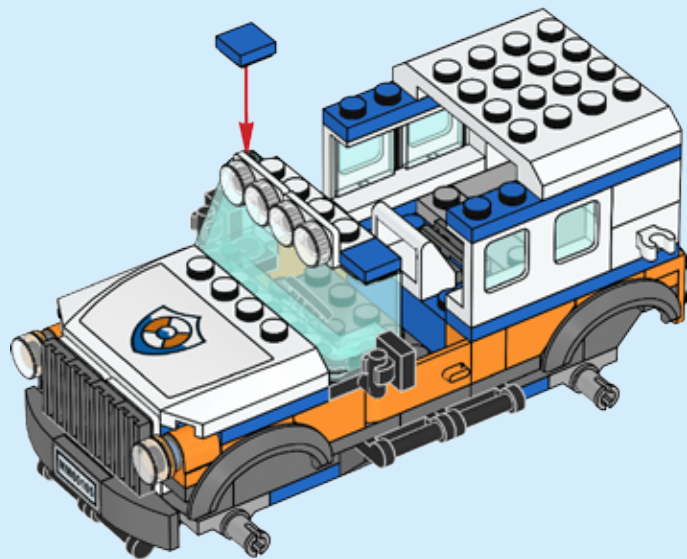

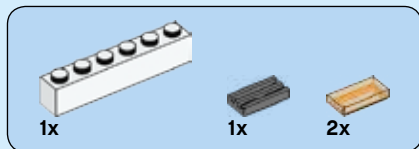

49

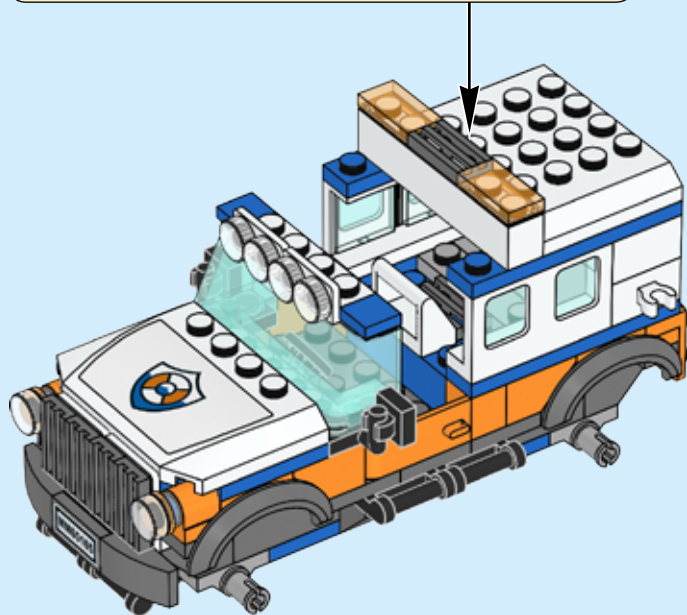
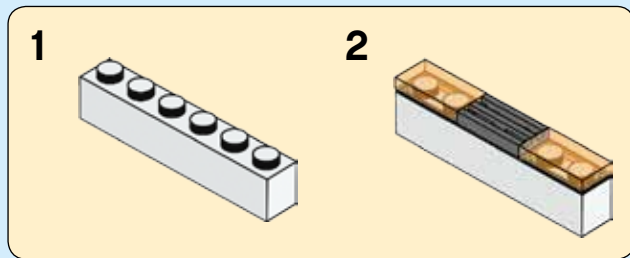

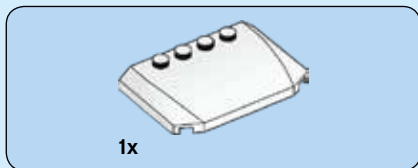

50

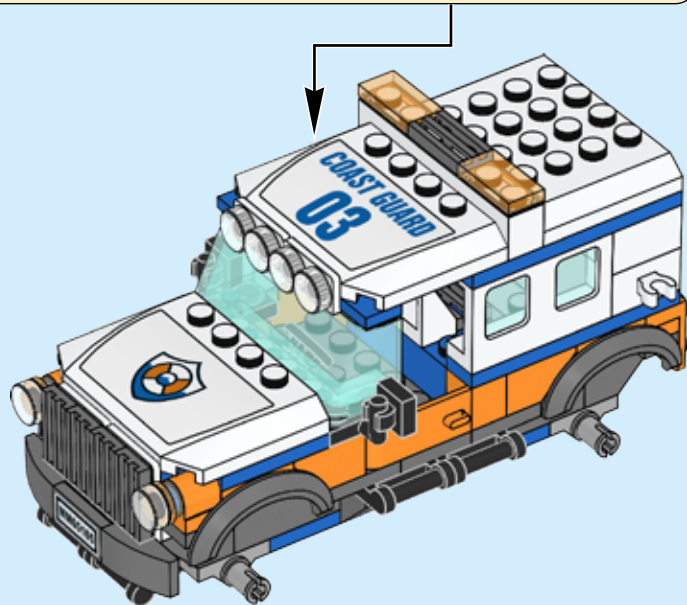
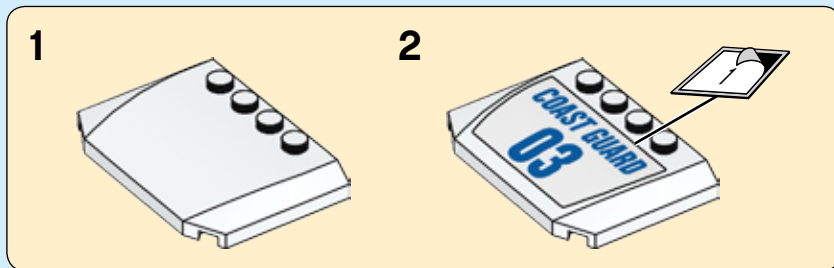



1x

51

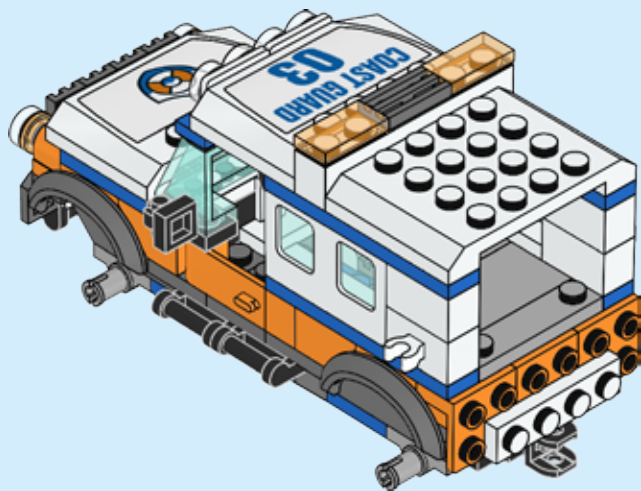

56



2x



1x



2x

52

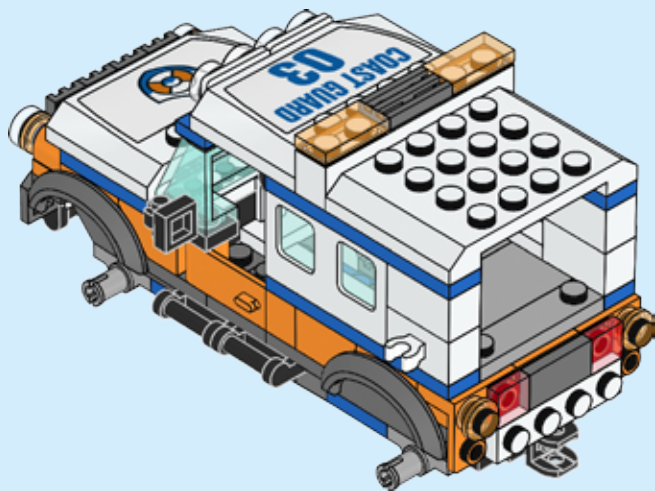



2x



1x

53

1



2

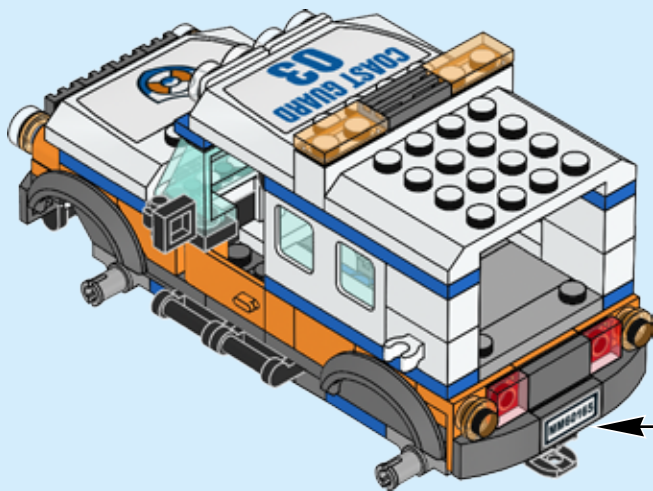

58

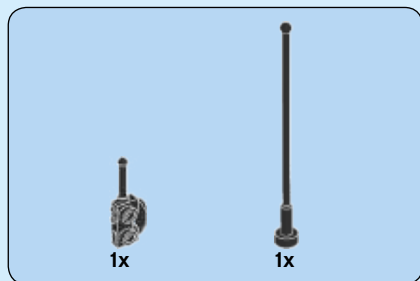

54

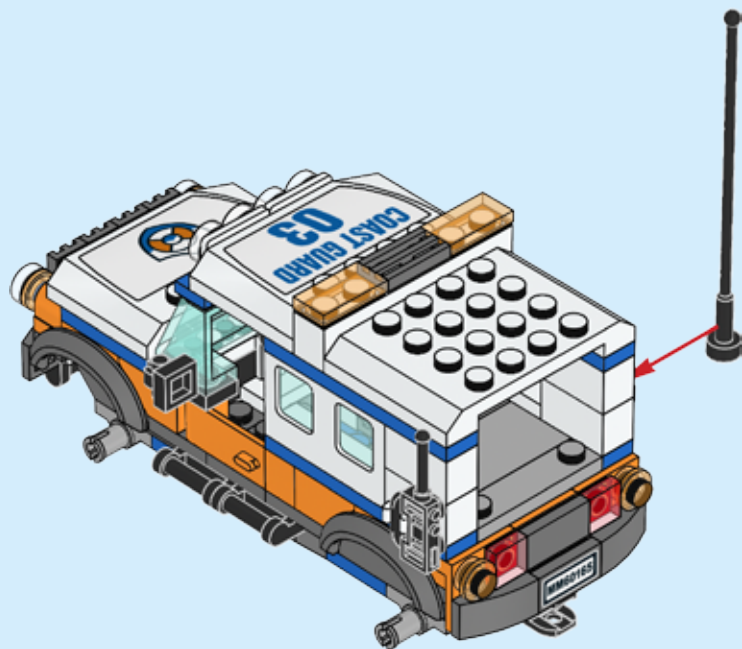

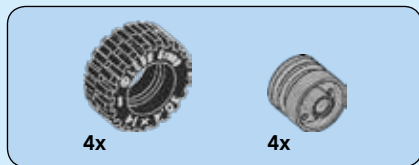

55

