



# CITY

60075



 [LEGO.com/city](http://LEGO.com/city)





+

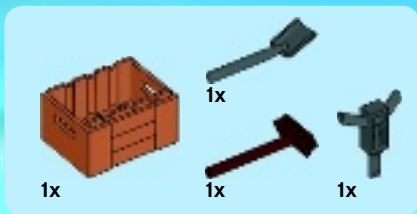

1





1x



1x



2x

# 2

1



2



3



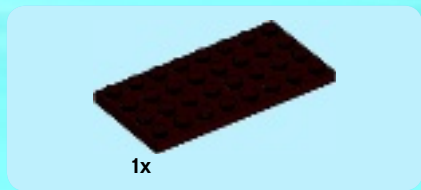

1





2x

2



4x

3

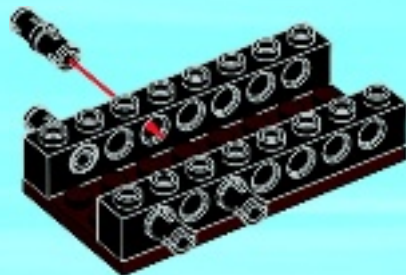



2x

4

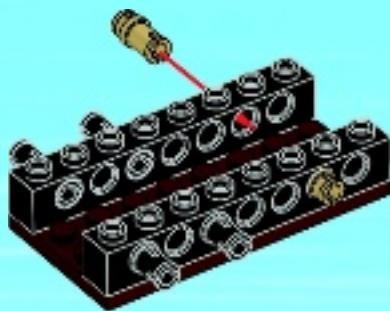



2x



1x

5

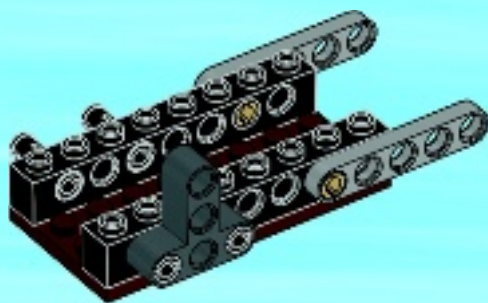

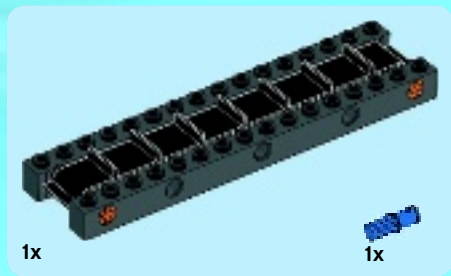

1

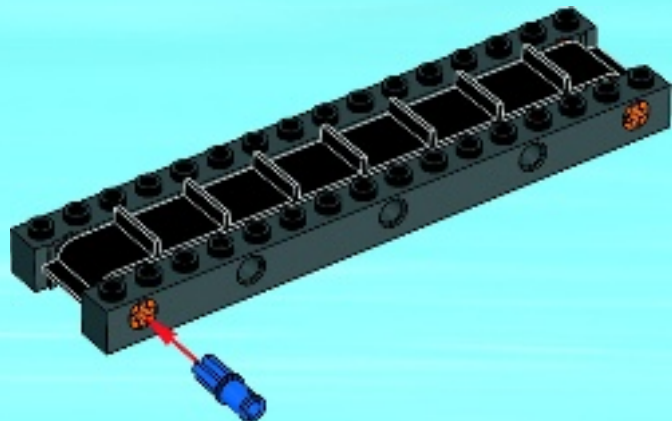





2x

2

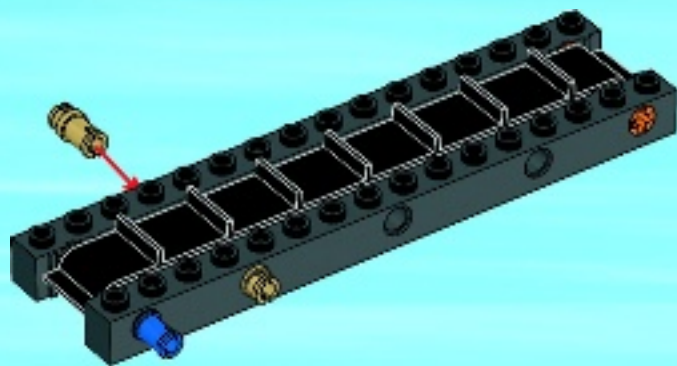



2x

3

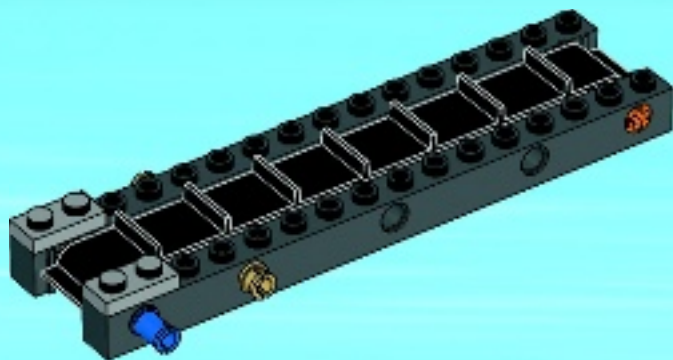



2x

4

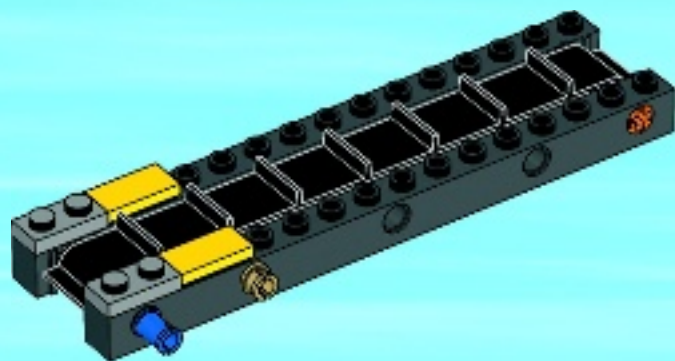



6x

5

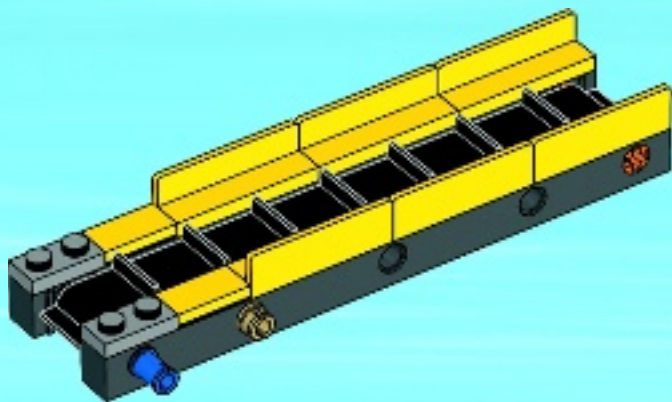

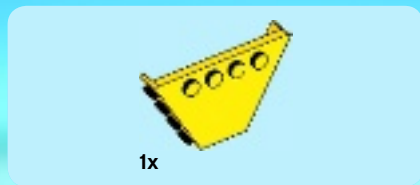

6

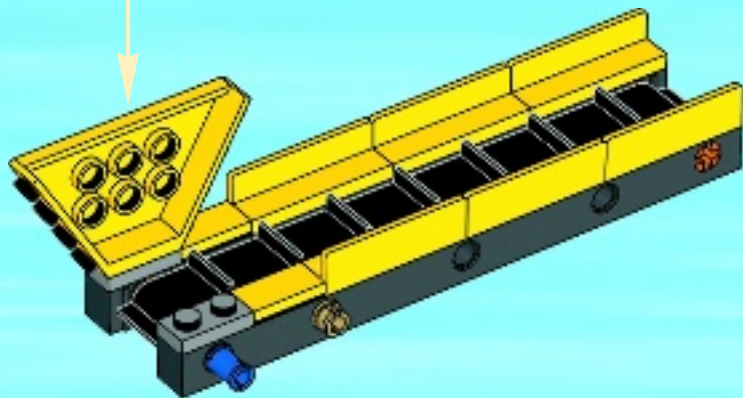

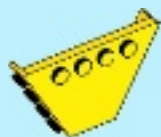

1x

7

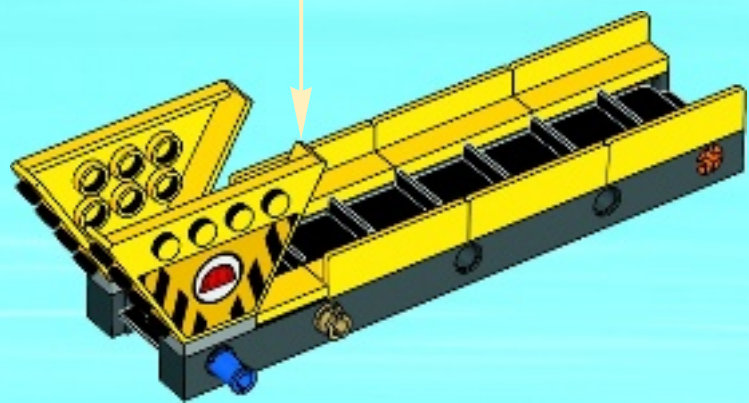
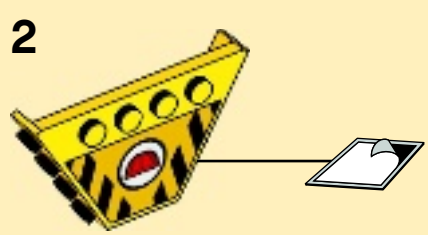
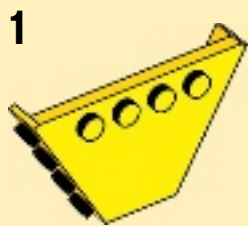



1x

8

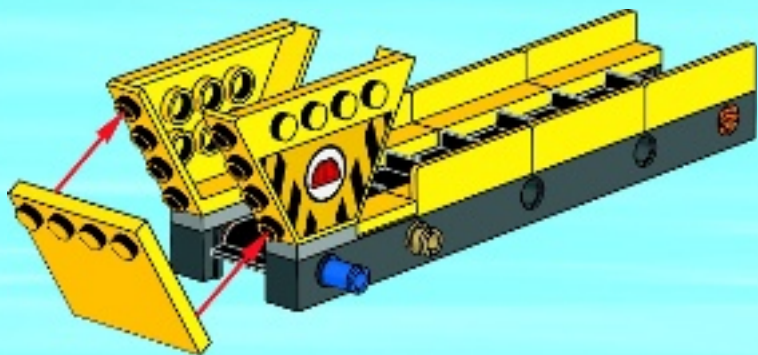



1x

9

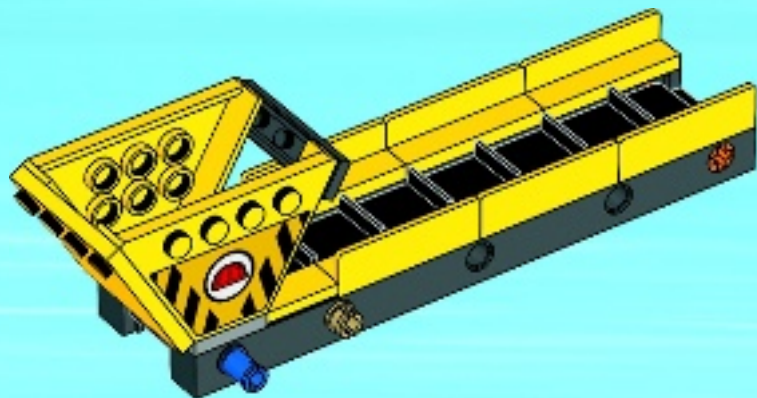



10

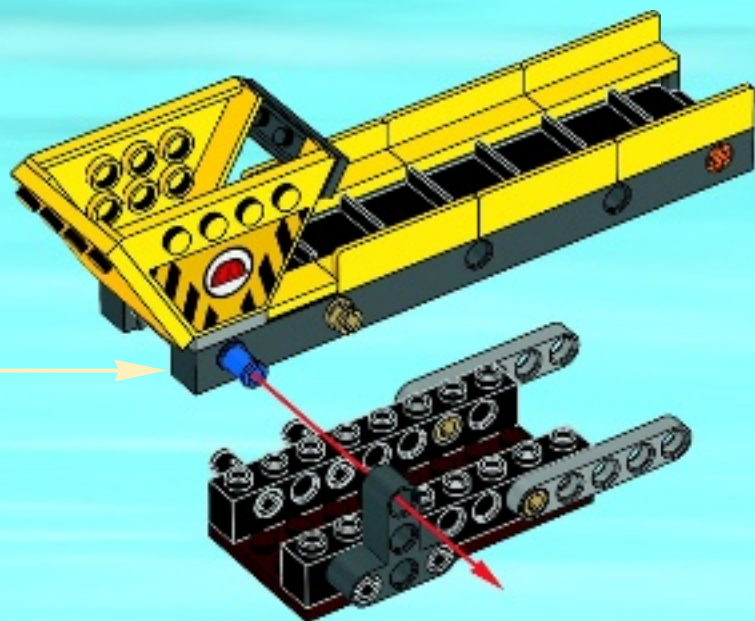



1x

11





1x

12

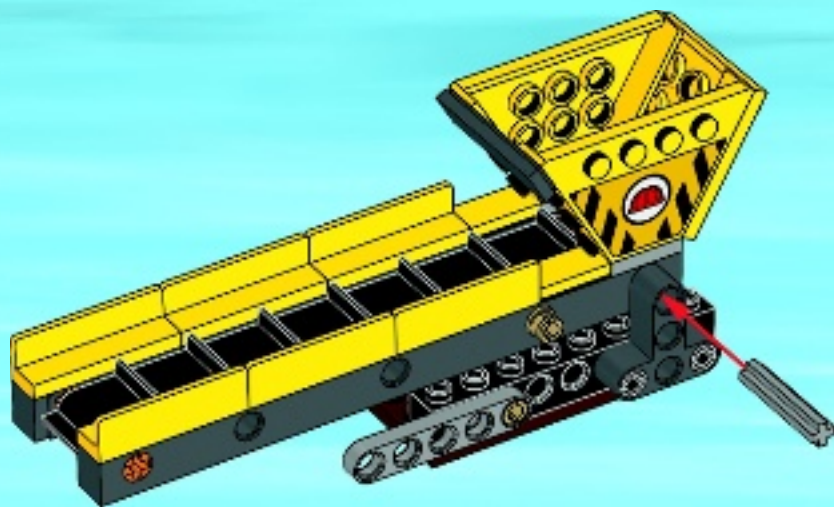



1x



1x

# 13

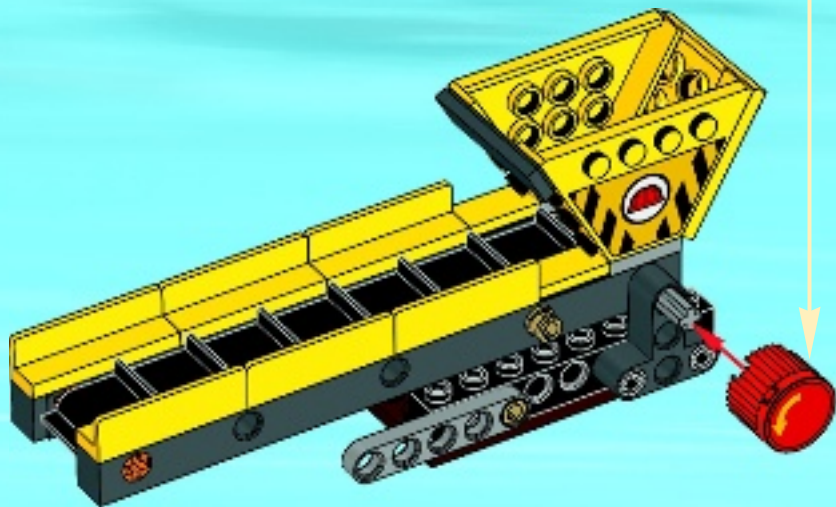
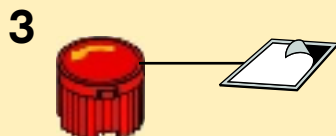

14

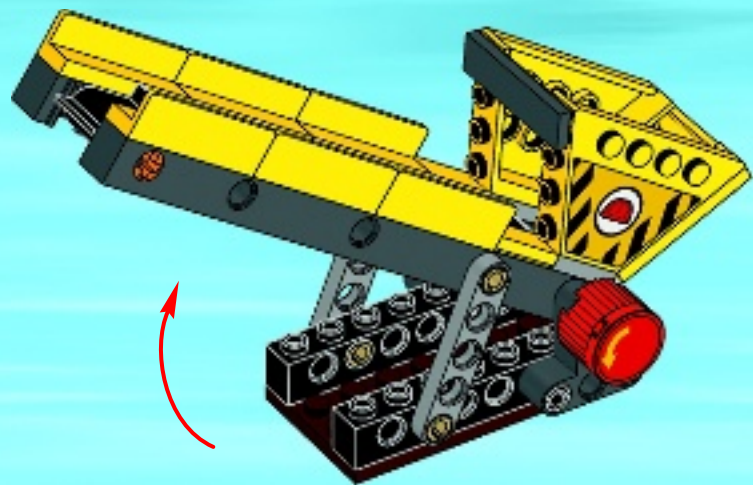



15

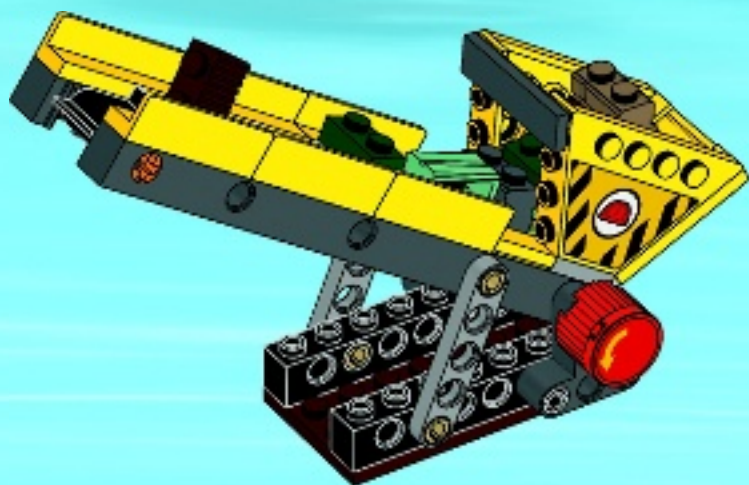

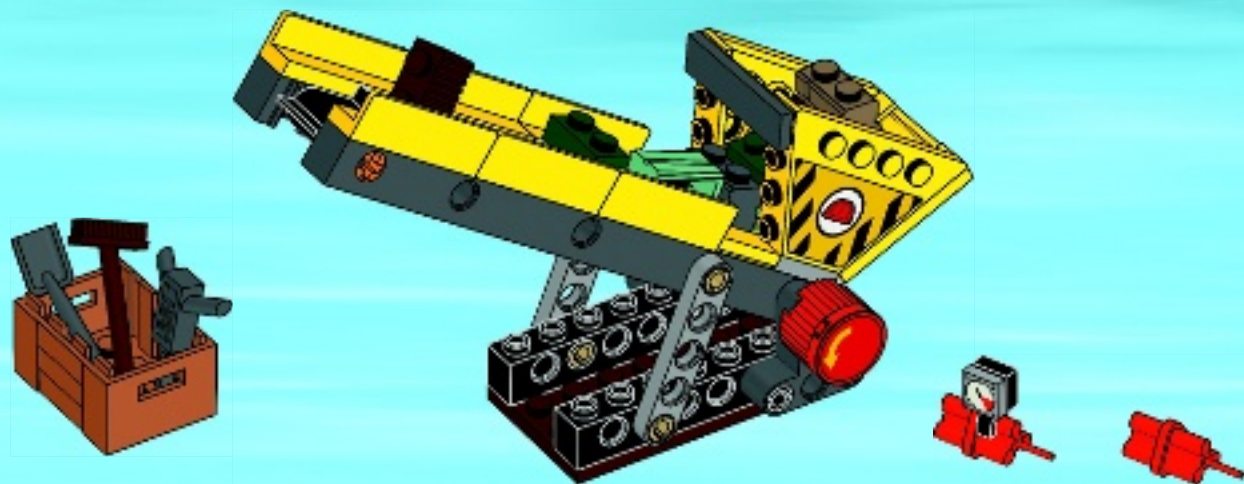



# FREE ONLINE GAME & APP!

KOSTENLOSES ONLINE-SPIEL & APP! - JEU EN LIGNE ET APPLUS GRATUITES!  
JUEGO ONLINE Y APP GRATIS! - JOGO E APLICACÃO ONLINE GRÁTIS!  
INGYENES ONLINE JÁTÉK ÉS APP! - SLOBYTY-FREZERSKI APP DLA DZIECI!  
[WWW.LEGO.COM/CITY](http://WWW.LEGO.COM/CITY)



LEGO and the LEGO logo are trademarks of the LEGO Group.  
©2015 The LEGO Group. 6109362



[LEGO.COM/CITY](http://LEGO.COM/CITY)

GET IT ON  
Google play

GET IT ON  
App Store



Apple, the Apple logo, iPad, iPhone and iPod touch are trademarks of Apple Inc., registered in the U.S. and other countries.  
App Store is a service mark of Apple Inc.  
Google Play is a trademark of Google Inc.