



# Harry Potter



4841



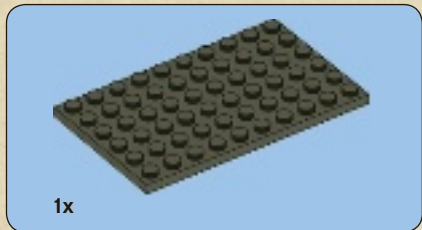
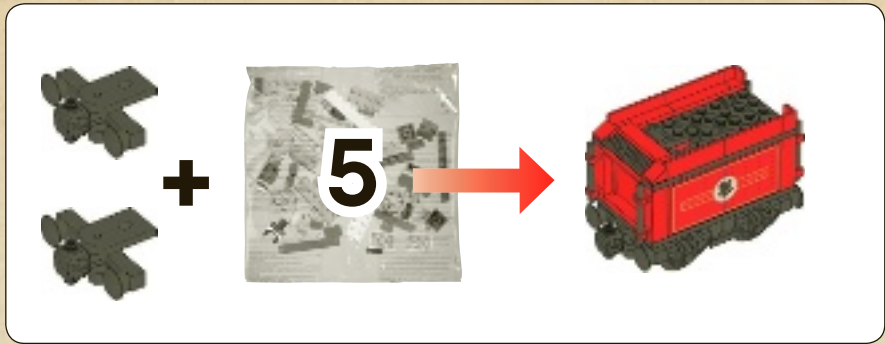

1

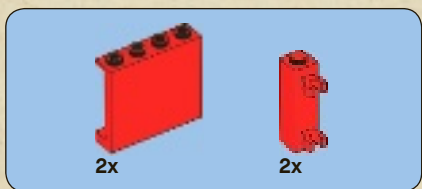
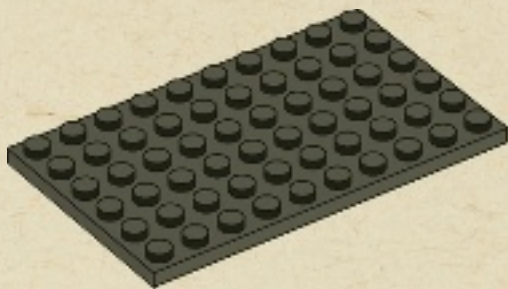

2

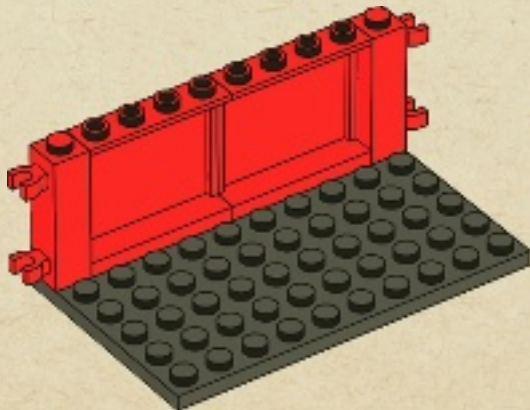

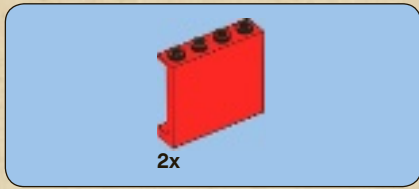

3

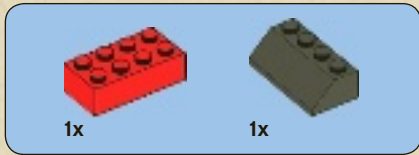
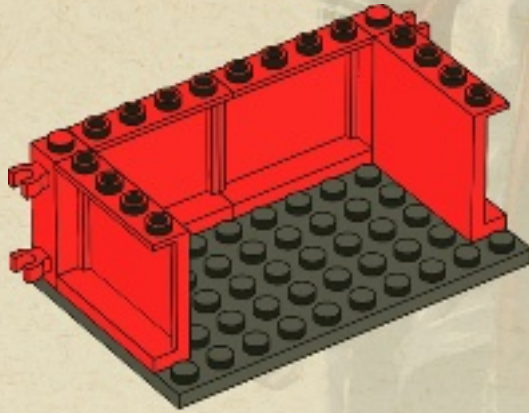

4

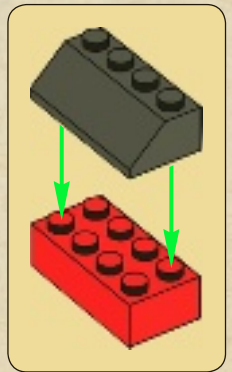
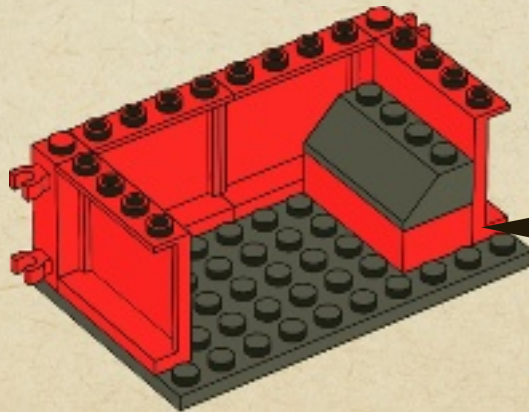

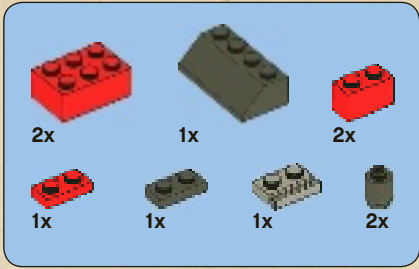

5

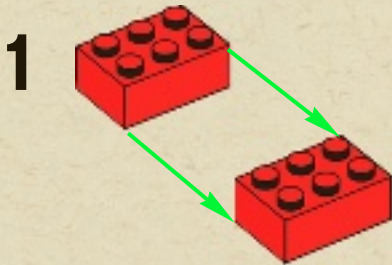

2

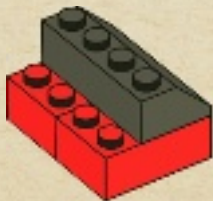

3

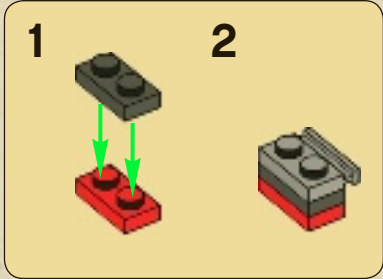
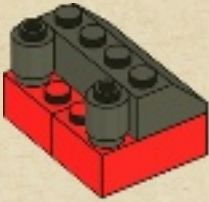

4

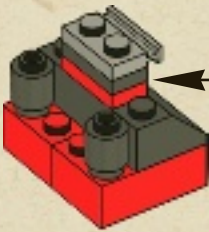

5

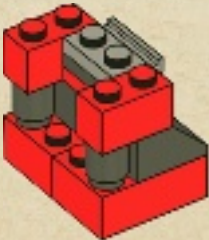

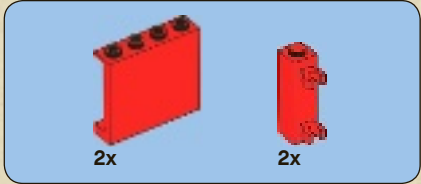
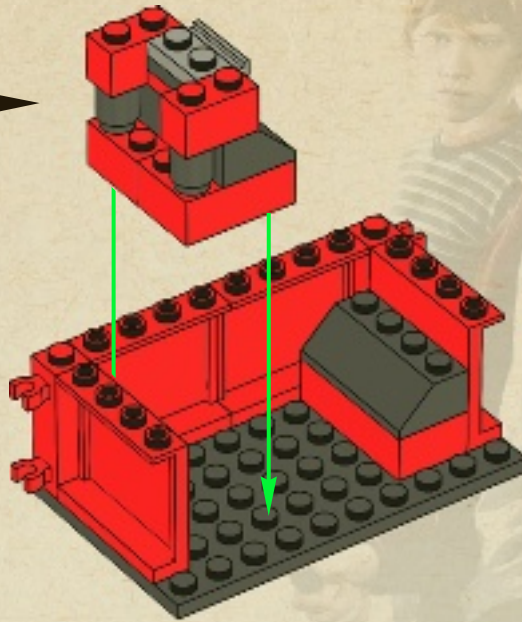
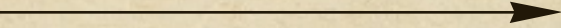

6

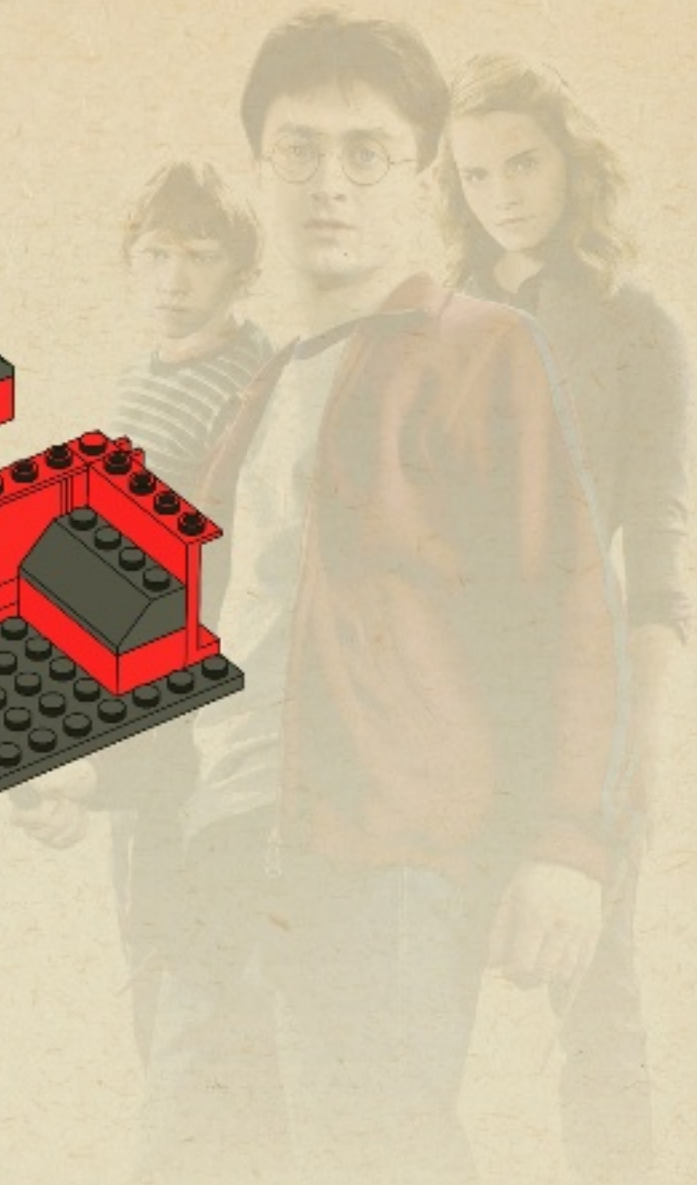
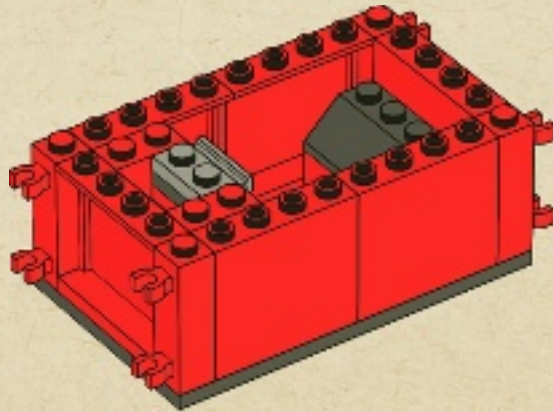

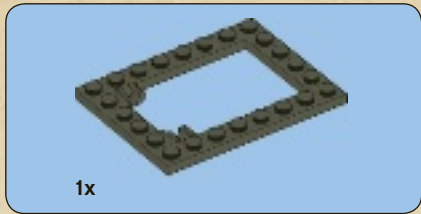

7

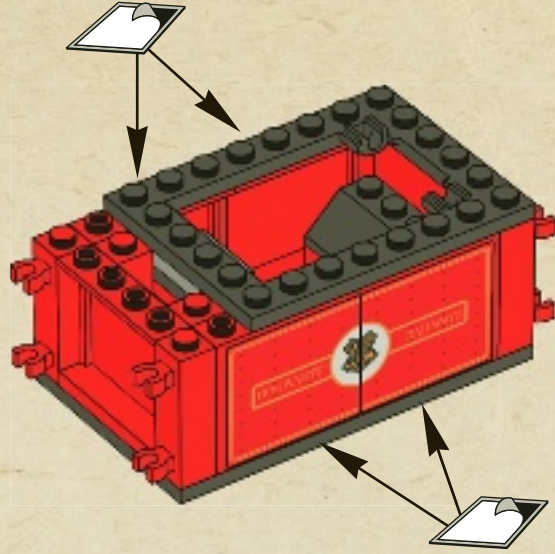

8

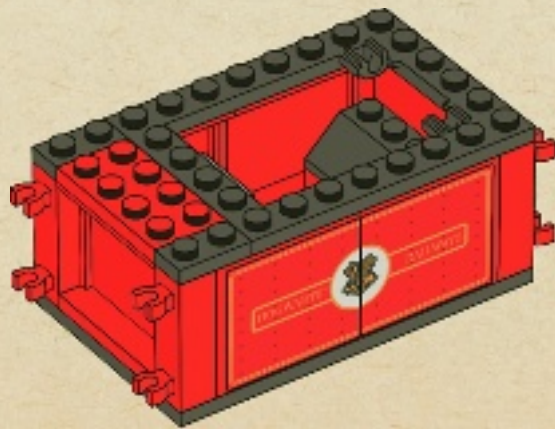

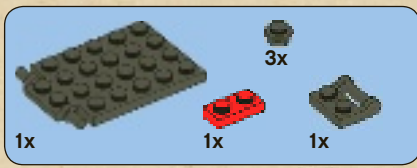

9

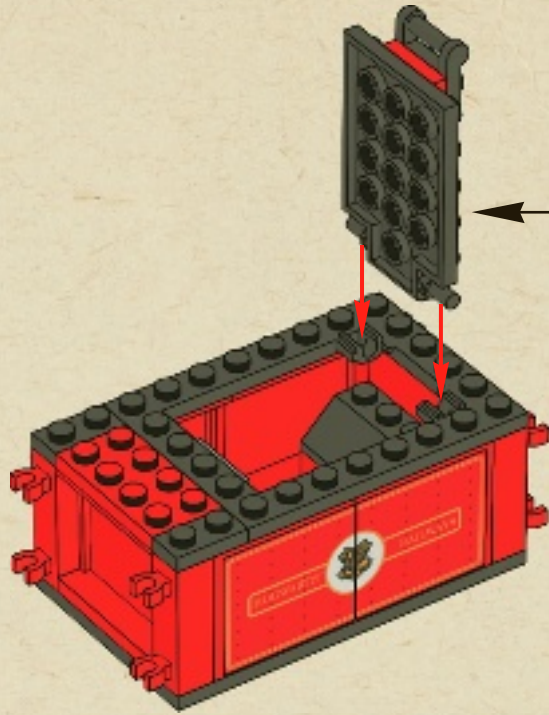
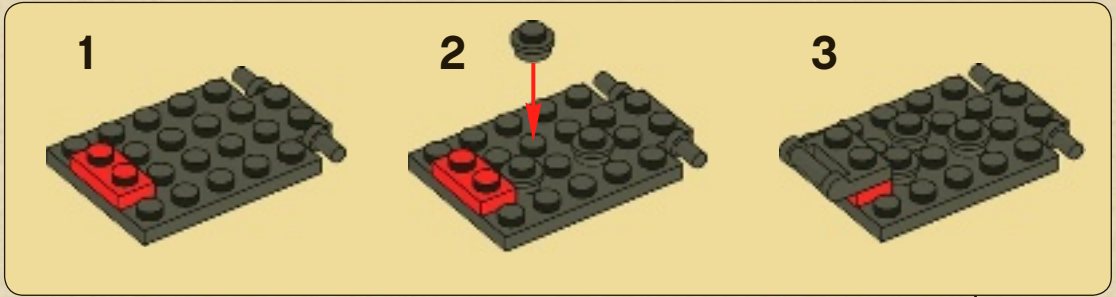

10





# 11



# 12







# 13

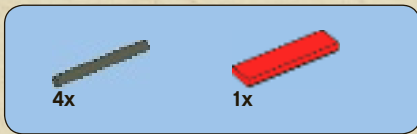

# 14

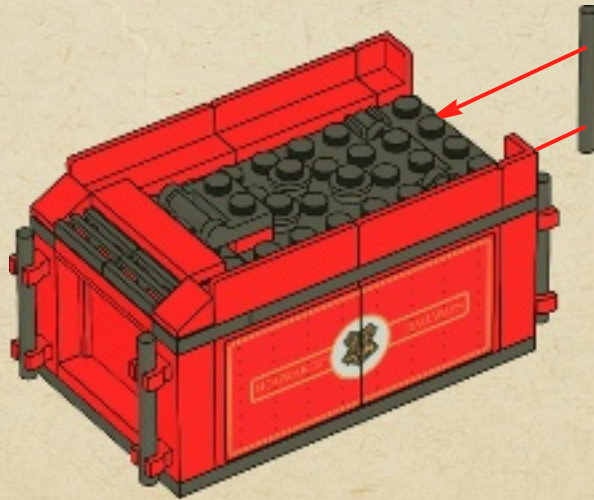

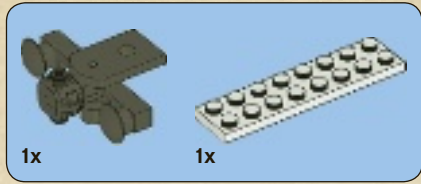

1

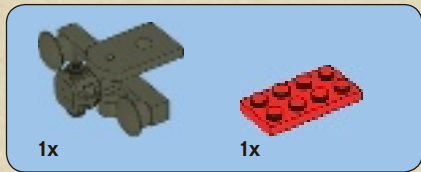
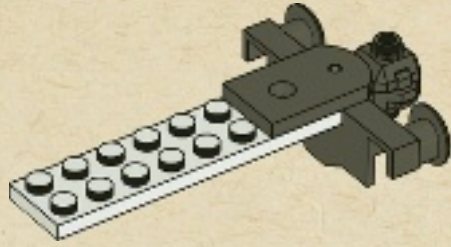

2

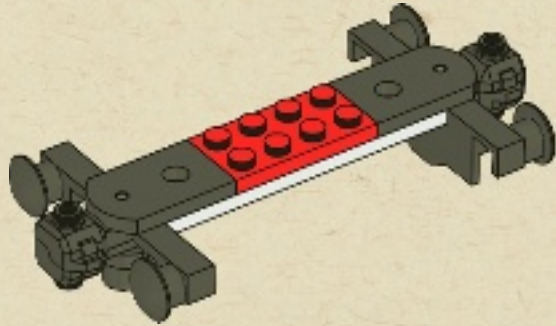

3

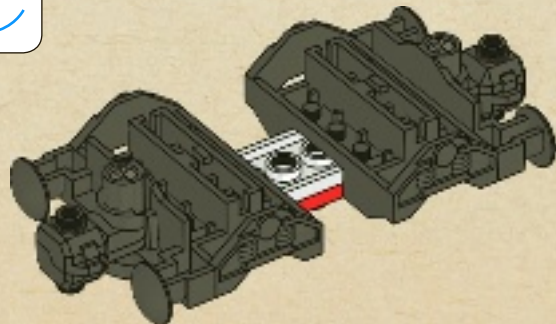



4

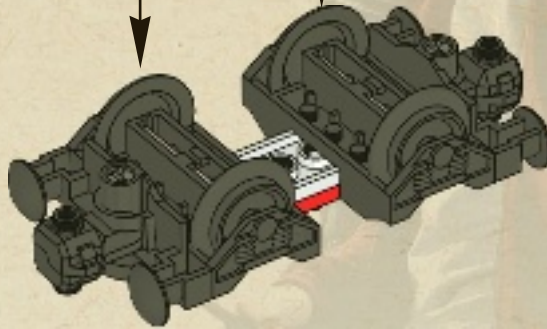
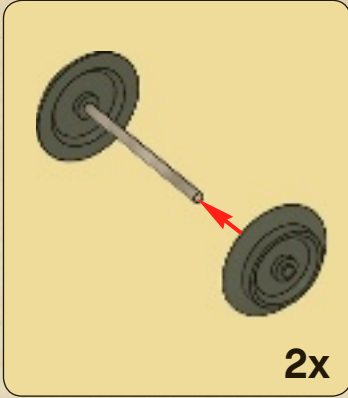

15

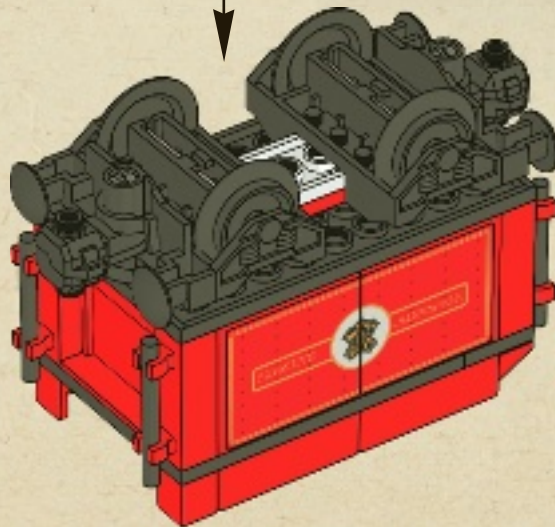



# 16

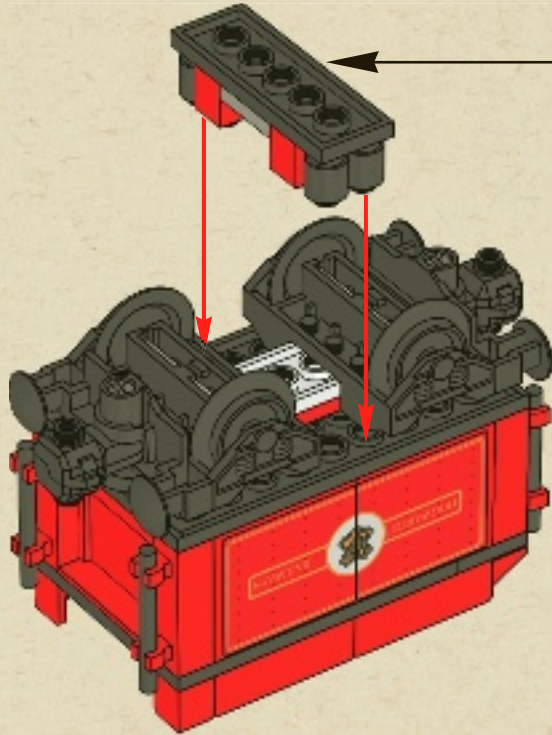
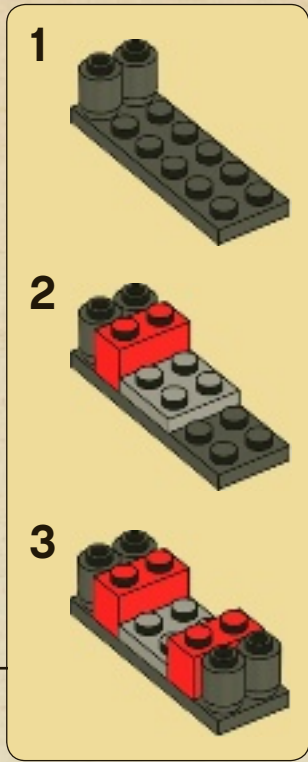

2x

17

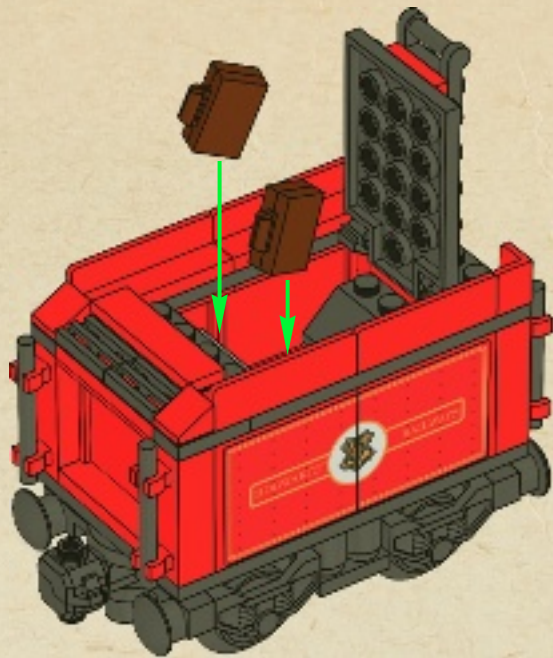

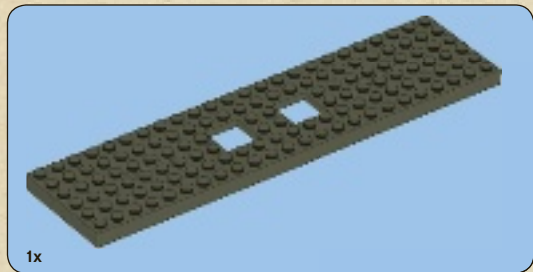
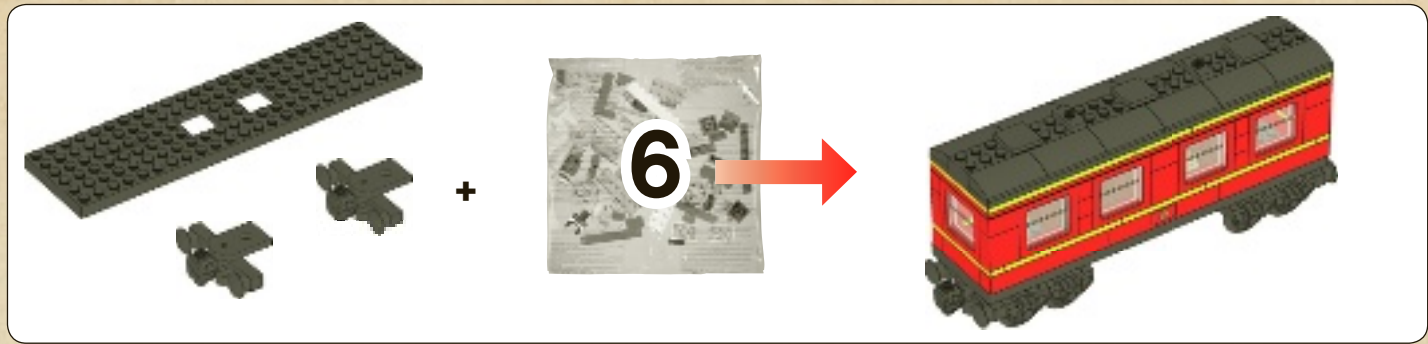

1

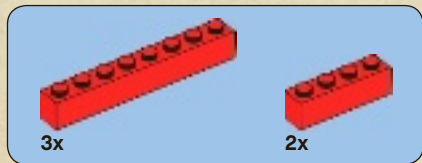
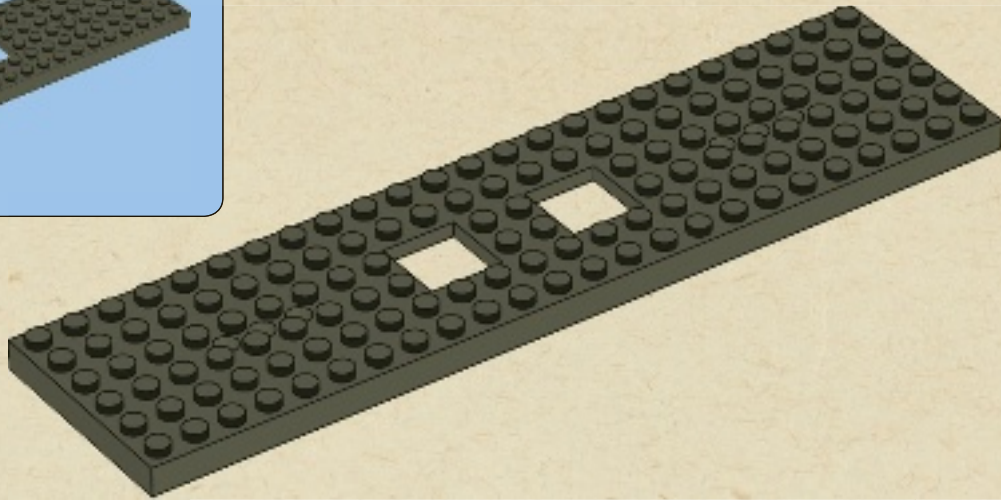

2

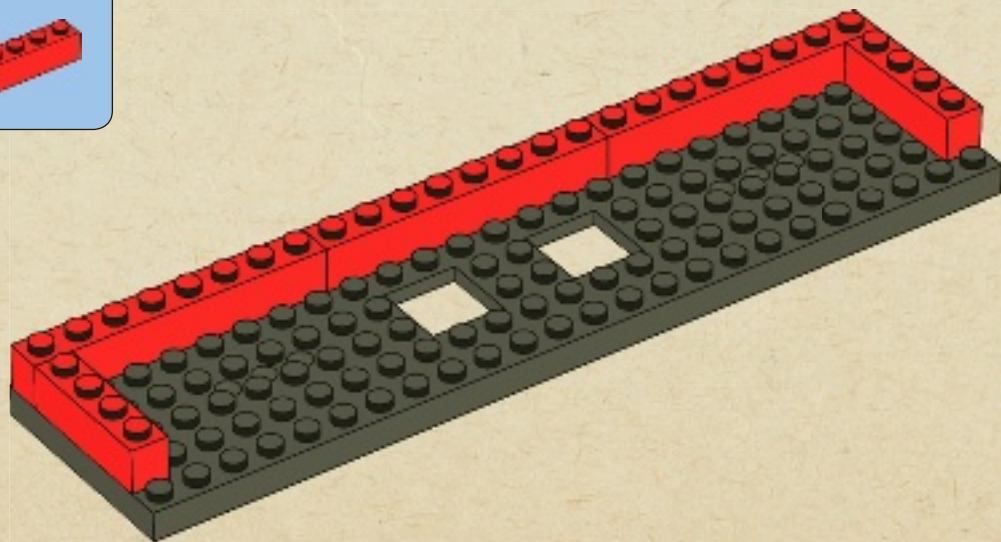



3

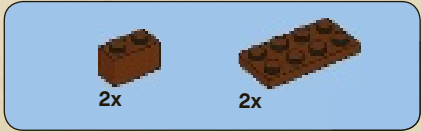
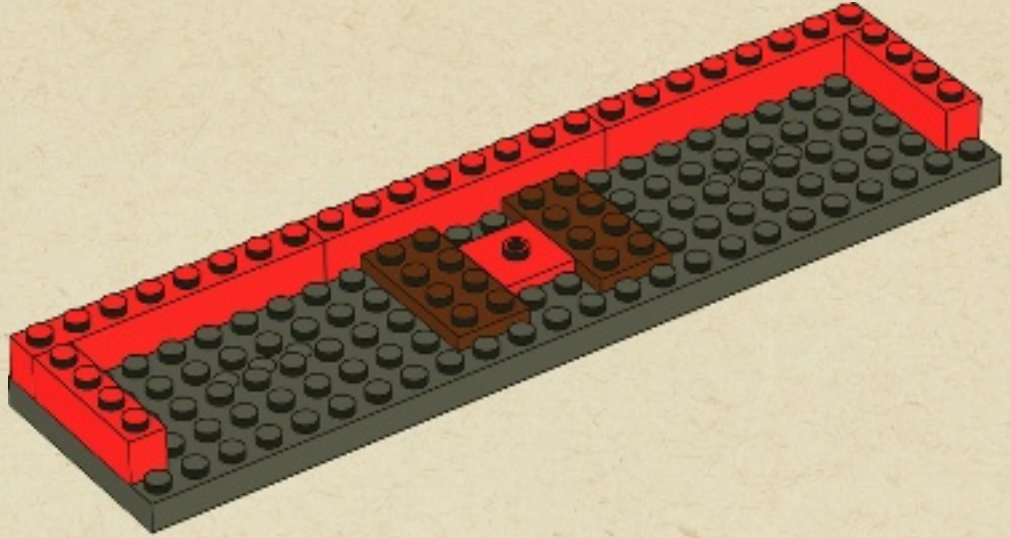

4

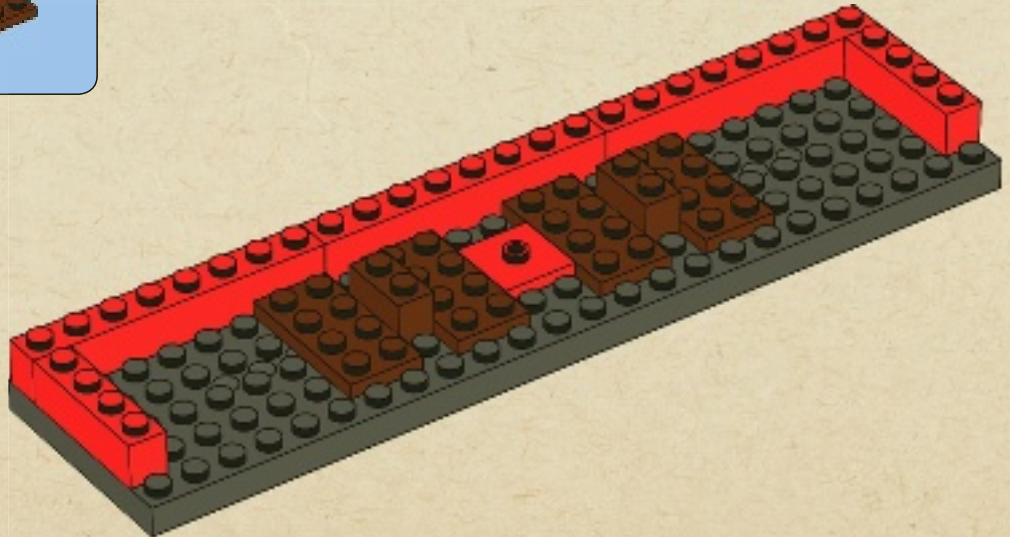



5

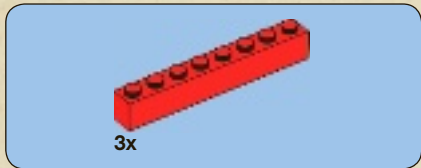
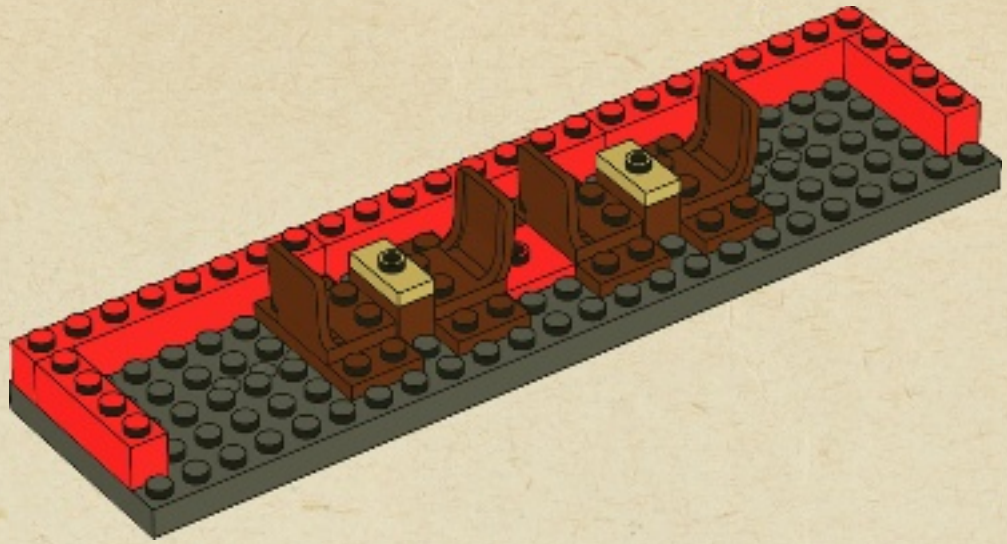

6

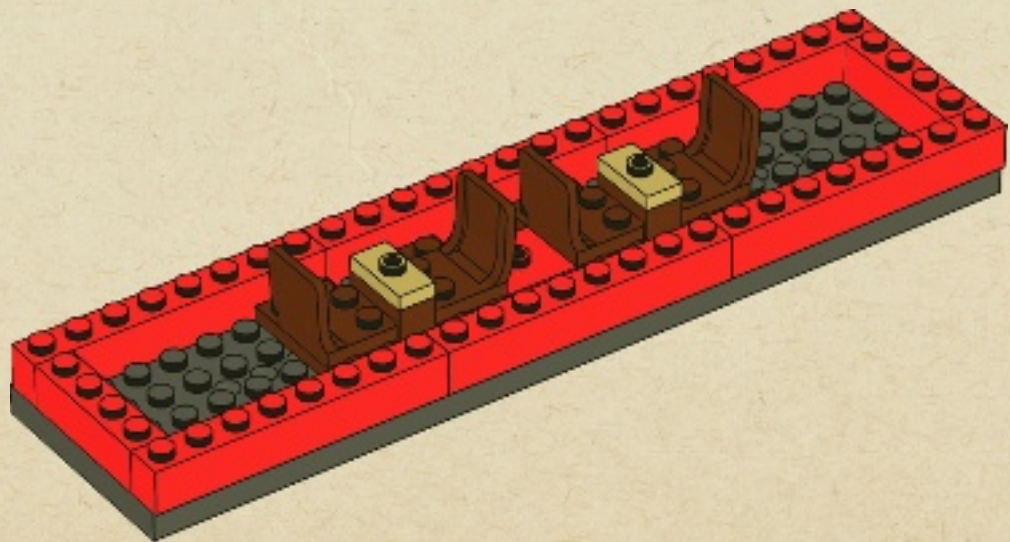



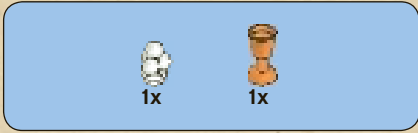

7

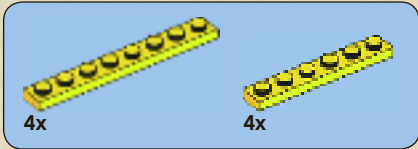
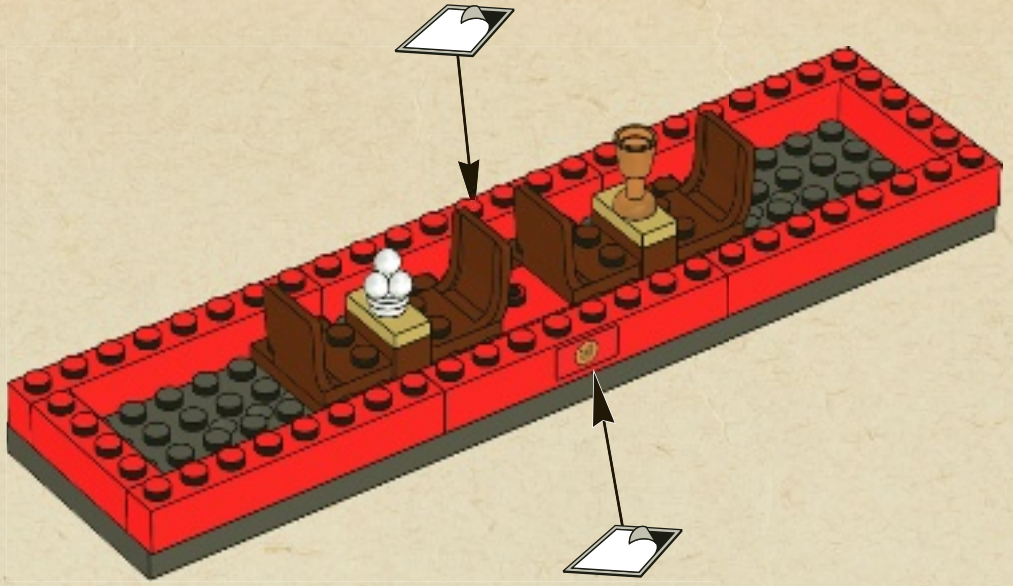

8

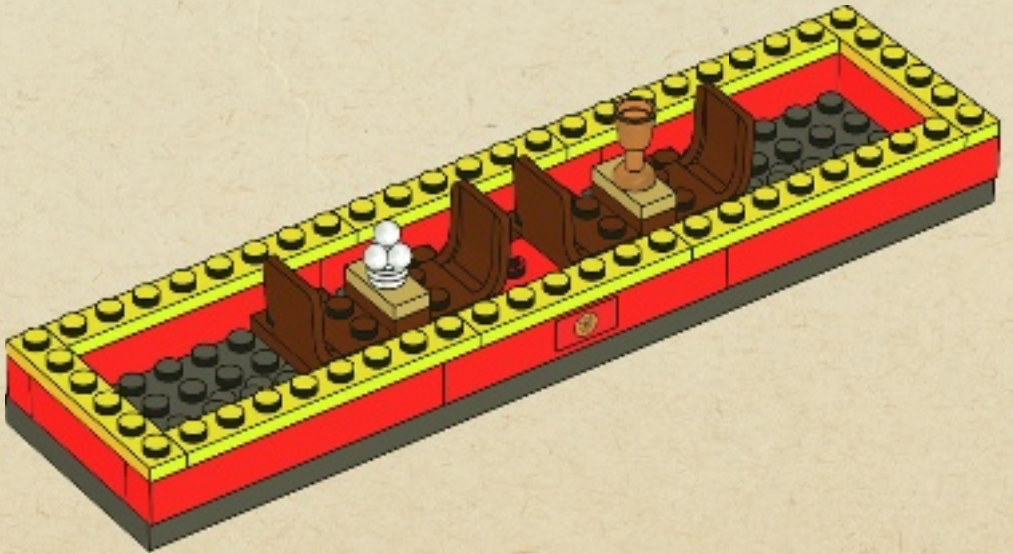

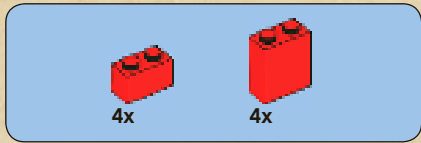

# 9

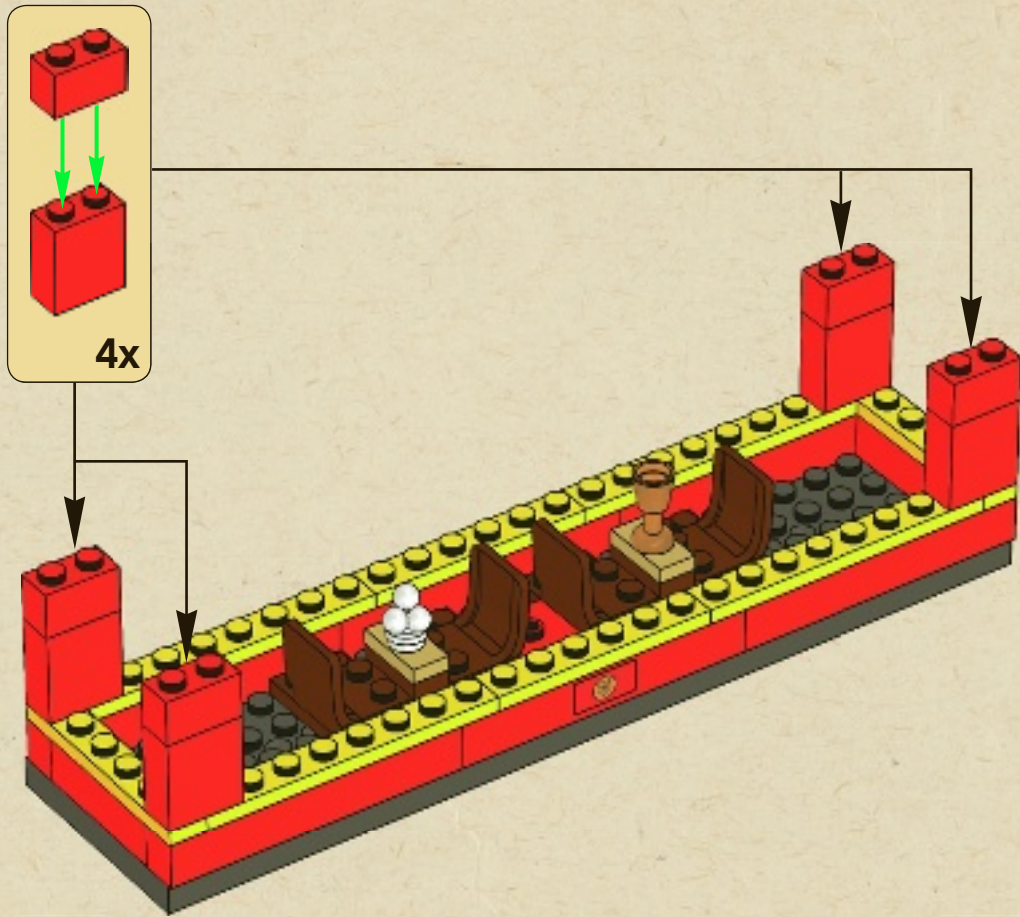

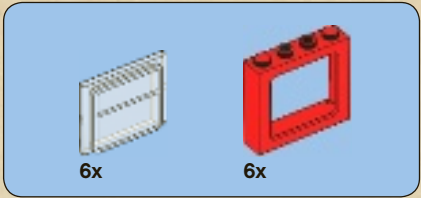

# 10

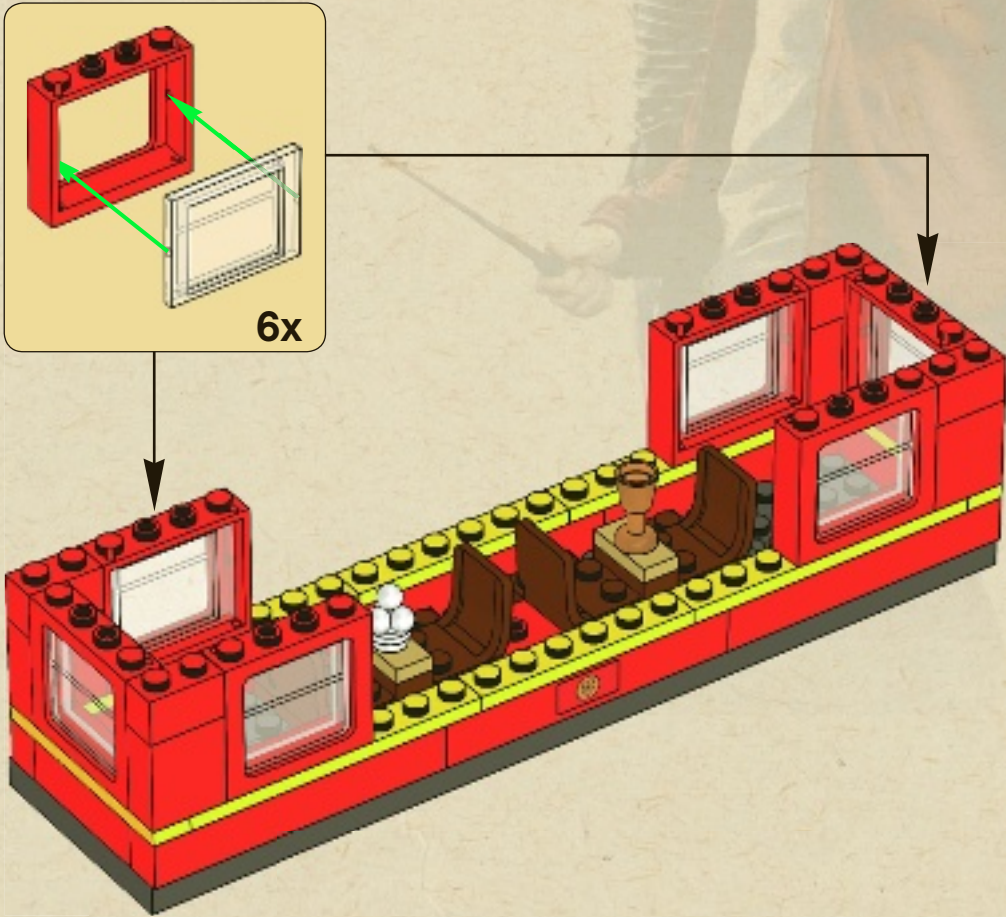



12x

# 11

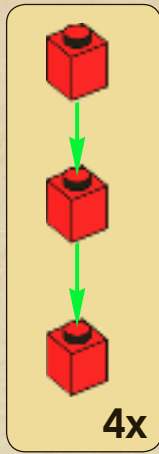

4x

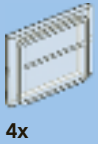
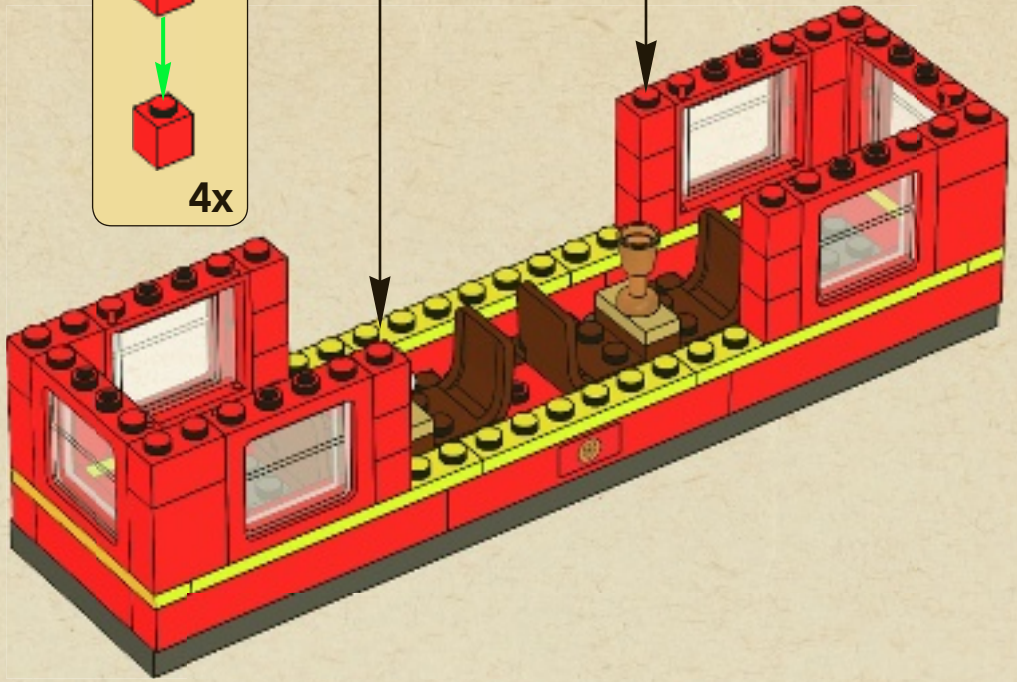

4x

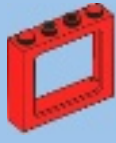

4x

# 12

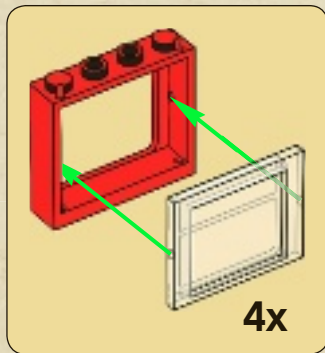

4x

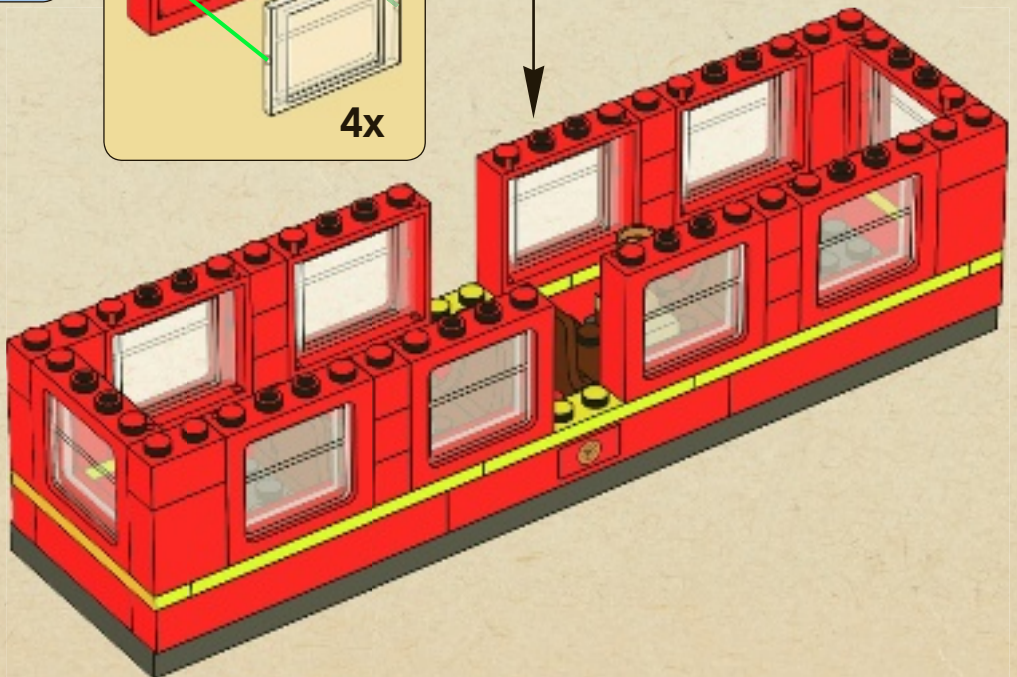

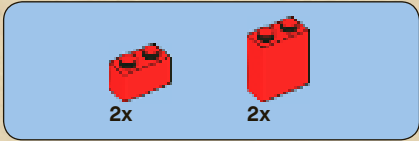

# 13

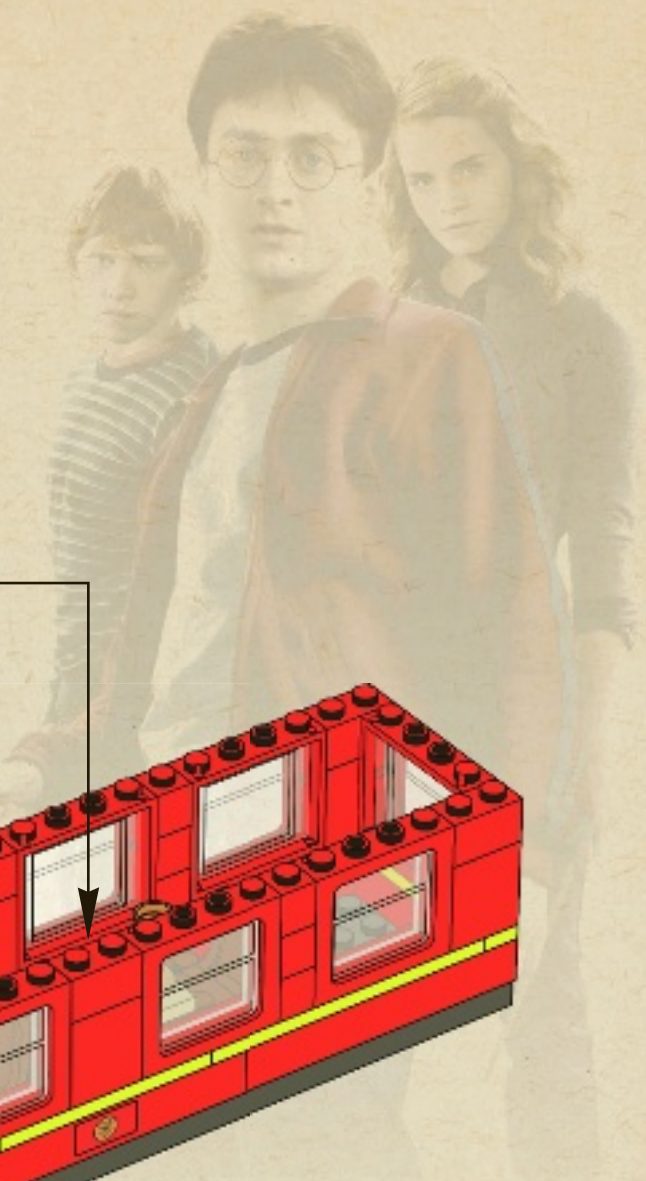
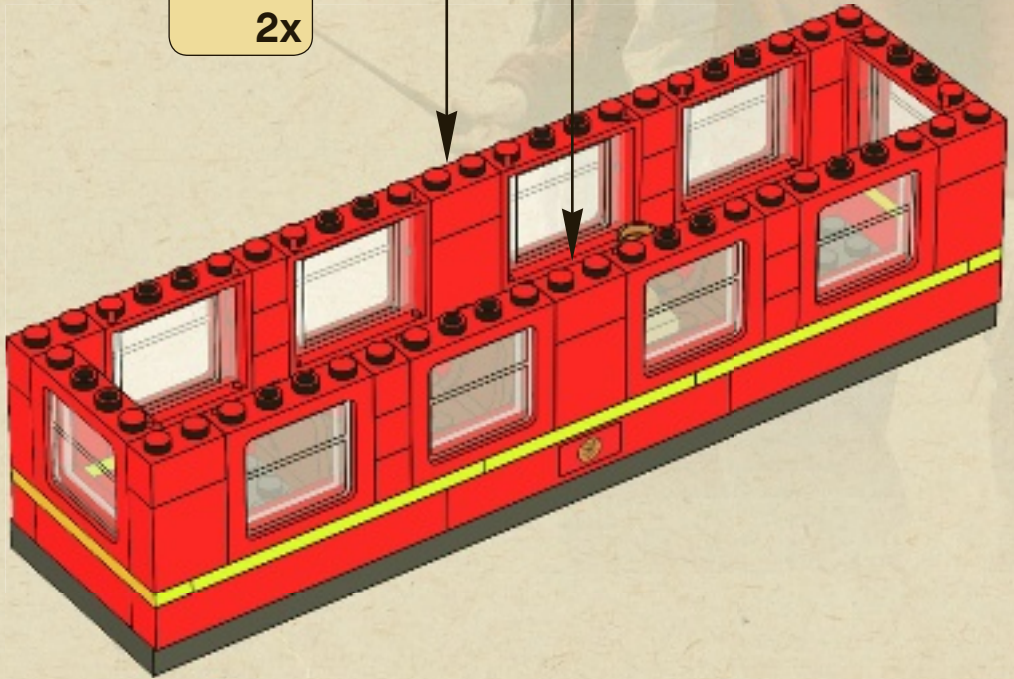
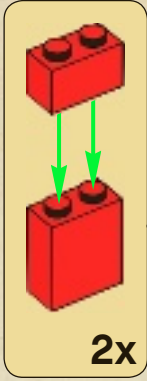

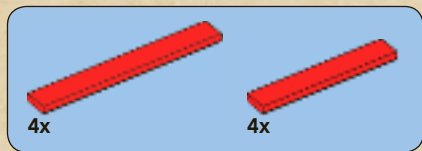

14

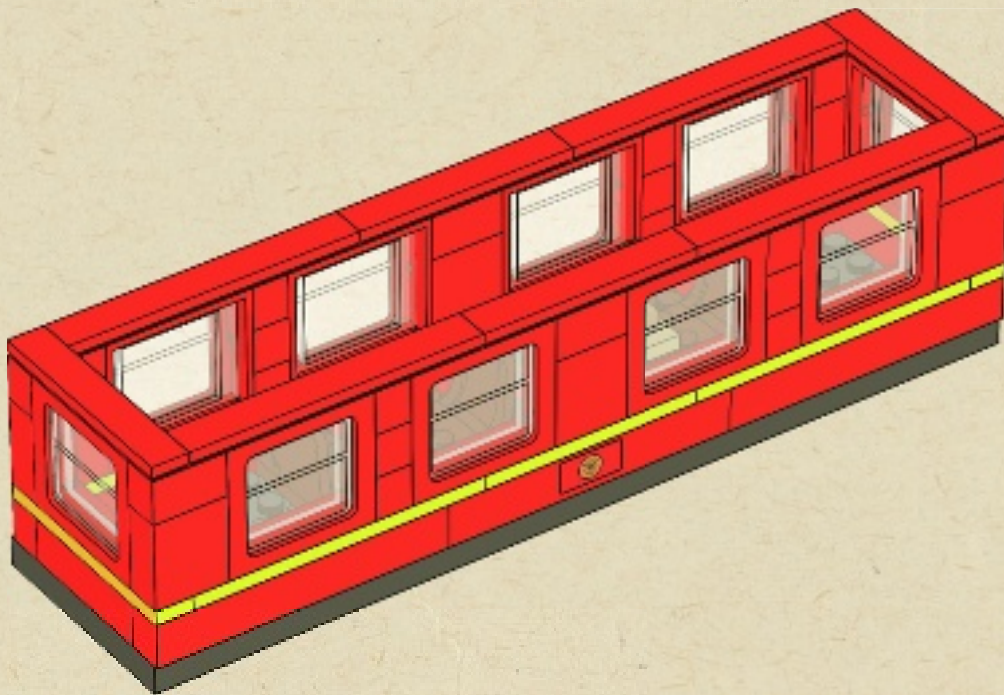

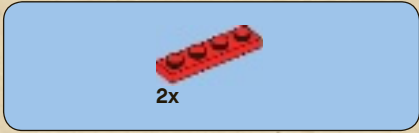

15

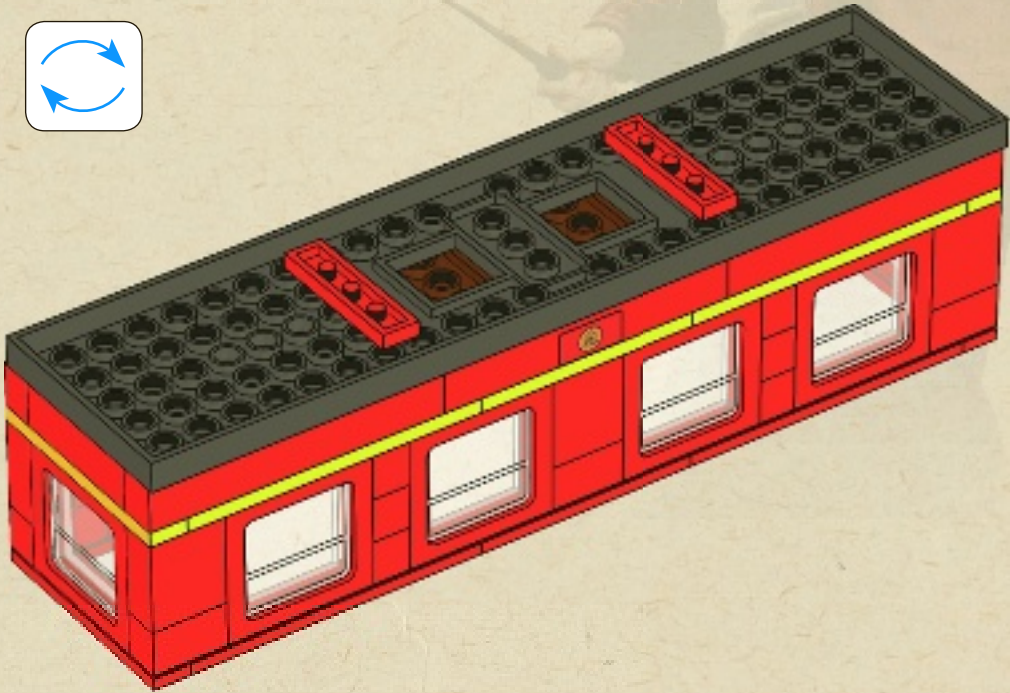

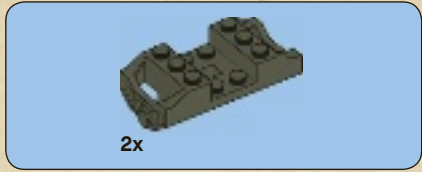

1

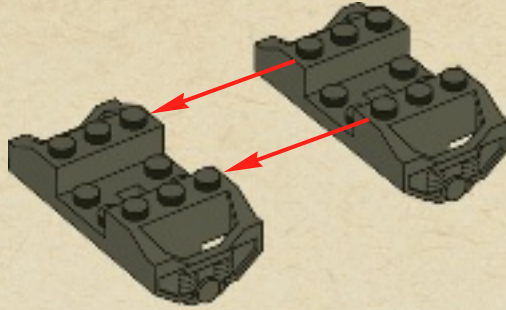

2



3







4

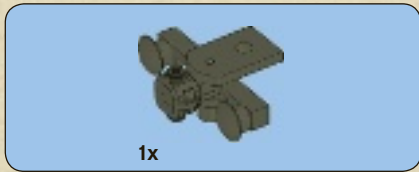
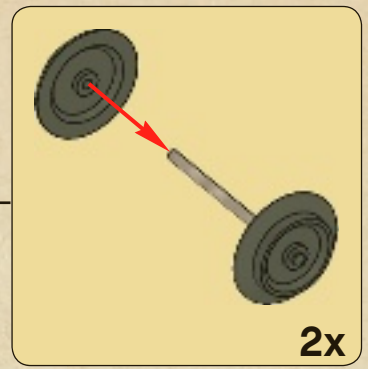
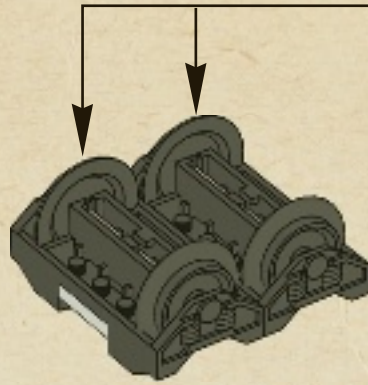

5

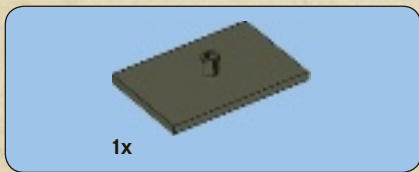
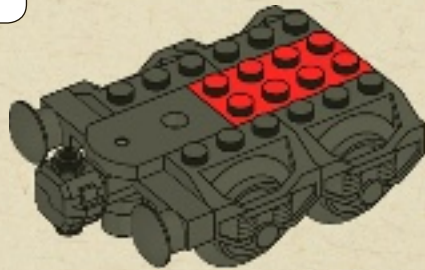
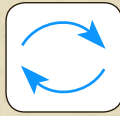

6

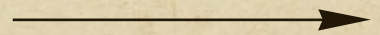
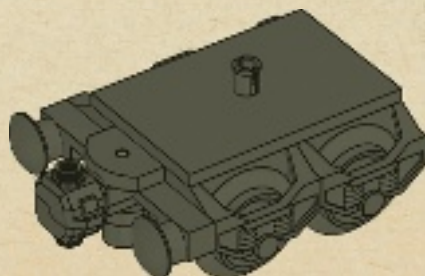

2x

16

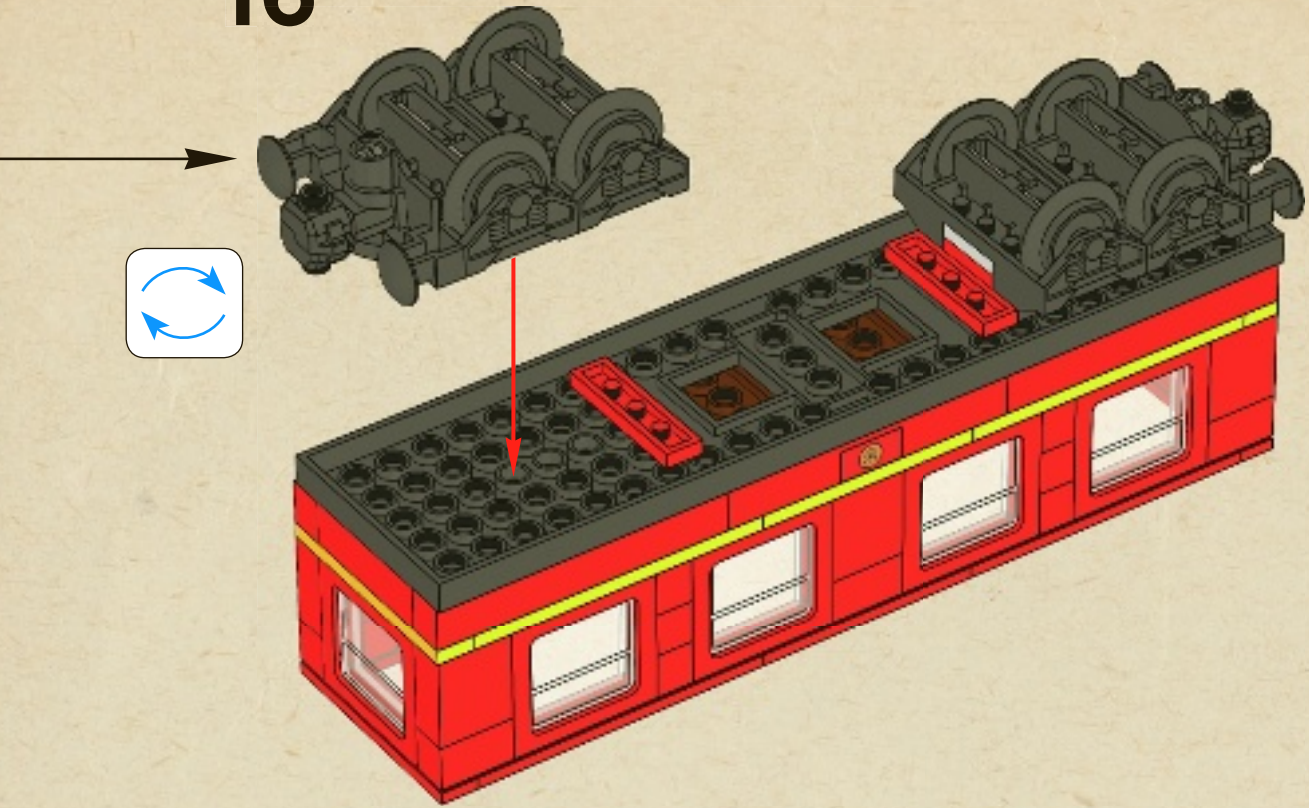

17

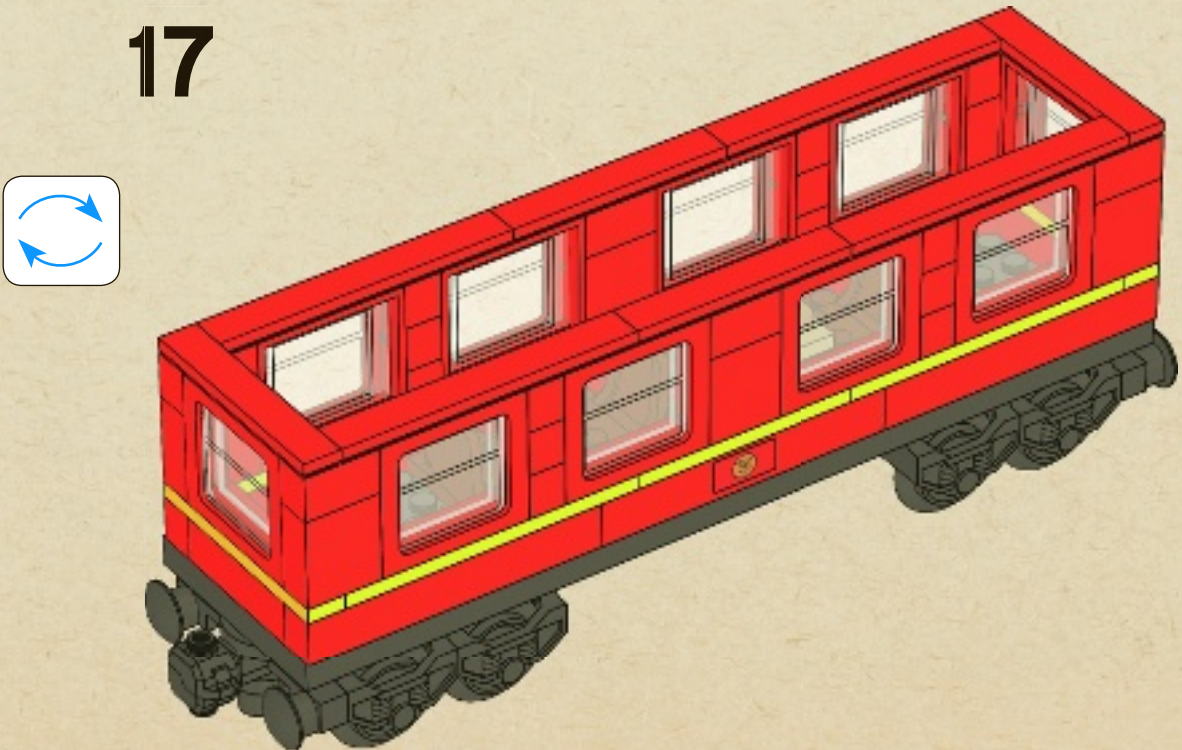

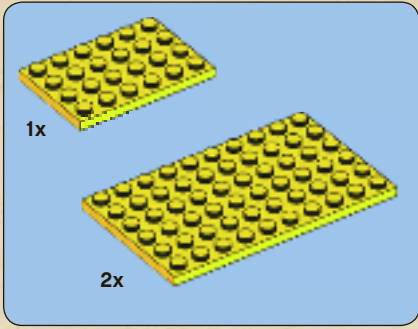
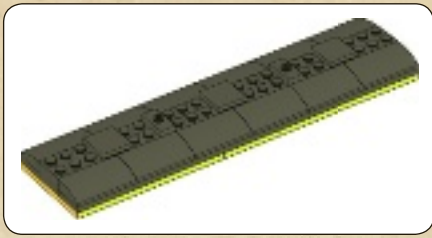

1

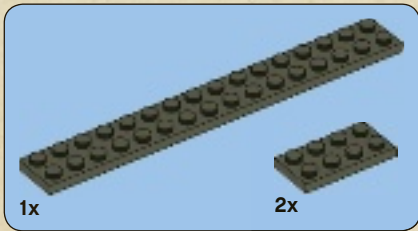
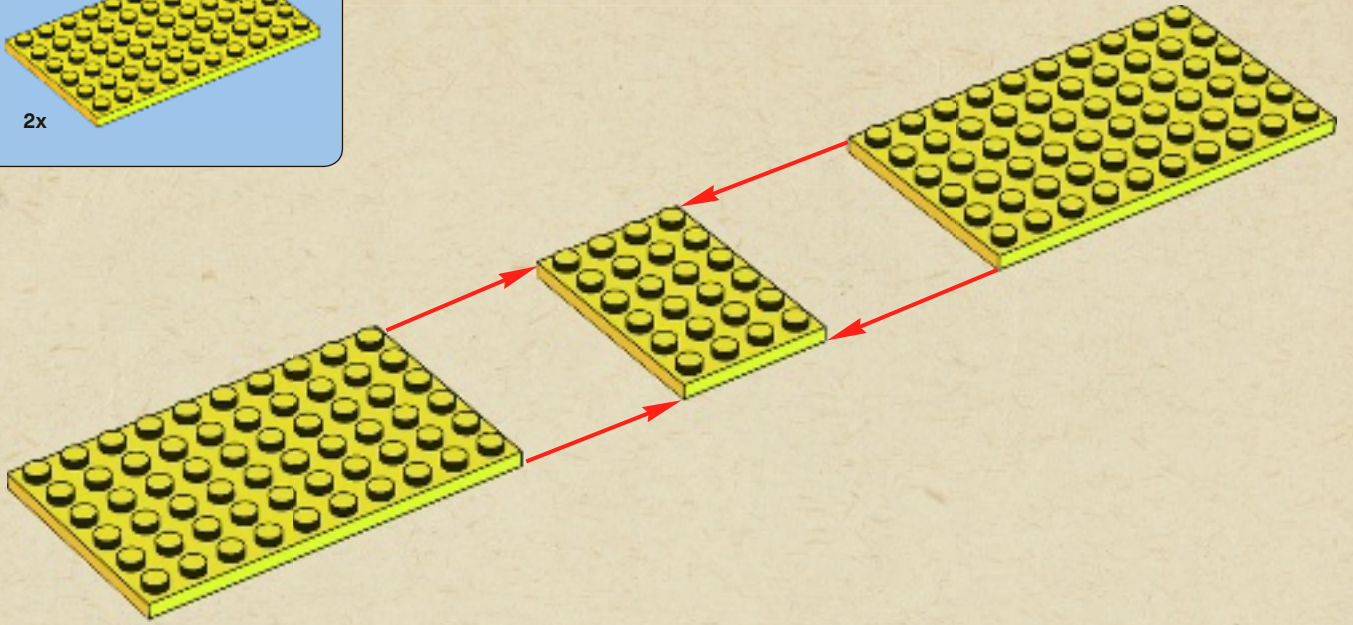

2

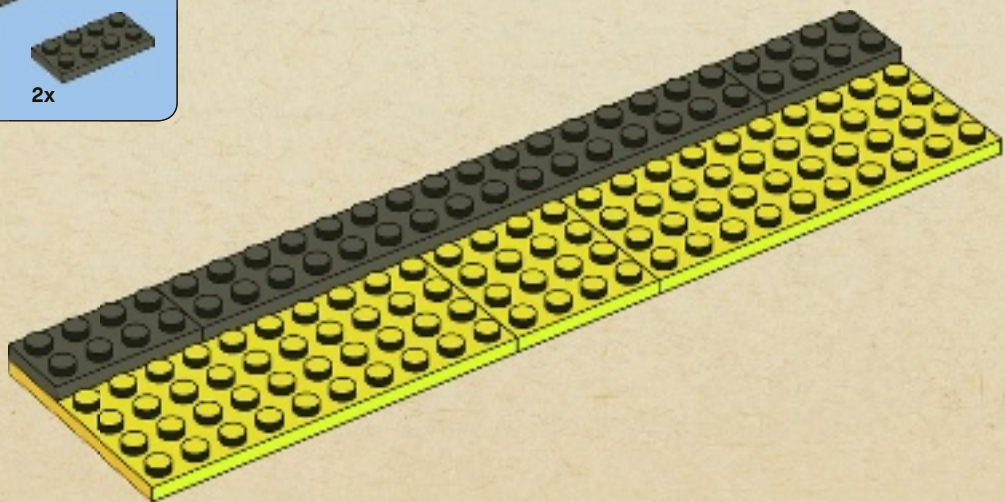

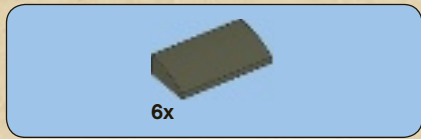

3

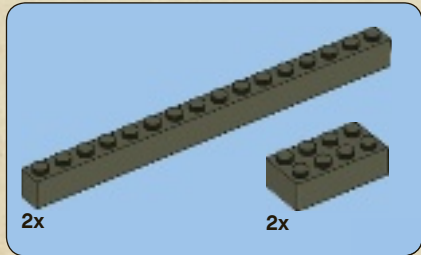
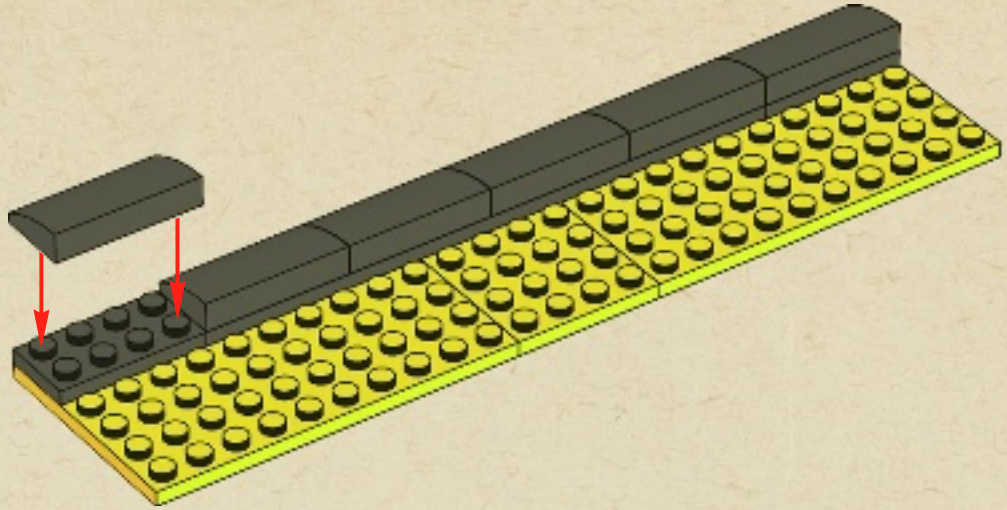

4

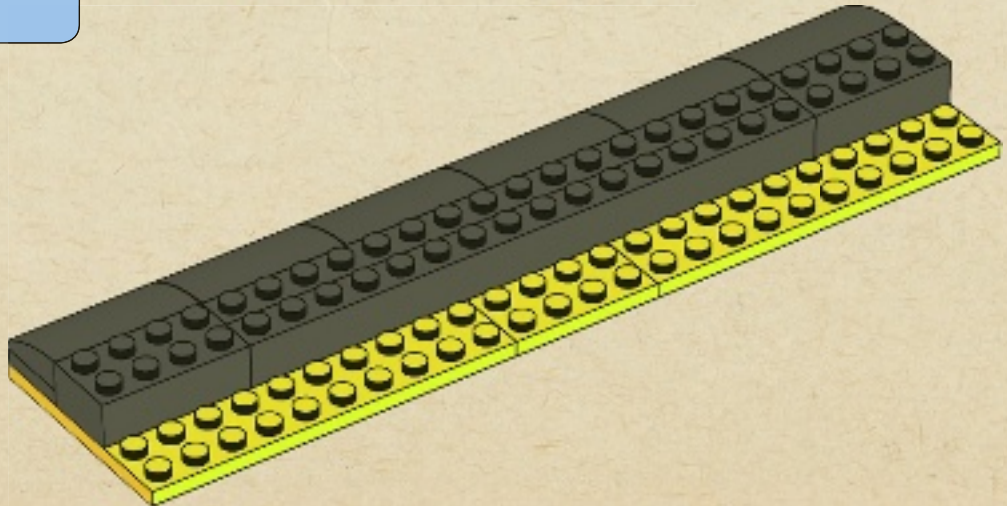

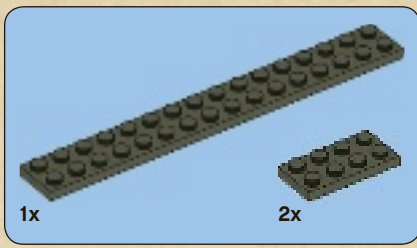

5

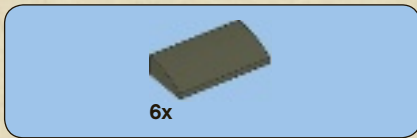
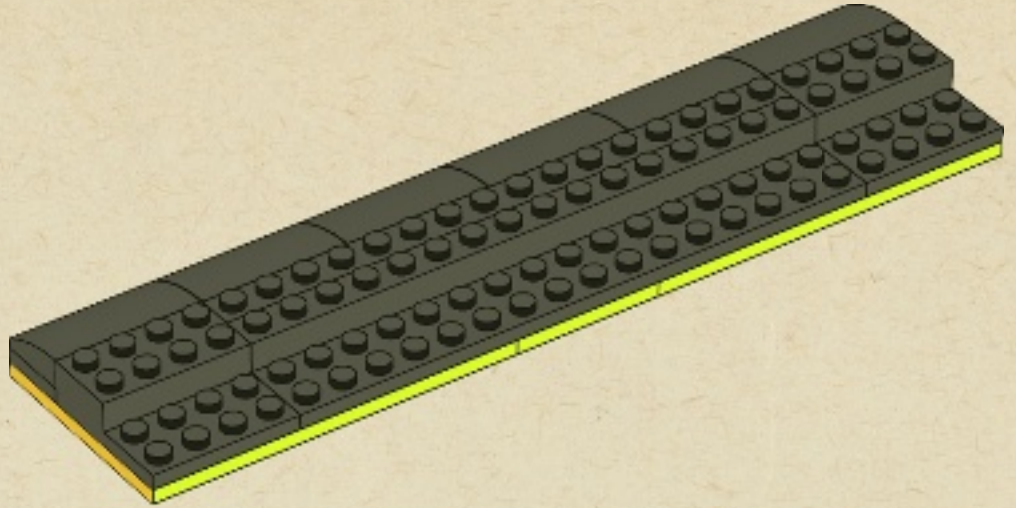

6

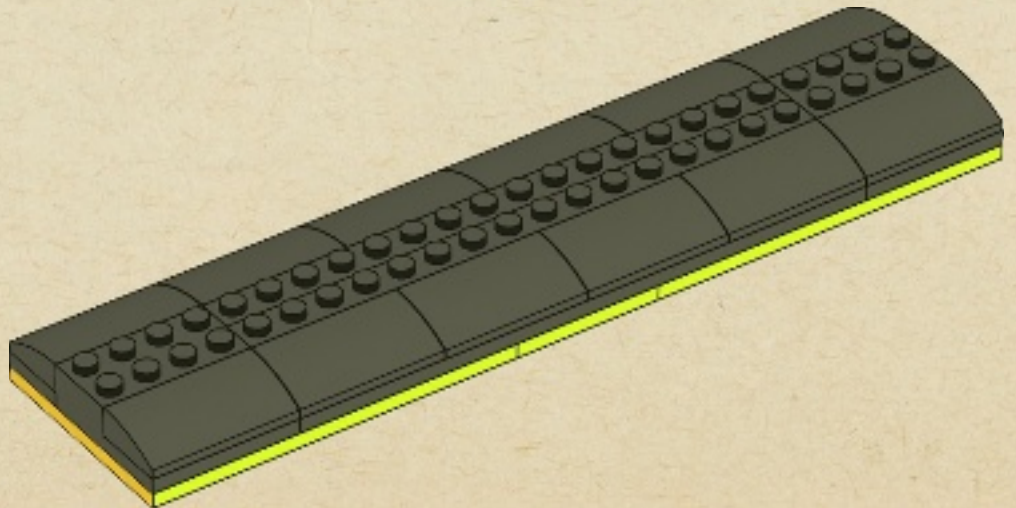

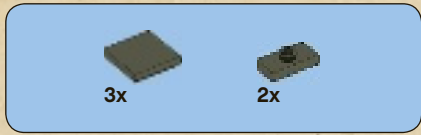

7

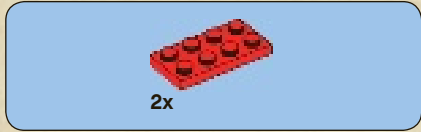
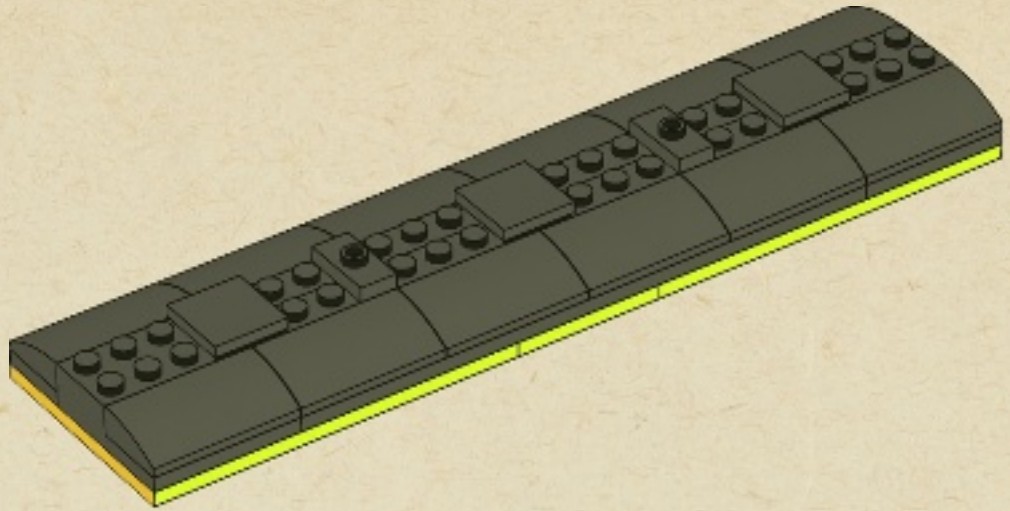

8

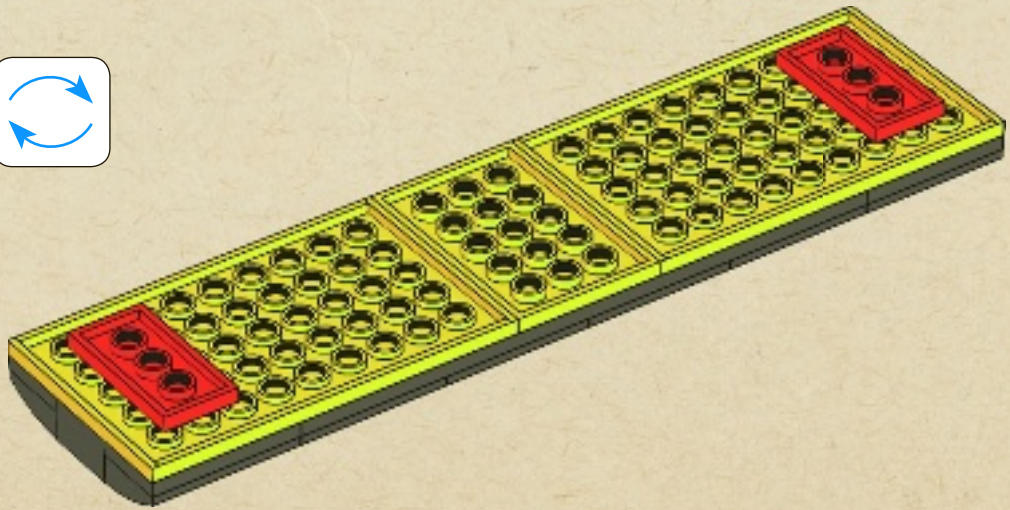

18

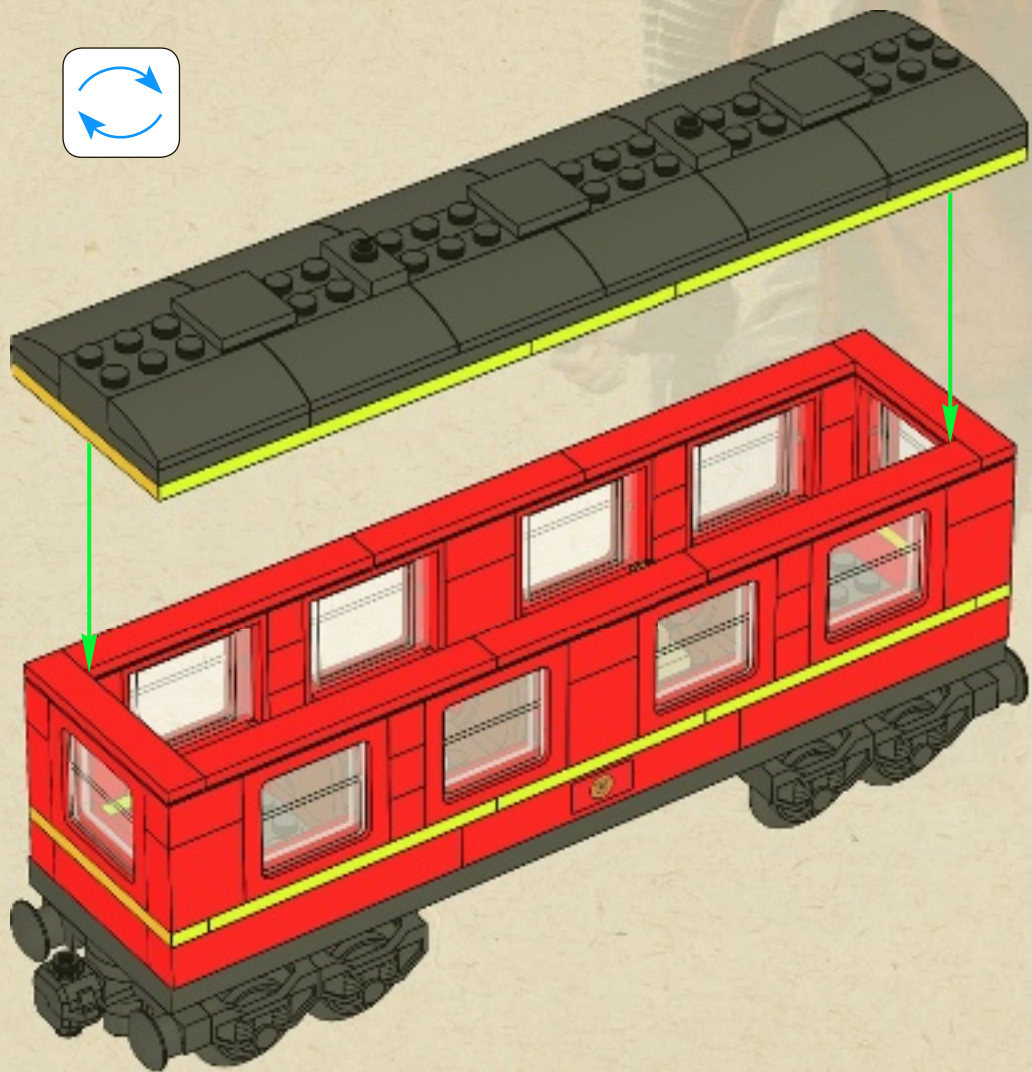

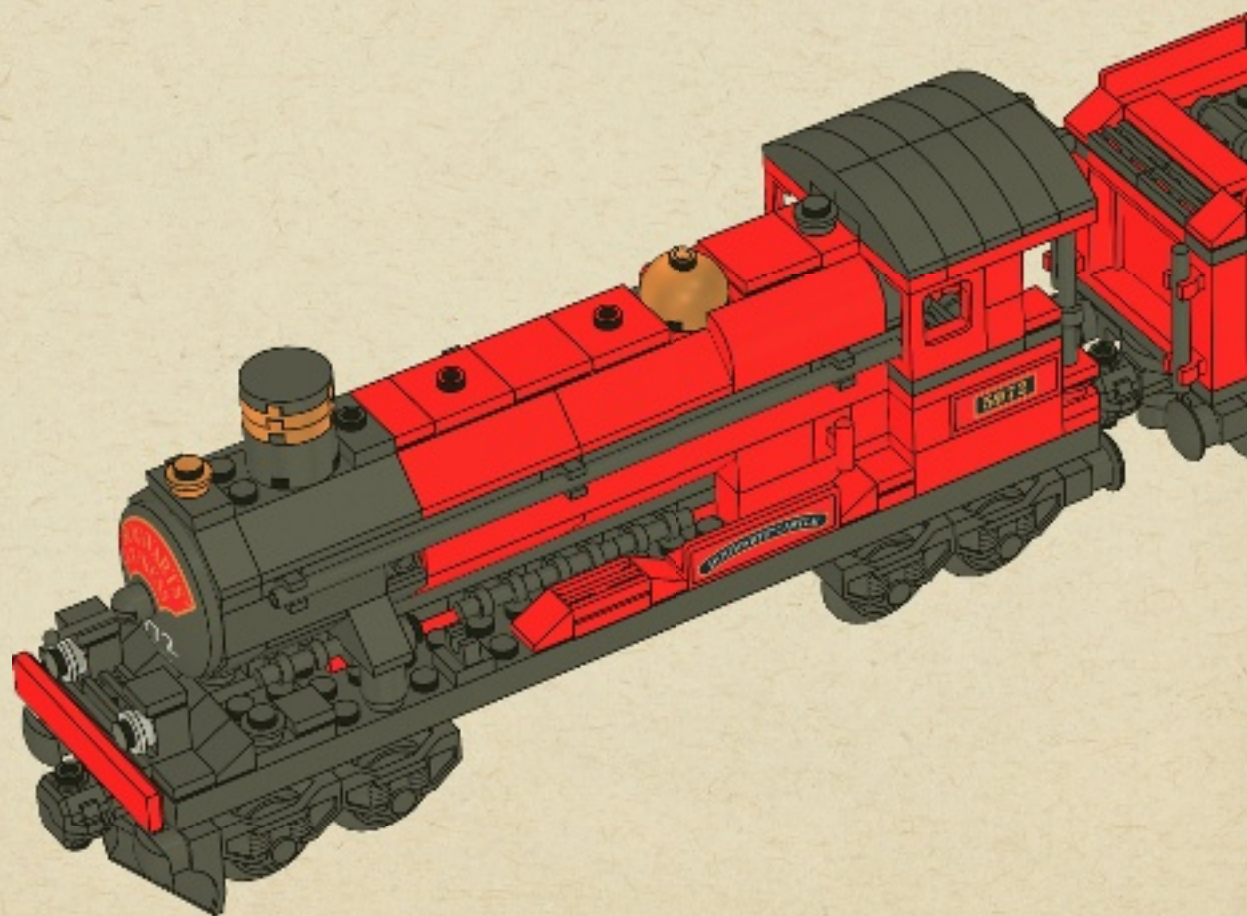



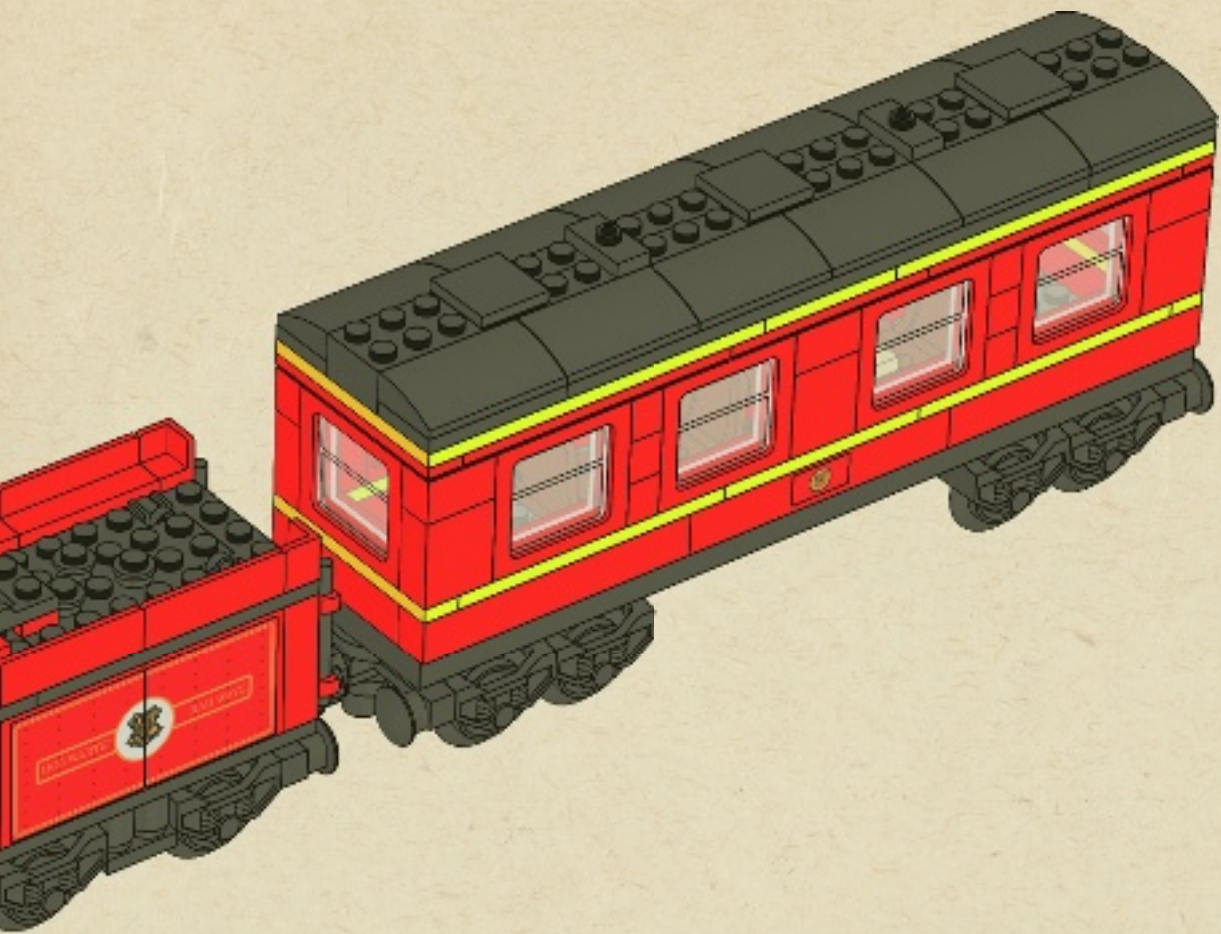

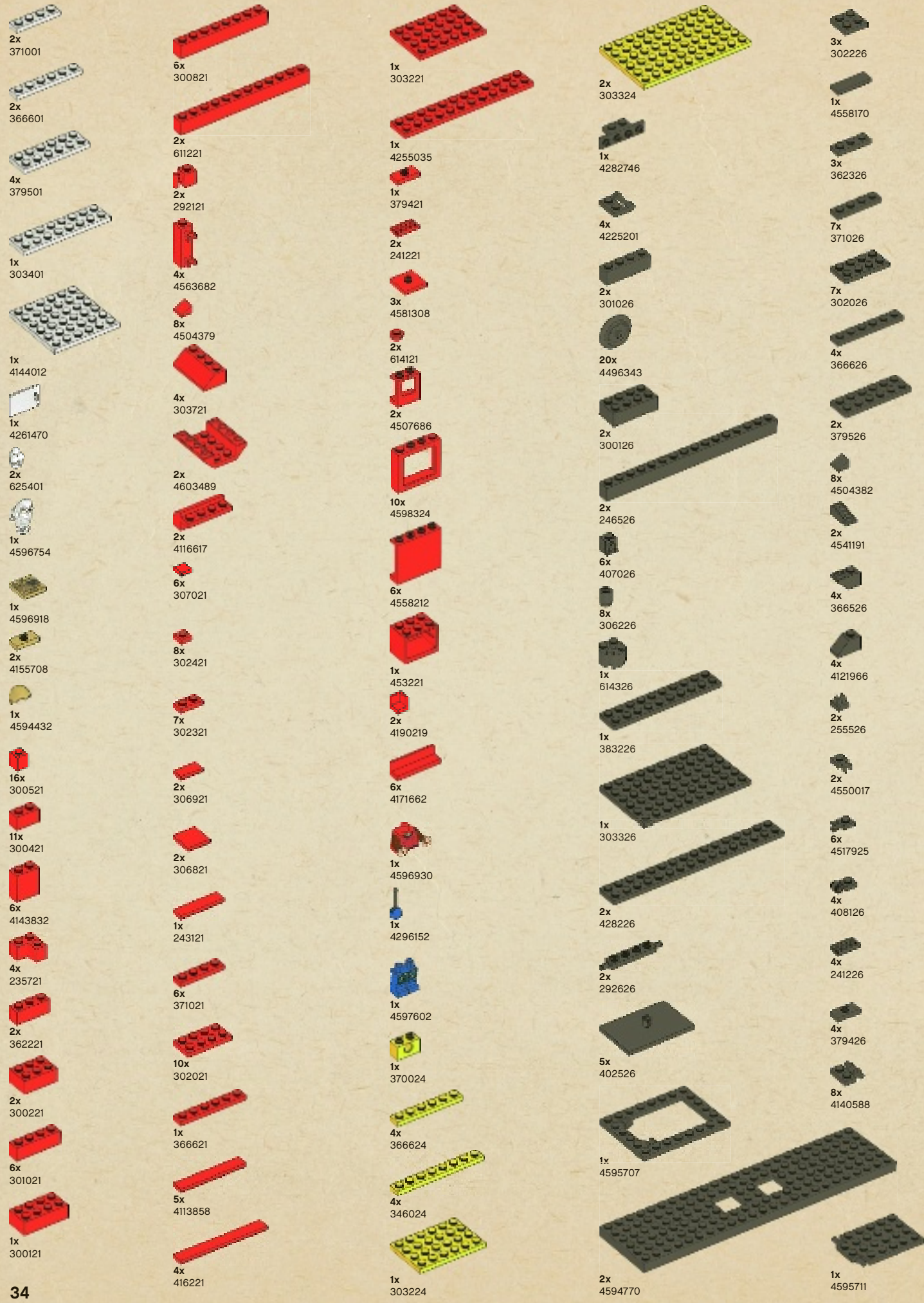

2x 371001  
 2x 366601  
 4x 379501  
 1x 303401  
 1x 4144012  
 1x 4261470  
 2x 625401  
 1x 4596754  
 1x 4596918  
 2x 4155708  
 1x 4594432  
 16x 300521  
 11x 300421  
 6x 4143832  
 4x 235721  
 2x 362221  
 2x 300221  
 6x 301021  
 1x 300121

6x 300821  
 2x 611221  
 2x 292121  
 4x 4563682  
 8x 4504379  
 4x 303721  
 2x 4603489  
 2x 4116617  
 6x 307021  
 8x 302421  
 7x 302321  
 2x 306921  
 2x 306821  
 1x 243121  
 6x 371021  
 10x 302021  
 1x 366621  
 5x 4113858  
 4x 416221

1x 303221  
 1x 4255035  
 1x 379421  
 2x 241221  
 3x 4581308  
 2x 614121  
 2x 4507686  
 10x 4598324  
 6x 4558212  
 1x 453221  
 2x 4190219  
 6x 4171662  
 1x 4596930  
 1x 4296152  
 1x 4597602  
 1x 370024  
 4x 366624  
 4x 346024  
 1x 303224

2x 303324  
 1x 4282746  
 4x 4225201  
 2x 301026  
 20x 4496343  
 2x 300126  
 2x 246526  
 6x 407026  
 8x 306226  
 1x 614326  
 1x 383226  
 1x 303326  
 2x 428226  
 2x 292626  
 5x 402526  
 1x 4595707  
 2x 4594770

3x 302226  
 1x 4558170  
 3x 362326  
 7x 371026  
 7x 302026  
 4x 366626  
 2x 379526  
 8x 4504382  
 2x 4541191  
 4x 366526  
 4x 4121966  
 2x 255526  
 2x 4550017  
 6x 4517925  
 4x 408126  
 4x 241226  
 4x 379426  
 8x 4140588  
 1x 4595711

- 2x 366026
- 4x 303726
- 10x 4251161
- 6x 307026
- 1x 306926
- 5x 302326
- 5x 306826
- 11x 614126
- 2x 415026
- 1x 4596757
- 2x 4106347
- 1x 73587
- 7x 4140303
- 3x 9339
- 1x 4157659
- 1x 4154853
- 1x 4113209
- 4x 4515290
- 4x 4248538
- 2x 249626
- 1x 4589489
- 5x 4589495
- 10x 287826
- 12x 4587844
- 1x 393826
- 1x 393726
- 2x 4599074
- 1x 4596523
- 1x 4594433
- 4x 3005740
- 10x 403440
- 2x 4248937
- 1x 4502193
- 2x 3005741
- 2x 4113954
- 1x 4218642
- 2x 4179830
- 1x 4163696
- 4x 4598016
- 4x 4565363
- 2x 4596065
- 4x 4598015
- 2x 4288497
- 8x 4179826
- 16x 4179825
- 2x 4597999
- 3x 4598008
- 6x 4598010
- 7x 4179828
- 2x 4179829
- 1x 4596067
- 1x 4596068
- 5x 4598017
- 2x 4598011
- 1x 4499710
- 10x 4298979
- 1x 4596636
- 1x 4597340
- 4x 4211149
- 1x 4211201
- 4x 4211186
- 4x 4211206
- 1x 4211163
- 1x 4533101
- 4x 4262974
- 2x 4211235
- 1x 4596335
- 1x 4597977
- 1x 4211401
- 1x 4211474
- 2x 4211614
- 3x 4211398
- 2x 4211397
- 3x 4558169
- 3x 4211429
- 1x 4596917
- 1x 4211356
- 3x 4211395
- 2x 4222960
- 7x 4211568
- 2x 4211525
- 2x 4211373
- 4x 4215513
- 2x 4211515
- 1x 4512743
- 1x 4226995
- 1x 4532589
- 1x 4211483
- 1x 4211088
- 1x 4211085
- 1x 4211094
- 1x 4211133
- 1x 4568734
- 1x 4211065
- 2x 4210651
- 2x 4211039
- 1x 4222693
- 1x 4596315
- 1x 4597608
- 1x 4287814
- 1x 4596738
- 2x 4289542
- 1x 4596938
- 1x 4578853
- 1x 4596330
- 1x 4596302
- 1x 4596570
- 1x 4596923
- 1x 4596604
- 1x 4569316
- 1x 4585493
- 1x 4523159
- 2x 4598025
- 1x 4505990



**Customer Service**  
**Kundenservice**  
**Service Consommateurs**  
**Servicio Al Consumidor**

[www.lego.com/service](http://www.lego.com/service) or dial

**: 00800 5346 5555**  
**: 1-800-422-5346**





# Harry Potter™ HOGWARTS™



3862  
Harry Potter™ Hogwarts™



2-4 8+ 20-40





# Harry Potter



**FREE! GRATIS! GRATUIT!**



**club**  
MAGAZINE™

**www.LEGOclub.com**



**00800 5346 5555\***



**1-866-534-6258 • 1-877-518-5346**

US & Canada only

Canada seulement

\* FreePhone. Mobile charges may apply. \* Numéro sans Frais. Des Frais peuvent s'appliquer avec les téléphones cellulaires. \* Gebührenfrei, Kosten für Anrufe aus Mobilfunknetzen können abweichen. \* Gratis telefonnummer vanaf vaste lijn. \* Det er ett gratis nummer, når du ringer fra Fasttelefon. \* Det er gratis, når du ringer från en Fast telefon.



**VISIT THE WORLD'S  
BIGGEST LEGO® SHOP!**

**www.LEGOshop.com**



# WIN!

Go to [www.nielsen.com/LEGO](http://www.nielsen.com/LEGO) to fill out a survey for a chance to win a cool LEGO® Product. No purchase necessary. Open to all residents where not prohibited.

 [www.LEGO.com](http://www.LEGO.com)

# www.nielsen.com/LEGO

## GEWINNE!

Nimm an der Umfrage auf [www.nielsen.com/LEGO](http://www.nielsen.com/LEGO) teil und hab die Chance ein cooles LEGO® Produkt zu gewinnen! Die Teilnahme am Gewinnspiel führt zu keinerlei Kaufverpflichtungen. Teilnahme in allen nicht ausgeschlossenen Ländern möglich.

## WIN!

Ga naar [www.nielsen.com/LEGO](http://www.nielsen.com/LEGO), vul een enquêteformulier in en maak kans op een cool LEGO® product. Geen aankoopverplichting. Iedereen mag deelnemen, uitgezonderd ingezetenden van landen waar een enquêteverbod geldt.

## GAGNE!

Visite [www.nielsen.com/LEGO](http://www.nielsen.com/LEGO) pour répondre à un questionnaire et avoir une chance de gagner un produit LEGO® très cool! Aucune obligation d'achat. Ouvert à tous les résidents des pays autorisés.

## 当てよう!

[www.nielsen.com/LEGO](http://www.nielsen.com/LEGO)にアクセスして、アンケートにご記入ください。当選者にはレゴ製品を差し上げます。

お買い上げの必要はありません。禁止されていない限り、すべての国籍にご利用いただけます。

LEGO, the LEGO logo and the Minifigure are trademarks of the/sont des marques de commerce de/son marcas registradas de LEGO Group. ©2010 The LEGO Group. ©2010 Lucasfilm Ltd. & TM. All rights reserved. Used under authorization./Todos los derechos reservados. Utilisé sous autorisation./Todos los derechos reservados. Usado bajo autorización. HARRY POTTER, characters, names and related indicia are trademarks of and © Warner Bros. Entertainment Inc. Harry Potter Publishing Rights © J.K.R. HARRY POTTER et tous les personnages et éléments qui y sont associés sont des marques de commerce et © de Warner Bros. Entertainment Inc. Droits d'édition de Harry Potter © J.K.R. HARRY POTTER, sus personajes, nombres, y los símbolos son marcas y © de Warner Bros. Derechos de publicación de Harry Potter © J.K.R. TM/MC & © Warner Bros. Entertainment Inc. (s10)