



# Disney

43214



**WARNING: CHOKING HAZARD.**  
Small parts. Not for children under 3 years.



## **Get excited about our new packaging!**

We're switching from plastic to paper-based packaging. That's why you might find a mix of paper and plastic in our boxes!

## **Nos nouveaux emballages vous emballeront !**

Nous passons des emballages en plastique aux emballages à base de papier. C'est pourquoi vous pourriez trouver un mélange de papier et de plastique dans nos boîtes !

## **¡Te presentamos nuestros nuevos empaques!**

Estamos sustituyendo las bolsas de plástico por bolsas con base de papel. ¡Por eso, puedes encontrar una mezcla de papel y de plástico en nuestras cajas!

**[LEGO.com/sustainable-packaging](https://www.lego.com/sustainable-packaging)**



# BUILDER



Apple and the Apple logo are trademarks of Apple Inc., registered in the U.S. and other countries and regions. App Store is a service mark of Apple Inc. Google Play and the Google Play logo are trademarks of Google LLC. Tencent and the Tencent logo are trademarks of Tencent Inc.

Q [LEGO.com/devicecheck](https://www.lego.com/devicecheck)

**EN** Ask parents' permission before going online | **DE** Eltern um Erlaubnis bitten, bevor du online gehst | **FR** Demande l'autorisation d'un parent avant d'aller en ligne | **IT** Chiedi il permesso ai tuoi genitori prima di andare online | **ES** Pídeles permiso a tus papás antes de conectarte a Internet | **PT** pede autorização aos pais antes de acederes online | **JA** オンラインになる前に ほかの方のきょかをもらおう | **ZH** 上网前应先征得父母的同意 | **KO** 온라인 접속 전에 보호자 동의가 필요합니다 | **RU** Спроси разрешения у родителей, прежде чем заходить в интернет | **PL** Poproś rodziców o zgodę, zanim wejdiesz do Internetu | **CS** Než půjdeš na internet, požádej rodiče o svolení | **SK** Skôr než pôjdeš na internet, vypýtaj si povolenie od rodičov | **HU** Kérj szülői engedélyt, mielőtt online csatlakoznál! | **RO** Cere permisiunea părinților înainte de a te conecta online | **BG** Попискайте разрешение от родител, преди да влезете онлайн | **LV** Pirms došanās tiešsaistē palūdz atļauju vecākiem | **ET** Enne Interneti kasutamist küsi vanematelt luba | **LT** Prieš prisijungdami prie interneto, atsiklauskite tėvų



## AVERTISSEMENT : RISQUE D'ÉTOUFFEMENT.

Contient des petites pièces. Ne convient pas aux enfants de moins de 3 ans.



## ADVERTENCIA: PELIGRO DE ASFIXIA.

No recomendado para niños menores de 3 años. Contiene piezas pequeñas.



1

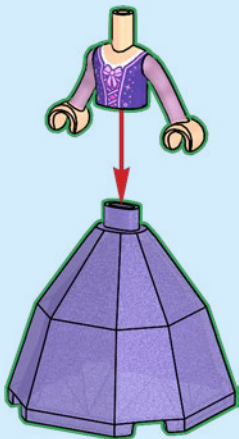

2

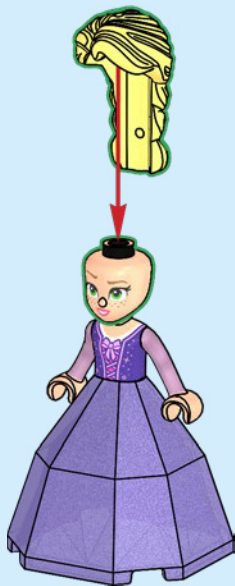

3



4

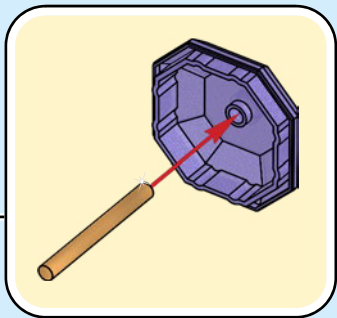

1

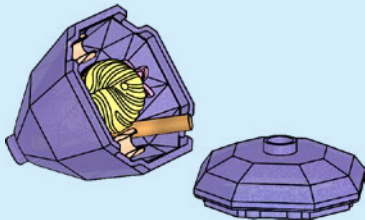

2

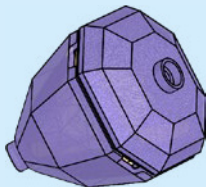



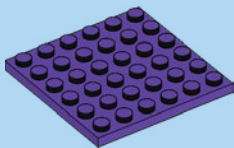
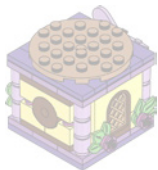

1

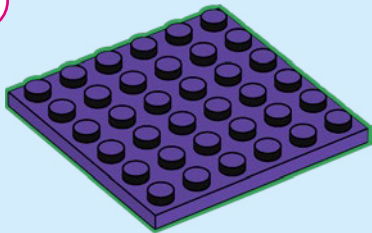



2

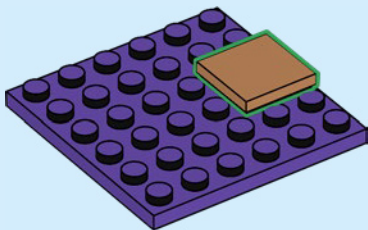

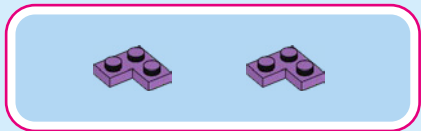

3

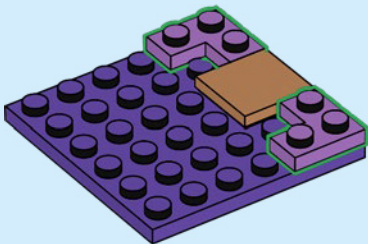

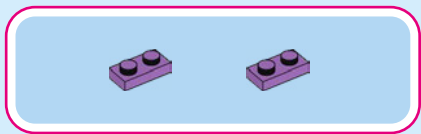

4

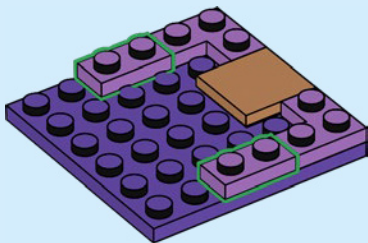

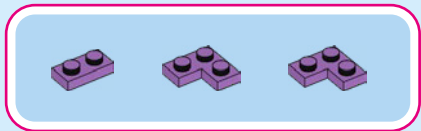

5

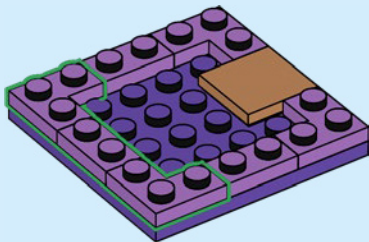



6

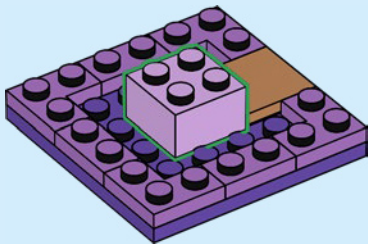



7

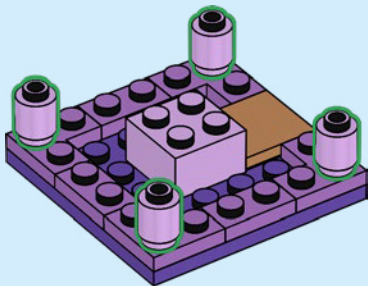

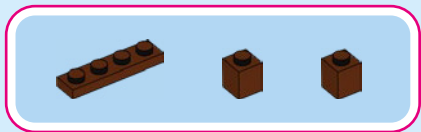

8

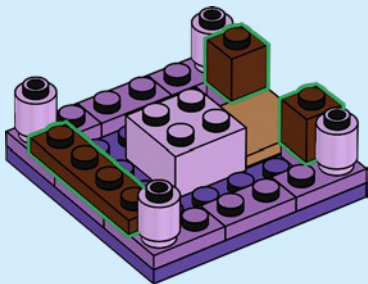



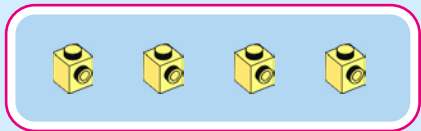

9

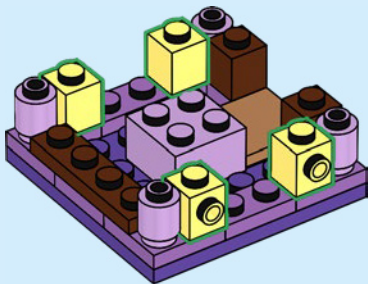

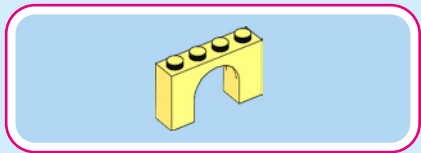

10

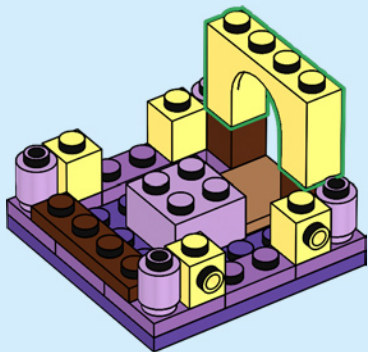



11

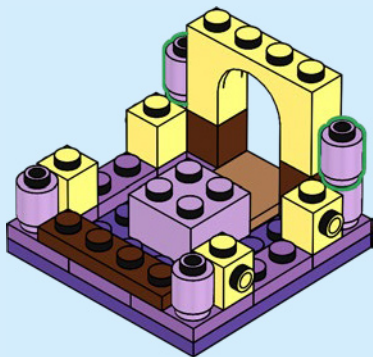



12

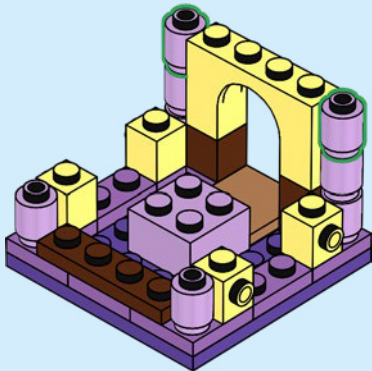



13

1

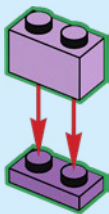

2

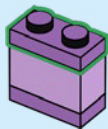

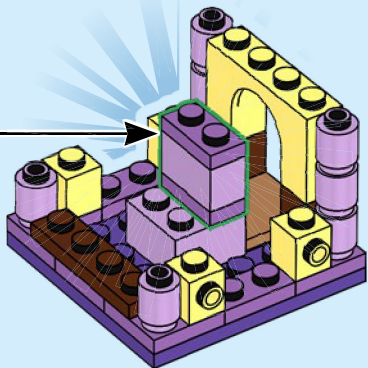

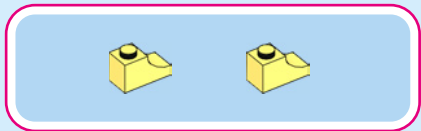

14

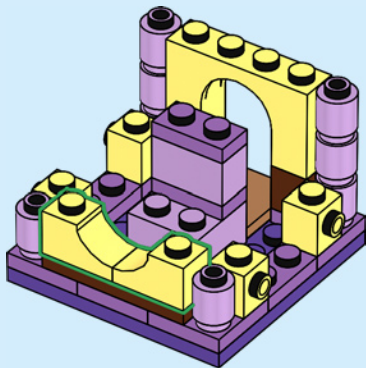



15

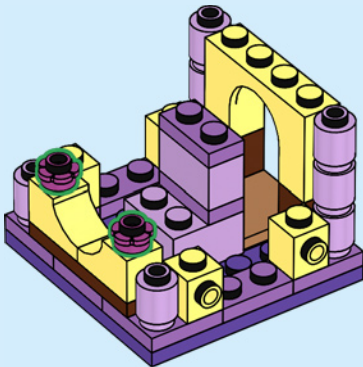





16





17

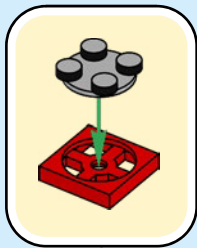



18





19

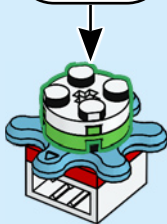
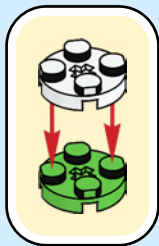



20



21

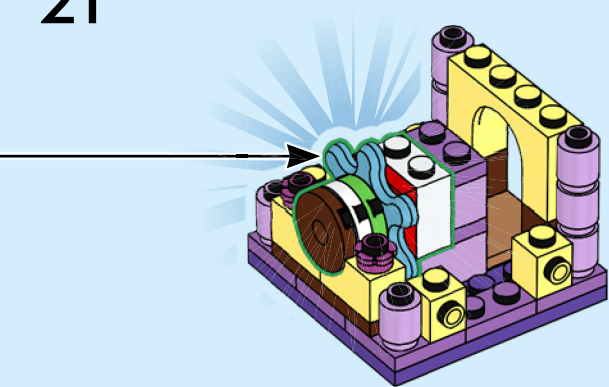



22

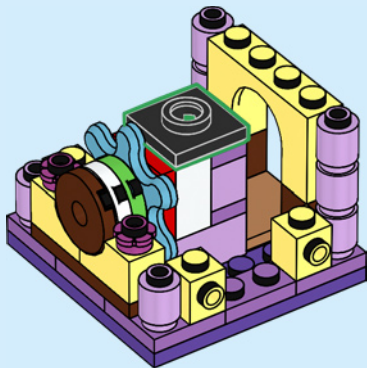



23





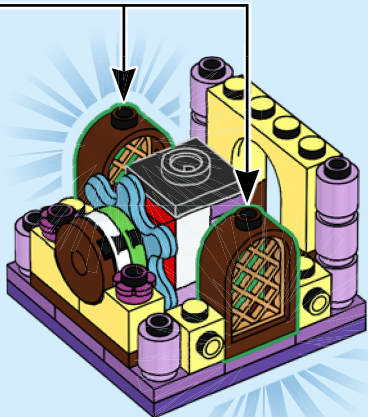

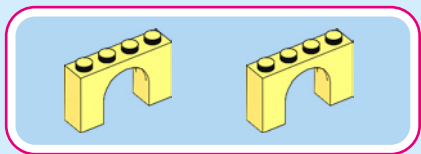

24

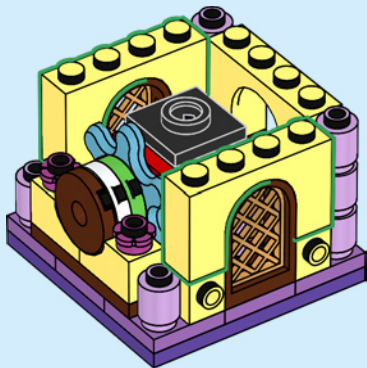



25

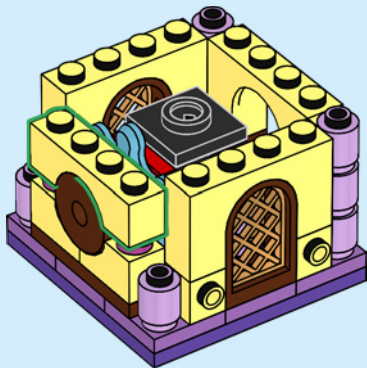



26

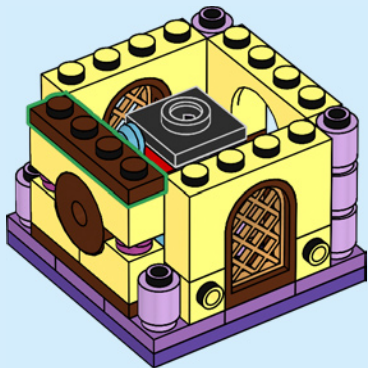



27

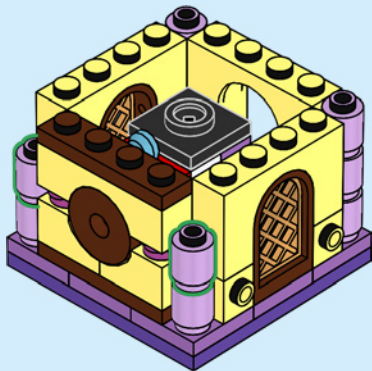



28

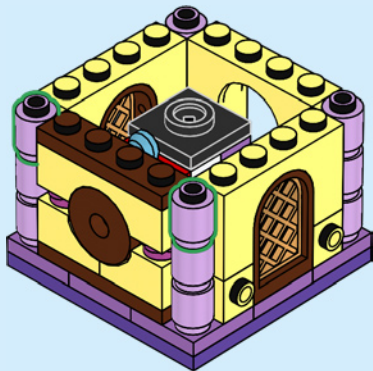



29

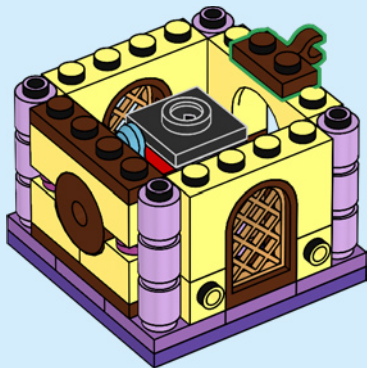



30

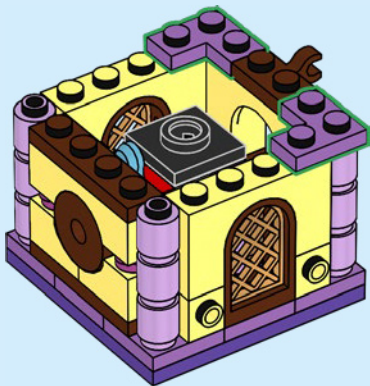



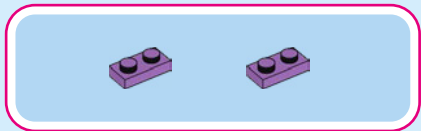

31

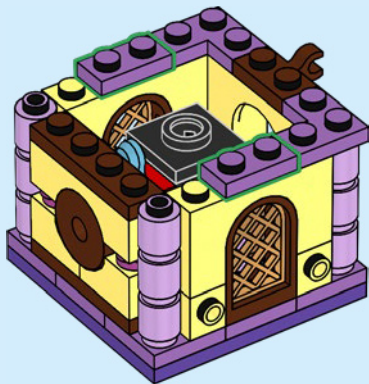

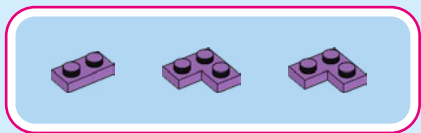

32

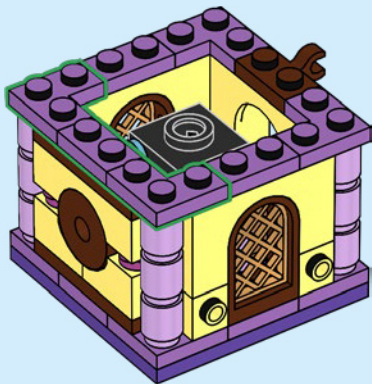



33

1



2



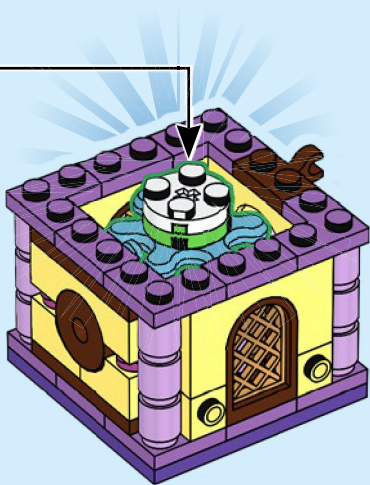



34

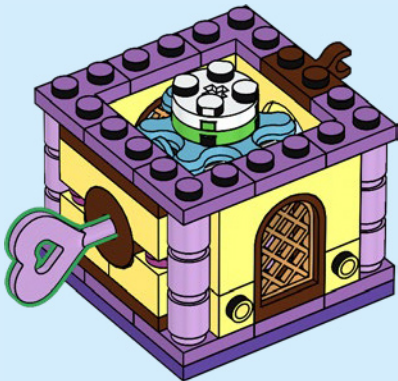

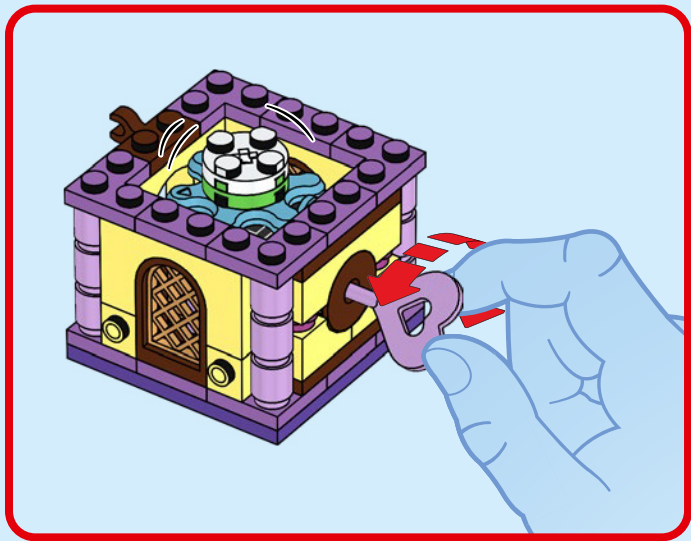

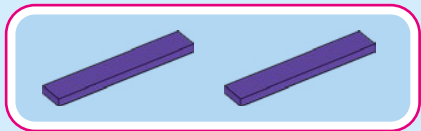

35

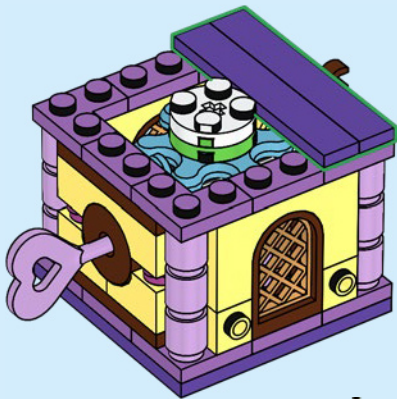

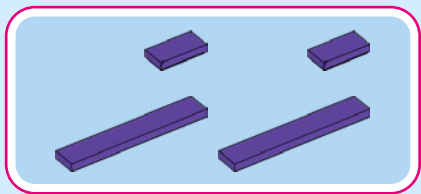

36

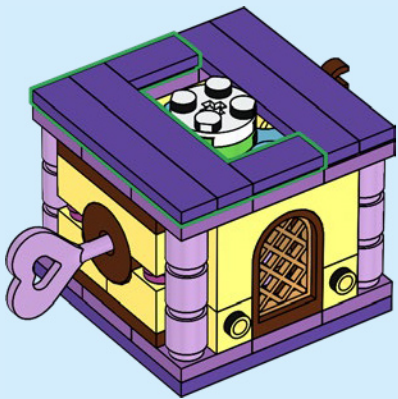



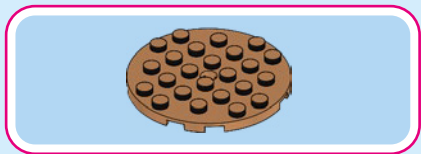

37

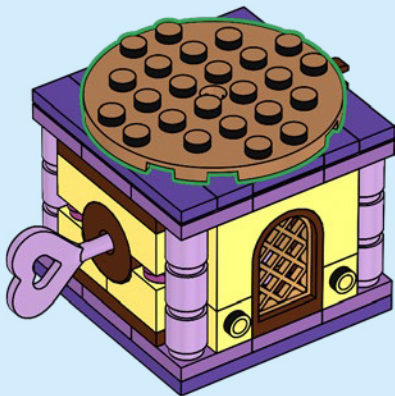



38

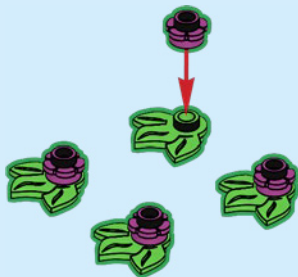

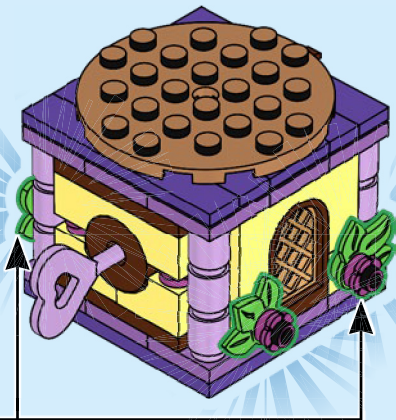
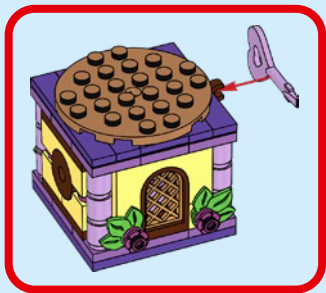

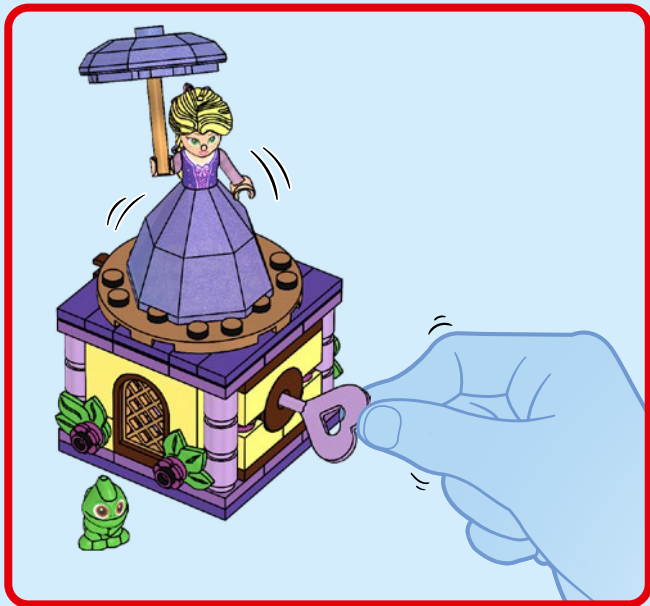



# Disney PRINCESS

43216



©Disney

43210



LEGO.com/disney



43214



43211

4+



2x  
403201



1x  
6218823



1x  
368021



1x  
6310981



1x  
6331061



4x  
6182261



2x  
6138624



2x  
4211242



2x  
4211190



1x  
6092568



2x  
4542131



1x  
6313124



1x  
4540203



4x  
6420726



1x  
6416303



2x  
6380628



1x  
6250076



12x  
6209673



3x  
6102580



6x  
6209682



1x  
6422040



1x  
6437468



2x  
6271207



2x  
6173106



1x  
6147169



12x  
6209673



1x  
6385583



1x  
6099352



1x  
6099349



1x  
6376537



1x  
6376544



8x  
4619512



8x  
4619517



1x  
6102990



1x  
6345302



2x  
4613192



4x  
4619657



1x  
6426669



2x  
6096990



LEGO.com/service

YOU COULD

WIN



Scan this QR code or go to  
**LEGO.COM/PRODUCTFEEDBACK**  
and give us your short feedback  
about this LEGO® set for a chance to  
win a cool LEGO prize.

Terms and Conditions apply\*

**DE: Du könntest GEWINNEN.** Es gelten die Teilnahmebedingungen\* **FR: Tu pourrais GAGNER.** Des conditions s'appliquent\* **IT: Potresti VINCERE tu.** Termini e condizioni sono applicabili\* **ES: Puedes GANAR.** Aplican términos y condiciones\* **PT: Poderá GANHAR.** Aplicam-se termos e condições\* **JA: プレゼント付き! 利用規約が適用されます\*** 轻松获奖. 条款和条件适用\* **KO: 상품의 주인이 되어보세요. 소정의 약관이 적용됩니다\*** **RU: Вы можете ВЫИГРАТЬ.** Действуют положения и условия\* **PL: Szansa na WYGRANĄ.** Obowiązują warunki korzystania\* **CS: Máte šanci VYHRÁT.** Platí všeobecné smluvní podmínky\* **SK: Máte šancu VYHRAŤ.** Platia všeobecné zmluvné podmienky\* **HU: TE IS NYERHETSZ.** Felhasználási feltételek érvényesek\* **RO: Ai putea CÂȘTIGA.** Se aplică termenii și condiții\* **BG: Можете да СПЕЧЕЛИТЕ.** Има определени правила и условия\* **LV: Tu vari LAIMĒT.** Ir spēkā noteikumi un nosacījumi.\* **ET: Sul on võimalus VÕITA.** Kehtivad tingimused\* **LT: Jūs galite LAIMĖTI.** Taikomos sąlygos\*

\*[LEGO.com/productfeedback-terms](https://www.lego.com/productfeedback-terms)

LEGO and the LEGO logo are trademarks of the/son des marques de commerce du/  
son marcas registradas de LEGO Group. ©2023 The LEGO Group.  
©Disney

6448815