

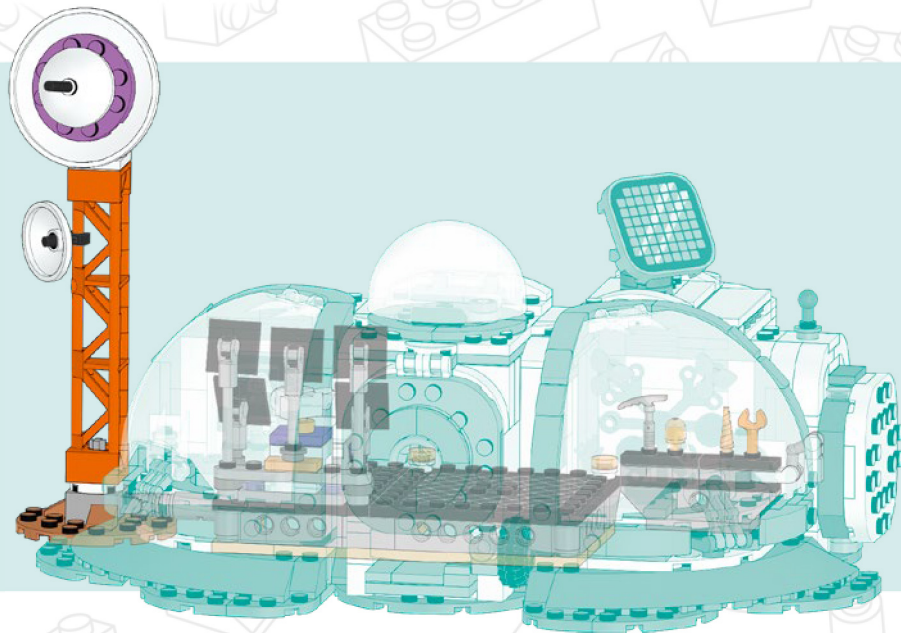

Friends™

42605

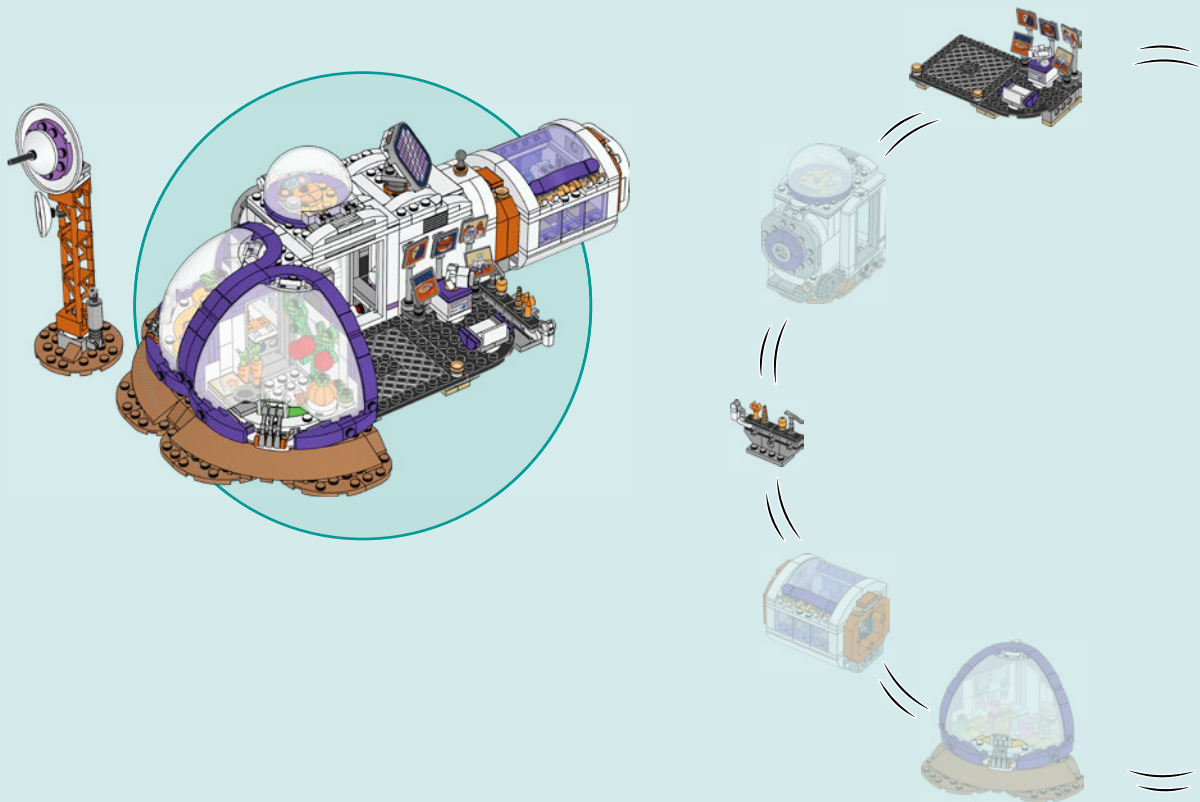







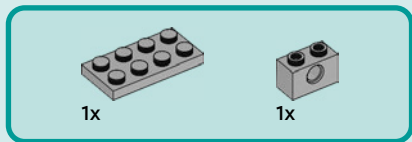
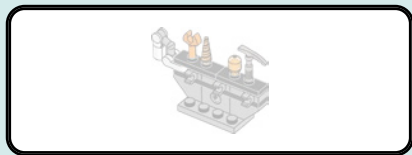

1

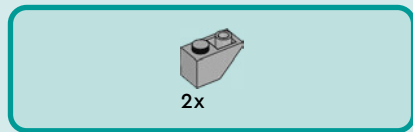
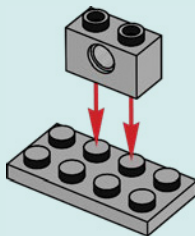

2

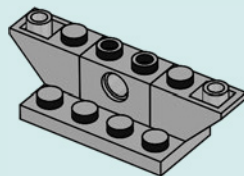



1x

3

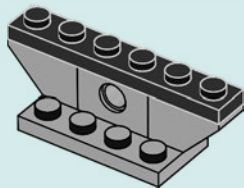

1x

4

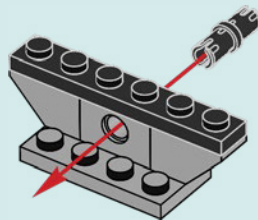



1x

5

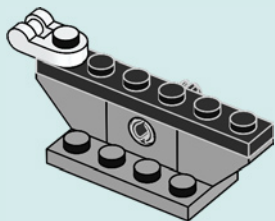

2x



3x

6

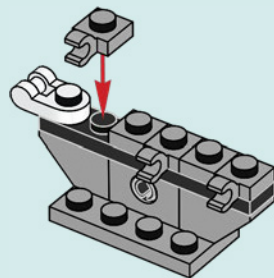



2x

7

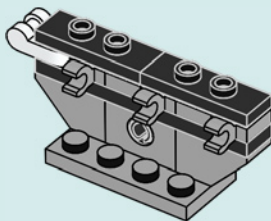

8





1x



1x

8

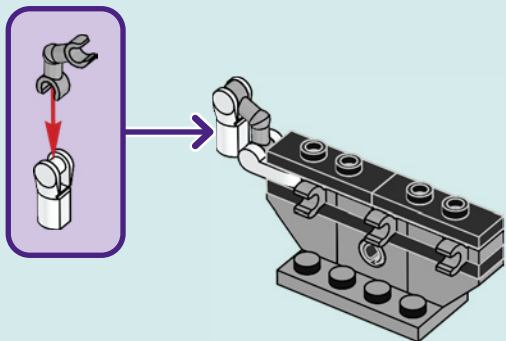

1x



1x



1x



1x

9

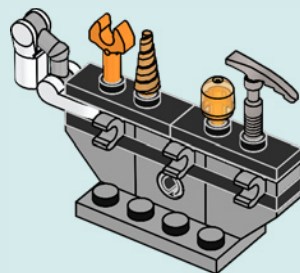

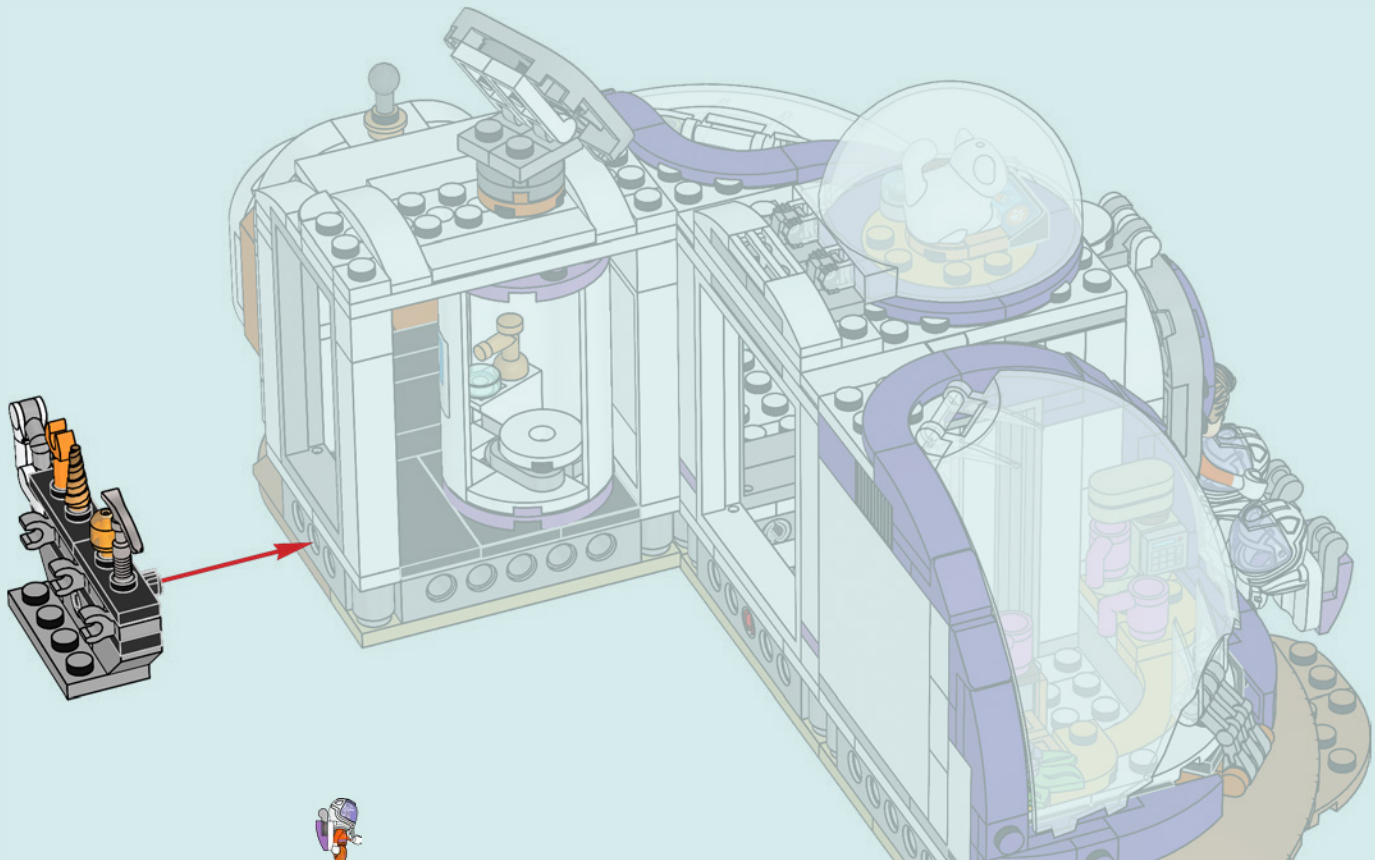

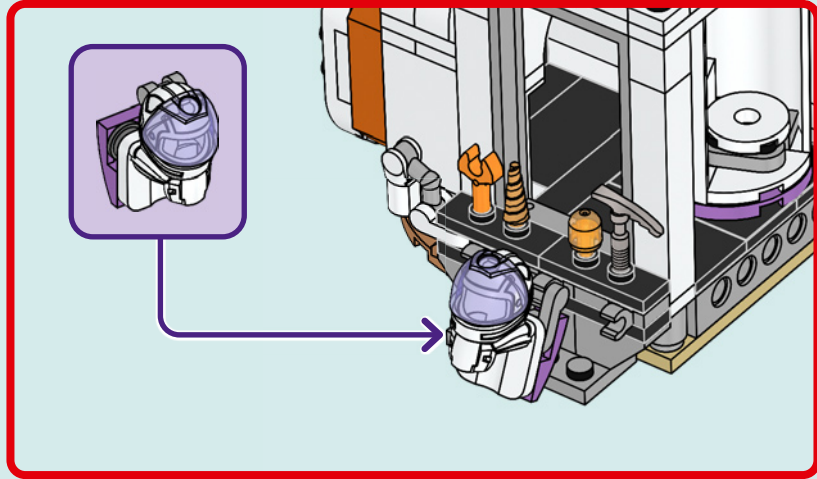

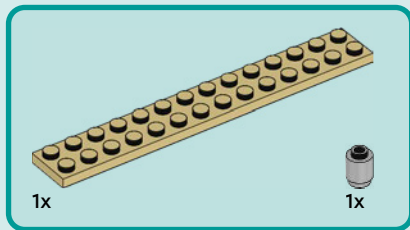
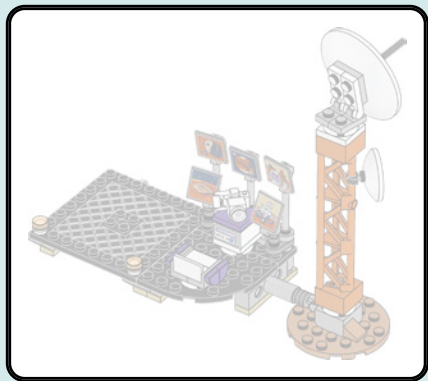

1

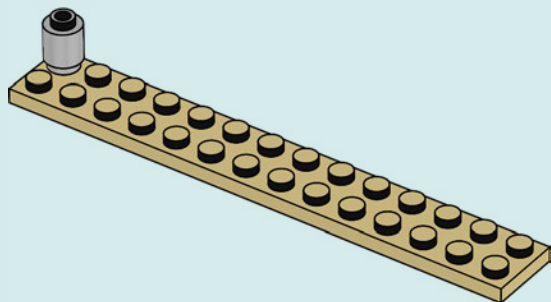

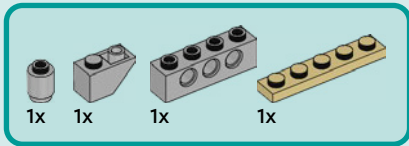

2

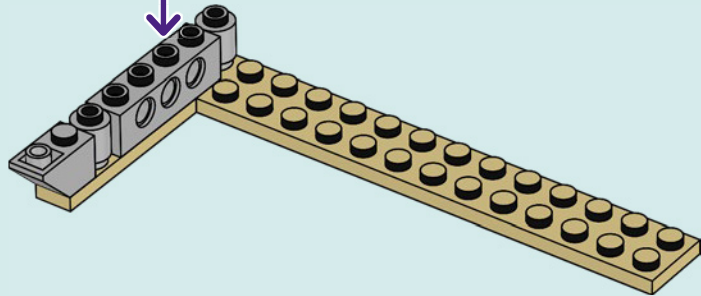
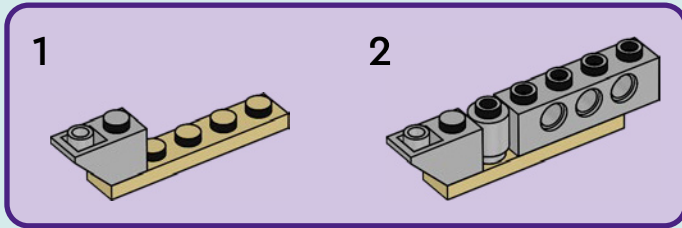



1x

3

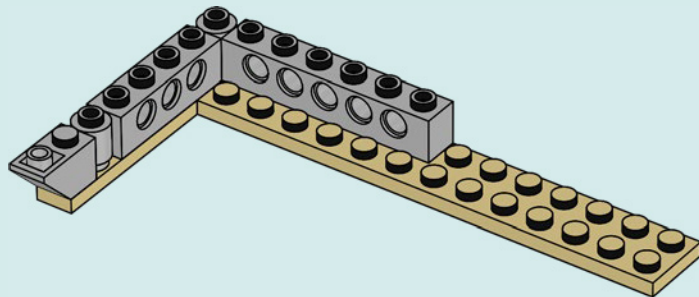

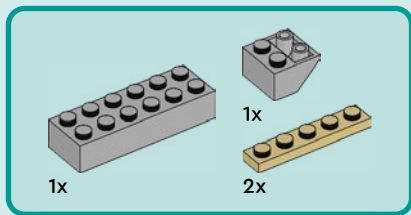

4

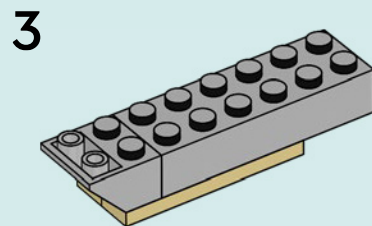
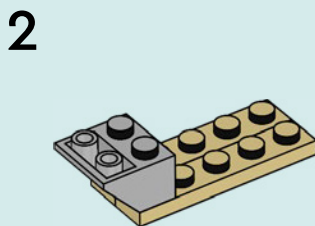
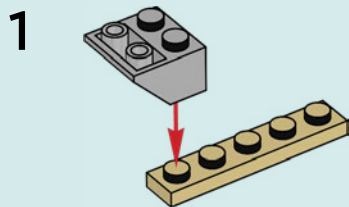

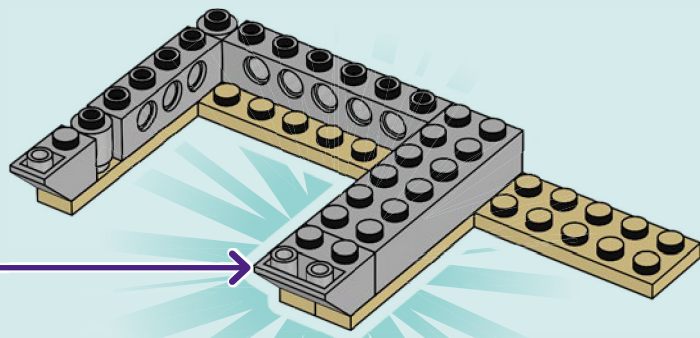

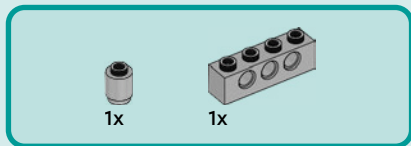

5

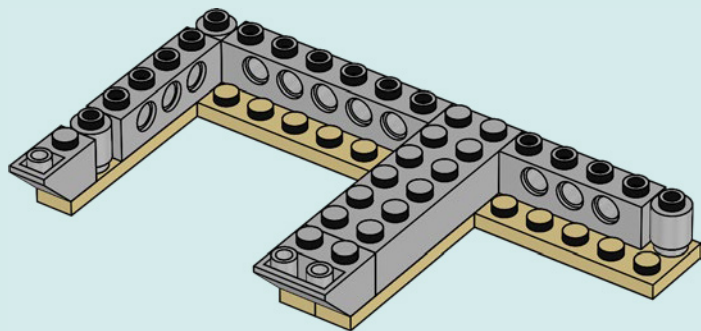

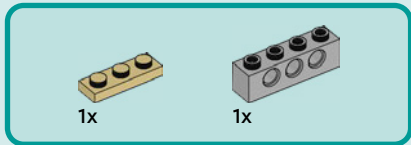

6

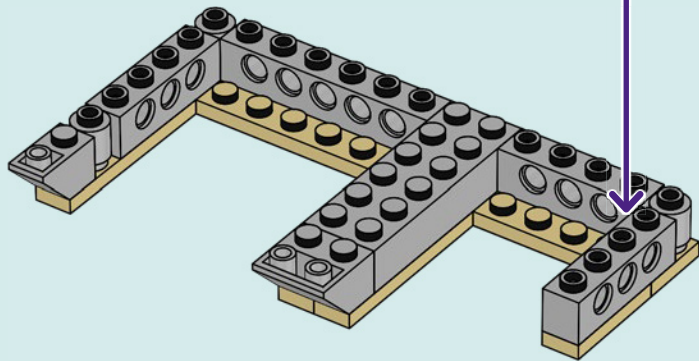
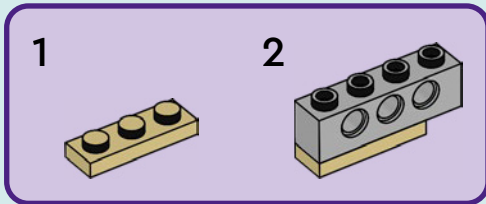



2x

7

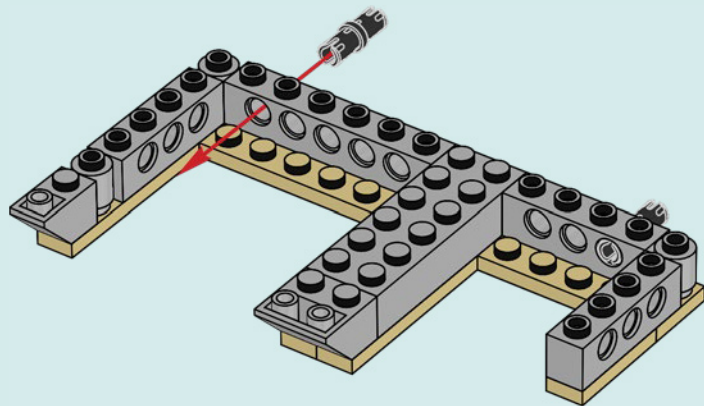

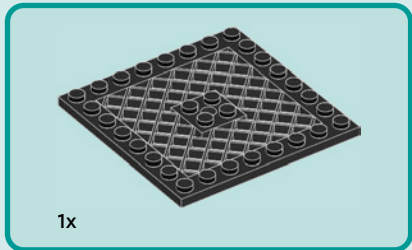

8

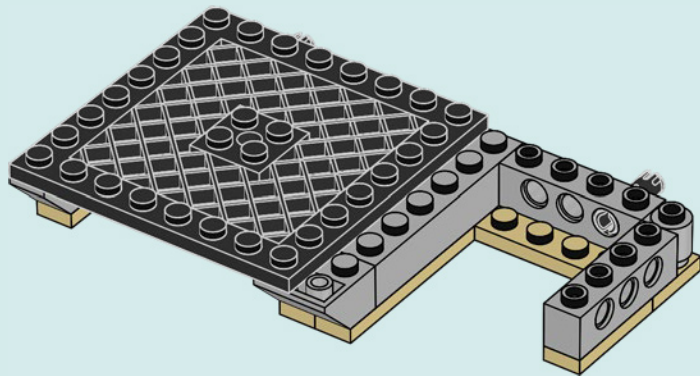

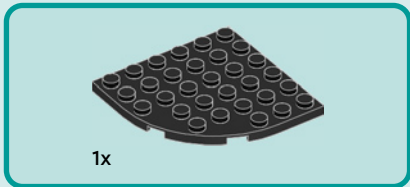

9

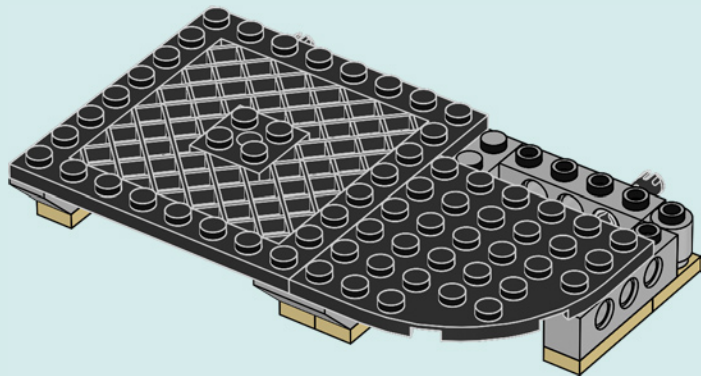

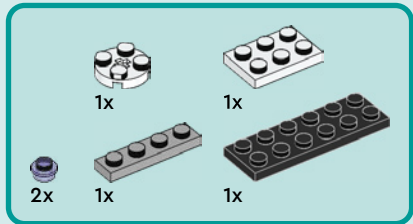

10

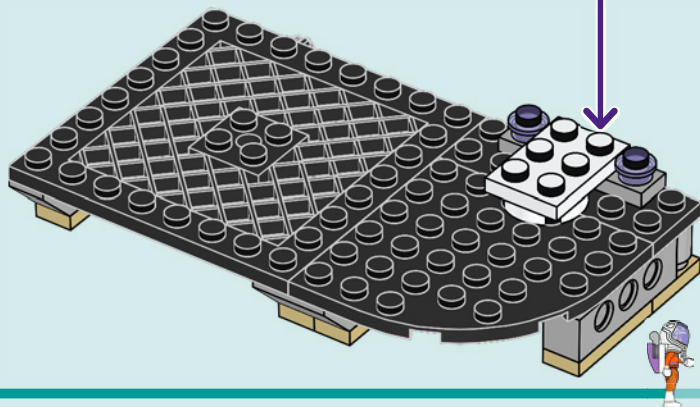
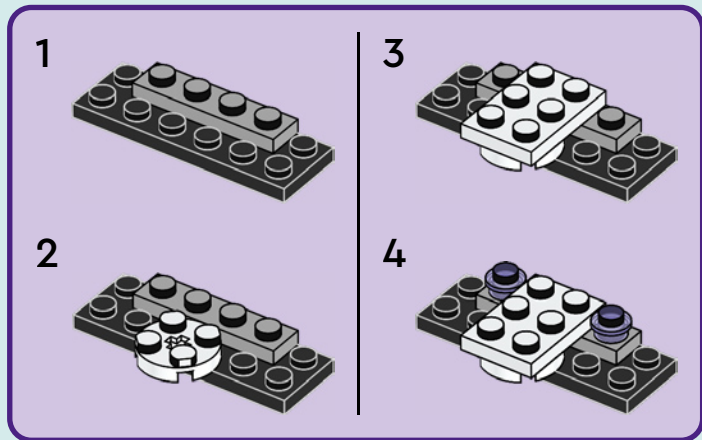

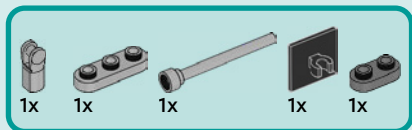

11

1



2

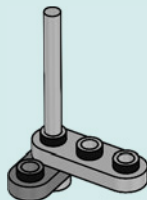

3

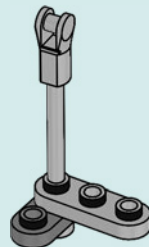

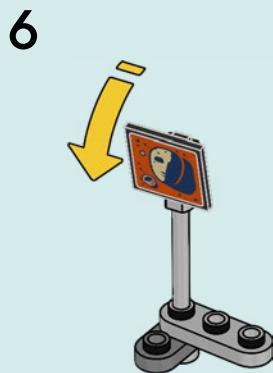
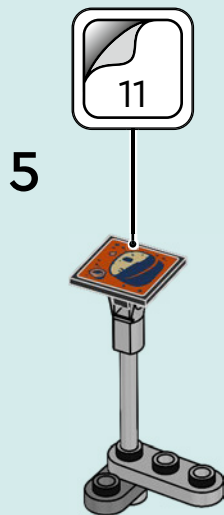
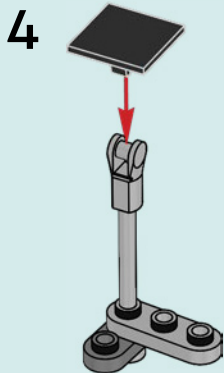

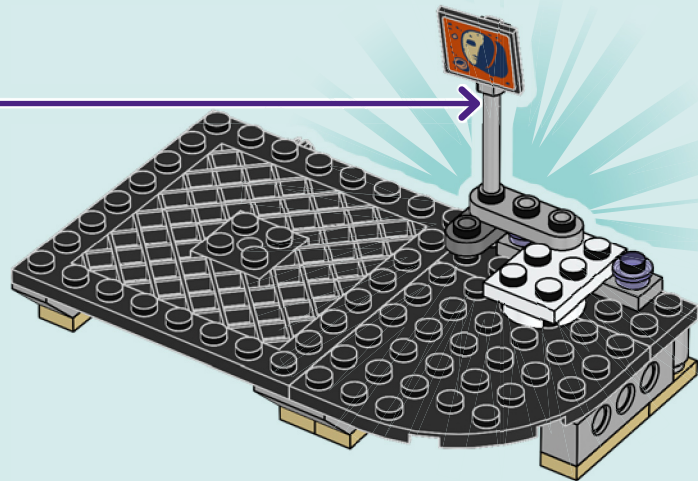

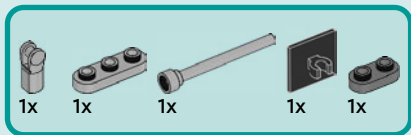

12

1

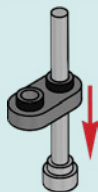

2



3

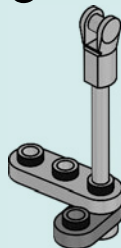

4

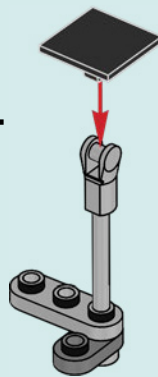

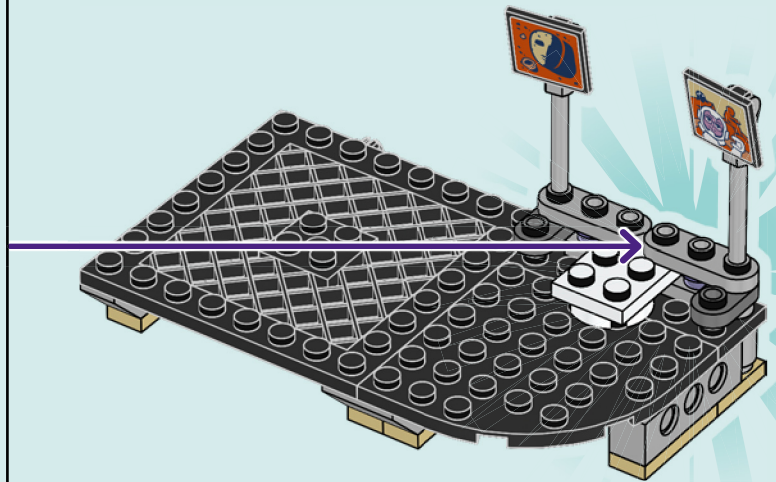
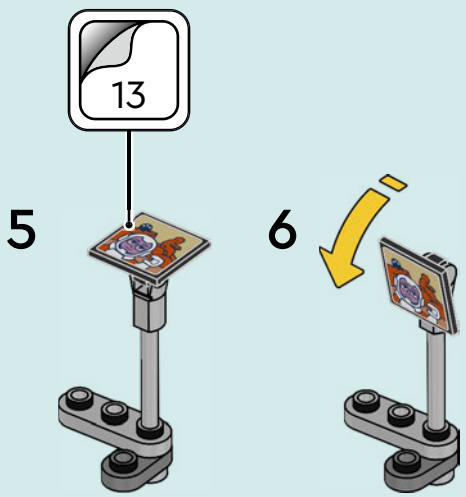

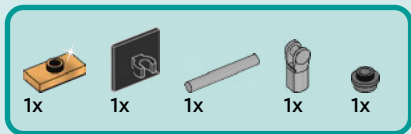

13

1

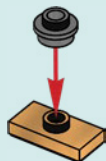

2

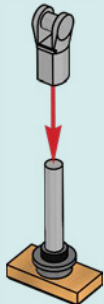

3

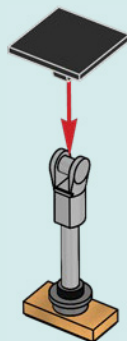

4



5

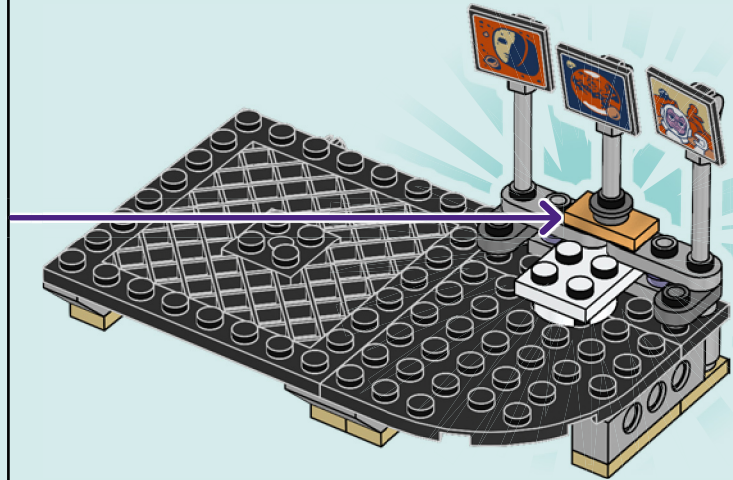

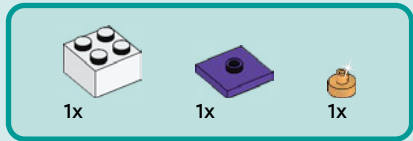

14

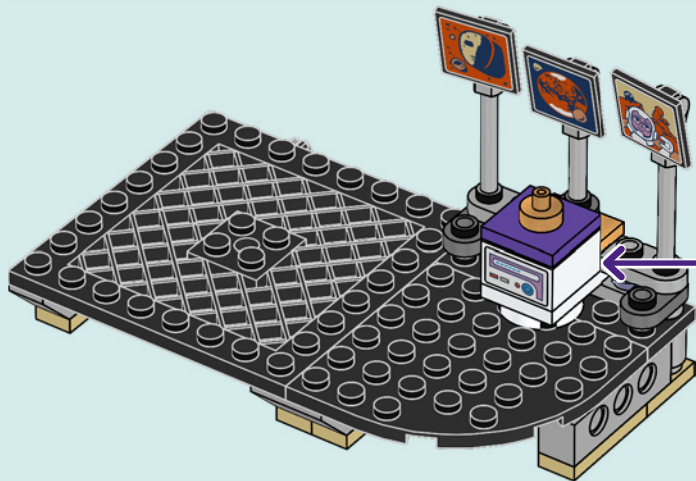
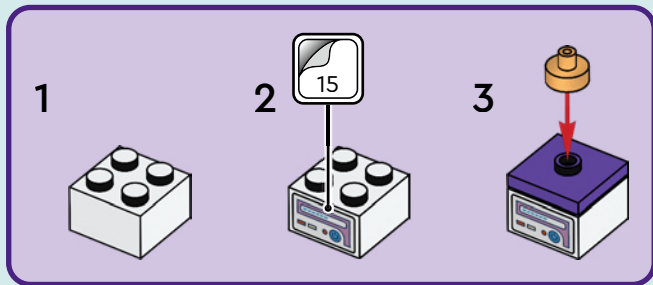

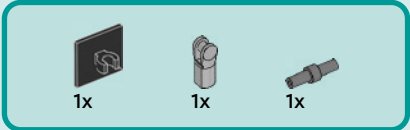

15

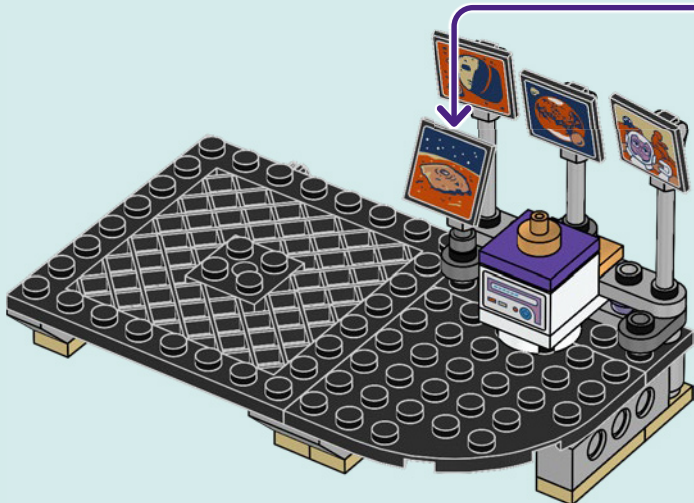
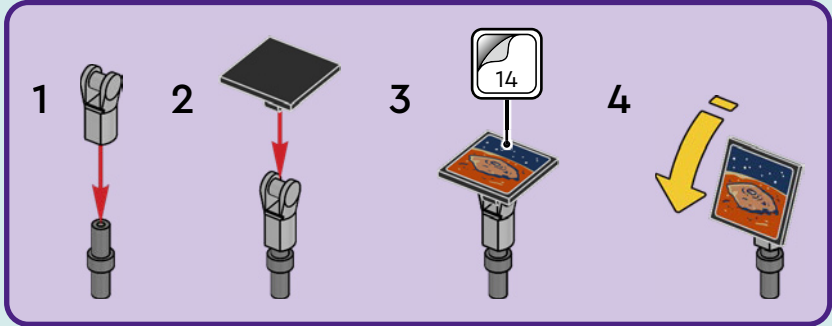

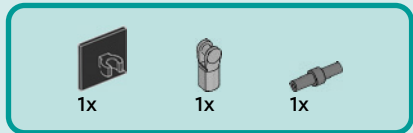

16

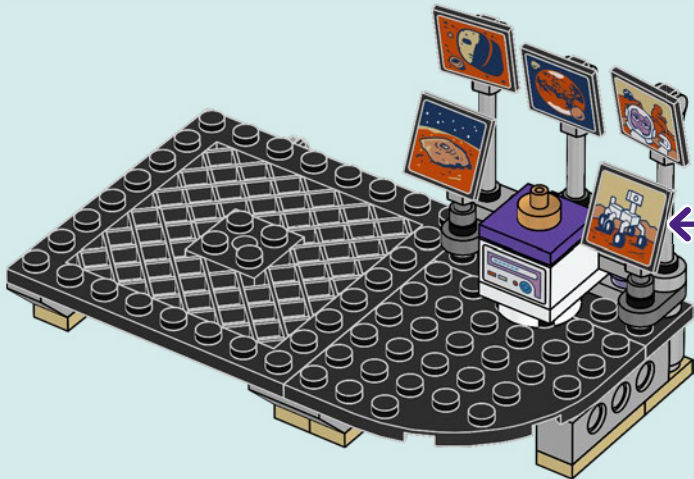
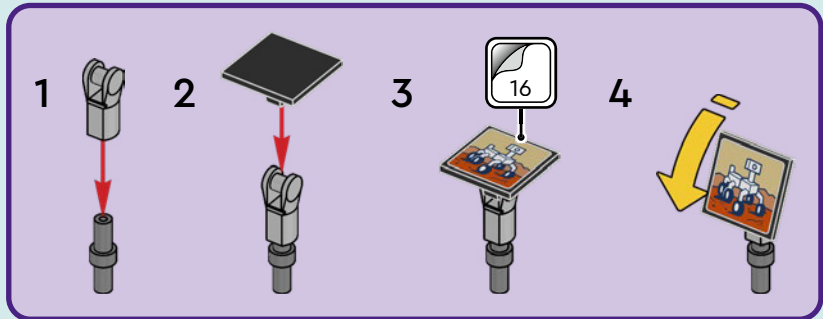

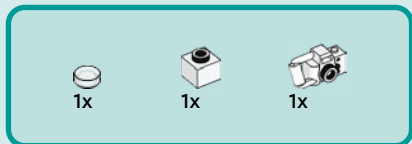

17

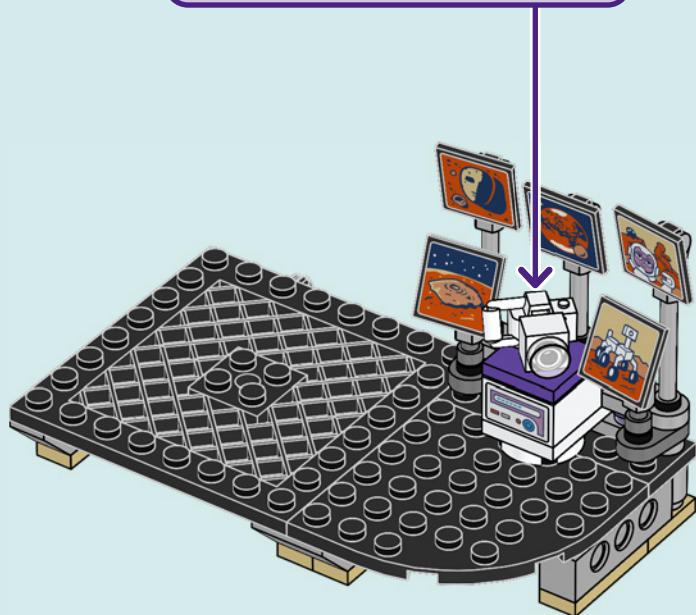
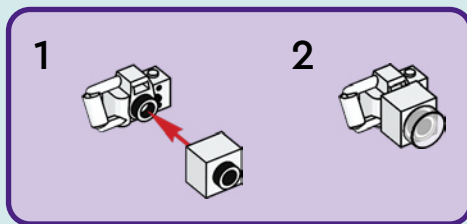

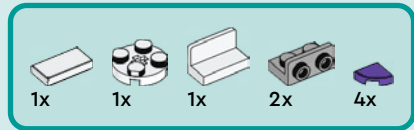

18

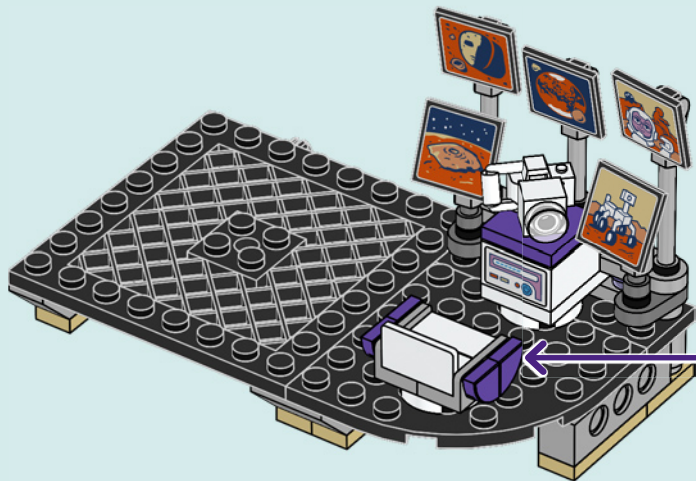
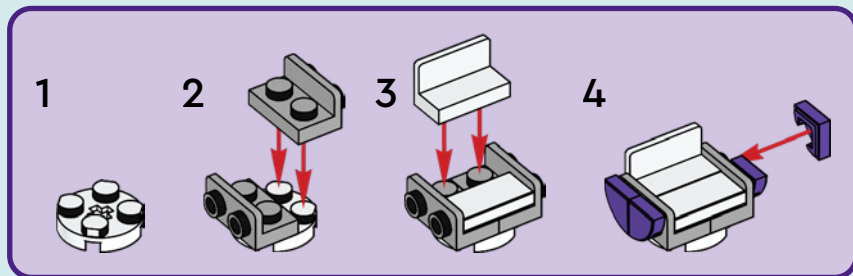



2x



2x

19

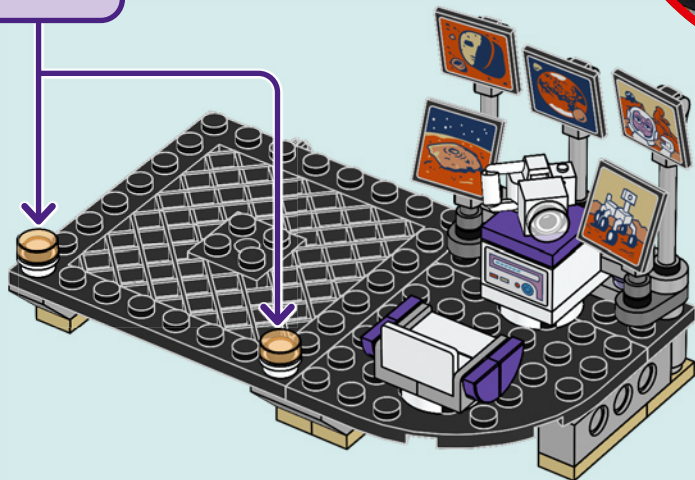
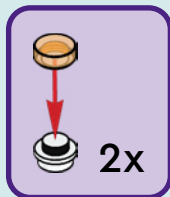

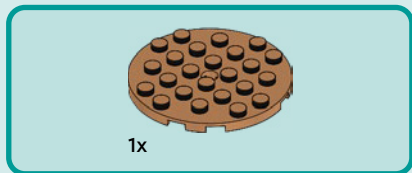
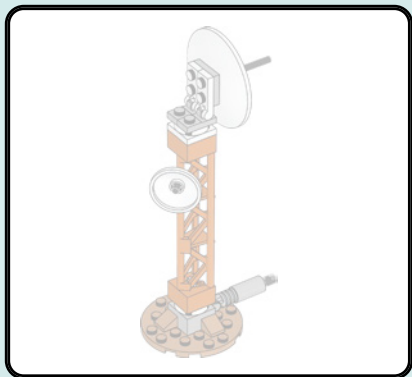

20





1x

21

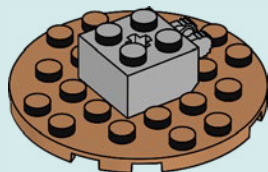

2x

22

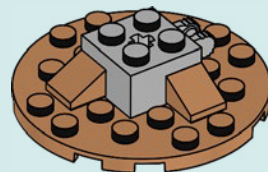

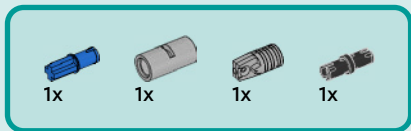

23

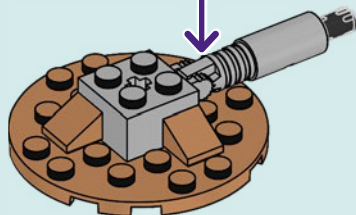
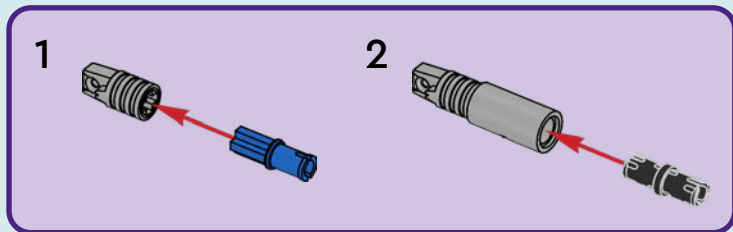



1x

24

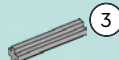
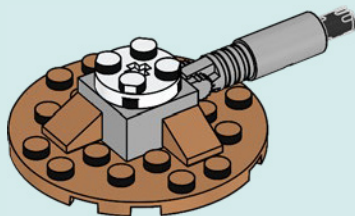

1x

25

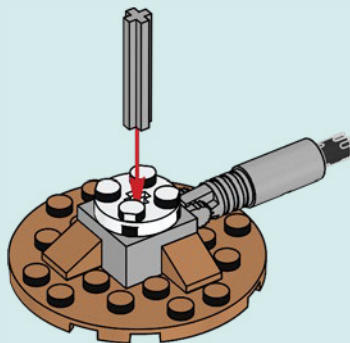

3

1:1

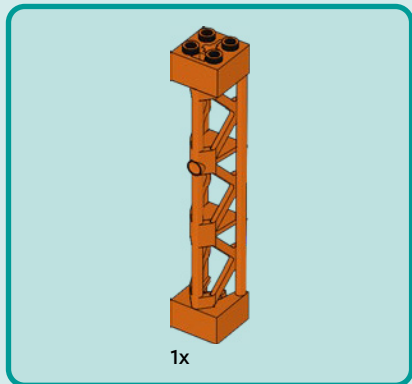

26

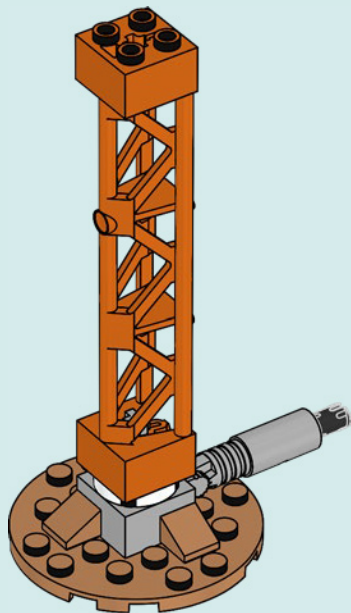



1x



1x

27

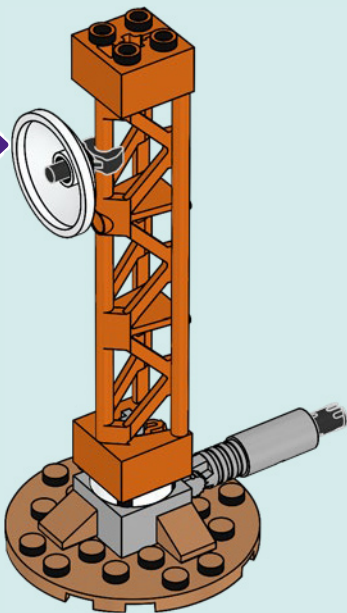
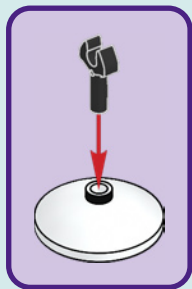



1x



1x

28

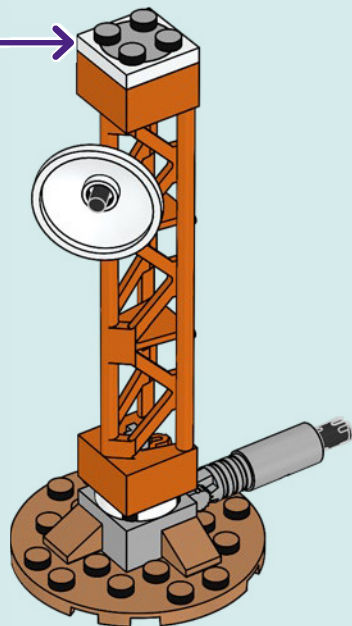
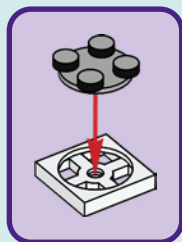



1x



2x

29

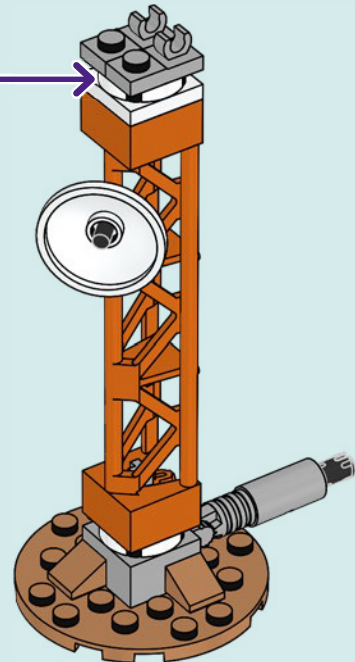
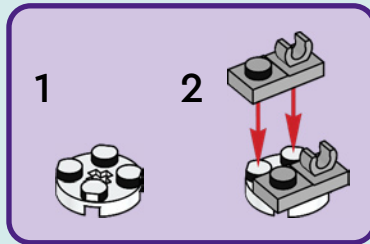

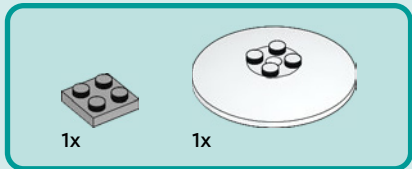
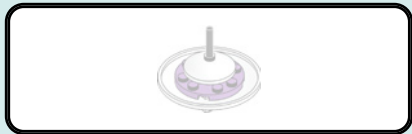

30

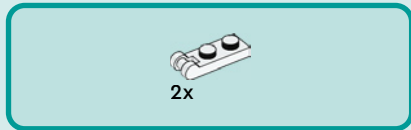
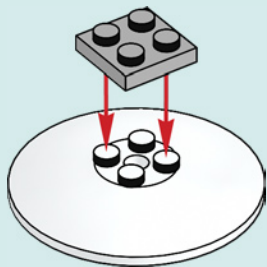

31

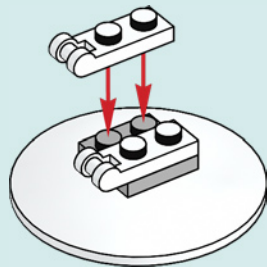

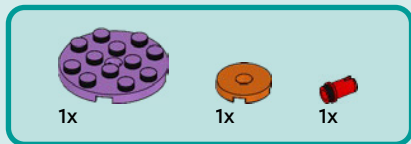

32

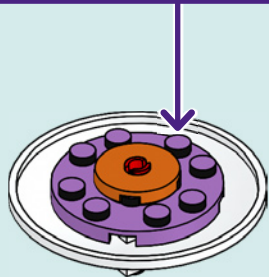
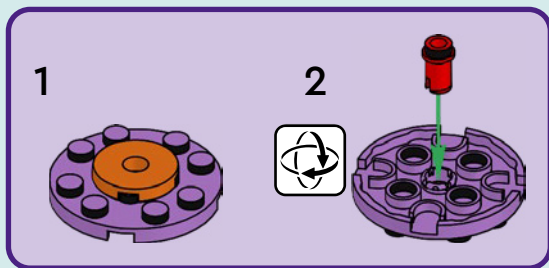

33

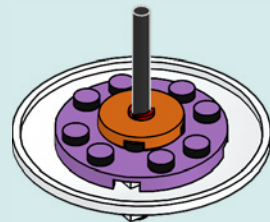



1x

34

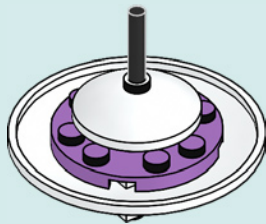

35

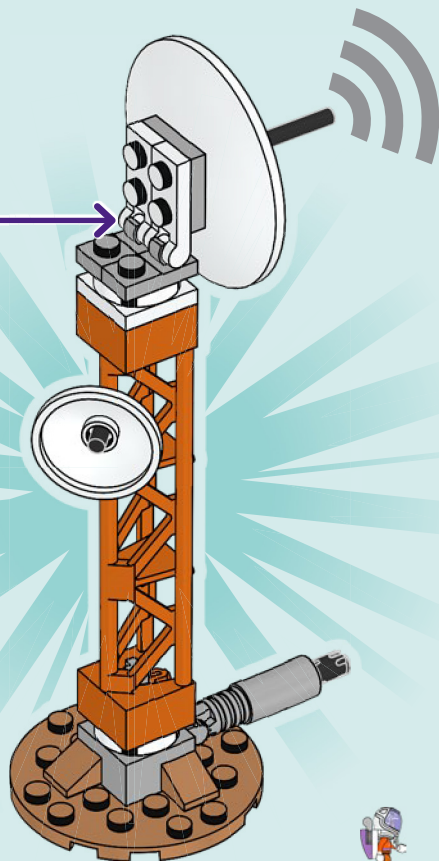

36

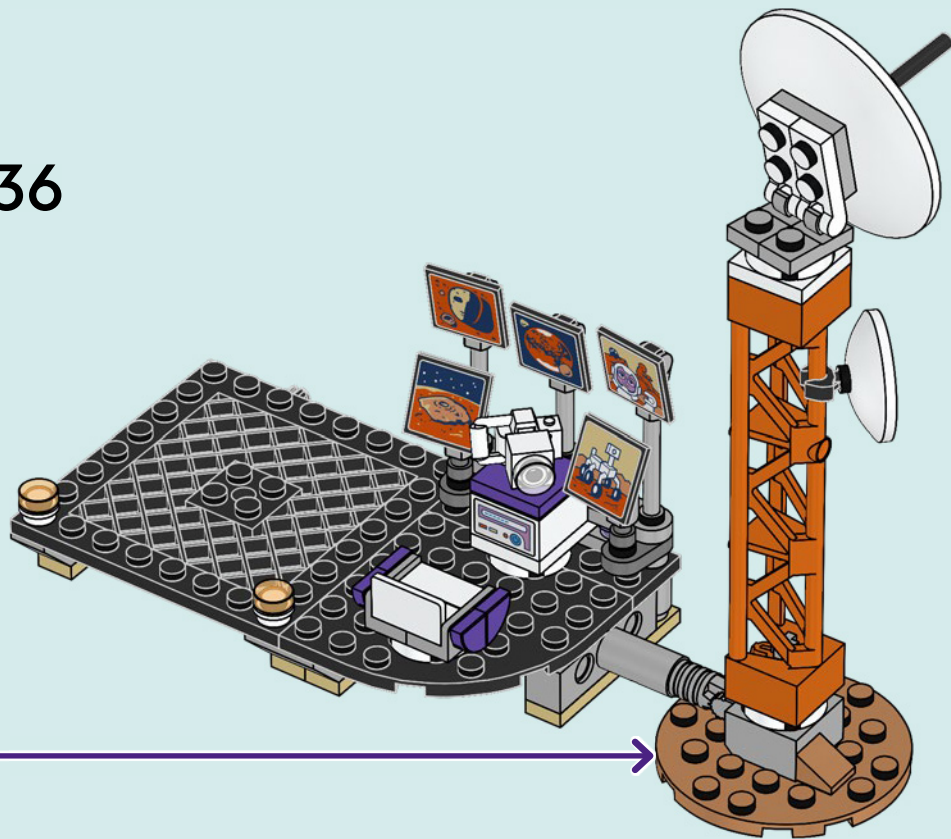

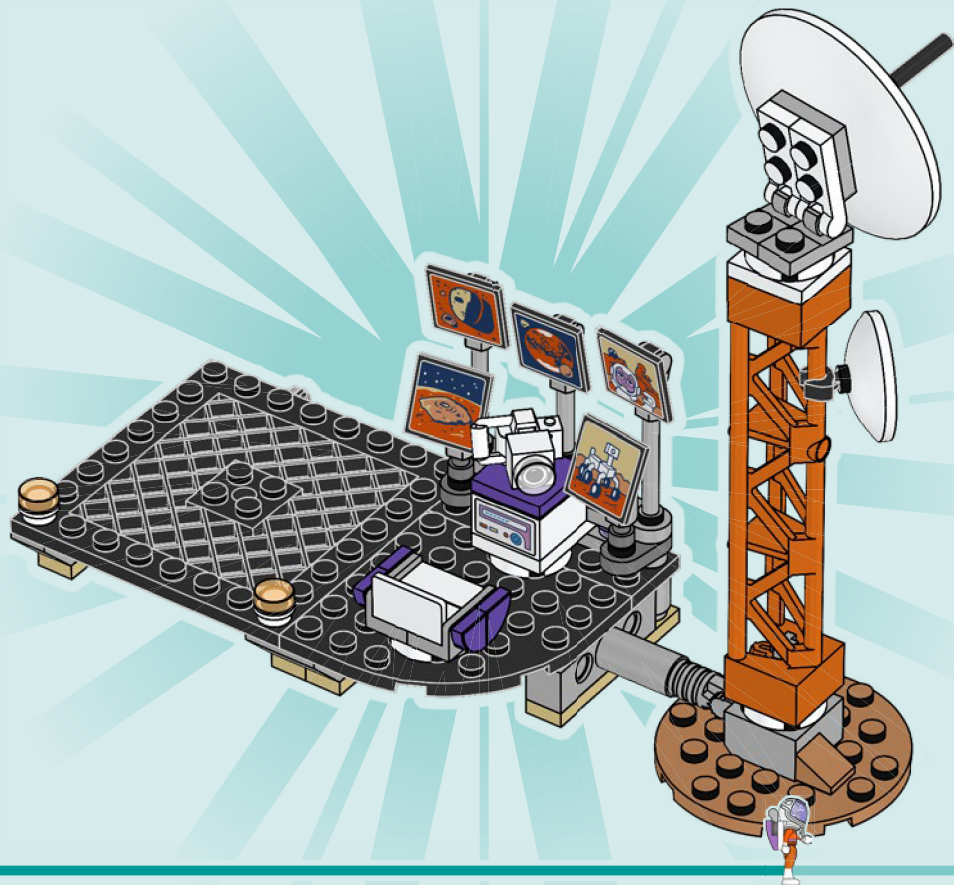

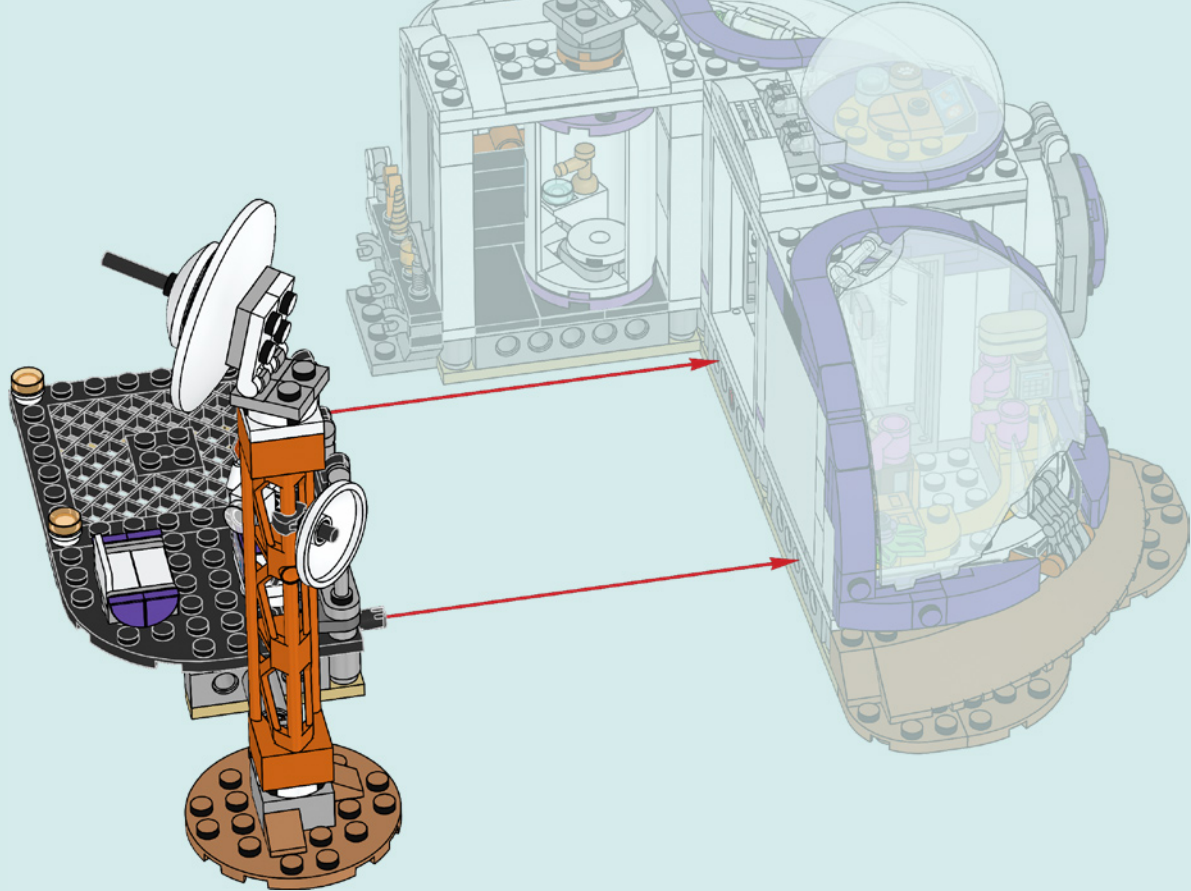

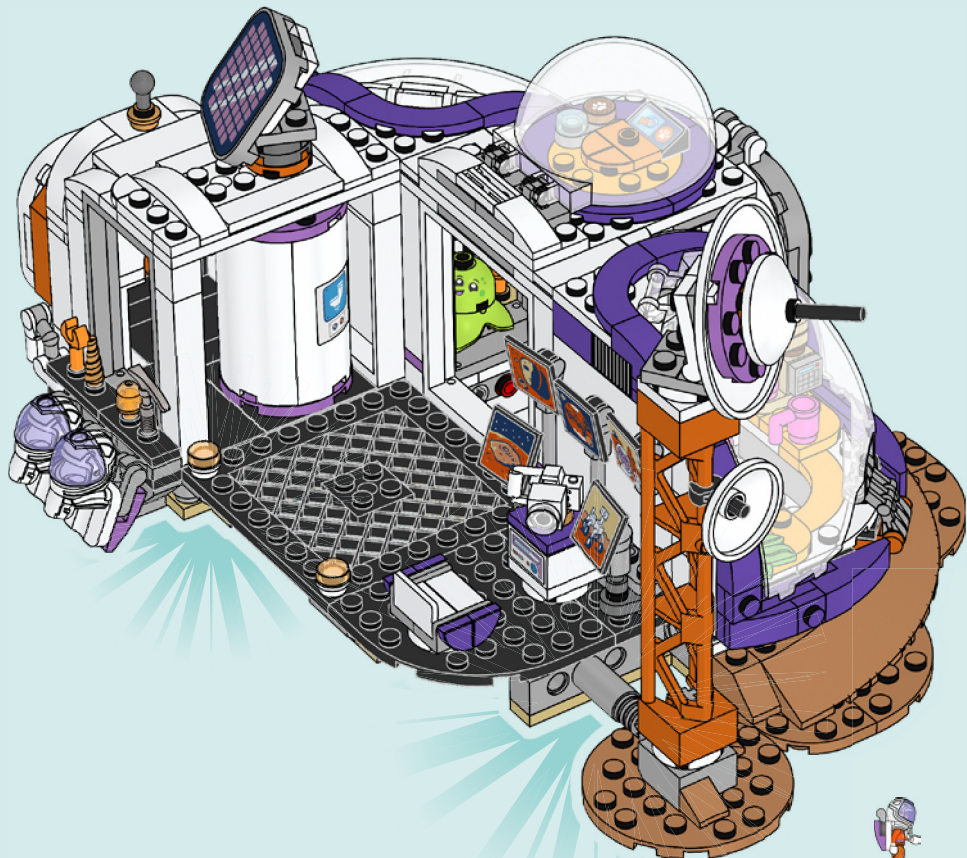

1



2

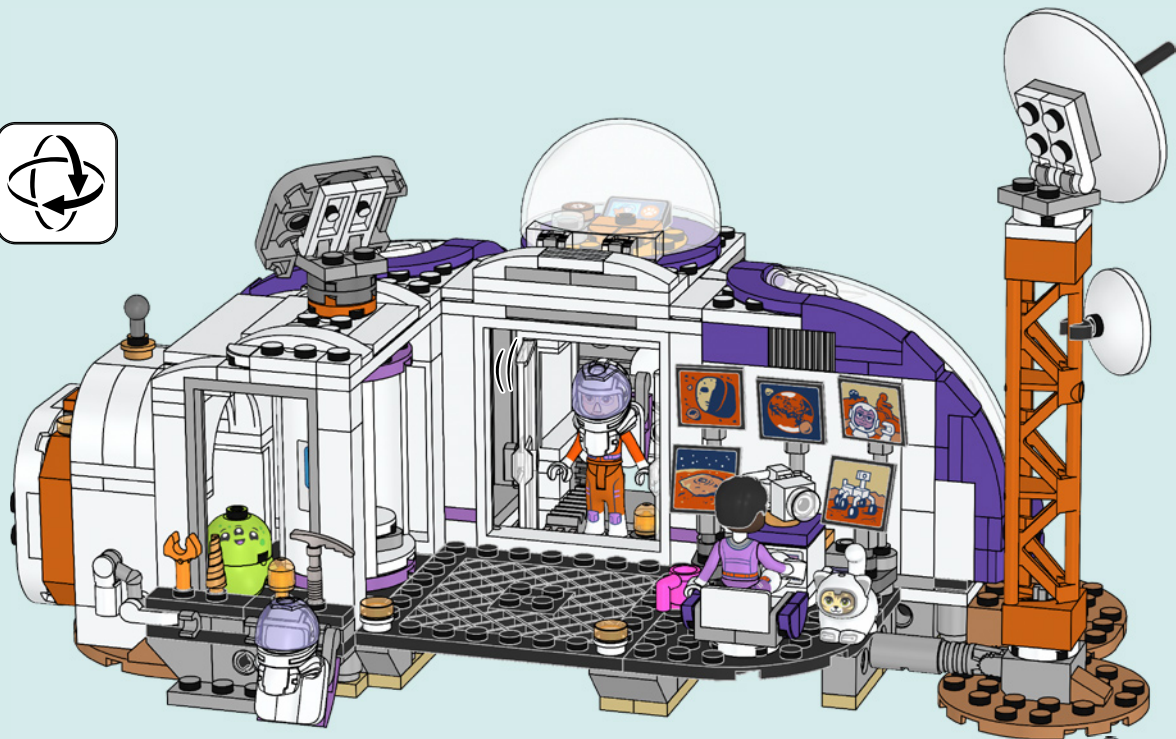



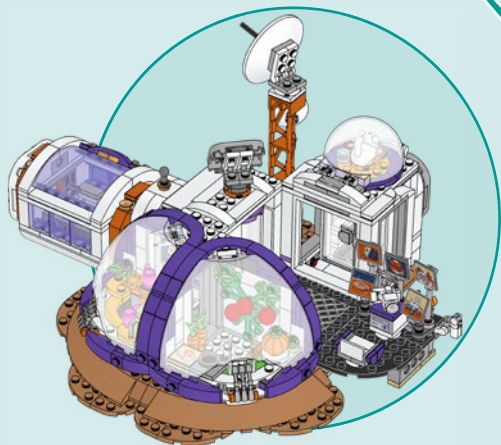
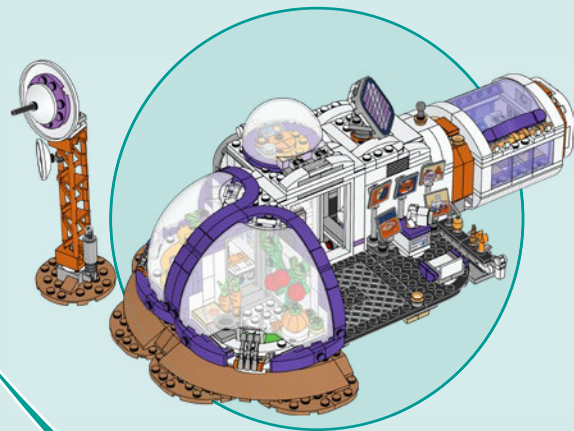
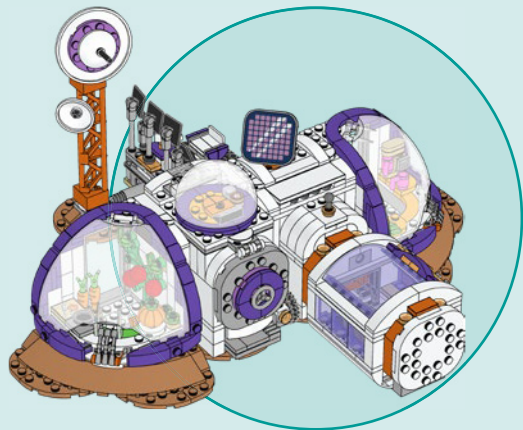

1

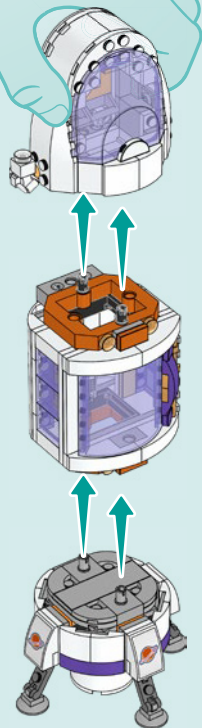

2

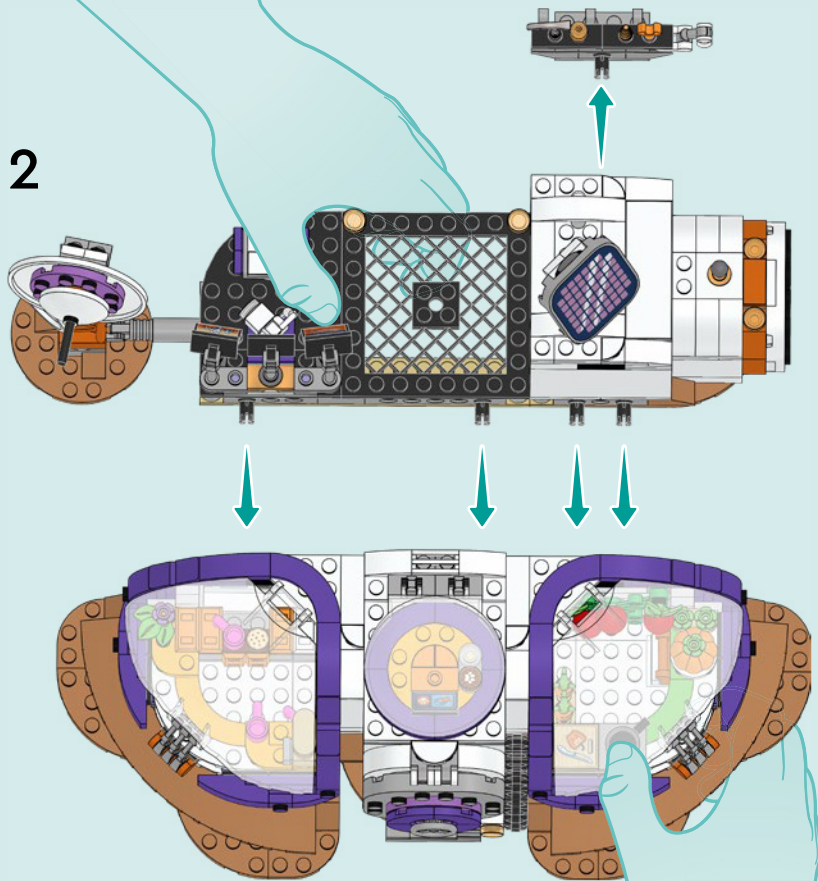

3

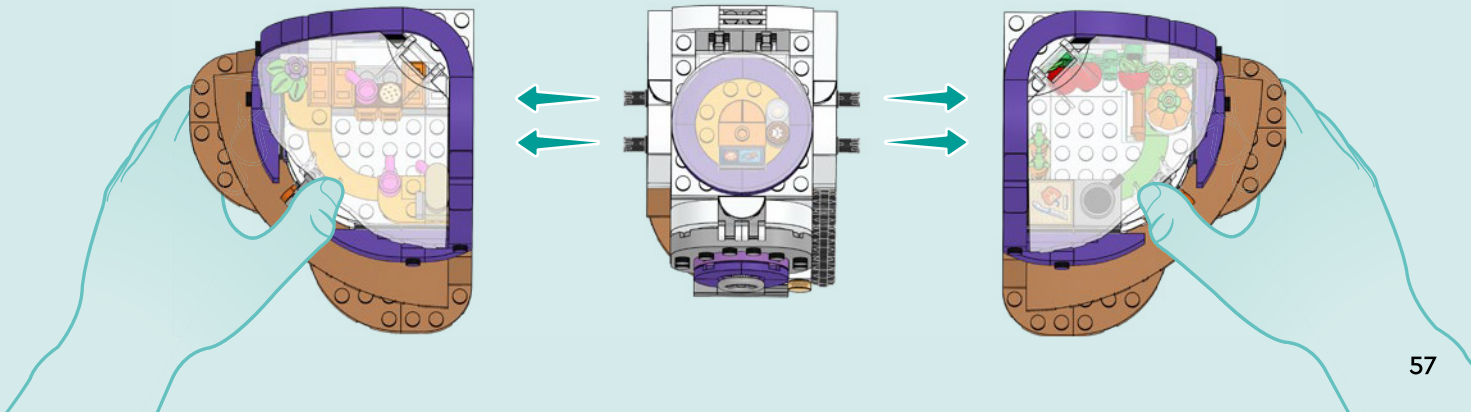
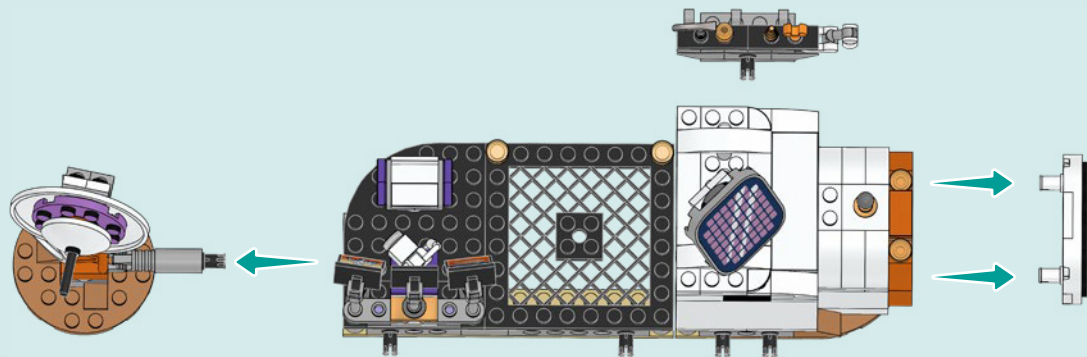

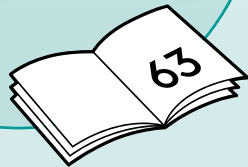
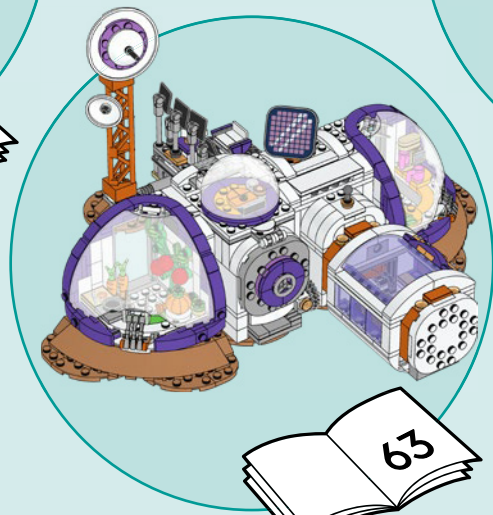
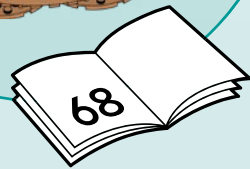
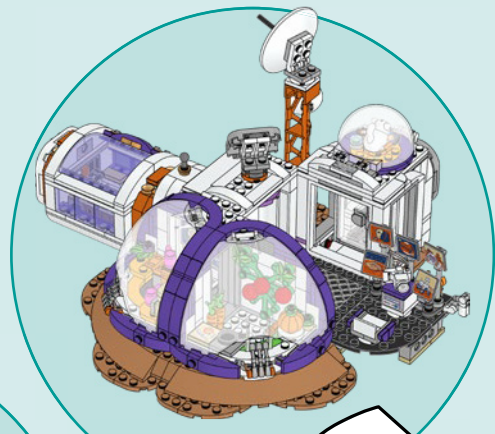
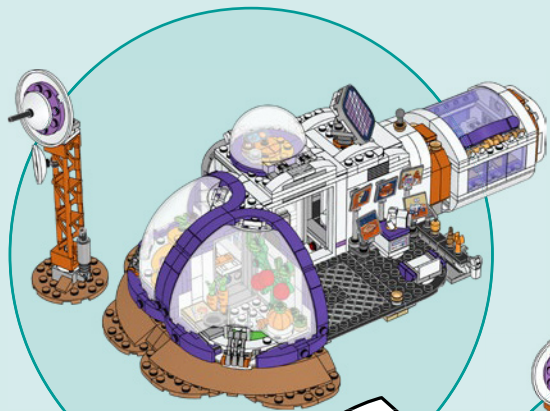

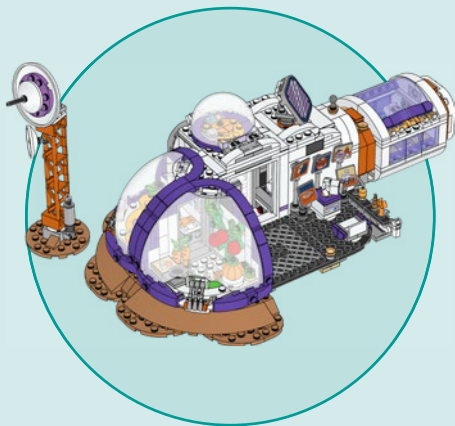

1

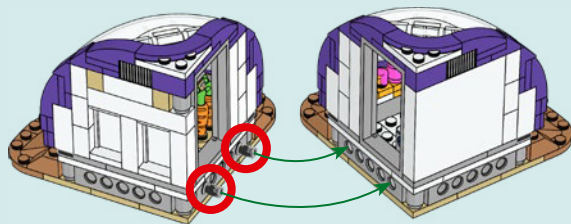

2

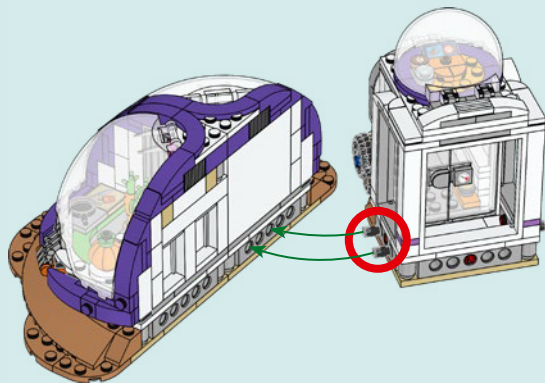

3

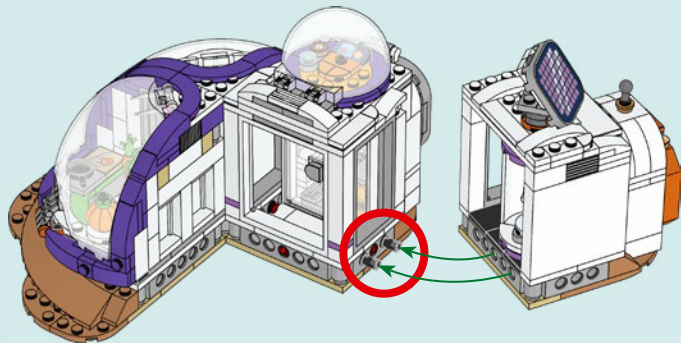

4

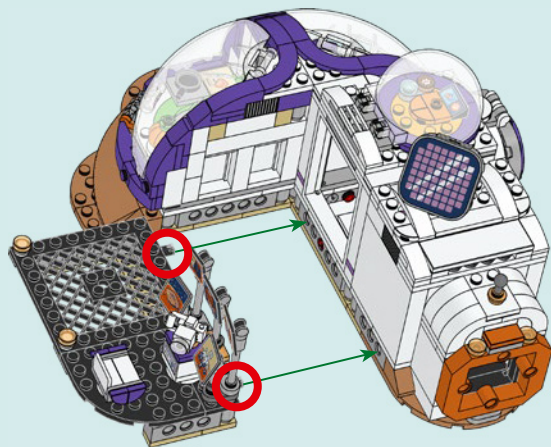

5

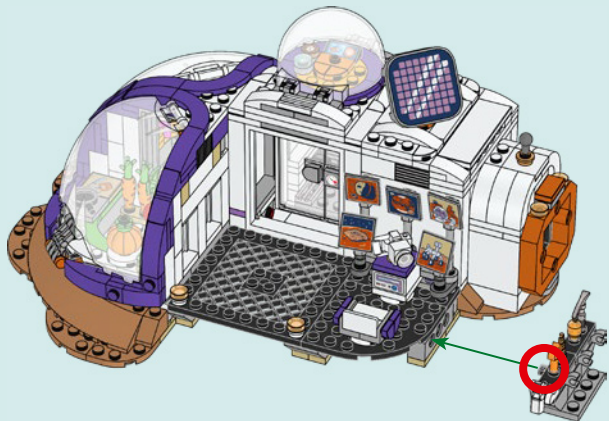

6

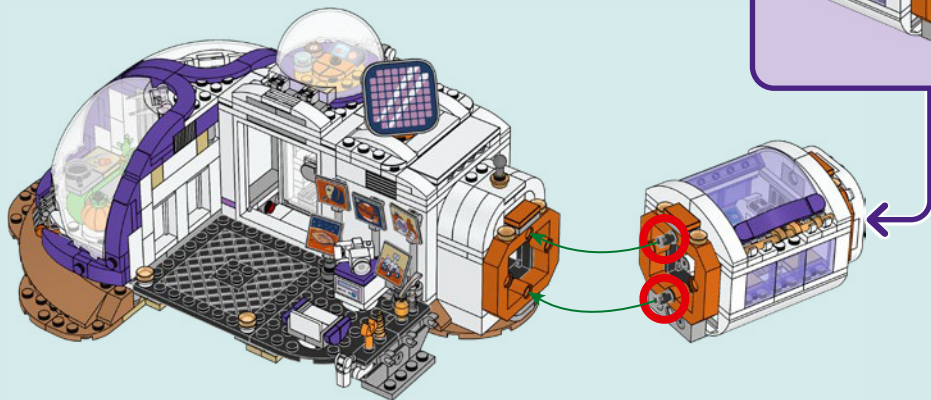

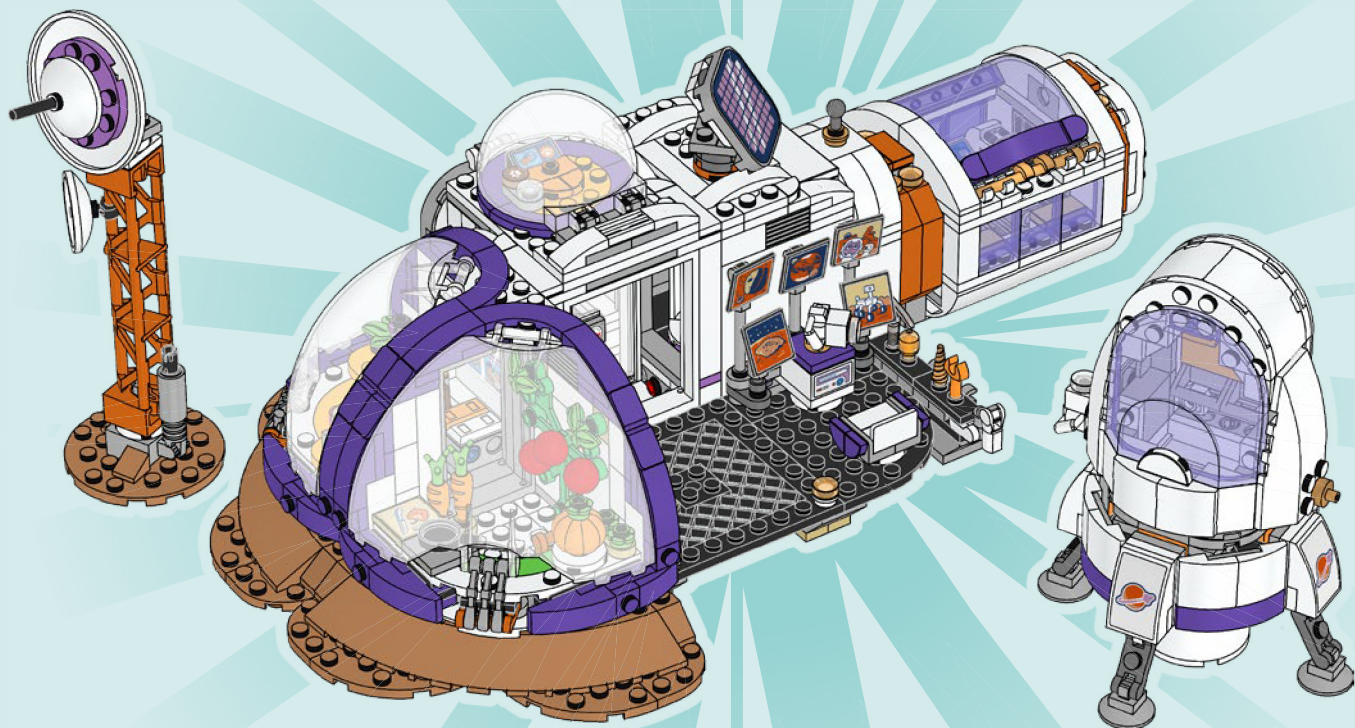

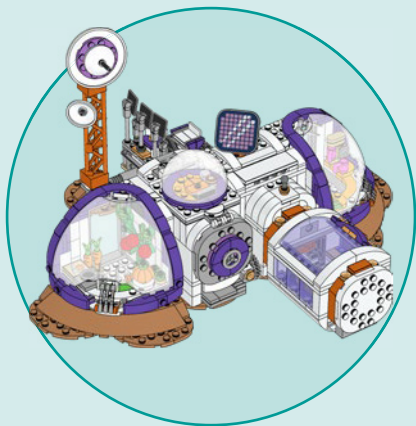

1

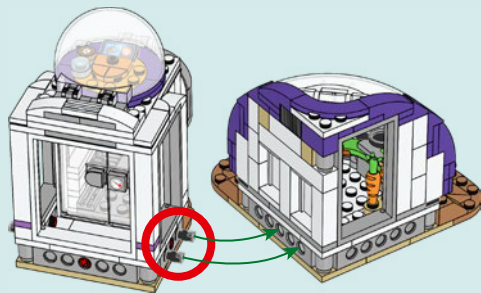

2

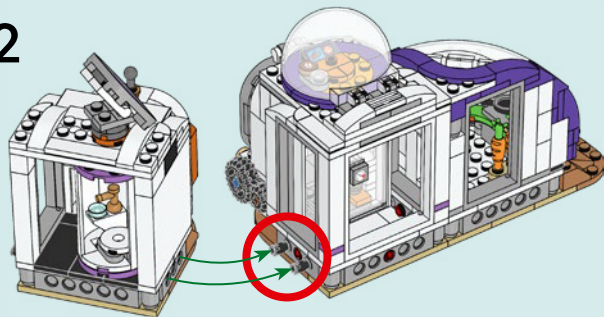

3

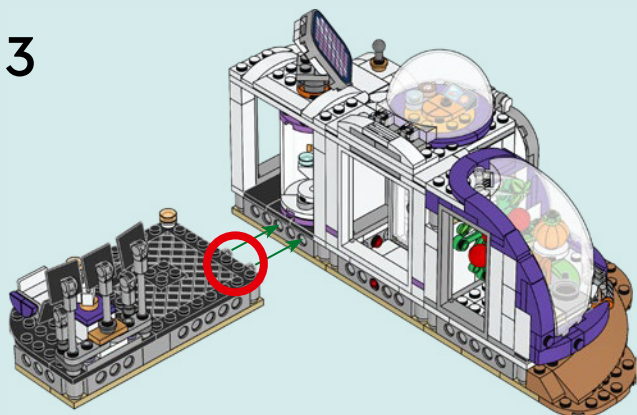

4

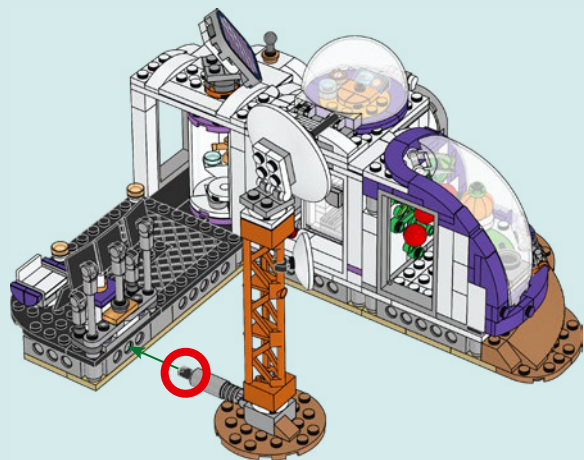

5

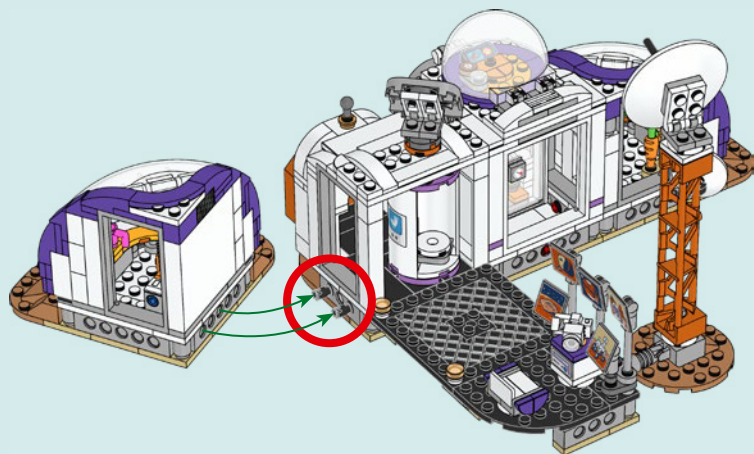

6

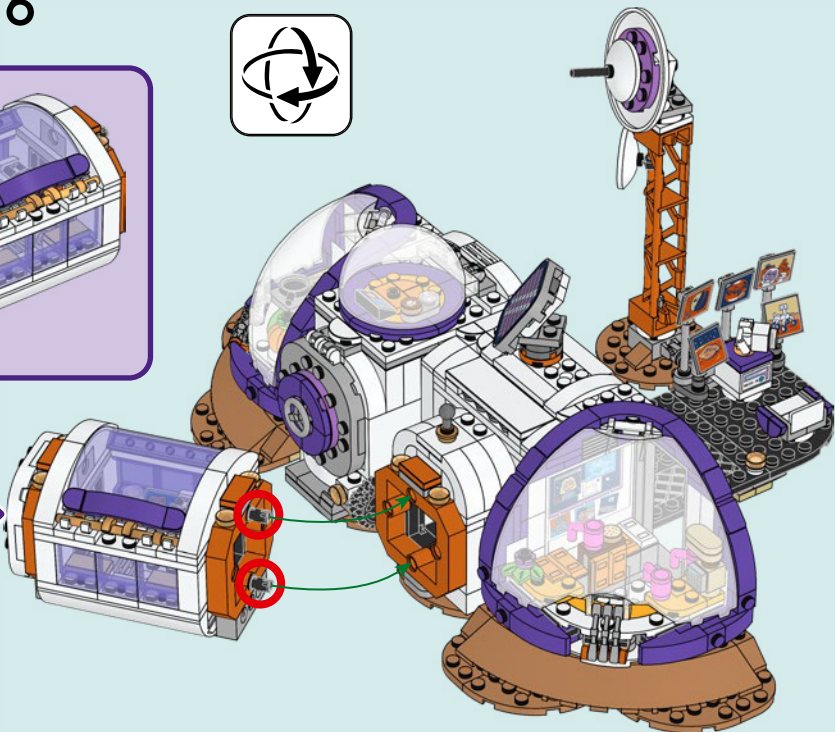
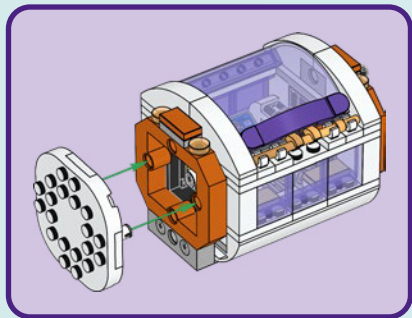

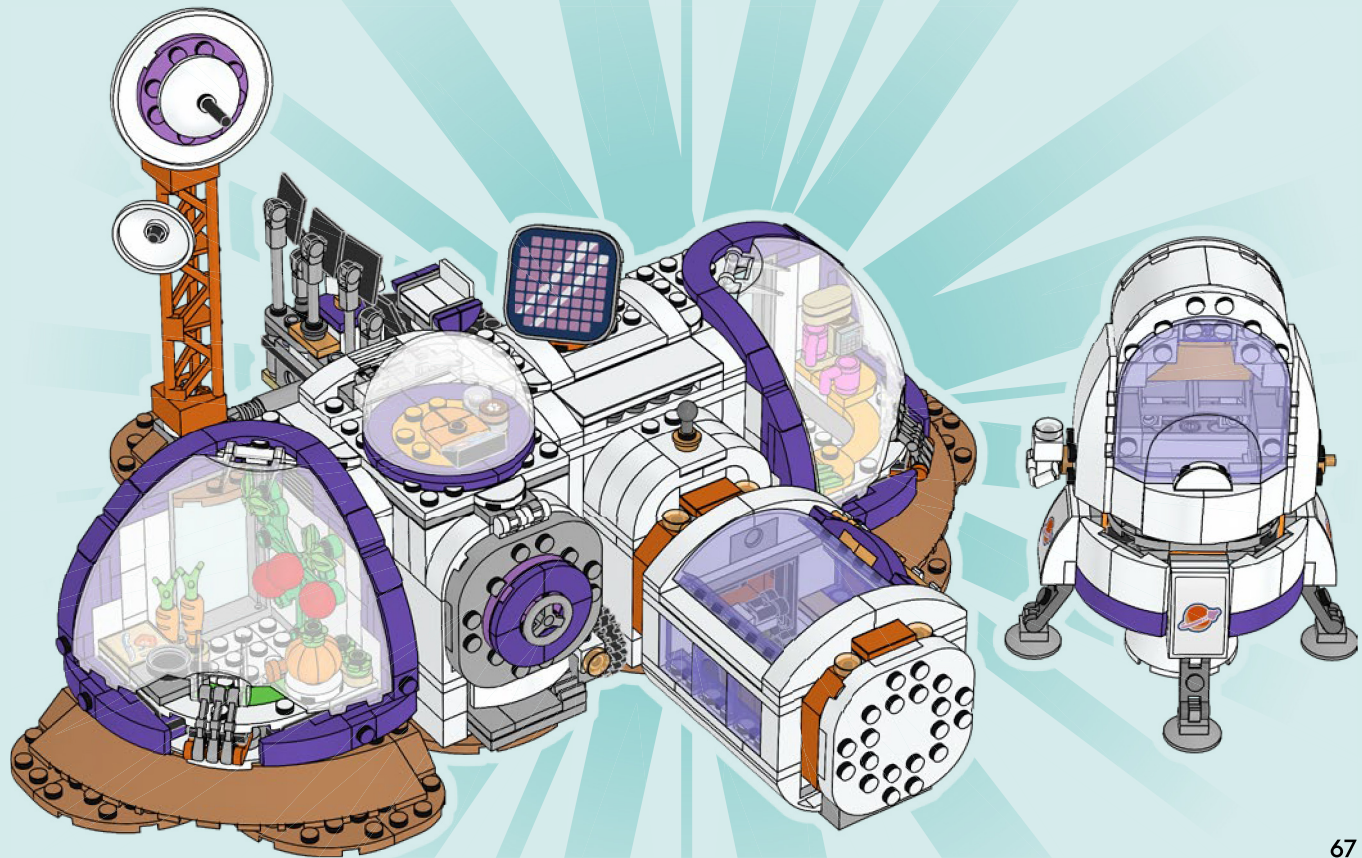

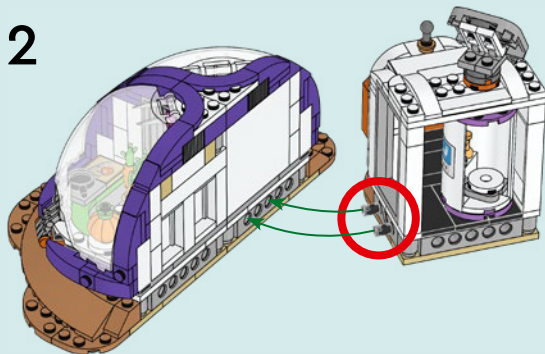
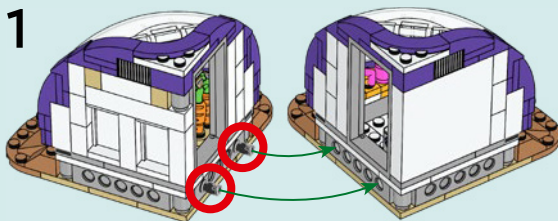
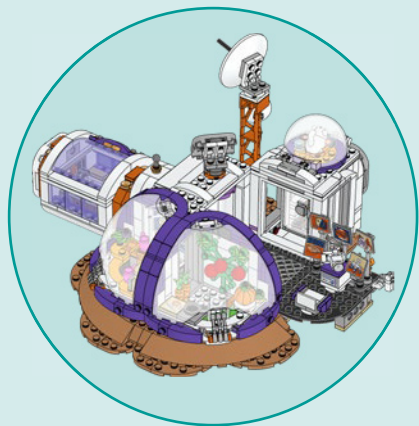

3

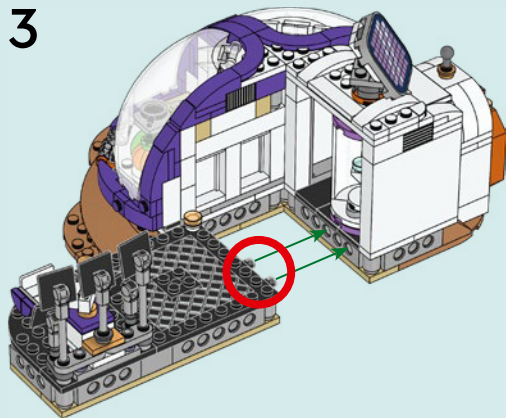

4

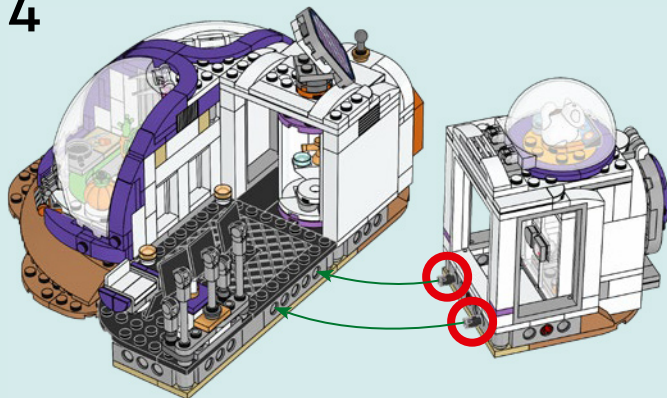

5

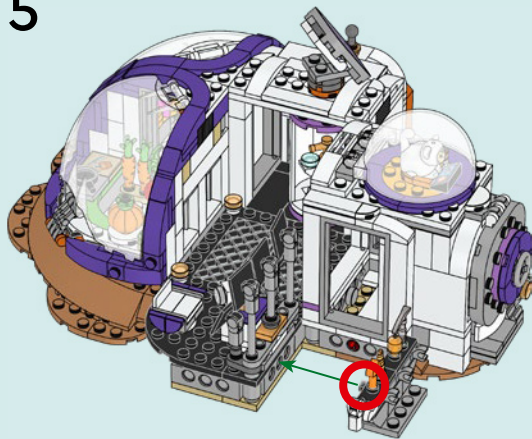

6

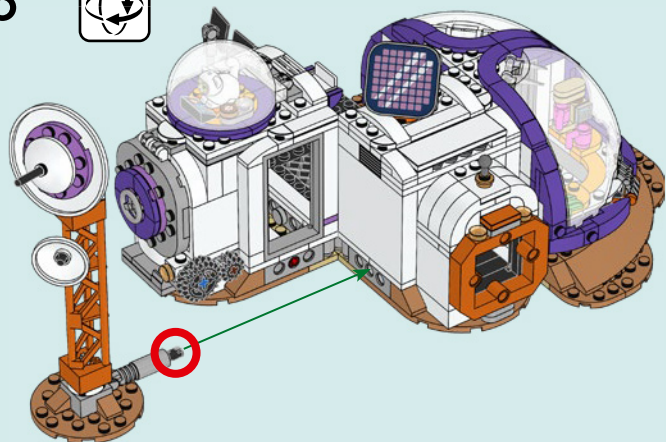

7

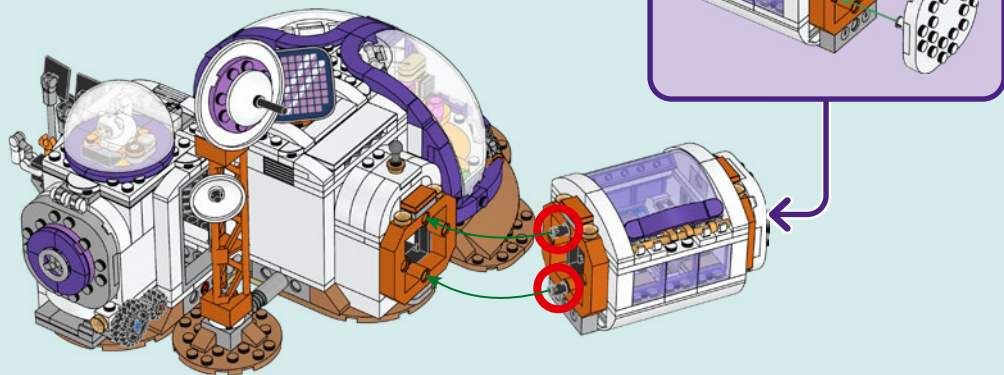

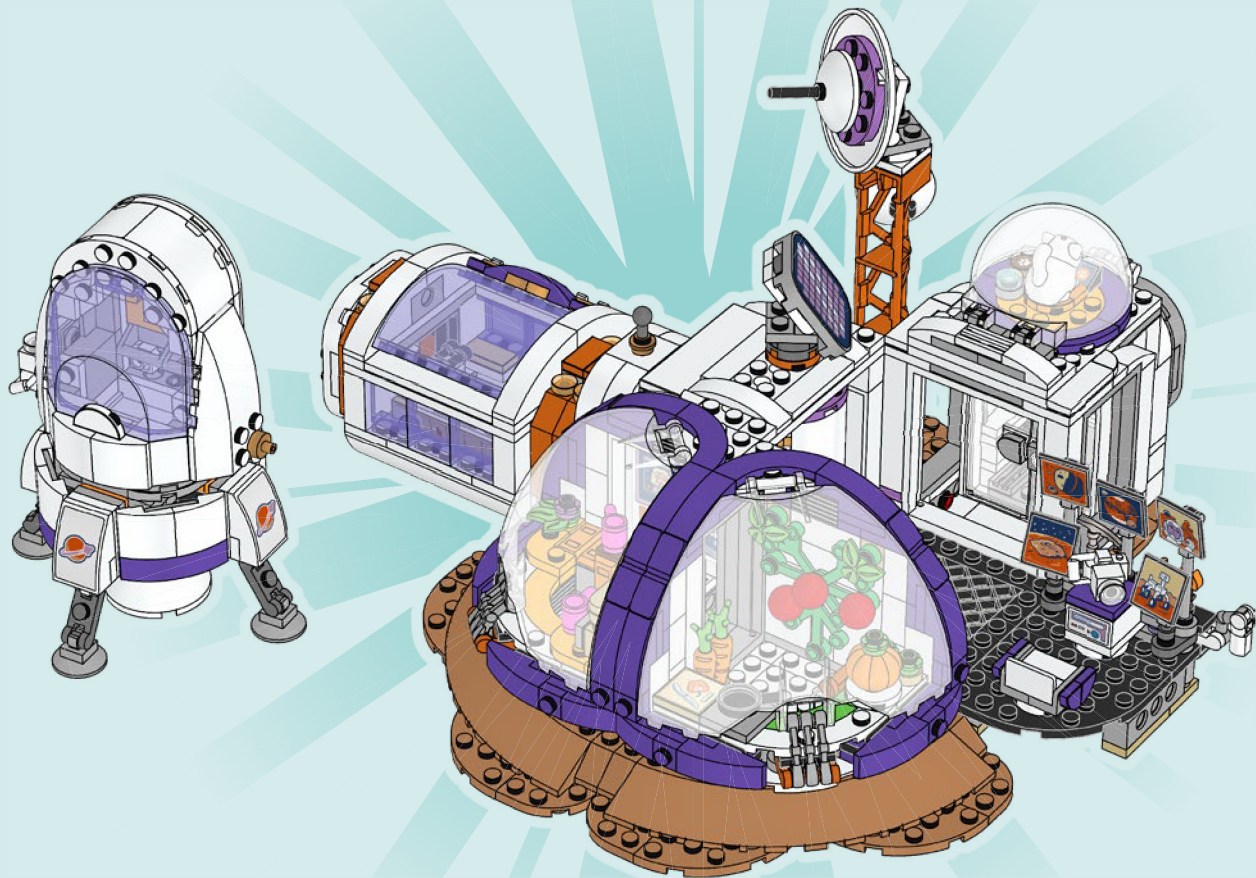

ESPACE ESPACIO

Weltraum
L'espace
Spazio

Espaço
太空
Kosmos

Vesmír
Világűr
Spațiu

Космос
Kosmos
Erdvè



**To know more, visit:
Pour en savoir plus, visiter :
Para más información, visita:**

Weitere Informationen findest du unter:

Pour en savoir plus, consultez :

Per saperne di più, visita:

Para mais informações, aceda a:

了解更多, 请访问:

Aby dowiedzieć się więcej, odwiedź stronę:

Více informací najdete zde:

Viac informácií nájdete na:

Ha szeretnél többet megtudni, látogass el ide:

Pentru a afla mai multe, accesează:

За да научите повече, посетете:

Lai uzzinātu vairāk, apmeklē:

Lisateabe saamiseks külasta:

Sužinokite daugiau:

LEGO.com/Airlock



SPACE



42605



60432



60434



60433



Rebuild
the
world™



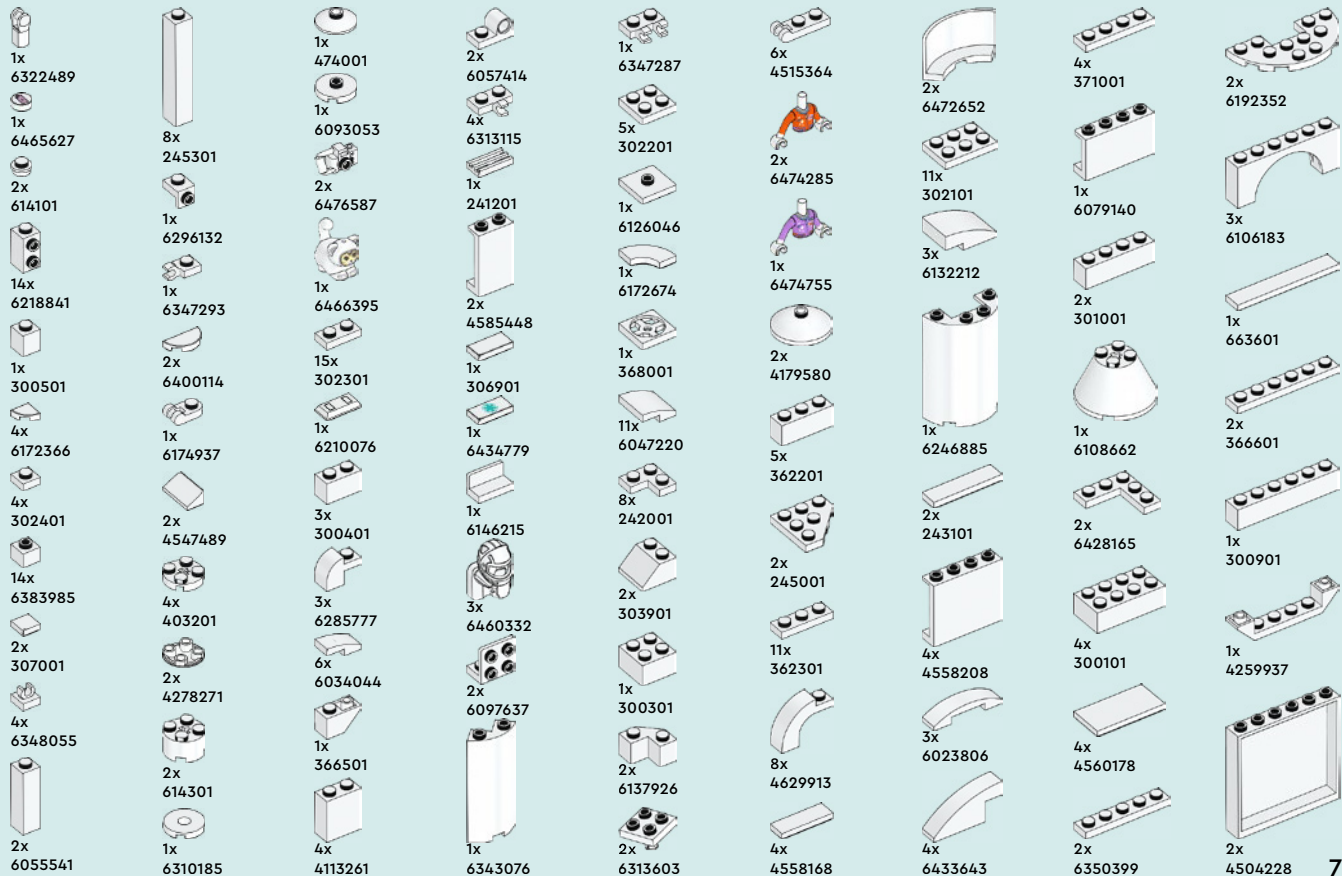

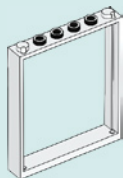

2x
6256127



1x
4514791



8x
379501

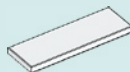

1x
6332042



1x
4181142



2x
4179869

76



1x
6475043



2x
6399559



6x
346001

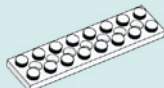

1x
4527945



2x
6057460



1x
6472515

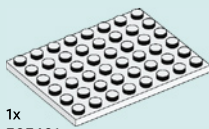

1x
303601

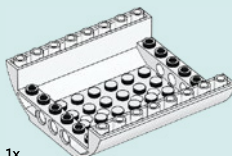

1x
6458576



3x
4579260



1x
6397819



4x
6212758



2x
4114026



1x
4185177



1x
4121921



4x
4118790



1x
4159739



1x
4113233



6x
6115031



3x
6351905



1x
6331158

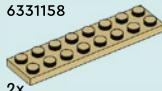

2x
4113988



1x
6466384



3x
4290714



4x
6378120



4x
6319330



2x
4206482



2x
6299413

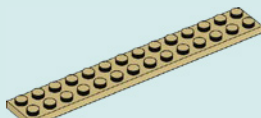

1x
6036487



4x
6331822



1x
6130007



1x
6439039



2x
6424674



4x
307026



1x
4526110



1x
6003301



1x
4177431



5x
6323189



8x
6210270



1x
6371584



2x
4548180



20x
6279875



1x
452826



4x
6273330



2x
6092585



2x
370026



1x
6403650



8x
6020193



1x
6346535



1x
6170693



4x
6133722



1x
303926



4x
302226



2x
6199908



1x
6116604



5x
243126



3x
4530589

1x
371026

2x
4560182

1x
366626

1x
663626

1x
4181144

1x
379526

1x
6137779

1x
6231856



1x
6266968

2x
6434871

3x
6206150

2x
6235080

1x
6182261

2x
6462578

1x
6406233

4x
4666352

1x
6375188

3x
6274738



2x
6424464

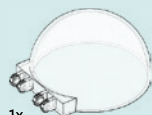

1x
6472513

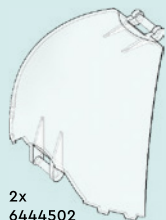

2x
6444502

2x
6274739

1x
6246890

1x
6439042

2x
6173925

1x
6267125

5x
6149656

2x
6092599

4x
4177932

2x
6424015

4x
6061676

1x
4121741

1x
6240515

1x
6469018

1x
6210415

1x
6325432

6x
6240210

3x
6472517

6x
6475046

1x
6472510

1x
6472651

2x
6171764

9x
6274747

4x
6073040

1x
6249235

1x
6028736

3x
6133805

2x
6444576

1x
6003033

1x
6115115

1x
6453948

1x
6421543

1x
4216581

1x
6240205

1x
6174856

1x
6135494

1x
6355025

5x
6343976

16x
4211412

2x
6284071

5x
6258831

1x
6326748

1x
6448793

1x
6250597

1x
6329583

4x
4211399

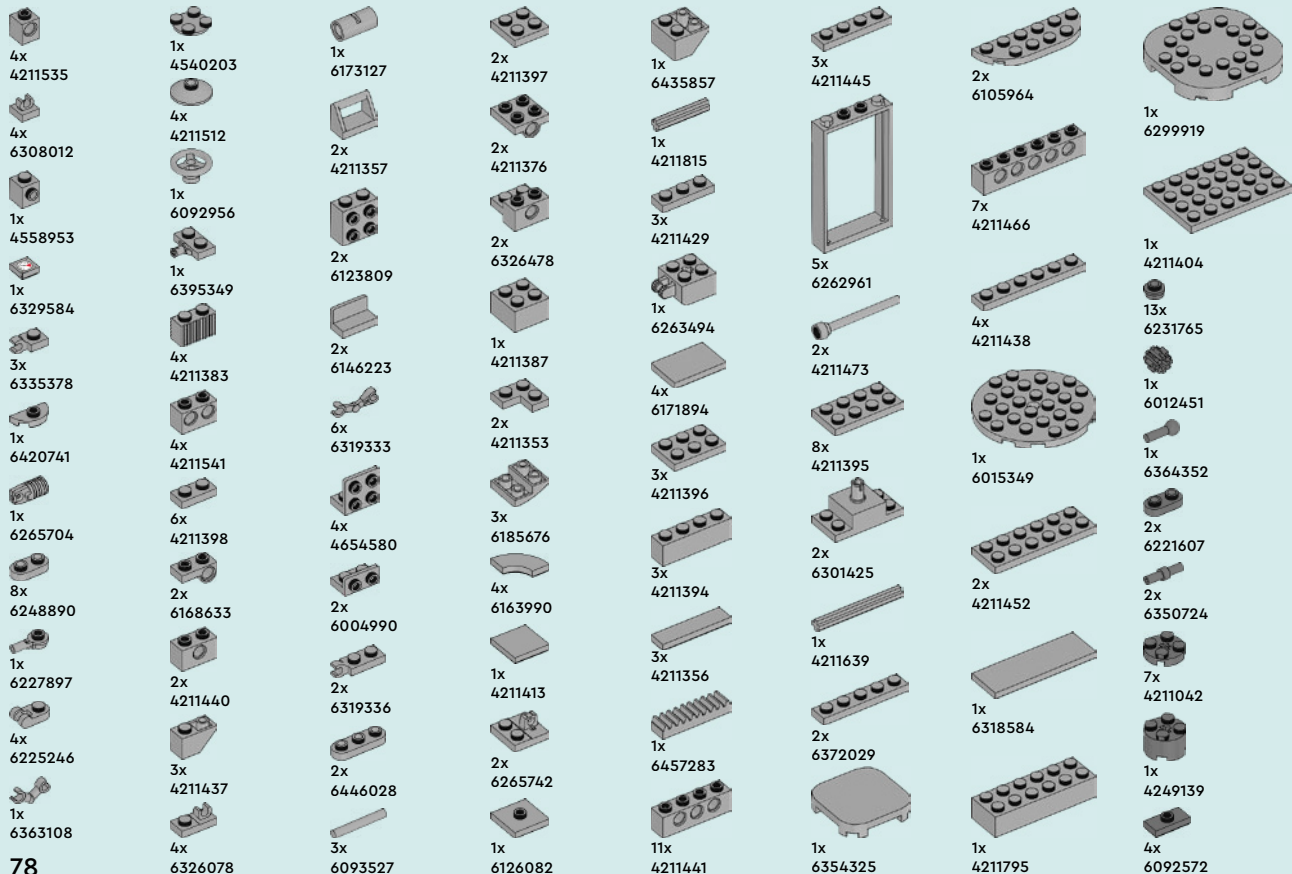

4x
6214341

4x
6352600

3x
4618670

2x
6313558

22x
6231376

4x
6199891

12x
4655695

2x
6104154

8x
6472512

4x
6057390

4x
6199899

1x
6446090

12x
6103449

12x
6167464

5x
6069012

6x
6472509

1x
6466389

1x
6214208

1x
6170470

1x
6190252

3x
6186672

1x
6146054

2x
6284379

1x
6092594

1x
6274748

1x
6299470

1x
6299469

1x
6287854

1x
6167641

1x
6287856

2x
6167690

1x
6145528

8x
6058135

4x
6252194

4x
6369499

1x
6345302

2x
6442140

2x
6301315

1x
6438518

4x
4619636

4x
4620909

2x
4625032

1x
6209684

2x
4619521

1x
6466394

3x
6139090

4x
6134717

1x
6464814

2x
6466388

3x
6471811

3x
6469086

3x
6468361

1x
6466717

3x
6468285

1x
6466390



 [LEGO.com/service](https://www.LEGO.com/service)

YOU COULD
WIN



Scan this QR code or go to
LEGO.COM/PRODUCTFEEDBACK and give
us your short feedback about this LEGO® set
for a chance to win a cool LEGO prize.

Terms and Conditions apply*

EN: YOU COULD WIN. Terms and Conditions apply* **DE: Du könntest GEWINNEN.** Es gelten die Teilnahmebedingungen* **FR: Tu pourrais GAGNER.** Des conditions s'appliquent* **IT: Potresti VINCERE tu.** Termini e condizioni sono applicabili* **ES: Puedes GANAR.** Aplican términos y condiciones* **PT: Poderá GANHAR.** Aplicam-se termos e condições* **ZH: 轻松获奖. 条款和条件适用*** **PL: Szansa na WYGRANĄ.** Obowiązują warunki korzystania* **CS: Máte šanci VYHRÁT.** Platí všeobecné smluvní podmínky* **SK: Máte šancu VYHRAŤ.** Platia všeobecné zmluvné podmienky* **HU: TE IS NYERHETSZ.** Felhasználási feltételek érvényesek* **RO: Ai putea CÂȘTIGA.** Se aplică termenii și condiții* **BG: Можете да СПЕЧЕЛИТЕ.** Има определени правила и условия* **LV: Tu vari LAIMĒT.** Ir spēkā noteikumi un nosacījumi.* **ET: Sul on võimalus VÕITA.** Kehtivad tingimused* **LT: Jūs galite LAIMĖTI.** Taikomos sąlygos*

*[LEGO.com/productfeedback-terms](https://www.lego.com/productfeedback-terms)