



BRICK 'HEADZ

41612



MINECRAFT



[LEGO.com/brickheadz](https://www.lego.com/brickheadz)

STEVE

58

1



2



3



4





1

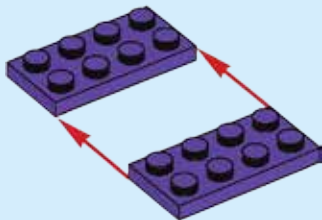



2x

2

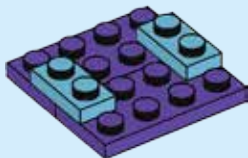

4



3

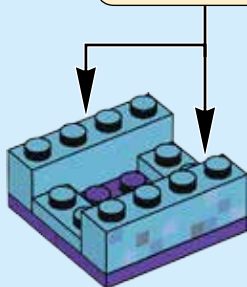
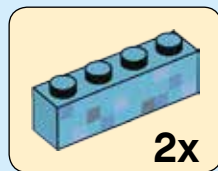

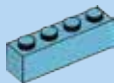

1x



2x

4

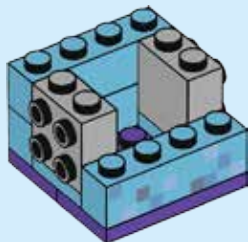

6

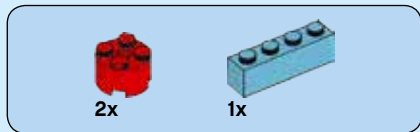

5

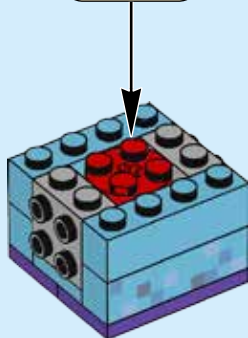



1x

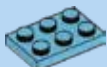

2x



2x

6



8



7

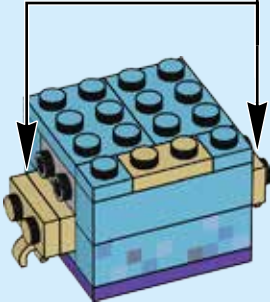
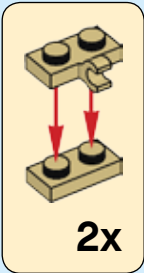



2x



2x

8

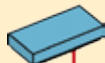

2x

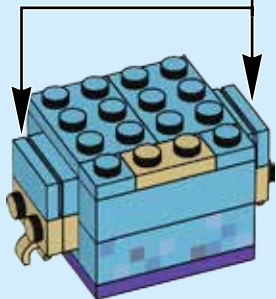



6x

9

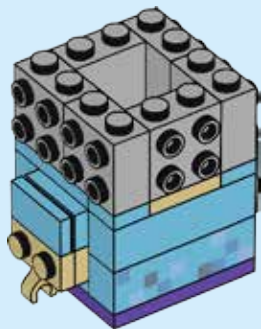



10

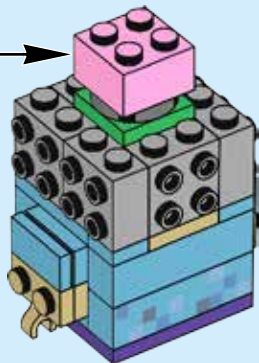
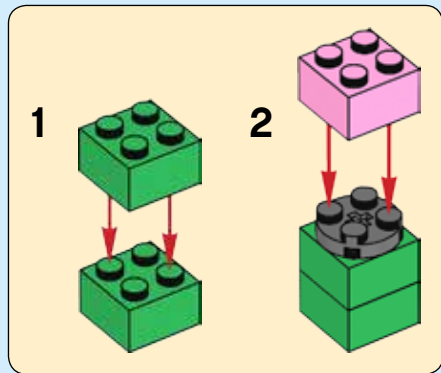

12



6x

11

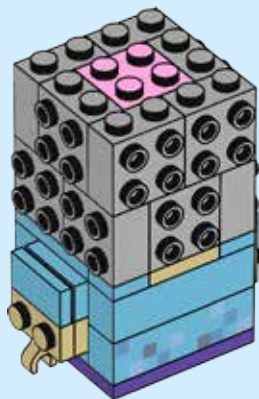



1x

12

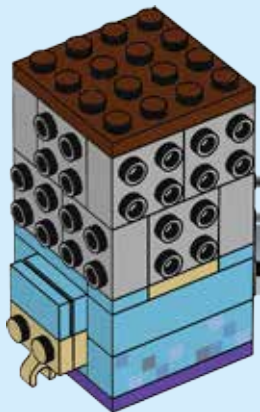

14



13

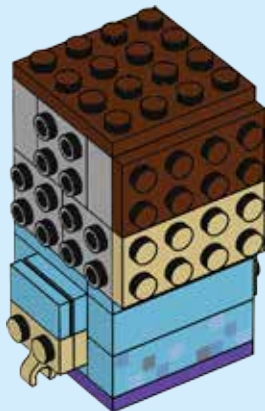

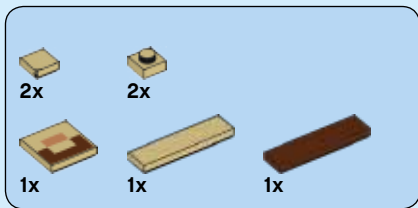

14

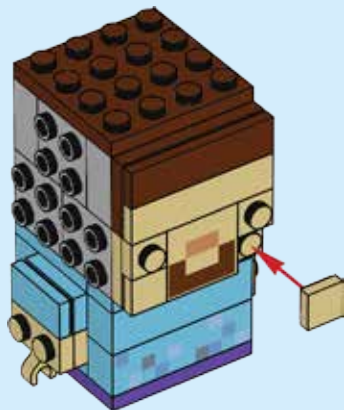



2x

15

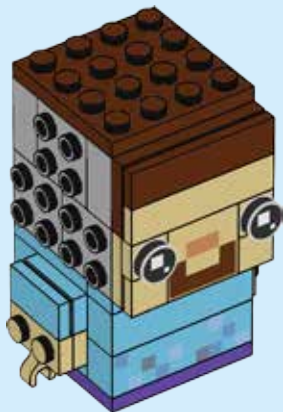



1x



1x



1x



1x

16

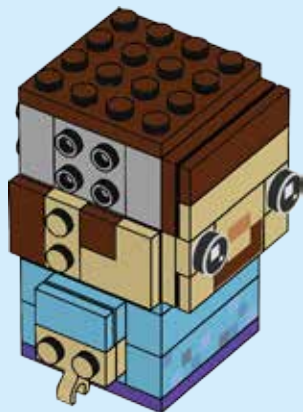

18



1x



1x

17

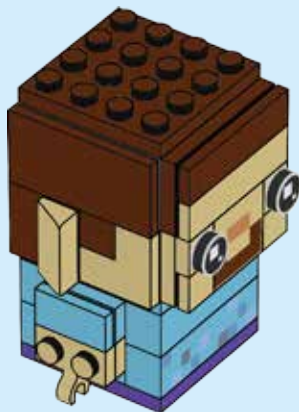



1x



1x



1x



1x

18

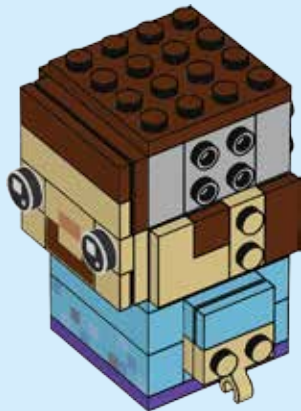
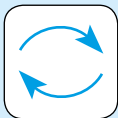



19





1x

20

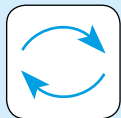

22



2x

21





1x

22

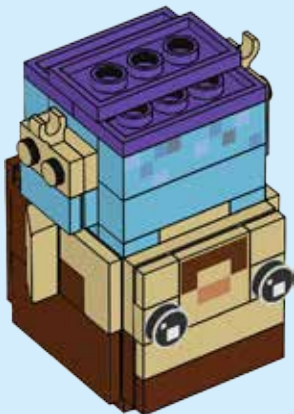
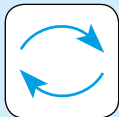

24

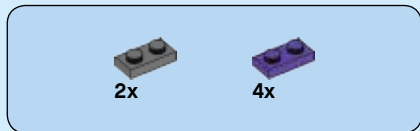

23

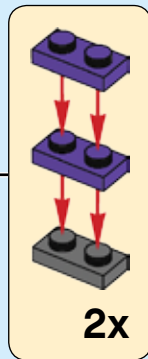
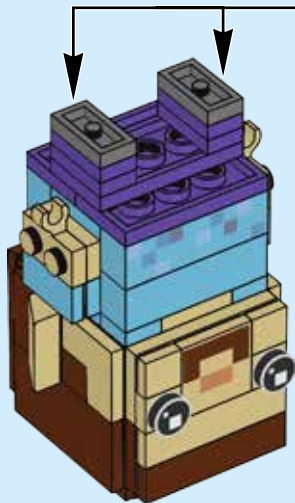



1x

24

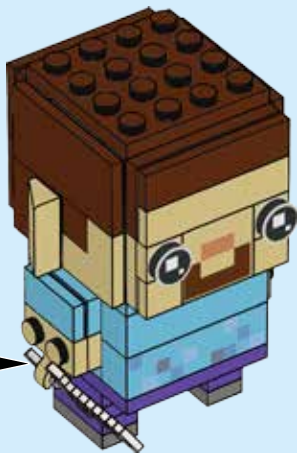
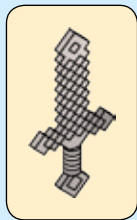
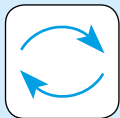

26

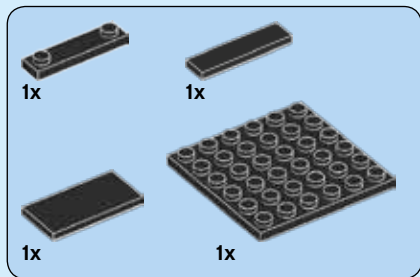

25

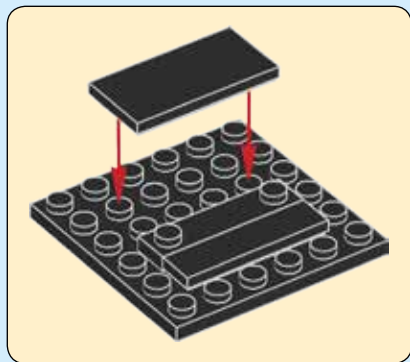



WIN

GO TO WWW.LEGO.COM/PRODUCTFEEDBACK AND
GIVE US YOUR SHORT **FEEDBACK** ABOUT THIS
LEGO® SET FOR A CHANCE TO WIN
A COOL LEGO PRIZE.

Terms & Conditions apply

LEGO.com/productfeedback

GEWINNE

Erzähle uns auf
www.LEGO.com/productfeedback

etwas über die Erfahrungen, die du
mit diesem LEGO® Set gemacht hast,
und sichere dir die Chance auf einen
coolen LEGO Preis!

Es gelten die Teilnahmebedingungen

GAGNE

Rends-toi sur
www.LEGO.com/productfeedback

et donne-nous quelques commen-
taires sur ce produit LEGO® pour
avoir une chance de gagner un
prix LEGO !

Voir Conditions Générales

GANANA

Visita
www.LEGO.com/productfeedback

y envíanos tu opinión acerca de este
set LEGO®. ¡Participarás en el sorteo
de un premio LEGO!

Términos y Condiciones aplicables

获取奖品

登录
www.LEGO.com/productfeedback

给出关于此乐高®套装的简短反馈，
就有机会获得炫酷乐高奖品

《条款及条件》适用

LEGO and the LEGO logo are trademarks of the/sont des marques de commerce du/
son marcas registradas de LEGO Group. ©2018 The LEGO Group.

© 2018 Mojang AB and Mojang Synergies AB. MINECRAFT is a trademark or
registered trademark of Mojang Synergies AB.

6248186