



# Mixels™

41546

## FORX



**WARNING: CHOKING HAZARD.**  
Toy contains small parts and a small ball.  
Not for children under 3 years.



LEGO.com

6126509

# 1



# 2

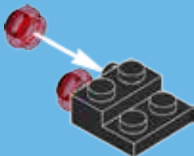

# 3

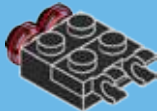

**AVERTISSEMENT : RISQUE D'ÉTOUFFEMENT.**

Le jouet contient des petites pièces ainsi qu'une petite boule.  
Il ne convient pas aux enfants de moins de 3 ans.



**ADVERTENCIA: PELIGRO DE ASFIXIA.**

Juguete que contiene partes pequeñas y una pelota pequeña.  
No recomendado para niños menores de 3 años.

4

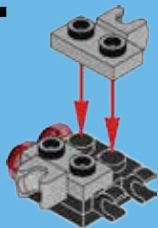

5



6

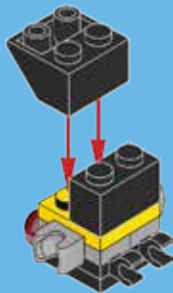

7



8



9

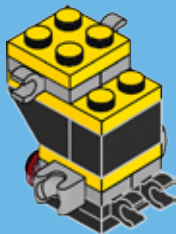

10



11



1



2



2x

12

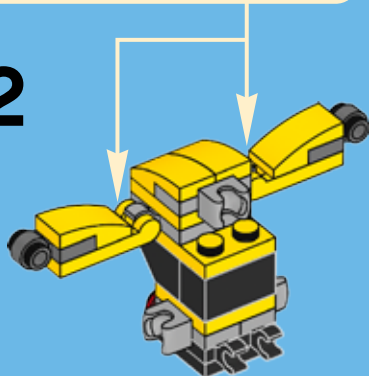

13

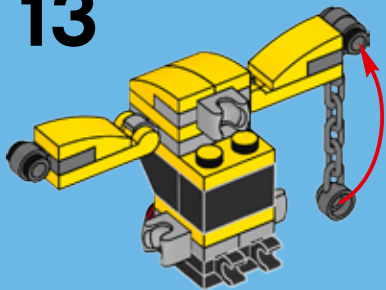

14



15



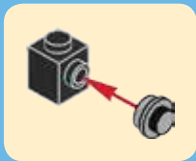

16



17



18

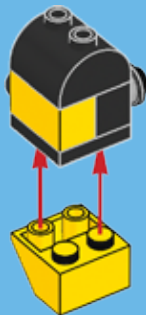



19



20

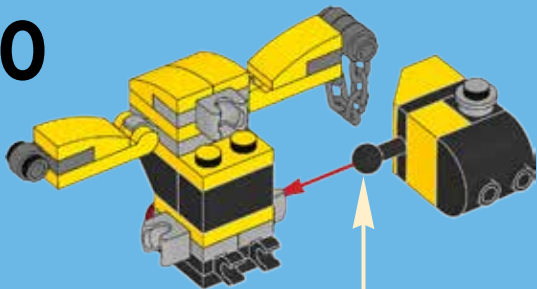



21

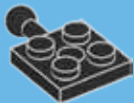

22



23

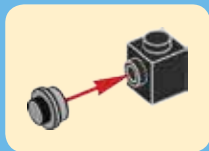

24



25

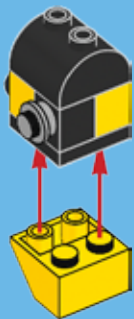

26



27

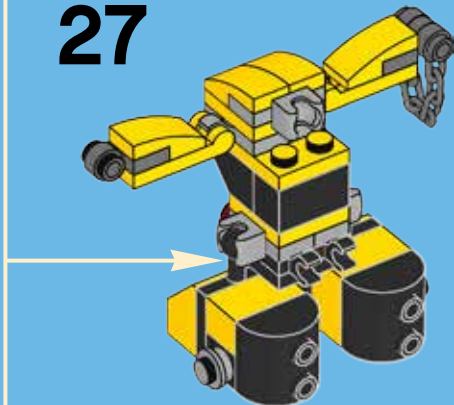



28

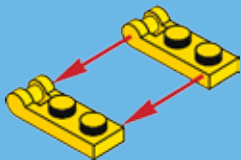

29



30

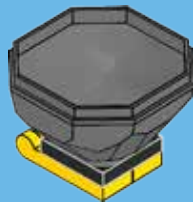

31

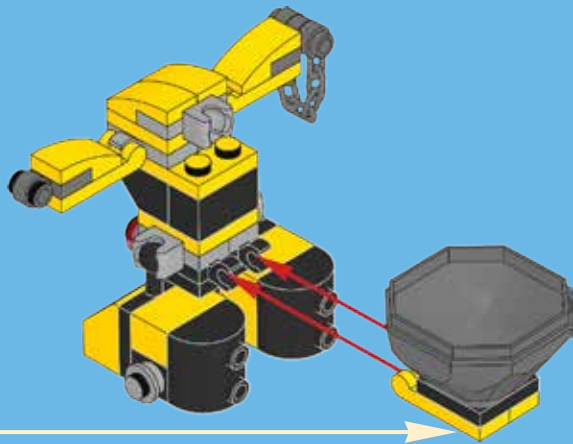



32



33



34



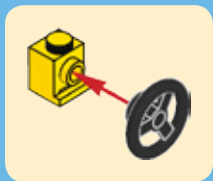

**35**



**36**



**37**



38



39

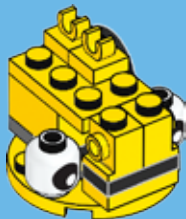

40

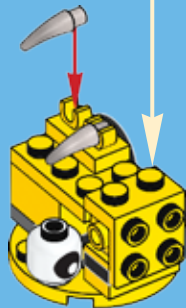



41

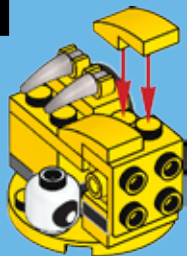

42

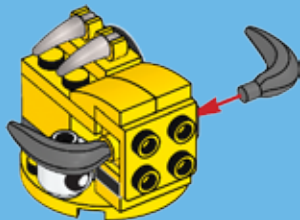

43

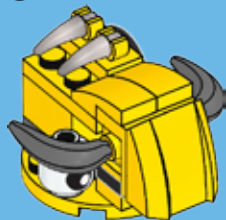

44



45

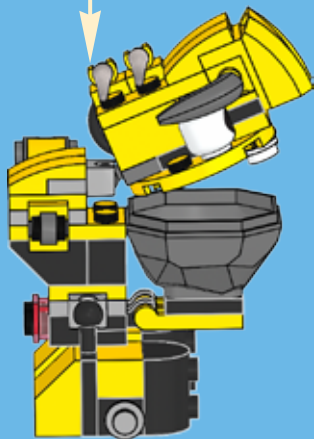

46





2x  
614101



3x  
6043656



3x  
235724



2x  
302124



2x  
6071270



1x  
300426



2x  
4632574



2x  
6060802



2x  
6028812



3x  
407024



1x  
6117938



2x  
302224



1x  
366026



1x  
6039479



2x  
3005741



2x  
4211525



2x  
366024



4x  
4515367



2x  
4558954



2x  
4200023



2x  
6109672



2x  
4612901



1x  
4540203



6x  
6029947



1x  
4515349



2x  
302326



1x  
6057397



1x  
302324



1x  
4144412



1x  
4556158



1x  
368026



1x  
4600437



**Customer Service**

**Kundenservice**

**Service Consommateurs**

**Servicio Al Consumidor**

**LEGO.com/service or dial**



**00800 5346 5555 :**



**1-800-422-5346 :**



1x  
6052126



2x  
6051038



1x  
4506779



**KRAMM  
41545**



**FORX  
41546**



**WUZZO  
41547**



**WELDOS MAX!**



[LEGO.com/mixels](http://LEGO.com/mixels)





# Mixels™



**41545  
KRAMM**



**41546  
FORX**



**41547  
WUZZO**



**41548  
DRIBBAL**



**41549  
GURGGLE**



**41550  
SLUSHO**



**41551  
SNAX**



**41552  
BERP**



**41553  
VAKA-WAKA**



[LEGO.com/mixels](http://LEGO.com/mixels)





**YOU CAN BUY THE GAME!  
TU PEUX ACHETER LE JEU !  
¡PUEDES COMPRAR EL JUEGO!**

**DEMOLITION**

**IN GAME CODE!  
CODE DANS LE JEU !  
¡CÓDIGO PARA EL JUEGO!**



# Mixels RUSH



Apple, the Apple logo, iPad, iPhone and iPod touch are trademarks of Apple Inc., registered in the U.S. and other countries. App Store is a service mark of Apple Inc.

Apple, le logo Apple, iPad, iPhone et iPod touch sont des marques de commerce d'Apple Inc., déposées aux États-Unis et dans d'autres pays. App Store est une marque de service d'Apple Inc.

Apple, el logotipo de Apple, iPad, iPhone e iPod touch son marcas comerciales de Apple Inc. registradas en EE. UU. y otros países. App Store es una marca de servicio de Apple Inc.

Google Play is a trademark of Google Inc.

Google Play est une marque de commerce de Google Inc.

Google Play es una marca comercial de Google Inc.