

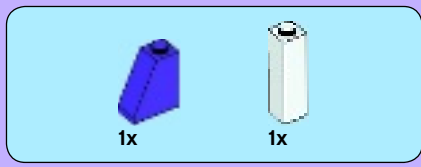

41055





62

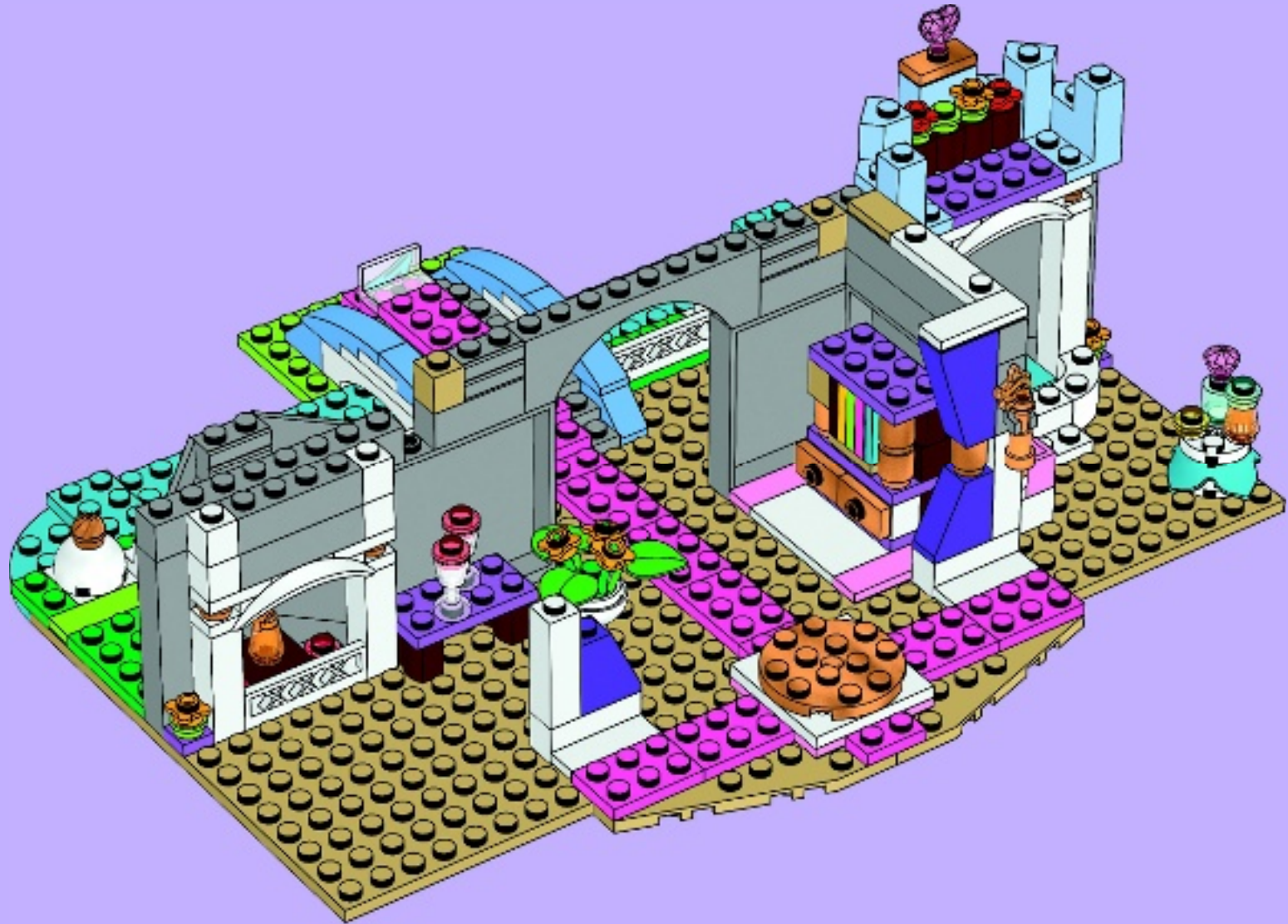



1x



1x

63



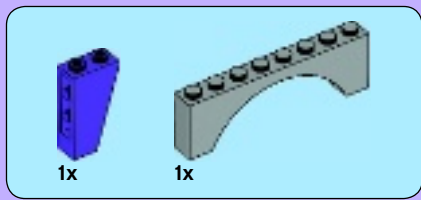

64

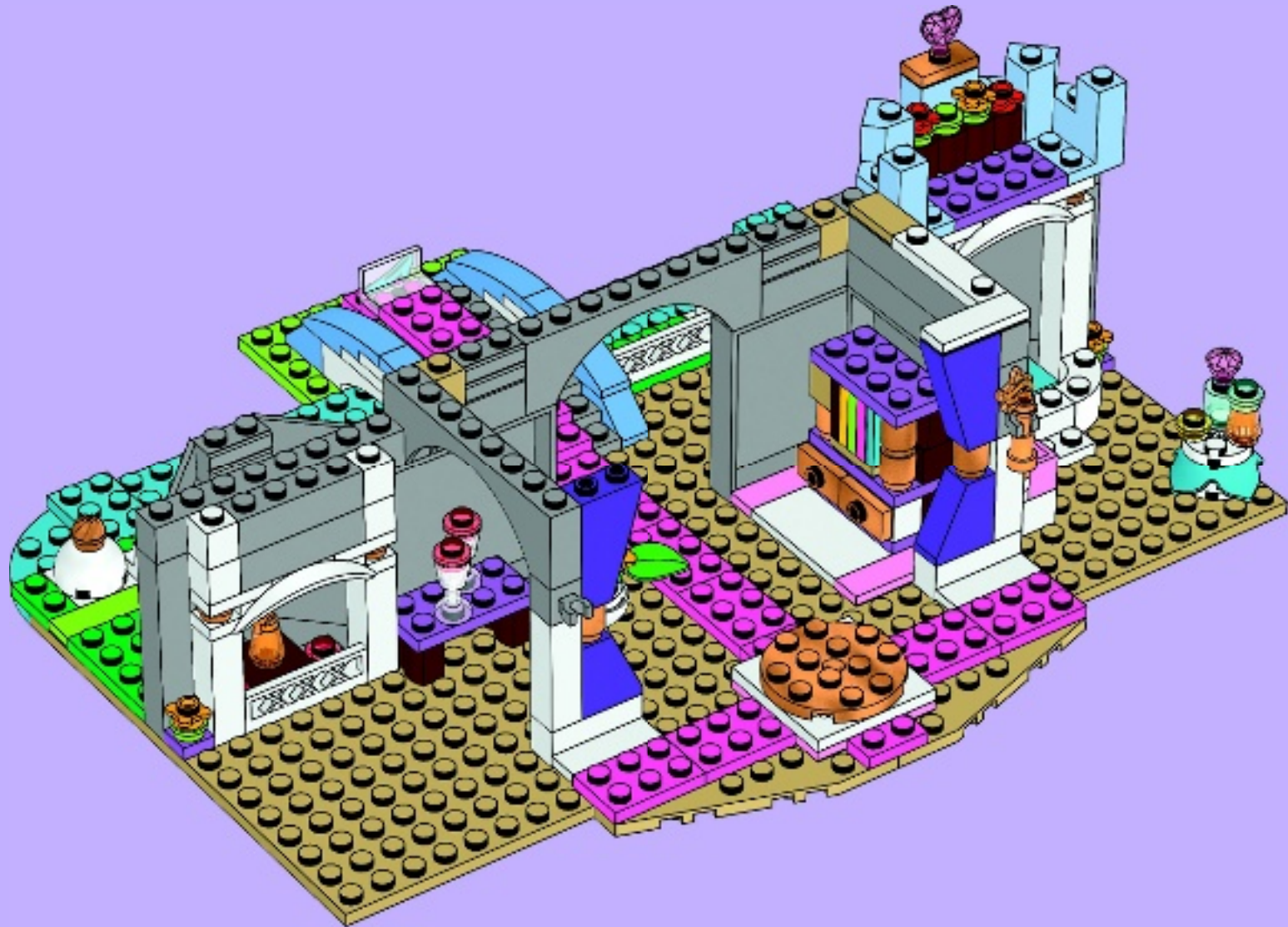

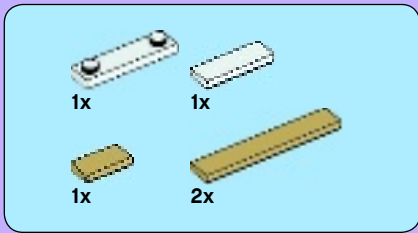

65

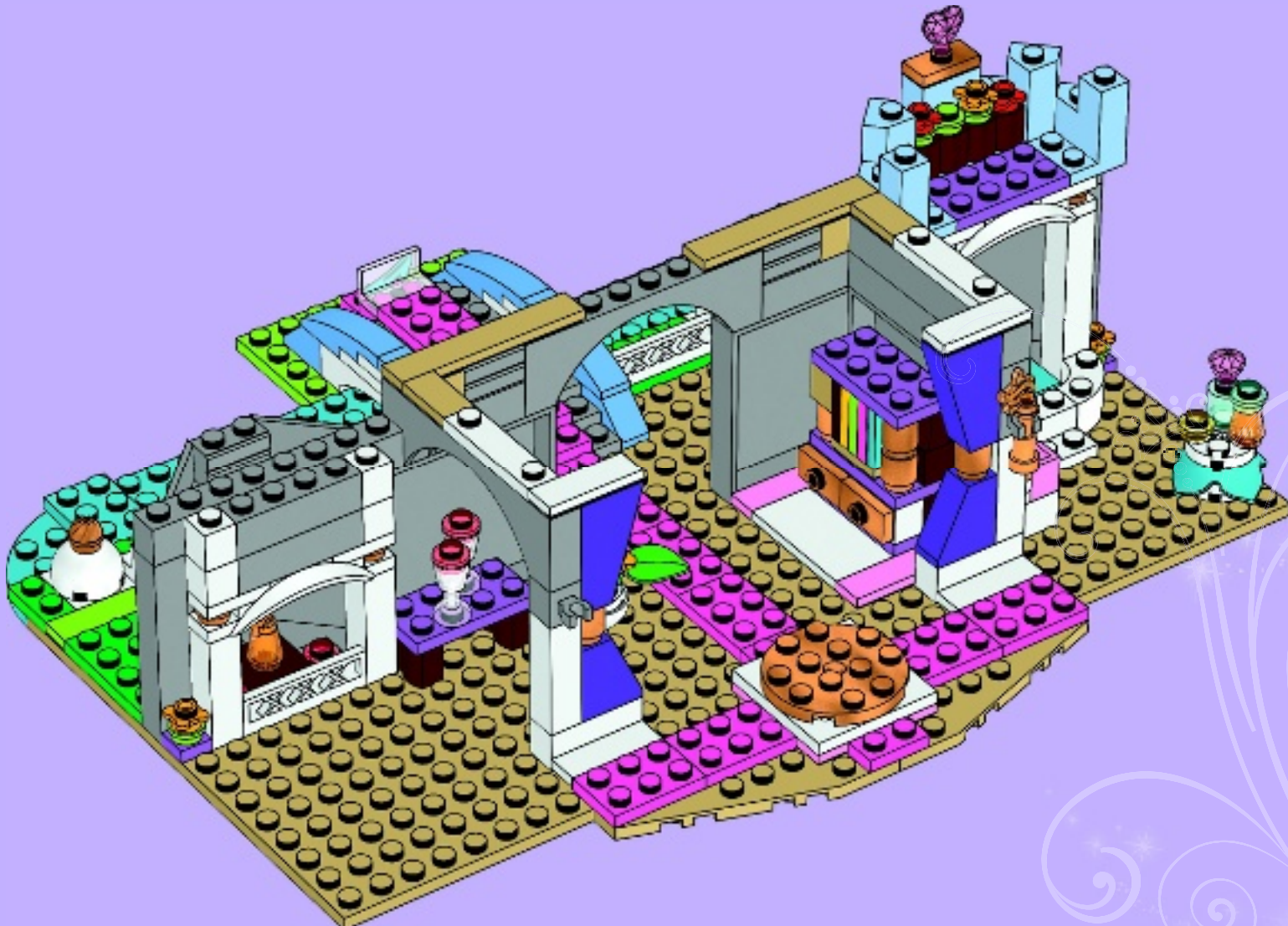

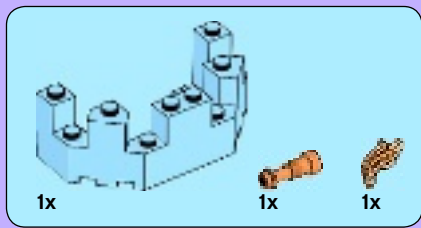

66

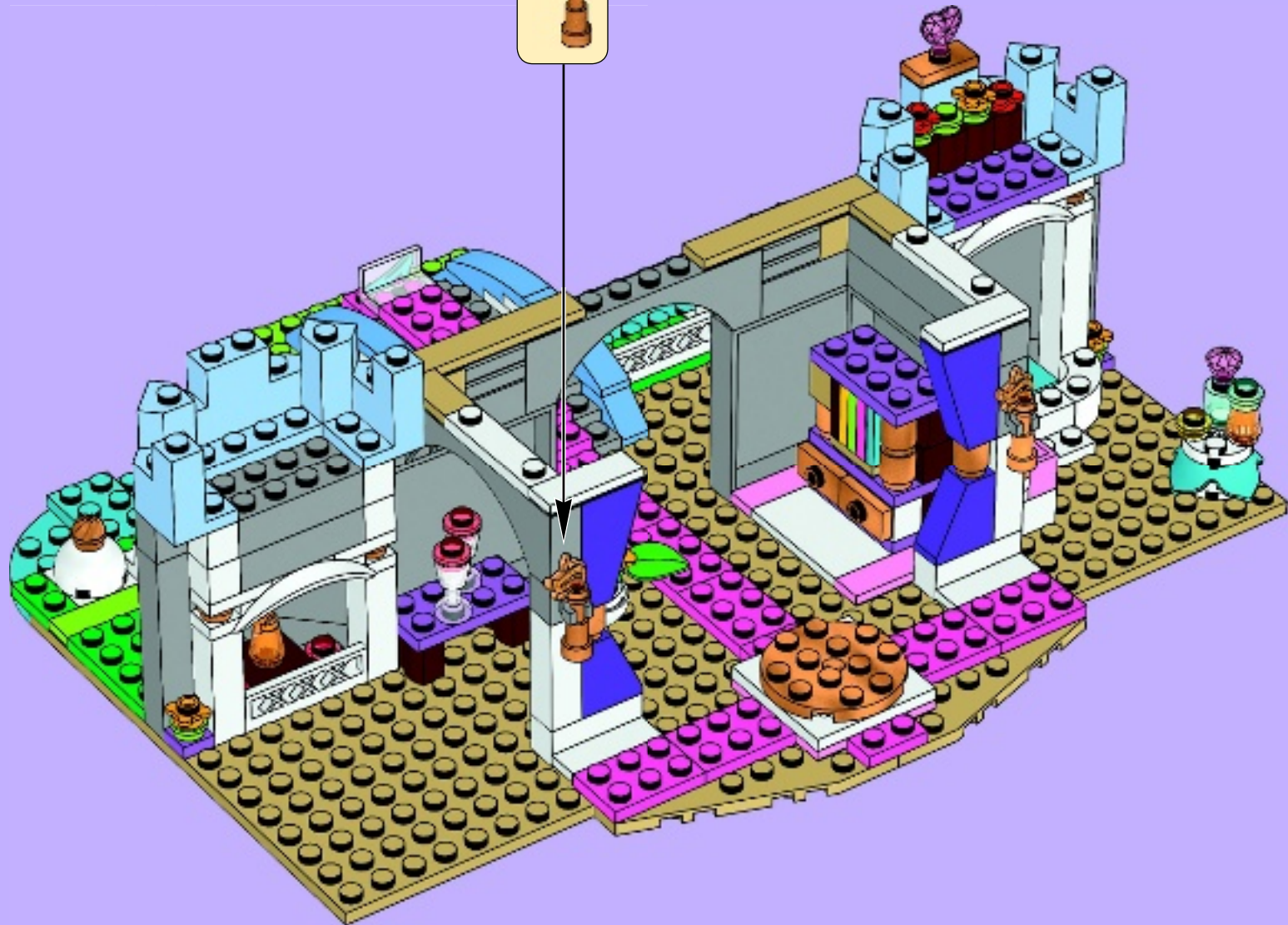
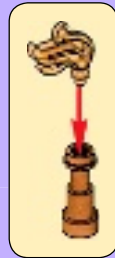



67

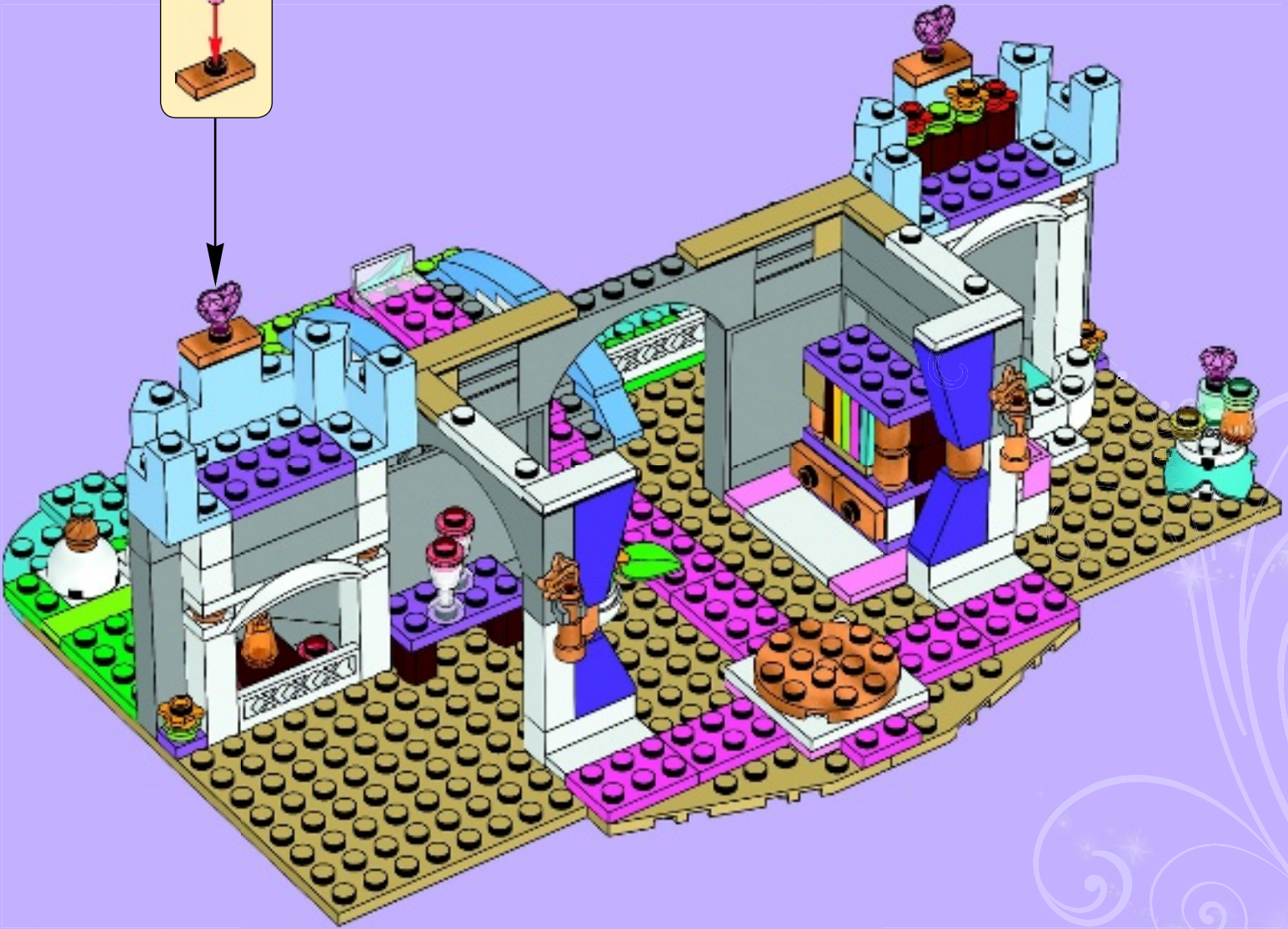



68

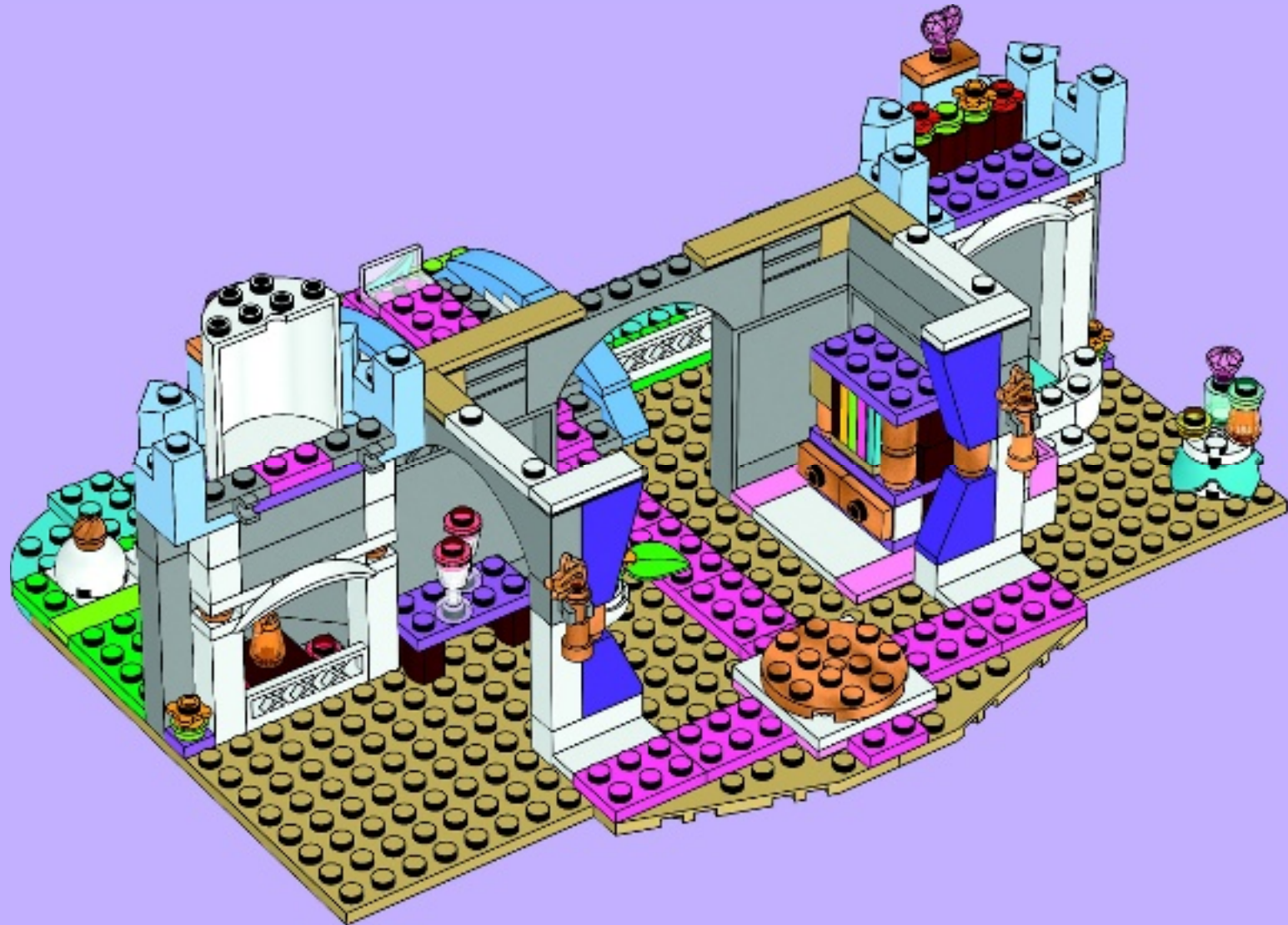

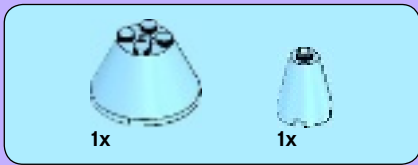

69

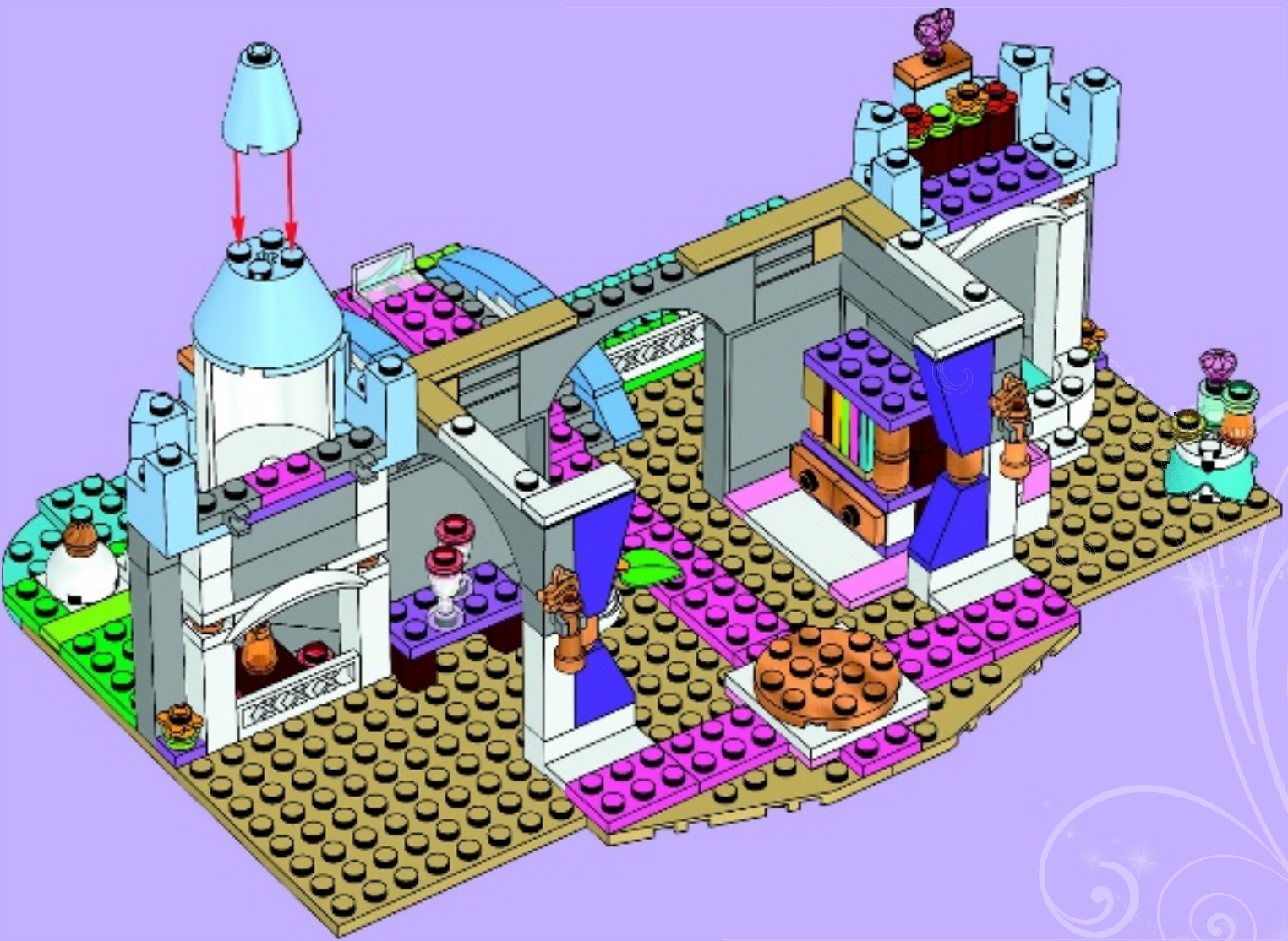

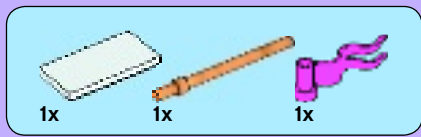

70

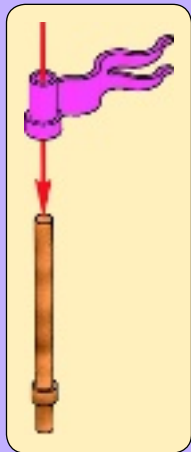



1

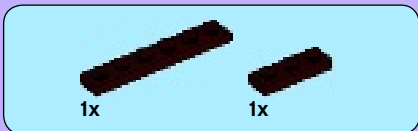
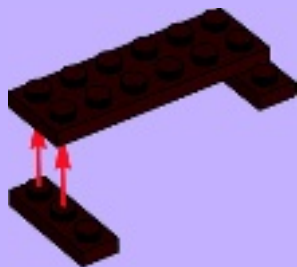

2



3

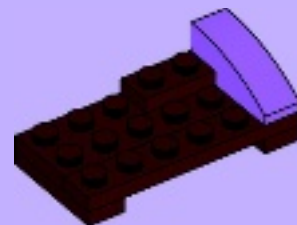

4

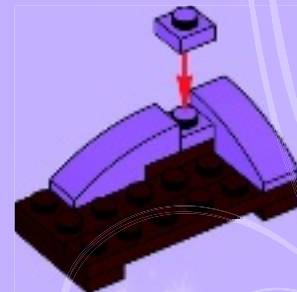



5

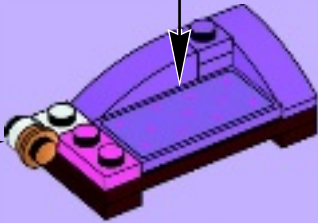
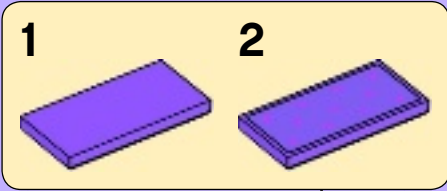

71

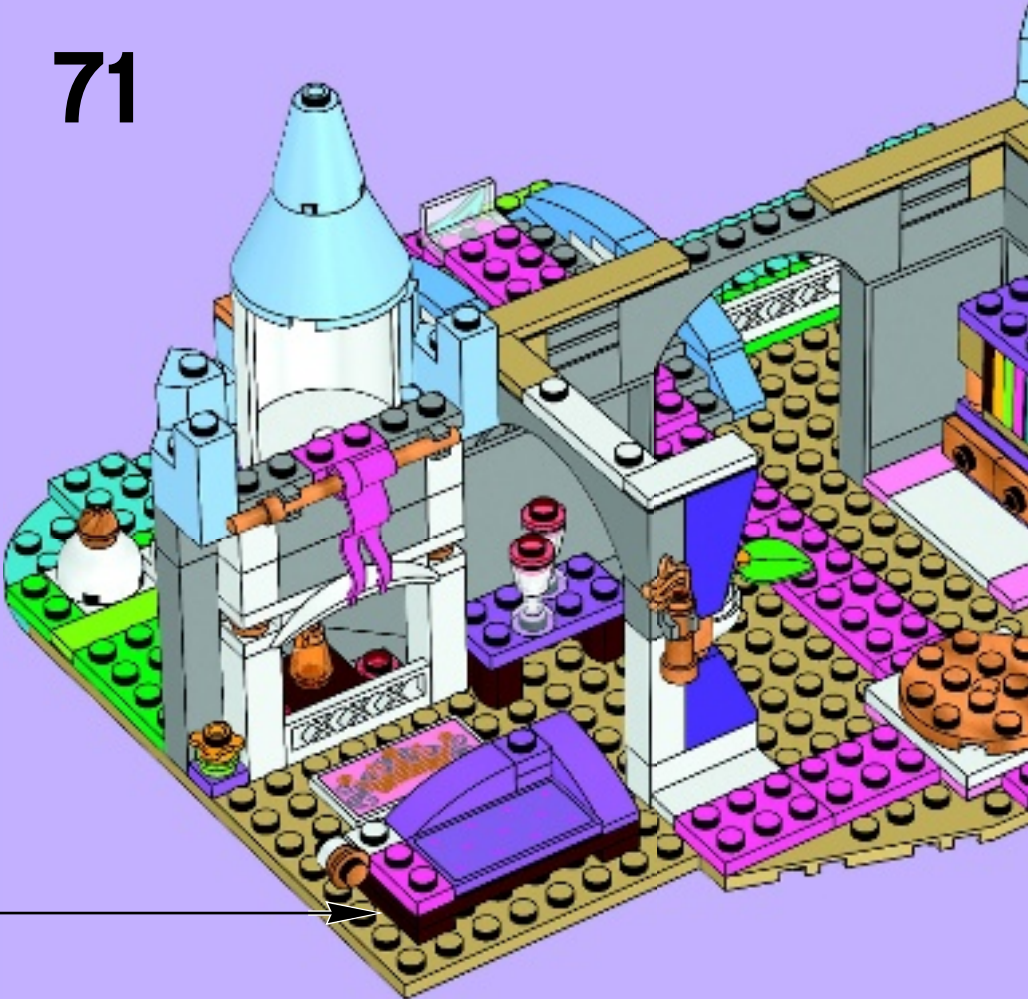



1

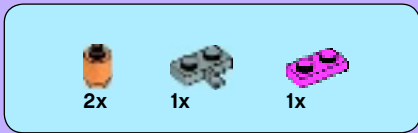
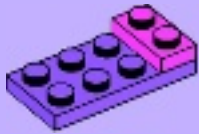

2

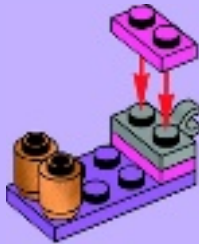

3

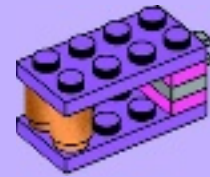

4

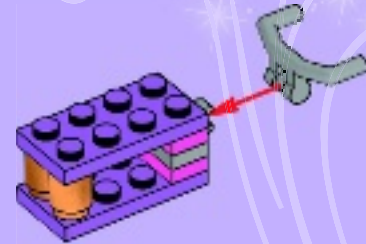



2x

5



2x

6

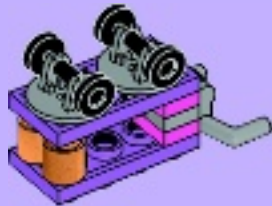

1x



2x



1x



1x



1x

7

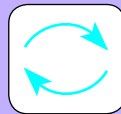
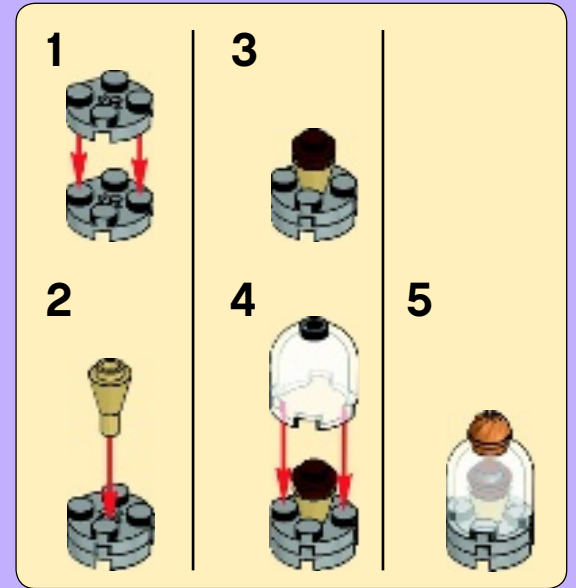

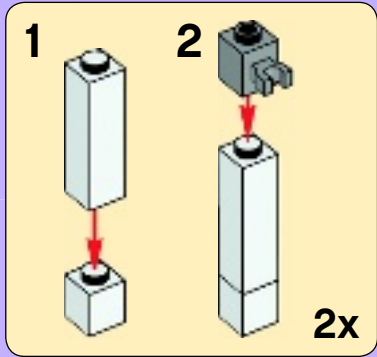

72

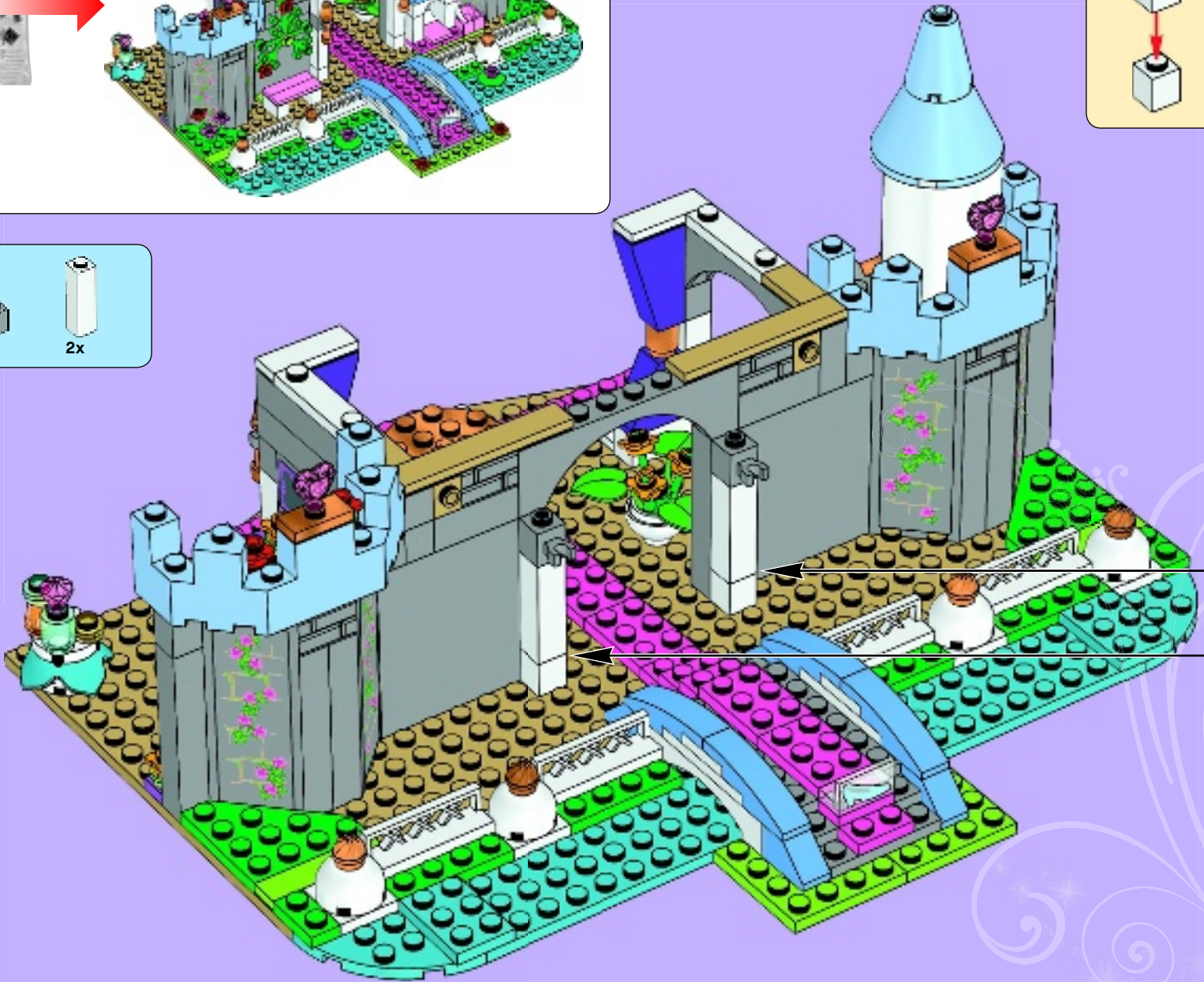
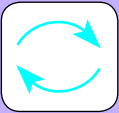

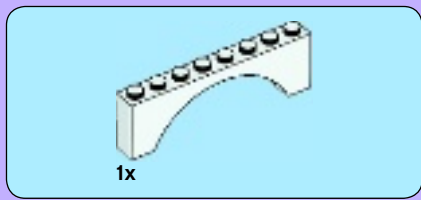

73

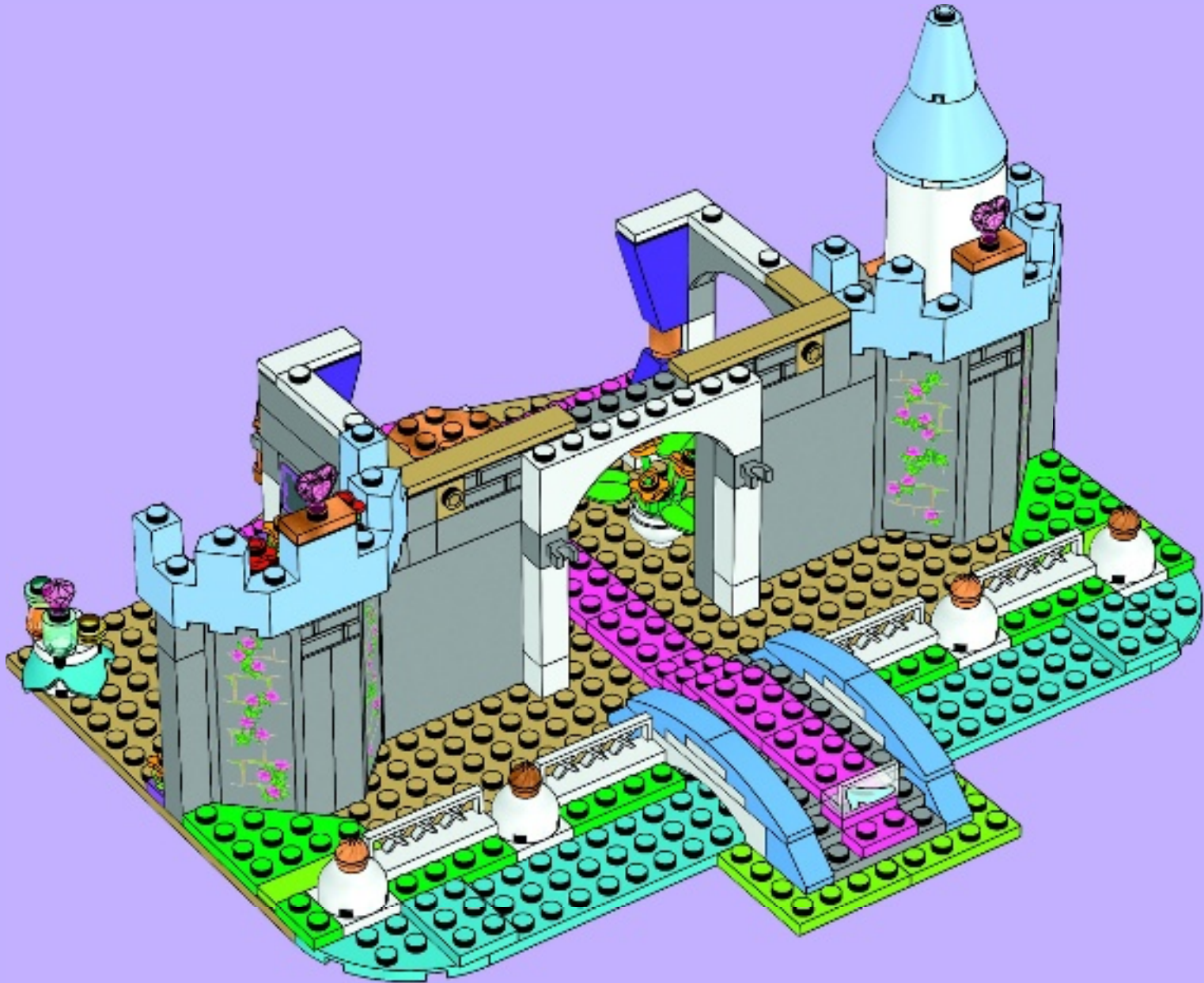



74

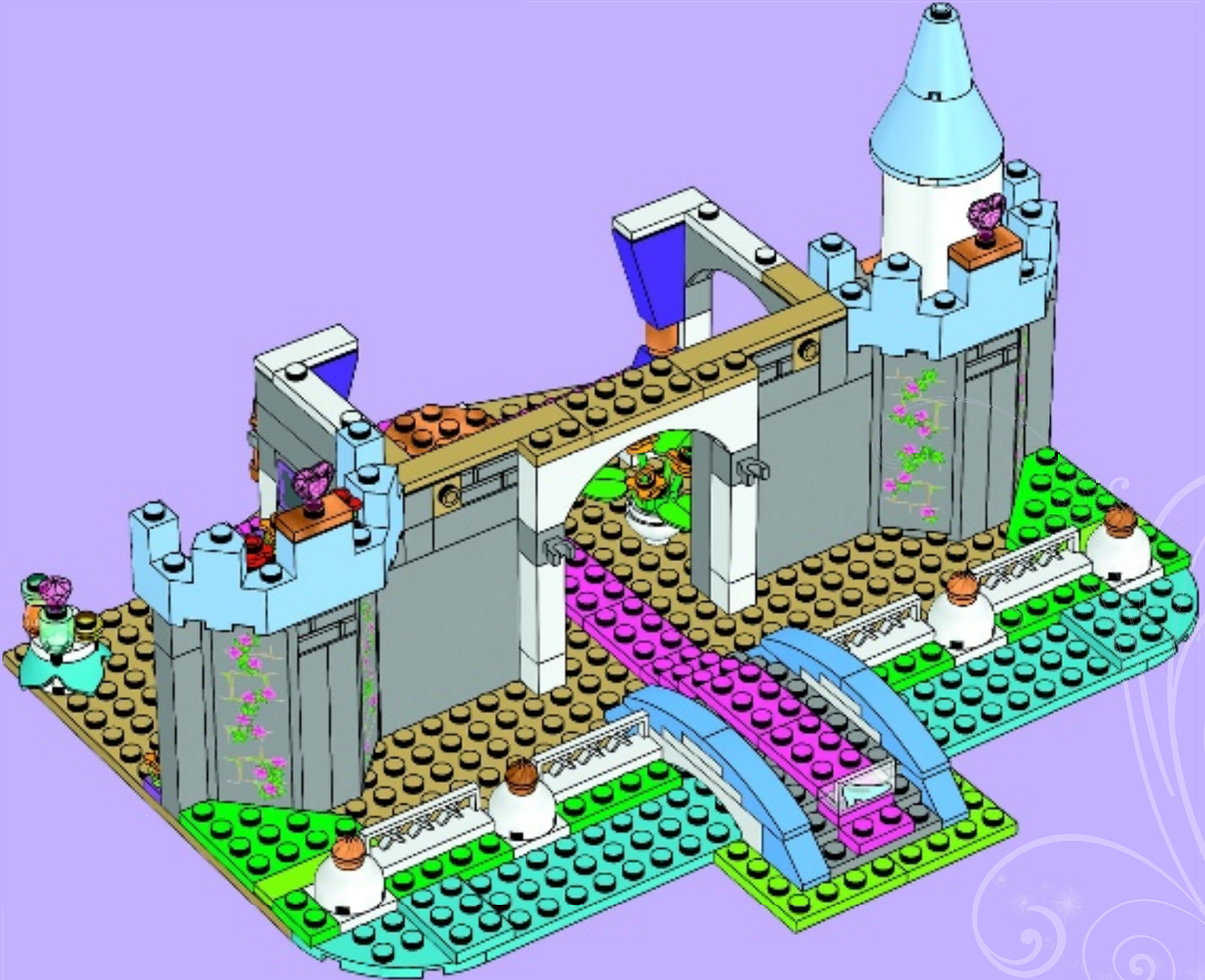



2x

75

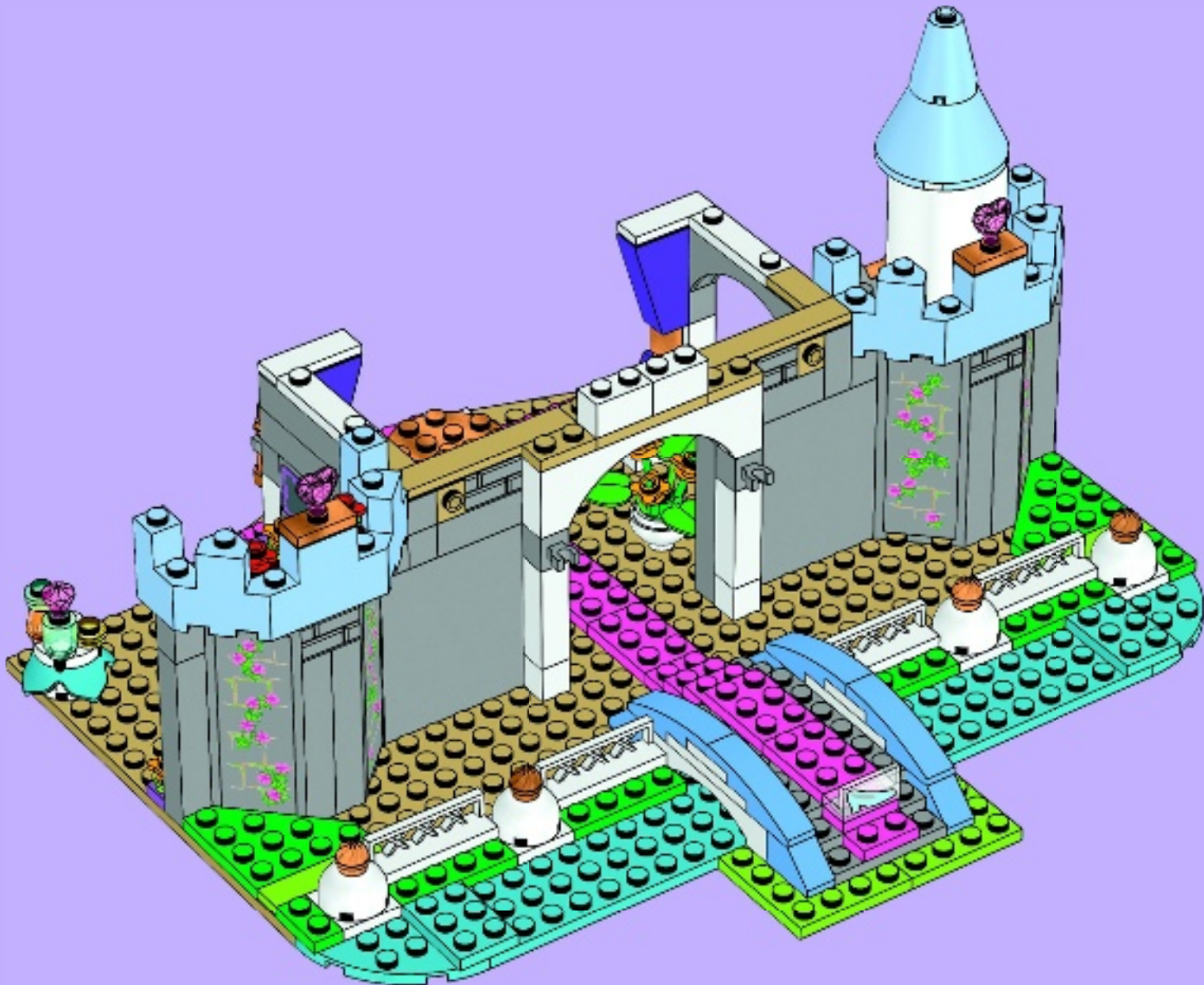



76

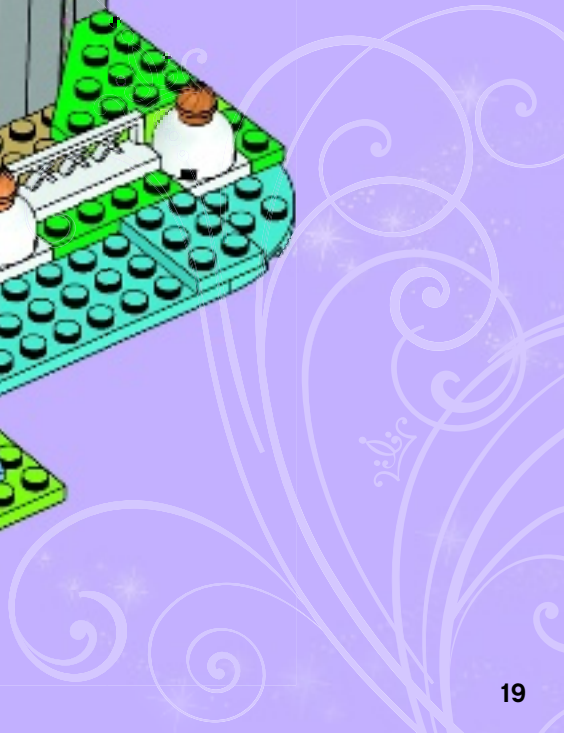
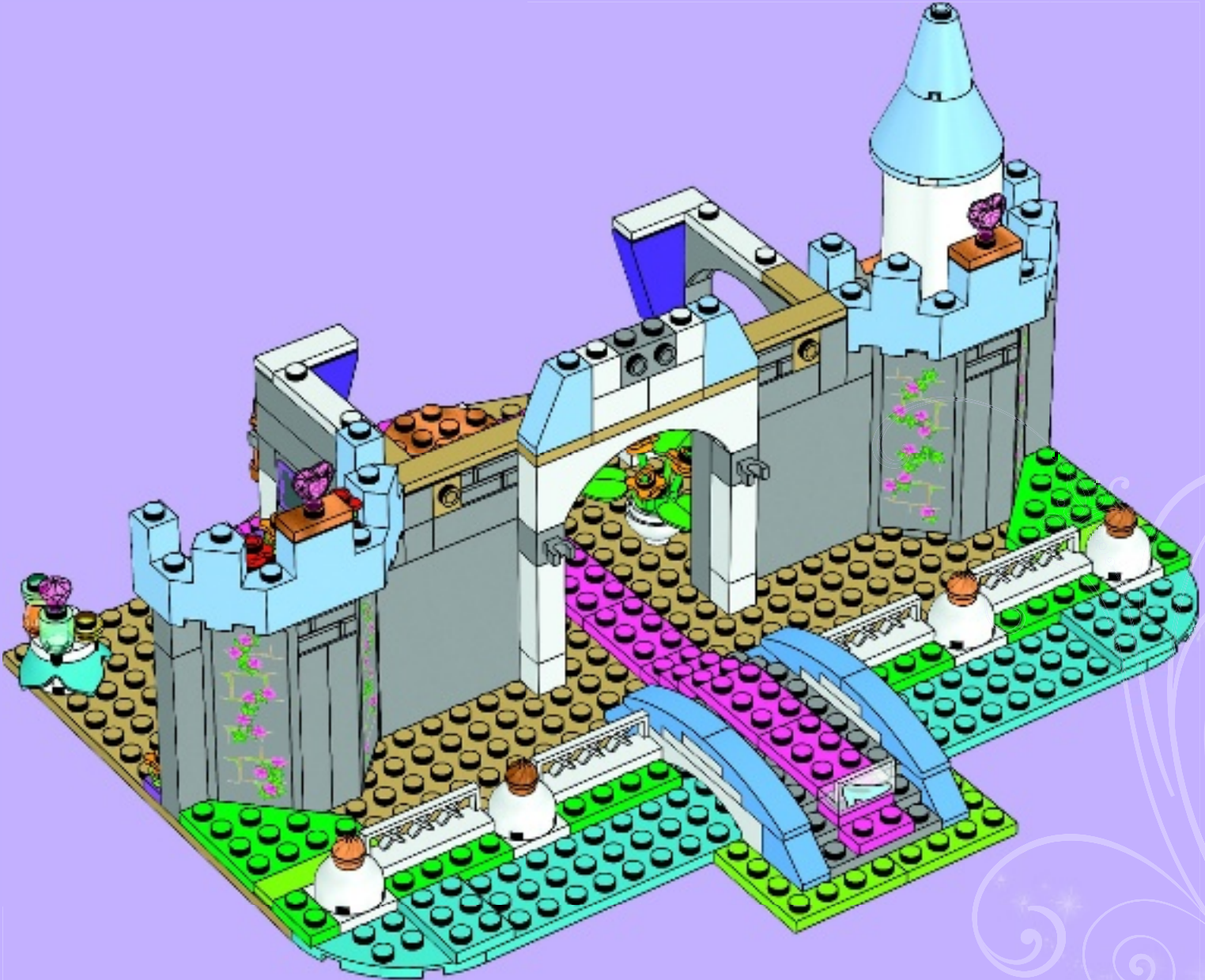



2x

77

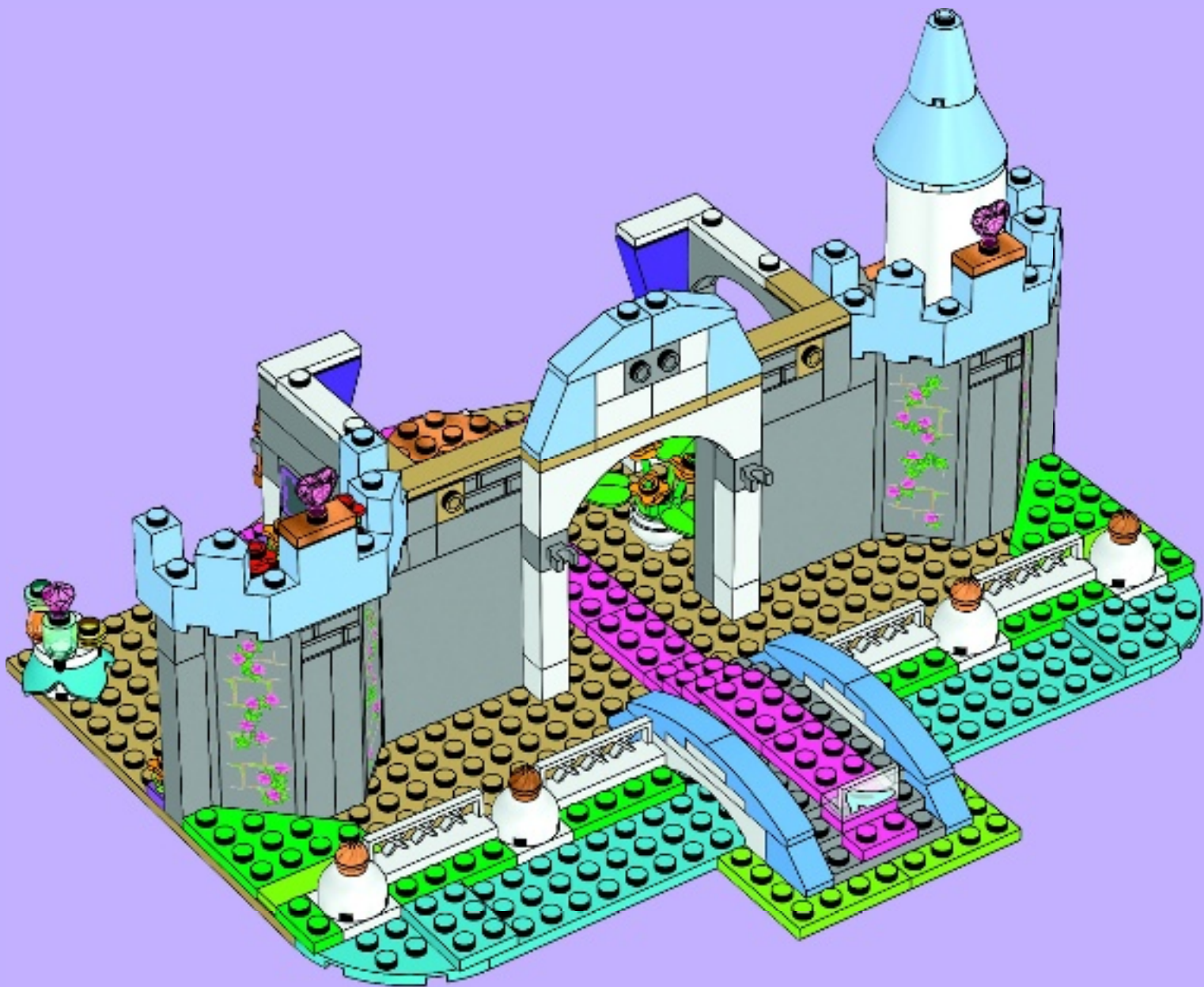

2x  1x 

78

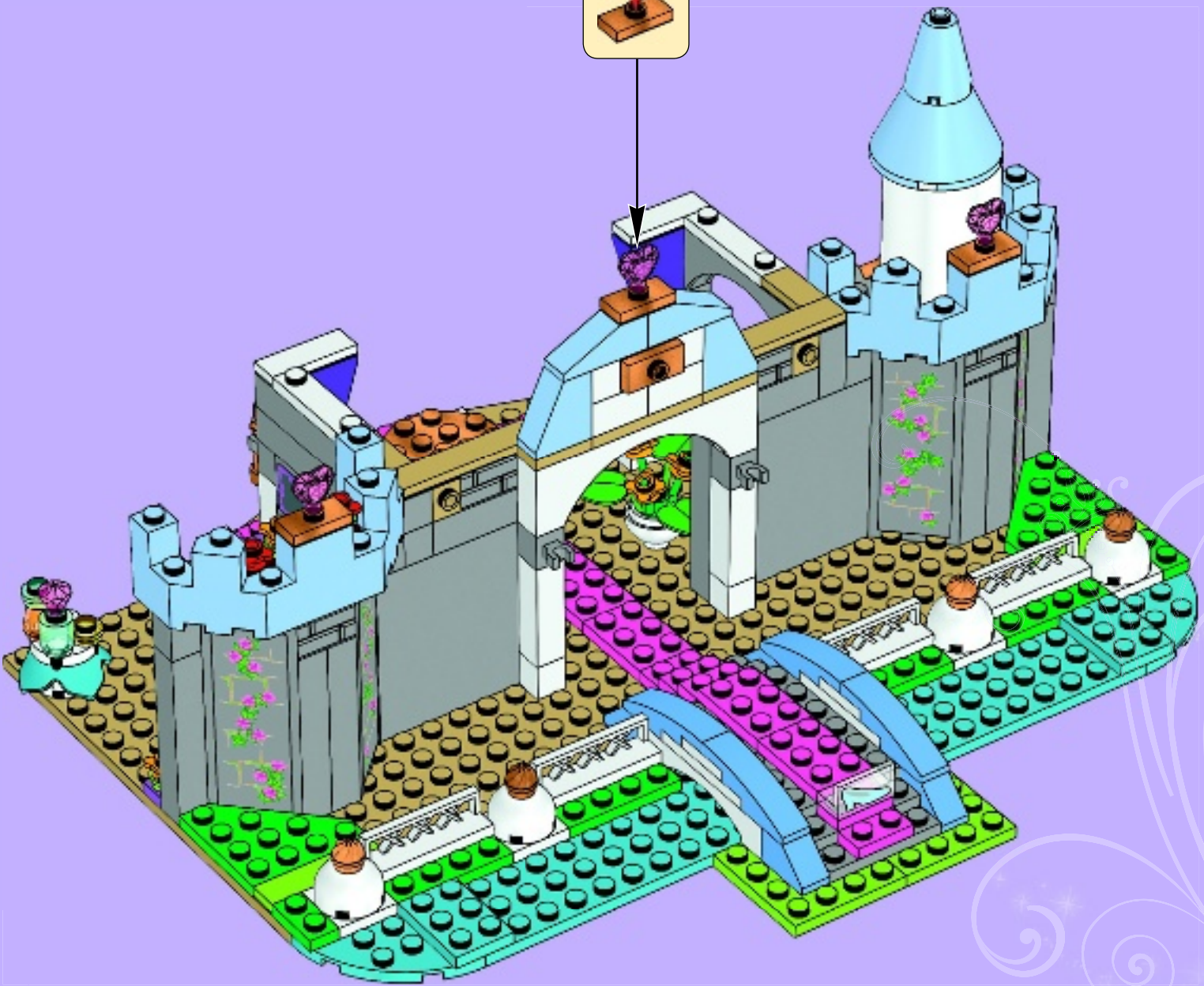

2x 2x 1x

79

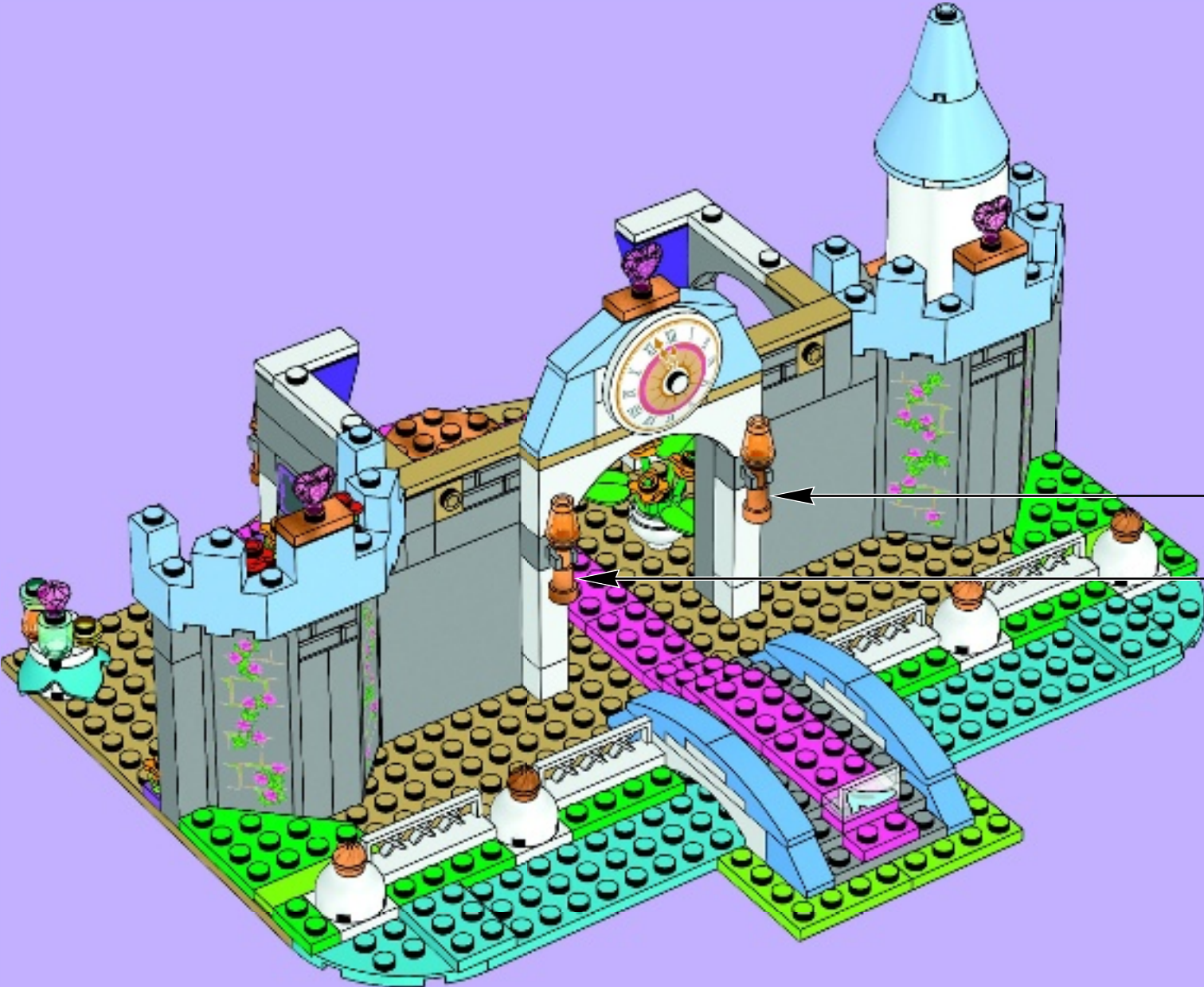

2x



80

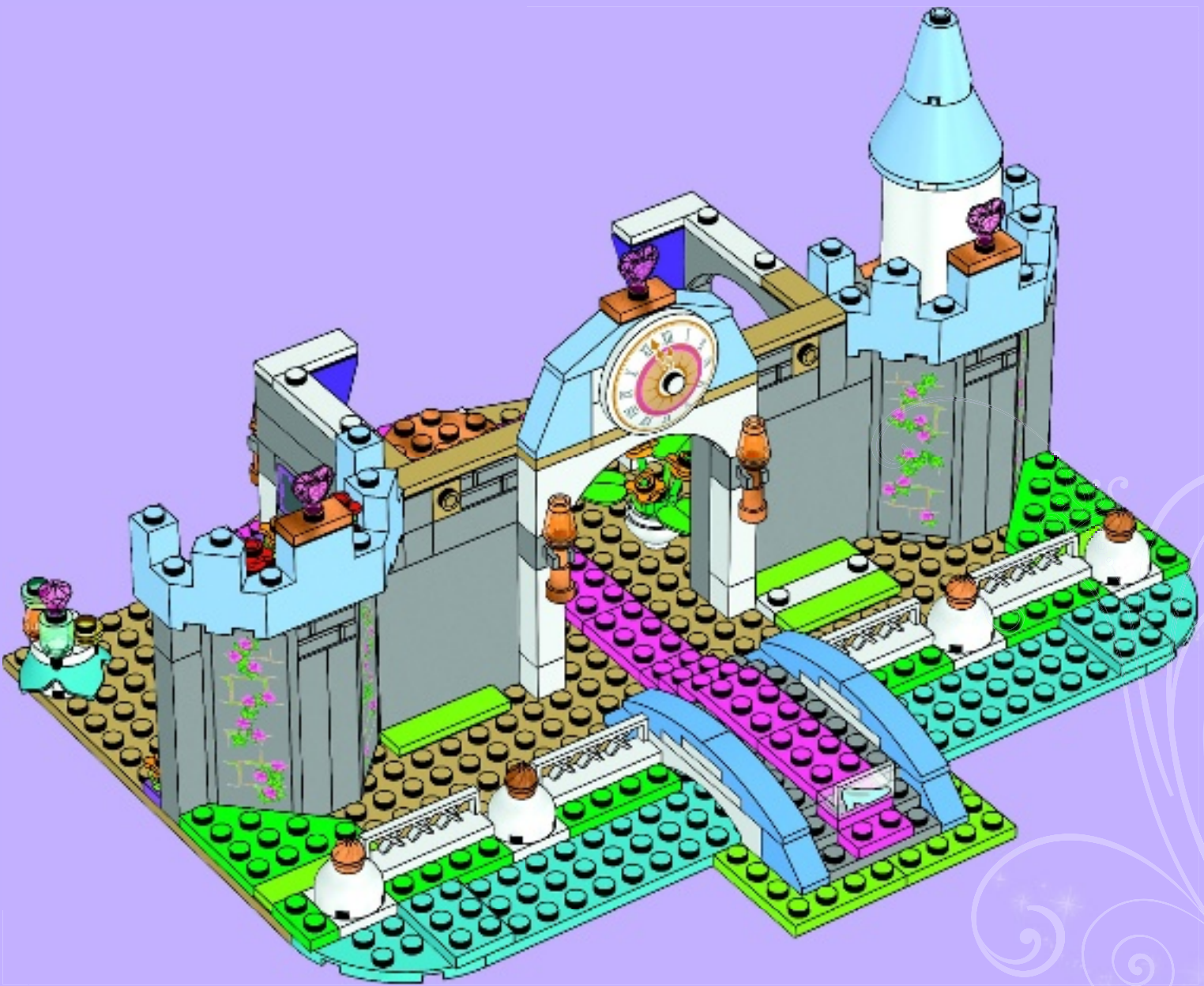

1x 4x 1x

81

1 2 3

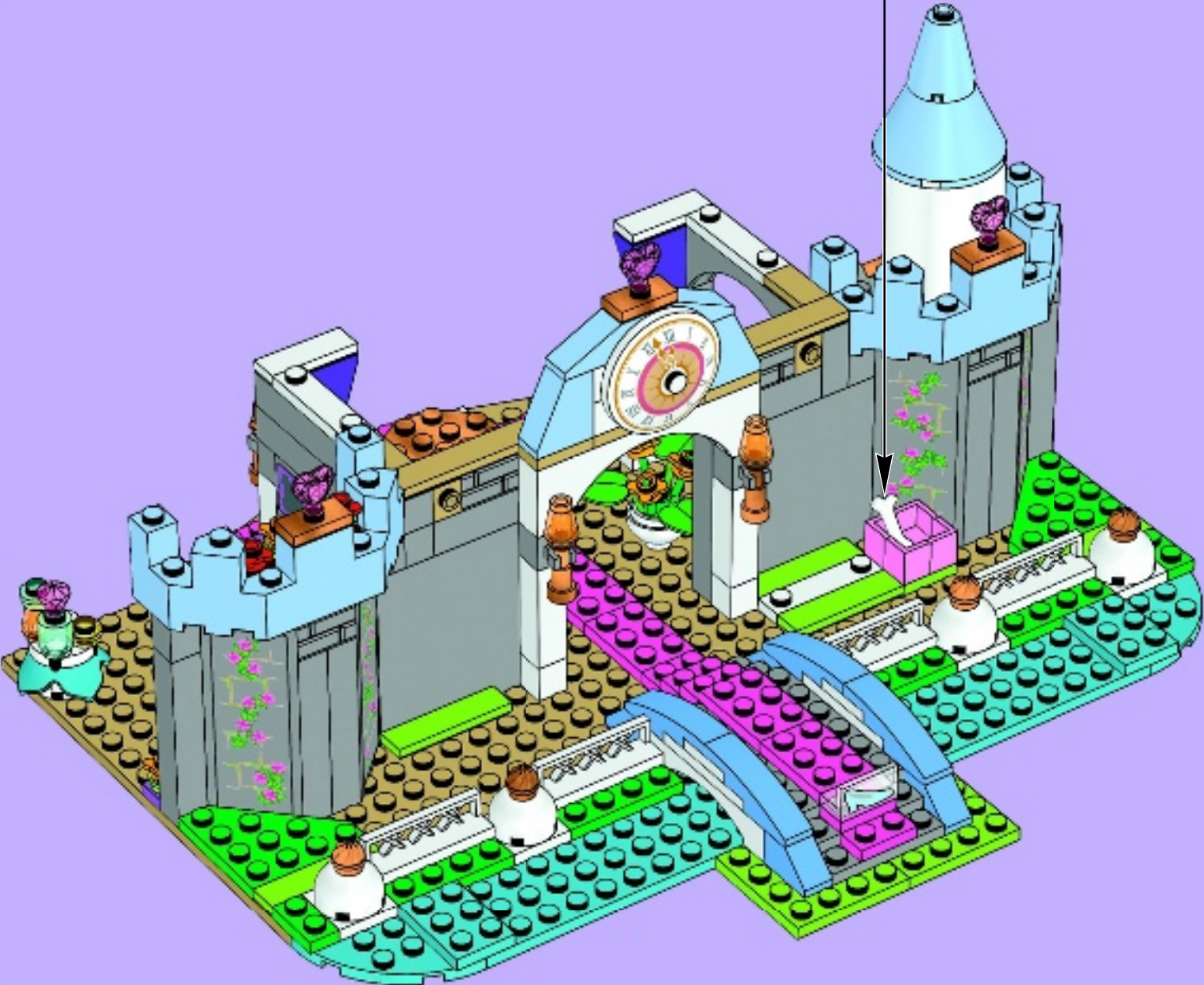

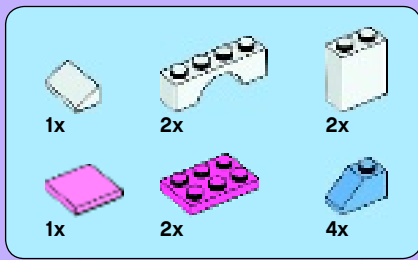

82

1

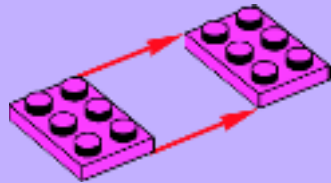

2



3

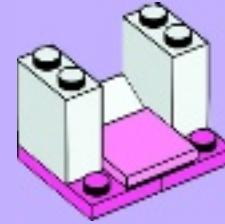

4

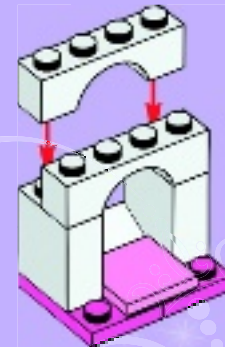

5

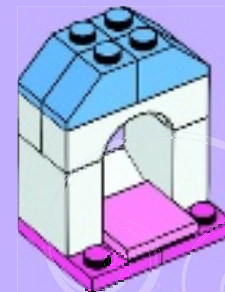

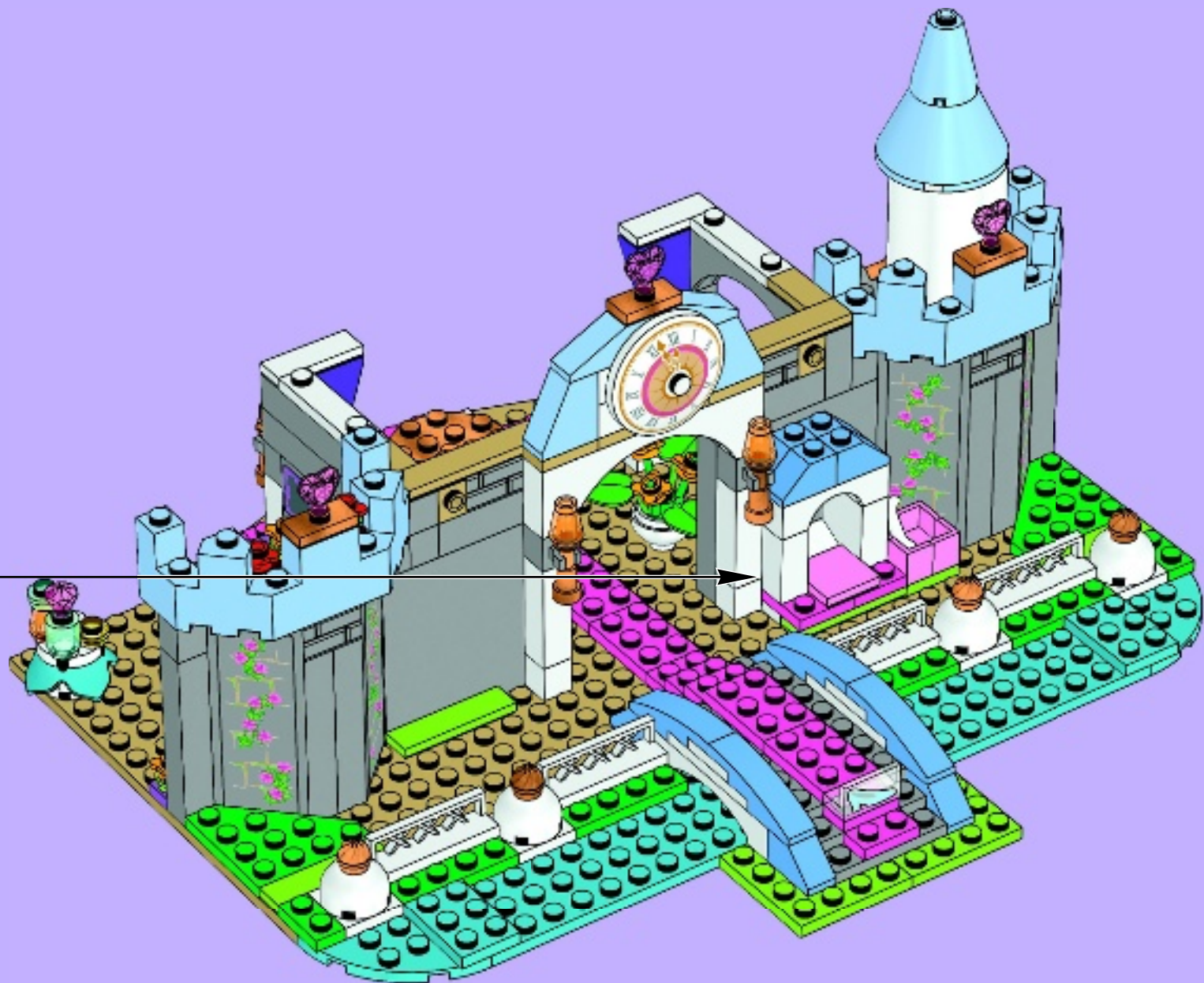

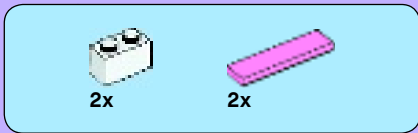

83

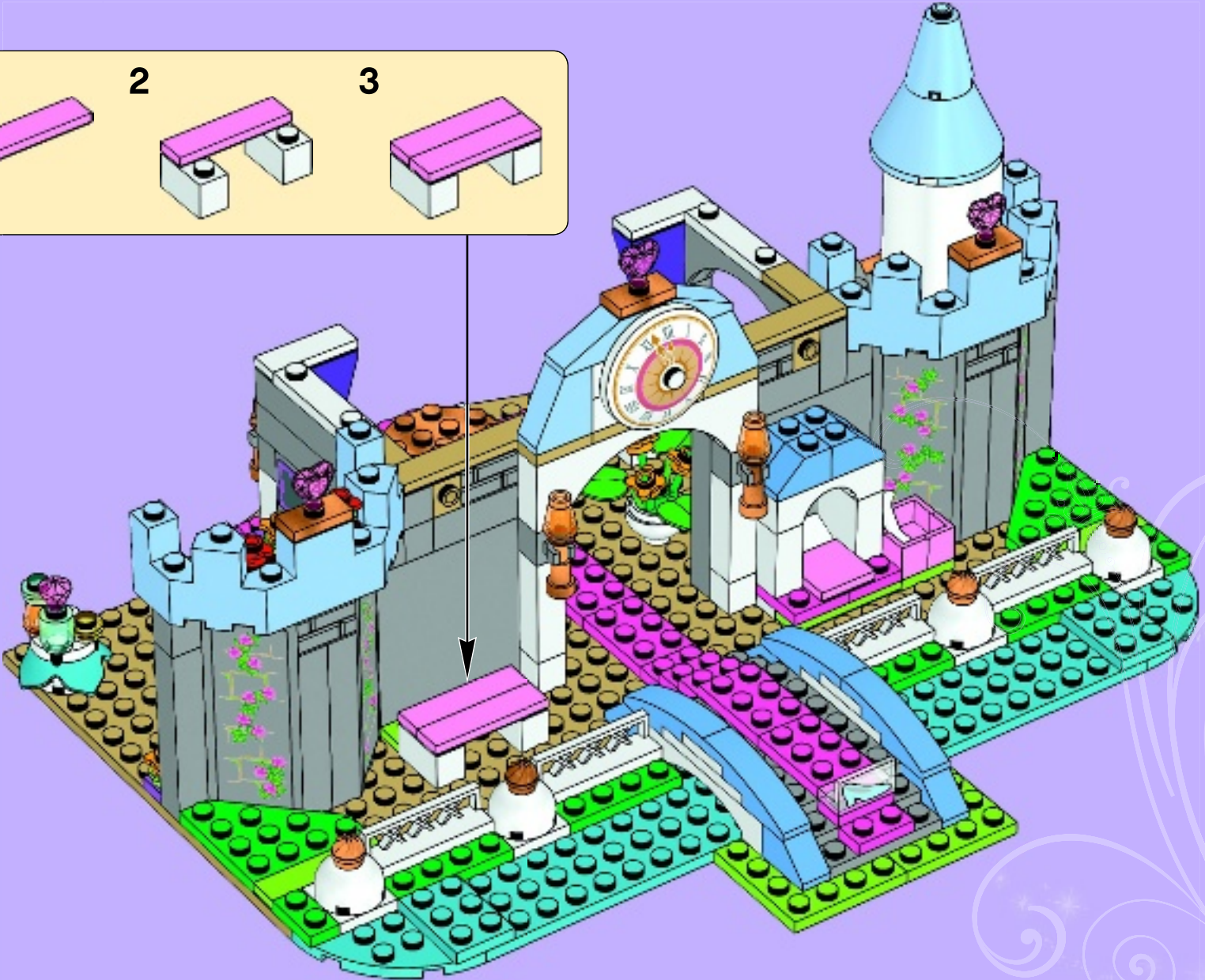
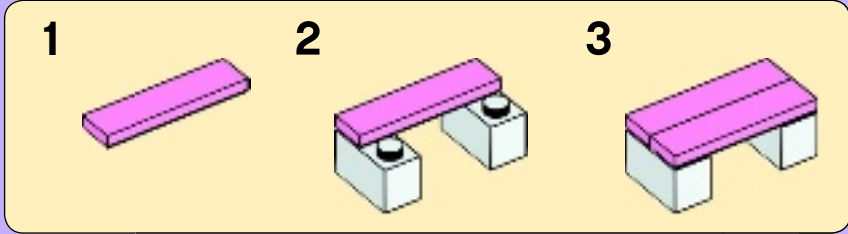

4x 2x 2x 2x

84

1 2

2x

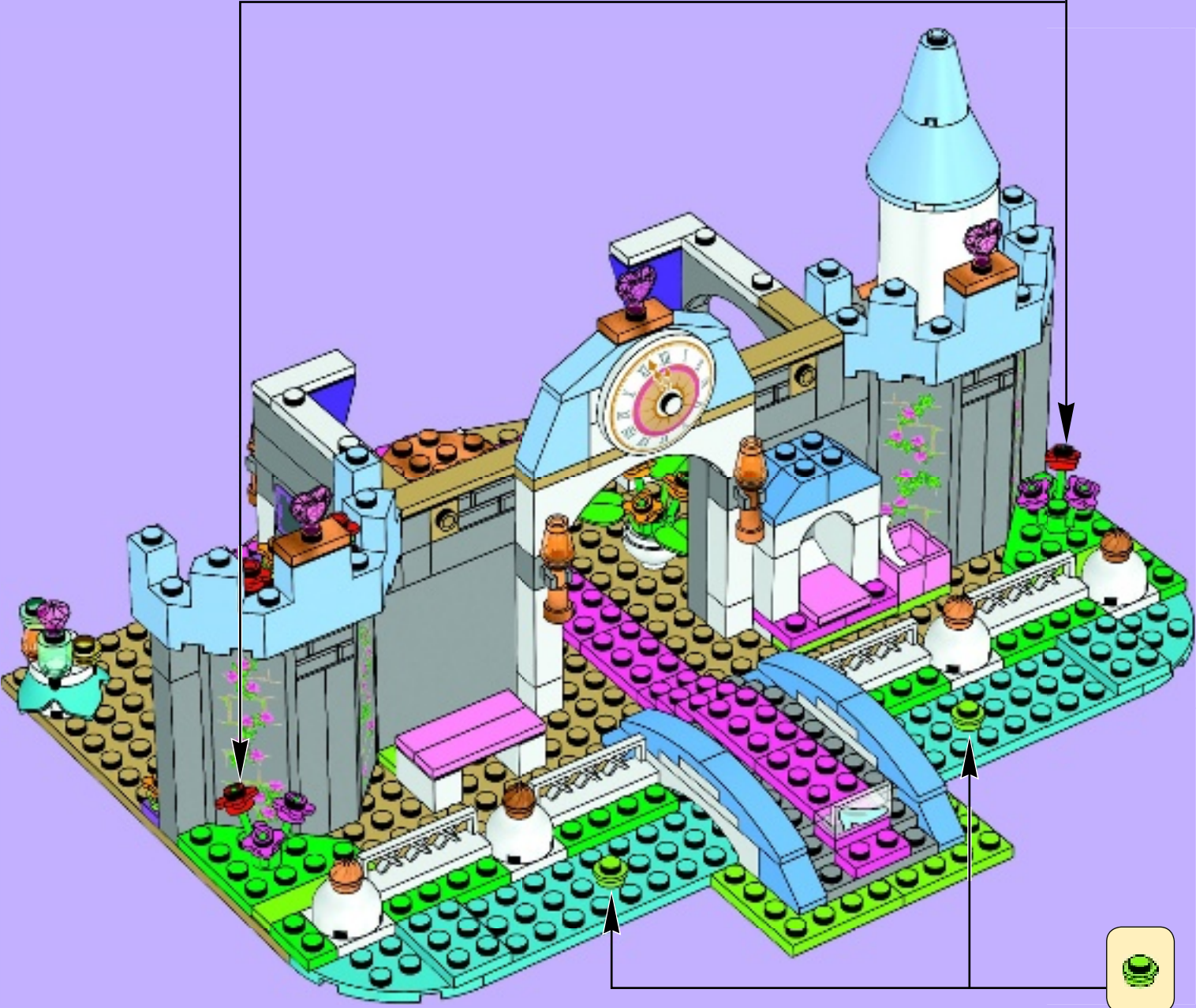

 2x
  2x
  2x

85

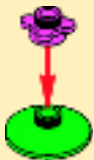
 2x





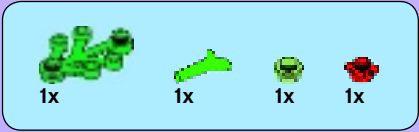

86

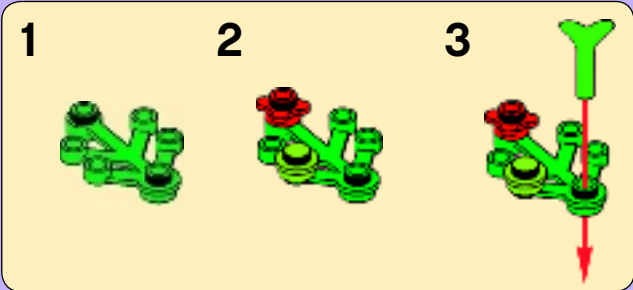

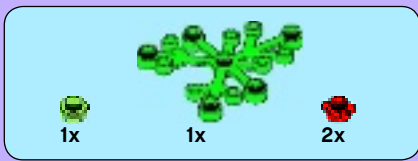

87

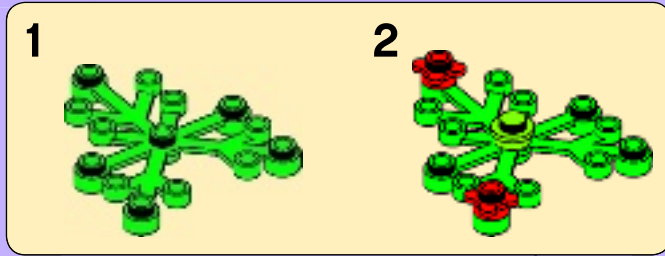

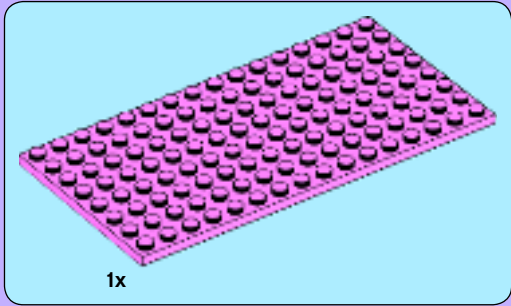
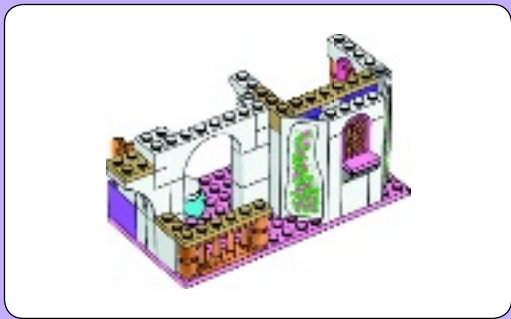

1

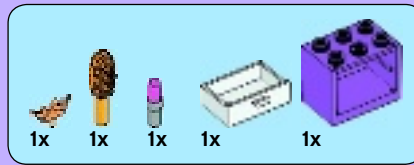
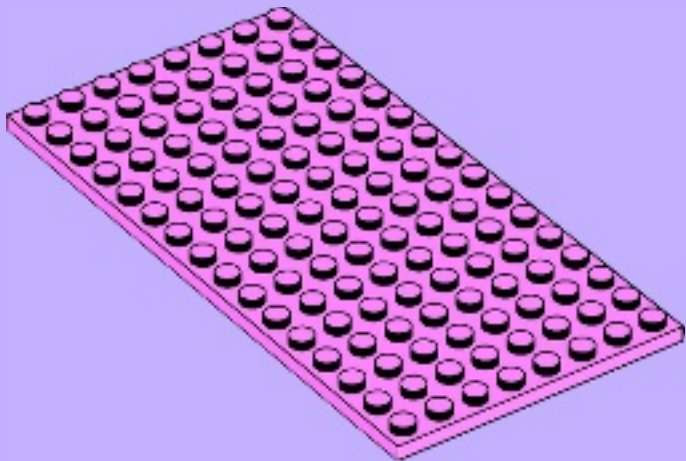

2

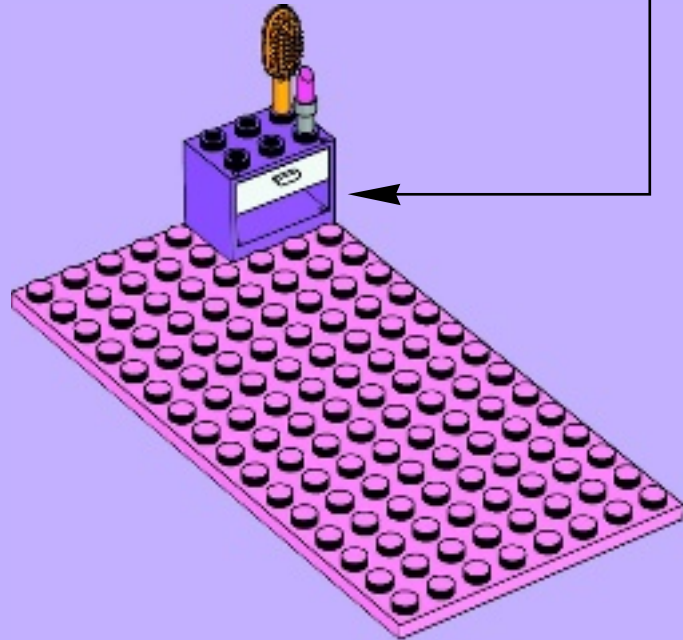
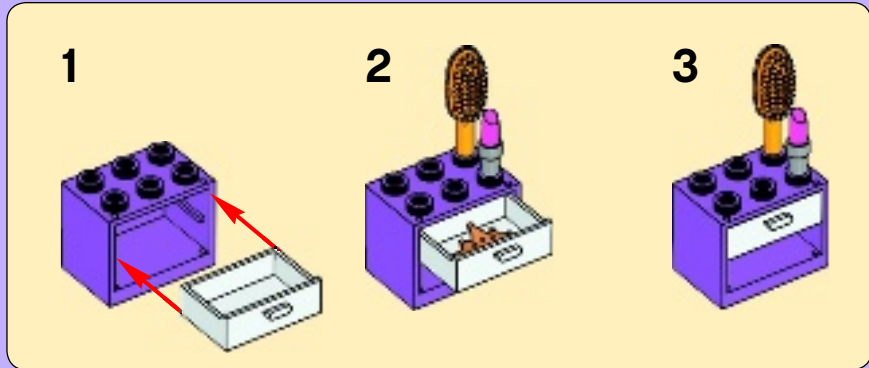

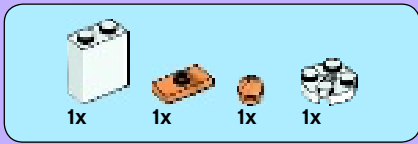

3

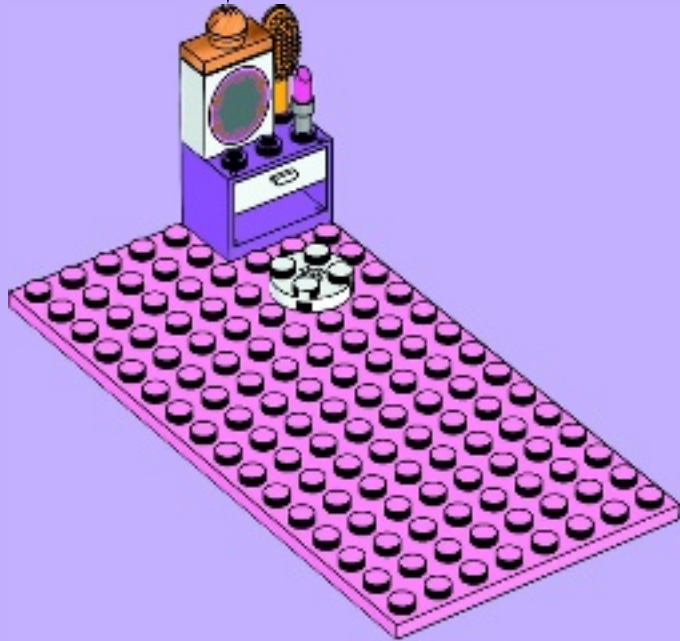
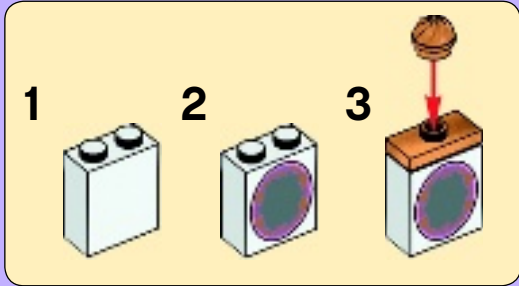

4

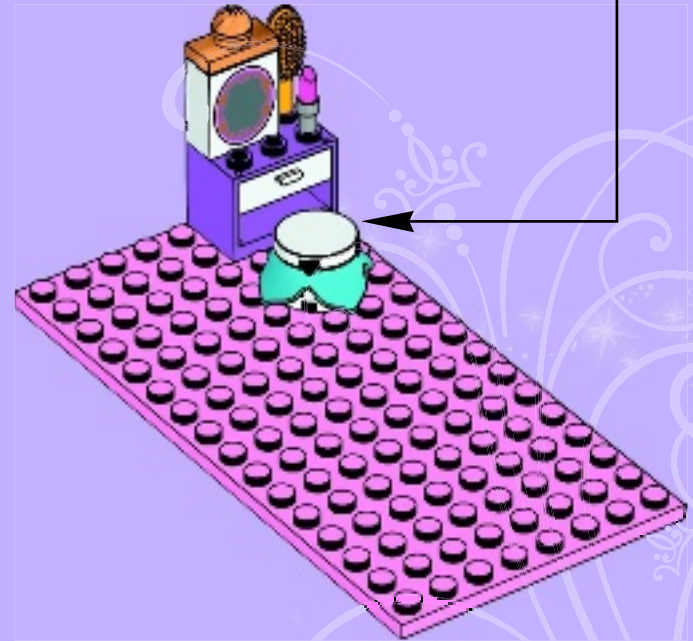
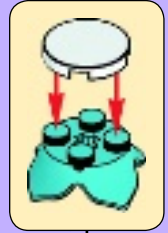

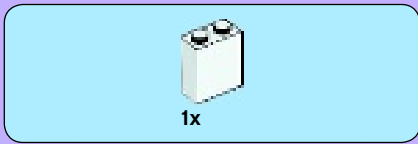

7



8

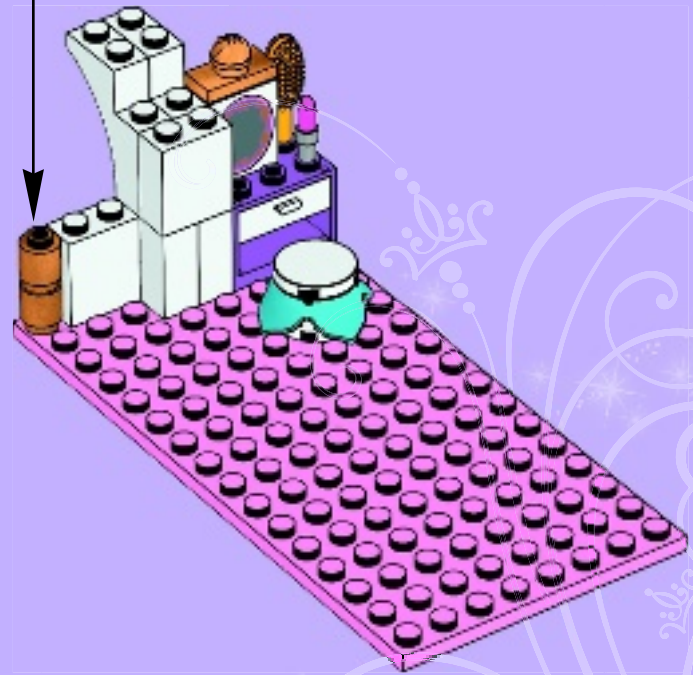

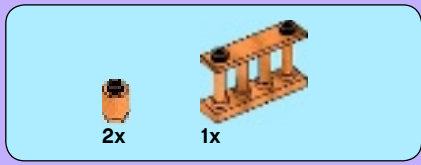

9

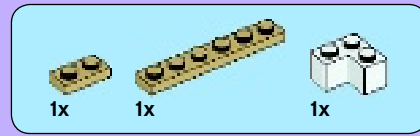
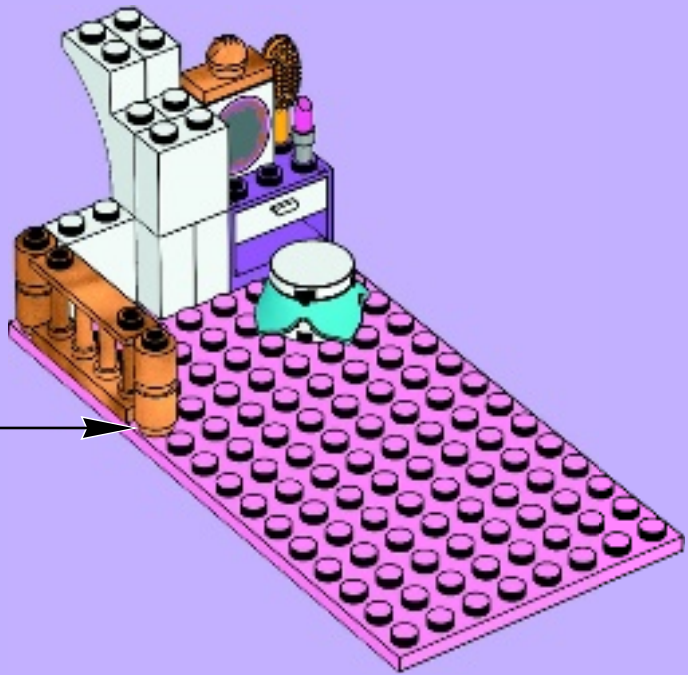

10

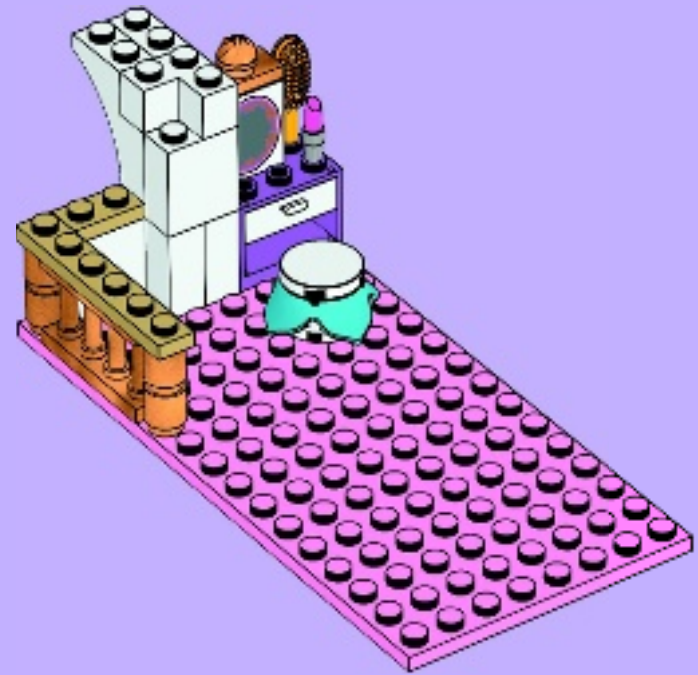

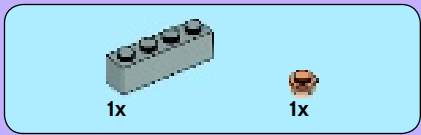

13

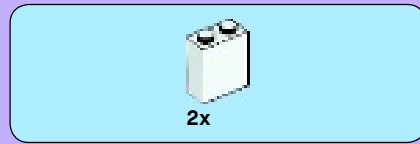
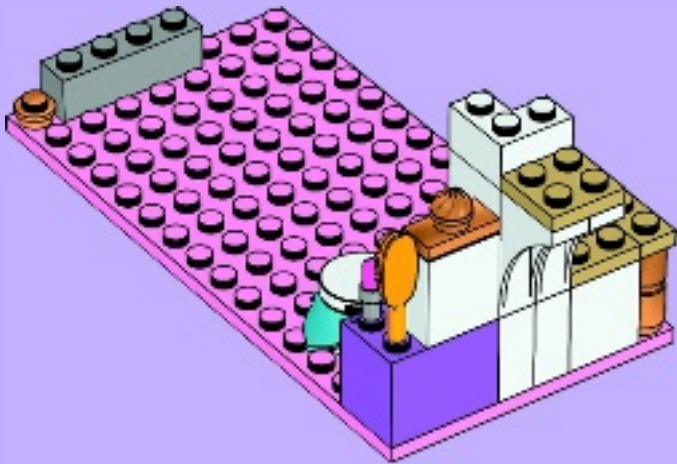

14

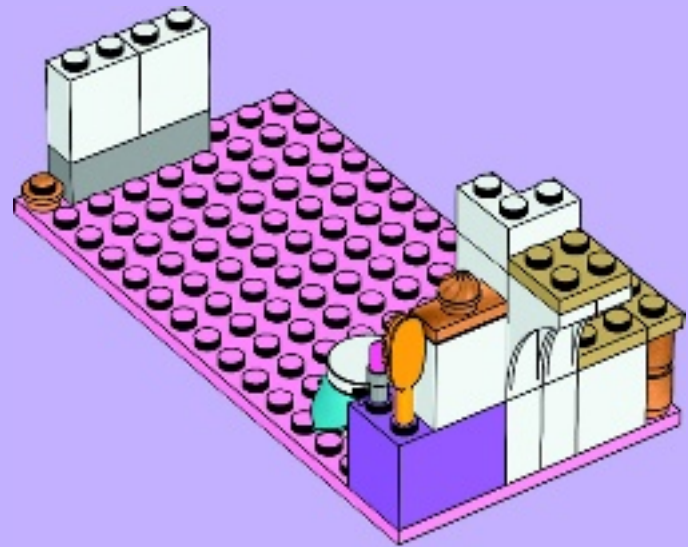



15

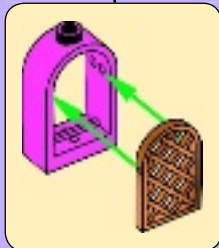

16

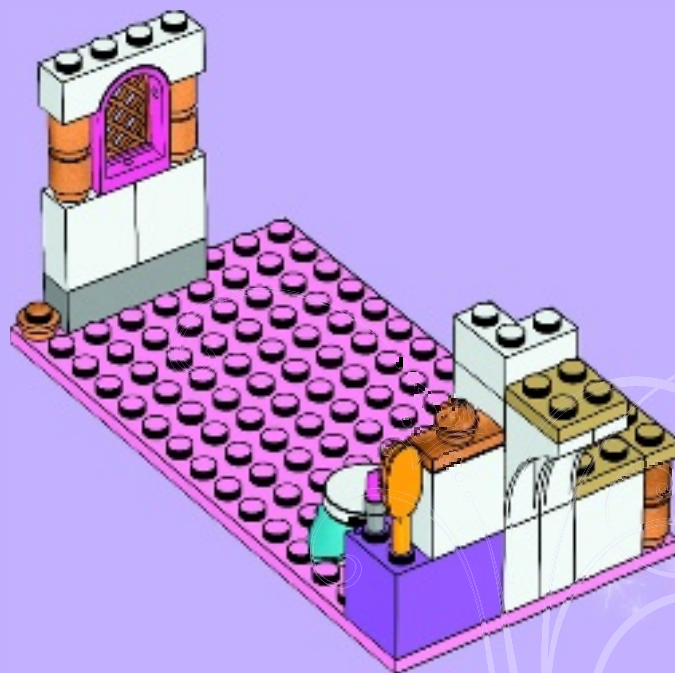

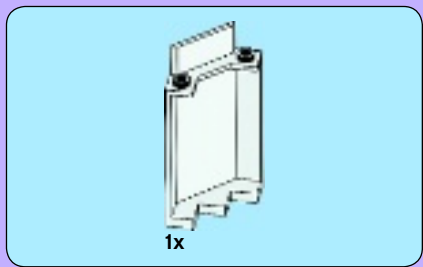

17

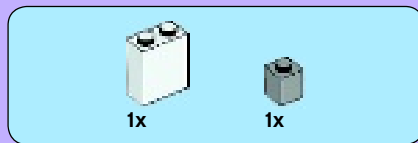
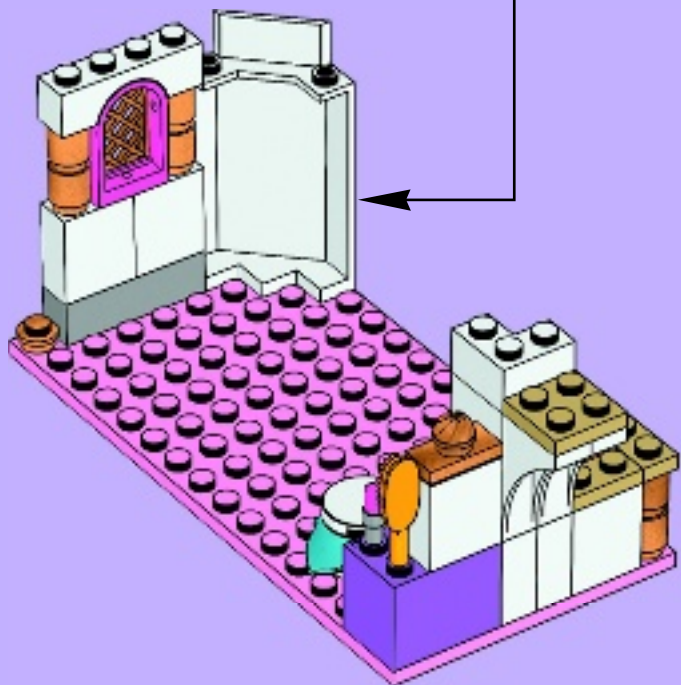
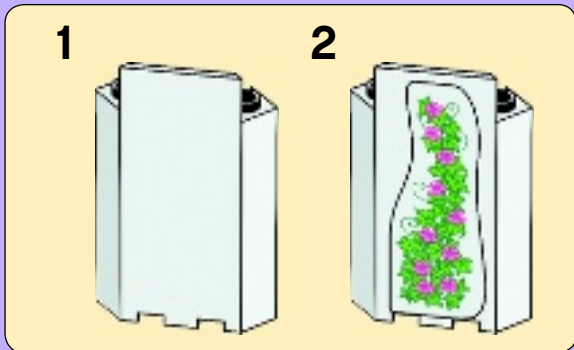

18

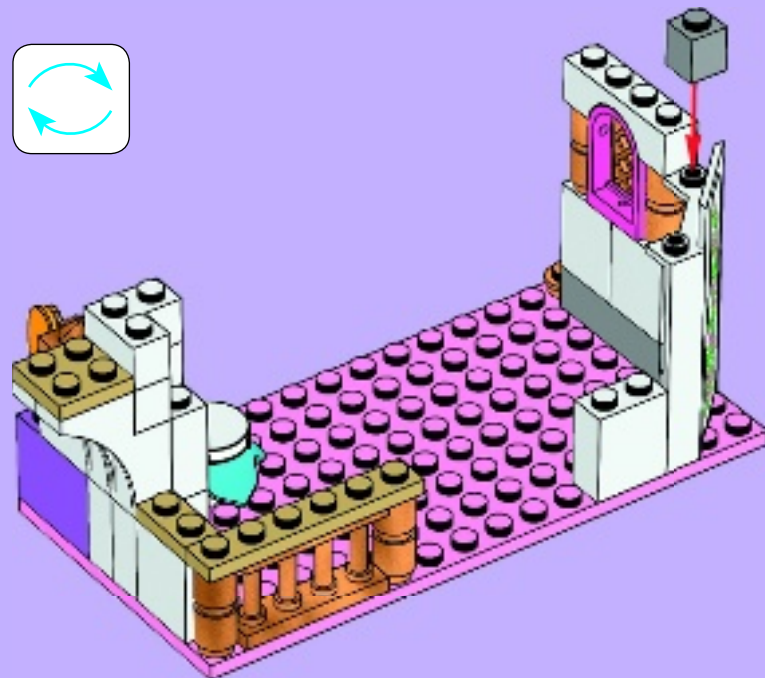
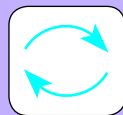



19

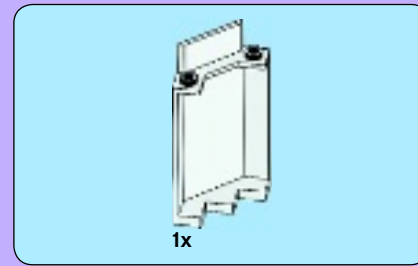
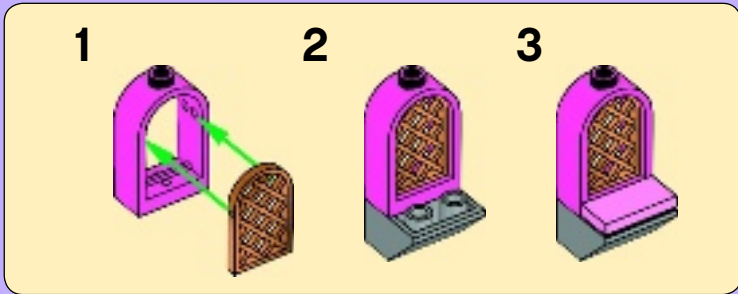

20

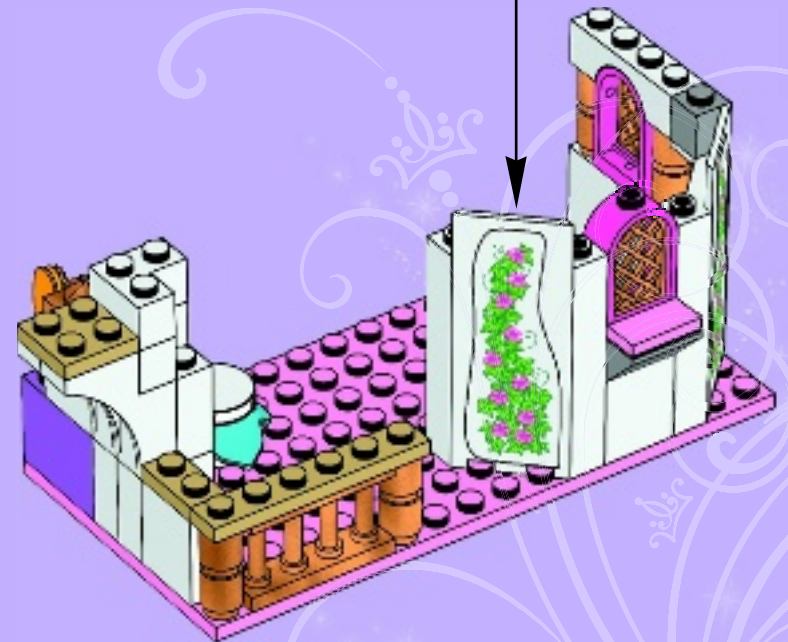
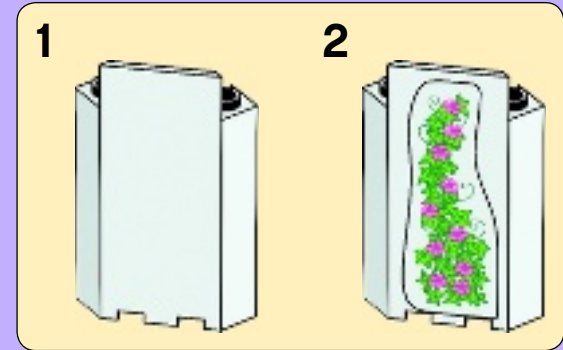

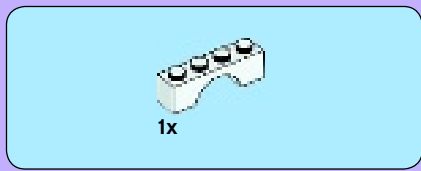

21

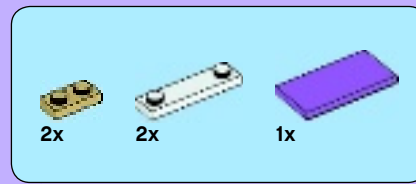
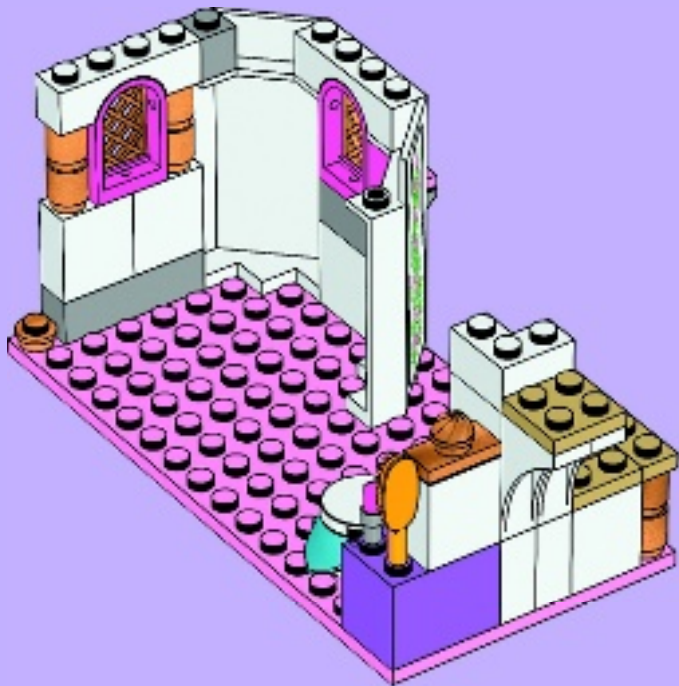
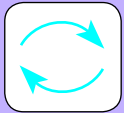

22

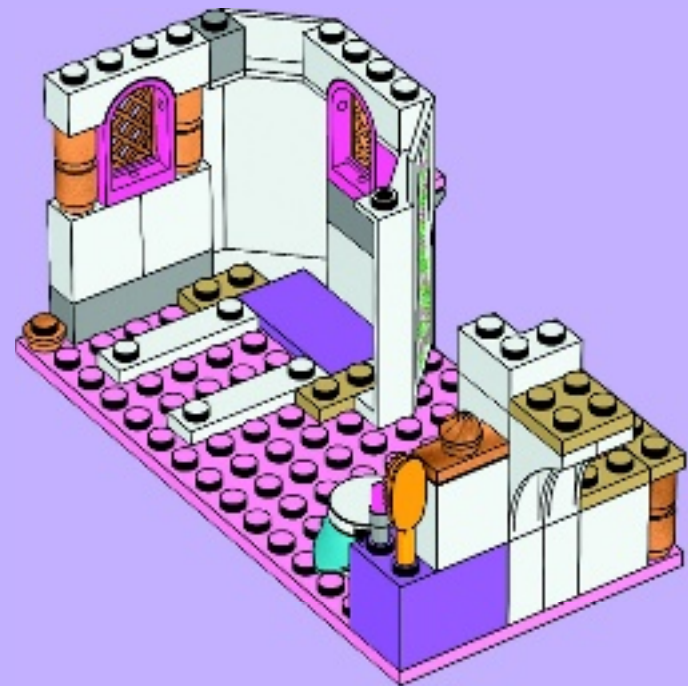



23

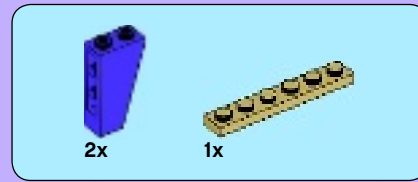
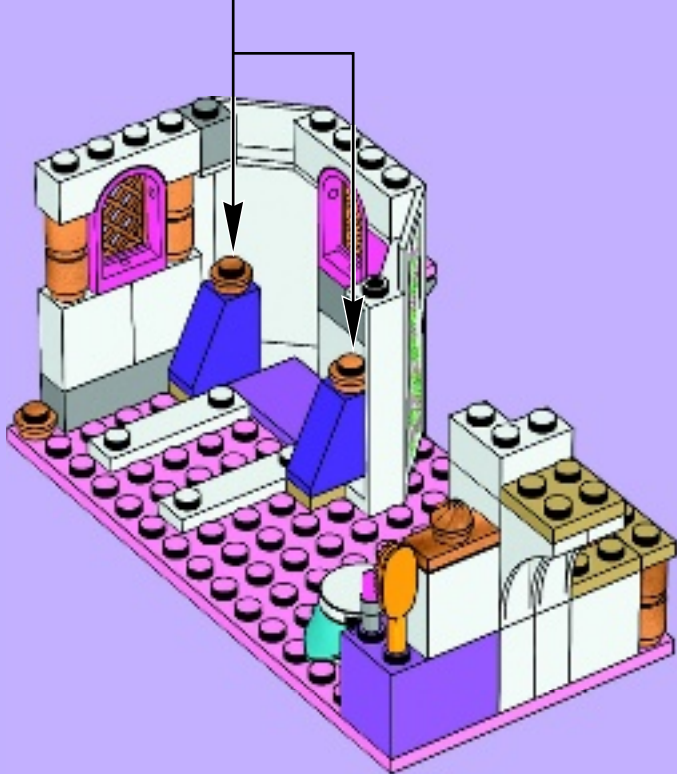
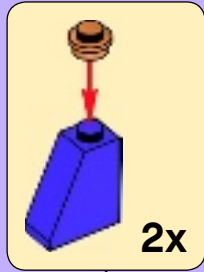

24

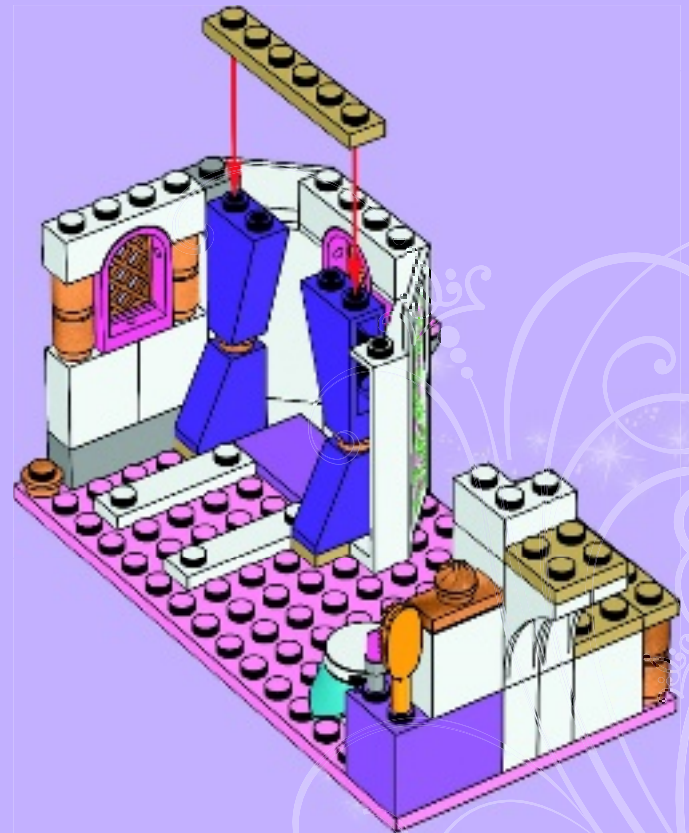

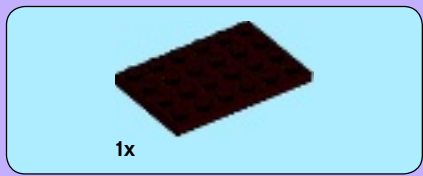

1



2

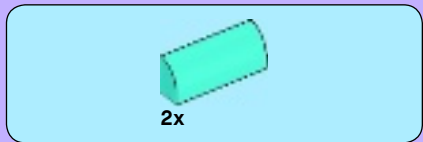
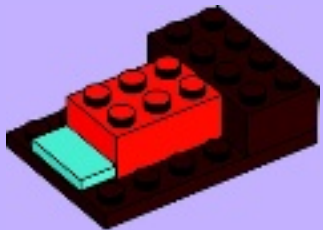

3



4

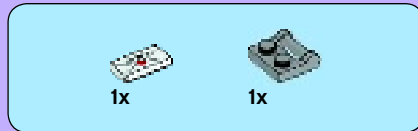
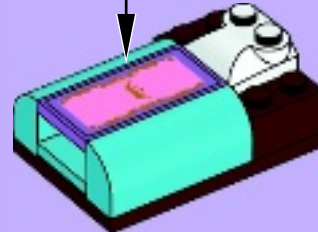
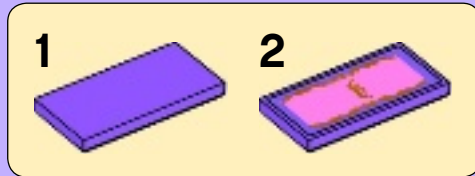

5

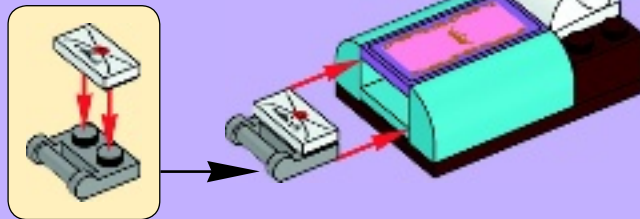

25

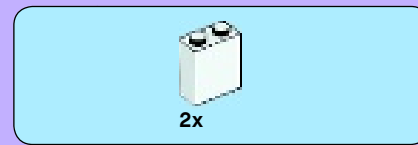
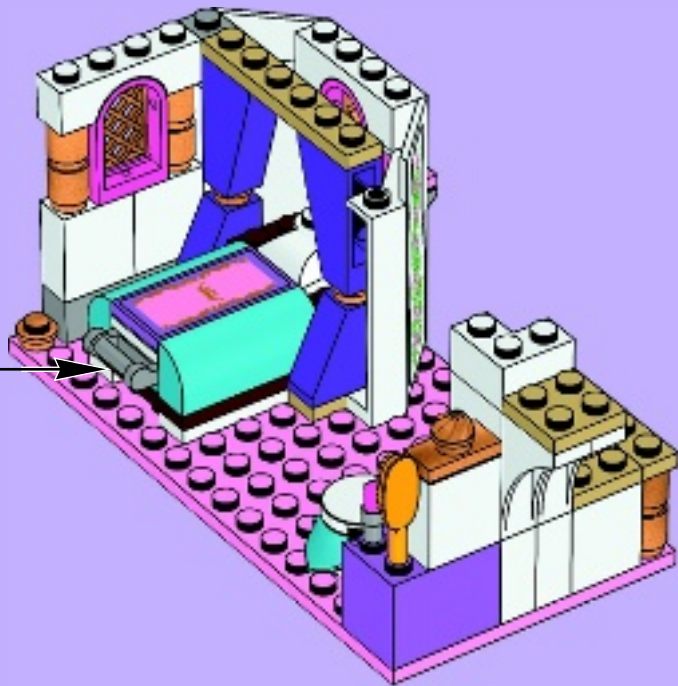

26





1x

27

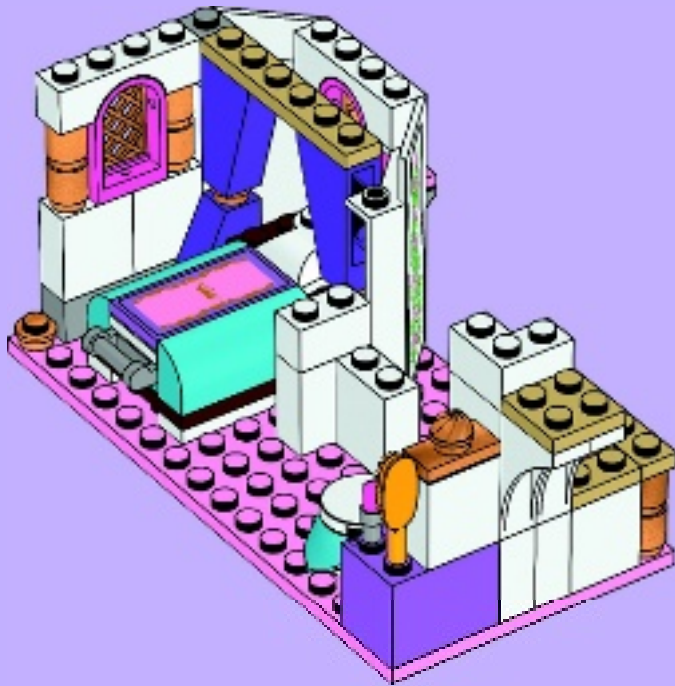

1x



1x

28

1



2

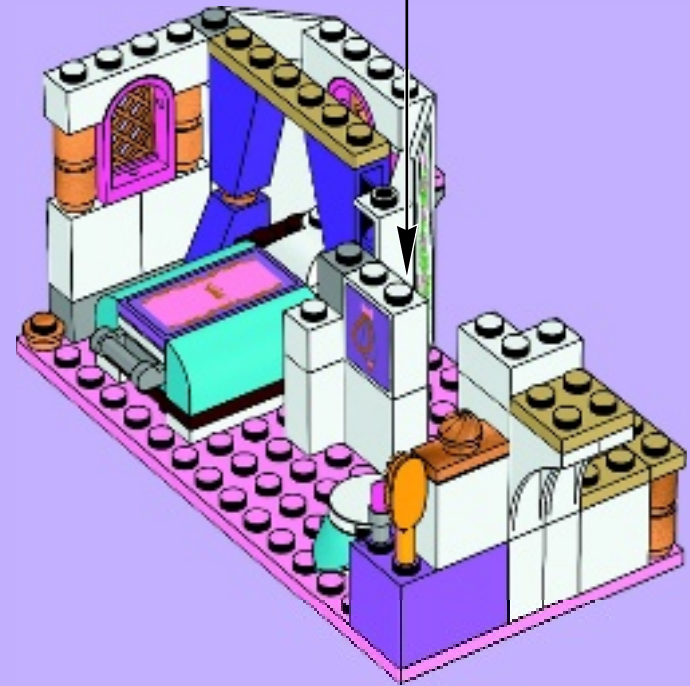

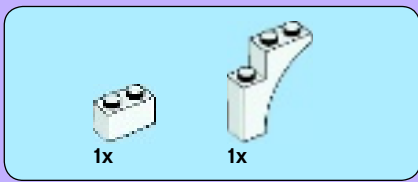

29

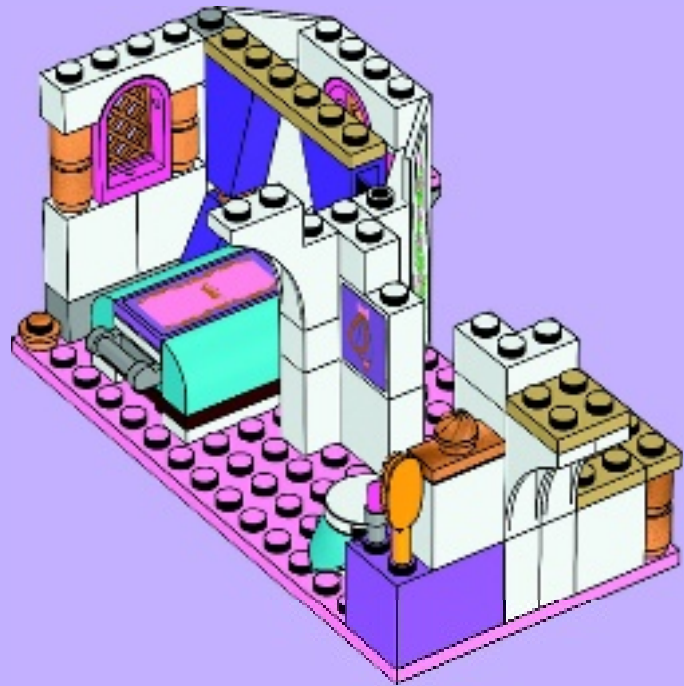

30

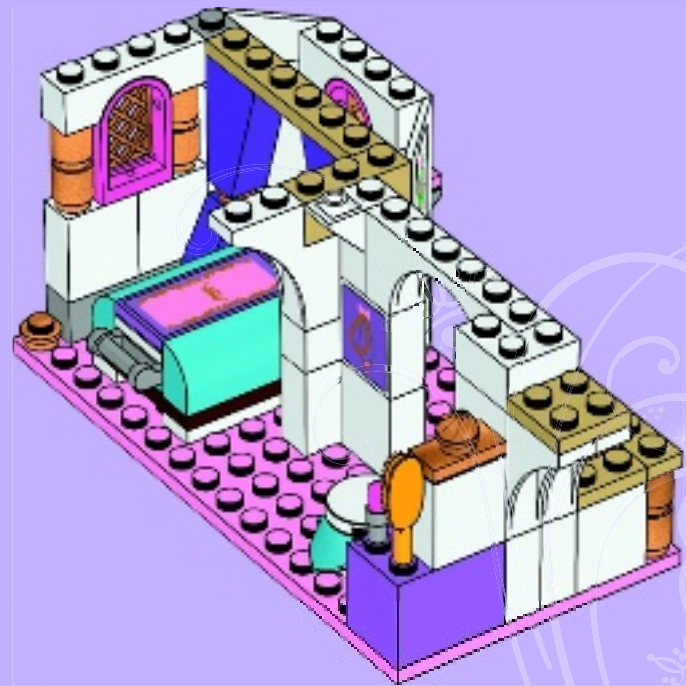



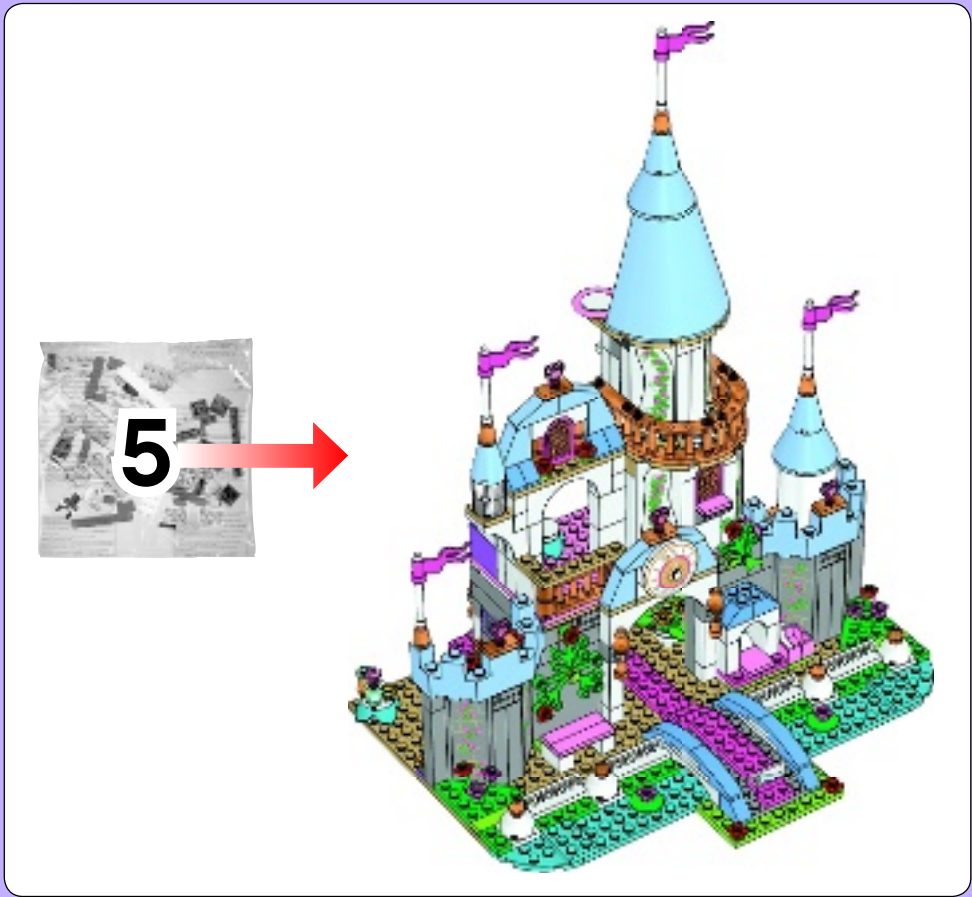

1

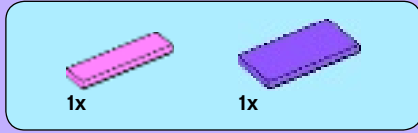

2

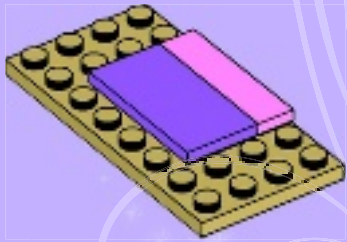



1x



1x

3

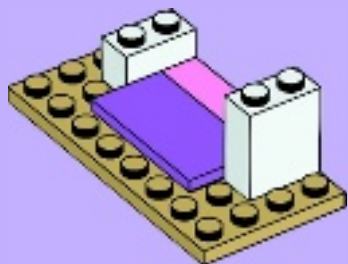

2x

4

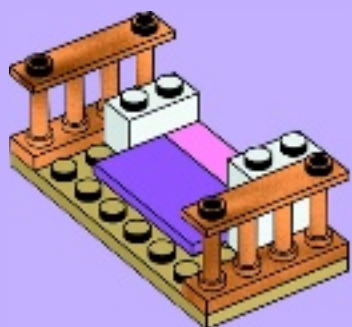

1x

5

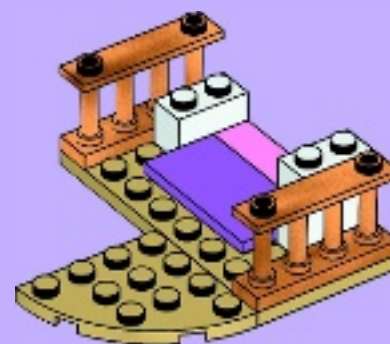

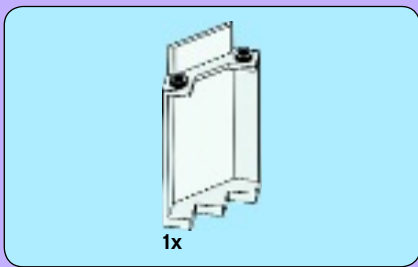

6

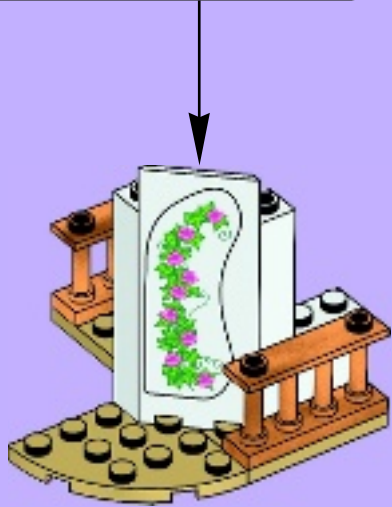
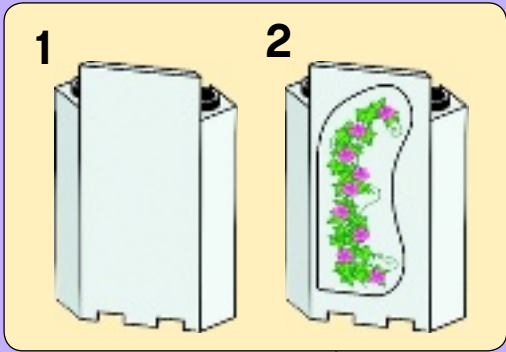

7

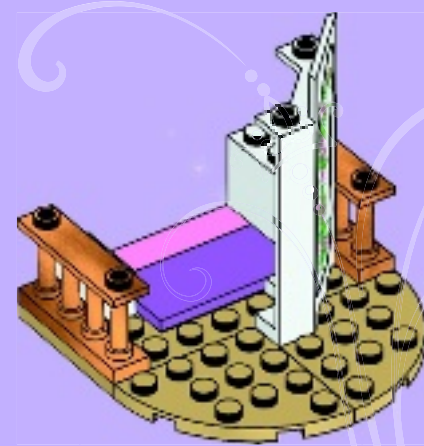
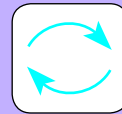

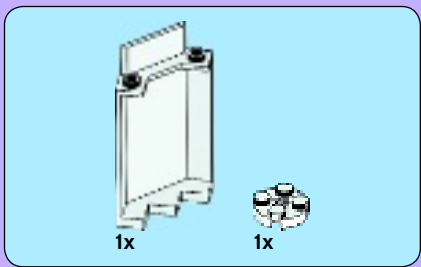

8

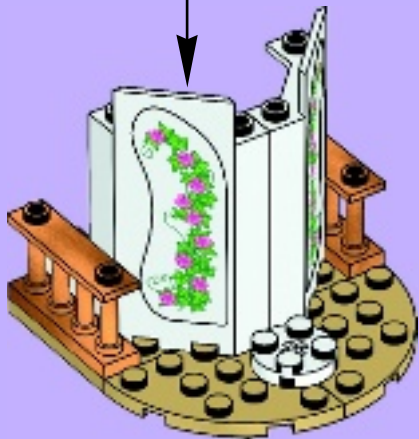
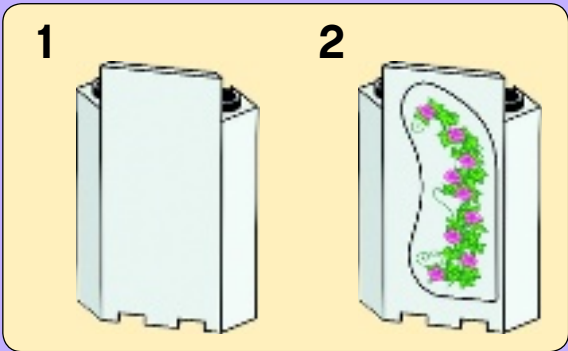

9

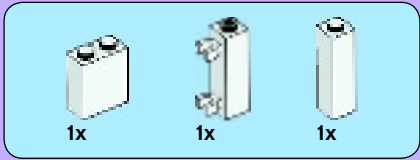
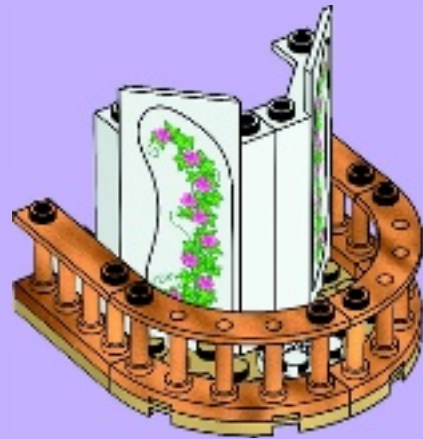

10

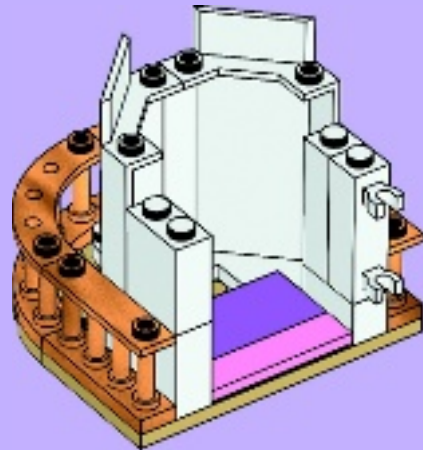



11

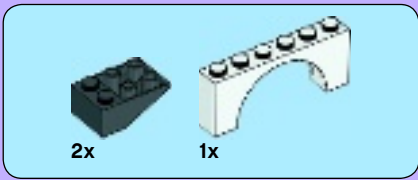
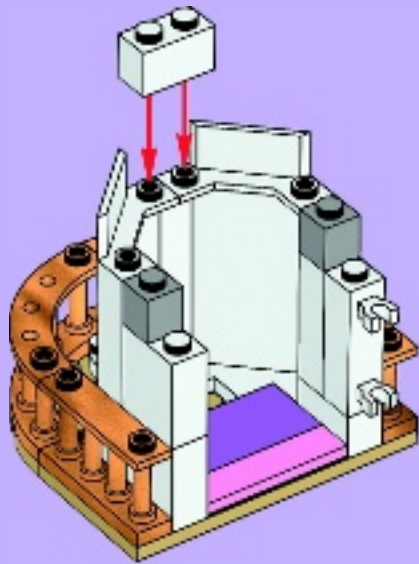

12

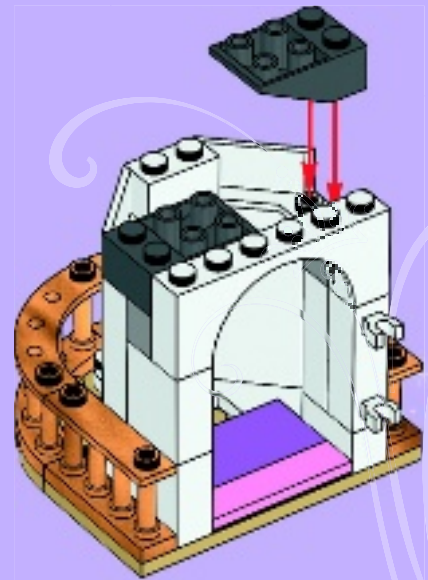



1

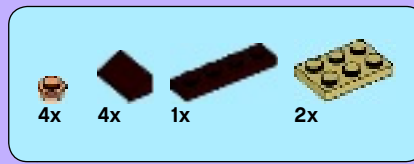

2

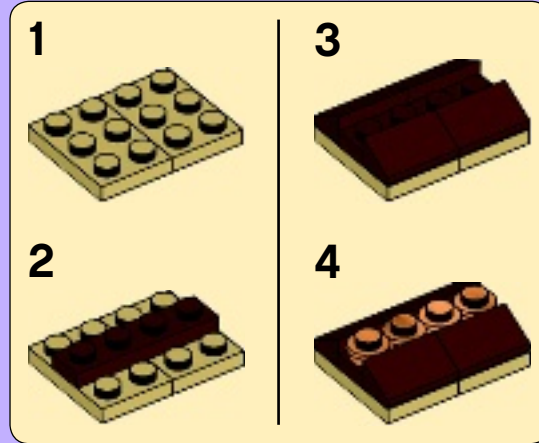

13

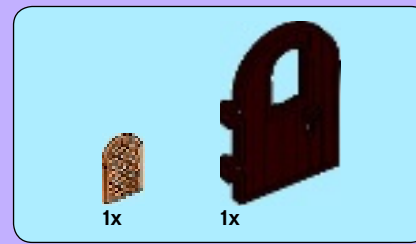
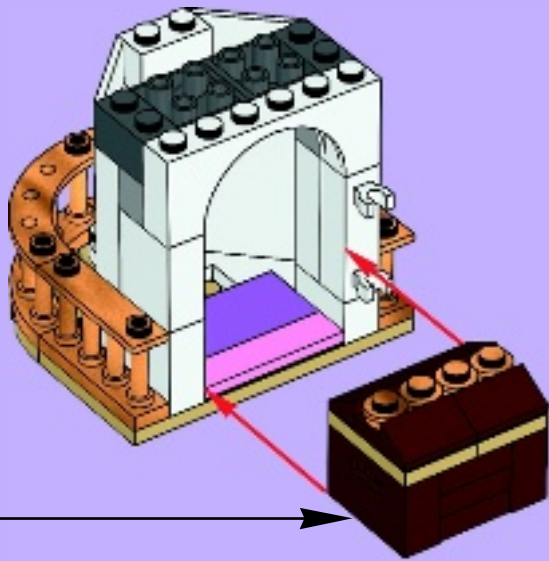

14

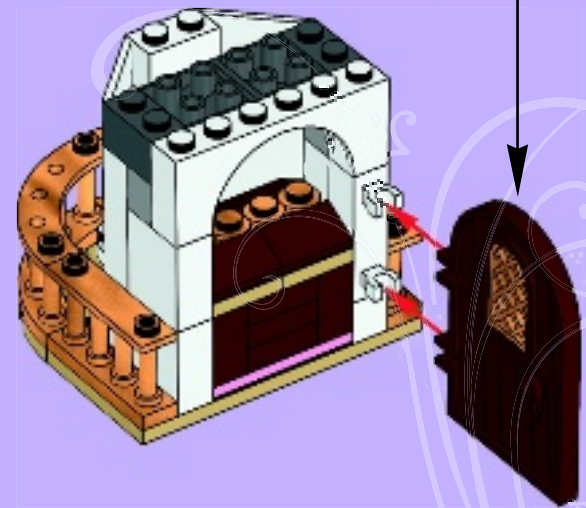

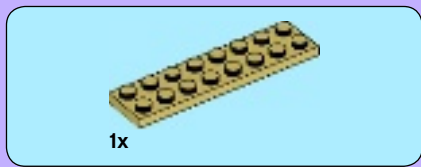

15

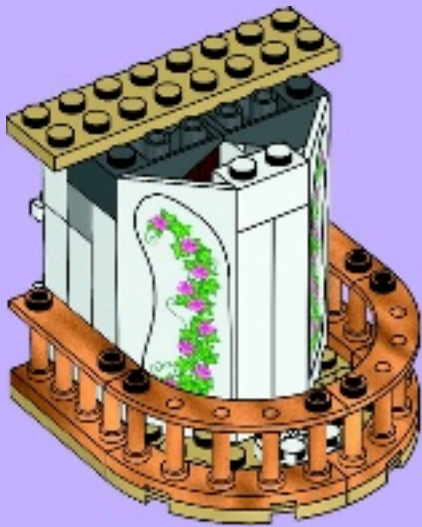
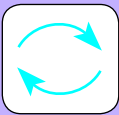

16

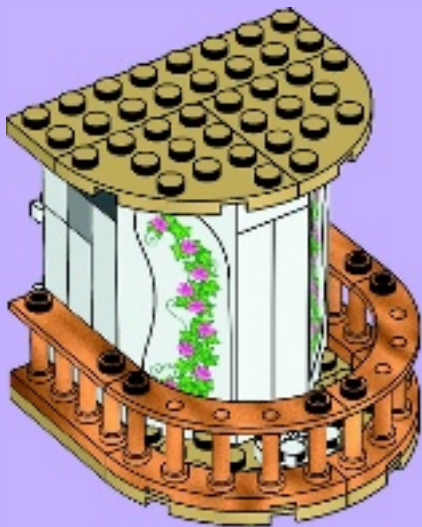

17

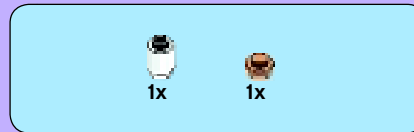
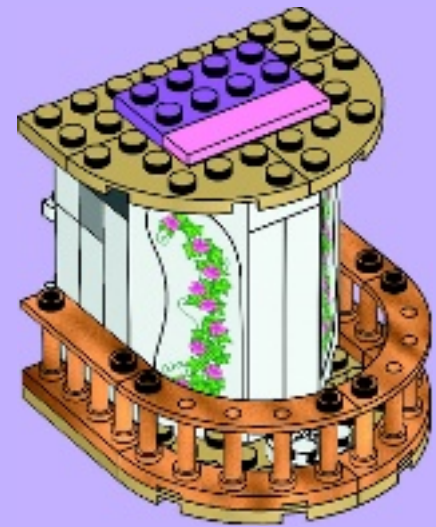

18

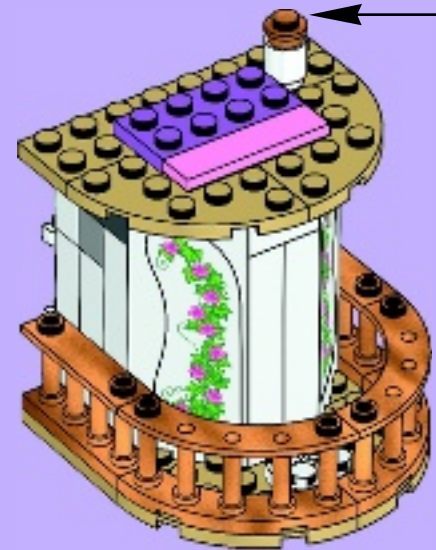



19

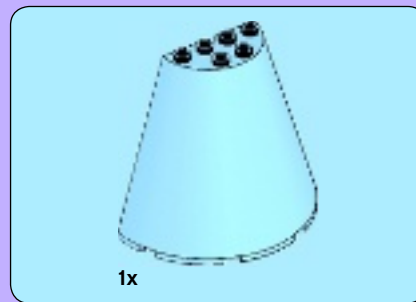
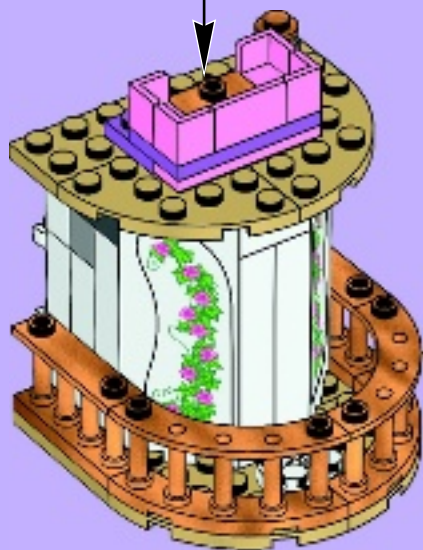
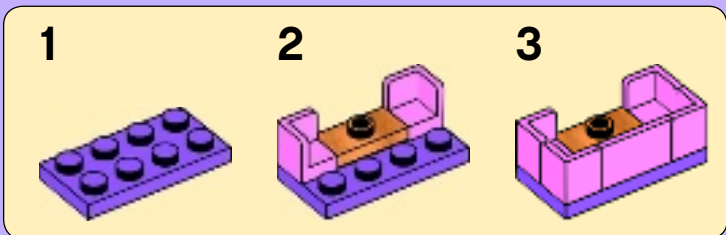

20

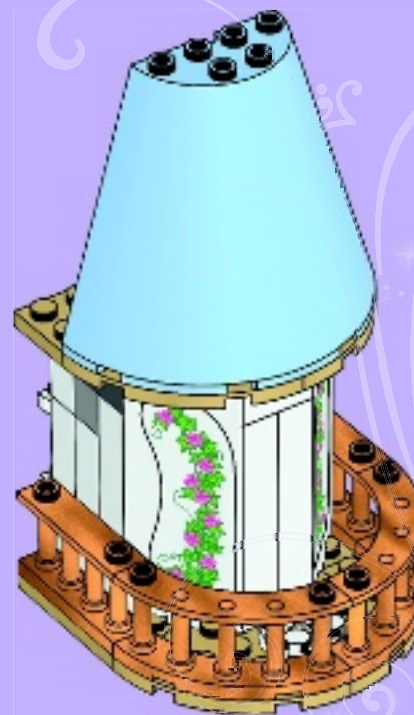

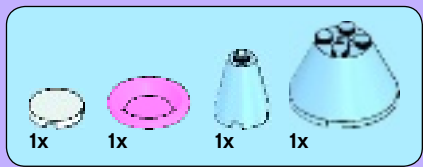

21

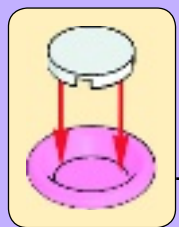

89



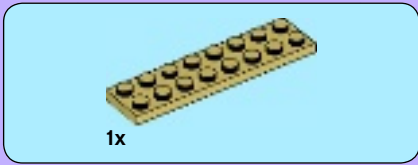

1

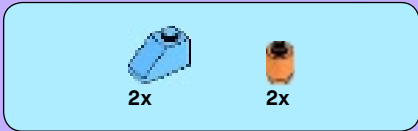
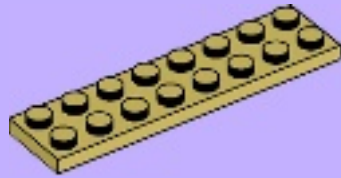

2

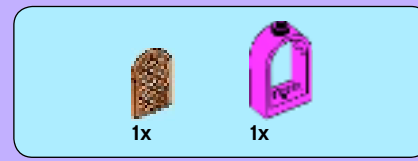
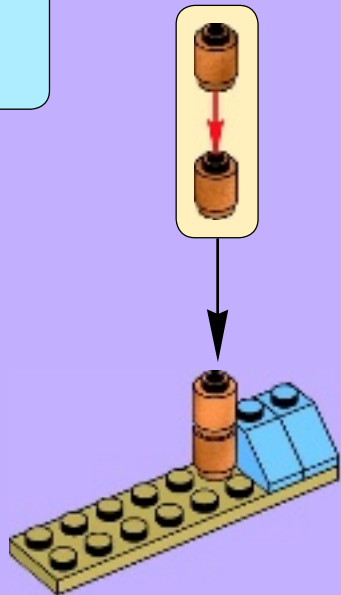

3

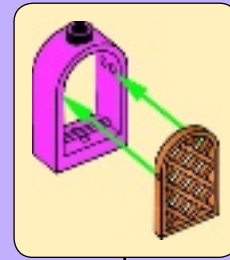

4

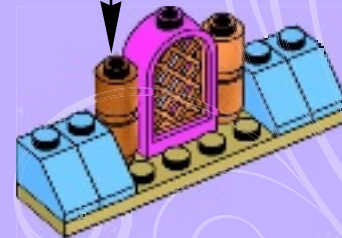
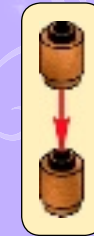



5



6

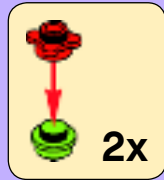

7



90





2x



1x

91

1



2



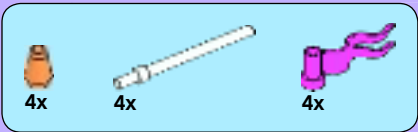

92

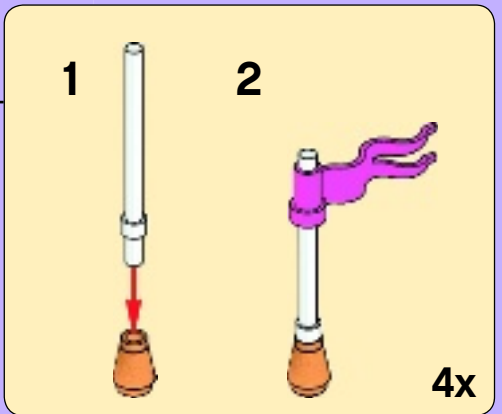



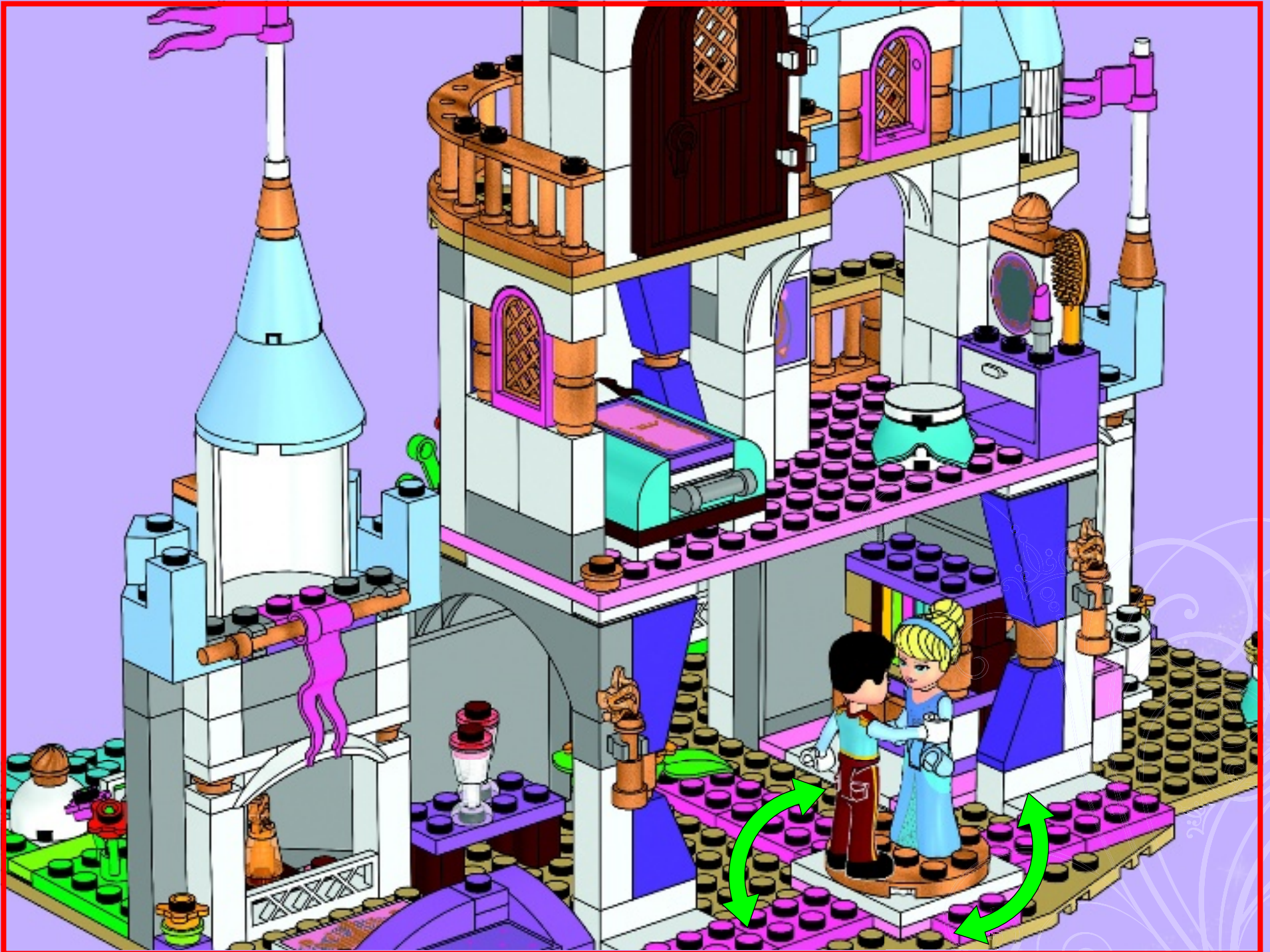

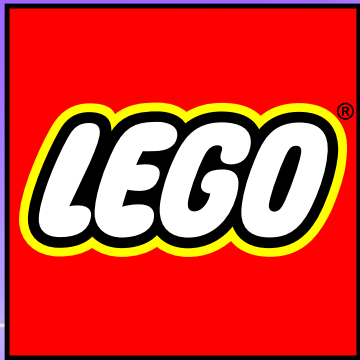

41050



41051



 [LEGO.com/disneyprincess](https://www.LEGO.com/disneyprincess)



41054



41055



41052



41053



Friends



41039



41026



41029

Heartlake City





41035



41027



41028



41037



- 2x 245301
- 7x 6055541
- 8x 300501
- 15x 4113261
- 10x 300401
- 1x 300301
- 2x 235701
- 2x 362201
- 1x 4563684
- 1x 4143254
- 1x 306201
- 4x 4216652
- 1x 6050914
- 2x 4650644
- 2x 4567449
- 1x 389401
- 1x 4547489
- 1x 366501
- 3x 6038525
- 5x 365901
- 2x 4620761
- 2x 6023878
- 1x 4611927
- 12x 302301
- 5x 302201
- 4x 4558168
- 7x 4597131
- 1x 4160736
- 2x 371001
- 2x 4560178
- 2x 4613256
- 1x 4632566
- 1x 4119410
- 2x 6046979
- 2x 4622937
- 8x 614101
- 4x 403201
- 2x 6044691
- 1x 4515347
- 1x 6065143
- 4x 4565576
- 1x 4163987
- 1x 4520636
- 5x 4550171
- 4x 4538720
- 1x 4600294
- 2x 4523556
- 1x 4494474
- 2x 4125554
- 1x 4114064
- 1x 4162465
- 3x 4579260
- 6x 4117070
- 2x 4205107
- 2x 4205105
- 3x 4114026
- 2x 4113988
- 1x 4509897
- 5x 4113917
- 1x 4114084
- 2x 4118790
- 1x 4114309
- 2x 4124067
- 2x 4157277
- 4x 4655257
- 1x 6056273
- 1x 6056274
- 4x 4570516
- 1x 6017003
- 1x 4666579
- 1x 300221
- 11x 6035617
- 2x 6054438
- 1x 4142865
- 1x 368023
- 1x 302324
- 1x 6063639
- 1x 6022447
- 2x 249626
- 3x 302328
- 4x 302028
- 2x 4116671
- 2x 4567908
- 3x 4651215
- 3x 374128
- 1x 242328
- 5x 4613823
- 1x 4107432
- 1x 4119479
- 1x 4113949
- 1x 6054554
- 2x 3000240
- 4x 3005741
- 1x 4113954
- 1x 4183544
- 2x 4163917
- 1x 3005744
- 1x 4128576
- 1x 4113955
- 12x 4626883
- 4x 6045942
- 1x 6070904
- 1x 4129917
- 5x 6058337
- 1x 4654448
- 1x 4164037
- 2x 4500125
- 1x 4537937
- 9x 4164021
- 2x 4504850
- 15x 4183133
- 1x 4624381
- 1x 4243703
- 4x 4567338
- 3x 4649066
- 6x 4624184
- 1x 4243668
- 1x 6064747
- 10x 421180
- 3x 421181
- 1x 4211201
- 1x 4215496
- 5x 4211166
- 4x 6035291
- 3x 4211199
- 4x 6055086
- 1x 4211150
- 3x 4565394
- 3x 4211152
- 1x 4211190
- 1x 4221590
- 1x 421247
- 1x 4271874
- 1x 4216581
- 1x 4561915
- 1x 421185



2x
4211362



4x
4211389



4x
6000066



2x
4211428



3x
4211394

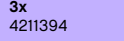

2x
4211393



4x
4211392



4x
4533772



1x
6015344



1x
4211436



2x
4211445



2x
4211395



3x
6028812



1x
4244627



2x
4211475



4x
4563698

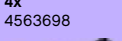

3x
4527174



2x
4211373



1x
4644102



2x
4211859



1x
4540203



1x
4211815



2x
4211064



1x
4211110

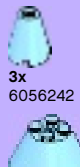

3x
6056242



2x
6056240



4x
6060798



4x
6056239



12x
6057387



11x
6060801



3x
6056260



11x
4216479



5x
4243677



1x
4624571



2x
4618670



1x
4580010



3x
4615728



8x
4621552



2x
4654127



10x
4655258



1x
4619591



1x
4618629



1x
6055643



4x
6022072



4x
6022070



1x
6058330



1x
6062110



1x
6062103



1x
6017021



20x
6060800



4x
4529247



9x
4523157



13x
4523159



1x
6013297



4x
4541895



2x
6044591



3x
6060803



2x
6060804



1x
4600270



1x
4656153



4x
4538126



6x
6050916



1x
6022033



1x
4535553



1x
6017046



2x
6015098



4x
4649741



3x
4619513



2x
6056271



2x
6058746

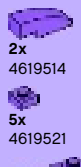

2x
4619514



5x
4619521



10x
4619516



4x
4651902



1x
6035703



2x
4221589



1x
6056243



2x
6056246

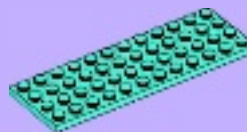

2x
6056270



1x
4610355



2x
4611414

Customer Service
Kundenservice
Service Consommateurs
Servicio Al Consumidor
LEGO.com/service or dial



: 00800 5346 5555
: 1-800-422-5346



Win!

Go to LEGO.com/productfeedback to fill out a survey for a chance to win a cool LEGO® Product.

No purchase necessary.
Open to all residents
where not prohibited.



LEGO.com/productfeedback

Gewinne!

Nimm an der Umfrage auf LEGO.com/productfeedback teil und hab die Chance ein cooles LEGO® Produkt zu gewinnen!

Die Teilnahme am Gewinnspiel führt zu keinerlei Kaufverpflichtungen. Teilnahme in allen nicht ausgeschlossenen Ländern möglich.

Win!

Ga naar LEGO.com/productfeedback, vul een enquêteformulier in en maak kans op een cool LEGO® product.

Geen aankoopverplichting. Ledereen mag deelnemen, uitgezonderd ingezetenden van landen waar een enquêteverbod geldt.

Gagne!

Visite LEGO.com/productfeedback pour répondre à un questionnaire et avoir une chance de gagner un produit LEGO® très cool !

Aucune obligation d'achat. Ouvert à tous les résidents des pays autorisés.

当てよう!

LEGO.com/productfeedbackにアクセスして、アンケートにご記入ください。当選者にはレゴ®製品を差し上げます。

お買い上げの必要はありません。

禁止されていない限り、すべての皆様にご利用いただけます。



LEGO.com

6078361

LEGO and the LEGO logo are trademarks of the LEGO Group. ©2014 The LEGO Group © Disney