



40678





Get excited about our new packaging!

We're switching from plastic to paper-based packaging. That's why you might find a mix of paper and plastic in our boxes!

Nos nouveaux emballages vous emballeront !

Nous passons des emballages en plastique aux emballages à base de papier. C'est pourquoi vous pourriez trouver un mélange de papier et de plastique dans nos boîtes !

¡Te presentamos nuestros nuevos empaques!

Estamos sustituyendo las bolsas de plástico por bolsas con base de papel. ¡Por eso, puedes encontrar una mezcla de papel y de plástico en nuestras cajas!

[LEGO.com/sustainable-packaging](https://www.lego.com/sustainable-packaging)

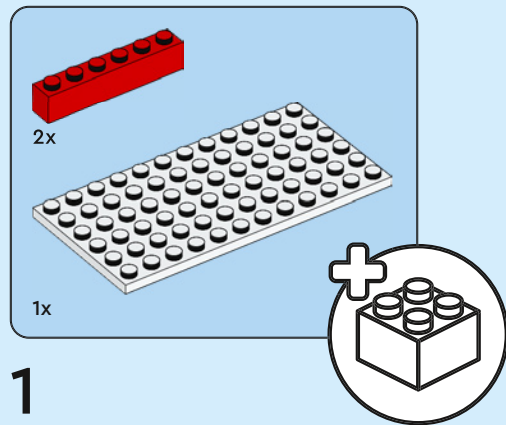
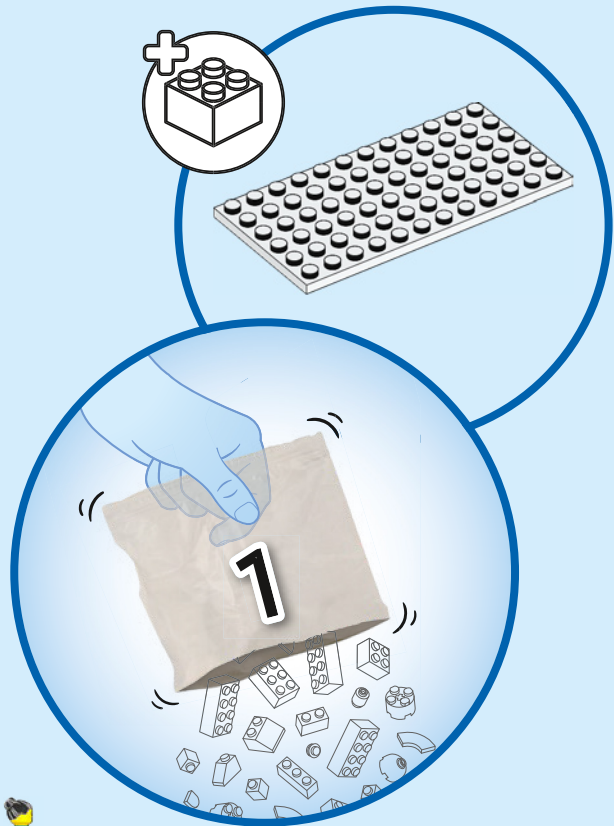

1

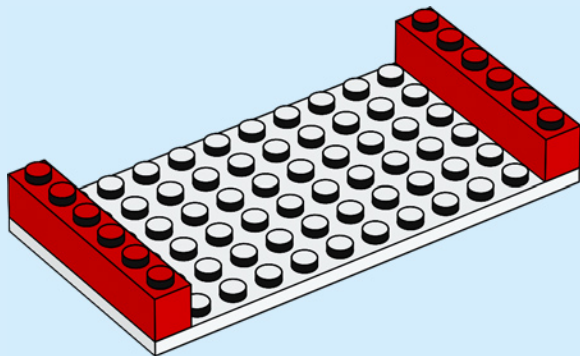



2x



2x

2

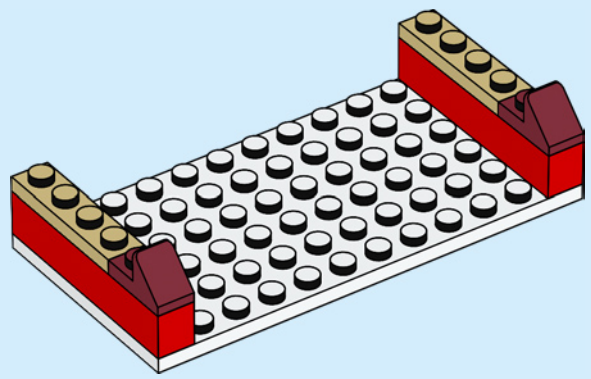

2x



2x

3

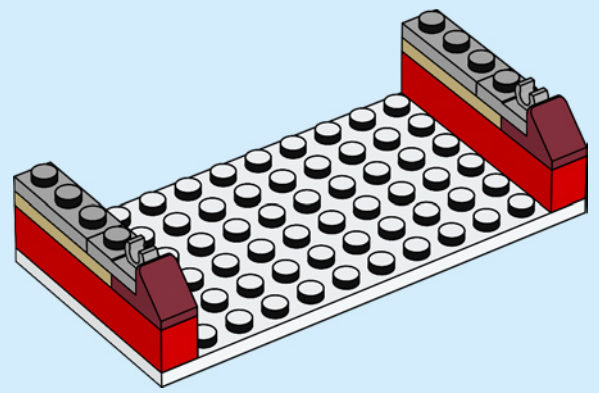

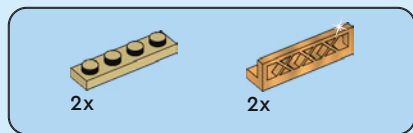

4

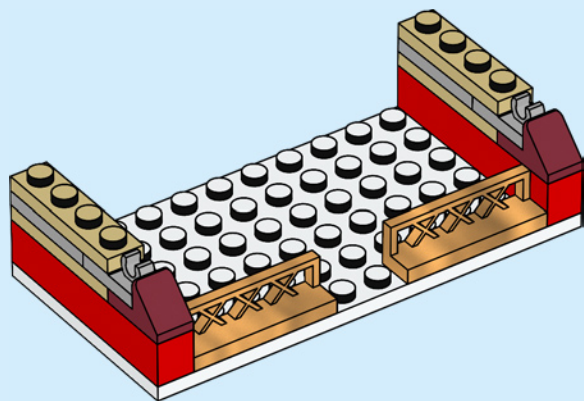

5

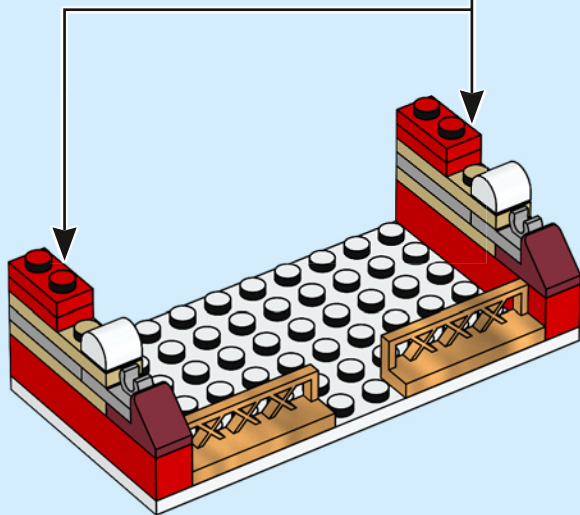
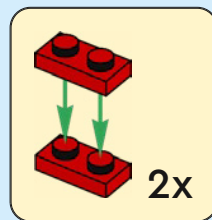

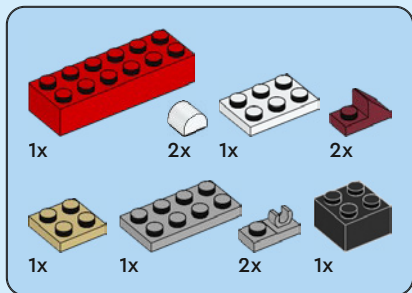

6

1

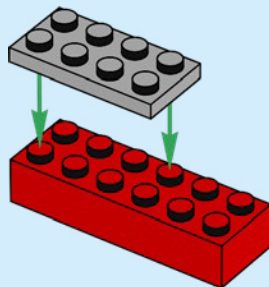

2

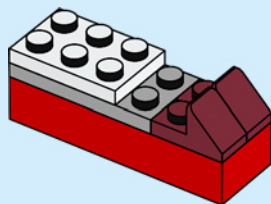

3

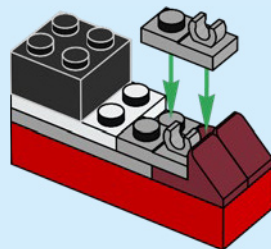

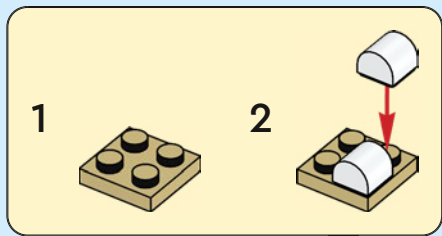

4

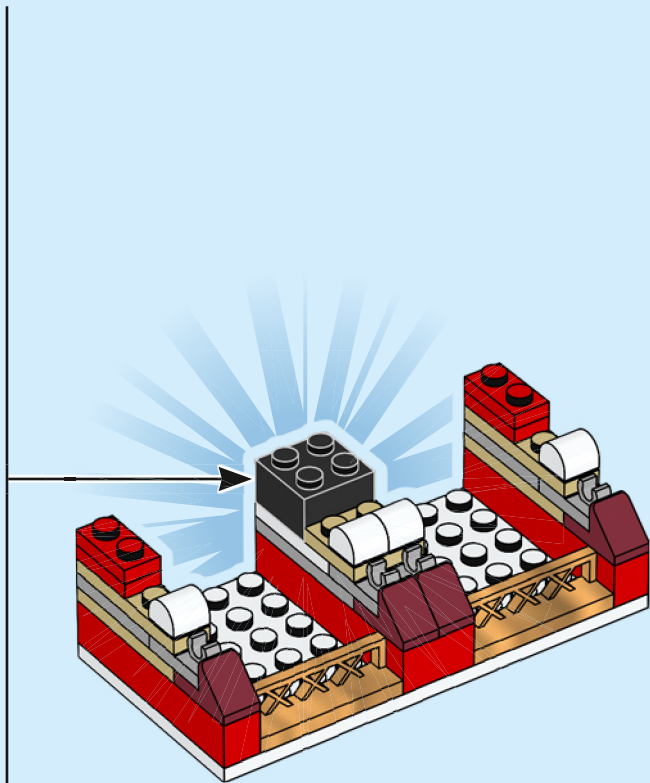
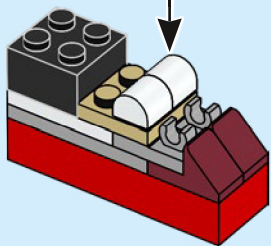

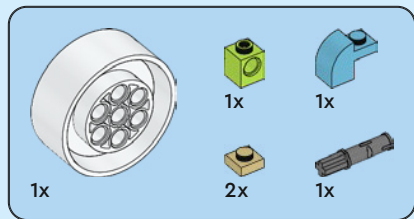

7

1

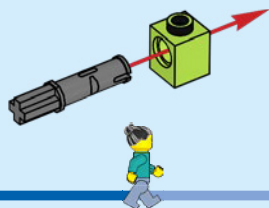

2

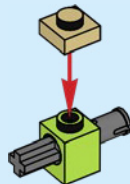

3

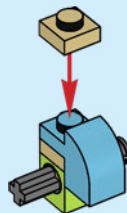

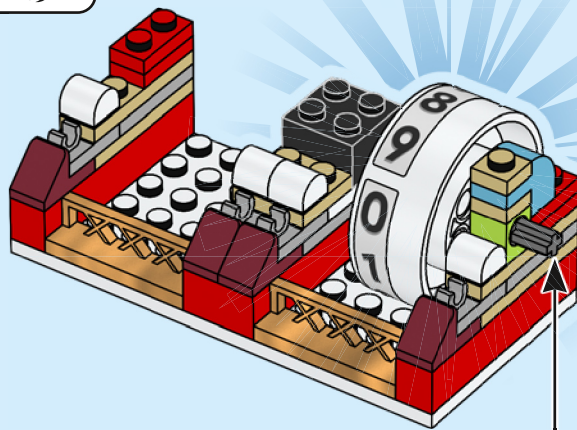
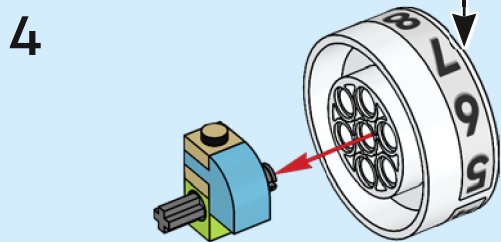
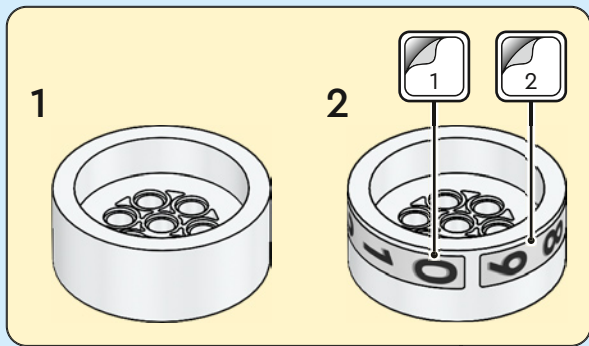

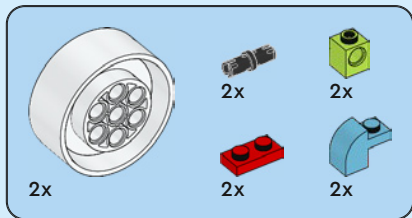

8

1

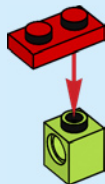

2

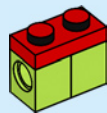

3

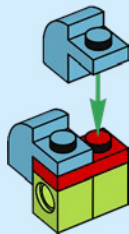

4

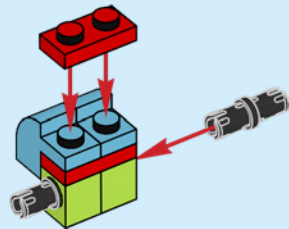

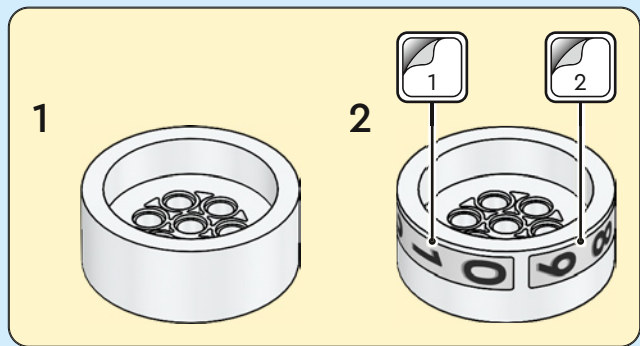
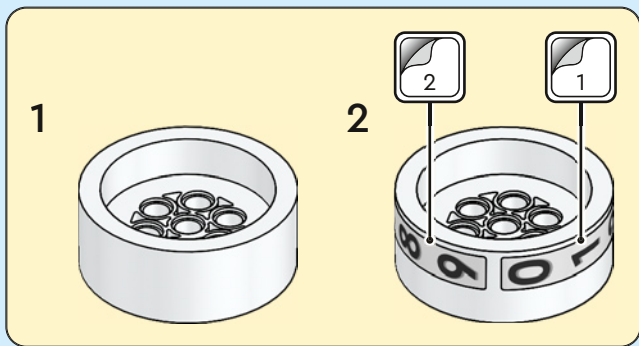

5

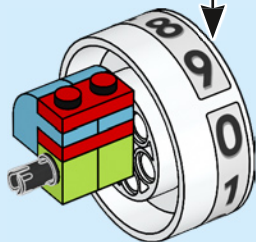

6

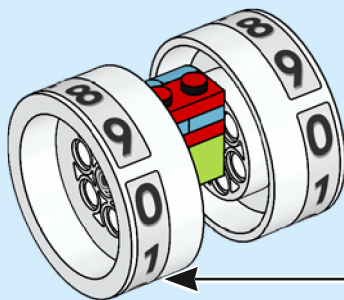

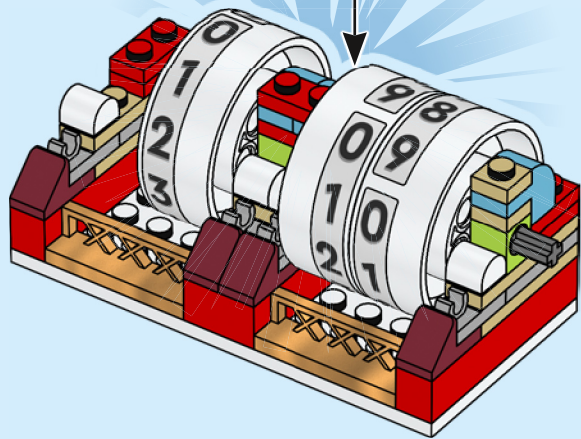

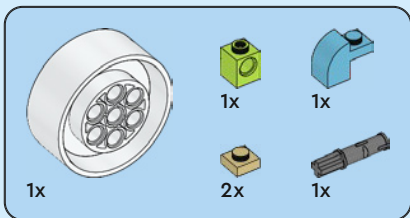

9

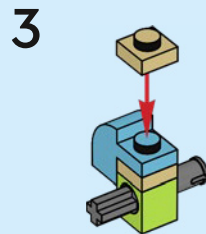
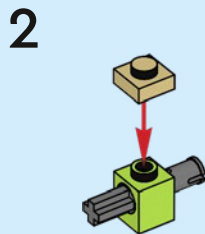
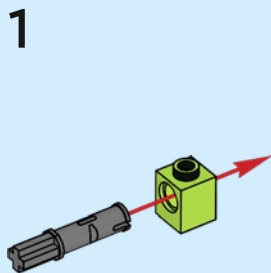

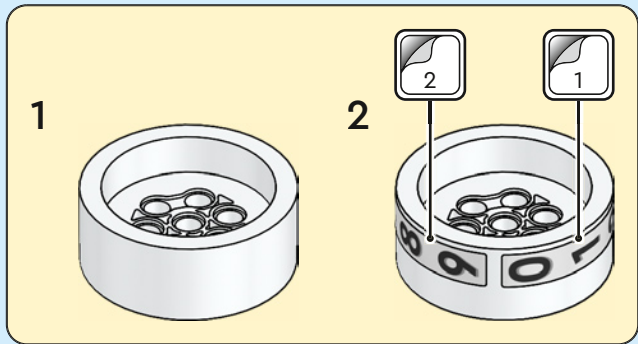

4

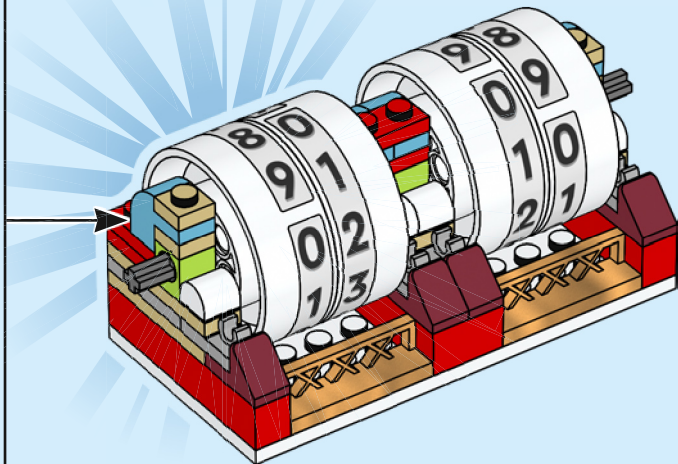
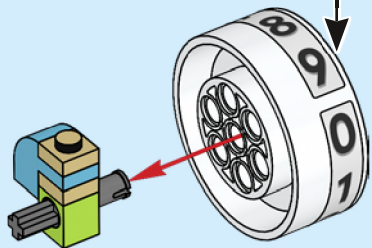

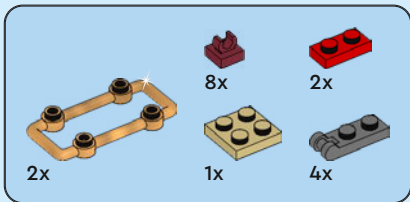
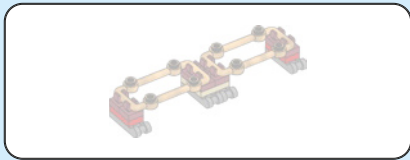

10

1



2

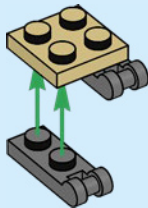

3

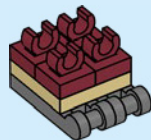

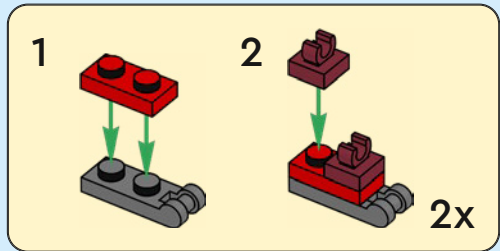

4

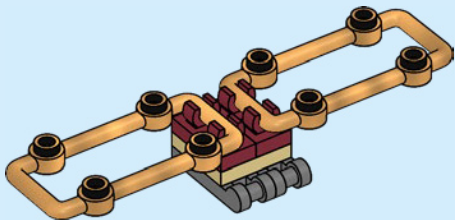

5

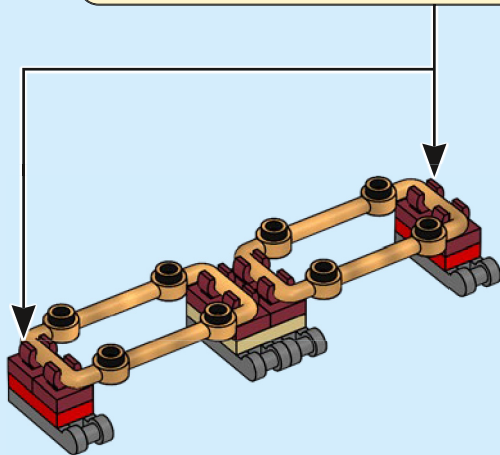

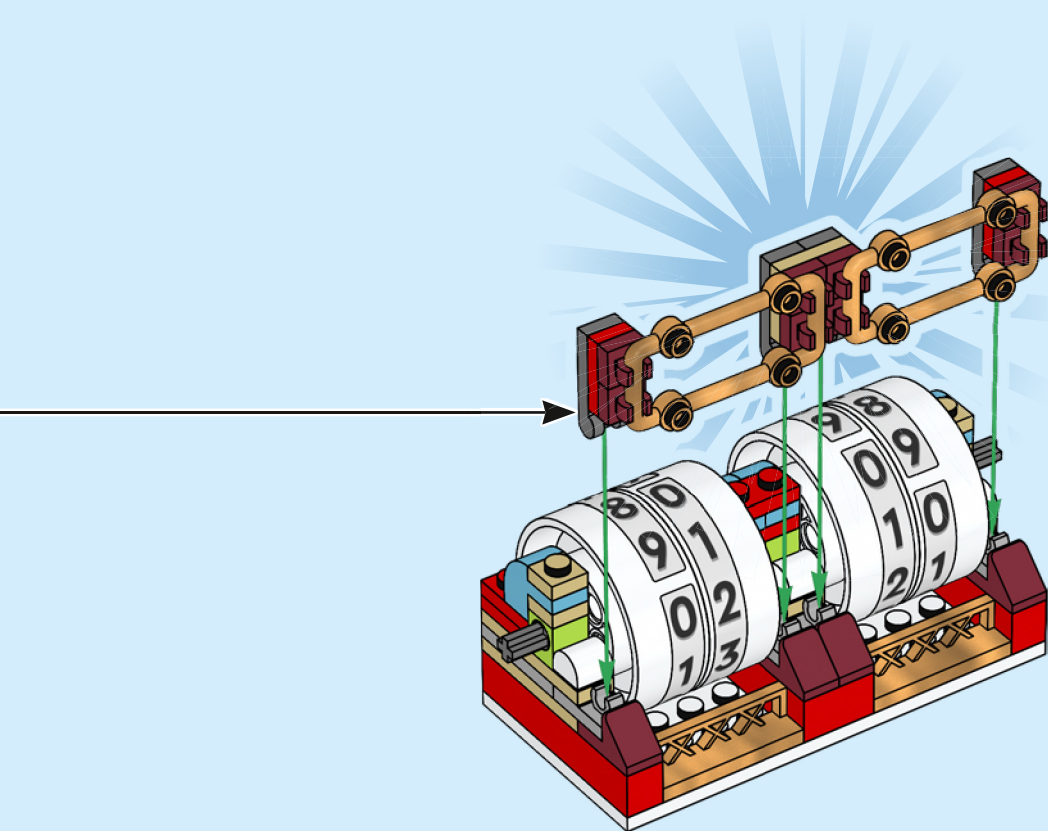

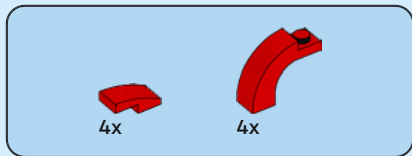

11

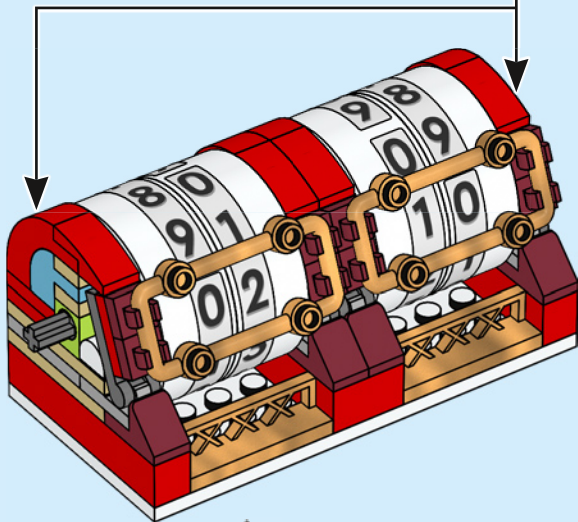
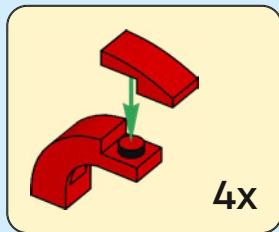



12

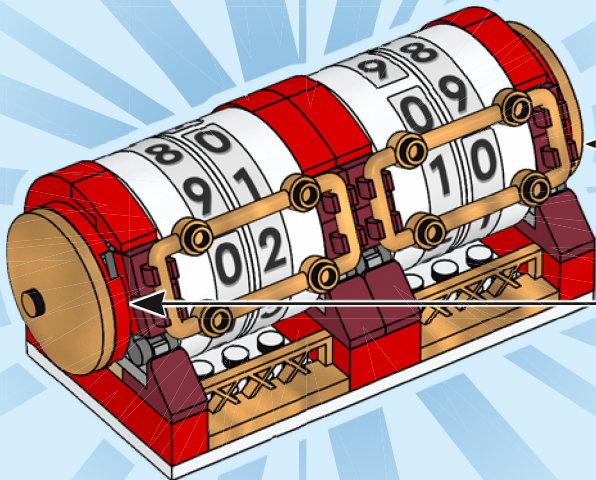
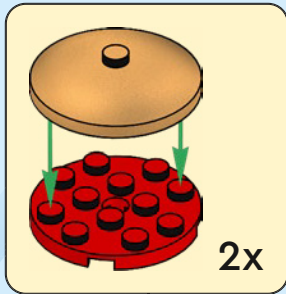

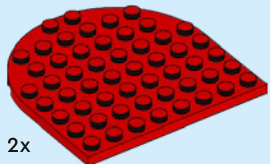
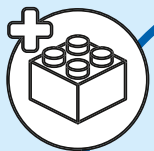

2x

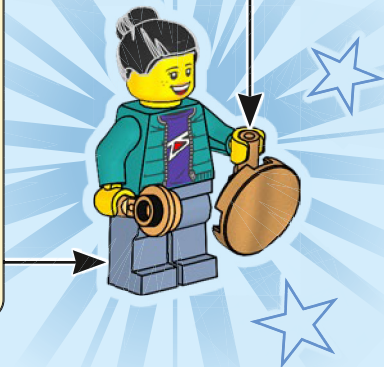
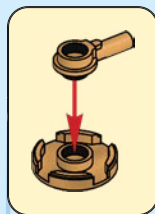
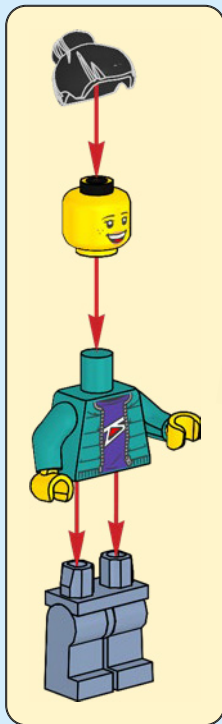

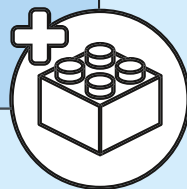
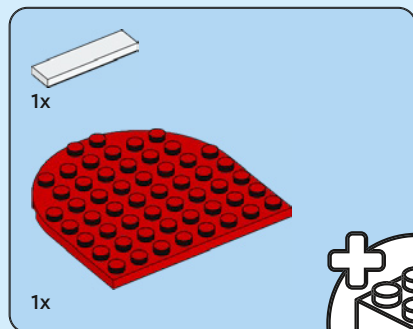

1

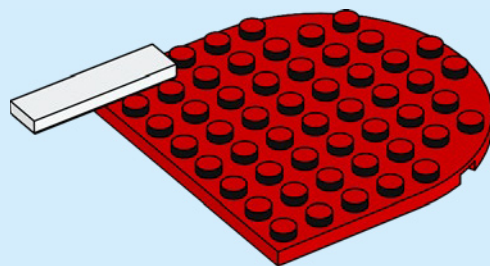

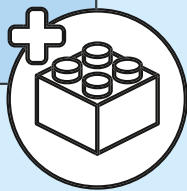
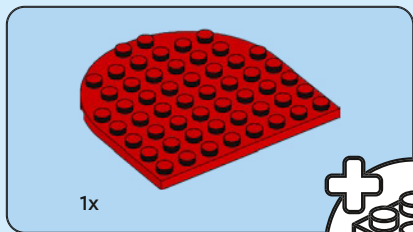

2

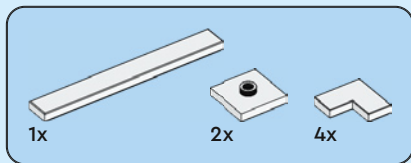
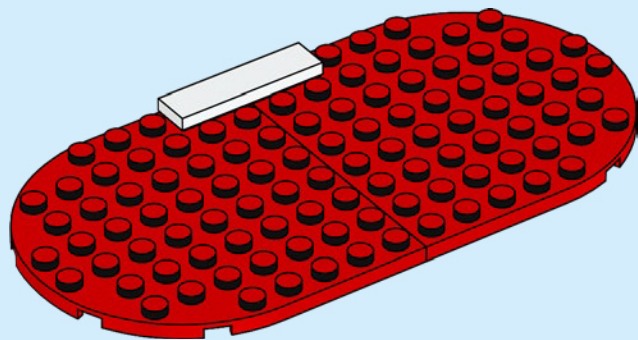

3

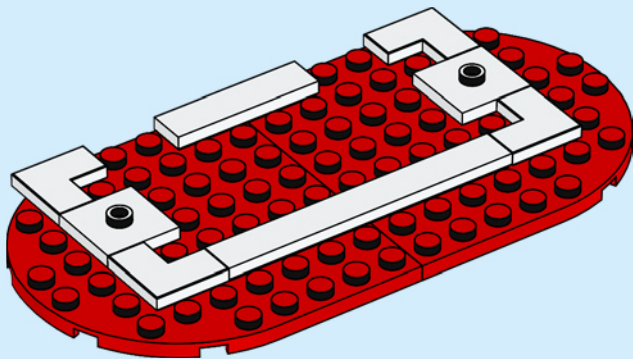



2x



2x

4

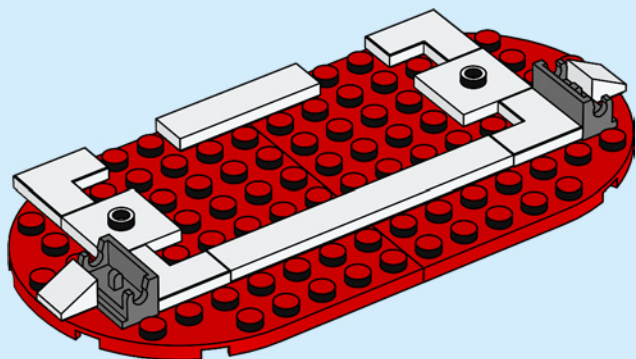

2x



2x



1x

5

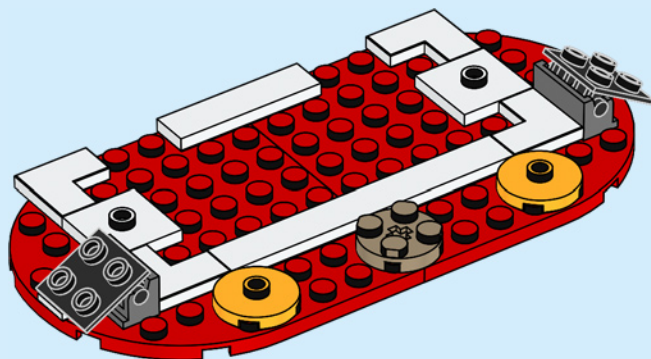

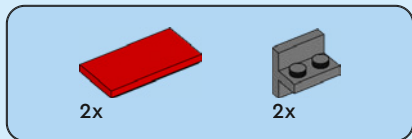

6

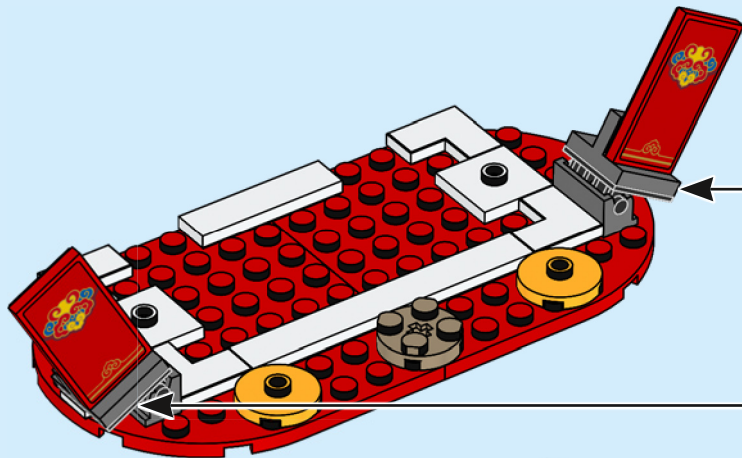



7

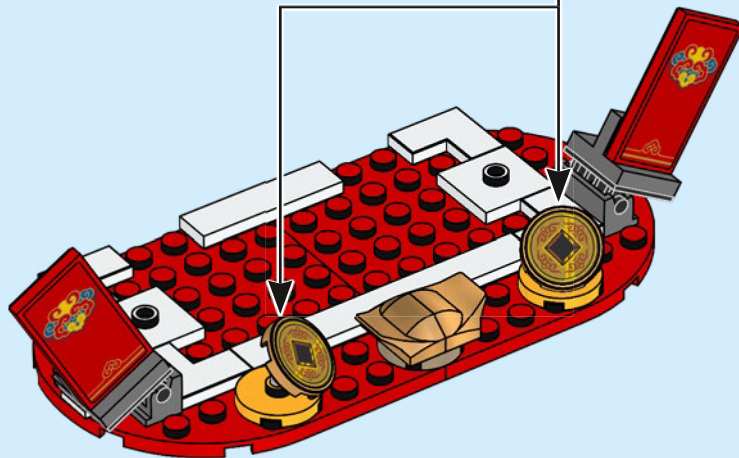
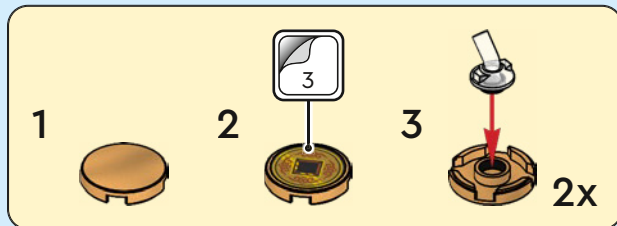

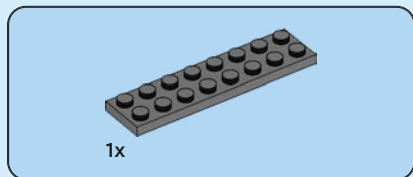
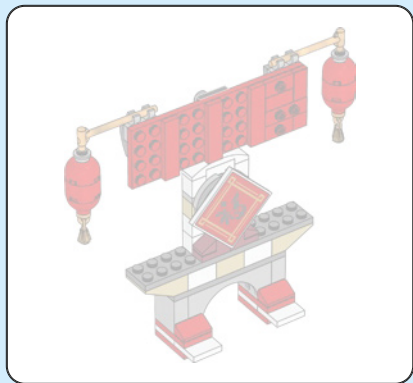

8

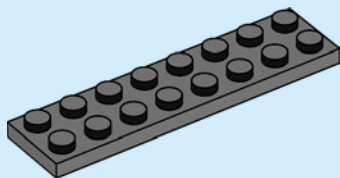

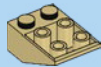

1x

9

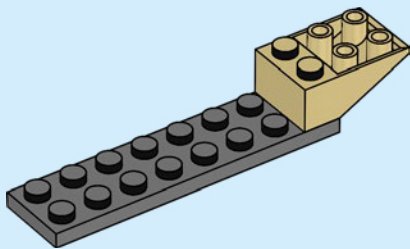

2x

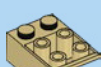

1x



1x

10

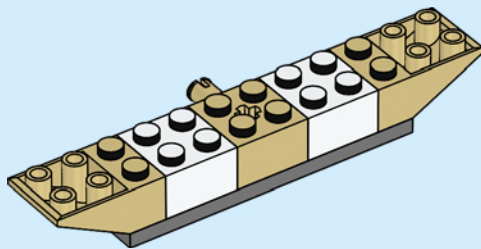

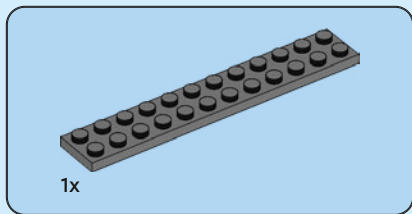

11

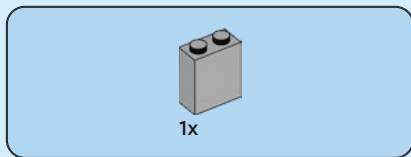
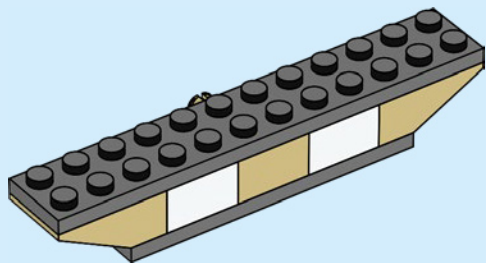

12

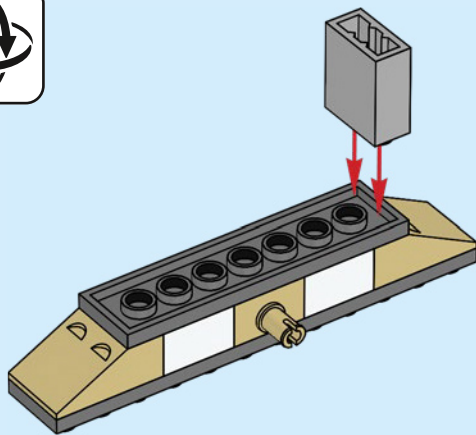

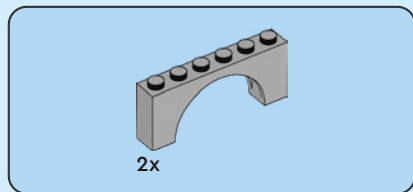

13

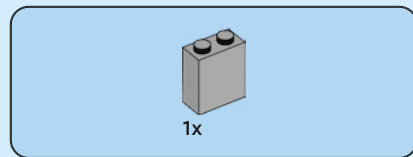
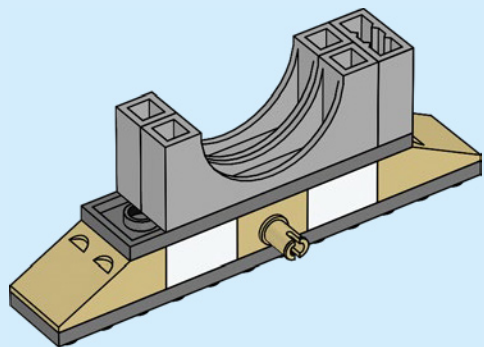

14

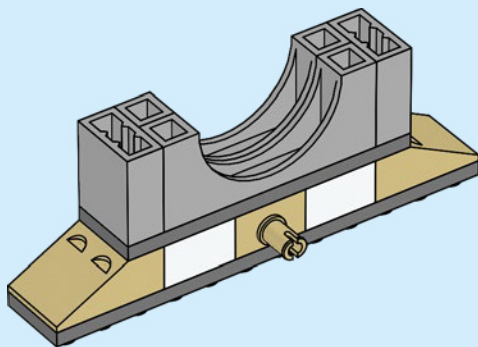

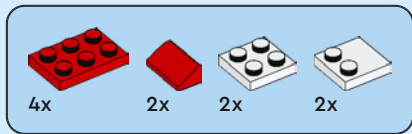

15

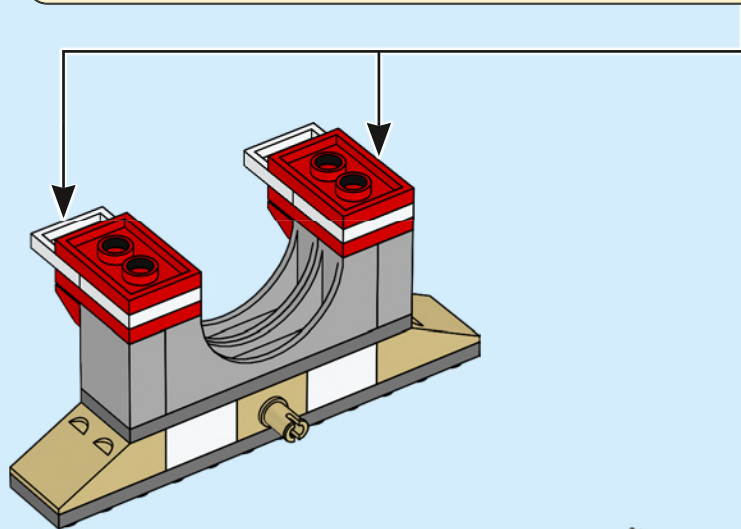
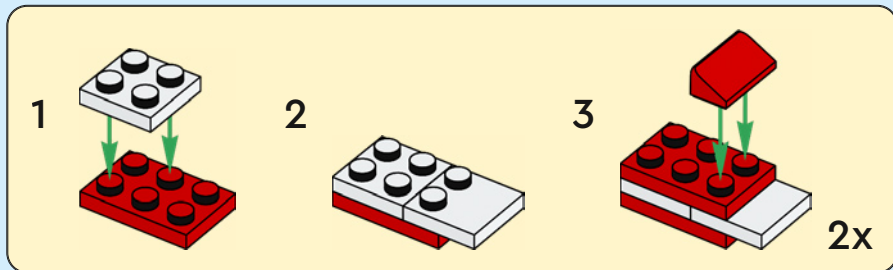

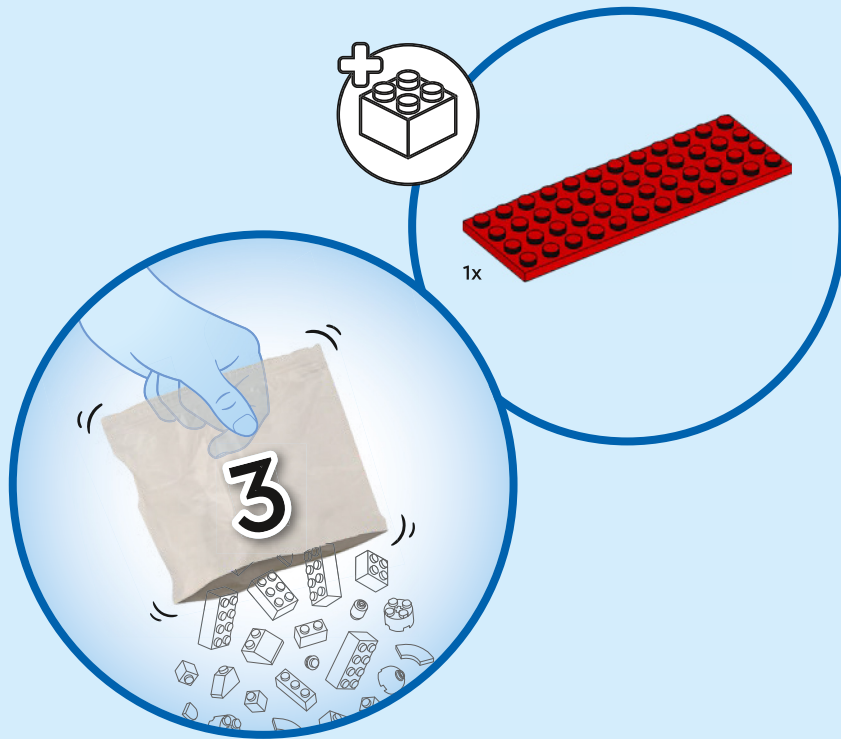

1

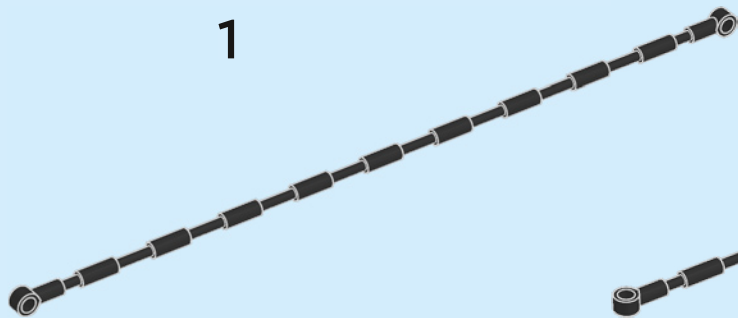

2

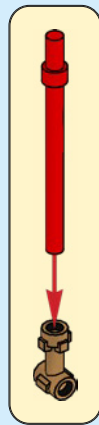
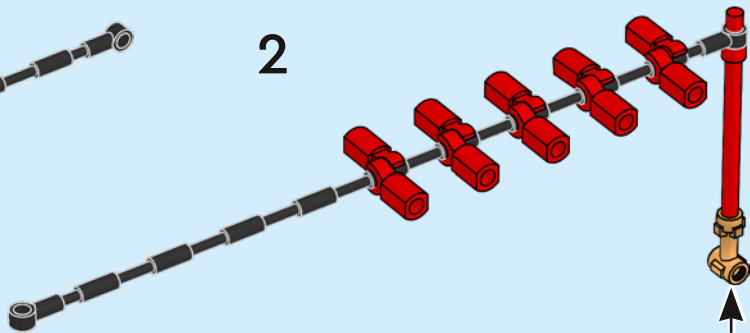

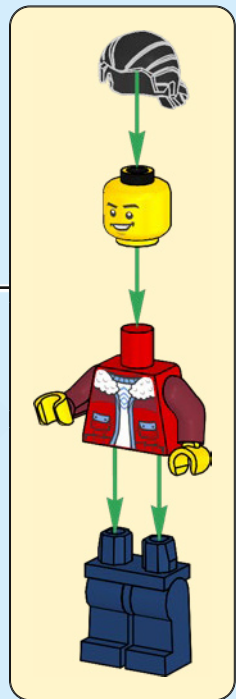
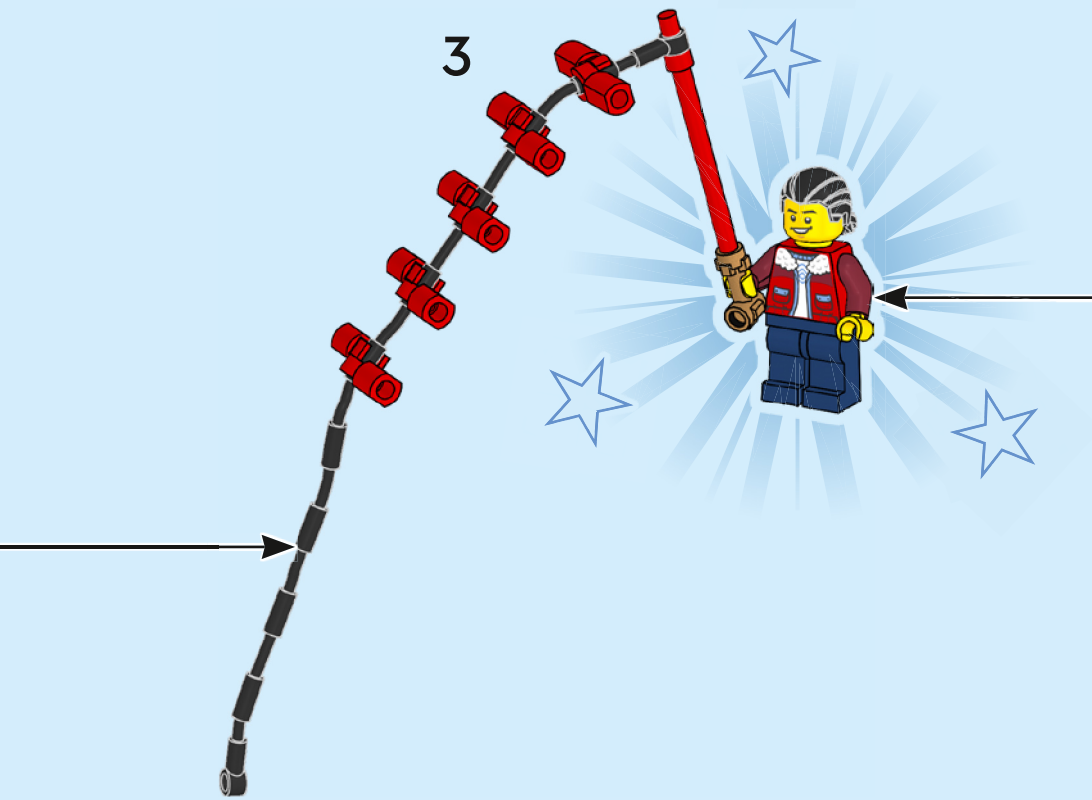

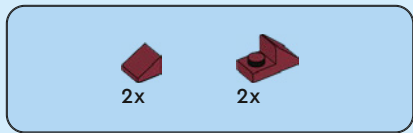

16

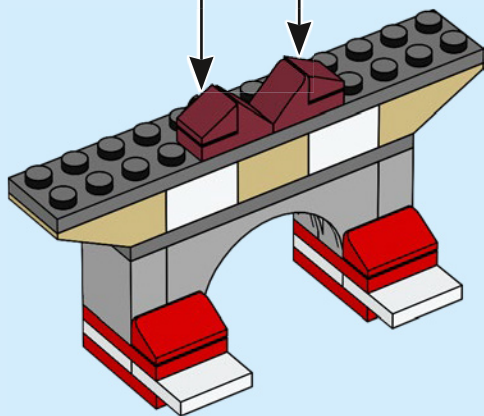
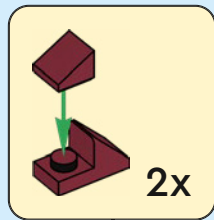

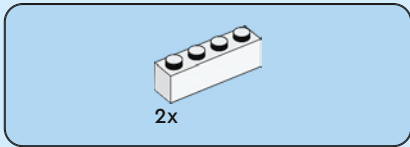

17

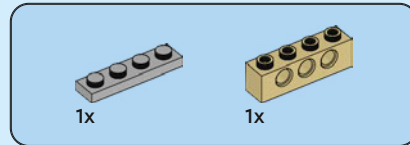
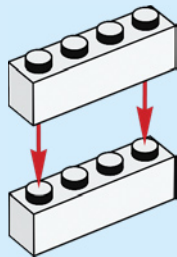

18

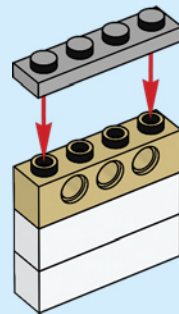



1x



2x



1x

19

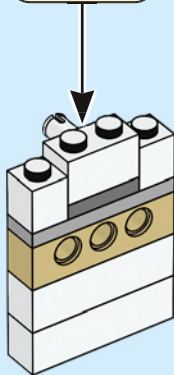
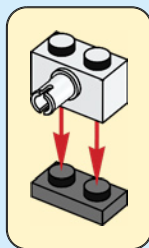

1x



1x

20

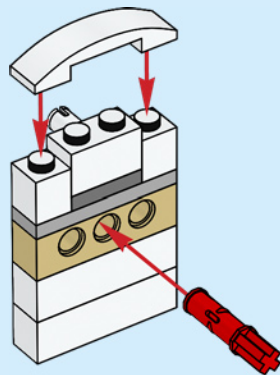

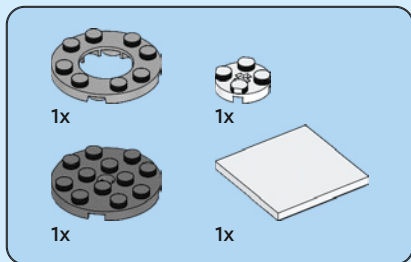

21

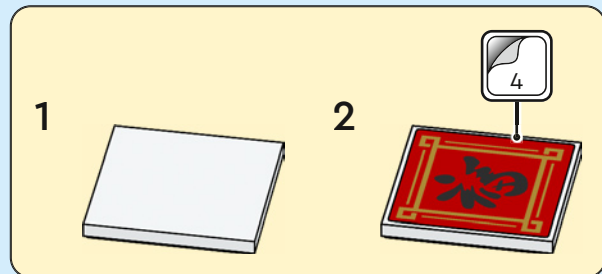
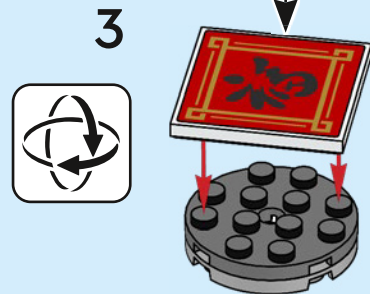
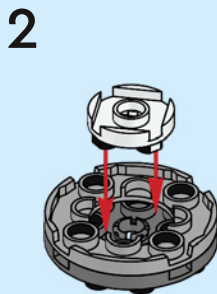
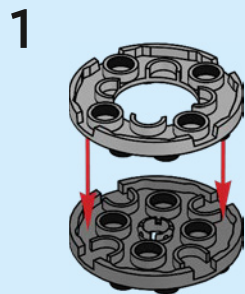

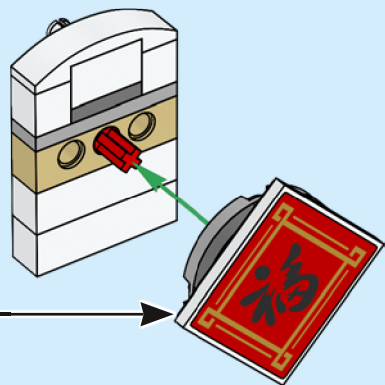

22

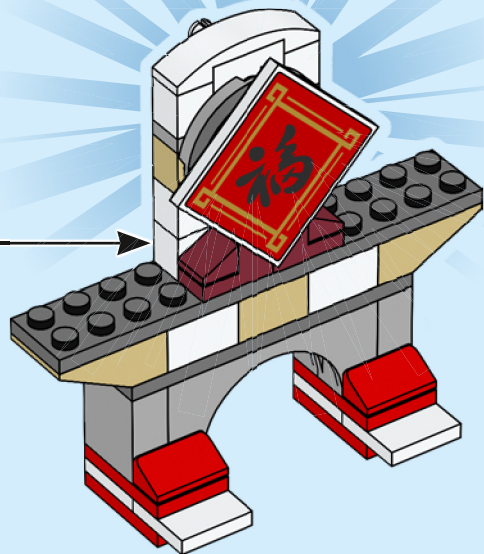

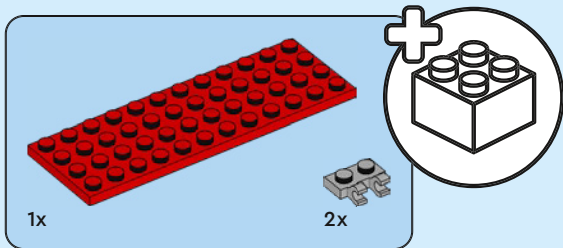
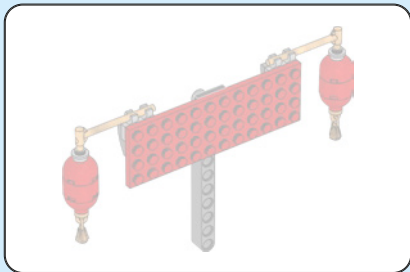

23

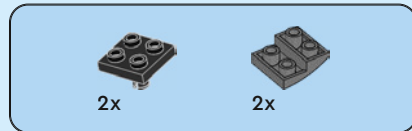
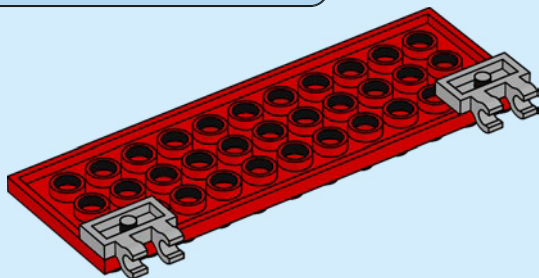

24

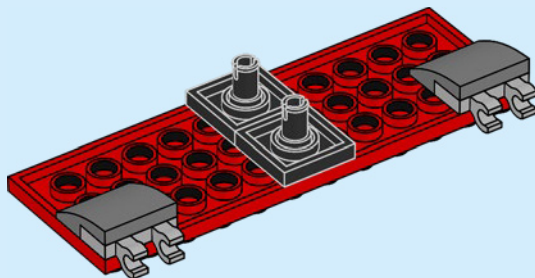

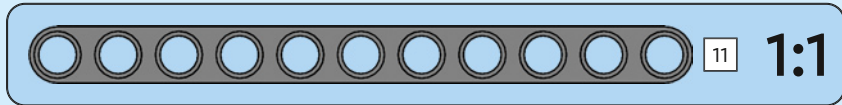
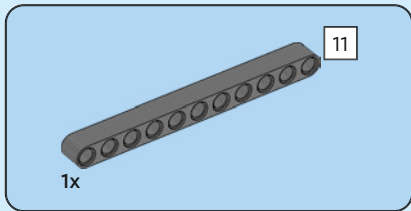

25

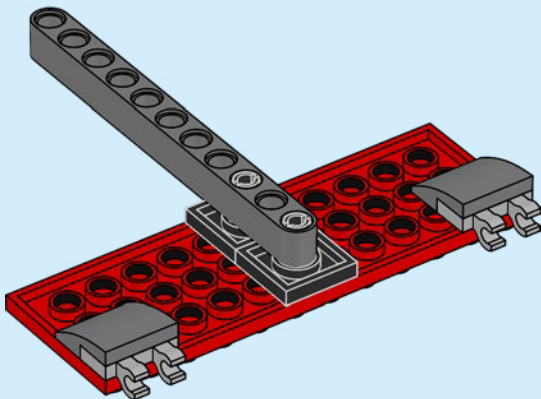



2x



2x



2x



2x



2x



2x



2x

26

1

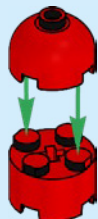

2

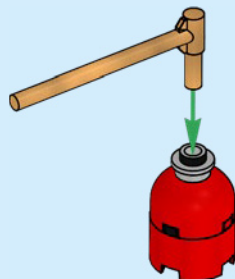

3

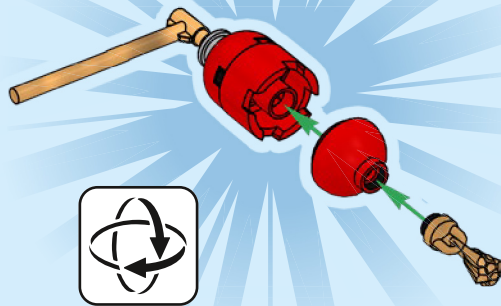

2x

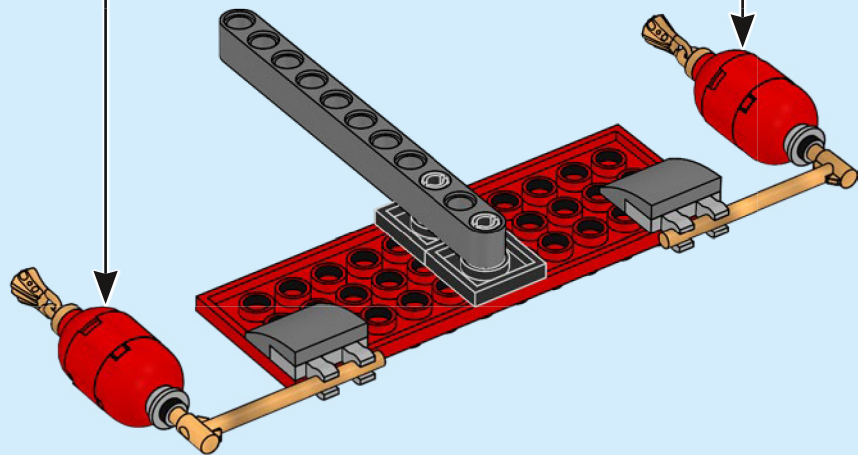

27

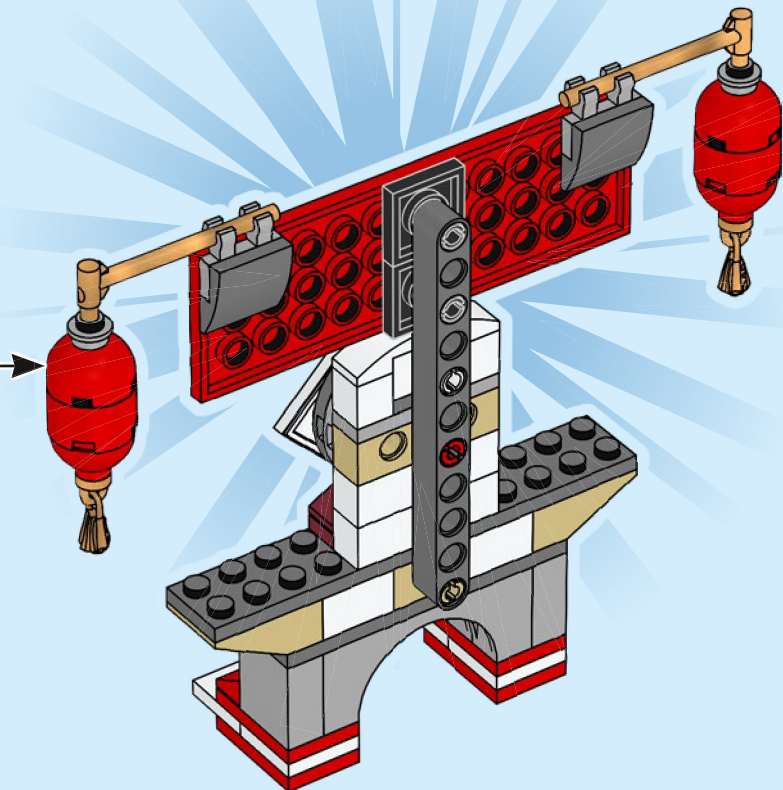

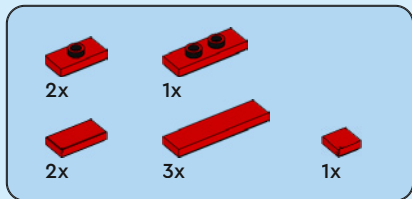

28

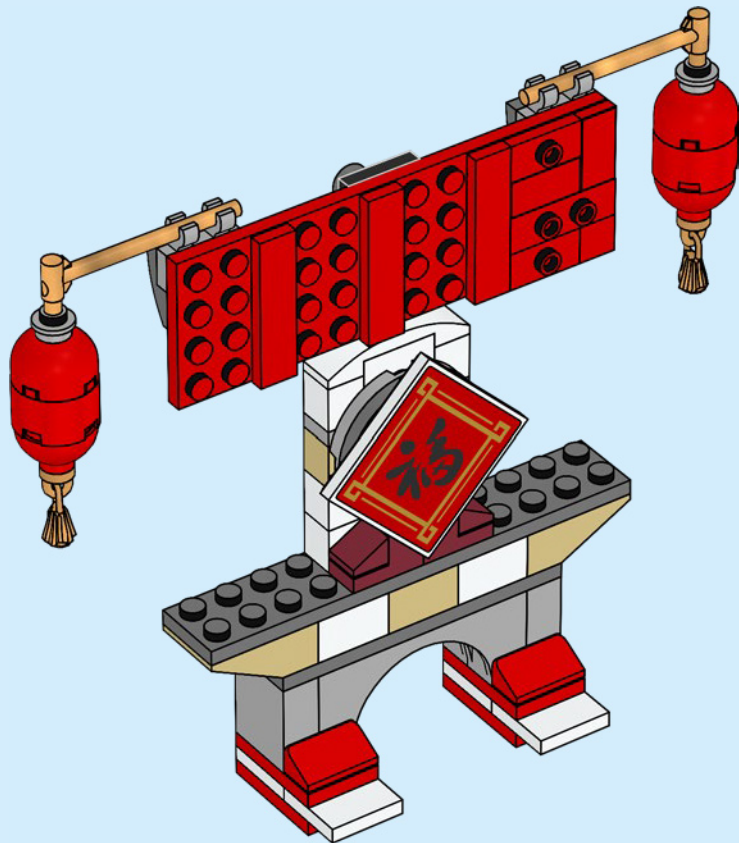



1x



2x

29

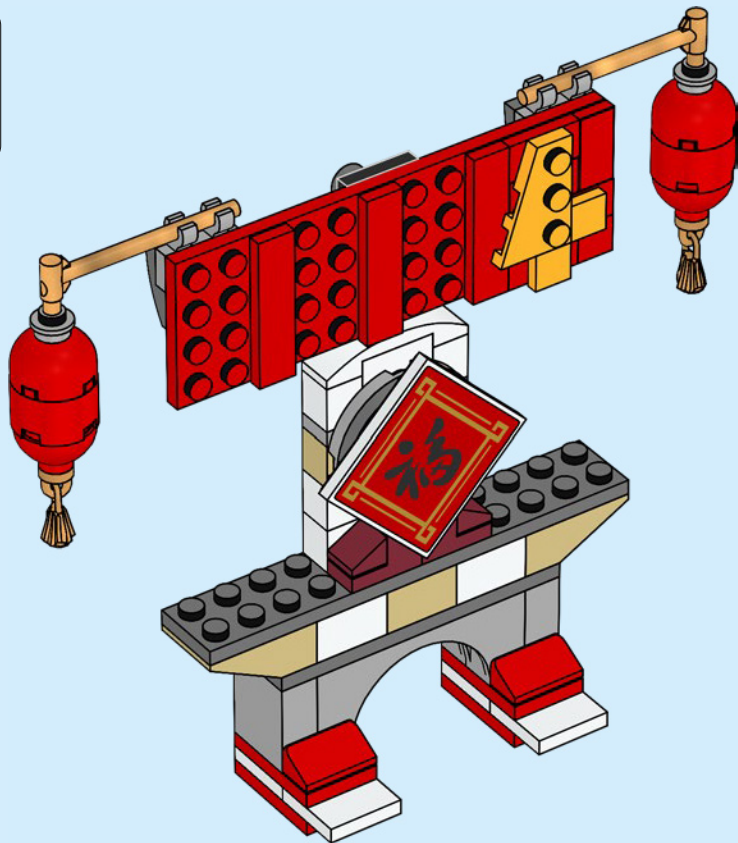

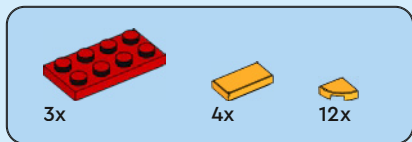

30

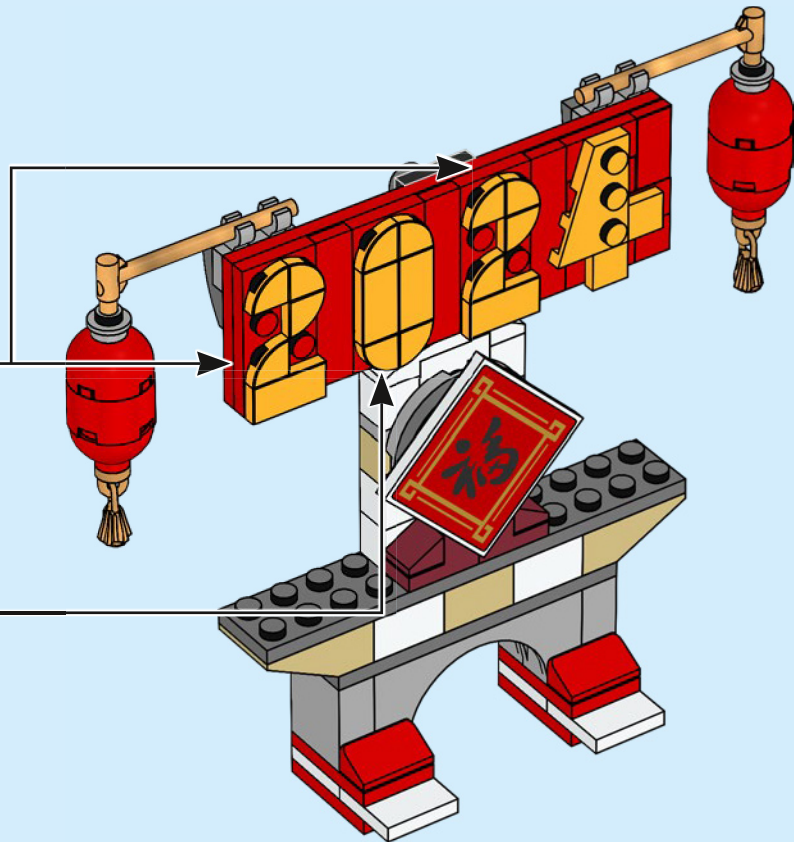
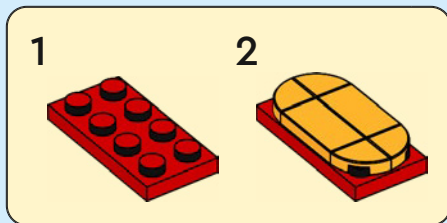
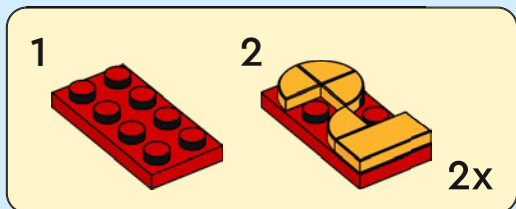

31

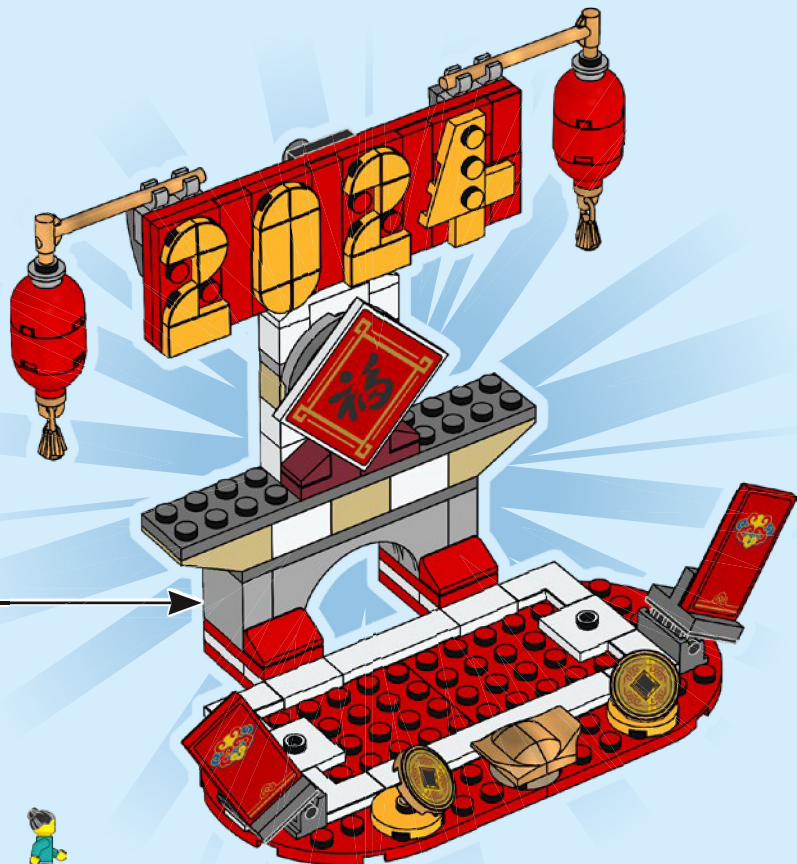

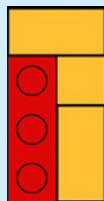
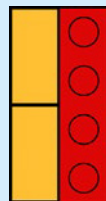
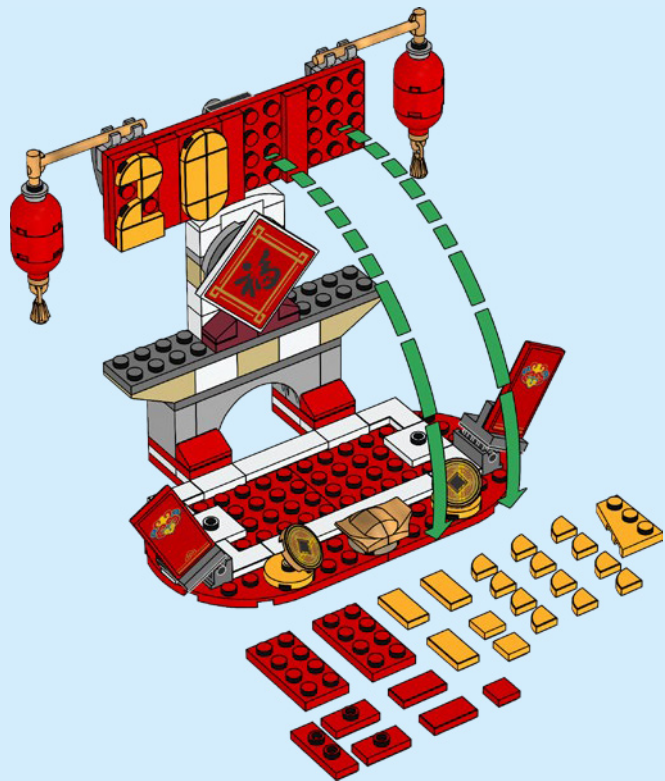

32

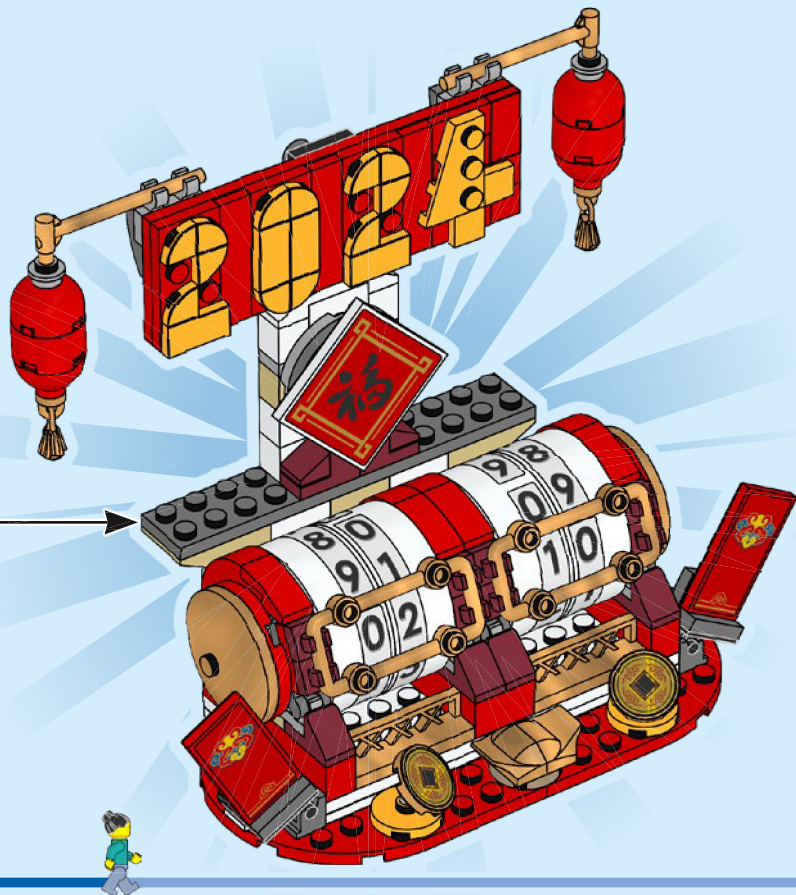

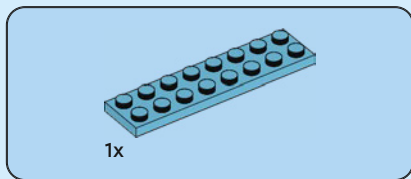
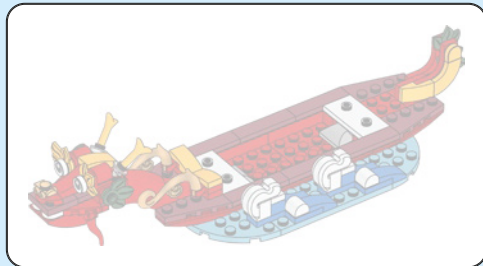

1

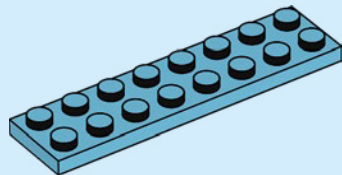

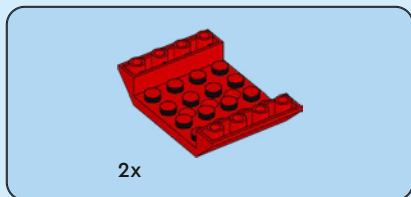

2

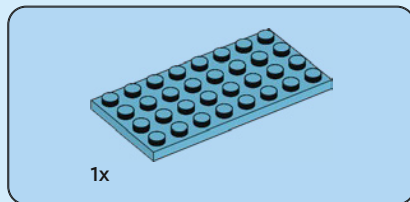
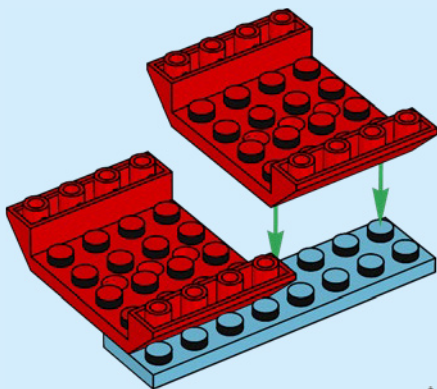

3

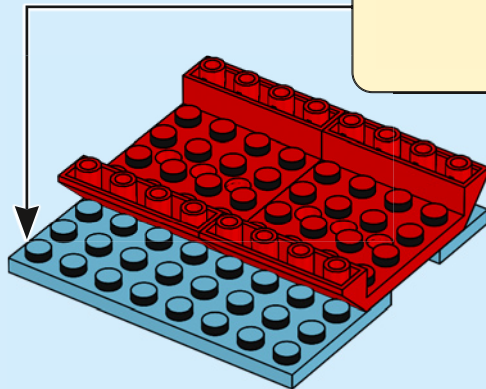
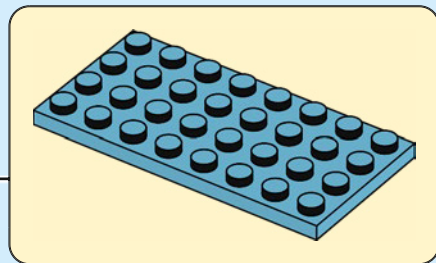

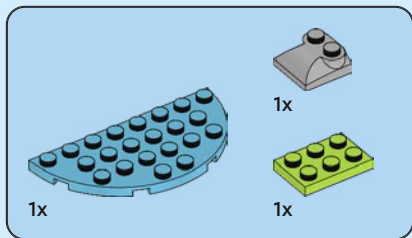

4

1

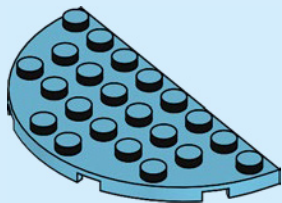

2

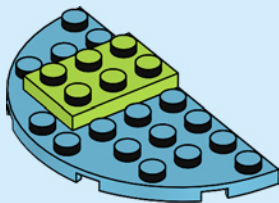

3

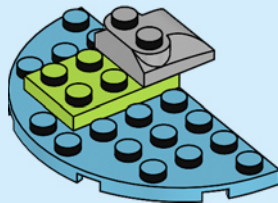

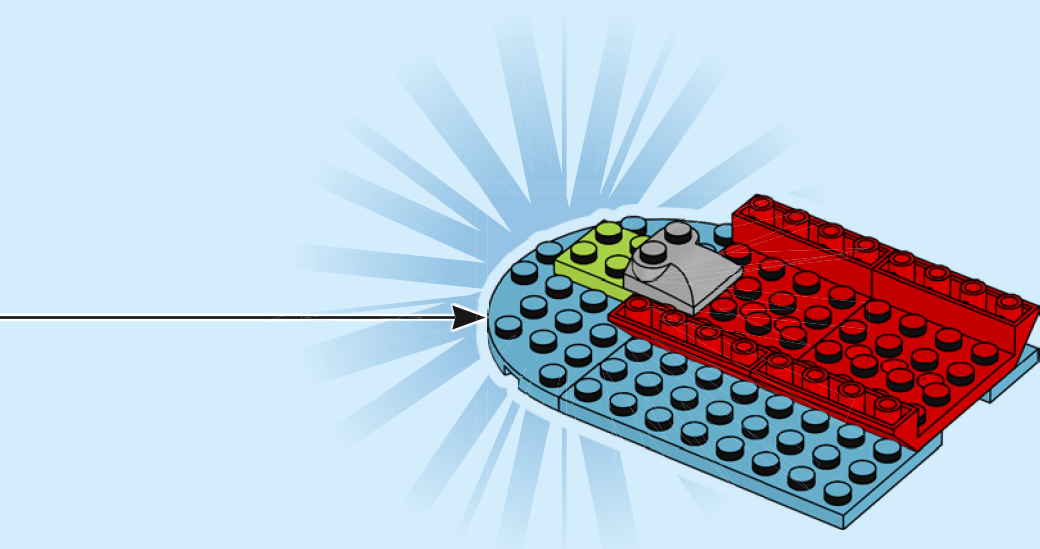

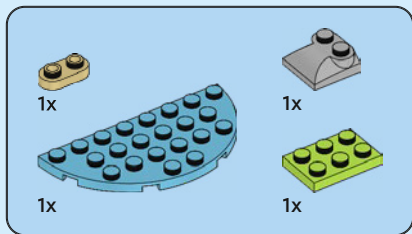

5

1

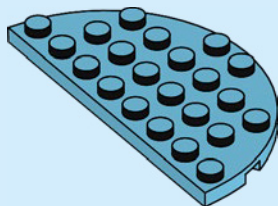

2

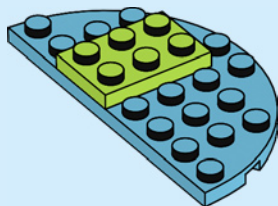

3

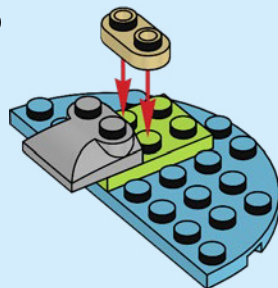

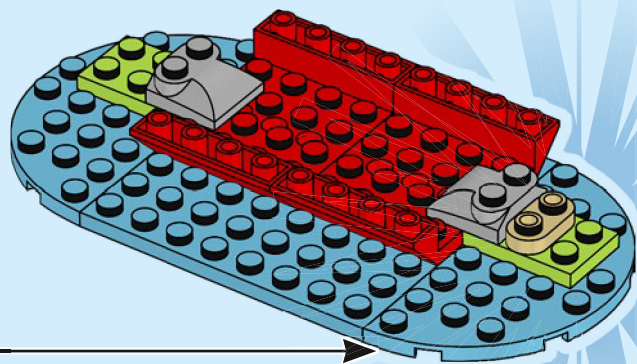

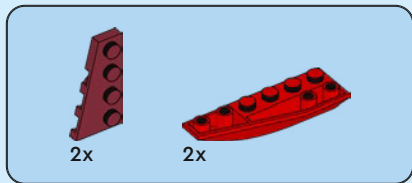

6

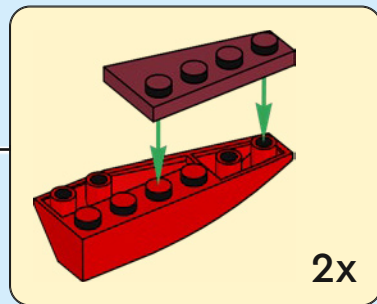
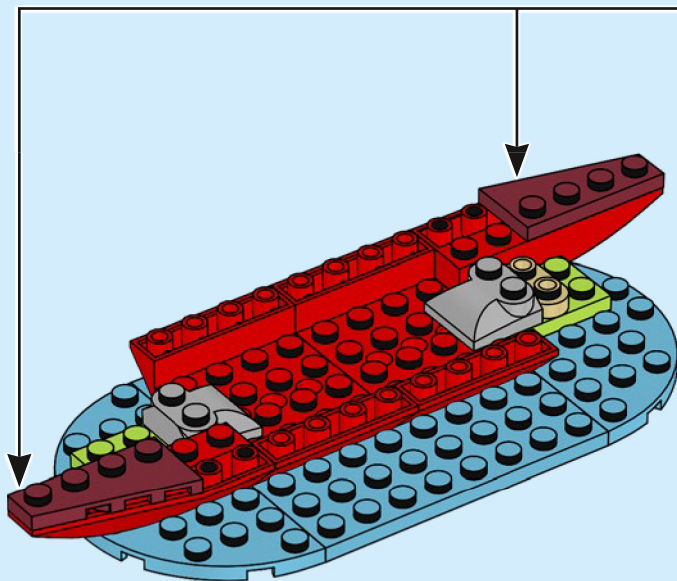

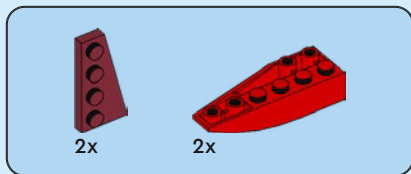

7

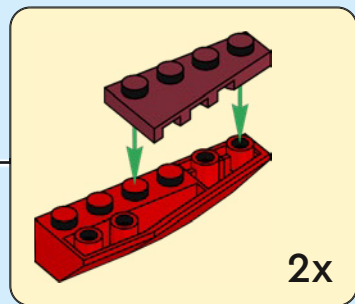
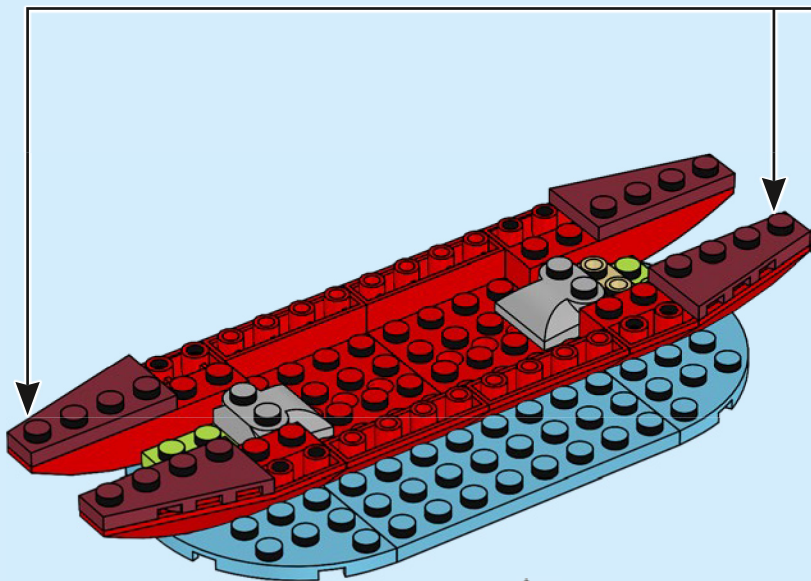

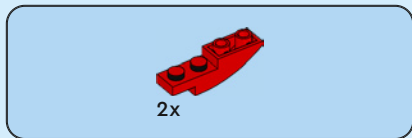

8

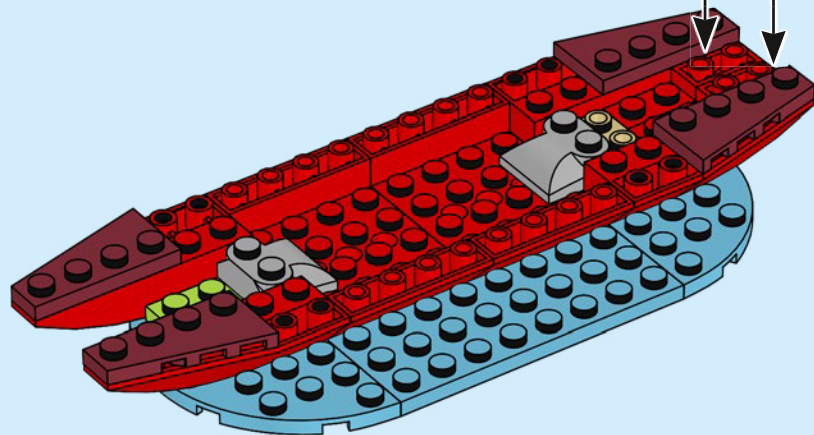
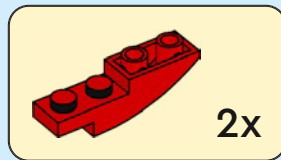

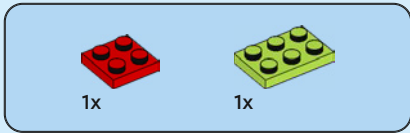

9

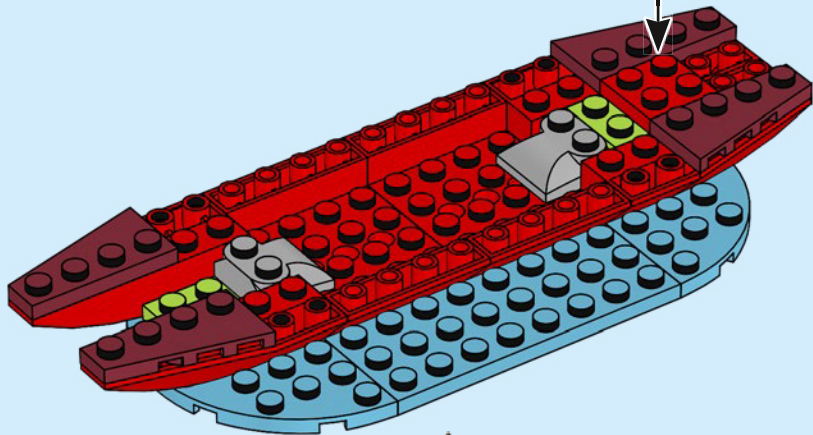
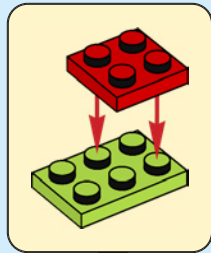

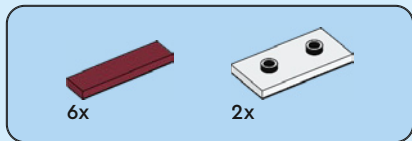

10

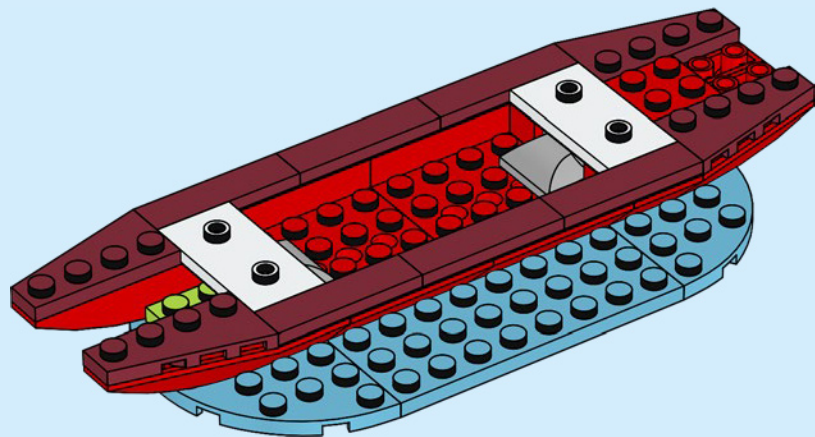

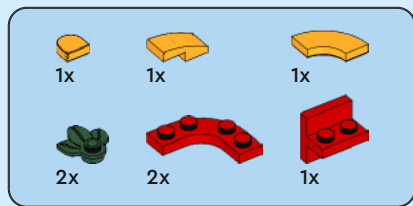

11

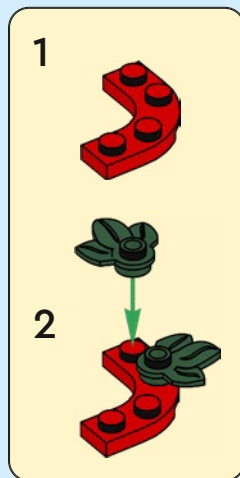

1

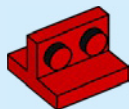

2

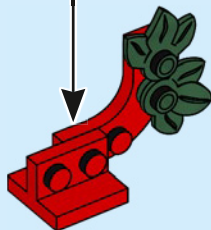

3

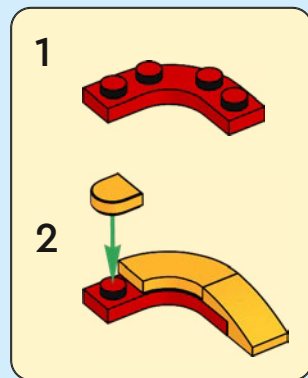
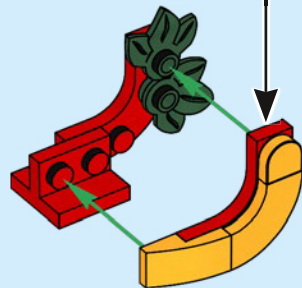

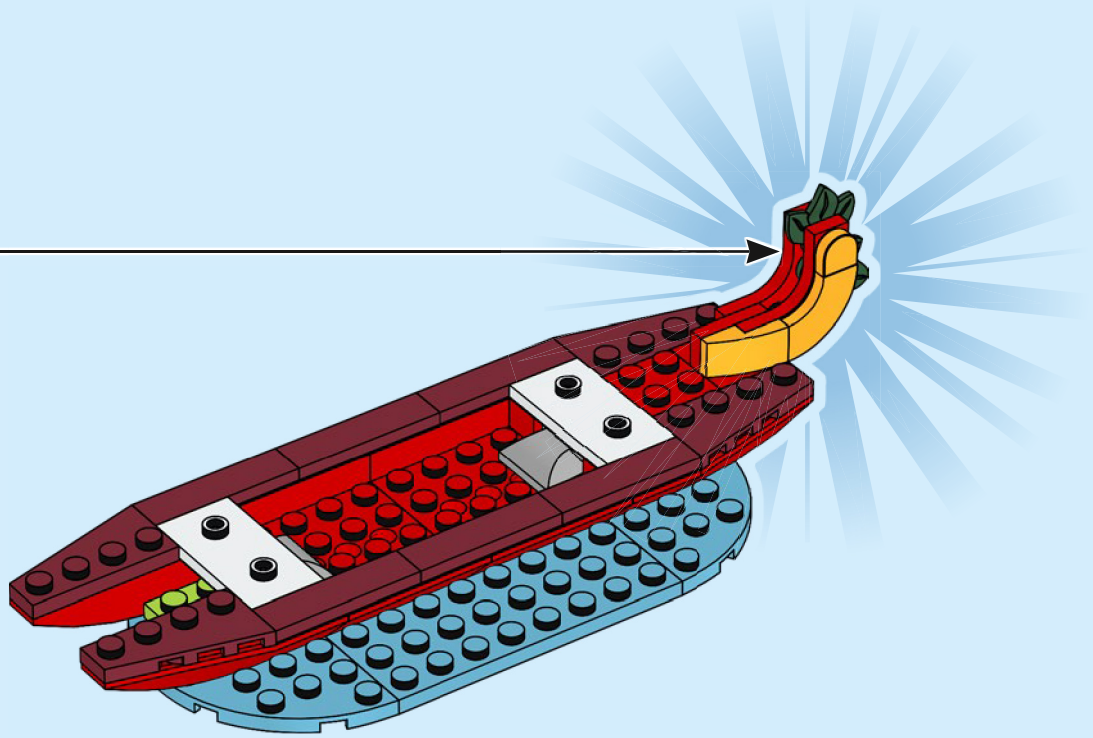

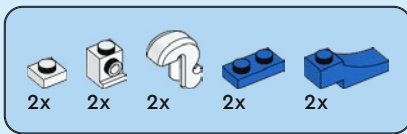

12

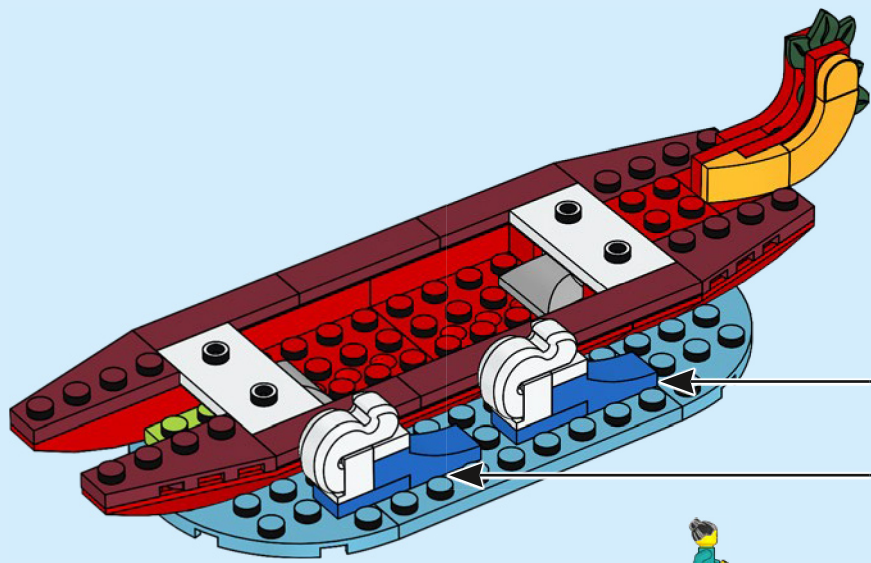
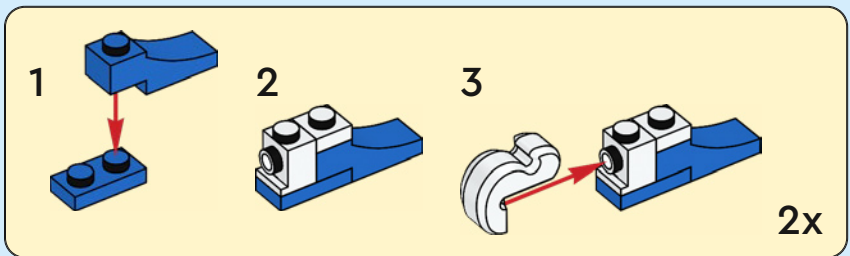



2x



2x



2x

13

1

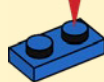

2



2x

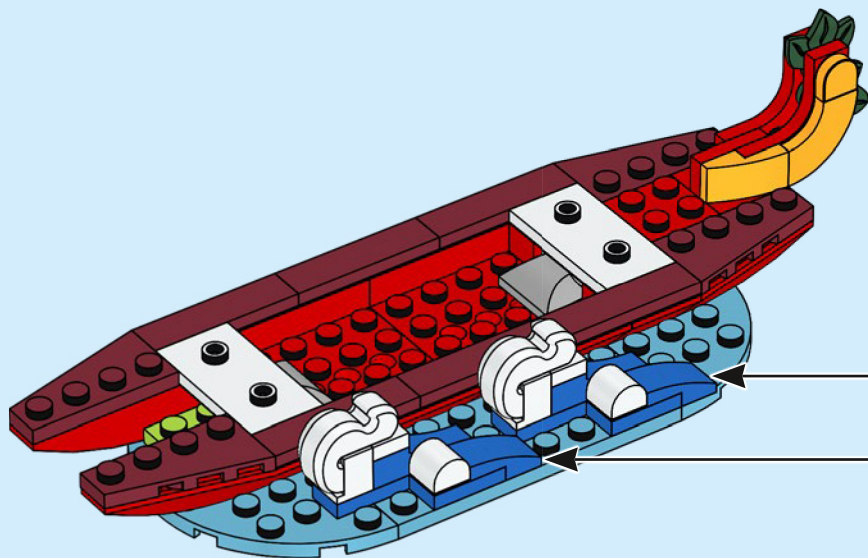

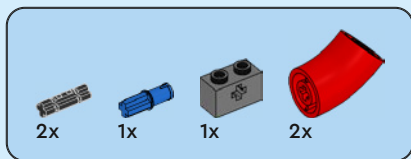

14

1

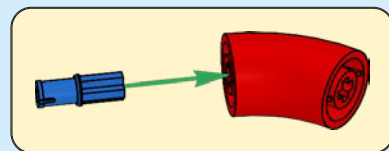
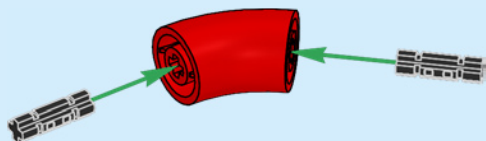

2

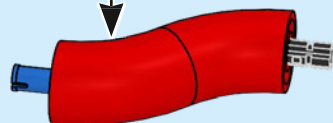

3

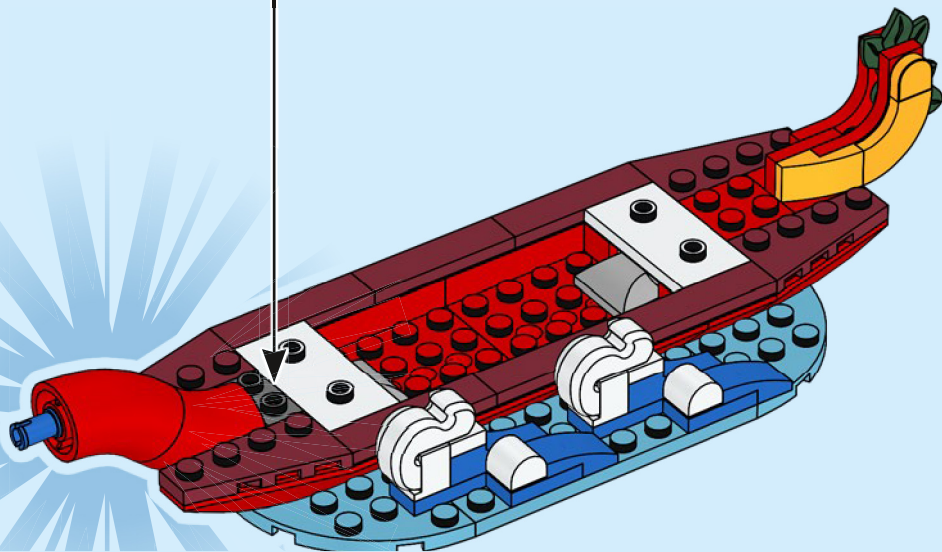
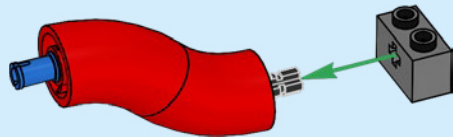

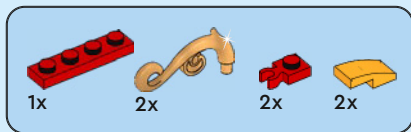

15

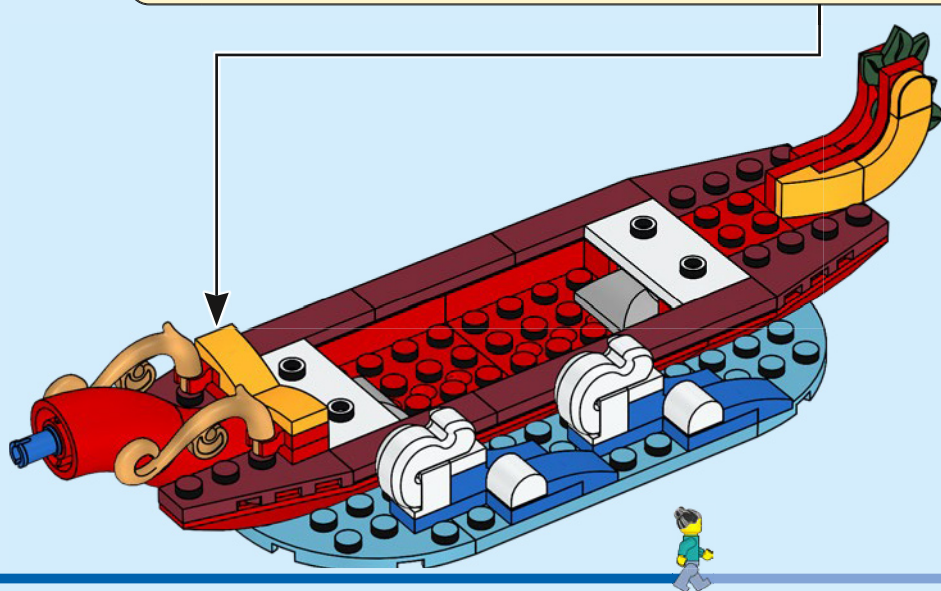
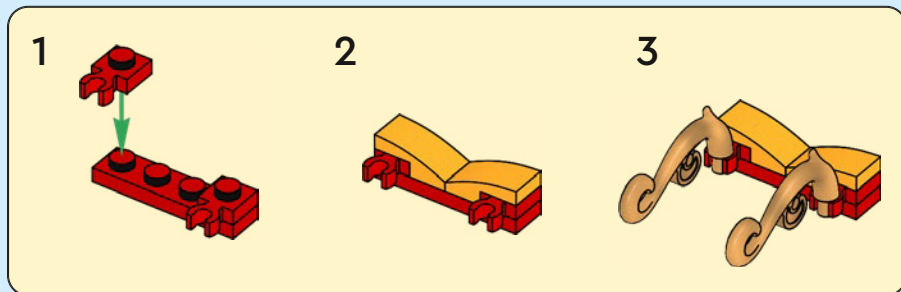

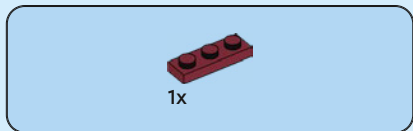

16

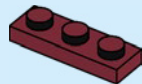

17

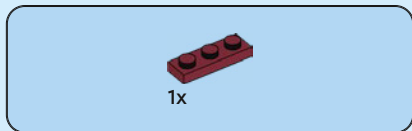
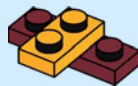

18





3x

19

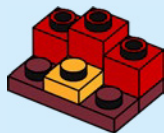

2x

20

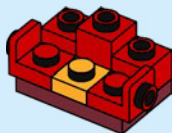

1x

21

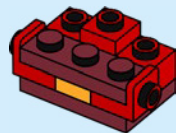

2x



1x

22

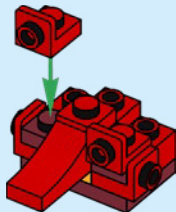

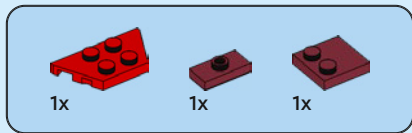

23

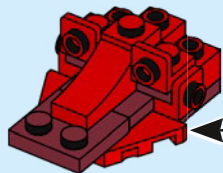
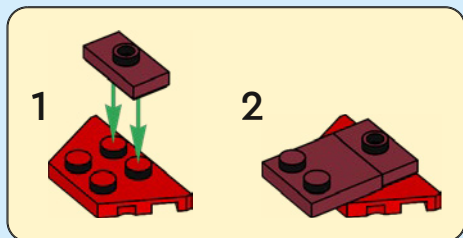

24

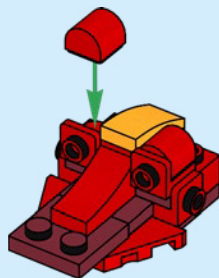



1x



1x



2x

25

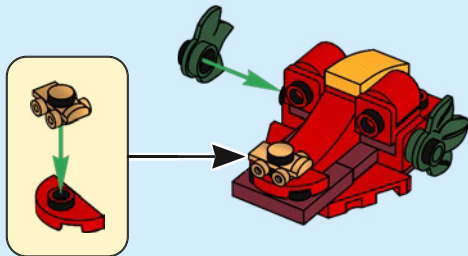

1x

26

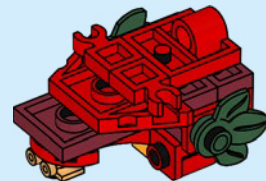

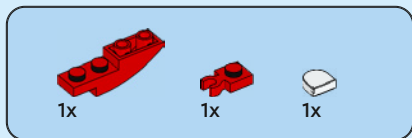

27

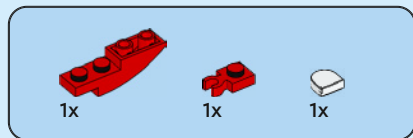
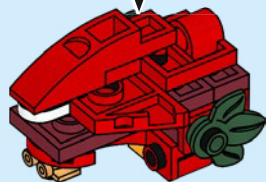
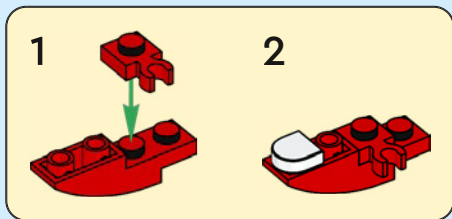

28

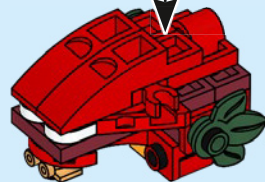
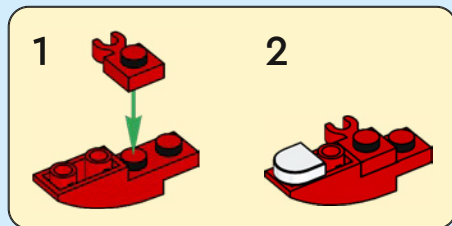



2x



2x

29

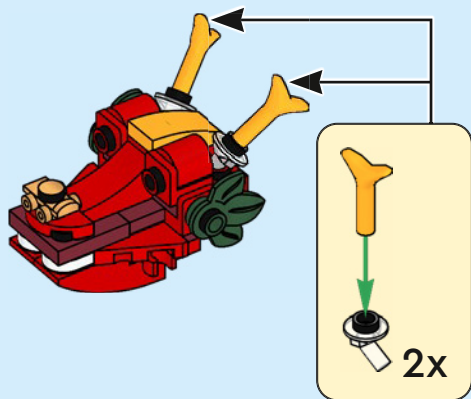

2x



2x



2x

30



31

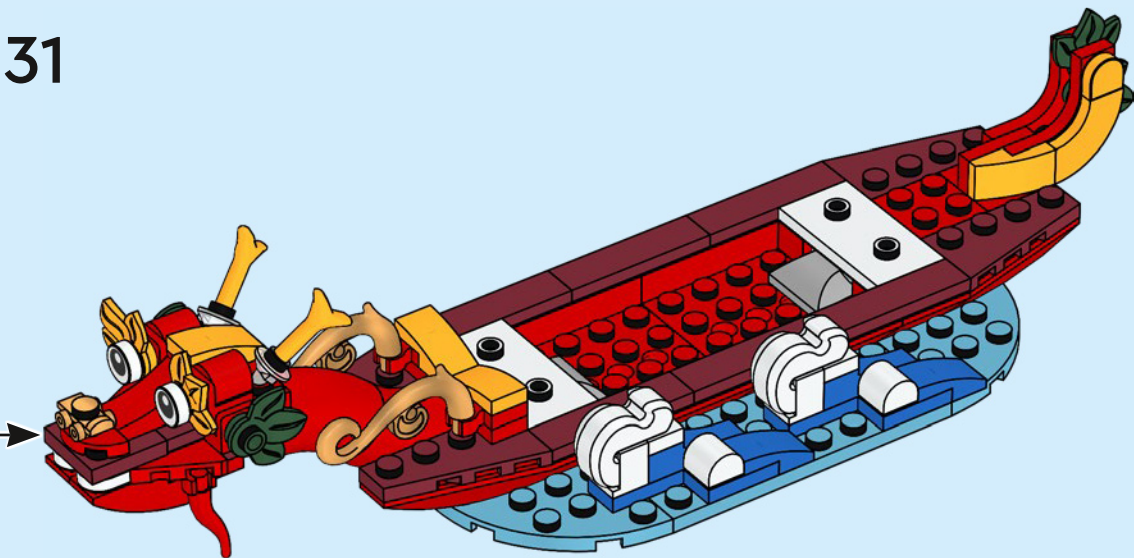

32

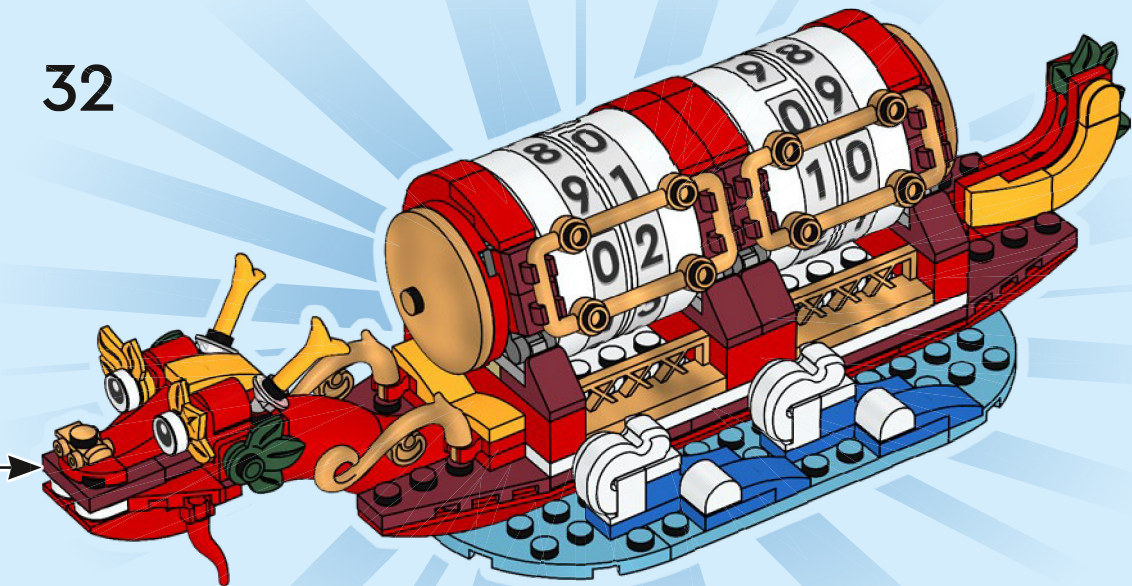

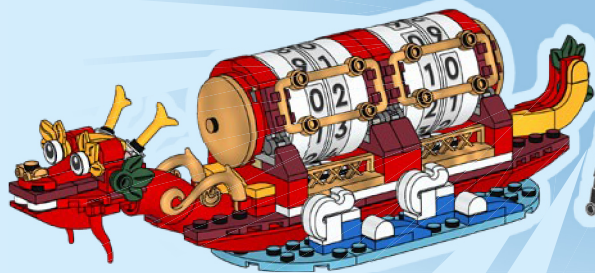

2x
6284599
 2x
6250591
 6x
6258135
 2x
407001
 2x
302401
 2x
300501
 2x
4504369
 2x
6222201
 1x
403201
 1x
6406522
 2x
6218822

2x
302201
 4x
6058329
 2x
6126046
 2x
300301
 1x
302101
 2x
301001
 1x
6023806
 1x
243101
 2x
6315024

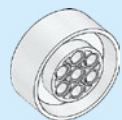

4x
6466803



1x
6400128

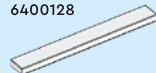

1x
416201

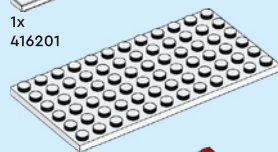

1x
4120020



1x
4514717

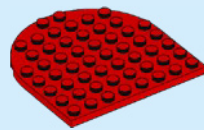

2x
6471614



1x
6170487

10x
6341972
 3x
6397571
 2x
6278441
 1x
307021
 4x
6249907
 1x
6400110
 4x
6337002
 2x
6065839
 2x
4651524
 2x
6429055
 2x
614321

8x
302321
 2x
6092565
 2x
306921
 4x
6029946
 1x
6393287
 2x
6269079
 1x
6014616
 1x
302221
 1x
6209519
 1x
6365716
 1x
6251410

4x
6212012
 1x
6434947
 2x
6349633
 1x
6023770
 4x
302121
 4x
6057432
 1x
371021
 3x
243121
 2x
4515348

2x
6462445
 4x
302021
 2x
4560179
 2x
300921
 2x
6447090
 1x
4181138
 2x
6447087
 2x
6346112

1x
4206482

4x
302323

2x
6055065

2x
6439891

1x
6215170

1x
6116616

4x
6285587

1x
6310580

4x
6310282

3x
6013530

4x
4159553

1x
6212758

2x
4114084

1x
6347700

2x
4500453

1x
4234365

4x
4113233

1x
4267425

1x
4162916

2x
4531415

8x
6360079

2x
6008593

2x
6008595

1x
6092597

6x
6251611

1x
6214309

3x
4539076

6x
4539060

1x
6313554

20x
6214457

2x
6065504

1x
6020145

2x
6378797

2x
6133933

2x
6096682

1x
6028736

4x
6099728

6x
4622062

1x
6334203

2x
6168647

2x
4211564

4x
6326078

2x
6337268

2x
4494475

2x
4211429

1x
4211445

1x
6167798

1x
4211395

2x
6106189

4x
6400754

1x
6454938

1x
6178919

2x
4211066

1x
4211063

2x
6250018



2x
6344820



2x
6015356



4x
4521187



1x
4528323



1x
4210997

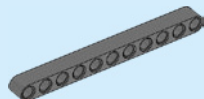

1x
4603472

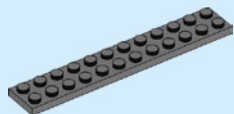

1x
4211067

11



2x
6274711



1x
6328909



1x
6132266



2x
6335111



3x
6066345



2x
6375715



2x
6172437



2x
4536675



2x
6062162



2x
6468173



2x
6468173



4x
6335566



2x
6138571

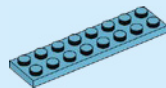

1x
6253666

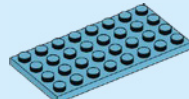

1x
6104130



2x
6441065



1x
6417267



1x
6292569



2x
4109810



2x
6279875



1x
6440995



1x
300326



2x
4124096



2x
6328479



1x
6440995



 [LEGO.com/service](https://www.LEGO.com/service)

YOU COULD **WIN**



Scan this QR code or go to **LEGO.COM/PRODUCTFEEDBACK** and give us your short feedback about this LEGO® set for a chance to win a cool LEGO prize.

Terms and Conditions apply*

EN: YOU COULD WIN. Terms and Conditions apply* **DE: Du könntest GEWINNEN.** Es gelten die Teilnahmebedingungen* **FR: Tu pourrais GAGNER.** Des conditions s'appliquent* **IT: Potresti VINCERE tu.** Termini e condizioni sono applicabili* **ES: Puedes GANAR.** Aplican términos y condiciones* **PT: Poderá GANHAR.** Aplicam-se termos e condições* **ZH: 轻松获奖. 条款和条件适用*** **PL: Szansa na WYGRANĄ.** Obowiązują warunki korzystania* **CS: Máte šanci VYHRÁT.** Platí všeobecné smluvní podmínky* **SK: Máte šancu VYHRAŤ.** Platia všeobecné zmluvné podmienky* **HU: TE IS NYERHETSZ.** Felhasználási feltételek érvényesek* **RO: Ai putea CÂȘTIGA.** Se aplică termenii și condiții* **BG: Можете да СПЕЧЕЛИТЕ.** Има определени правила и условия* **LV: Tu vari LAIMĒT.** Ir spēkā noteikumi un nosacījumi.* **ET: Sul on võimalus VÕITA.** Kehtivad tingimused* **LT: Jūs galite LAIMĖTI.** Taikomos sąlygos*

*[LEGO.com/productfeedback-terms](https://www.lego.com/productfeedback-terms)

LEGO and the LEGO logo are trademarks of the/son des marques de commerce du/son marcas registradas de LEGO Group. ©2024 The LEGO Group.

6490242