



BRICK HEADZ

40622



Booklet available in English on
Heft in deutscher Sprache erhältlich auf
Livret disponible en français sur
Libretto disponibile in italiano su
Folleto en español disponible en
如需中文版手册, 请访问:

[LEGO.com/service/buildinginstructions](https://www.lego.com/service/buildinginstructions)



[LEGO.com/brickheadz](https://www.lego.com/brickheadz)



LEGO.com/sustainable-packaging



Disney
100

For a century, Disney movie magic has captured generations of fans worldwide. Join us in celebrating four trail-blazing, animated heroes who each made Disney™ history.

OSWALD THE LUCKY RABBIT

This peppy little prankster's talent for thinking on his (lucky) feet always gets him out of comical predicaments. Oswald tackles every tricky situation with (sometimes unwarranted) confidence and a savvy sense of humour. Oswald first debuted in *Trolley Troubles* in 1927 and was featured in 25 theatrical cartoons. In 1928, rights were acquired by Universal Studios and Walt Disney was forced to explore new directions.



"Oswald will not only be able to hold his own with competition but will set a pace that will make the others hustle."

- Walt Disney



Disney
100



MICKEY MOUSE

After all these years, Mickey Mouse remains as plucky and joyfully mischievous as ever. A loyal and caring friend and leader, he relies on his generous heart, humour and keen wit to solve every problem, and his curiosity and passion for exploring new things take him on incredible adventures with his friends. Mickey Mouse starred in Disney's first cartoon with synchronised sound; *Steamboat Willie* (1928), which led to the successful growth of the Walt Disney Studios. In celebration of his 50th anniversary on 13 November 1978, Mickey became the first cartoon character ever to receive a star on the Hollywood Walk of Fame.

"When people laugh at Mickey Mouse it's because he's so human, and that is the secret of his popularity"

- Walt Disney



Disney
100

SNOW WHITE

Born a princess, yet treated poorly by her wicked stepmother, Snow White takes her trials in stride. She finds a new, loving home with the Seven Dwarfs in their humble yet cosy cottage. With her mild, joyful manners and caring nature, she wins the trust and devotion not only of the Dwarfs, but of all animals and creatures she encounters. *Snow White and the Seven Dwarfs* (1937) was Walt Disney's first full-length animated film. Critics believed nobody would pay to watch a full-length cartoon movie, yet Disney believed in the story and, over time, the movie has become the highest-grossing animated film.



"I dream, I test my dreams against my beliefs, I dare to take risks and I execute my vision to make those dreams come true."

- Walt Disney



Disney
100

TINKERBELL

Tinkerbell's delicate figure holds a strong, bubbly personality: She is feisty and sassy with friends and adversaries alike. She can mend everything from pots and pans to intricate, mechanical contraptions, and help others fly with a sprinkle of her pixie dust on her adventures in Neverland and beyond. From the popular side character in the *Peter Pan* movie (1953), Tinkerbell became the first mascot for the *Walt Disney's Disneyland* TV show (1954). She is still an unofficial mascot for Disney Parks around the world and on our screens, where her pixie dust fireworks whisk us into magic realms. Since 2005, she has been the central figure in the Disney Fairies franchise, and in 2010, she received her star on the Hollywood Walk of Fame.



*"Laughter is timeless,
imagination has no age.
And dreams are forever."*

- Walt Disney

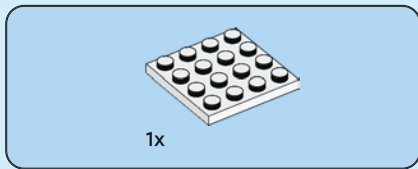

1

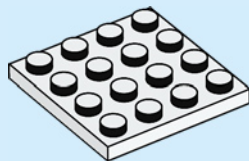



2x



1x

2

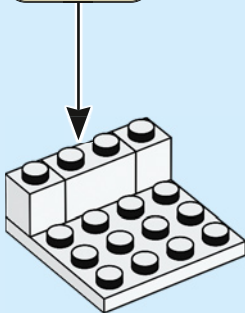
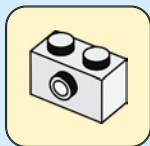

1x

3

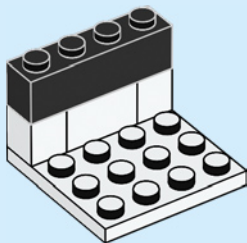



2x



1x



2x

4

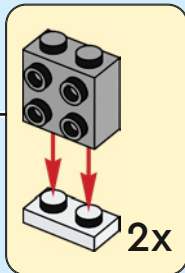
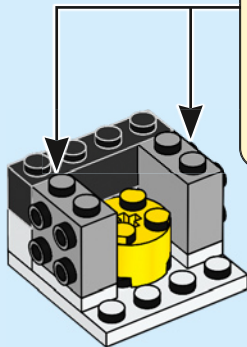

2x



1x



2x

5

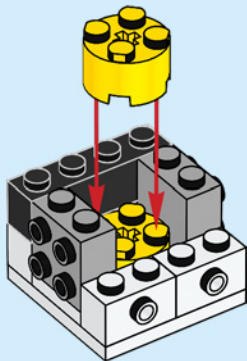



2x

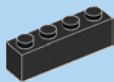

1x

6

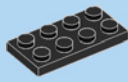
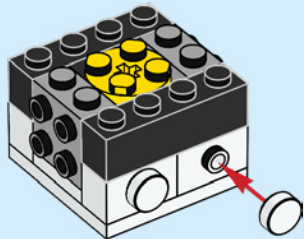

1x



2x

7

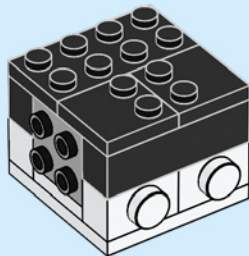



2x

8

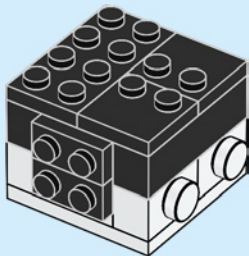

1x



1x

9

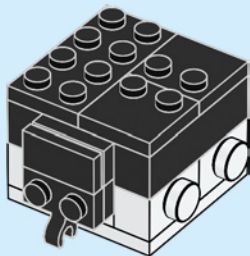



2x

10

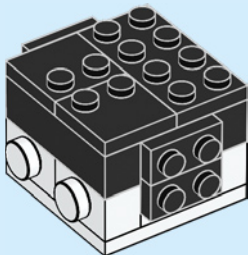

1x



1x

11

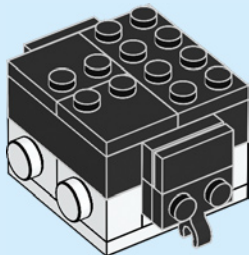



3x

12

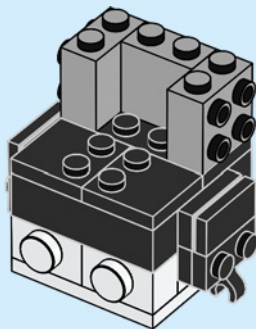



2x



1x

13

1

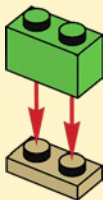

2

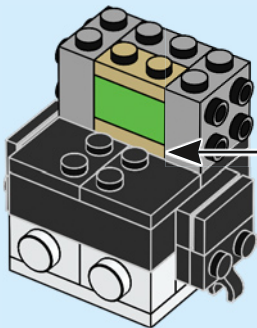
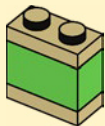



2x

14

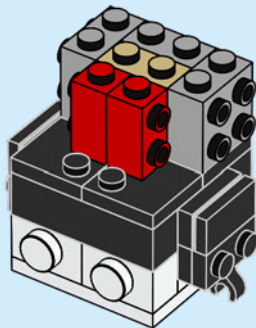

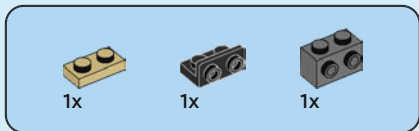

15

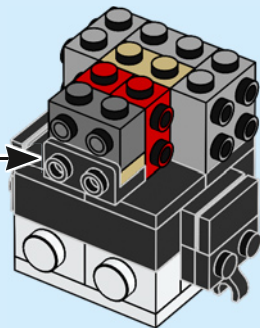
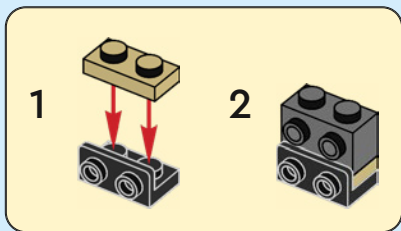



2x



2x

16

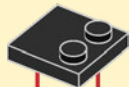
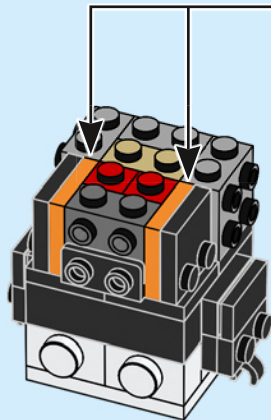

2x



2x

17

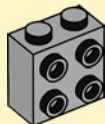

2x

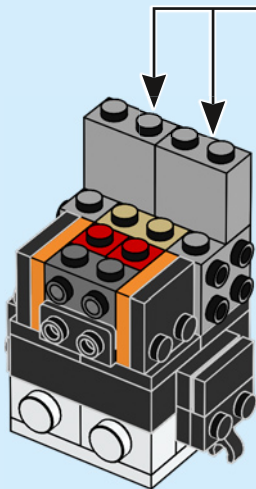



2x

18

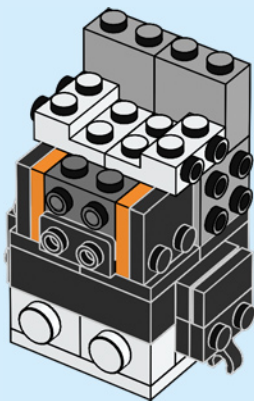



1x



2x

19

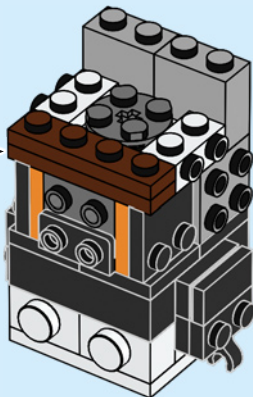
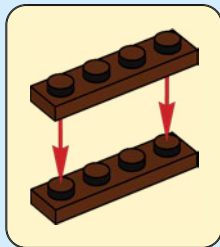



2x



1x

20

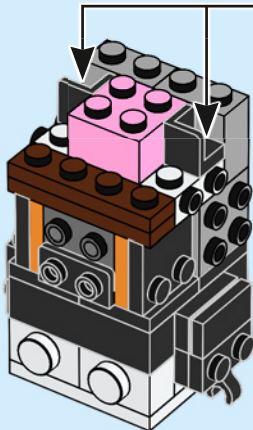

2x



3x

21

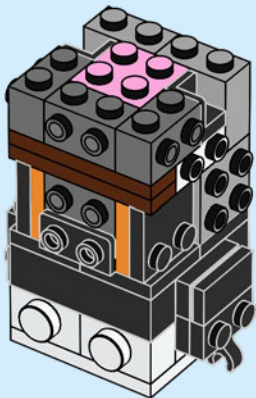



1x



1x



1x

22



1



2

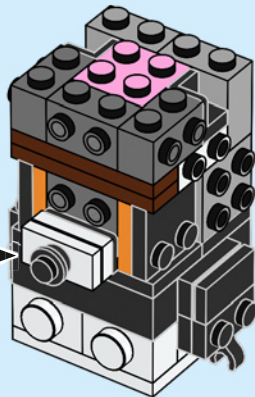

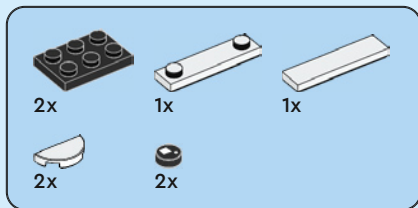

23

1

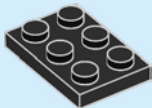

2

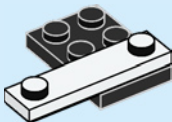

3

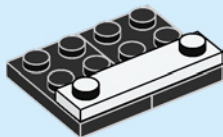

4

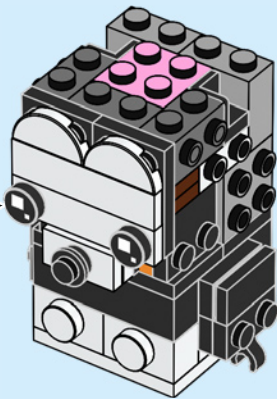
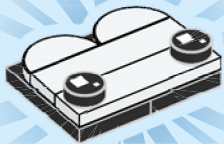

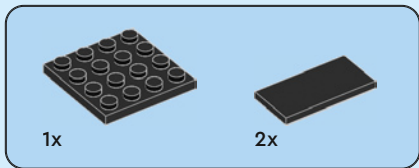

24

1

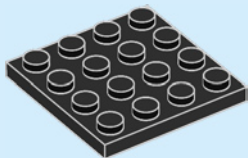

2

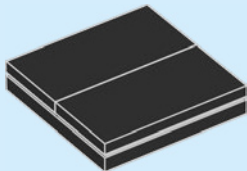

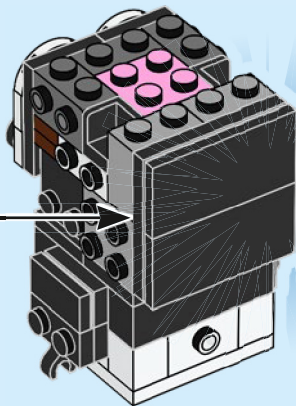



1x



1x

25

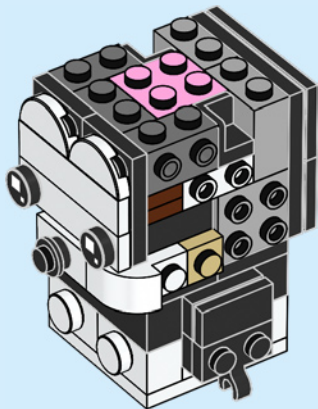

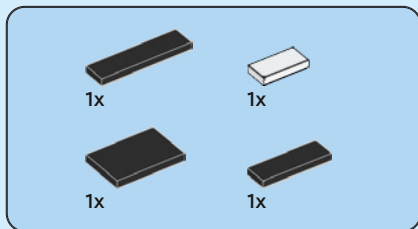

26

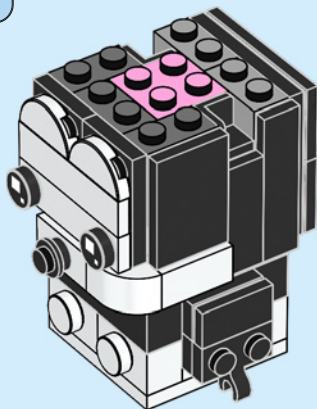



1x



1x

27

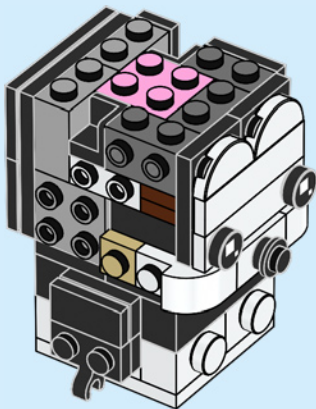

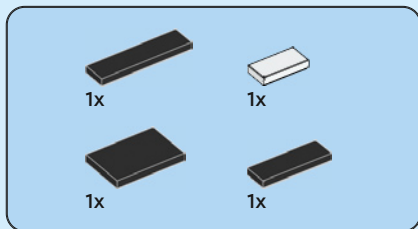

28

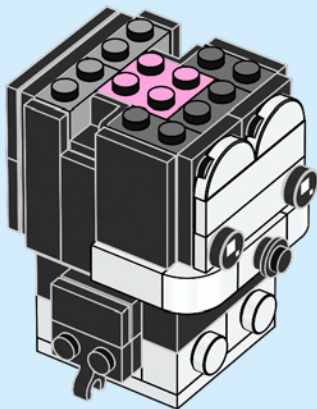



2x

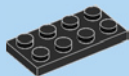

1x

29

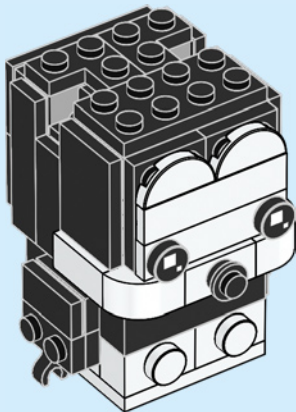



1x



2x



2x

30

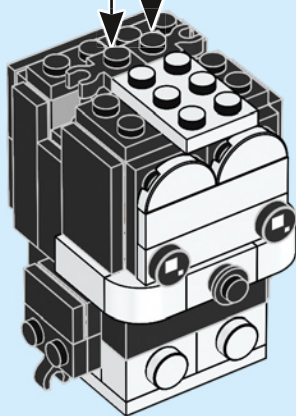

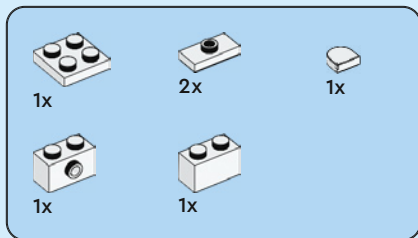

31

1



2

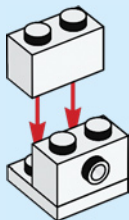

3

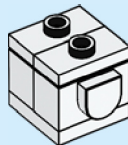

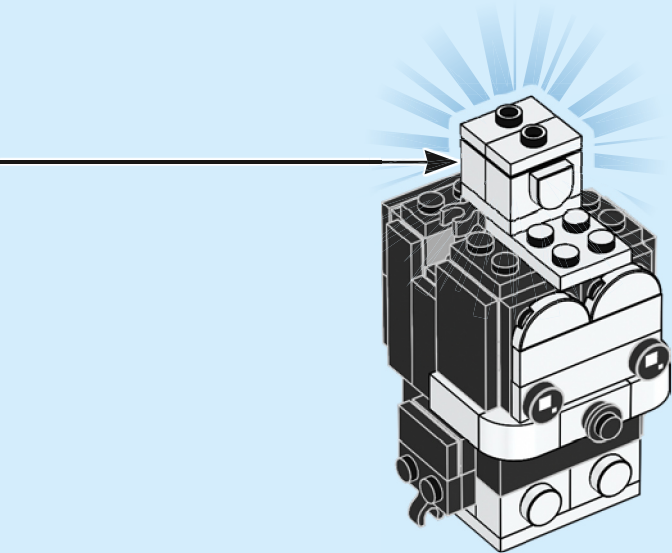

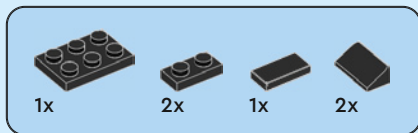

32

1

2

3

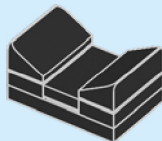
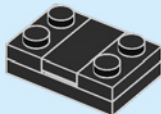

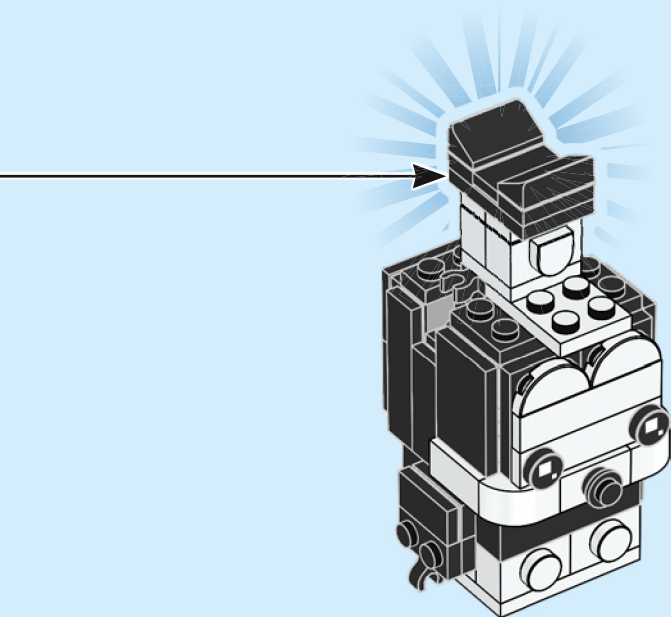



2x

33

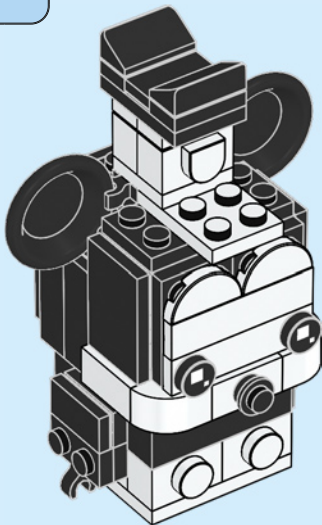

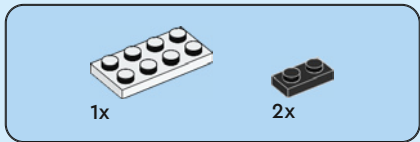

34

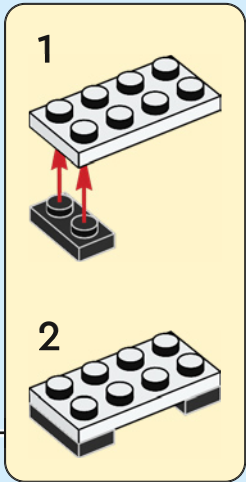
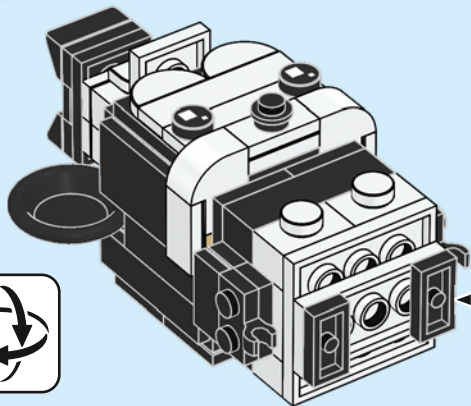



2x



2x



4x

35

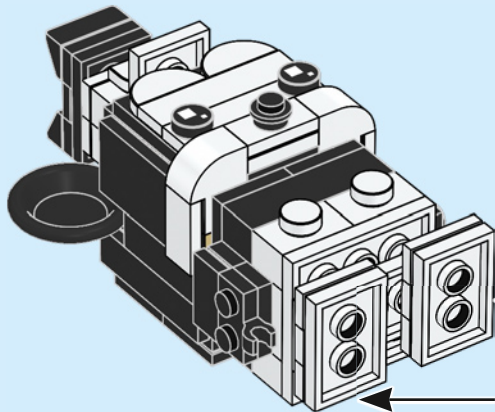

1

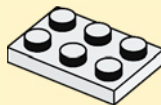

2

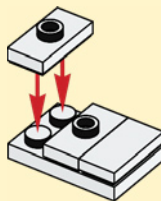

2x



1x

36

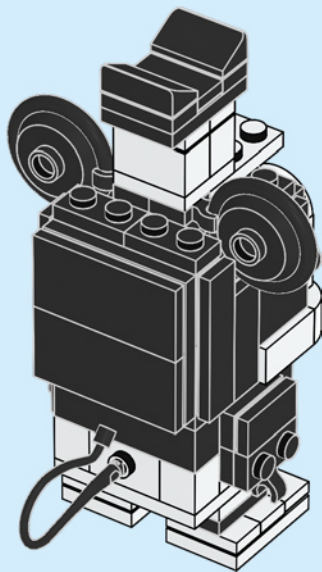

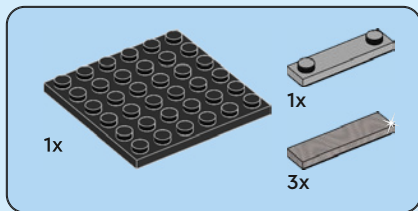

37

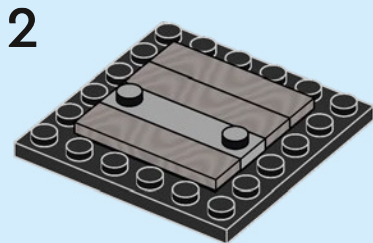
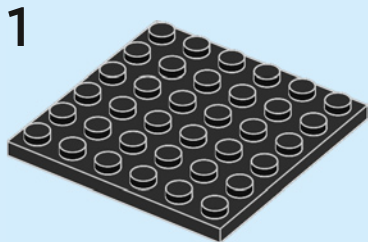

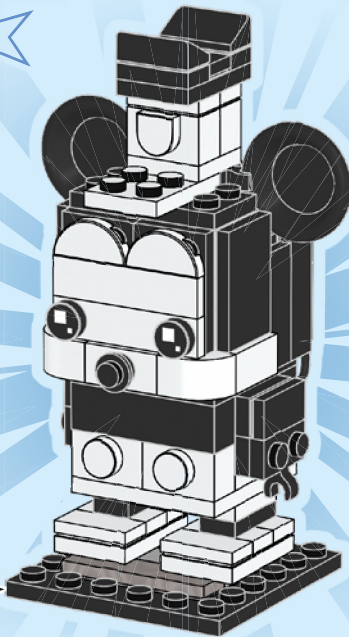

4x
6284572

1x
6250591

2x
300501

2x
302401

2x
6172366

1x
6132203

4x
6400114

1x
6132204

2x
6174937

44

1x
614301

4x
6383982

7x
6051511

5x
302301

1x
300401

4x
306901

2x
6285777

4x
302201

1x
6126046

2x
6046979

3x
302101

1x
6249091

2x
243101

1x
302001

1x
4243812

6x
4159553

2x
4624086

11x
4113917

4x
4114026

4x
6313119

2x
6173057

5x
4114084

4x
4118790

4x
4550324

2x
6257600

1x
4243824

2x
6187620

4x
4504379

4x
403221

1x
302321

2x
300321

1x
371021

4x
300523

1x
6430680

2x
301023

1x
302023

2x
614324



6x
6248833



8x
6284077



2x
614126



1x
4290713



2x
4106347



6x
302426



6x
307026



6x
4504382



2x
6181720



4x
6172383



4x
6228987



2x
6330189



2x
6181713



2x
4548180



8x
306926



2x
242026



16x
302326



4x
6313116



8x
6047276



2x
6347310



4x
6184784



3x
6020193



2x
4107761



4x
6192346



5x
6053077



5x
302226



2x
4515368



2x
6433560



2x
4558170



2x
362326



2x
6162892



8x
302126



2x
6147790



2x
243126



4x
301026



1x
6019726



3x
371026



2x
6037746



2x
302026



8x
4560182



2x
6350415



1x
4647553



2x
6252043



2x
4159007



2x
4621557



1x
4500125



2x
4220634



2x
6365620



2x
6258408



2x
6247210



1x
6314224



4x
6310279



2x
4537937



4x
6433213



3x
4187743



1x
4164021



2x
4537936



2x
6375006



1x
6385485



2x
6295078



2x
4211190



46x
6123809



2x
6126082



2x
6118827



3x
6257593



2x
4211636



1x
4211042



4x
6230233



2x
6336860



1x
4654128



3x
4550359



2x
6096589



6x
6058014



4x
6228969



2x
6296498



6x
6275877



4x
6296494



2x
6201647



2x
6022083



2x
6296519



1x
6316265



12x
6296487



1x
6424475



2x
6296492



4x
6344840



4x
6248756



2x
6147726



5x
6296524



2x
4622176



1x
6296849



1x
6167643



2x
6345712



2x
6225538



4x
4653988



2x
6430724



1x
6151671



1x
6213272



3x
6210675



2x
6099349



11x
6409129



2x
6258091



4x
6339228

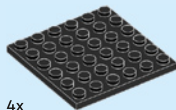

4x
395826



1x
6359865

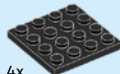

4x
4243819

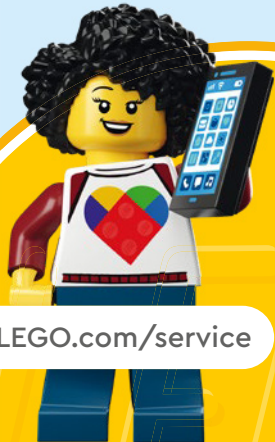

[LEGO.com/service](https://www.LEGO.com/service)

YOU COULD
WIN



Scan this QR code or go to
LEGO.COM/PRODUCTFEEDBACK and give us
your short feedback about this LEGO® set
for a chance to win a cool LEGO prize.

Terms and Conditions apply*

DE: Du könntest GEWINNEN. Es gelten die Teilnahmebedingungen* **FR: Tu pourrais GAGNER.** Des conditions s'appliquent* **IT: Potresti VINCERE tu.** Termini e condizioni sono applicabili* **ES: Puedes GANAR.** Aplican términos y condiciones* **PT: Poderá GANHAR.** Aplicam-se termos e condições* **JA: プレゼント付き! 利用規約が適用されます*** **ZH: 轻松获奖. 条款和条件适用*** **KO: 상품의 주인이 되어보세요. 소정의 약관이 적용됩니다*** **RU: Вы можете ВЫИГРАТЬ.** Действуют положения и условия* **PL: Szansa na WYGRANĄ.** Obowiązują warunki korzystania* **CS: Máte šanci VYHRÁT.** Platí všeobecné smluvní podmínky* **SK: Máte šancu VYHRATĚ.** Platia všeobecné zmluvné podmienky* **HU: TE IS NYERHETSZ.** Felhasználási feltételek érvényesek* **RO: Ai putea CĂȘTIGA.** Se aplică termenii și condiții* **BG: Можете да СПЕЧЕЛИТЕ.** Има определени правила и условия* **LV: Tu vari LAIMĒT.** Ir spēkā noteikumi un nosacījumi.* **ET: Sul on võimalus VÕITA.** Kehtivad tingimused* **LT: Jūs galite LAIMĖTI.** Taikomos sąlygos*

*[LEGO.com/productfeedback-terms](https://www.lego.com/productfeedback-terms)

LEGO and the LEGO logo are trademarks of the LEGO Group. ©2023 The LEGO Group.
©Disney

6467951