



**BRICK  
HEADZ**

40619



[LEGO.com/brickheadz](https://www.LEGO.com/brickheadz)



 **FR**  
**DONNEZ**  
OU  
**RECYCLEZ**

 OU  OU   
ASSOCIATION MAGASIN DÉCHÈTERIE

Adresses sur [quefairedemesdechets.fr](http://quefairedemesdechets.fr)



[LEGO.com/sustainable-packaging](https://LEGO.com/sustainable-packaging)

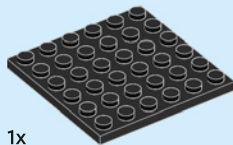
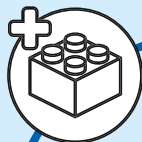

1x

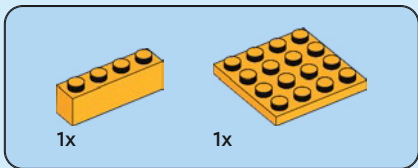
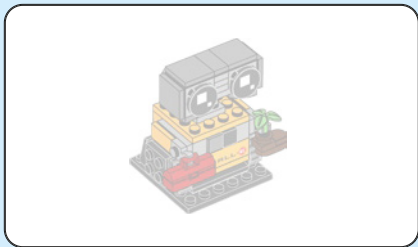

1

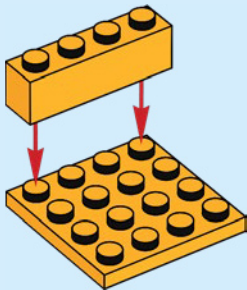



1x



2x

2

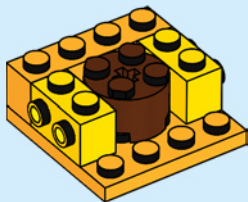

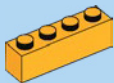

1x



1x

# 3

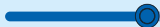



1x



2x



2x

4





1x



1x



2x

# 5

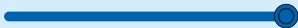
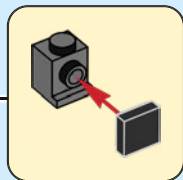
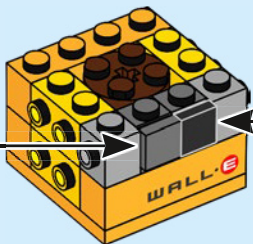
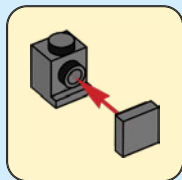



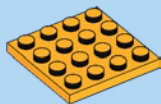

1x

6

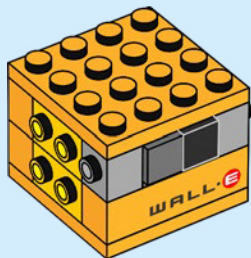

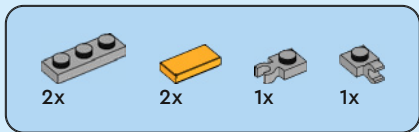

7

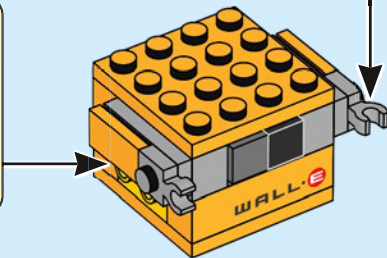
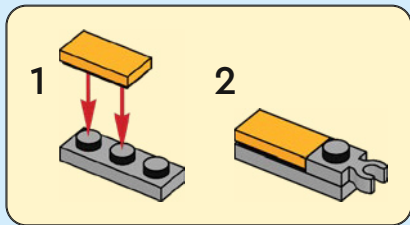
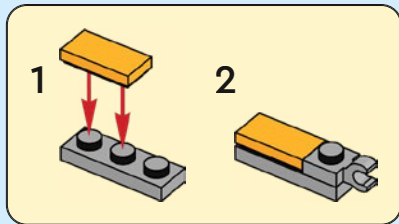



2x

8

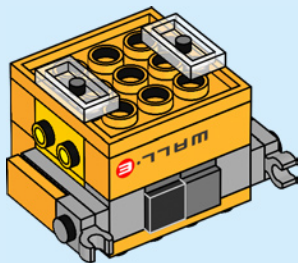



2x



4x



4x



4x

9

1

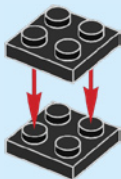

2

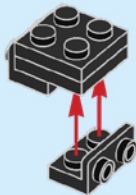

3

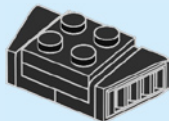

2x

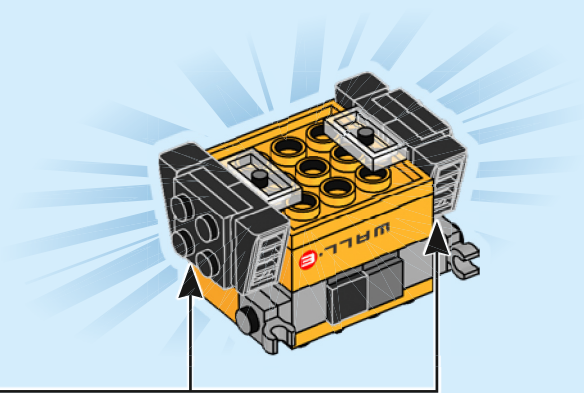



1x



1x

10

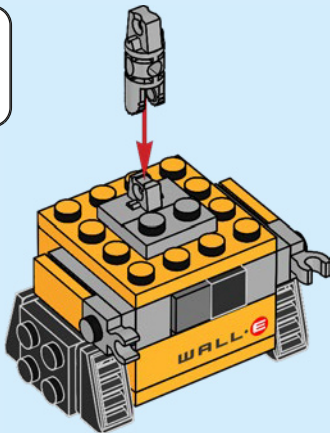



1x



1x

# 11

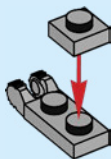

1x

# 12

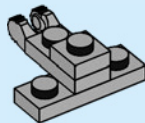



4x



1x

# 13

1

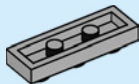

2

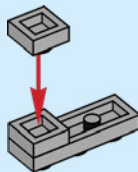



3

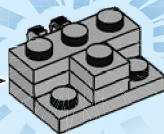
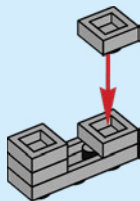



1x



2x

# 14

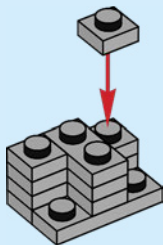



2x

15

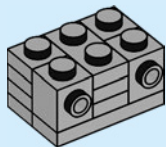



1x

16

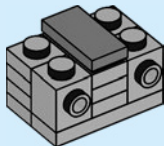



2x

17

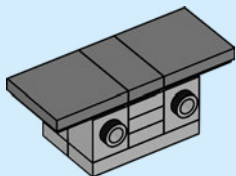



2x



2x

# 18

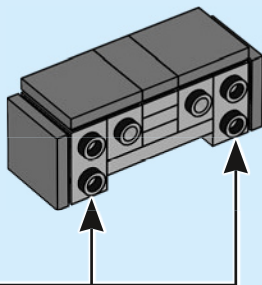
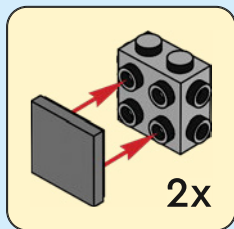



2x

19

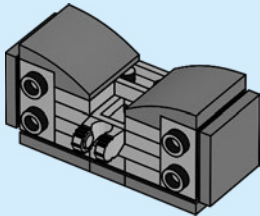



2x

20

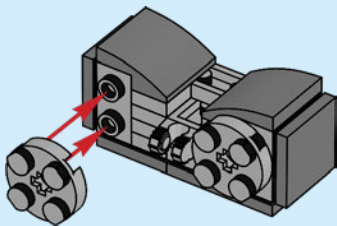

2x

21

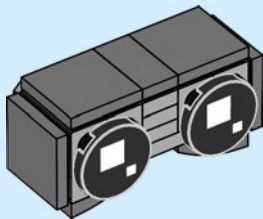



22

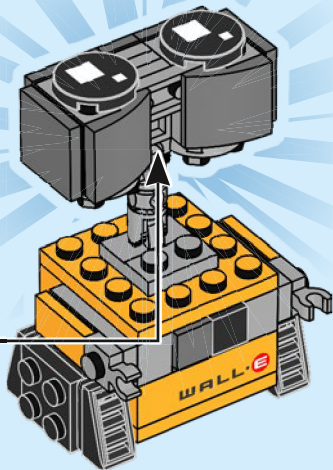



1x

23

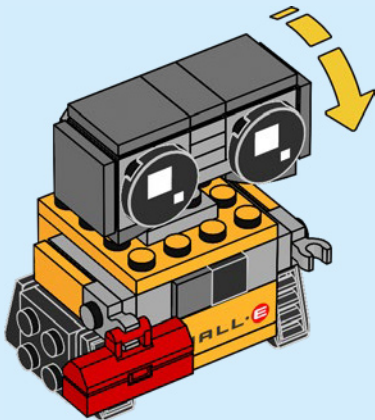

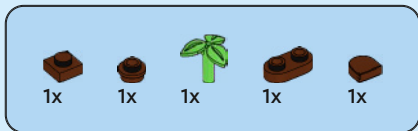

24

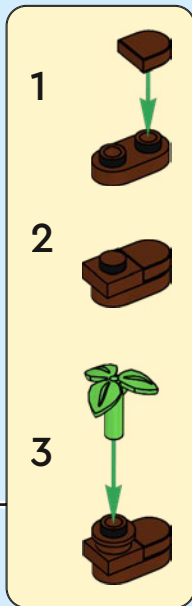
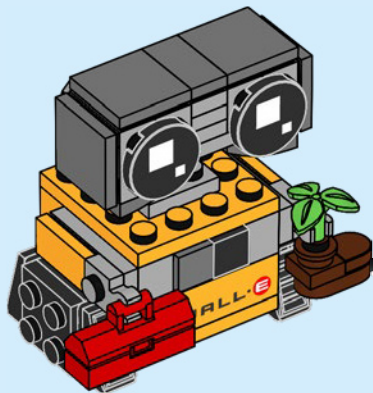

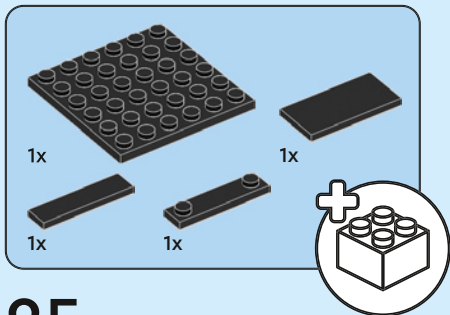

25

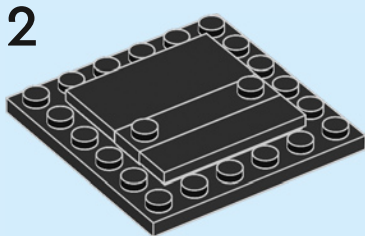
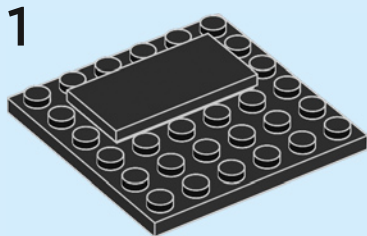

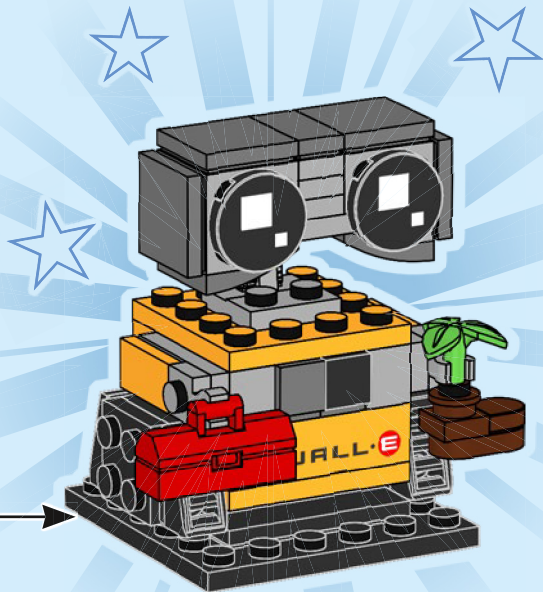



4x  
307001



4x  
6383985



4x  
4547489



2x  
6058177



2x  
300401



4x  
6138740



2x  
6218822



2x  
302201

**30**



4x  
6046979



2x  
6245249



4x  
302101



6x  
301001



1x  
243101



1x  
4560178



4x  
4583297



1x  
4243812



2x  
6250001



4x  
6119197



1x  
6206150



1x  
6235080



6x  
6240204



1x  
6239418



2x  
6258094



1x  
6273153



2x  
6322819



2x  
6371456



1x  
6060843



4x  
6172383



1x  
307026



2x  
6430739



5x  
306926



1x  
302326



4x  
4541191



4x  
6020193



4x  
302226



2x  
6254045



1x  
243126



2x  
4560182

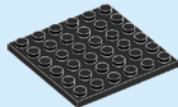

2x  
395826



2x  
4622062



1x  
6430740



2x  
6003004

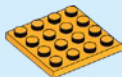

2x  
6093272



1x  
6215659



1x  
6328180



1x  
4221744



1x  
6248944



2x  
4211166



2x  
4211044



1x  
4210848



1x  
4211052



2x  
6344820



4x  
4211055



1x  
4550359



7x  
4211399



4x  
4558953



1x  
6335378



1x  
6296894



2x  
4211475



1x  
4211398



2x  
6301870



1x  
6267112



1x  
6265742



1x  
6267048



4x  
4211429



1x  
6383134



1x  
6314091



2x  
6380132



[LEGO.com/service](https://www.LEGO.com/service)

YOU COULD  
**WIN**



Scan this QR code or go to  
**LEGO.COM/PRODUCTFEEDBACK** and give us  
your short feedback about this LEGO® set  
for a chance to win a cool LEGO prize.  
Terms and Conditions apply\*

**DE: Du könntest GEWINNEN.** Es gelten die Teilnahmebedingungen\* **FR: Tu pourrais GAGNER.** Des conditions s'appliquent\* **IT: Potresti VINCERE tu.** Termini e condizioni sono applicabili\* **ES: Puedes GANAR.** Aplican términos y condiciones\* **PT: Poderá GANHAR.** Aplicam-se termos e condições\* **JA: プレゼント付き! 利用規約が適用されます\*** **ZH: 轻松获奖. 条款和条件适用\*** **KO: 상품의 주인이 되어보세요. 소정의 약관이 적용됩니다\*** **RU: Вы можете ВЫИГРАТЬ.** Действуют положения и условия\* **PL: Szansa na WYGRANĄ.** Obowiązują warunki korzystania\* **CS: Máte šanci VYHRÁT.** Platí všeobecné smluvní podmínky\* **SK: Máte šancu VYHRÁT.** Platia všeobecné zmluvné podmienky\* **HU: TE IS NYERHETSZ.** Felhasználási feltételek érvényesek\* **RO: Ai putea CÂȘTIGA.** Se aplică termenii și condiții\* **BG: Можете да СПЕЧЕЛИТЕ.** Има определени правила и условия\* **LV: Tu vari LAIMĒT.** Ir spēkā noteikumi un nosacījumi.\* **ET: Sul on võimalus VÕITA.** Kehtivad tingimused\* **LT: Jūs galite LAIMĖTI.** Taikomos sąlygos\*

\*[LEGO.com/productfeedback-terms](https://www.lego.com/productfeedback-terms)

LEGO and the LEGO logo are trademarks of the LEGO Group. ©2023 The LEGO Group.  
©Disney/Pixar

6505932