



40590





Get excited about our new packaging!

We're switching from plastic to paper-based packaging. That's why you might find a mix of paper and plastic in our boxes!

Nos nouveaux emballages vous emballeront !

Nous passons des emballages en plastique aux emballages à base de papier. C'est pourquoi vous pourriez trouver un mélange de papier et de plastique dans nos boîtes !

¡Te presentamos nuestros nuevos empaques!

Estamos sustituyendo las bolsas de plástico por bolsas con base de papel. ¡Por eso, puedes encontrar una mezcla de papel y de plástico en nuestras cajas!

[LEGO.com/sustainable-packaging](https://www.lego.com/sustainable-packaging)

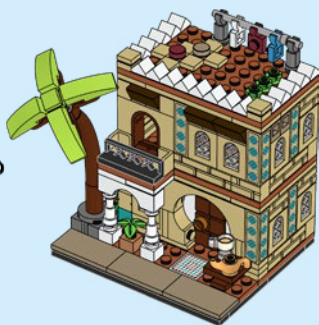
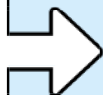
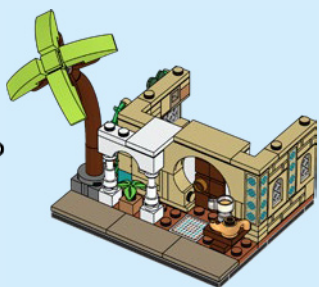
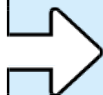



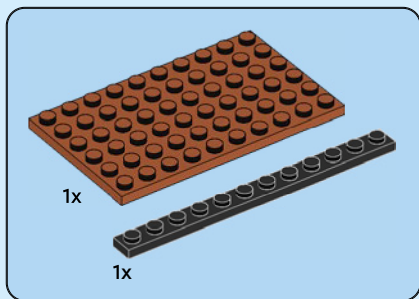

1

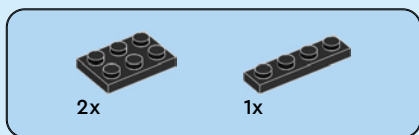
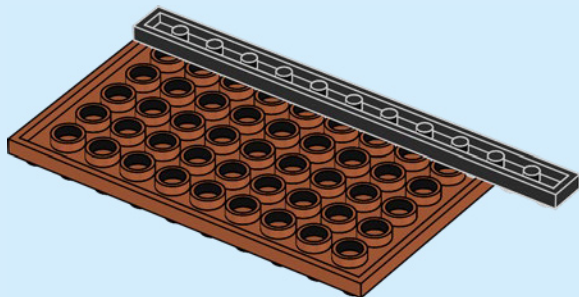

2

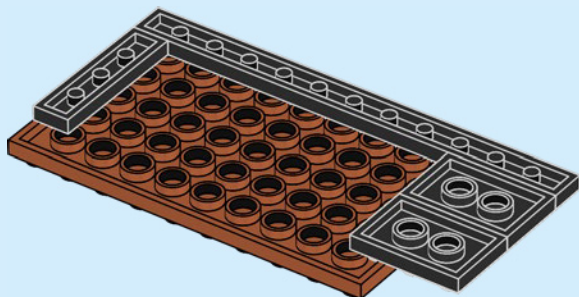

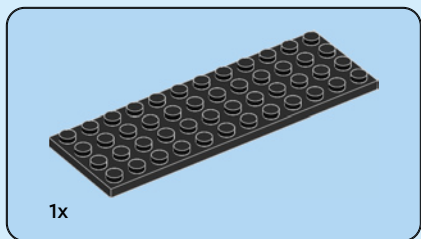

3

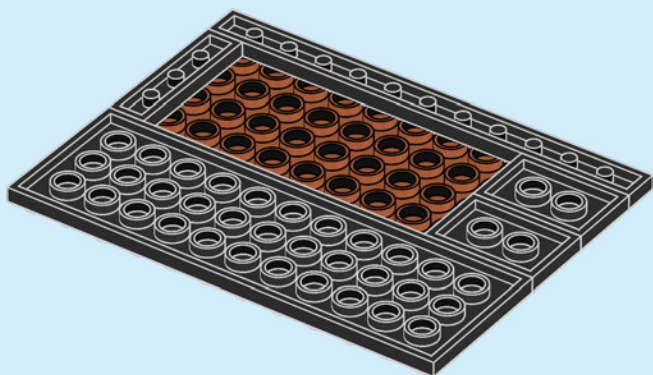

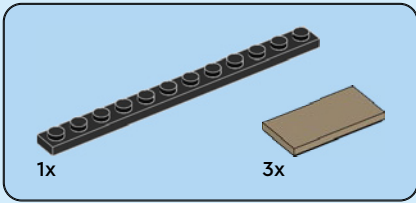

4

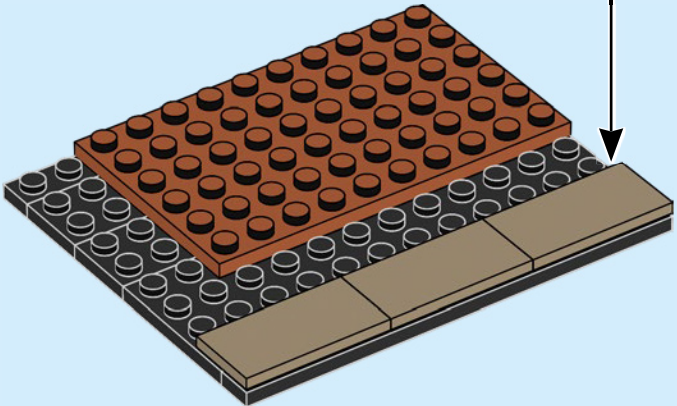
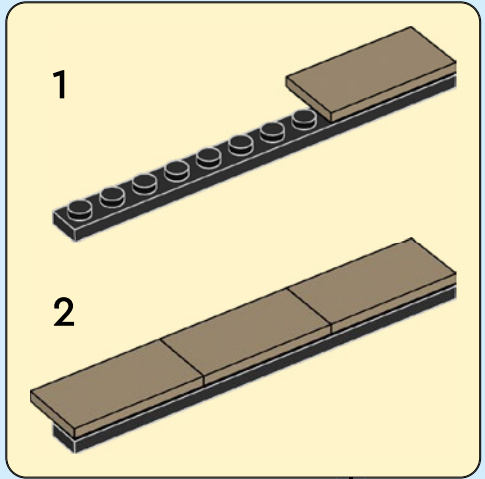



4x

5

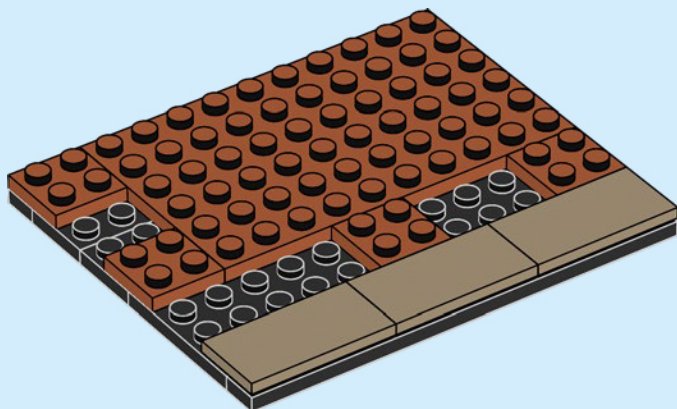

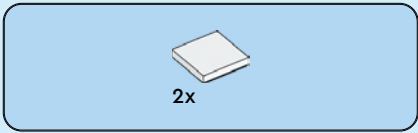

6

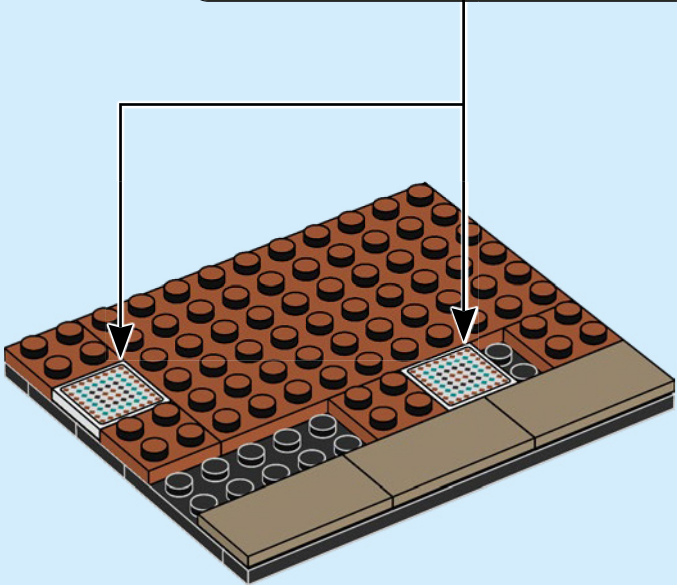
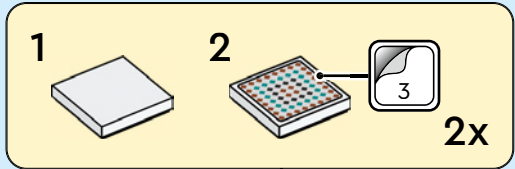



3x



1x

7

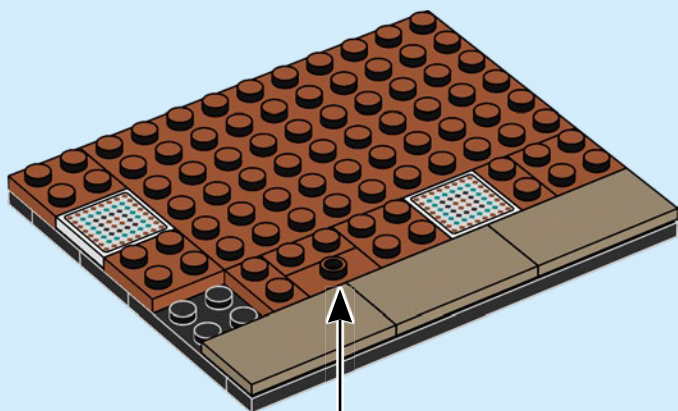

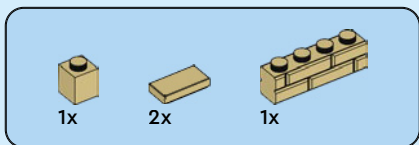

8

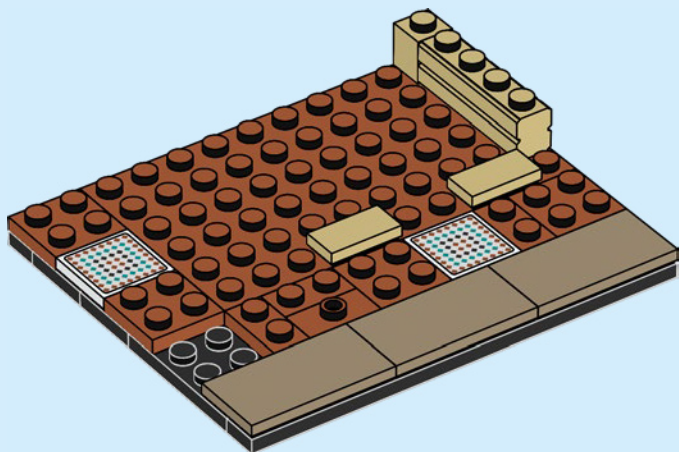

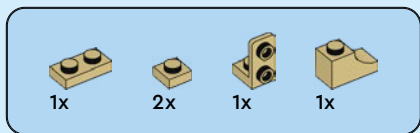

9

1

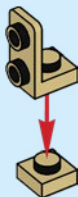

2

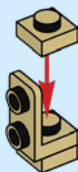

3

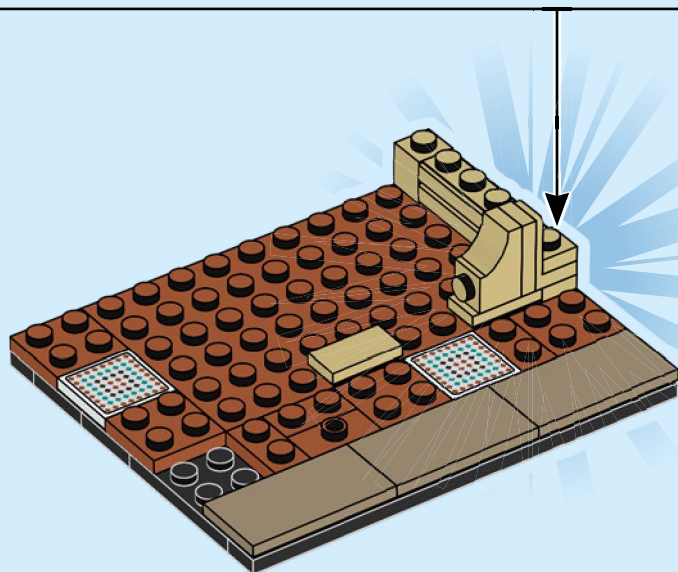
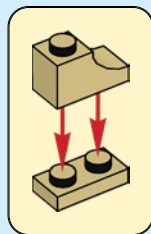
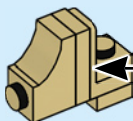

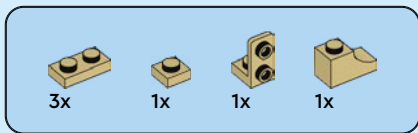

10

1

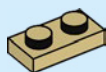

2

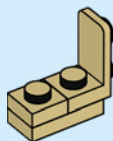

3

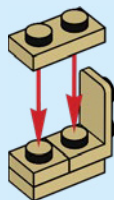

4

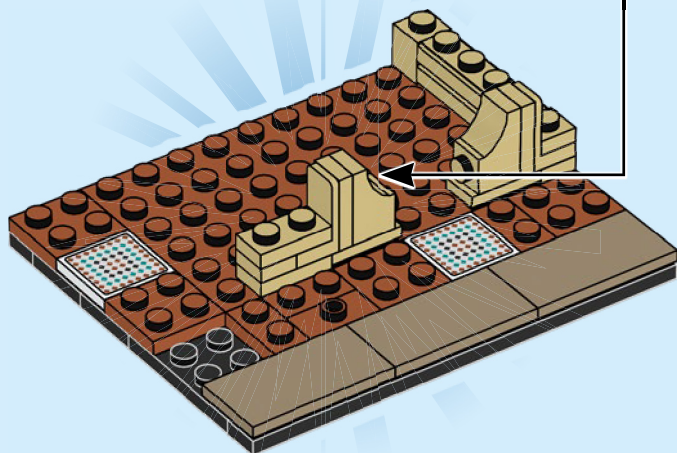
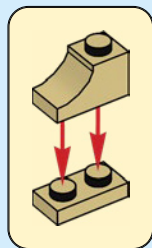
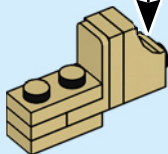

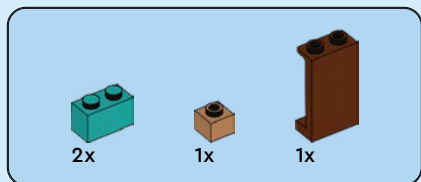

11

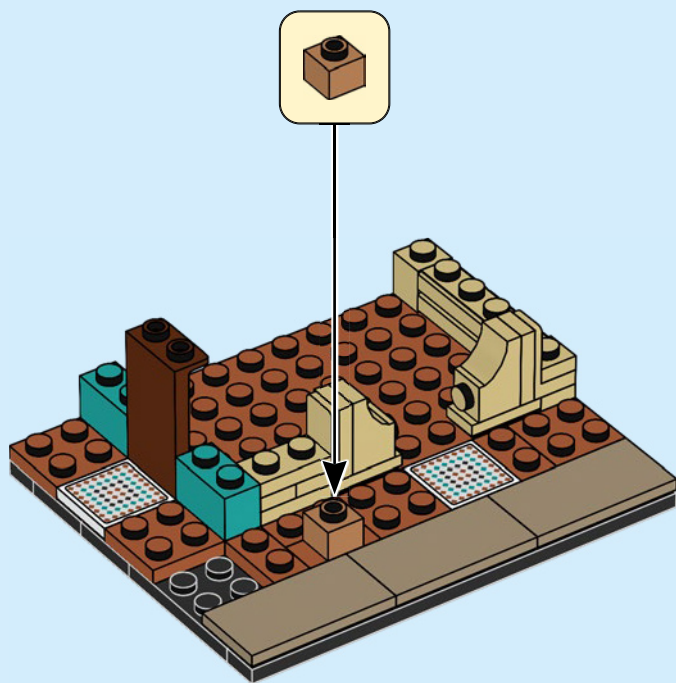

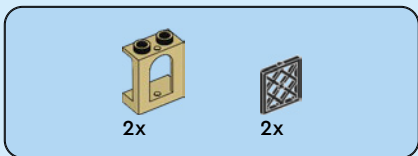

12

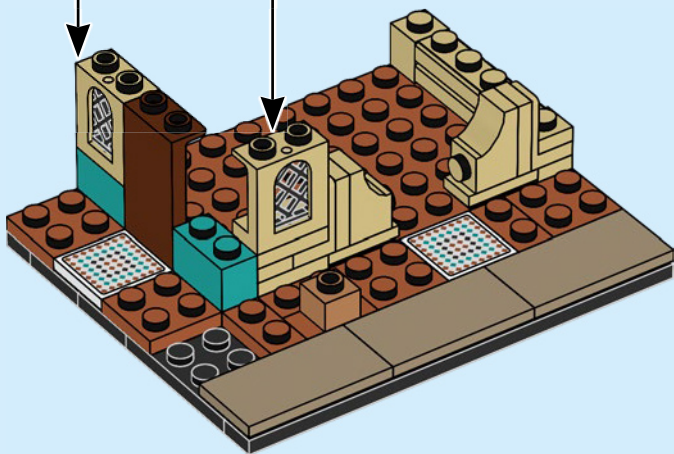
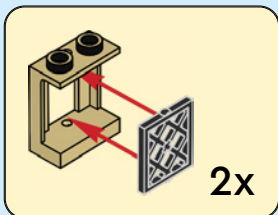



1x



1x



1x

13

1

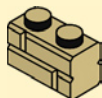

2

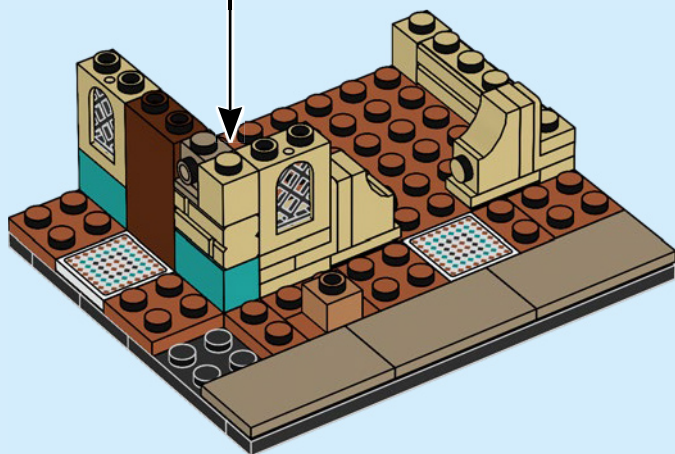
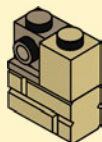



1x



1x



1x



1x

14

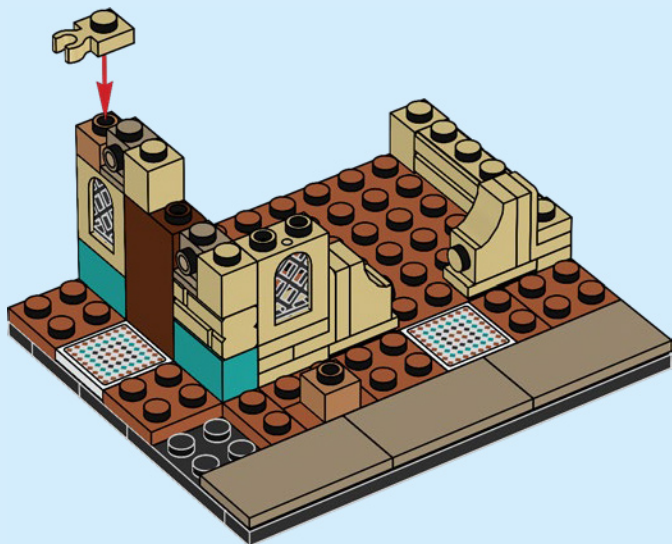

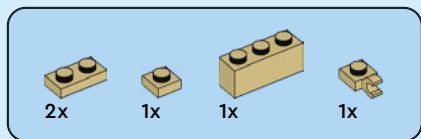

15

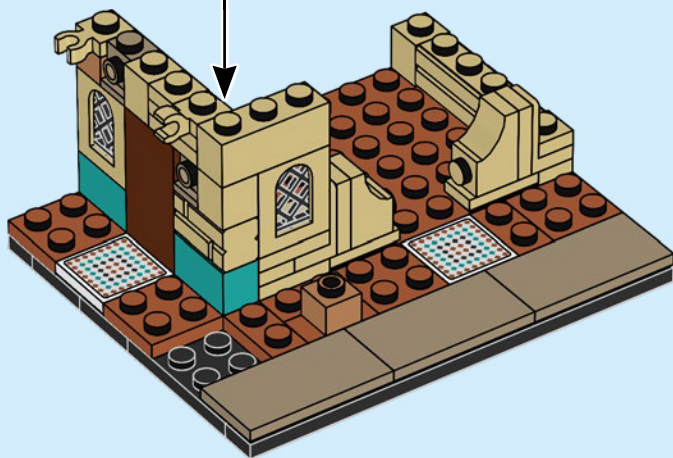
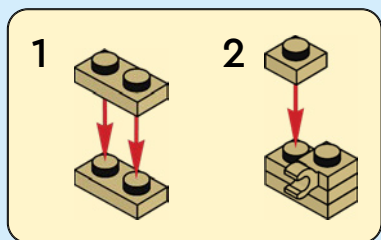

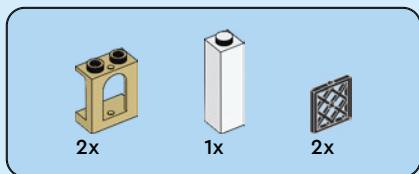

16

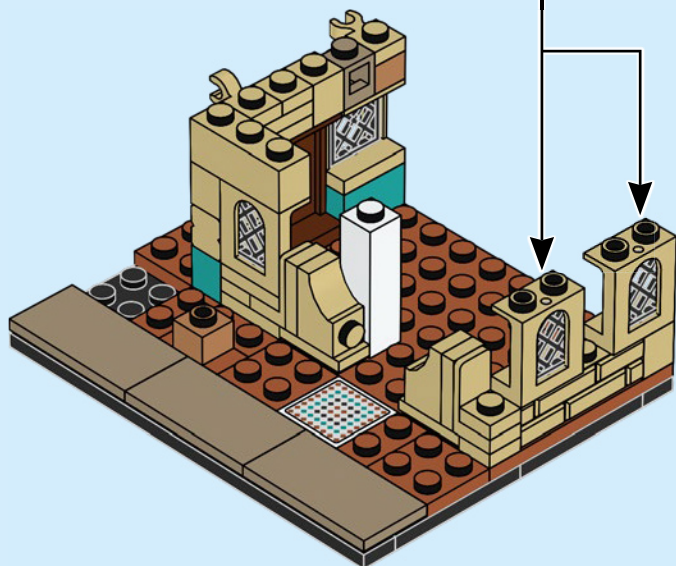
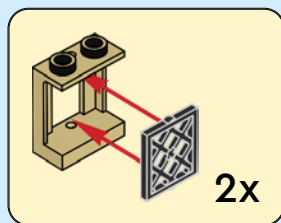

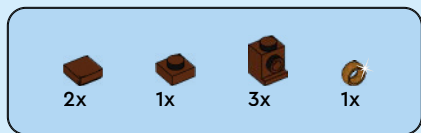

17

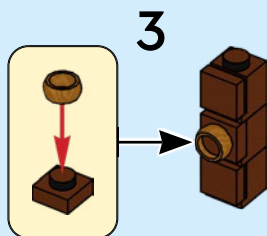
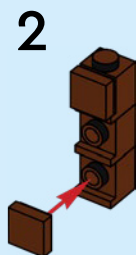
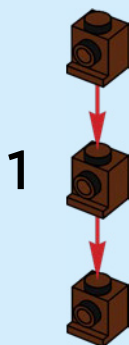

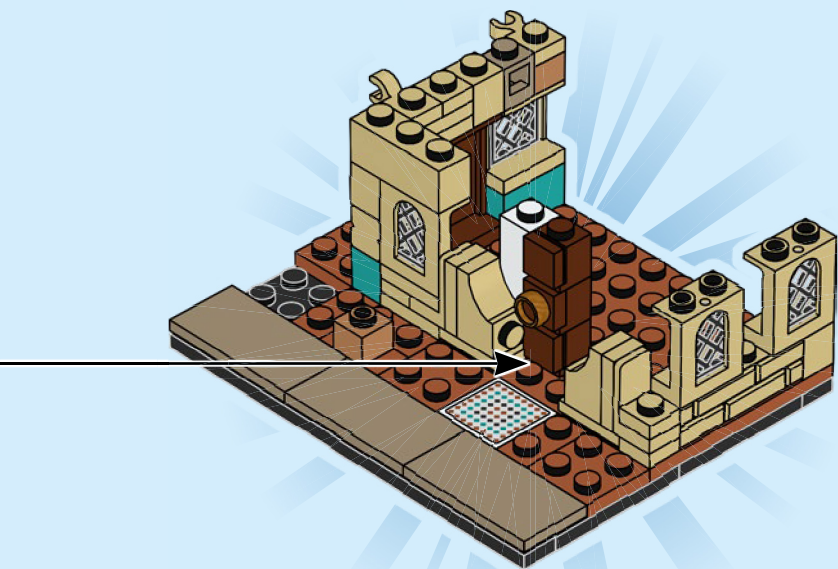



18

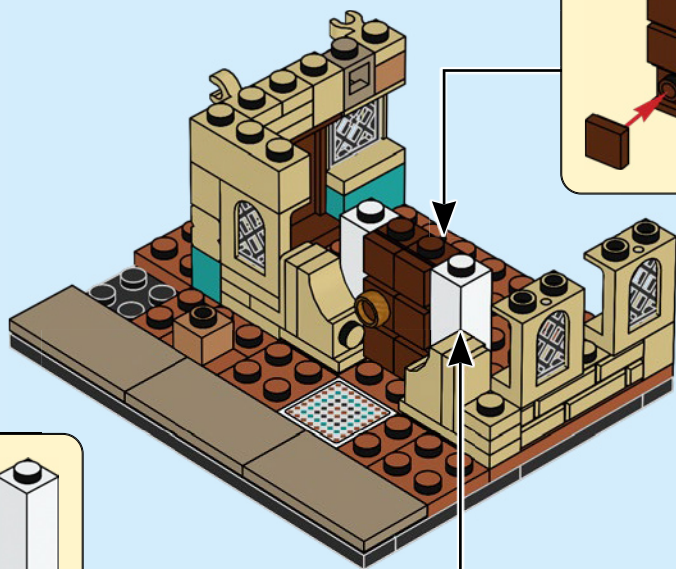
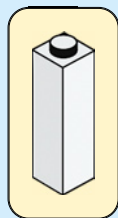
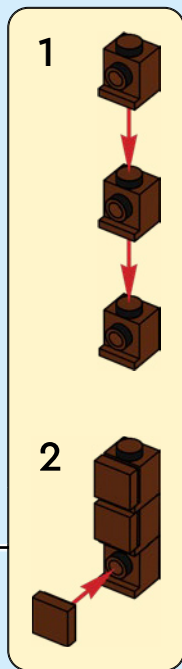



1x

19

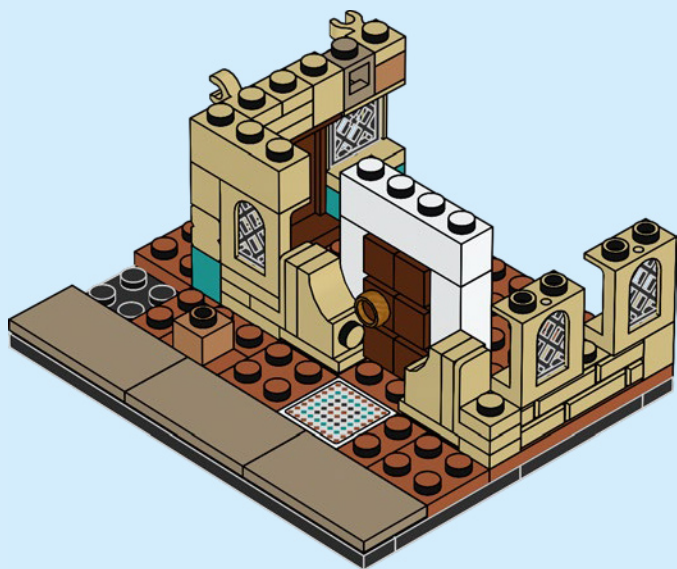

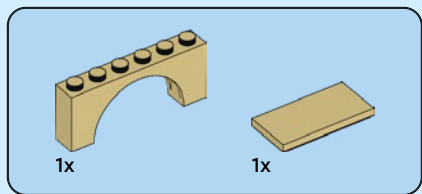

20

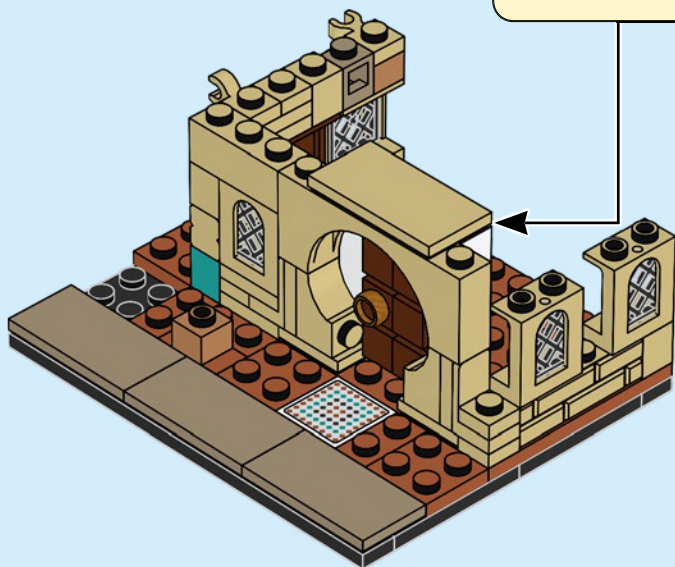
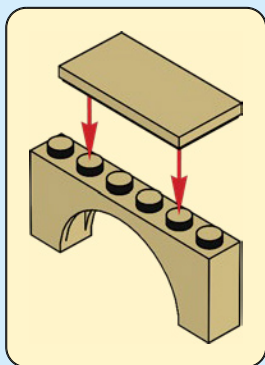

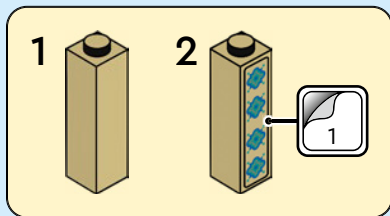
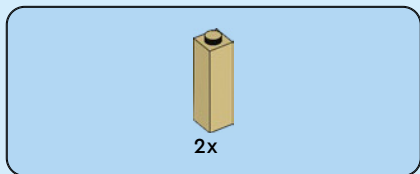

21

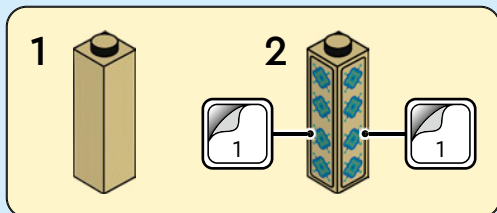
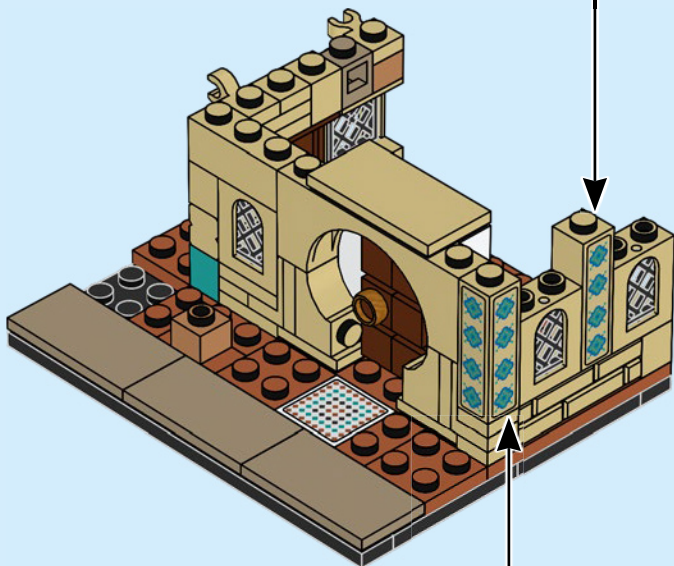



2x

22

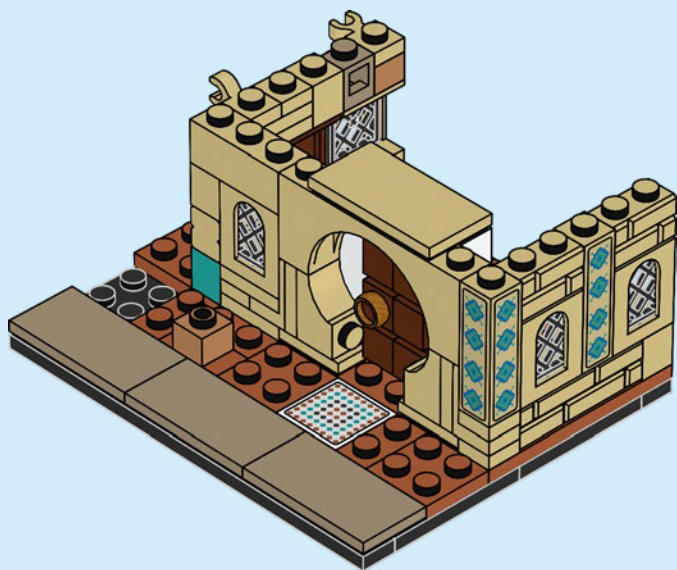



2x



2x

23

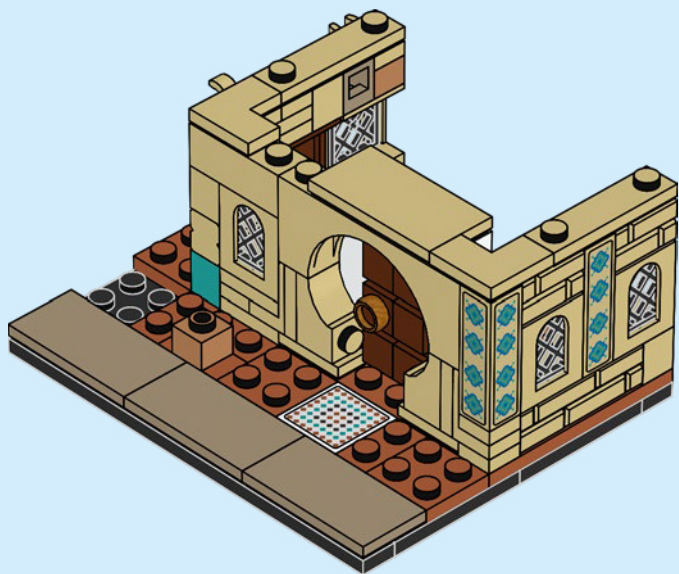

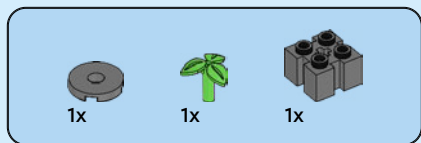

24

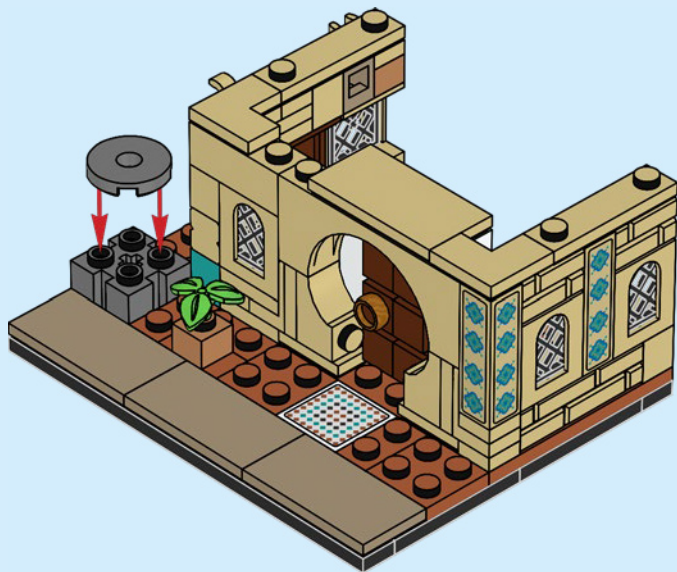



1x



1x

25





1x



1x



1x

26

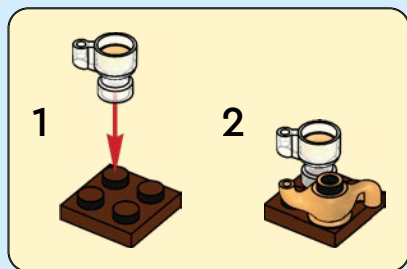



2x



4x



2x

27

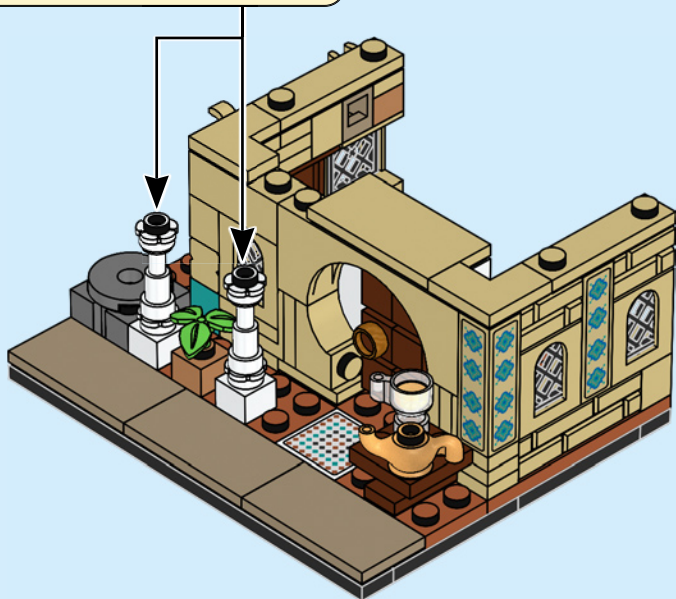
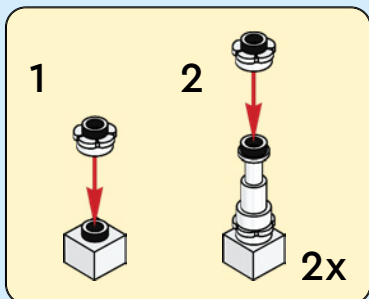

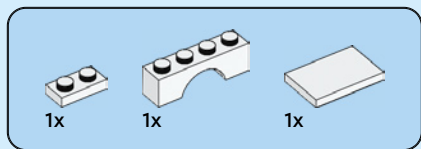

28

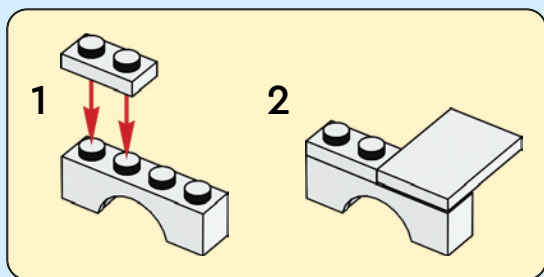



29

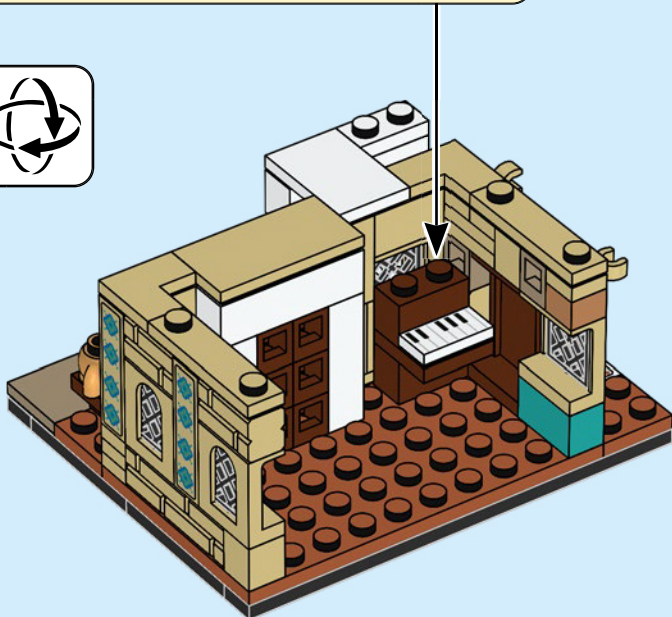
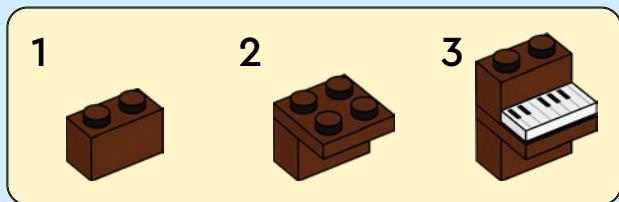

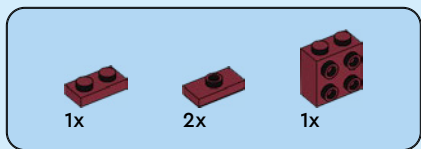

30

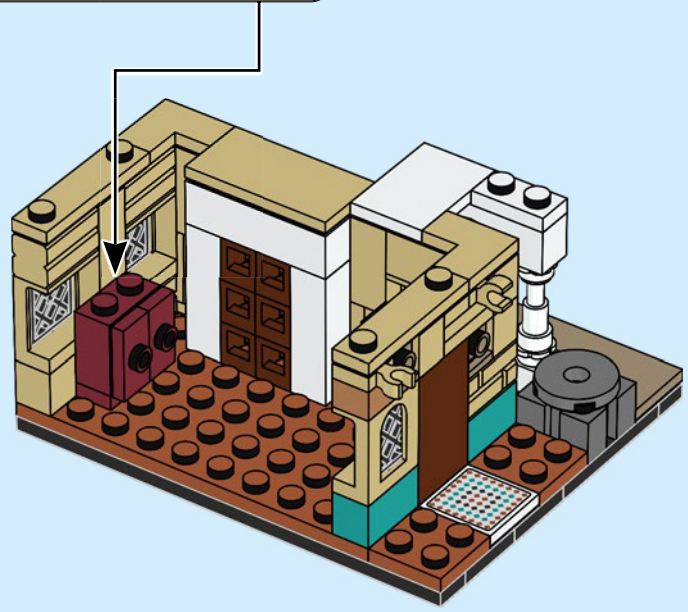
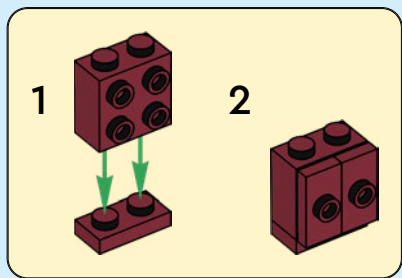



2x



2x



1x

31

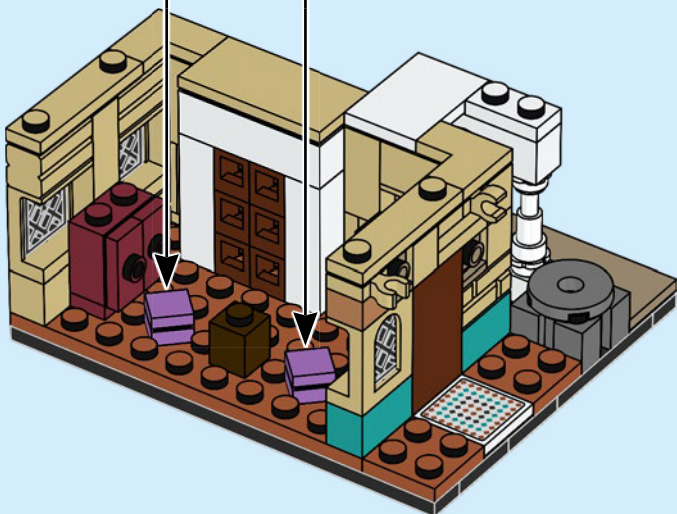
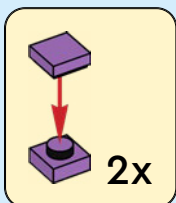



1x

32

1



2

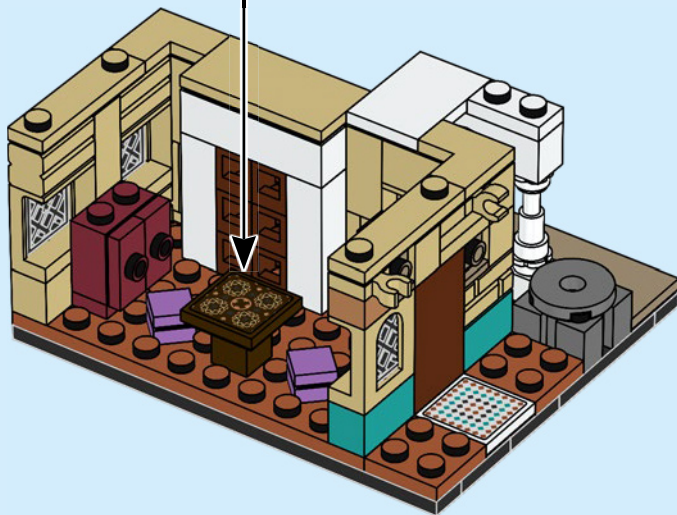
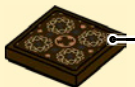



2x

33

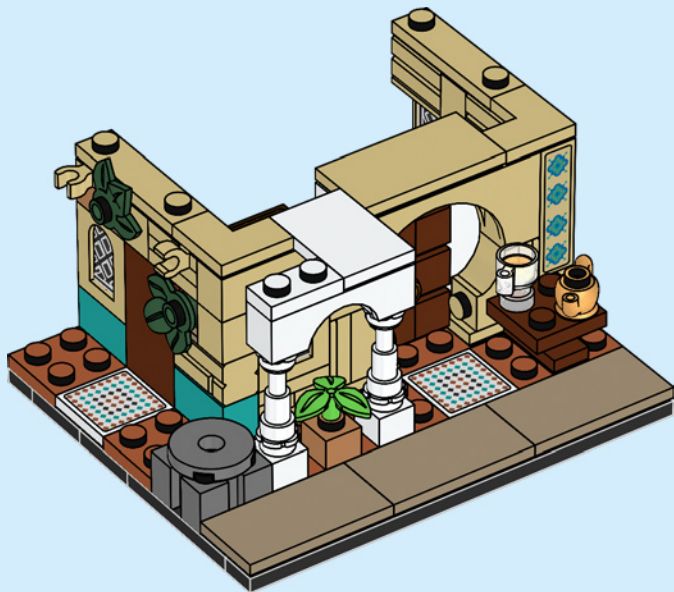



2x

34



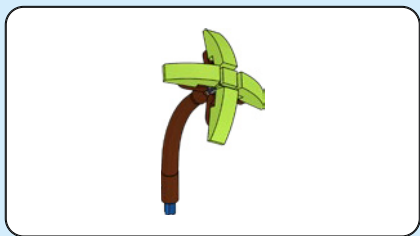

35





1x

36

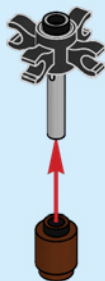

1x



1x

37





4x



4x

38

1



2



4x



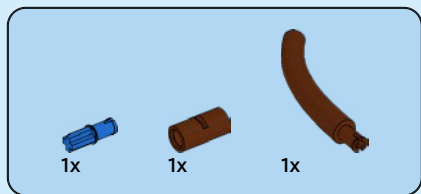

39

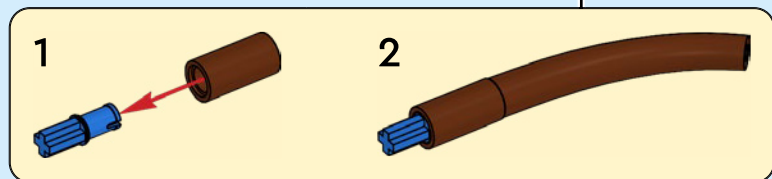
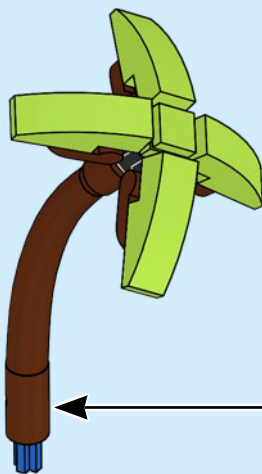

40

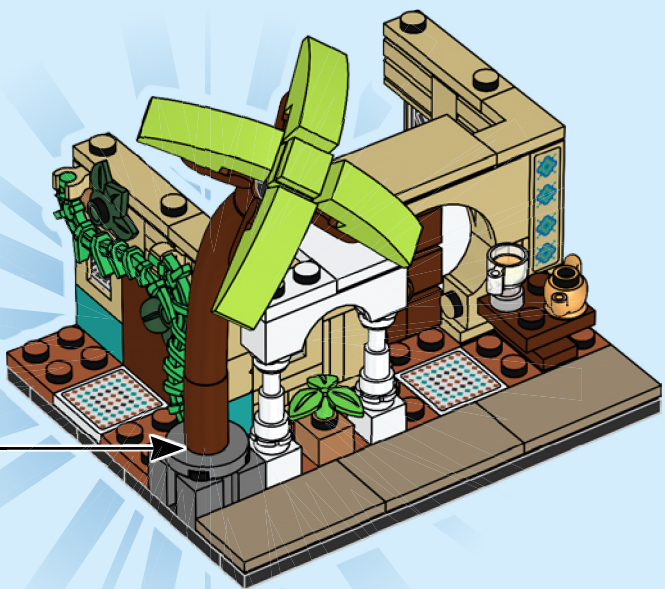



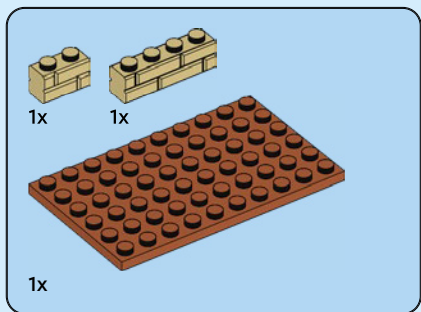
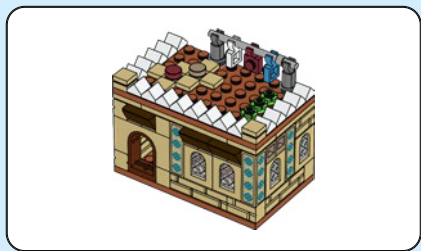

41

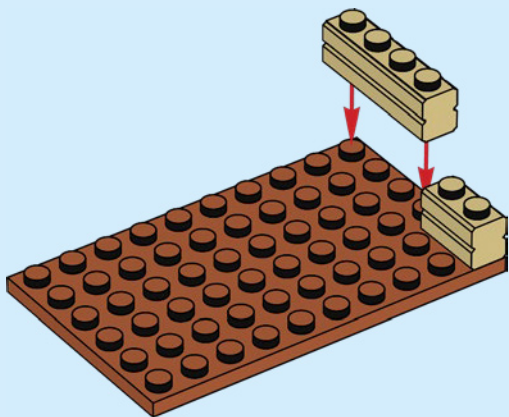

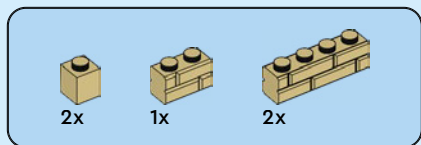

42

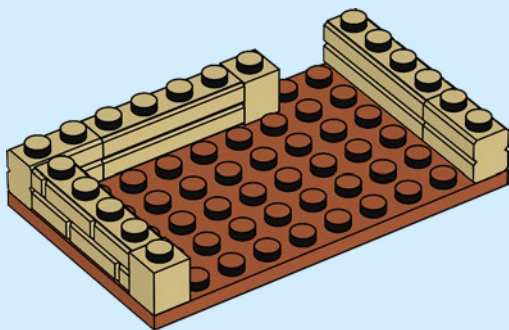



1x



2x



3x

43

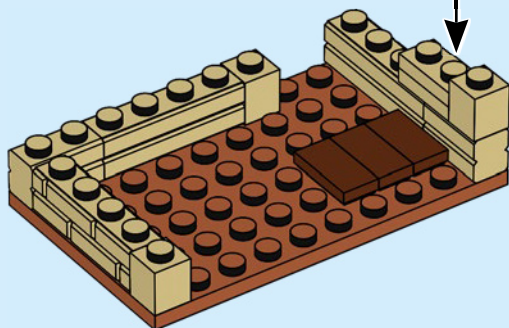
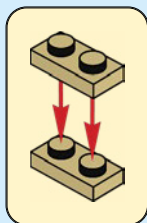



2x

44

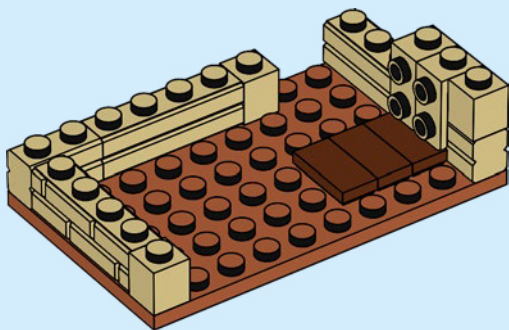



1x



1x



1x

45

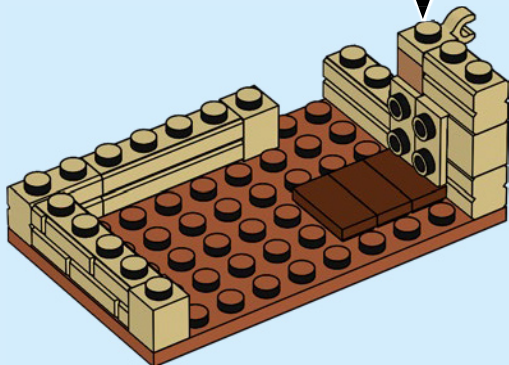
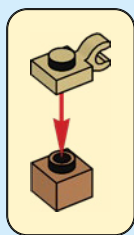



5x



5x

46

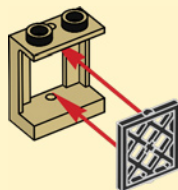

5x

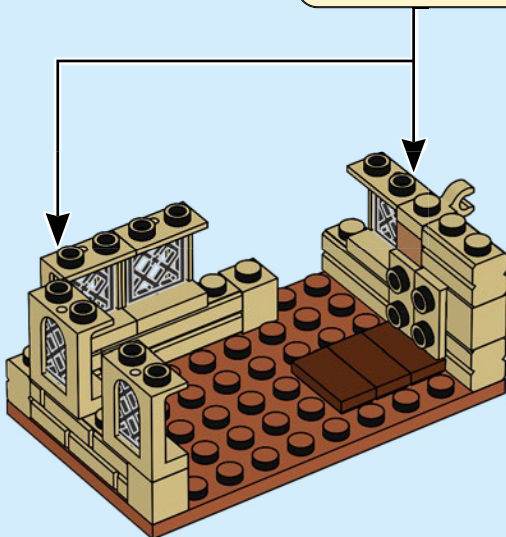

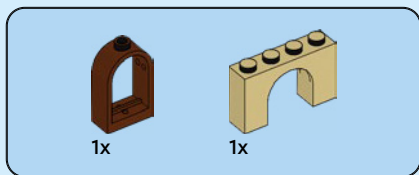

47

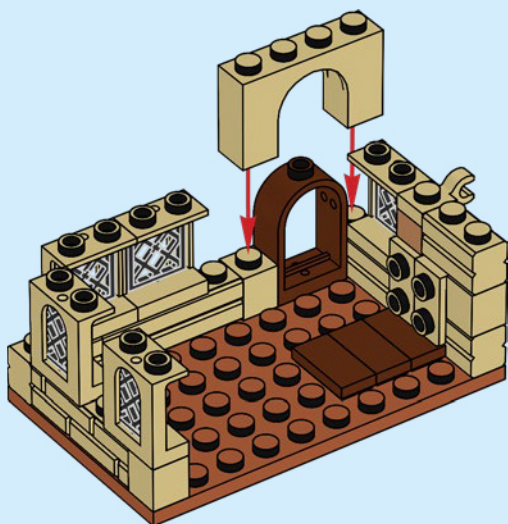

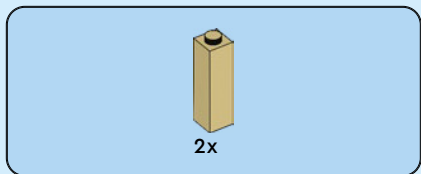

48

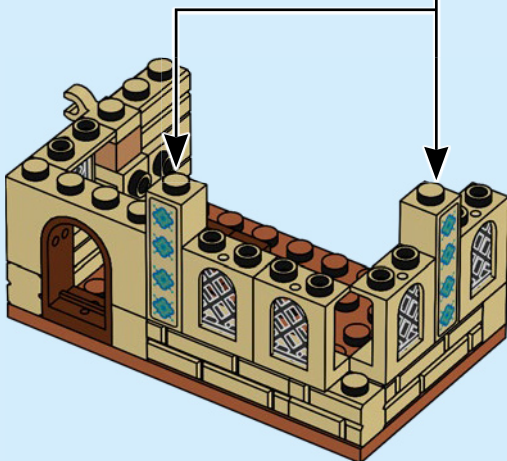
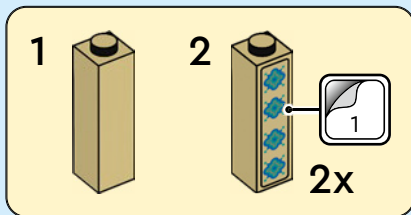

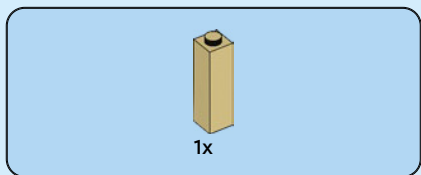

49

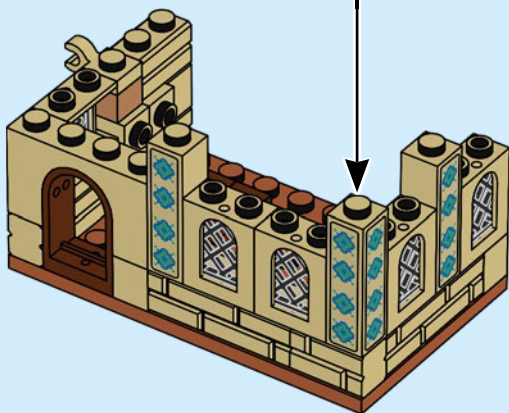
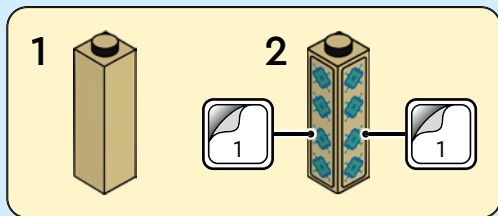

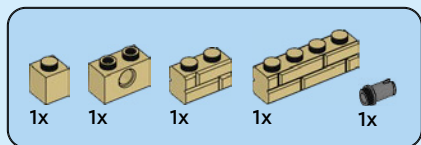

50

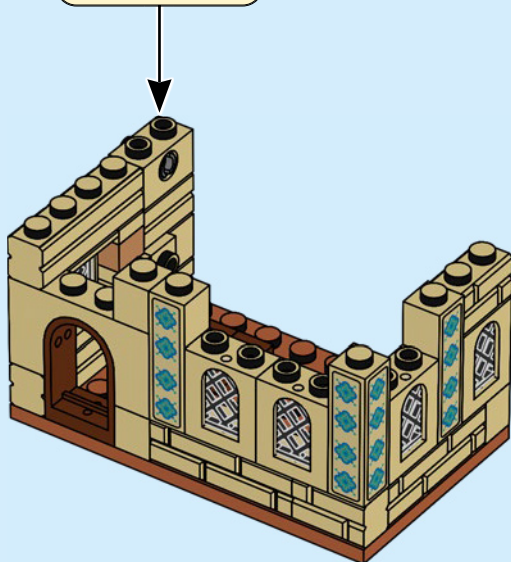
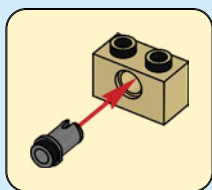



3x



6x

51

1

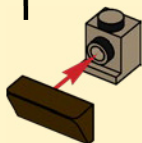

2



3x

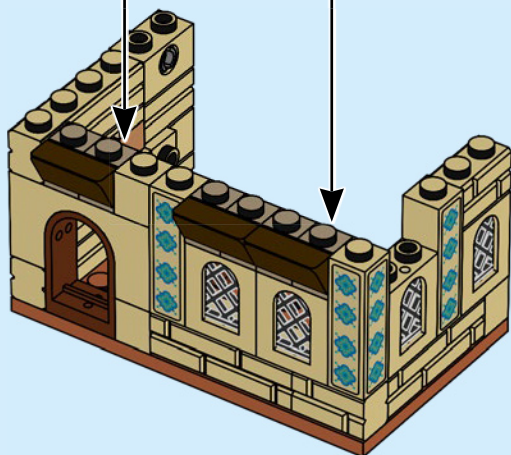



1x



2x

52

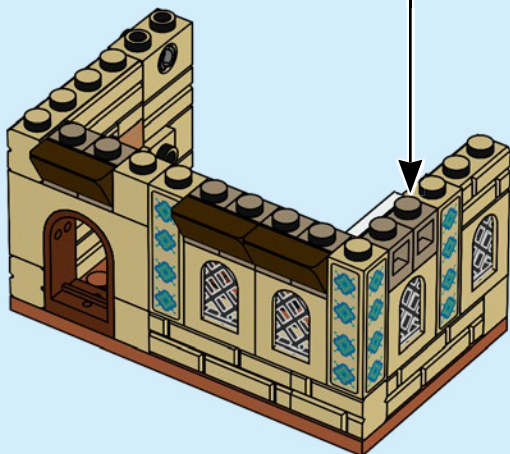
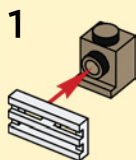

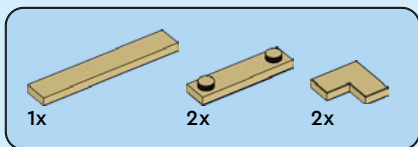

53

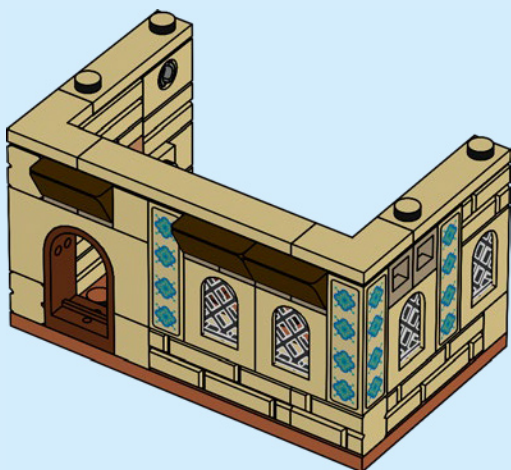

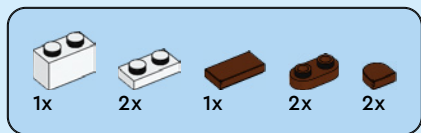

54

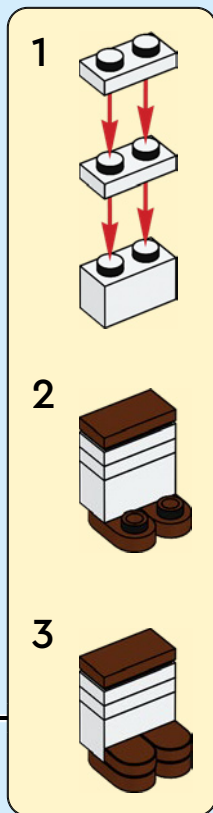
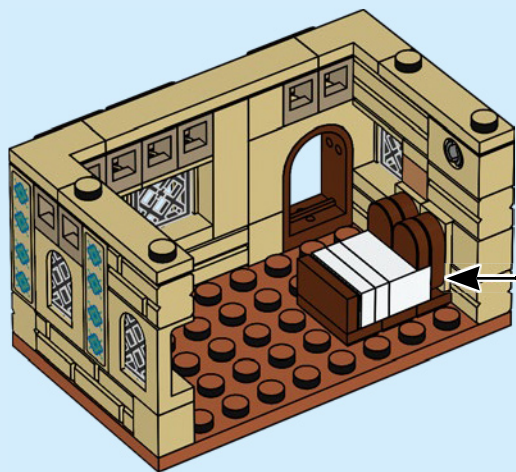
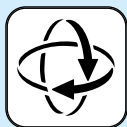



1x



1x



1x

55

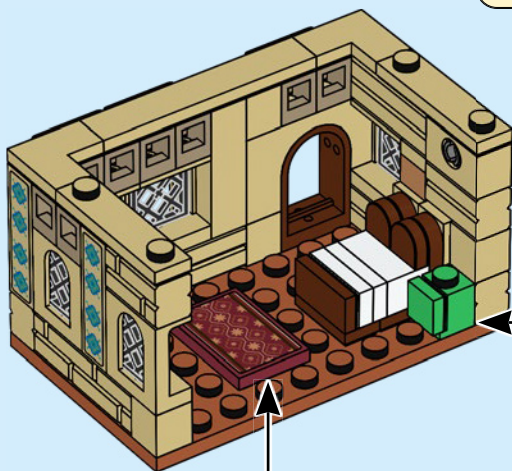
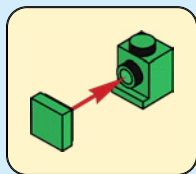

1



2



2



1x



1x

56

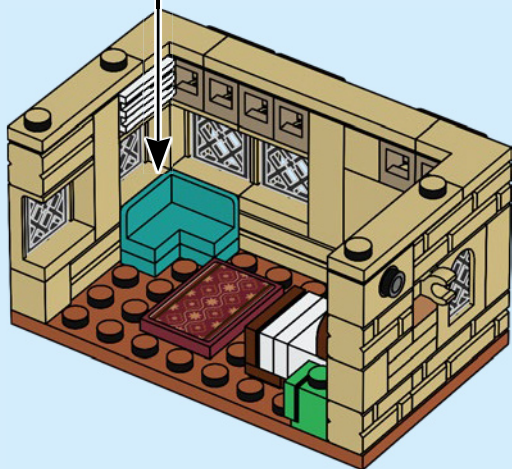
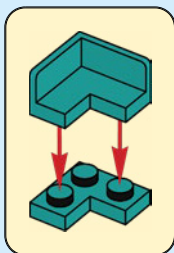



3x



1x

57

1



2

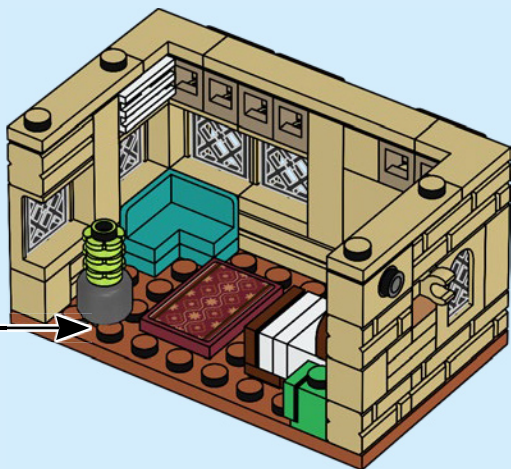

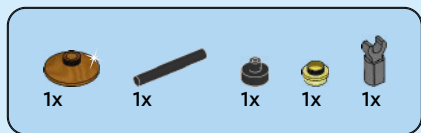

58

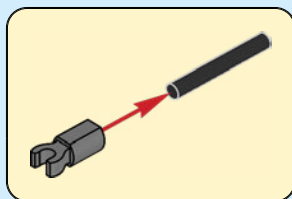
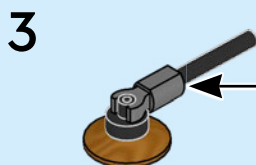
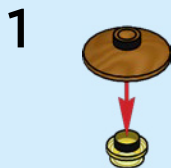

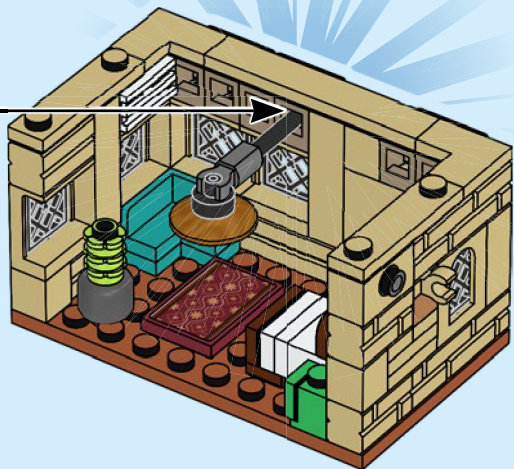

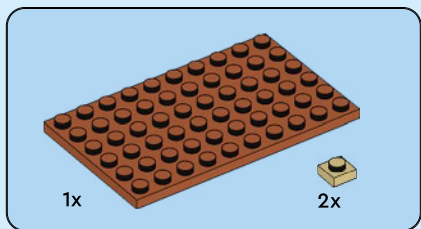

59

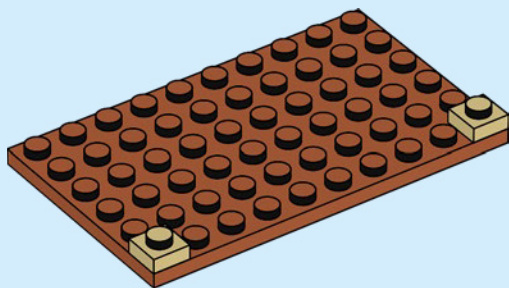



2x

60

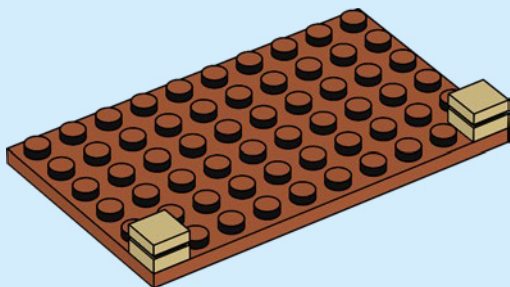

18x

61

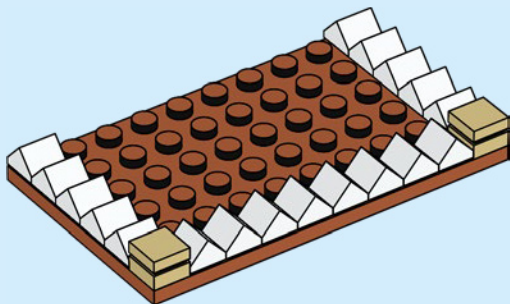



1x



2x

62

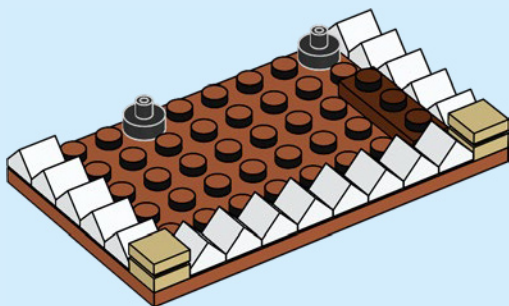



3x



2x

63

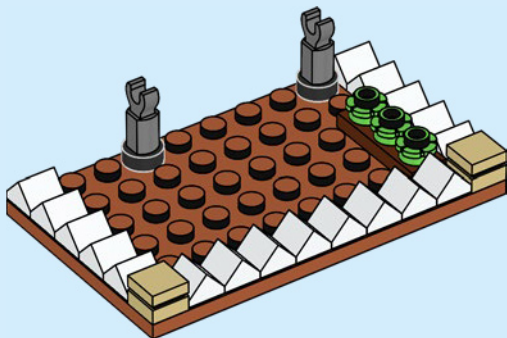

6x



2x

64

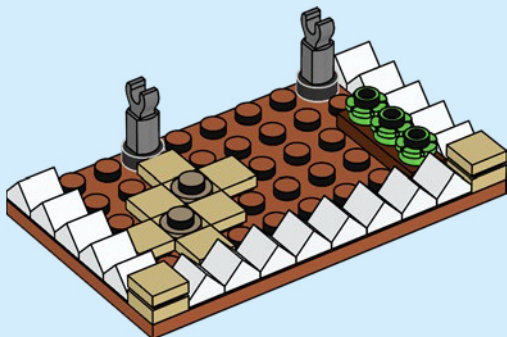



1x



1x

65

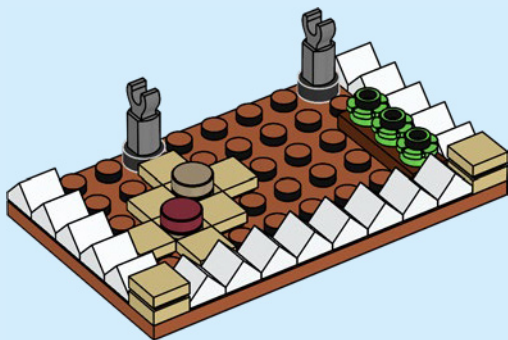

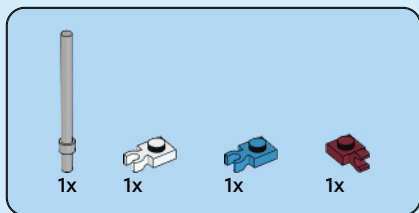

66

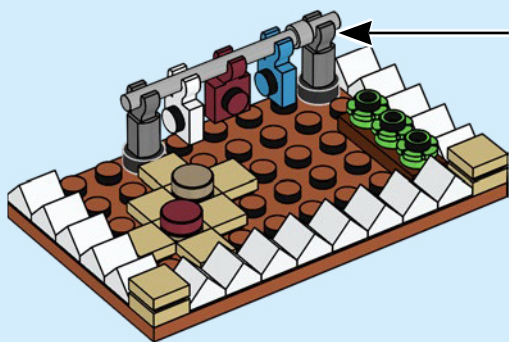
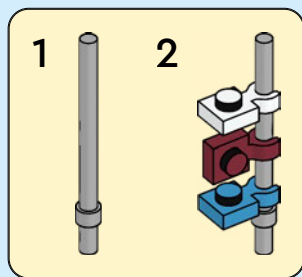

67

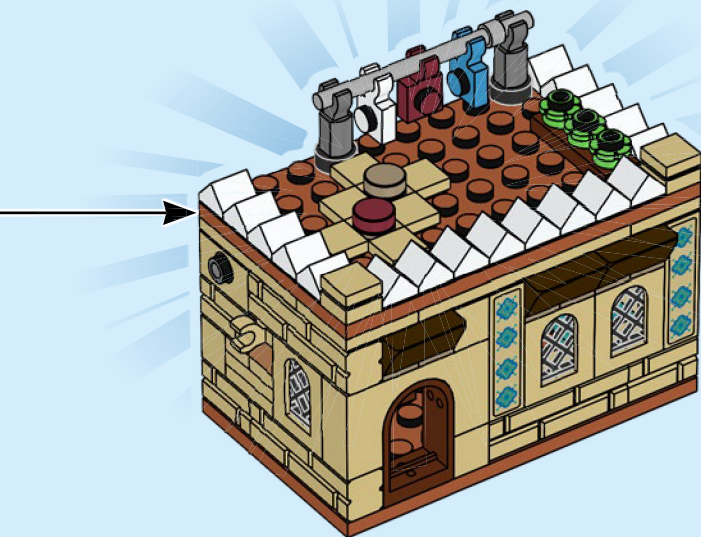

68

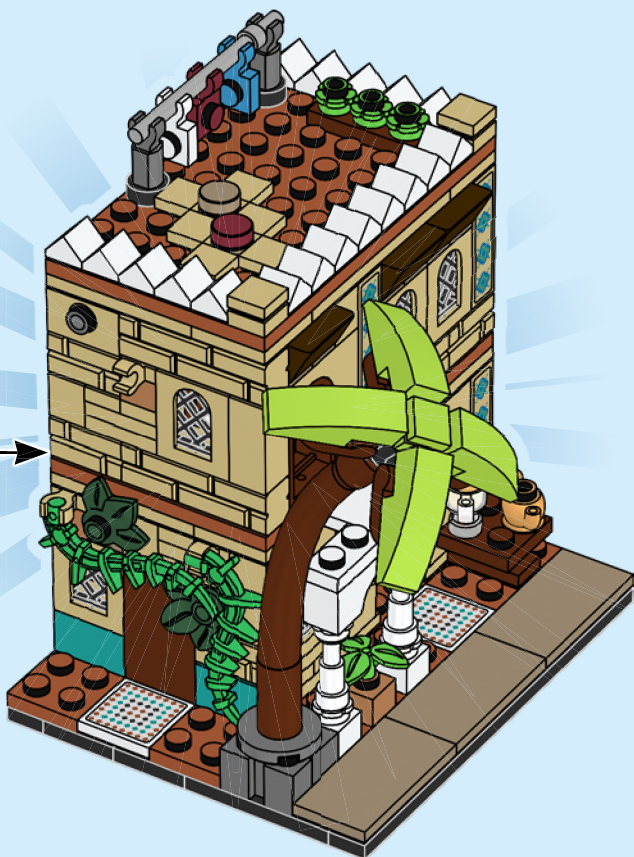

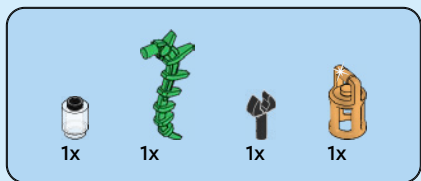

69

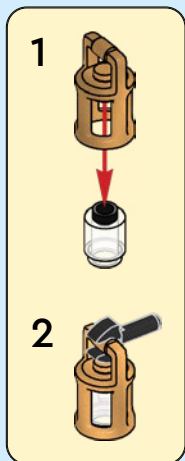

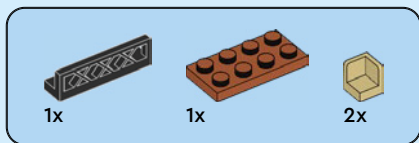

70

1

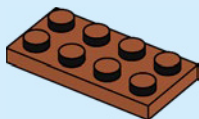

2

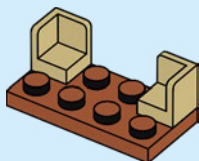

3

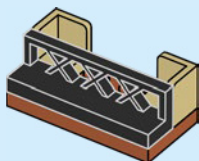











4x
6206149

18x
6286834

2x
6055541

2x
6383985

1x
6330191

3x
302301

1x
300401



1x
241201

1x
6293665

2x
6070327

2x
306801

1x
6156667

1x
301001

1x
365901

78

7x
4113915

8x
4125253

6x
4159553

5x
6057517

2x
4612603

2x
6374151

2x
6357613

2x
6347292

1x
6352222

9x
4642933

7x
6148262

1x
4205107

8x
4113917

1x
6275509

2x
4114026

2x
6383295

4x
6173057

1x
4162465



4x
6257600

5x
6232136

1x
6031057

1x
6122047

1x
6106187

1x
4157277

3x
6383946

1x
4206482

1x
6009771

1x
6078236

1x
4187334

1x
4558593

3x
6270055

3x
6206150

1x
6235080

1x
6223655

1x
6306748

1x
6240216

2x
6217659

1x
6385084

1x
6378330

3x
6209692

1x
4537251

1x
4621557

4x
4537928

1x
6284585

1x
6360110

1x
4539097

1x
6359684

2x
6092597

1x
6359681

1x
6170418

1x
6347715

2x
6400754

1x
6352226

2x
4619521

2x
6097301

1x
6283475

1x
6081658

2x
6315781

1x
6322841

10x
6273590

3x
6164288

1x
6226437

3x
6127366

1x
6179803

3x
6336970

1x
6395635

1x
6055313

1x
6236949

1x
4216581

1x
4211183

2x
6328180

6x
4225469

5x
4211288

1x
4221744

2x
6248944

4x
6153863

4x
4211151

1x
6092590

1x
4542131

1x
6398342

2x
4211149

1x
6173132

2x
4216695

1x
4211152

1x
6326087

3x
6186675

1x
6278152

9x
6234994

1x
6320293

1x
6093525

2x
302126

1x
371026

1x
4187209

2x
4514845

1x
302926

3x
4570877

1x
6092602

4x
4615606

1x
4535928

3x
6263971

 [LEGO.com/service](https://www.LEGO.com/service)



YOU COULD

WIN



Scan this QR code or go to
LEGO.COM/PRODUCTFEEDBACK
and give us your short feedback
about this LEGO® set for a chance
to win a cool LEGO prize.

Terms and Conditions apply*

DE: Du könntest GEWINNEN. Es gelten die Teilnahmebedingungen* **FR: Tu pourrais GAGNER.** Des conditions s'appliquent* **IT: Potresti VINCERE tu.** Termini e condizioni sono applicabili* **ES: Puedes GANAR.** Aplican términos y condiciones* **PT: Poderá GANHAR.** Aplicam-se termos e condições* **JA: プレゼント付き! 利用規約が適用されます*** **ZH: 轻松获奖. 条款和条件适用*** **KO: 상품의 주인이 되어보세요. 소정의 약관이 적용됩니다*** **RU: Вы можете ВЫИГРАТЬ.** Действуют положения и условия* **PL: Szansa na WYGRANĄ.** Obowiązują warunki korzystania* **CS: Máte šanci VYHRÁT.** Platí všeobecné smluvní podmínky* **SK: Máte šancu VYHRÁŤ.** Platia všeobecné zmluvné podmienky* **HU: TE IS NYERHETSZ.** Felhasználási feltételek érvényesek* **RO: Ai putea CÂȘTIGA.** Se aplică termeni și condiții* **BG: Можете да СПЕЧЕЛИТЕ.** Има определени правила и условия* **LV: Tu vari LAIMĒT.** Ir spēkā noteikumi un nosacījumi.* **ET: Sul on võimalus VÕITA.** Kehtivad tingimused* **LT: Jūs galite LAIMĖTI.** Taikomos sąlygos*

*[LEGO.com/productfeedback-terms](https://www.lego.com/productfeedback-terms)