

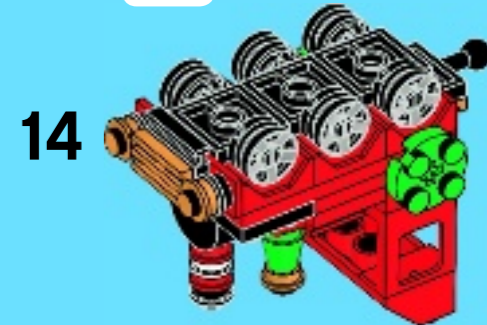

40034

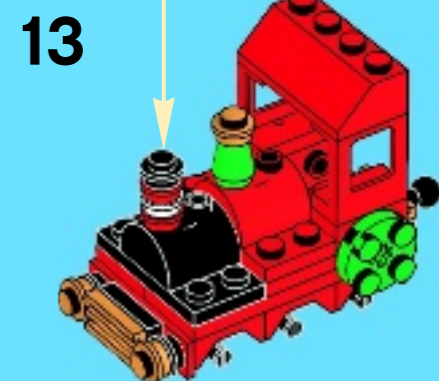

601009

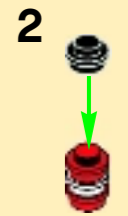
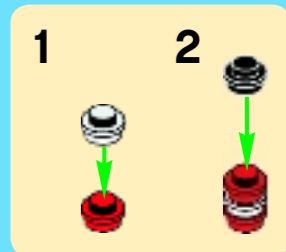
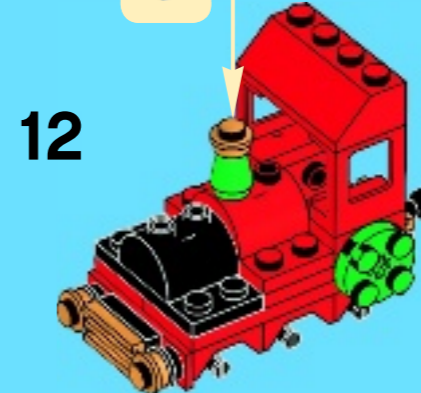
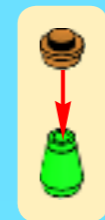
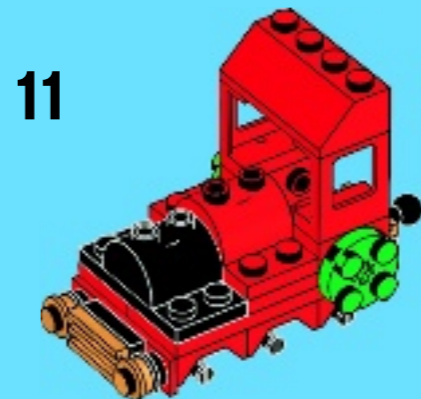
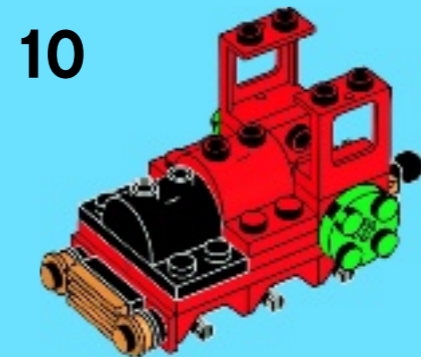
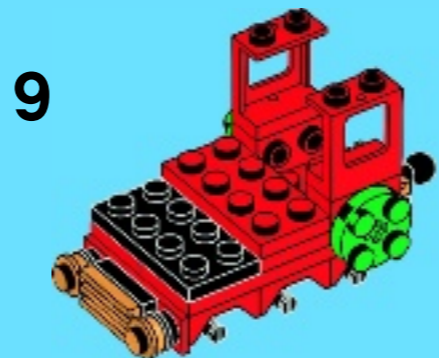
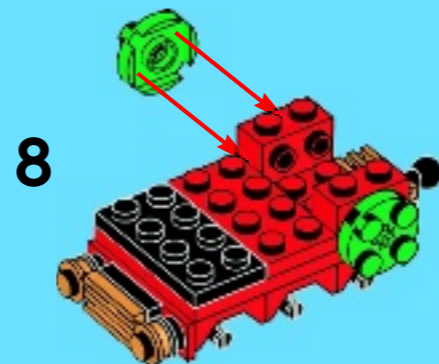
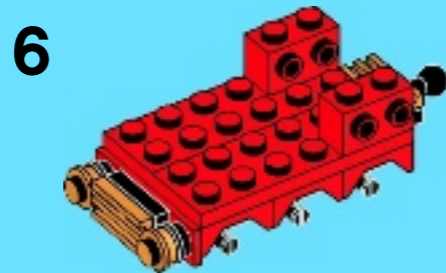
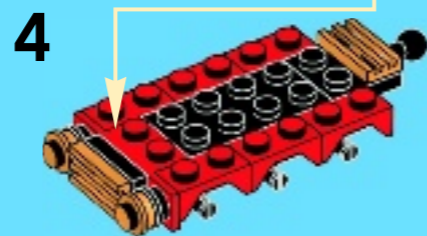
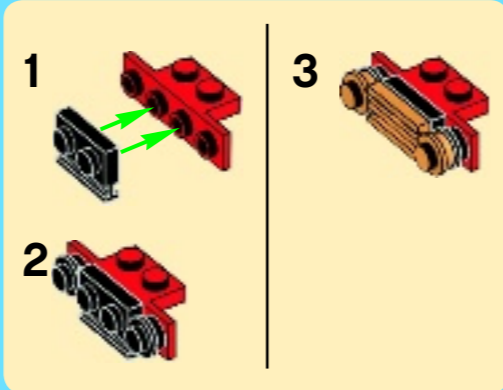
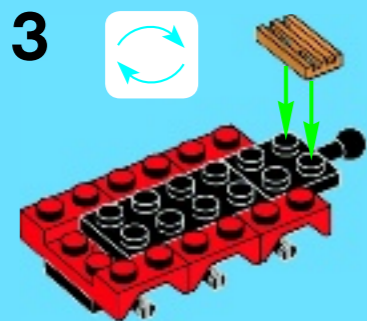
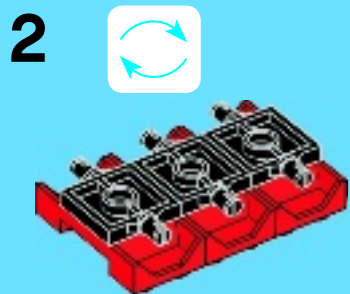
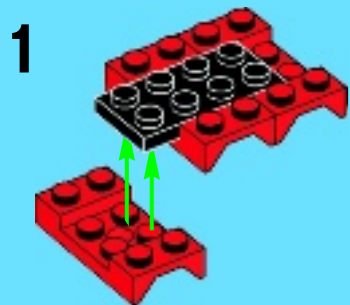

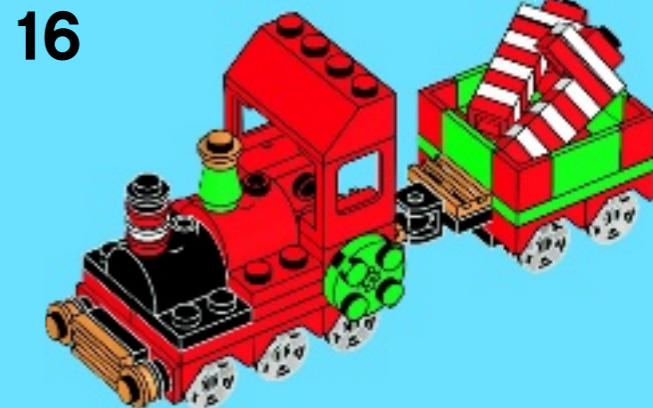
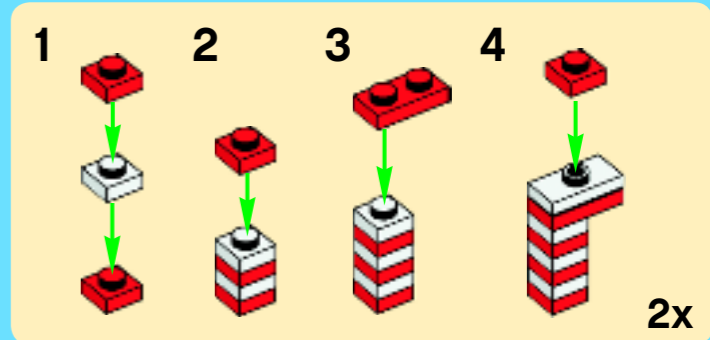
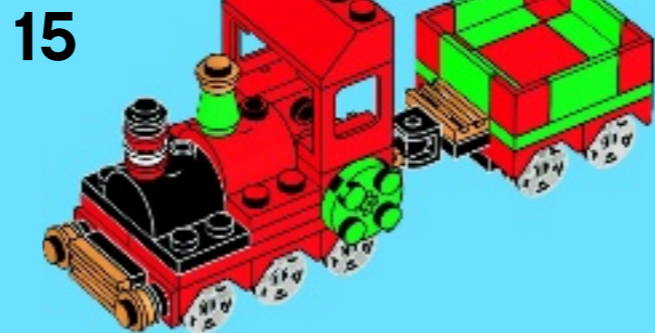
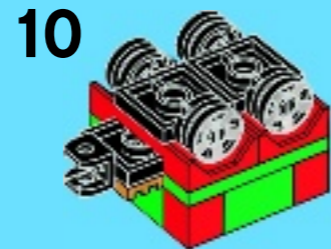
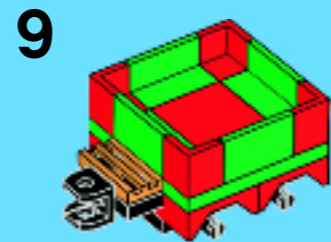
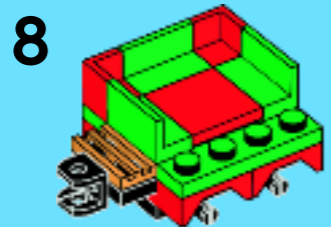
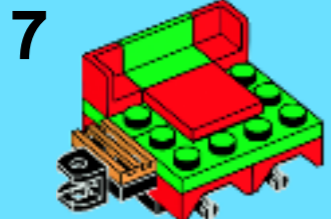
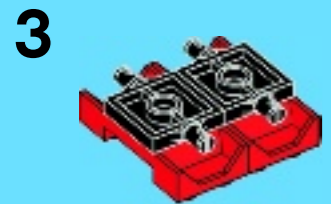

- | | | | | | | |
|------------|-----------|------------|------------|-------------|------------|------------|
| 1x 4282742 | 1x 302121 | 2x 614121 | 1x 303721 | 1x 412411 | 2x 302026 | 1x 4200023 |
| 5x 4600176 | 2x 302021 | 2x 4569056 | 1x 4529239 | 3x 614126 | 1x 4107761 | 6x 302401 |
| 4x 4190219 | 2x 379521 | 1x 4521852 | 3x 4490599 | 10x 6022424 | 1x 4529064 | 2x 379401 |
| 2x 4507686 | 1x 306821 | 2x 302421 | 3x 4523159 | 5x 460026 | | 1x 614101 |
| | | 2x 302321 | | | | |