

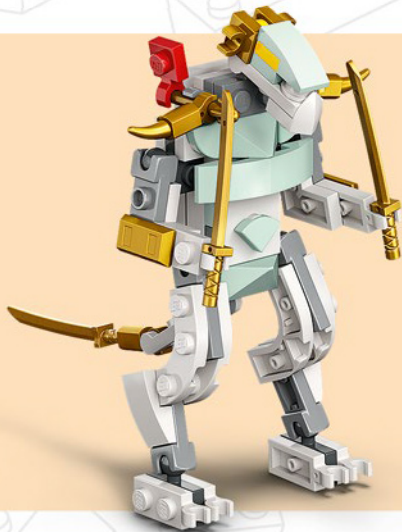

# NINJAGO

30649





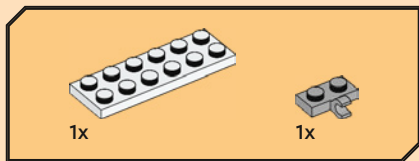

1

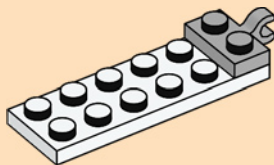

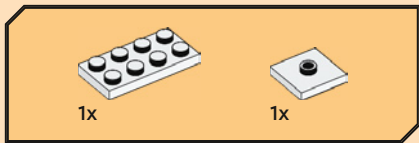

2

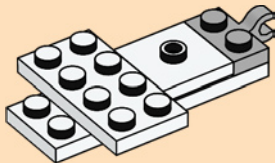

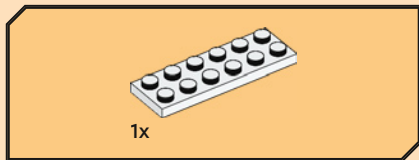

3

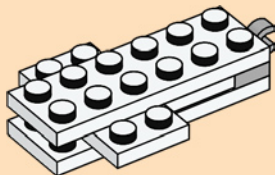



4

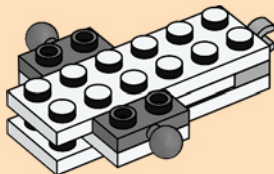

6

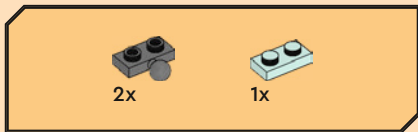

5

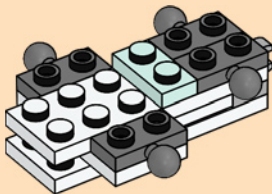



2x



2x

6

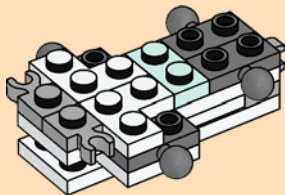

8



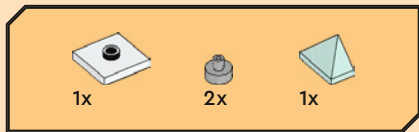

7

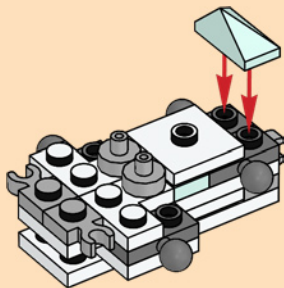



1x



1x

8

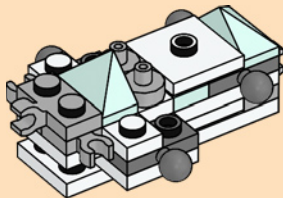

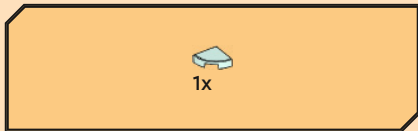

9

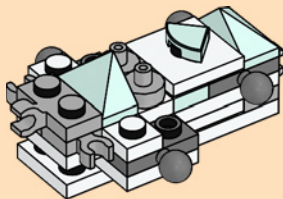



2x

10

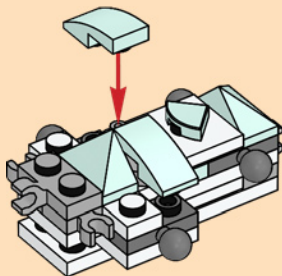

12

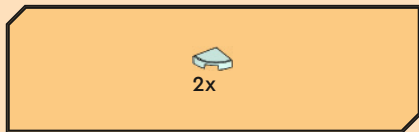

11

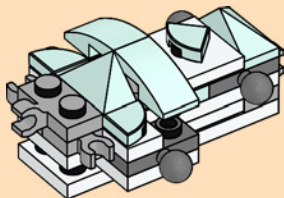

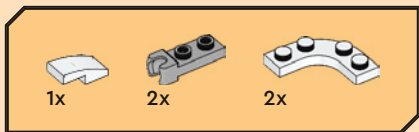

# 12

1

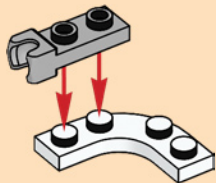

2

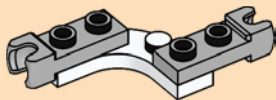

3



4

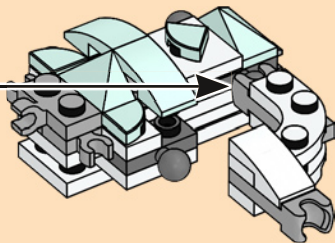



1x



2x

# 13

1

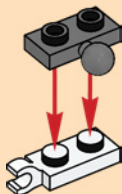

2

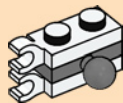



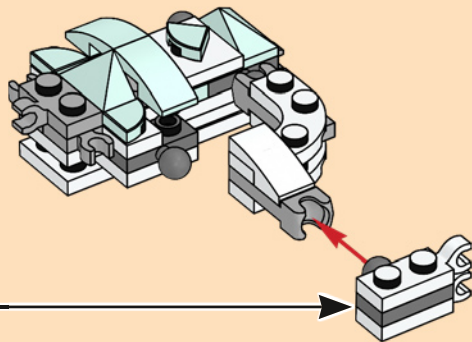

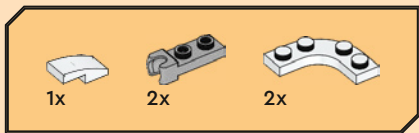

14

1

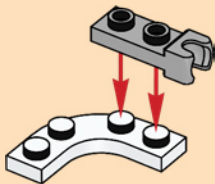

2



3



4

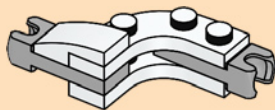

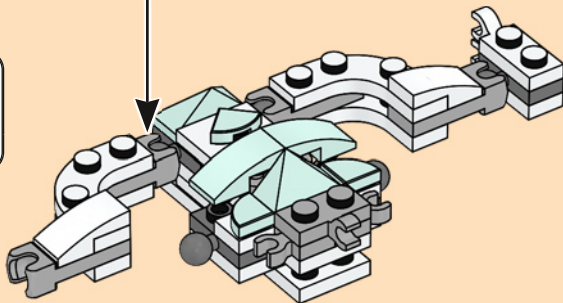

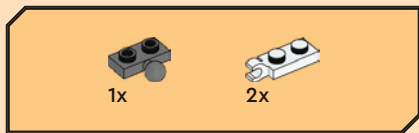

15

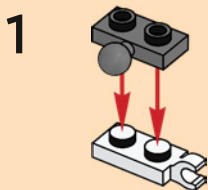

2

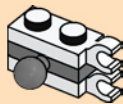

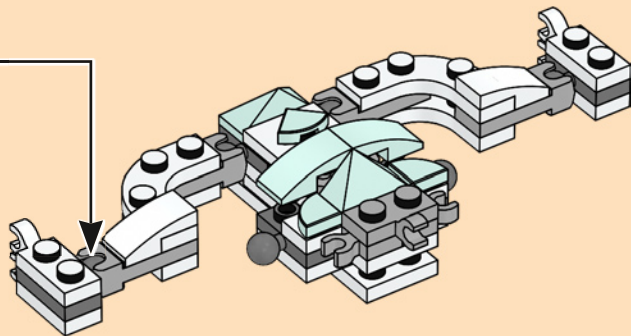

# 16

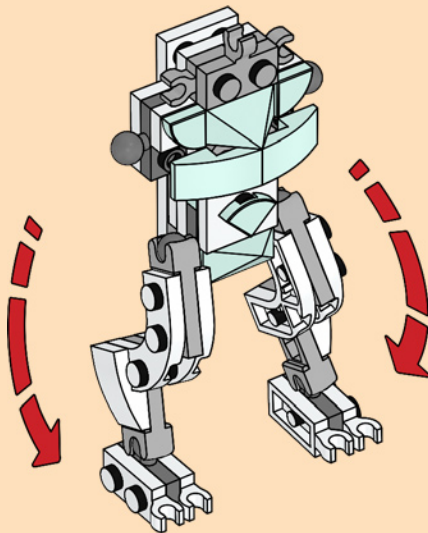

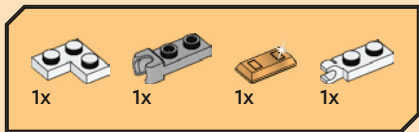

17

1

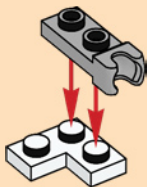

2

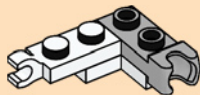



3

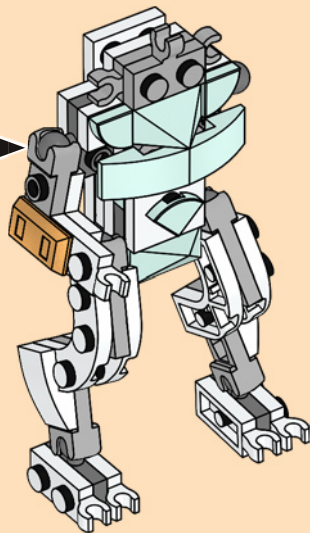
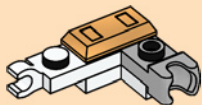

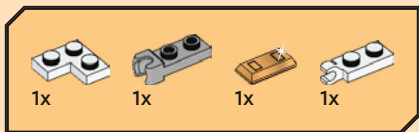

18

1

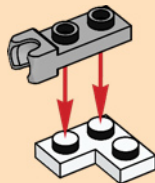

2

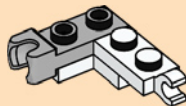

3

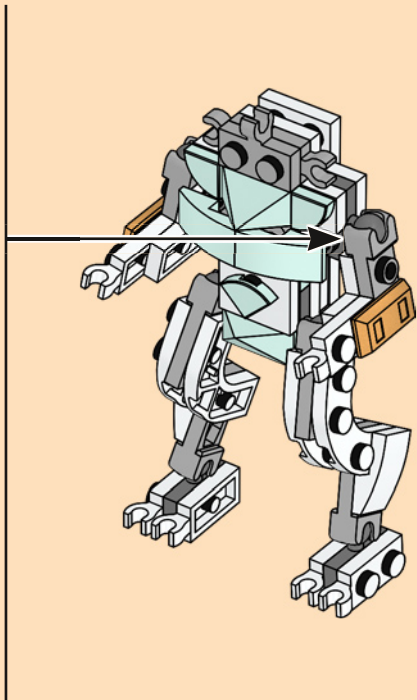
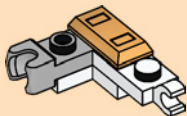

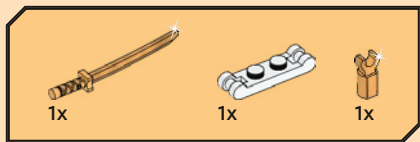

19

1

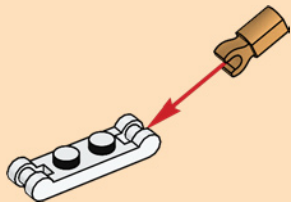

2

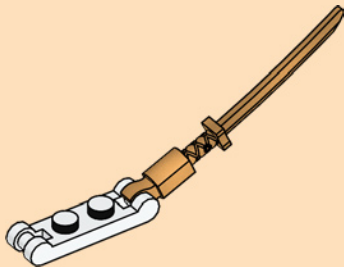

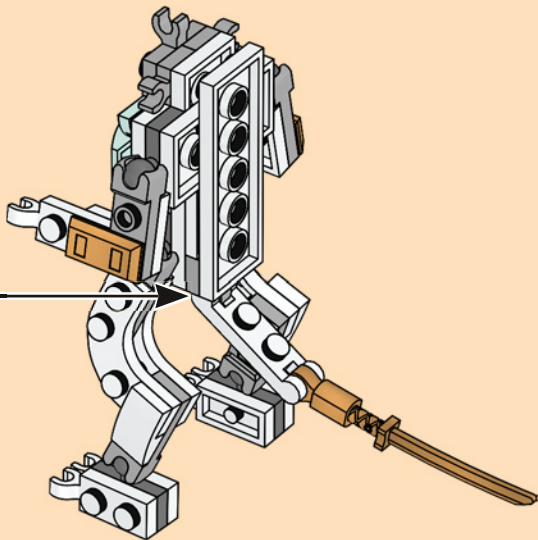

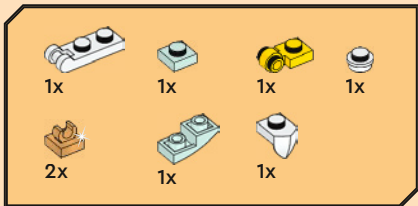

20

1

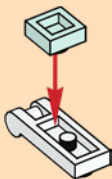

2



3



4

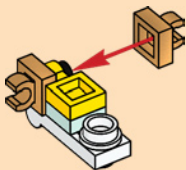

5

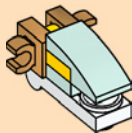

6

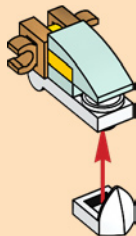

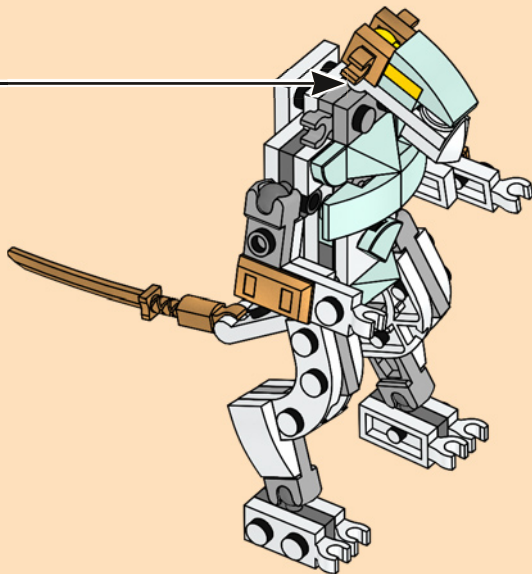





# 21

1



2



3

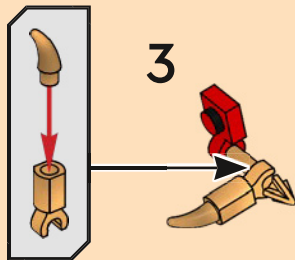

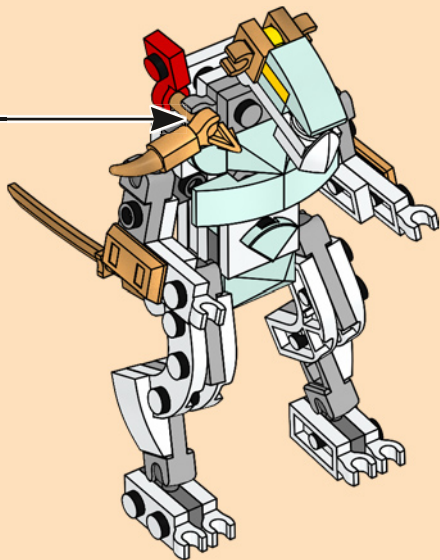



22

1



2

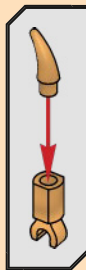

3



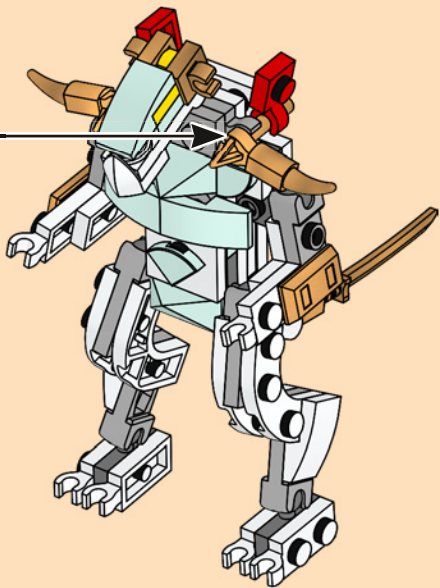



23

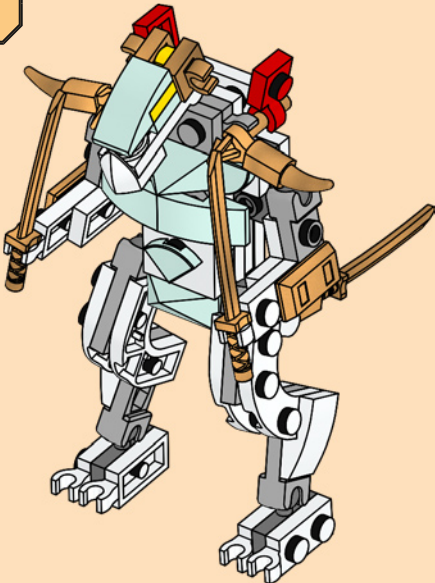

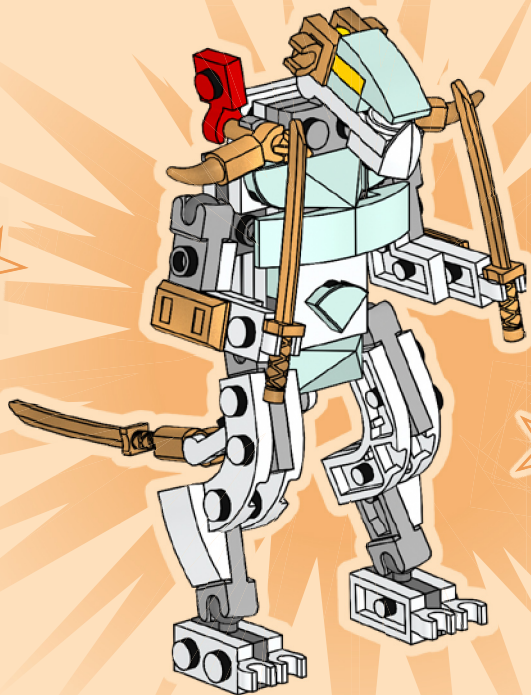

1x  
614101

4x  
6339103

2x  
6162580

2x  
6258831

3x  
6199886

3x  
6336530

1x  
6046905

1x  
302001

2x  
6270109

2x  
6296894

1x  
6058016

2x  
6335377

2x  
6034044

2x  
379501

3x  
6252838

2x  
6313114

2x  
6137764

1x  
6281992

6x  
6361170

1x  
4515364

2x  
6262138

6x  
6043639

1x  
6146701

4x  
242001

1x  
6249273

2x  
6207933

6x  
6039479

2x  
6126046

3x  
6116596



 [LEGO.com/service](https://www.LEGO.com/service)

LEGO, the LEGO logo, NINJAGO, the NINJAGO logo are trademarks of the/sont des marques de commerce du/  
son marcas registradas de LEGO Group. ©2023 The LEGO Group.