

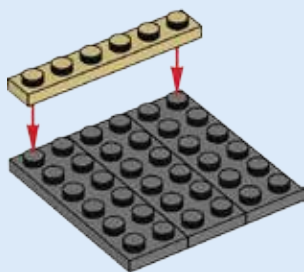

1

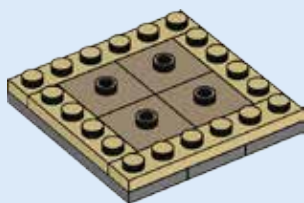

2



3



4

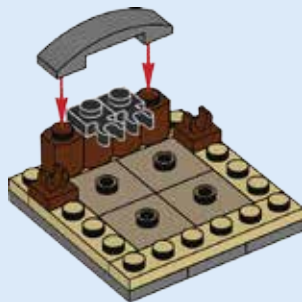

5

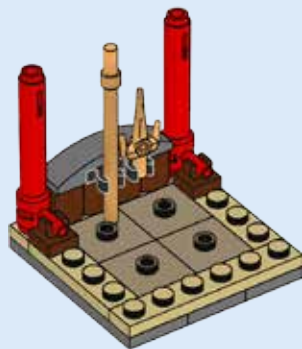

6

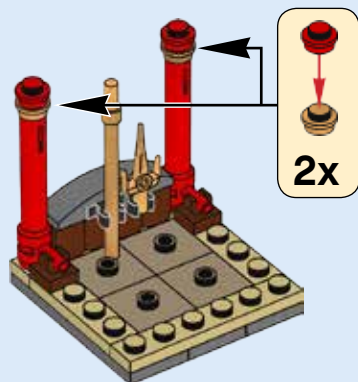

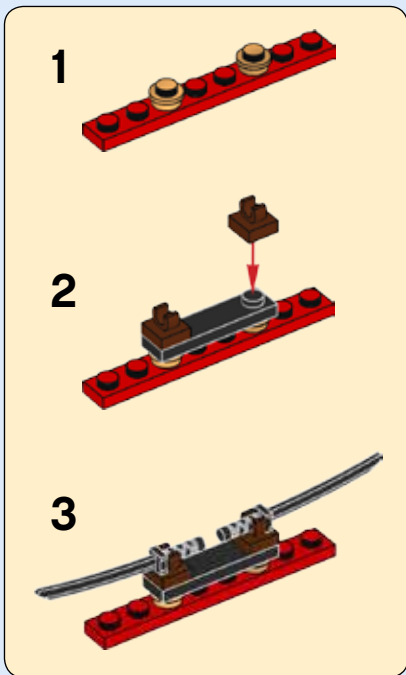

RATE THIS SET!
ÉVALUE CE JEU!



7

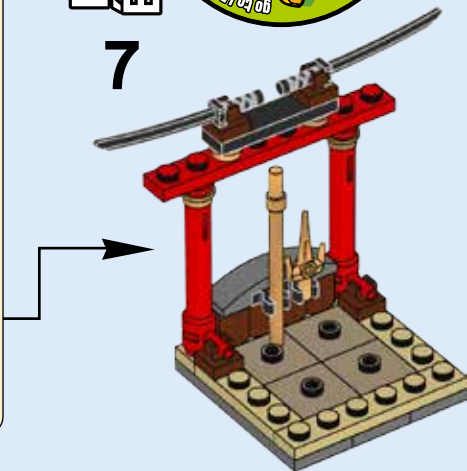

LEGO.com/service

LEGO, the LEGO logo, NINJAGO and the NINJAGO logo are trademarks of the/ont des marques de commerce d/ison marcas registradas de LEGO Group. ©2016 The LEGO Group. 6163459



NINJAGO™
Masters of Spinjitzu



LEGO.COM/NINJAGO