



WOMEN OF NASA

21312



LEGO.com/ideas



MARGARET HAMILTON

COMPUTER SCIENTIST



Born in 1936, Margaret Hamilton was always interested in mathematics. Her early work, beginning in 1959, included developing weather predicting and air-defense software at MIT, in an era when computer science and software engineering were not yet established disciplines.

When NASA contracted with MIT to develop the guidance and navigation system for its Apollo Moon-landing program, Hamilton's experience led to her becoming the leader of the team responsible for developing the spacecraft's on-board flight software for the command module and the lunar module.

On July 20, 1969, as the Apollo 11 lunar lander approached the Moon's surface, its computer suddenly became overtaxed. Priority displays designed by Hamilton warned the astronauts with 1201 and 1202 alarms, allowing NASA's Mission Control to understand what was happening and alerting the astronauts to place the rendezvous radar switch in the right position. The mission was a success, Apollo 11's crew became the first humans ever to walk on the Moon; and the software became the first software to land on the moon.

Hamilton and her team's software was so reliable that NASA went on to use parts of it in the Skylab space station and the Space Shuttle.

Hamilton is CEO of Hamilton Technologies. Its Universal Systems Language, together with its preventative life cycle and its automation, is based on her mathematical theory of control for systems and software. For her work as a pioneering computer scientist, she received NASA's Exceptional Space Act Award in 2003, and the Presidential Medal of Freedom from President Obama in 2016.



SALLY RIDE

PHYSICIST, ASTRONAUT AND ENTREPRENEUR

Sally Ride was born in Los Angeles in 1951. While completing her PhD in physics at Stanford University, she read in a student newspaper that NASA was recruiting astronauts, and for the first time, women could apply. Ride was one of 8,000 applicants and one of six women selected by NASA in 1978.

While training for her first spaceflight, Ride endured intense media attention focused on her gender. She insisted on being treated the same as any other astronaut. On June 18, 1983, she blasted off aboard the space shuttle *Challenger* to become America's first woman in space. During the flight, Ride used *Challenger's* robotic arm to capture a satellite hurtling around Earth. Her historic flight made her a symbol of women's ability to break barriers and an inspiration to generations of adventurous girls.

Ride flew aboard the *Challenger* again in 1984 and later led a task force that wrote an influential report on America's future in space. After leaving NASA in 1987, she became a physics professor. She cowrote science books for young people and cofounded a company, Sally Ride Science, to inspire students in math and science.

Ride died in 2012. She was posthumously awarded the Presidential Medal of Freedom.





NANCY GRACE ROMAN

ASTRONOMER



Born in 1925, Nancy Grace Roman formed an astronomy club with her classmates at the age of 11. After graduating early from high school, she worked at several observatories while earning a Bachelor of Arts degree and a PhD in Astronomy. Throughout her education, she battled against the belief that women should not want to be scientists.

In her late twenties, Roman discovered unusual behavior in the emission spectra of the star AG Draconis. She published her findings, becoming well recognized in the astronomy field. After working at the Naval Research Laboratory, she applied to the newly formed NASA and became the first Chief of Astronomy for its Office of Space Science, as well as the first woman to hold an executive position at the agency.

Over the course of her career at NASA, Roman was involved in the development and launching of numerous satellites. She is most famous for her work in the planning of the Hubble Space Telescope, launched in 1990, and is often called the “Mother of Hubble”.

Roman received the NASA Exceptional Scientific Achievement Medal in 1969. NASA's Nancy Grace Roman Technology Fellowship in Astrophysics and the asteroid 2516 Roman are named in her honor.



MAE JEMISON, M.D.

ASTRONAUT, ENGINEER,
PHYSICIAN, DANCER



Insatiably curious, Mae Jemison set her mind early to exploration. Pursuing everything from dinosaurs and stars to fishing, travel and dance, her mission has always included science, teaching and discovering something new!

Starting Stanford University at the age of 16, Jemison graduated with Bachelor's degrees in Chemical Engineering and African Studies. She then earned her Doctorate in Medicine from Cornell University Medical College. She practiced medicine and lived in West Africa as the Area Peace Corps Medical Officer for Sierra Leone and Liberia.

In 1987, Jemison was one of 15 individuals chosen from among 2000 applicants to train to be a NASA astronaut. On September 12, 1992, she launched into space aboard the Space Shuttle Endeavour, spending over 190 hours conducting life sciences, material sciences and medical experiments. Traveling over three million miles, Jemison was the first woman of color in the world in space.

Jemison founded an international science camp for 12-16 year olds, started two technology companies and was an environmental studies professor. Today, Jemison leads 100 Year Starship—a global initiative that is pushing the frontiers of space exploration—ensuring human interstellar travel in 100 years.

The recipient of many awards and honors, Jemison is a member of the National Academy of Medicine, the Women's Hall of Fame and the International Space Hall of Fame. Jemison loves cats, science fiction, art, dance, gardening and mysteries!

FAN DESIGNER

MAIA WEINSTOCK

Science editor and writer Maia Weinstock combined three of her personal passions in designing the Women of NASA set for LEGO® Ideas: space exploration, the history of women in science and engineering, and LEGO building.

“I thought people might like to build their own display featuring minifigs of accomplished women in the STEM [Science, Technology, Engineering and Mathematics] professions. For the vignettes, I wanted to contextualize each person in terms of her contribution to NASA history.”

“I was absolutely elated when the project reached 10,000 supporters! The set clearly touched and inspired many, as it reached 10,000 supporters in just 15 days. The night on which it appeared we’d reach 10K, I stayed up until 4:30 or 5 in the morning so that I could watch the 10,000th vote come in. I didn’t get much sleep that day, but it was thrilling!”

“It is incredibly rare for a company — much less a global powerhouse like LEGO — to crowdsource ideas from fans/customers/potential customers. I give LEGO Ideas a ton of credit for pushing the envelope in terms of giving the public a say in what ultimately becomes available. I also value LEGO Ideas for simply being a platform where nontraditional set ideas can be seen and appreciated for what they are.”



LEGO® DESIGNERS

GEMMA ANDERSON & MARIE SERTILLANGES

LEGO® designers Gemma Anderson and Marie Sertillanges were thrilled to help refine Maia's model into an official LEGO set.

"I was extremely excited about working on this one, especially as I had already heard of it and really wanted it to become a set," says Gemma. "My focus was on ensuring that the model had stability, the colors were aligned and the subjects were accurately portrayed, all while staying respectful to the design of the original model."

For Marie, "The main challenge in designing the minifigures and the decorations was that I could not make anything up. Every detail was important and needed to match reality, since they represent real-life women. It was beautiful to hear some of the stories behind the scenes, like how Sally's name tag was changed from 'Sally Ride' to just 'Sally' at her own request."

The designers were extremely happy about their collaboration with the fan designer, Maia Weinstock. They hope to have truly captured the achievements of Margaret Hamilton, Sally Ride, Nancy Grace Roman and Mae Jemison, four very inspirational women.

Photo right: Marie, Gemma and project Design Lead Tara Wike dream of their own outer space adventures.





MARGARET HAMILTON

INFORMATICIENNE

Née en 1936, Margaret Hamilton a toujours eu un intérêt pour les mathématiques. Débutant en 1959, à une époque où l'informatique et le génie logiciel ne figurent pas encore au rang des disciplines établies, ses premiers projets au Massachusetts Institute of Technology (MIT) consistent à développer des programmes de prévision météorologique et de défense aérienne.

Plus tard, la NASA charge MIT de développer le système de guidage et de navigation qui servira à l'atterrissage lunaire du module Apollo. Forte de son expérience, Margaret Hamilton est nommée chef de l'équipe responsable de concevoir le logiciel de vol intégré au vaisseau spatial pour le module de commande et le module lunaire.

Le 20 juillet 1969, alors que le module lunaire Apollo 11 s'approche de la surface de la Lune, un signal indique soudainement que l'ordinateur est saturé. Alerté par les alarmes des programmes 1201 et 1202 qu'émettent les écrans de priorité conçus par Margaret Hamilton, le centre de contrôle de mission de la NASA prend connaissance de la situation et commande aux astronautes de placer le bouton du radar de rendez-vous dans la bonne position. Mission accomplie ! Les membres de l'équipage d'Apollo 11 sont devenus les premiers êtres humains à marcher sur la Lune, et le logiciel devint également le premier à atterrir sur la Lune.

Le logiciel développé par Margaret Hamilton et son équipe était tellement fiable que la NASA l'a utilisé en partie à bord de la station spatiale Skylab et de la navette spatiale.

Margaret Hamilton est chef de la direction de Hamilton Technologies, l'entreprise qui a mis au point le langage de programmation Universal Systems Language. Ce langage, de même que la gestion préventive et l'automatisation du cycle de vie, repose sur sa théorie mathématique des commandes pour les systèmes et les logiciels. Le travail de cette pionnière de l'informatique lui vaut une récompense de la NASA en 2003, et la médaille présidentielle de la Liberté, que lui remet le président Obama en 2016.





SALLY RIDE

PHYSICIENNE, ASTRONAUTE ET ENTREPRENEURE



Sally Ride naît à Los Angeles en 1951. Elle terminait son doctorat en physique à l'Université Stanford quand elle a vu, annoncé dans un journal étudiant, que le recrutement d'astronautes de la NASA était pour la première fois ouvert aux femmes. Parmi les 8 000 candidats, Sally Ride est l'une des six femmes qui rejoignent la NASA en 1978.

Pendant sa formation en vue de son premier vol dans l'espace, elle attire fortement l'attention des médias sur la place des femmes. Elle tenait à ce qu'on la traite de la même façon que n'importe quel autre astronaute. Le 18 juin 1983, elle décolle à bord de la navette spatiale *Challenger* et devient la première Américaine à aller dans l'espace. Durant le vol, elle se sert du bras robotisé de l'engin spatial pour récupérer un satellite en orbite autour de la Terre. Son vol historique fait de Sally Ride un symbole féminin qui n'a pas froid aux yeux et une source d'inspiration pour des générations de jeunes aventurières.

En 1984, elle s'envole une seconde fois à bord de *Challenger*, et plus tard, prend les rênes d'un groupe de travail qui rédige un rapport phare pour l'avenir de l'Amérique dans l'industrie spatiale. Après son départ de la NASA en 1987, elle se met à enseigner la physique. Afin de sensibiliser les élèves aux mathématiques et aux sciences, elle coécrit des livres pour les jeunes sur des sujets scientifiques et cofonde l'entreprise Sally Ride Science.

Sally Ride meurt en 2012. On lui décerne à titre posthume la médaille présidentielle de la Liberté.



NANCY GRACE ROMAN

ASTRONOME



Née en 1925, Nancy Grace Roman crée un club d'astronomie avec ses camarades à l'âge de 11 ans. Après l'obtention de son diplôme d'études secondaires accélérées, elle décroche un baccalauréat en arts et un doctorat en astronomie tout en travaillant pour plusieurs observatoires. Tout au long de ses études, elle se bat contre la croyance selon laquelle les femmes ne devraient pas vouloir faire carrière en sciences.

Dans la vingtaine avancée, Nancy Grace Roman découvre que le spectre d'émission de l'étoile AG Draconis a changé de manière inhabituelle. Elle publie ses découvertes et se fait peu à peu un nom dans le domaine de l'astronomie. Après s'être jointe au laboratoire de recherche de la marine américaine, elle pose sa candidature à la toute nouvelle NASA et est la première personne à diriger la division d'astronomie du bureau des sciences spatiales de l'agence, ainsi que la première femme à y occuper un poste de cadre.

Au fil de sa carrière à la NASA, Nancy Grace Roman participe à la mise au point et au lancement de nombreux satellites. Souvent appelée la « mère de Hubble », elle est surtout célèbre pour son travail dans la mise en place du télescope spatial Hubble, lancé en 1990.

En 1969, on lui remet la médaille de la NASA pour ses réalisations exceptionnelles en sciences. La bourse d'astrophysique Nancy Grace Roman Technology Fellowship de la NASA et l'astéroïde (2516) Roman sont nommés en son honneur.



MAE JEMISON, M.D.

ASTRONAUTE, INGÉNIEURE,
MÉDECIN, DANSEUSE

De nature toujours curieuse, Mae Jemison a eu très tôt l'envie de partir en exploration. Elle se donne pour mission de s'intéresser à tout ce qui touche à la science, à l'enseignement et aux nouvelles découvertes, qu'il s'agisse des dinosaures, des étoiles, de la pêche, des voyages ou de la danse !

Admise à l'Université Stanford à l'âge de 16 ans, elle obtient un baccalauréat en génie chimique et en études africaines. Ensuite, elle passe son doctorat à l'école de médecine de l'Université Cornell. Elle se joint au corps des volontaires de la paix de la Sierra Leone et du Libéria en Afrique de l'Ouest, où elle habite, pour offrir ses services de médecin.

En 1987, elle est l'une des quinze personnes choisies parmi 2 000 candidats pour suivre la formation d'astronaute à la NASA. Le 12 septembre 1992, elle part à l'aventure dans l'espace à bord de la navette spatiale Endeavour, où elle passe plus de 190 heures à réaliser des expériences en sciences de la vie, en sciences des matériaux et en sciences médicales. Son voyage de près de cinq millions de kilomètres lui vaut le titre de première femme de couleur au monde à parcourir l'espace.

Mae Jemison fonde un camp scientifique international pour les enfants de 12 à 16 ans, lance deux entreprises de technologie et enseigne les études environnementales. Aujourd'hui, elle est à la tête du programme 100 Year Starship, une initiative mondiale qui repousse les frontières de l'exploration spatiale afin que nous puissions effectuer des voyages interstellaires d'ici 100 ans.

Lauréate de nombreux prix et distinctions, elle est membre de la National Academy of Medicine, du Women's Hall of Fame et de l'International Space Hall of Fame. Mae Jemison adore les chats, la science-fiction, l'art, la danse, le jardinage et les mystères !



Rédactrice en chef et journaliste scientifique, Maia Weinstock a combiné trois de ses passions personnelles dans la conception de l'ensemble LEGO® Ideas sur le thème des femmes de la NASA : l'exploration spatiale, l'histoire des femmes dans les sciences et l'ingénierie, ainsi que la construction LEGO.

« J'ai pensé que les gens auraient envie de construire leur propre modèle comprenant des figurines de femmes accomplies en STEM [sciences, technologies, ingénierie et mathématiques]. Pour les scènes, j'ai voulu situer chaque femme dans le contexte de sa contribution à l'histoire de la NASA. »

« J'étais absolument ravie que le projet obtienne l'appui de 10 000 personnes ! De toute évidence, l'ensemble a touché et inspiré bien des gens, car on a reçu 10 000 votes en 15 jours à peine. La nuit où on a atteint ce chiffre, je suis restée debout jusqu'à 4 h 30 ou 5 h du matin pour voir la 10 000^e personne voter. Je n'ai pas tellement dormi ce jour-là, mais c'était passionnant ! »

« Rares sont les entreprises qui font appel aux amateurs, à la clientèle et aux clients potentiels pour rassembler des idées, surtout une société d'envergure mondiale comme LEGO. Je lève mon chapeau à LEGO Ideas pour avoir pris les devants et donné une voix au public quant à ce qui se retrouve sur le marché. J'apprécie également LEGO Ideas pour sa plateforme simple qui permet de présenter et de véritablement valoriser les concepts d'ensembles non traditionnels. »

FAN DESIGNER

MAIA WEINSTOCK



Les designers LEGO® Gemma Anderson et Marie Sertillanges se réjouissaient d'aider Maia Weinstock à transformer son modèle en un authentique ensemble LEGO.

« J'ai eu beaucoup de plaisir à travailler sur ce projet, car j'en avais déjà entendu parler et je tenais à ce qu'on en fasse un ensemble », affirme Gemma Anderson. « Mon objectif était de m'assurer de la stabilité du modèle, de l'harmonie des couleurs et de l'exactitude des sujets présentés, tout en respectant la conception du modèle original. »

Marie Sertillanges raconte : « Je ne pouvais pas concevoir les figurines et le décor comme bon me semblait, et c'était tout un défi. Comme il s'agit de femmes bien réelles, le moindre détail compte et doit coller à la réalité. Certaines des anecdotes faisaient plaisir à entendre, comme celle où Sally Ride a fait changer le nom de son insigne pour "Sally" au lieu de son nom complet. »

Les designers étaient enchantées de leur collaboration avec la fan designer Maia Weinstock. Elles espèrent avoir rendu fidèlement les exploits de Margaret Hamilton, Sally Ride, Nancy Grace Roman et Mae Jemison, quatre femmes absolument inspirantes.

Photo sur la droite : Marie Sertillanges, Gemma Anderson et Tara Wike, responsable de la conception du projet, rêvent de leurs propres aventures spatiales.

DESIGNERS LEGO®

GEMMA ANDERSON ET MARIE SERTILLANGES





MARGARET HAMILTON

CIENTÍFICA DE COMPUTADORAS

Nacida en 1936, Margaret Hamilton siempre sintió un interés especial por las matemáticas. Sus primeros trabajos llegaron en 1959, con el desarrollo de software de pronóstico meteorológico y defensa aérea para el MIT, en una época en la que la ingeniería de software no se consideraba aún una disciplina.

Cuando la NASA contrató al MIT para desarrollar el sistema de guía y navegación del programa de alunizaje Apolo, la experiencia de Hamilton la llevó a liderar el equipo responsable del desarrollo del software de vuelo a bordo de los módulos de control y lunar.

El 20 de julio de 1969, mientras el módulo de alunizaje de la misión Apolo 11 se aproximaba a la superficie de la Luna, su computadora comenzó a sobrecargarse de repente. Las pantallas de datos diseñadas por Hamilton mostraron las alarmas 1201 y 1202, permitiendo al Centro de Control de Misiones de la NASA entender lo que estaba sucediendo y pedir a los astronautas que colocaran el interruptor del radar de localización en la posición correcta. La misión fue un éxito. La tripulación del Apolo 11 se convirtió en el primer grupo de seres humanos en caminar sobre la Luna; y el software en el primer software en llegar hasta ella.

Hamilton y su equipo crearon un software tan confiable que la NASA decidió incorporar partes del mismo a la estación espacial Skylab y el transbordador espacial.

Hamilton es la directora general de Hamilton Technologies. Los importantes logros de la compañía (como el lenguaje universal de sistemas, el ciclo de vida preventivo y sus tecnologías de automatización) se basan en su teoría matemática de control de sistemas y software. En reconocimiento a su trabajo como pionera en el mundo de la informática, recibió el Premio al Acto Espacial Excepcional de la NASA en 2003 y la Medalla Presidencial de la Libertad de manos del presidente Obama en 2016.





SALLY RIDE

FÍSICA, ASTRONAUTA Y EMPRENDEDORA



Sally Ride nació en Los Ángeles en 1951. Mientras terminaba su doctorado en física por la Universidad de Stanford, leyó en un periódico estudiantil que la NASA buscaba astronautas y que, por primera vez, las mujeres podían participar. Ride fue una de las 8.000 solicitantes y también una de las seis mujeres elegidas por la NASA en 1978.

Mientras entrenaba para su primer viaje espacial, Ride soportó una intensa atención mediática concentrada en su género. Insistió en recibir el mismo tratamiento que cualquier otro astronauta. El 18 de junio de 1983 despegó a bordo del transbordador *Challenger* y se convirtió en la primera mujer de América en viajar al espacio. Durante el vuelo, Ride usó el brazo robótico del *Challenger* para atrapar un satélite que orbitaba alrededor de la Tierra. Su histórico vuelo la convirtió en un símbolo de la capacidad de las mujeres para romper barreras y un modelo para las generaciones venideras de pequeñas aventureras.

Ride volvió a volar en el *Challenger* en 1984 y lideró más tarde un grupo de trabajo que redactó un influyente informe sobre el futuro de América en el espacio. Luego de abandonar la NASA en 1987, se convirtió en maestra de física. Participó en la redacción de varios libros de ciencia para jóvenes y cofundó la empresa Sally Ride Science, cuya misión es promover la educación en los campos de las matemáticas y las ciencias.

Ride falleció en 2012. Recibió la Medalla Presidencial de la Libertad a título póstumo.



NANCY GRACE ROMAN

ASTRÓNOMA



Nacida en 1925, Nancy Grace Roman fundó un club de astronomía con sus compañeros de clase cuando tenía 11 años. Luego de graduarse antes de tiempo de la escuela preparatoria, trabajó en varios observatorios mientras cursaba una licenciatura y un doctorado en astronomía. Durante sus estudios luchó contra la creencia establecida de que las mujeres no debían interesarse por la ciencia.

Poco antes de cumplir treinta años, Roman descubrió un comportamiento inusual en los espectros de emisión de la estrella AG Draconis. Publicó sus hallazgos, labrándose así una reputación en el campo de la astronomía. Después de trabajar en el Laboratorio de Investigación Naval, solicitó un puesto en la recién formada NASA y se convirtió en la primera directora de astronomía de la Oficina de Ciencias Espaciales y la primera mujer en ocupar un puesto ejecutivo en la agencia.

A lo largo de su carrera en la NASA, Roman participó en el desarrollo y lanzamiento de numerosos satélites. Famosa por su trabajo en la planificación del telescopio espacial Hubble, lanzado en 1990, es conocida con frecuencia como «Madre del Hubble».

Roman recibió la Medalla al Logro Científico Excepcional de la NASA en 1969. La Comunidad Tecnológica de Astrofísica Nancy Grace Roman de la NASA y el asteroide 2516 Roman fueron nombrados en su honor.



MAE JEMISON, M.D.

ASTRONAUTA, INGENIERA,
MÉDICA Y BAILARINA



La insaciable curiosidad de Mae Jemison la empujó muy pronto hacia la exploración. Interesada por cosas tan diferentes como los dinosaurios, las estrellas, la pesca, los viajes y la danza, la ciencia, la enseñanza y el descubrimiento de cosas nuevas siempre han formado parte de su misión.

Matriculada en la Universidad de Stanford a los 16 años, Jemison obtuvo el grado de licenciatura en ingeniería química y estudios africanos. Más tarde recibió su doctorado en medicina en el Colegio Médico de la Universidad de Cornell. Practicó la medicina y vivió en el África Occidental como oficial médico del Cuerpo de Paz para Sierra Leona y Liberia.

En 1987, Jemison fue una de las 15 personas elegidas de entre las 2.000 que solicitaron entrenamiento para ser astronautas de la NASA. El 12 de septiembre de 1992 viajó al espacio a bordo del transbordador espacial Endeavour y pasó más de 190 horas realizando experimentos en los campos de la biología, los materiales y la medicina. Con casi cinco millones de kilómetros viajados, Jemison fue la primera mujer de color en el espacio.

Jemison fundó un campamento internacional de ciencias para niños de 12 a 16 años, creó dos empresas tecnológicas y fue maestra de estudios medioambientales. En la actualidad, Jemison lidera la iniciativa internacional Nave de los 100 Años, dedicada a ampliar las fronteras de la exploración espacial y cuyo objetivo es hacer posibles los viajes interestelares en 100 años.

Ganadora de numerosos premios y galardones, Jemison es miembro de la Academia Nacional de Medicina, el Salón de la Fama de las Mujeres y el Salón de la Fama Espacial Internacional. ¡A Jemison le encantan los gatos, la ciencia ficción, el arte, la danza, la jardinería y los misterios!

La editora y escritora científica Maia Weinstock mezcló tres de sus pasiones personales al diseñar el set Mujeres de la NASA para LEGO® Ideas: la exploración espacial, la historia de las mujeres en los campos de la ciencia y la ingeniería, y la construcción con LEGO.

«Pensé que a la gente podría gustarle construir su propia exposición con minifiguras de grandes mujeres con profesiones CTIM —un concepto que engloba la ciencia, la tecnología, la ingeniería y las matemáticas—. En las viñetas, quise contextualizar a cada persona en relación con su contribución a la historia de la NASA».

«¡Me alegré muchísimo cuando el proyecto alcanzó los 10.000 votos! El set debió de conmover e inspirar a mucha gente, ya que los votos llegaron en sólo 15 días. La noche en que parecía que llegaríamos al objetivo, me quedé despierta hasta las 4:30 o las 5:00 de la mañana para poder ver la llegada del voto número 10.000. No dormí mucho ese día, ¡pero fue emocionante!»

«Es increíblemente poco frecuente que una empresa —y mucho menos un fenómeno internacional como LEGO— pida ideas a sus fans, usuarios y clientes potenciales. Me parece tremendamente respetable que LEGO Ideas haya dado el paso y permita al público expresar lo que quiere que llegue al mercado. También valoro mucho a LEGO Ideas por el solo hecho de ser una plataforma en la que las ideas menos tradicionales se observan y valoran por lo que son en realidad».

LA FAN DISEÑADORA

MAIA WEINSTOCK



A Gemma Anderson y Marie Sertillanges, diseñadoras de LEGO®, les fascinó tener la oportunidad de convertir el modelo de Maia en un set LEGO oficial.

«Me entusiasmé cuando supe que iba a trabajar en el modelo, especialmente porque ya había oído hablar de él y realmente quería que llegara a convertirse en un set», comenta Gemma. «Mi objetivo fue garantizar la estabilidad del modelo, elegir los colores adecuados y lograr que las mujeres estuvieran bien representadas, respetando siempre el diseño del modelo original».

Según Marie: «El principal reto al diseñar las minifiguras y decoraciones fue que no se podía inventar nada. Todos los detalles eran importantes y tenían que ajustarse a la realidad, ya que representaban mujeres reales. Fue hermoso descubrir algunas historias que no muchos conocen, como el motivo por el que la placa de identificación de Sally cambió de “Sally Ride” a sólo “Sally” a petición de ella misma».

Las diseñadoras quedaron muy satisfechas de su colaboración con la fan diseñadora, Maia Weinstock. Esperan haber representado con fidelidad los logros de Margaret Hamilton, Sally Ride, Nancy Grace Roman y Mae Jemison, cuatro mujeres verdaderamente inspiradoras.

A la derecha: Marie, Gemma y Tara Wike, jefa de diseño, sueñan con sus propias aventuras en el espacio exterior.

LAS DISEÑADORAS DE LEGO®

**GEMMA ANDERSON Y
MARIE SERTILLANGES**





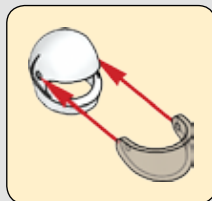
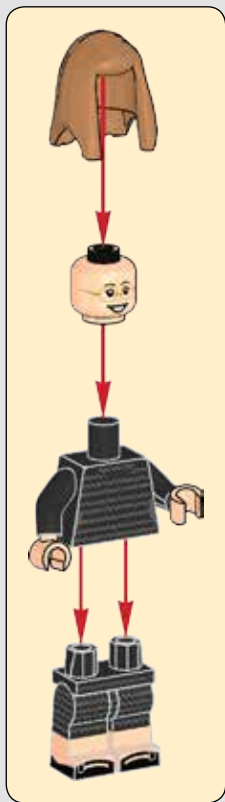

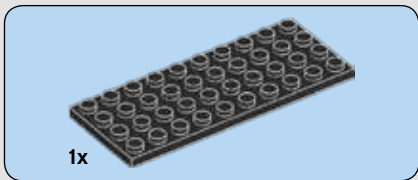

1

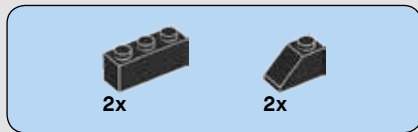
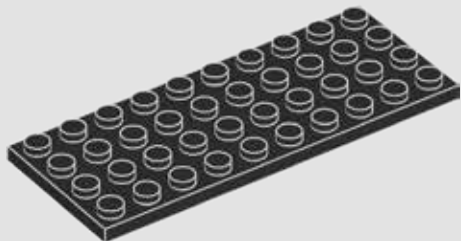

2

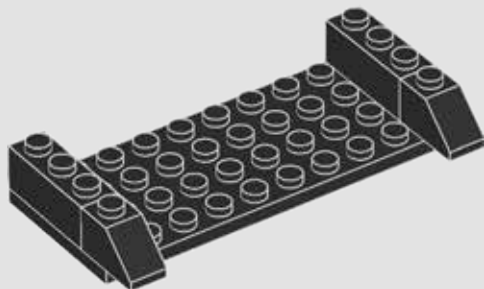

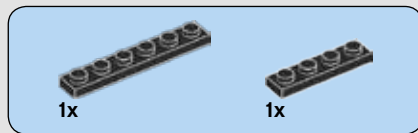

3

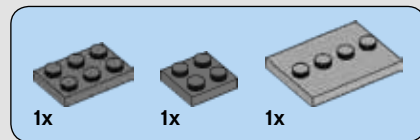
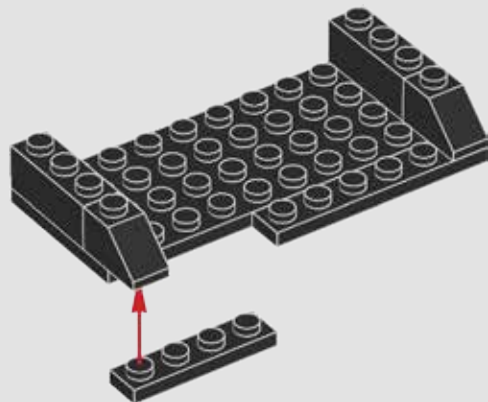

4

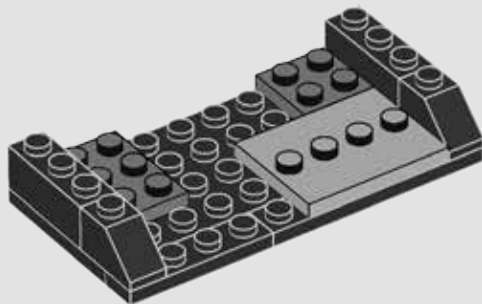



2x

5

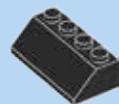
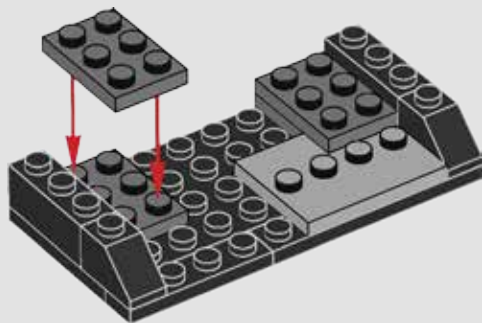

1x



2x

6

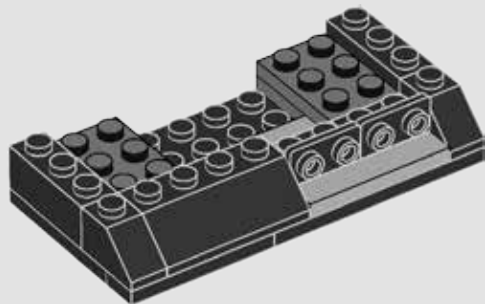

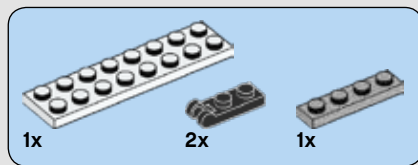

7

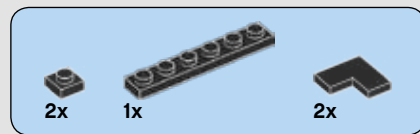
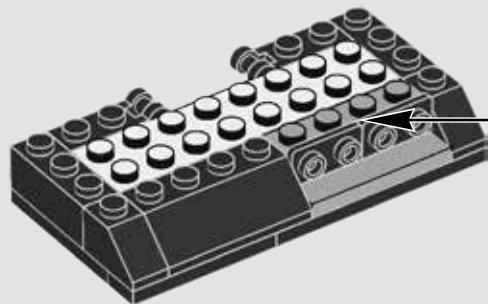
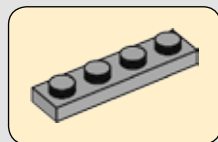

8

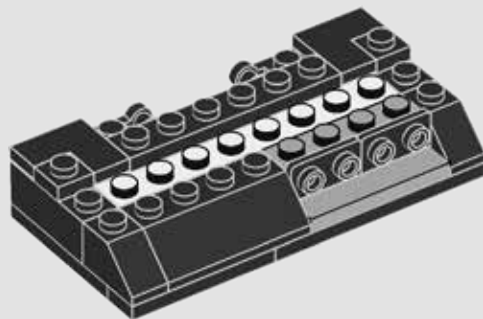

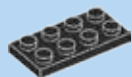

1x

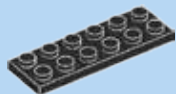

1x

9

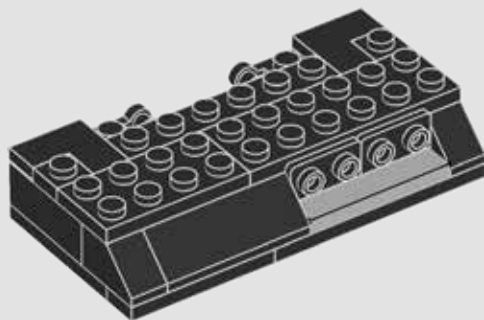

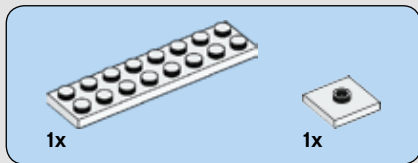

10

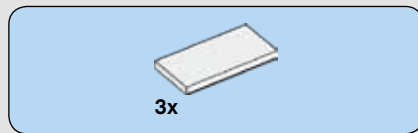
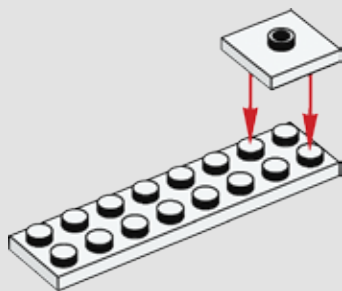

11

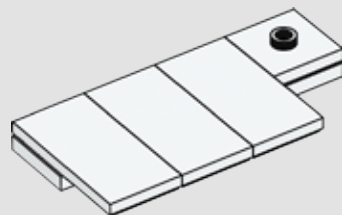

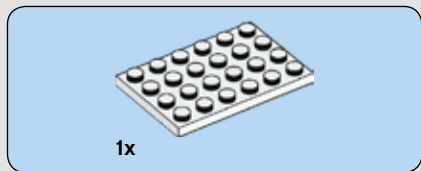

12

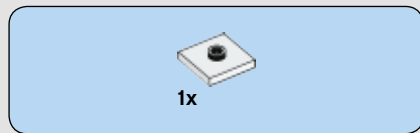
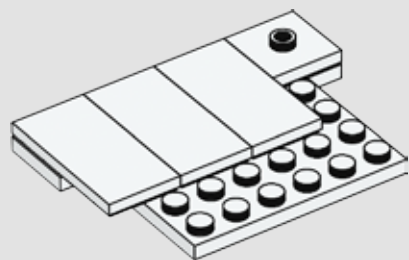

13

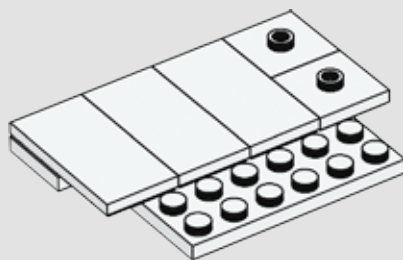

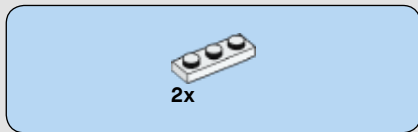

14

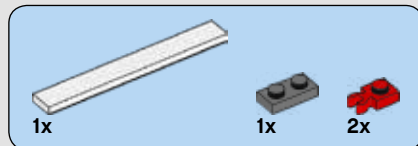
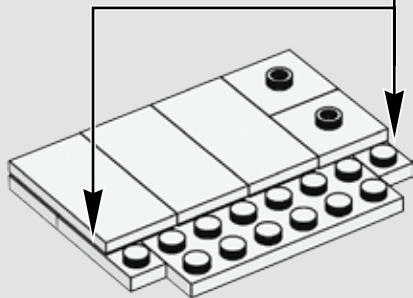
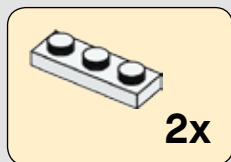

15

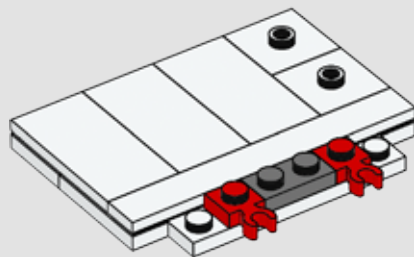



2x



2x

16

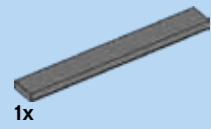
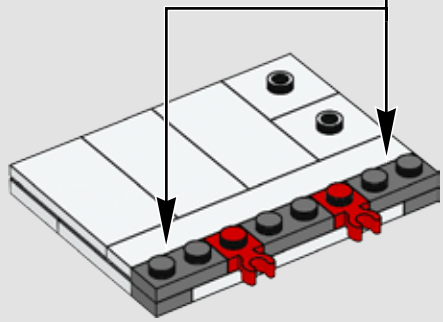
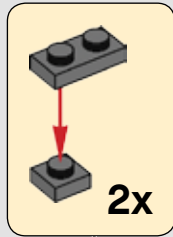

1x

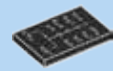

1x

17

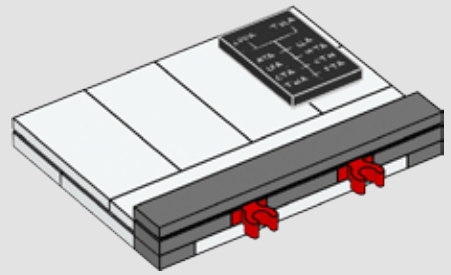

18

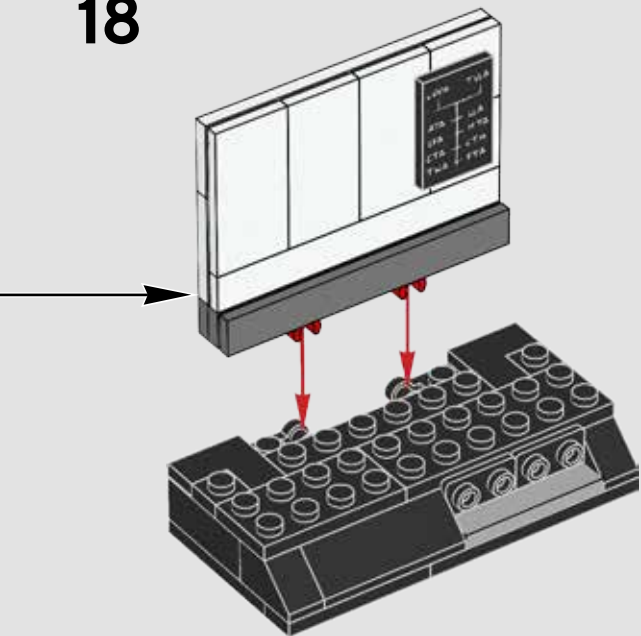

19

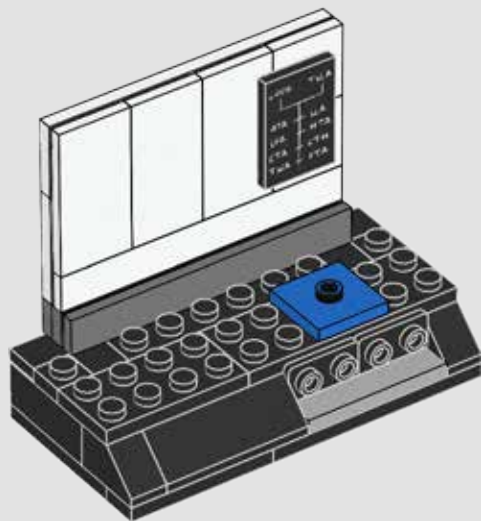

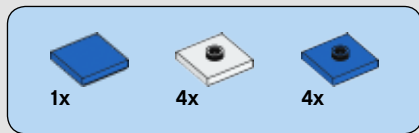

20

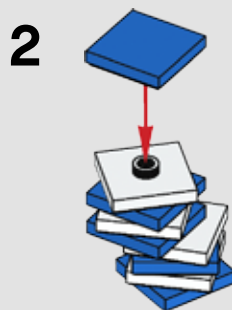
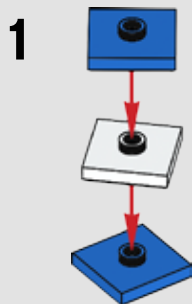



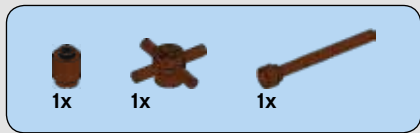

21

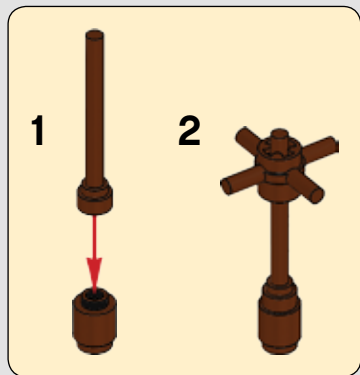



1x

22



Margaret Hamilton

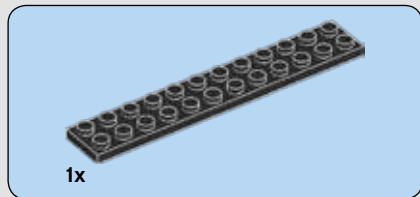
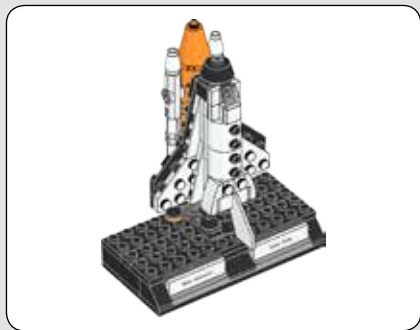

1x

1

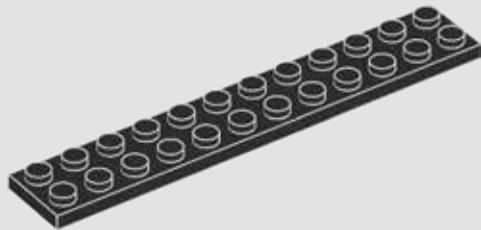

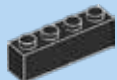

2x



1x

2

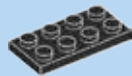
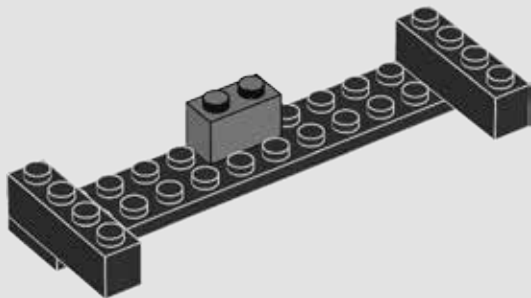

2x

3

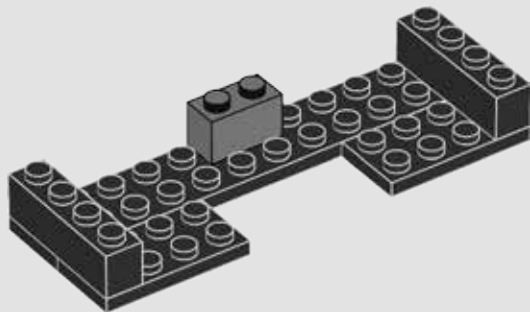

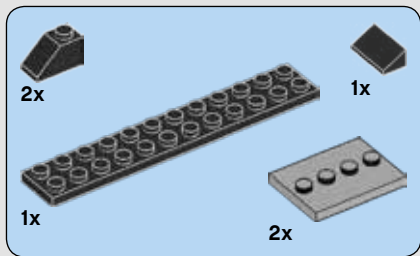

4

1

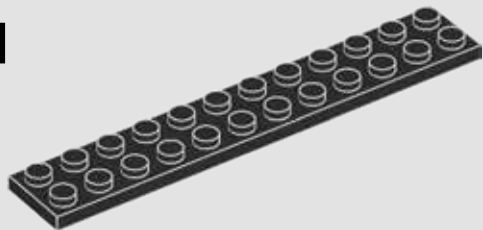

2

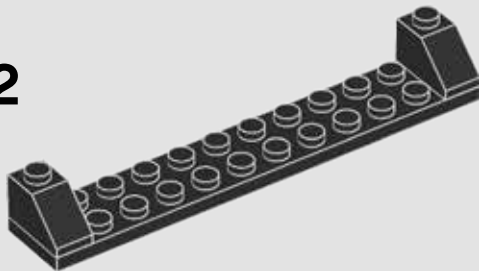

3

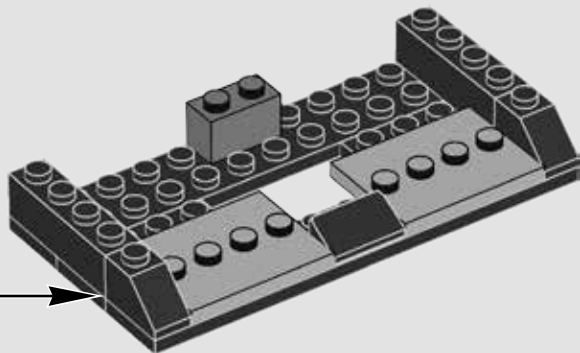
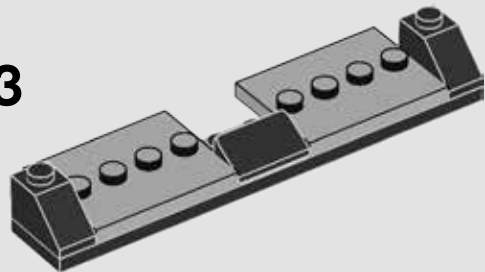

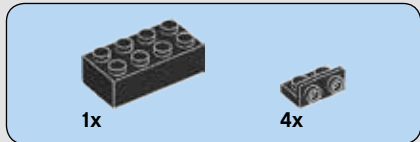

5

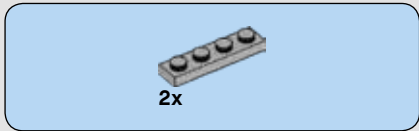
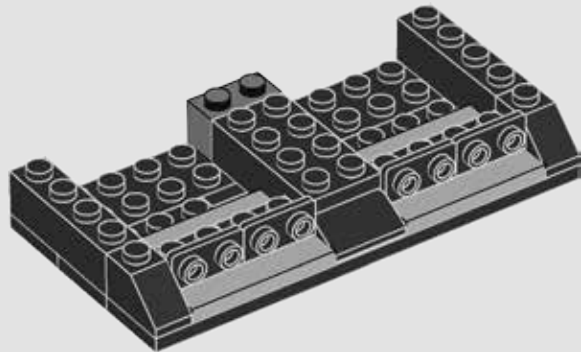

6

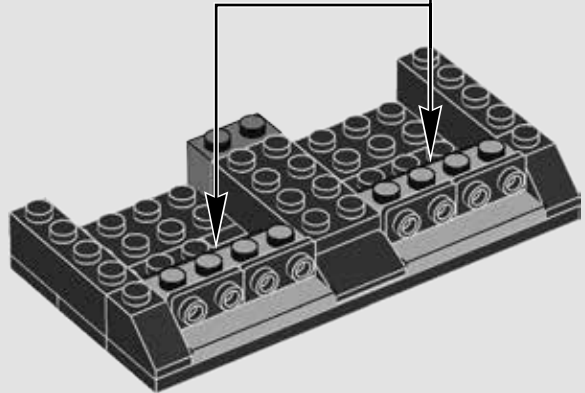
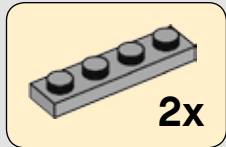

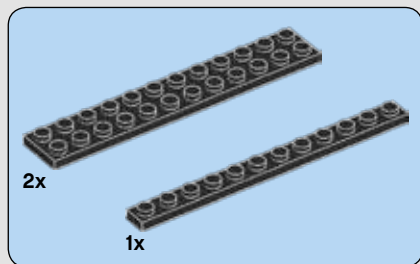

7

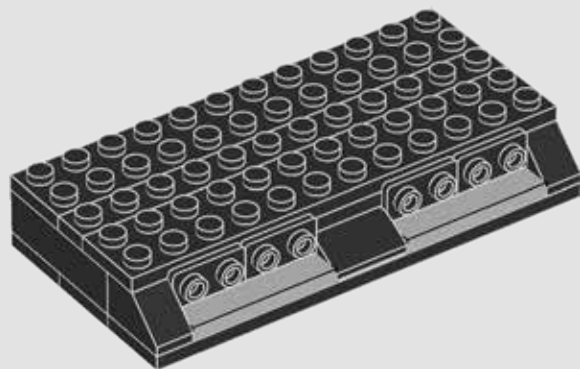

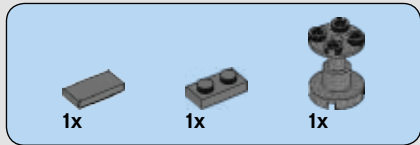

8

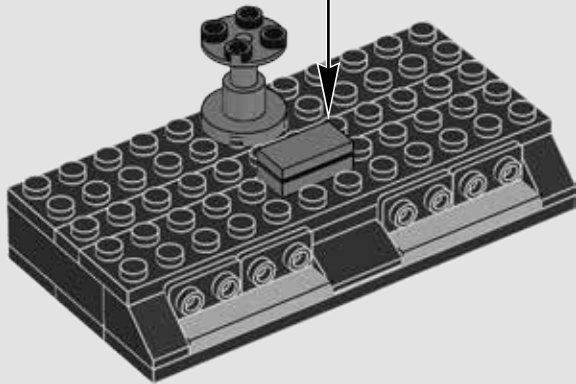
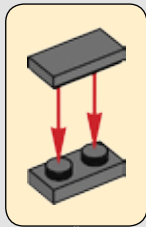

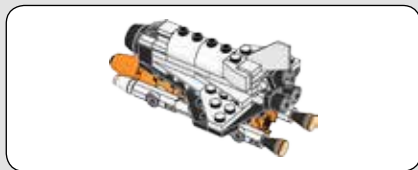

9

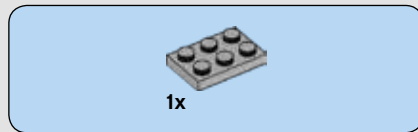
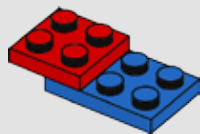

10

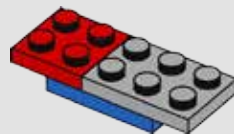

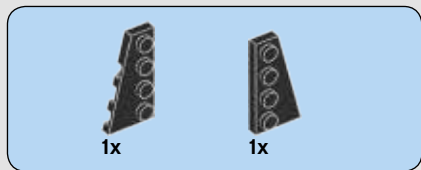

11

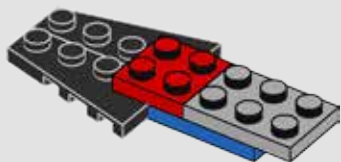

44



12

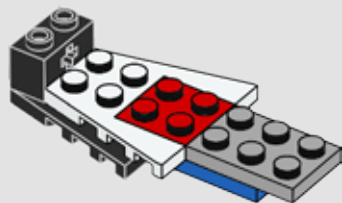



13

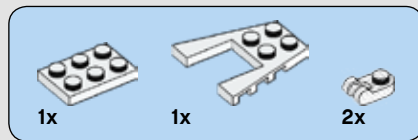
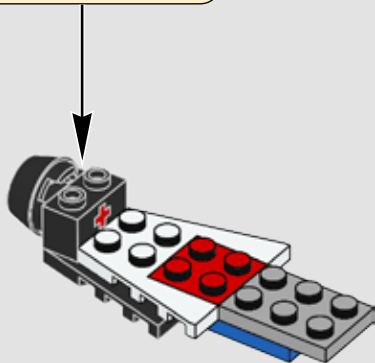
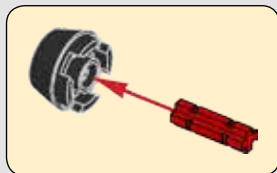

14

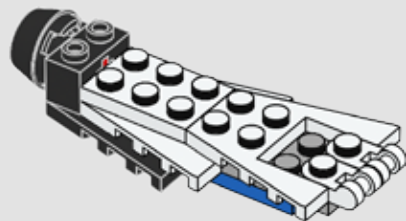



2x



1x

15

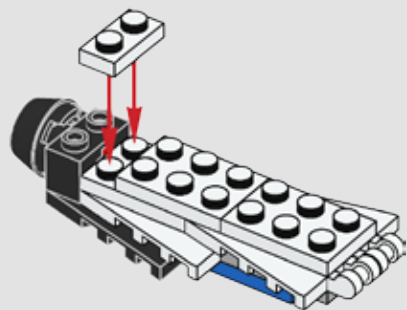

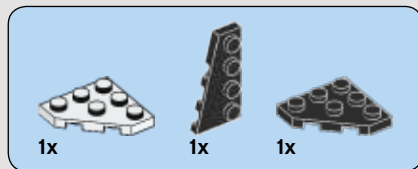

16

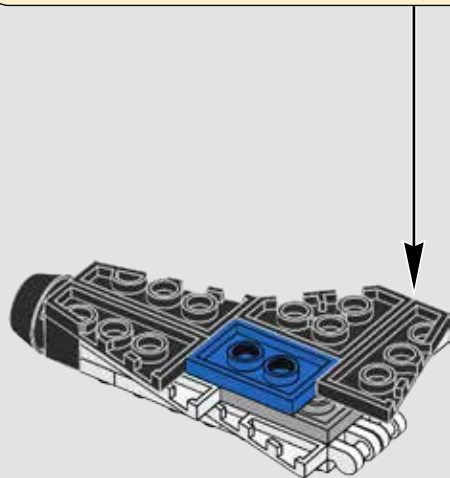
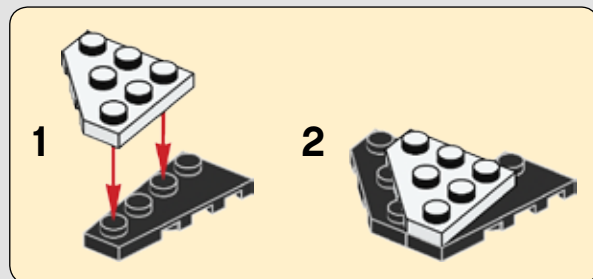
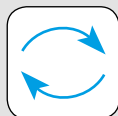

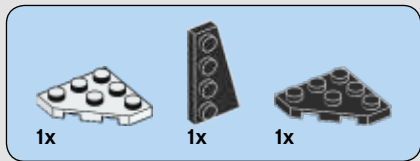

17

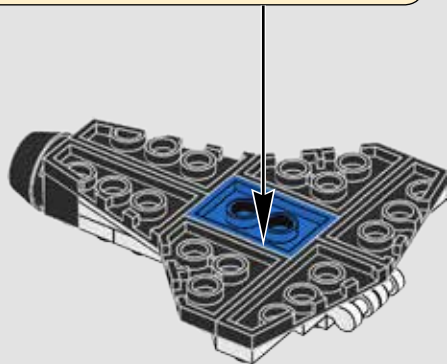
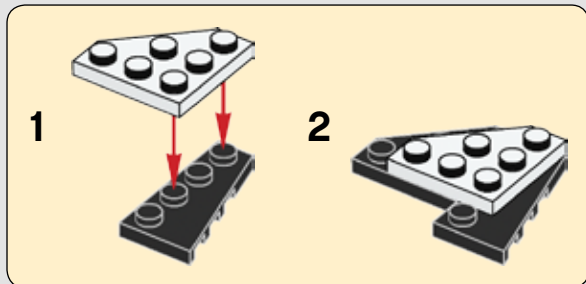



2x

18

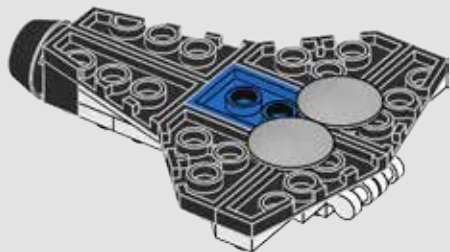

2x

19

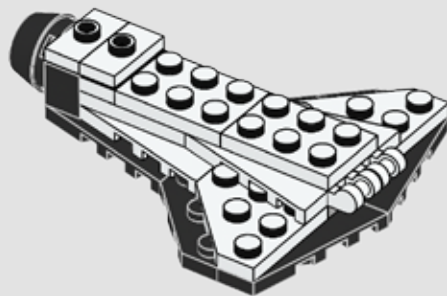
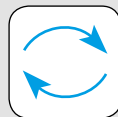



1x



1x



1x

20

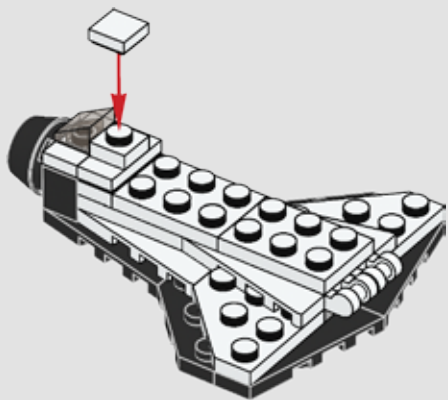

2x



2x

21

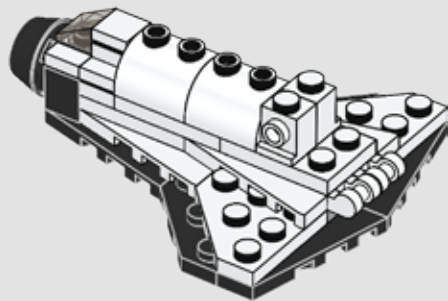



22

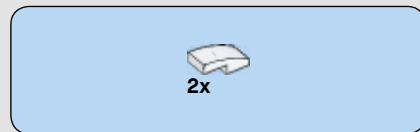
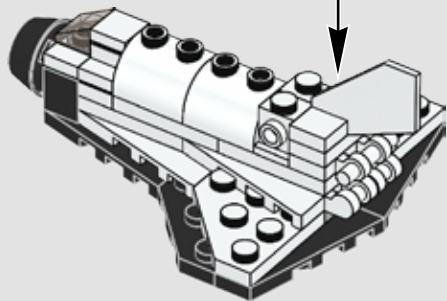
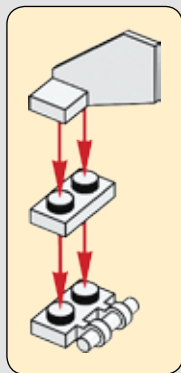

23

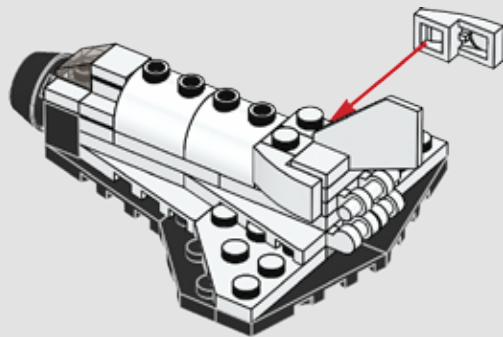



3x



3x

24



3x

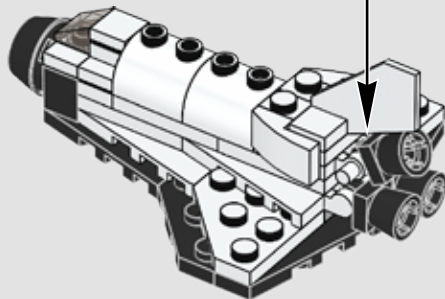

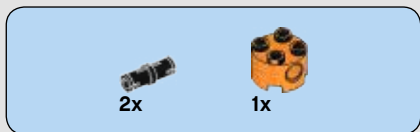
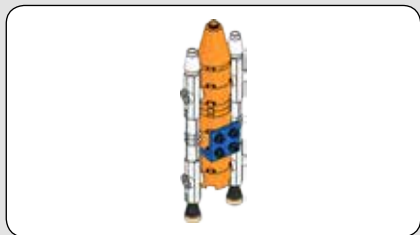

25

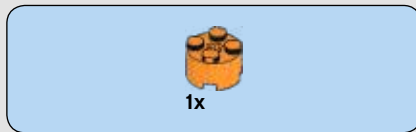
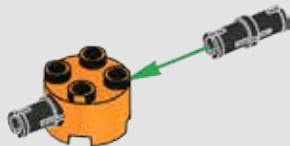

26

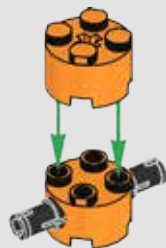



1x



1x

27



2x

28

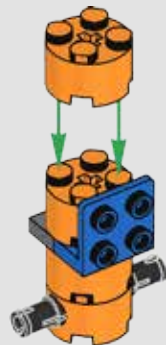



2x

29

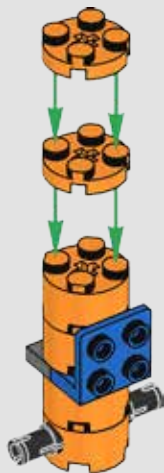

2x



1x

30

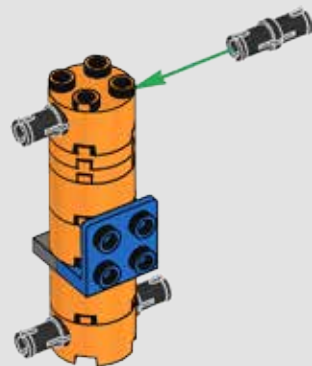



1x



1x

31



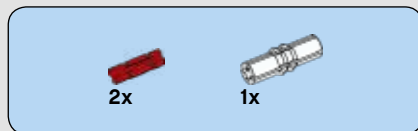

32

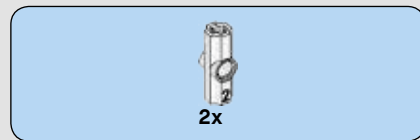
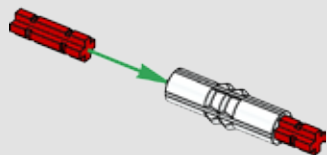

33

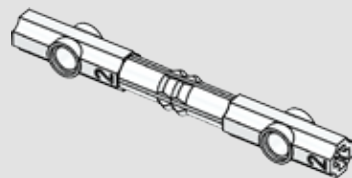



1x



1x

34

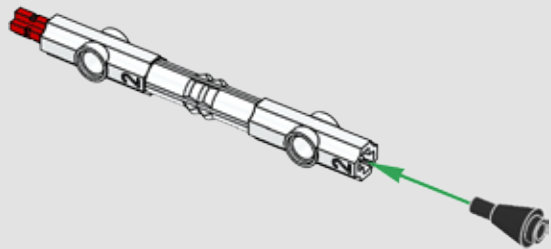

1x



1x

35

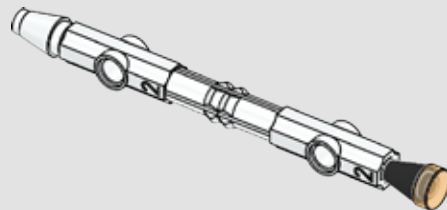

2x

36

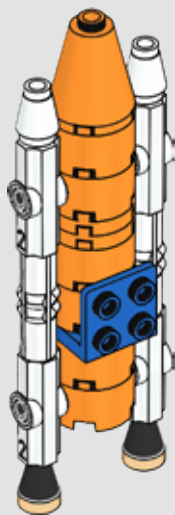

37

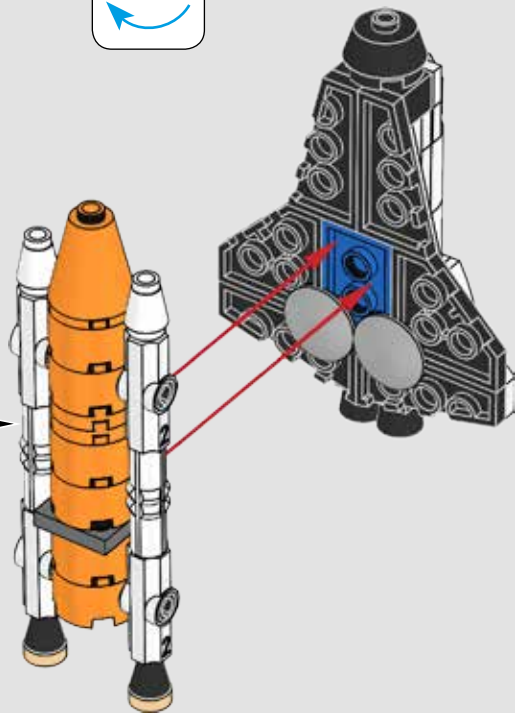
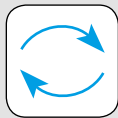

38

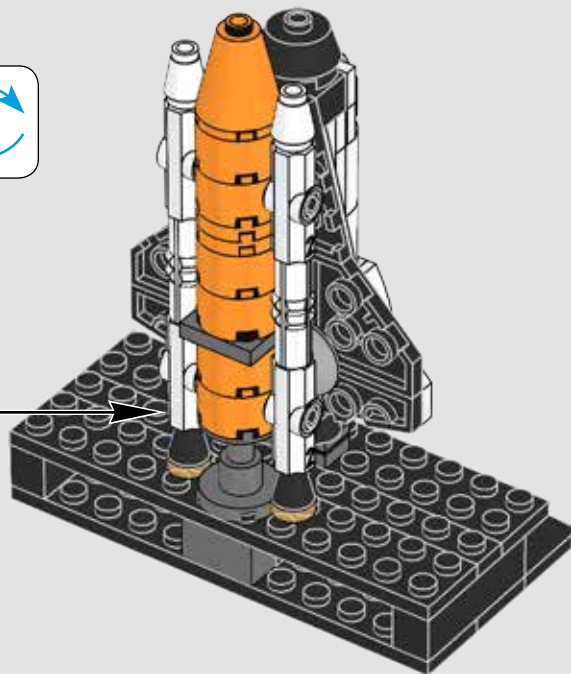
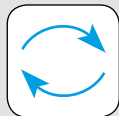

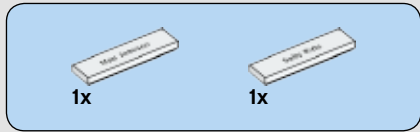

39

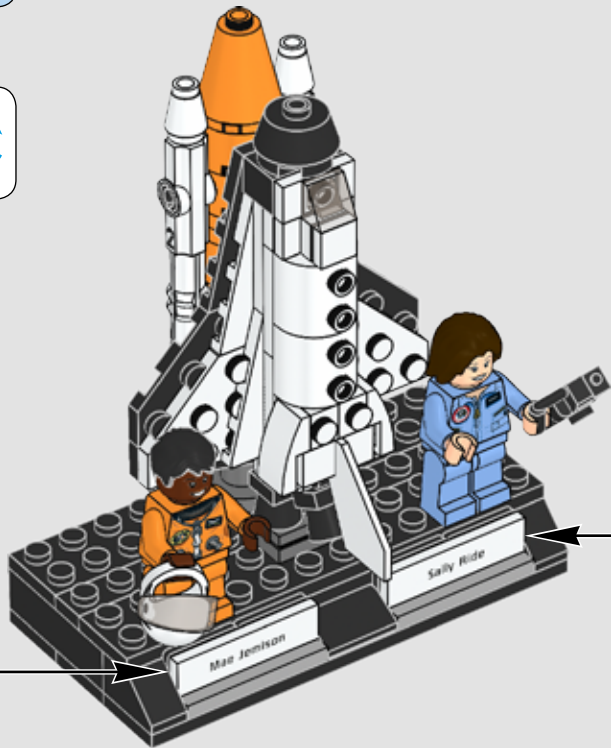
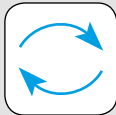

Sally Ride

Mae Jemison

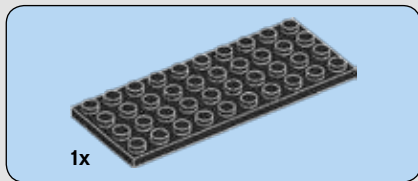

1

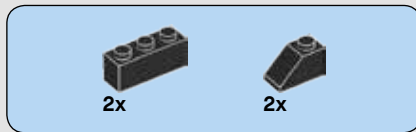
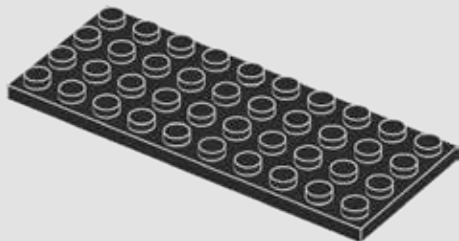

2

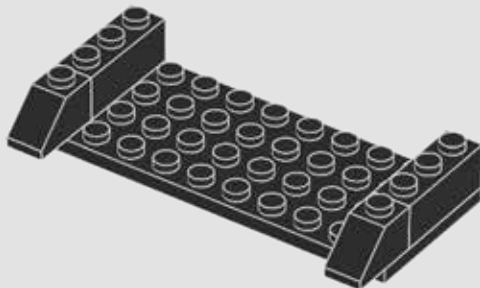

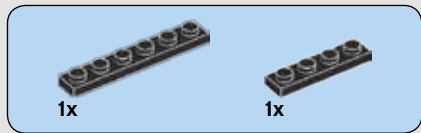

3

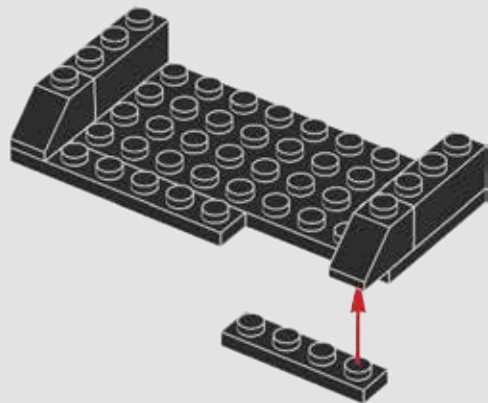

64

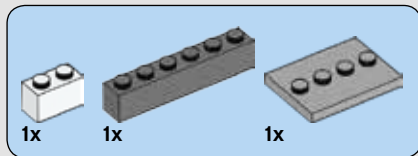

4

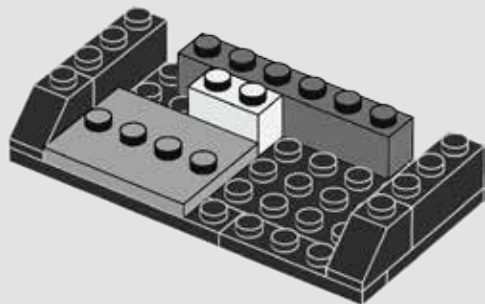

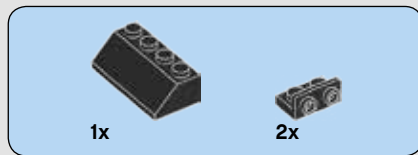

5

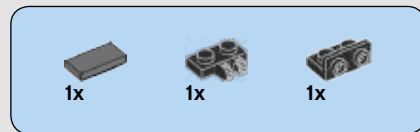
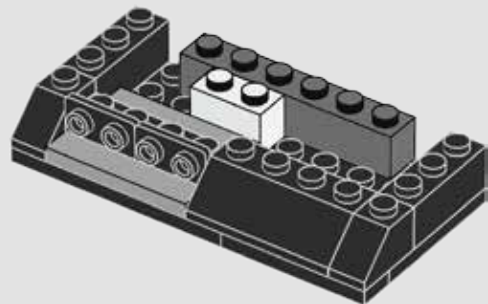

6

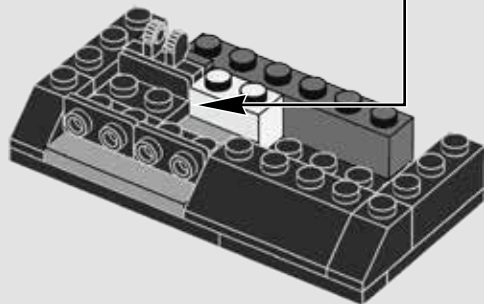
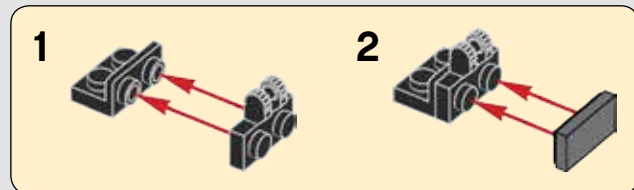



7

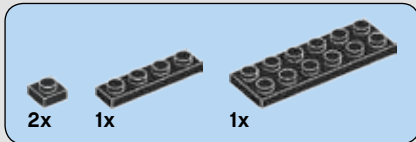
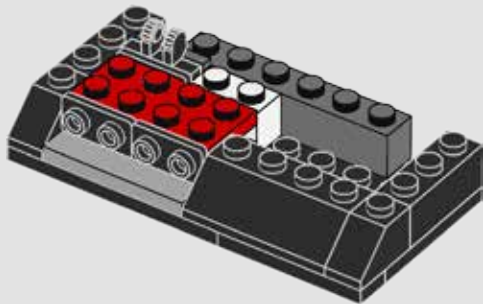

8

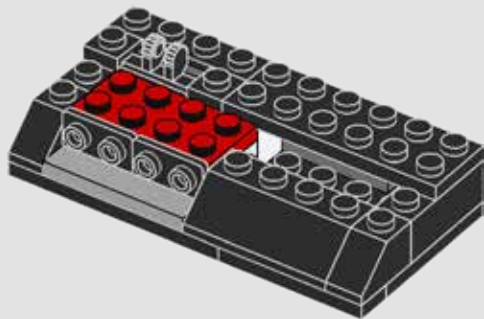

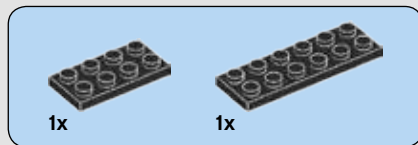

9

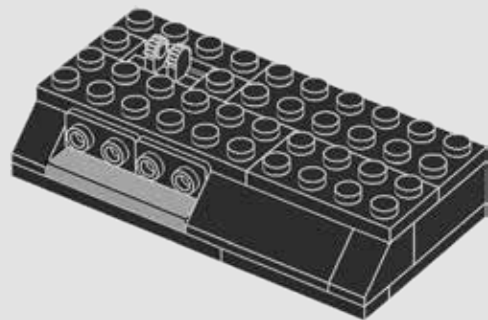

10

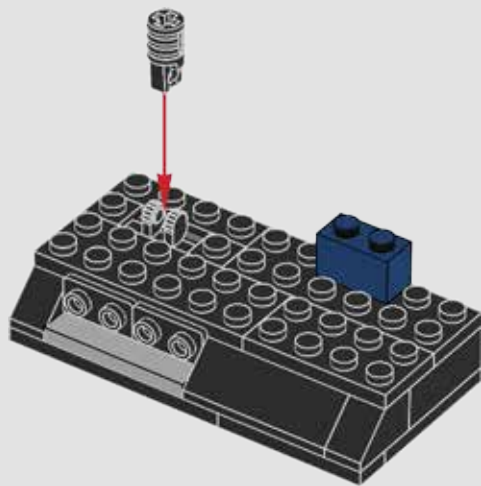

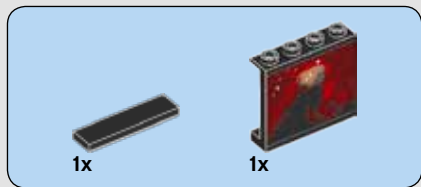

11

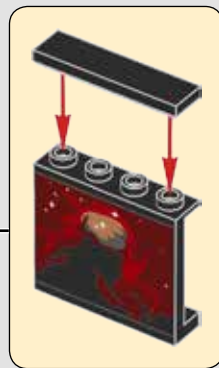
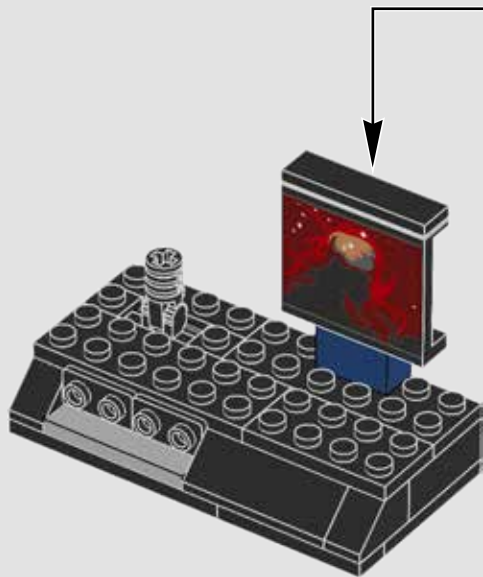



1x

12



4x

13

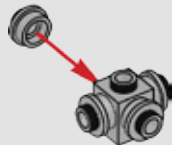



14



15

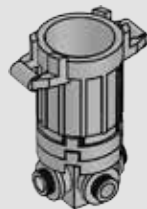

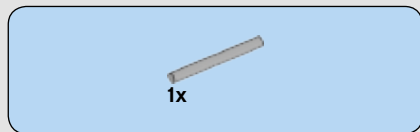

16

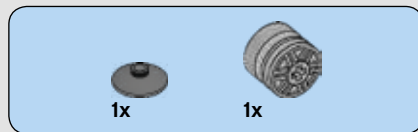
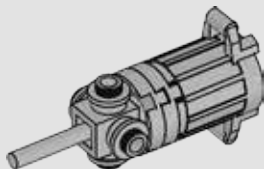
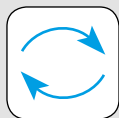

17

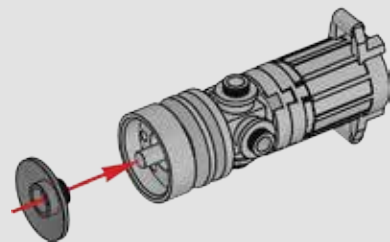



1x



1x



2x

18

1



2



3

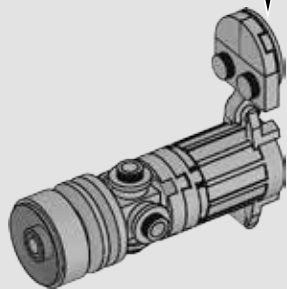

2x



1x

19

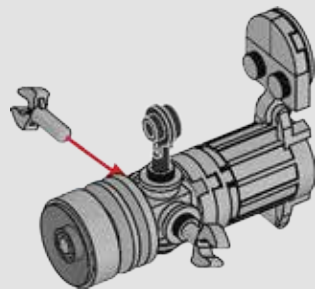



2x

20

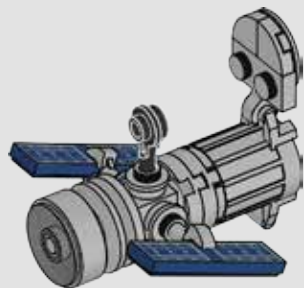

1x

21

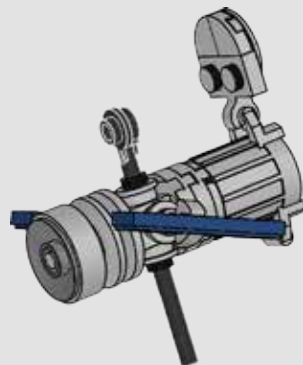

22

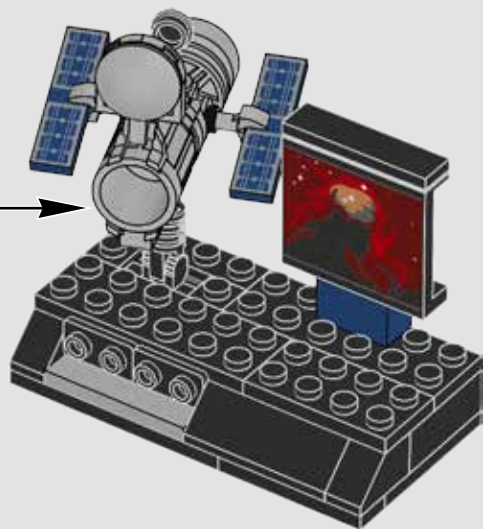









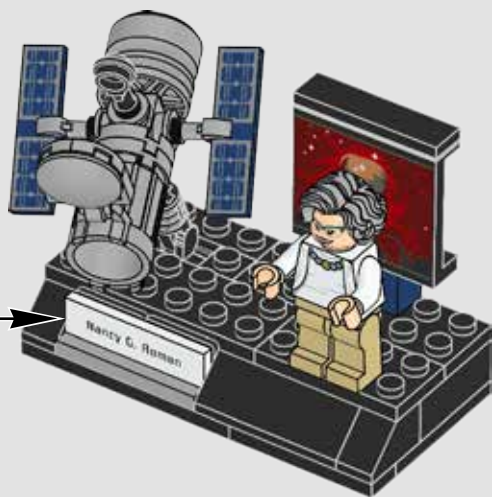































































1x

23

Nancy G. Roman



| | | | | | | | |
|--|--|--|--|--|--|--|--|
|  2x 4518400 |  2x 6051511 |  1x 6215334 |  1x 303201 |  1x 6133720 |  2x 4161332 |  1x 6178922 |  1x 243126 |
|  4x 4125554 |  2x 6034044 |  1x 6215336 |  2x 303401 |  5x 6126049 |  1x 6196548 |  6x 4121966 |  3x 371026 |
|  1x 302401 |  1x 4140583 |  1x 6215338 |  2x 303401 |  1x 306823 |  1x 4158848 |  9x 6020193 |  2x 301026 |
|  2x 407001 |  2x 4624989 |  1x 6215235 |  2x 4588003 |  1x 302123 |  2x 4160869 |  1x 6093525 |  2x 303726 |
|  1x 307001 |  6x 6126046 |  2x 245001 |  7x 4142865 |  2x 6056234 |  1x 4548180 |  2x 6133722 |  2x 4227684 |
|  1x 4298609 |  2x 6100932 |  3x 4560178 |  1x 302221 |  3x 6203937 |  1x 4653822 |  2x 4515368 |  4x 302026 |
|  2x 6174937 |  1x 4288960 |  2x 4561038 |  1x 302021 |  3x 6066102 |  4x 4121715 |  4x 362226 |  1x 300126 |
|  1x 300401 |  2x 362301 |  1x 416201 |  1x 4244368 |  4x 302426 |  1x 4106552 |  1x 6215342 |  1x 6218939 |
|  2x 302301 |  3x 302101 | |  1x 4163306 |  1x 4526110 |  1x 4515340 | | |



1x
4514845



2x
303026



4x
244526



3x
366626



3x
379526



1x
6215344



4x
4141089



1x
4120158



1x
6217992



2x
6030521



1x
6062601



2x
6120639



4x
6168647



2x
4542590



2x
6176433



1x
4211511



2x
4211475



3x
4278273



1x
6028812



1x
6194308



1x
6194414



1x
6116608



1x
4211396



3x
4211445



4x
6079461



1x
4490127



1x
4249891



2x
6215341



1x
4538252



1x
4211183



1x
6217940



1x
4252456



2x
4210719



1x
4211010



1x
6106283



2x
4211052



1x
4211088



5x
4211063



1x
4211094



3x
4211043



1x
4211100



1x
4211008



2x
4646865



1x
4107623



1x
6047056



1x
6217936



1x
6217941



1x
6162427



1x
6217991



1x
6217993



1x
6218740



1x
4568934



1x
6218268

Customer Service

Kundenservice

Service Consommateurs

Servicio Al Consumidor

LEGO.com/service or dial



: 00800 5346 5555

: 1-800-422-5346

SHARE YOUR IDEA
PARTAGE TON IDÉE
COMPARTE TU IDEA



LEGO® REVIEW
EXAMEN LEGO®
REVISIÓN DE LEGO®



GATHER SUPPORT
OBTIENS DE L'APPUJ
OBTÉN APOYOS



NEW LEGO® PRODUCT
NOUVEAU PRODUIT LEGO®
NUEVO PRODUCTO LEGO®



[LEGO.com/ideas](https://www.lego.com/ideas)

LEGO and the LEGO logo are trademarks of the/son des marques de commerce du/son marcas registradas de LEGO Group.
©2017 The LEGO Group. All rights reserved/Tous droits réservés/Todos los derechos reservados.

Do you like this LEGO® Ideas Set?

The LEGO® Group would like your opinion on the new product you have just purchased. Your feedback will help shape the future development of this product series.

Please visit:

[LEGO.com/productsurvey](https://www.lego.com/productsurvey)

By completing our short feedback survey, you will be automatically entered into a drawing to win a LEGO® prize.

See website for official rules and details. Open to all countries where not prohibited.

Aimez-vous cet ensemble LEGO® Ideas ?

Le Groupe LEGO® aimerait connaître votre opinion sur le produit que vous venez d'acheter. Vos commentaires nous aideront à concevoir les futurs produits de cette gamme.

Veuillez visiter :

[LEGO.fr/productsurvey](https://www.lego.fr/productsurvey)

En remplissant ce court sondage sur le produit, vous serez automatiquement inscrit à un tirage au sort pour gagner un prix LEGO®. Consultez le site Web pour obtenir le règlement officiel et les détails. Ouvert à tous les résidents des pays autorisés.



¿Te gusta este set LEGO® Ideas?

The LEGO® Group quiere conocer tu opinión acerca del nuevo producto que acabas de comprar. Tus comentarios nos ayudarán a dar forma a los futuros productos de esta serie.

Visita:

[LEGO.com/productsurvey](https://www.lego.com/productsurvey)

Al contestar este breve cuestionario de opinión, participarás automáticamente en el sorteo de un producto LEGO®. Consulta las reglas oficiales y demás información en el sitio web. Válido en todos los países en los que esta actividad no esté prohibida.