



MINECRAFT

21257



Q LEGO® Builder



Get excited about our new packaging!

We're switching from plastic to paper-based packaging. That's why you might find a mix of paper and plastic in our boxes!

Nos nouveaux emballages vous emballeront !

Nous passons des emballages en plastique aux emballages à base de papier. C'est pourquoi vous pourriez trouver un mélange de papier et de plastique dans nos boîtes !

¡Te presentamos nuestros nuevos empaques!

Estamos sustituyendo las bolsas de plástico por bolsas con base de papel. ¡Por eso, puedes encontrar una mezcla de papel y de plástico en nuestras cajas!

[LEGO.com/sustainable-packaging](https://www.lego.com/sustainable-packaging)

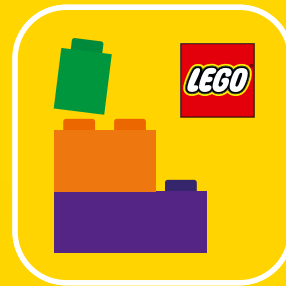

BUILDER



Apple and the Apple logo are trademarks of Apple Inc., registered in the U.S. and other countries and regions. App Store is a service mark of Apple Inc. Google Play and the Google Play logo are trademarks of Google LLC. Tencent and the Tencent logo are trademarks of Tencent Inc.

LEGO.com/devicecheck

EN Ask parents' permission before going online | DE Eltern um Erlaubnis bitten, bevor du online gehst | FR Demande l'autorisation d'un parent avant d'aller en ligne | IT Chiedi il permesso ai tuoi genitori prima di andare online | ES Pídeles permiso a tus papás antes de conectarte a Internet | PT Pede autorização aos pais antes de acederes online | ZH 上网前应先征得父母的同意 | PL Poproś rodziców o zgodę, zanim wejdiesz do Internetu | CS Než půjdeš na internet, požádej rodiče o svolení | SK Skôr než pôjdeš na internet, vypýtaj si povolenie od rodičov | HU Kérj szülői engedélyt, mielőtt online csatlakoznál! | RO Cere permisiunea părinților înainte de a te conecta online | BG Поискайте разрешение от родител, преди да влезете онлайн | LV Pirms došanās tiešsaistē palūdz atļauju vecākiem | ET Enne Interneti kasutamist küsi vanematelt luba | LT Prieš prisijungdami prie interneto, atsilkauskite tėvų

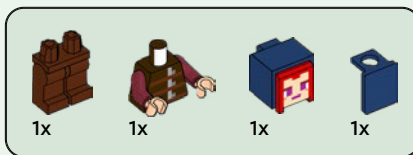

1

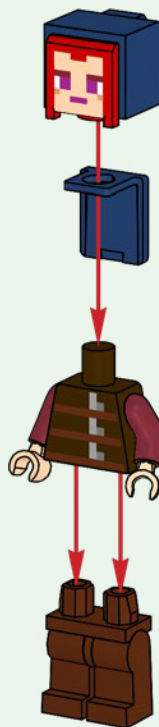

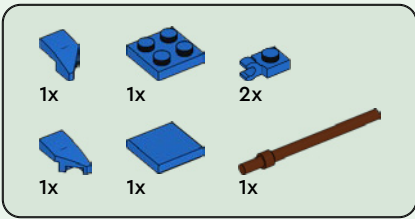

2

1



2



3



4



5

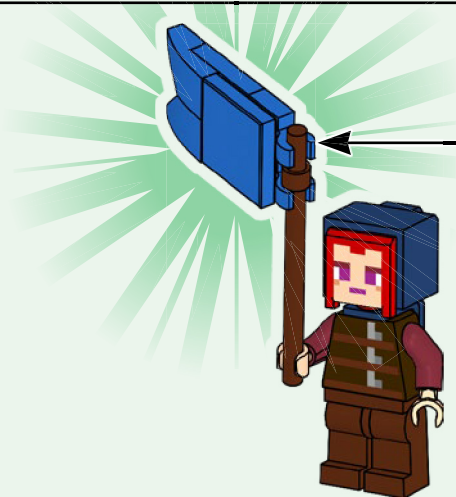
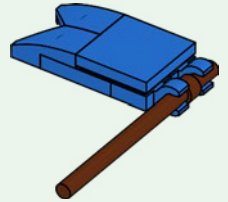

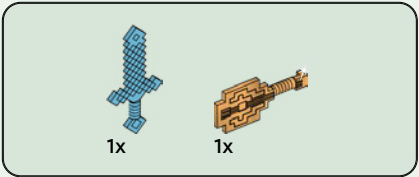

3

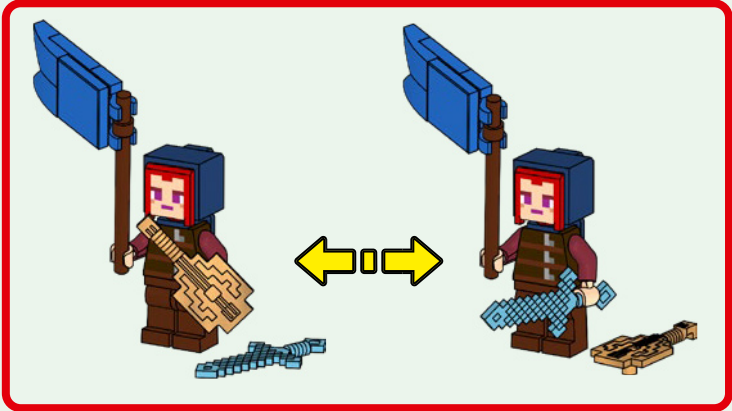

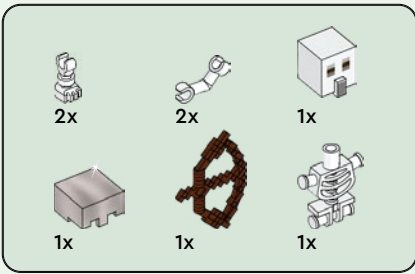

1



2



3

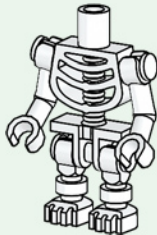

4

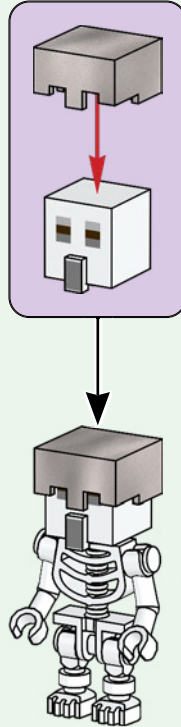

5

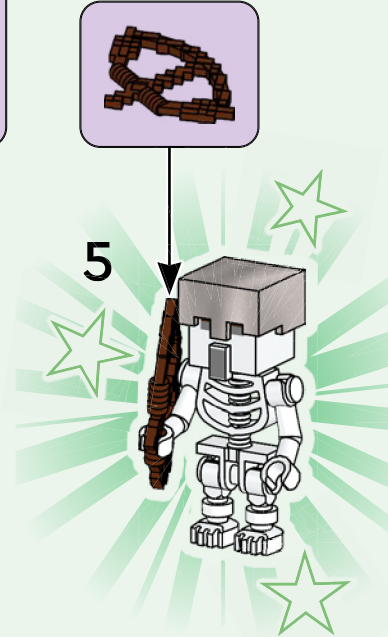

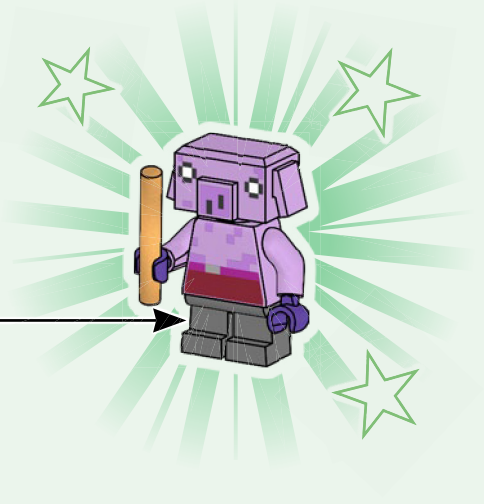
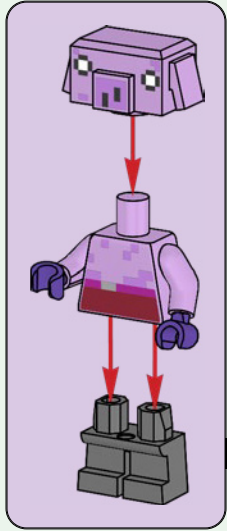
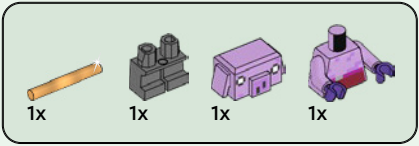

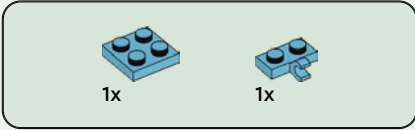
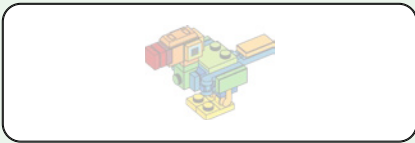

1

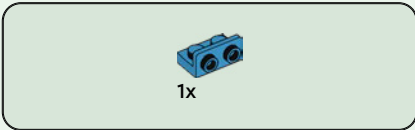
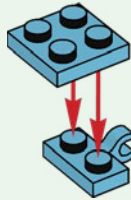

2

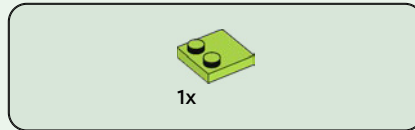

3



4



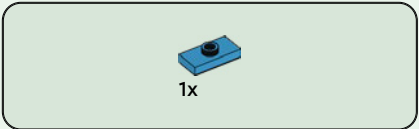

5

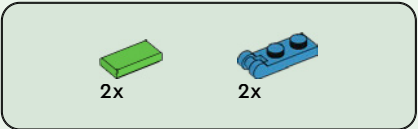
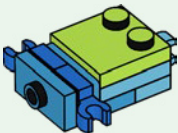

6

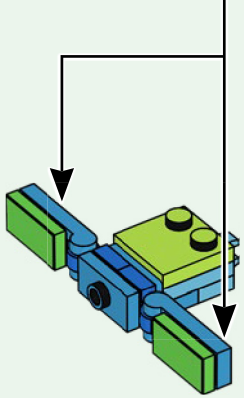
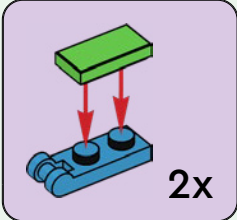

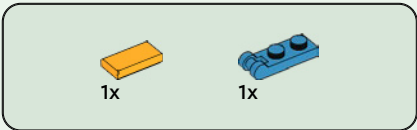

7

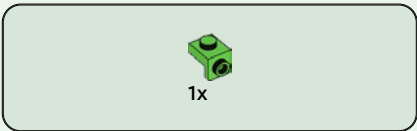
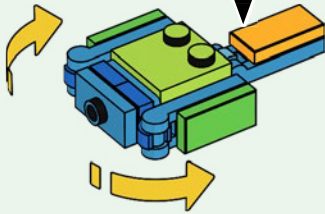
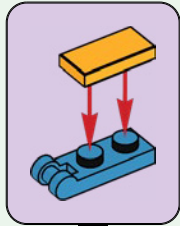

8

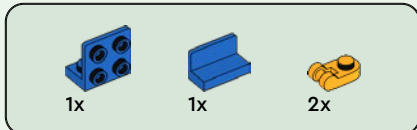
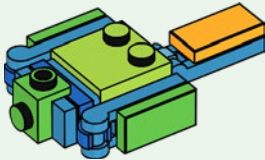

9

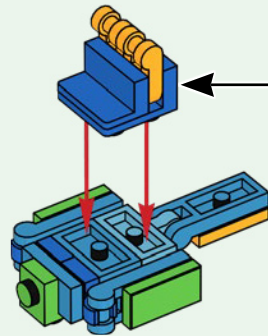
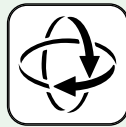
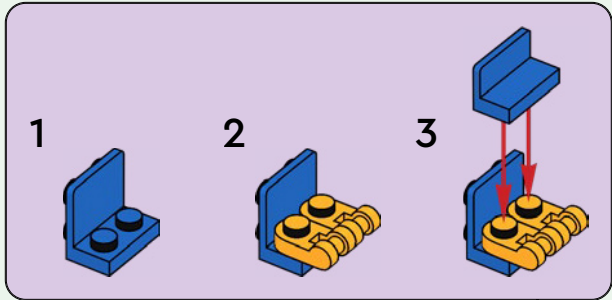



2x

10

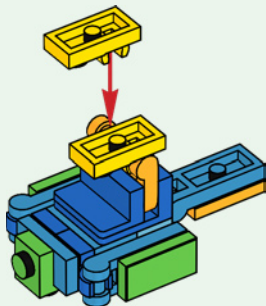

1x



1x

11

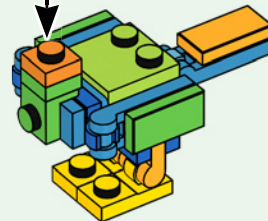
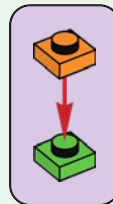



12

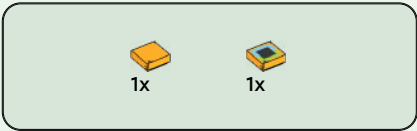

13

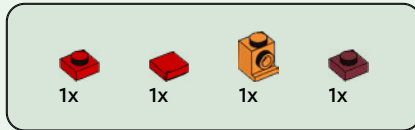

14

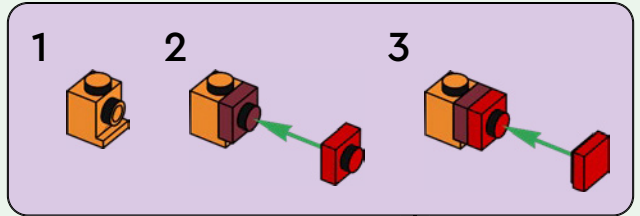



1x

15



1x

16



17

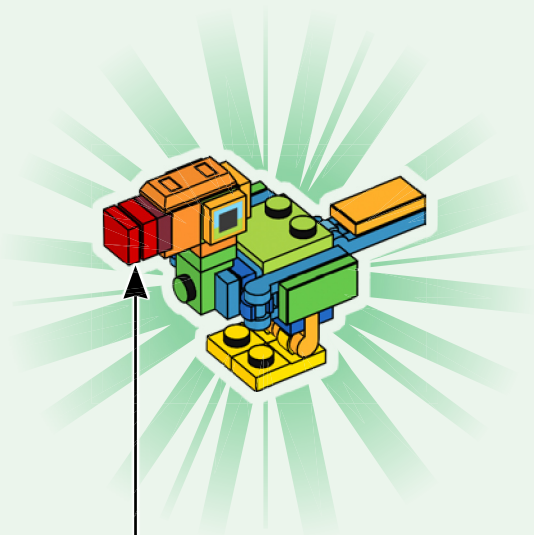

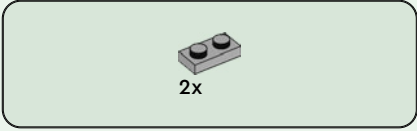
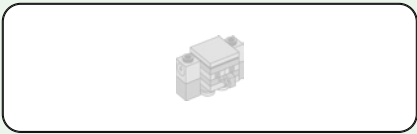

1

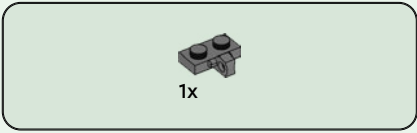
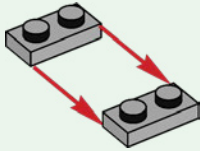

2

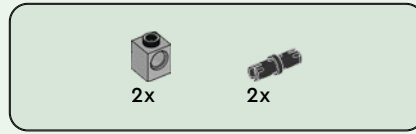
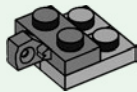

3

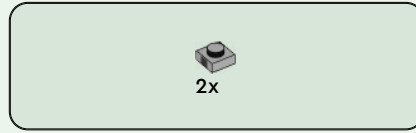
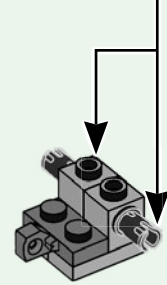
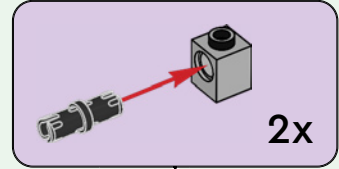

4



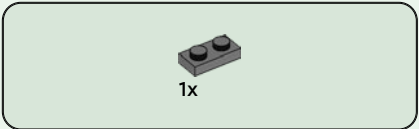

5

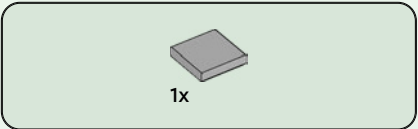

6



7



2x

8



2x

2x

9

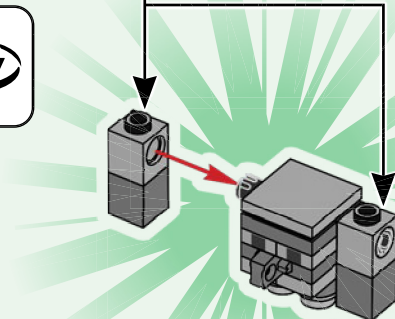
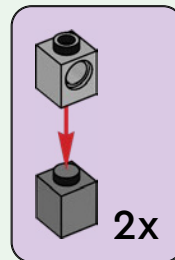

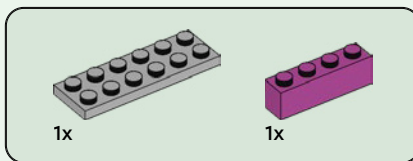
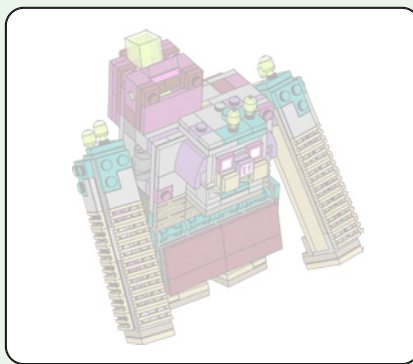

1

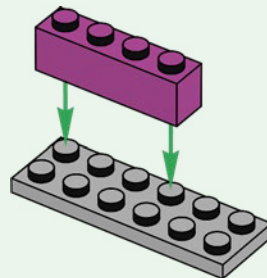

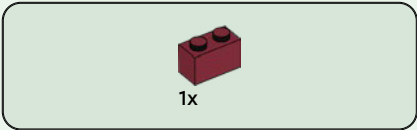

2

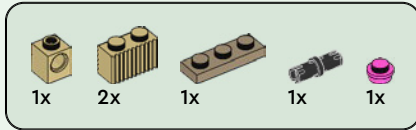
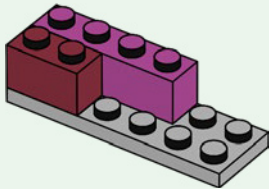

3

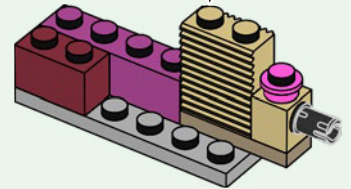
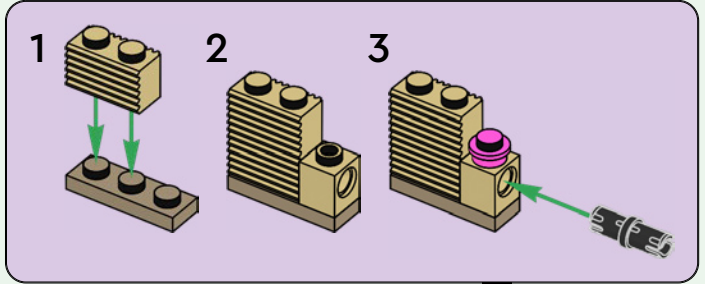

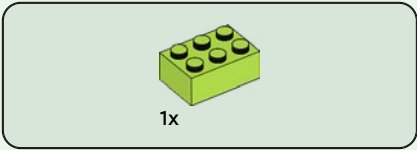

4

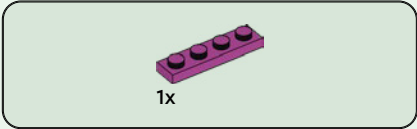
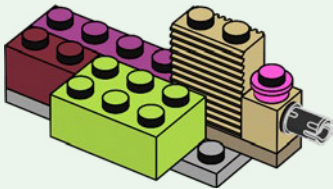

5

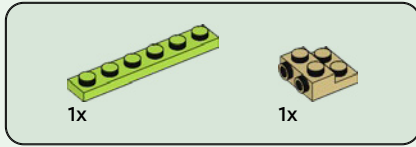
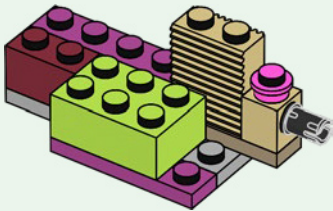

6

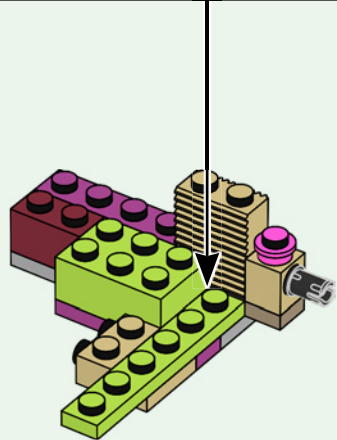
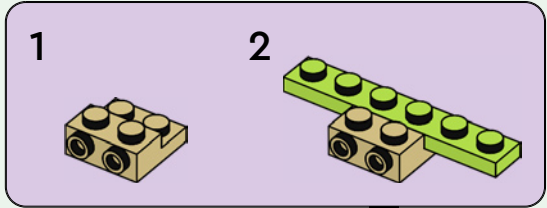

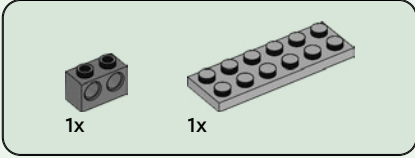
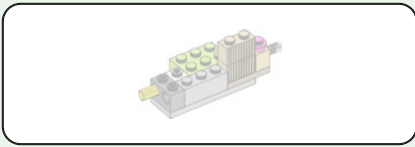

7

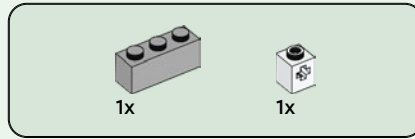
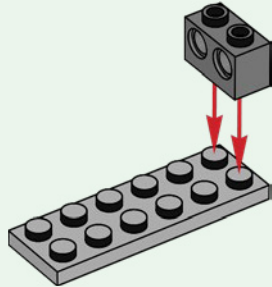

8

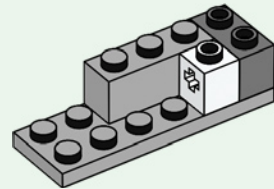

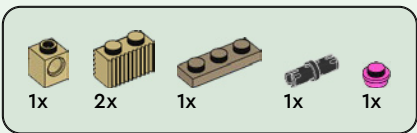

9

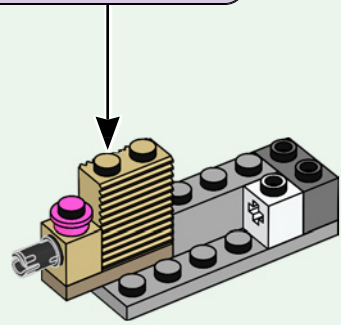
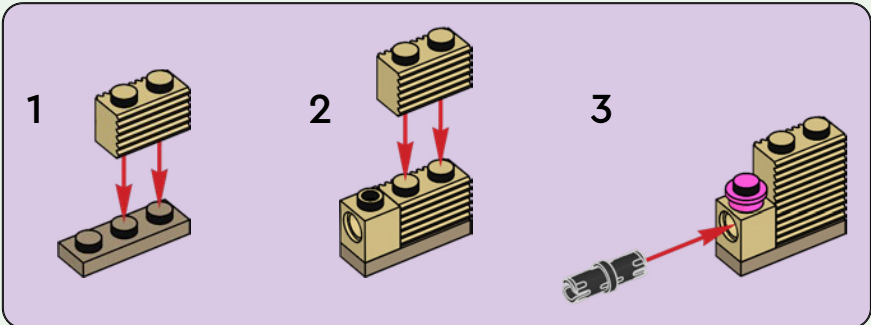

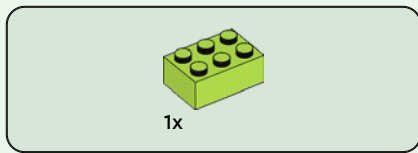

10

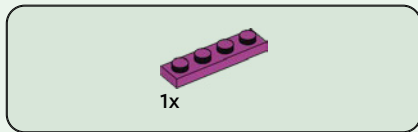
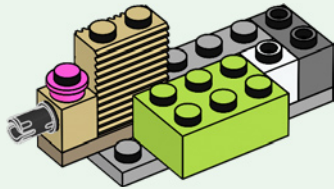

11

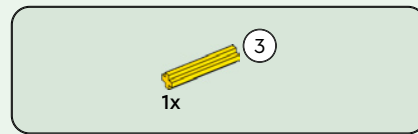
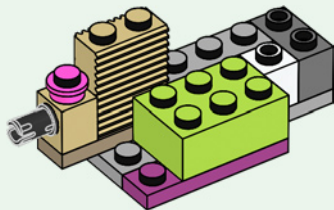

12

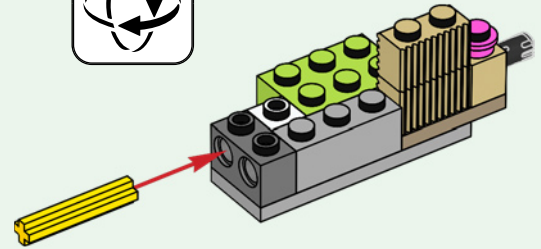
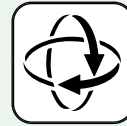

13

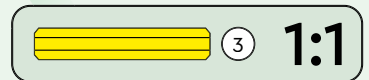
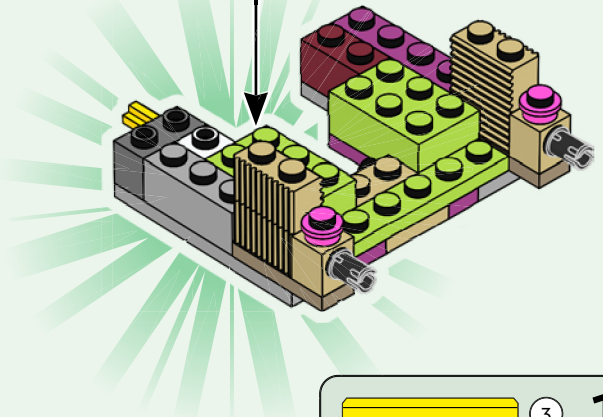

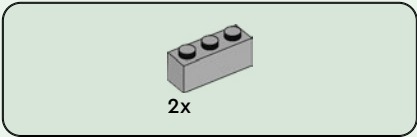

14

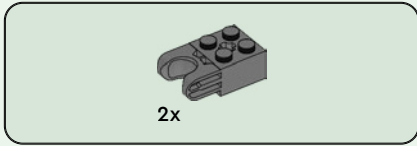
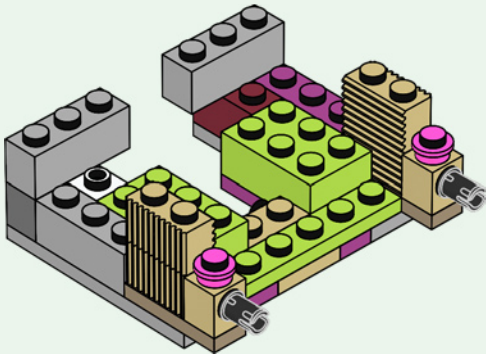

15

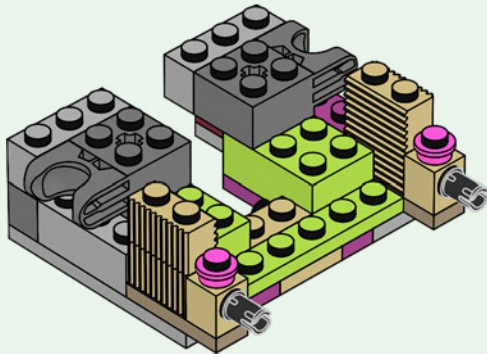



2x



2x

16

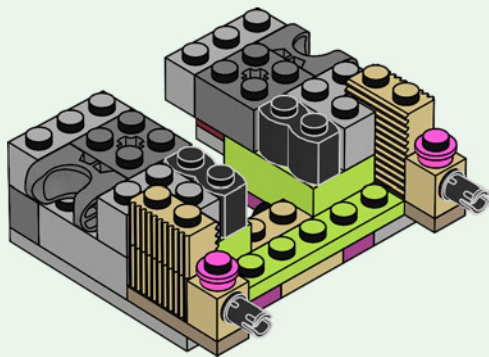

2x



2x

17

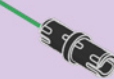
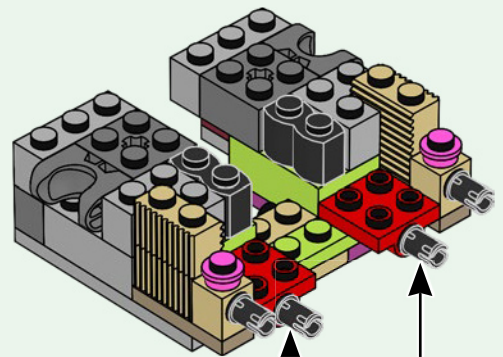

2x

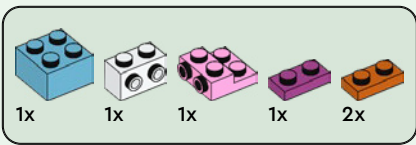

18

1

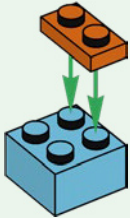

2

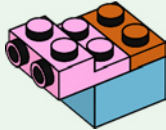

3

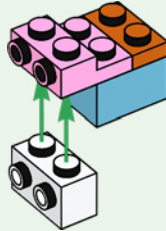

4

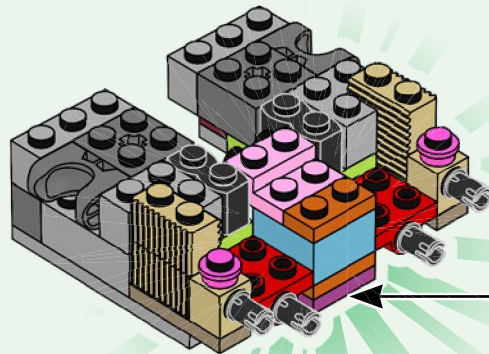
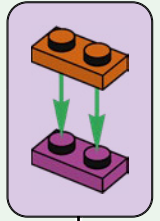
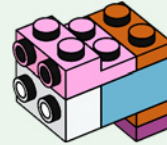

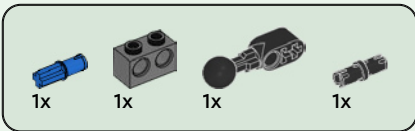

19

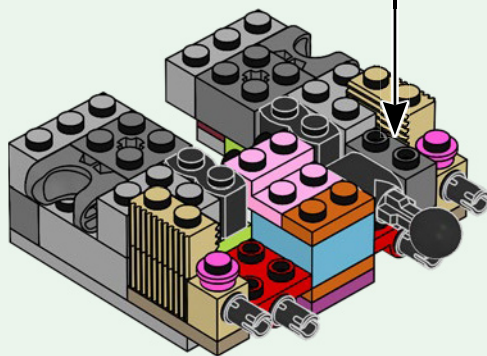
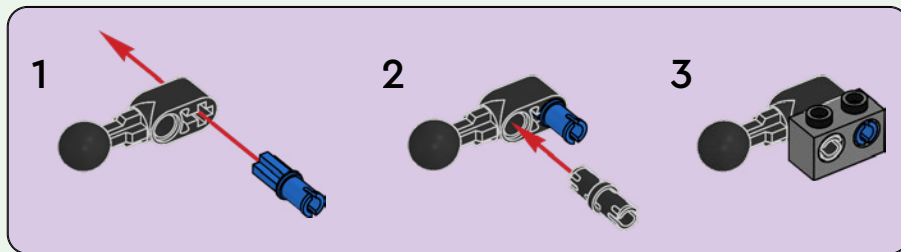

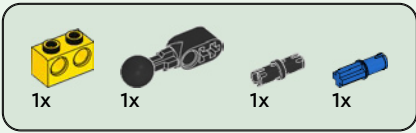

20

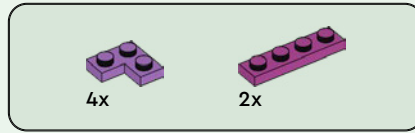
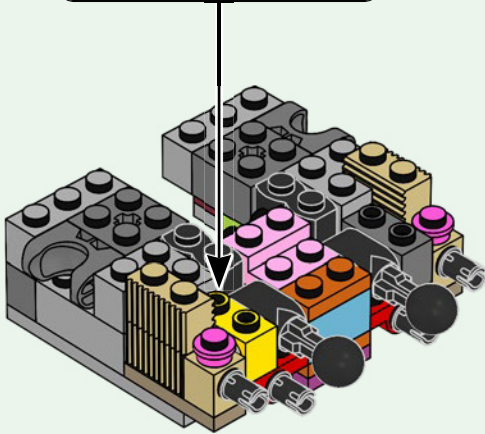
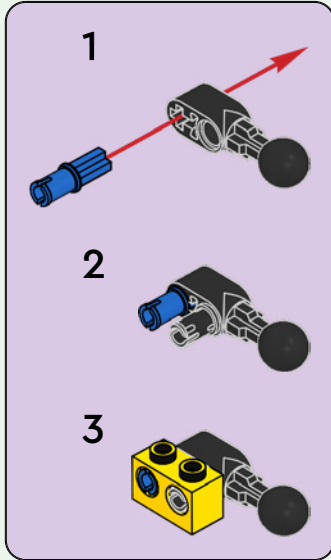

21

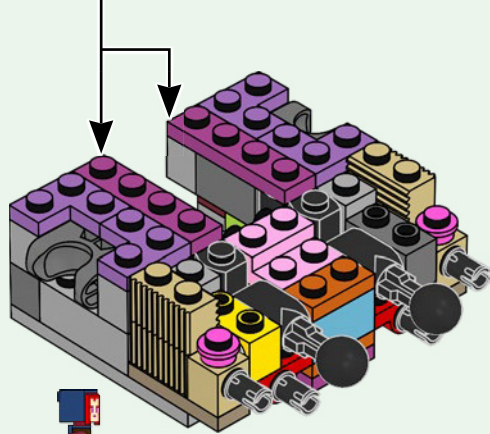
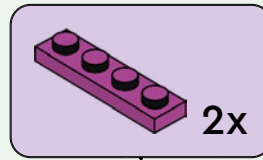

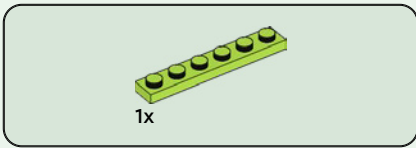

22

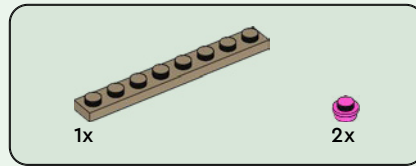
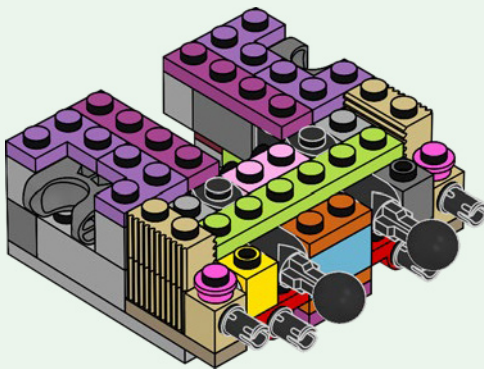

23

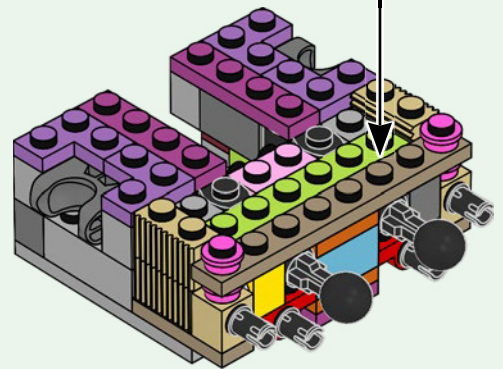
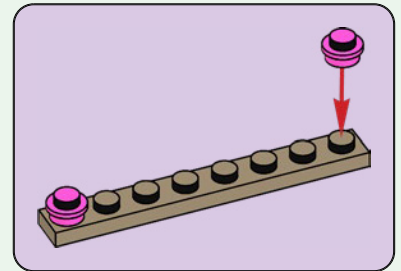



2x

24

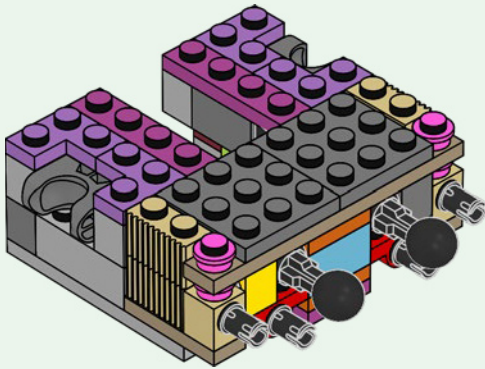

2x

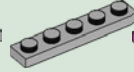

2x



2x



1x

25

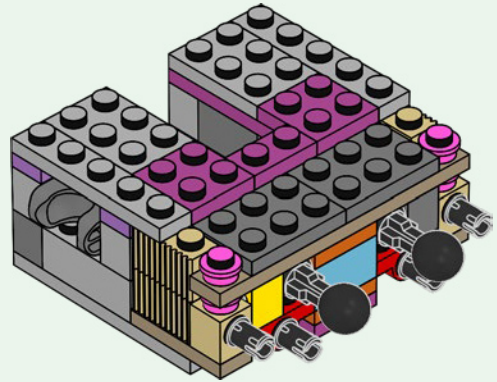



8x

26

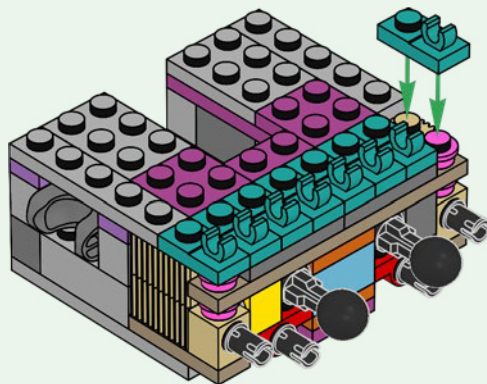

2x



2x



2x



2x

27

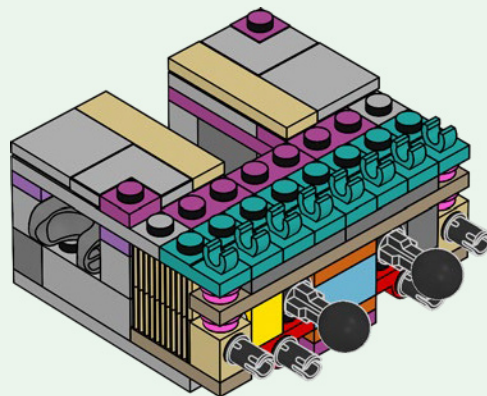



8x

28

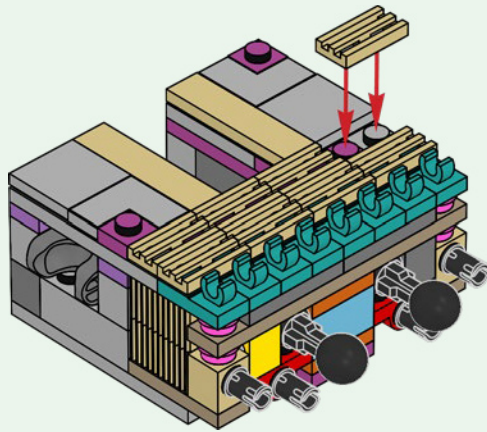

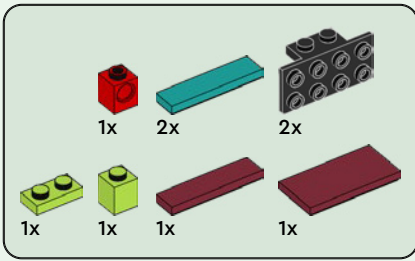

29

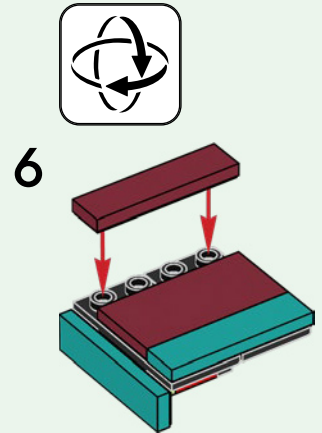
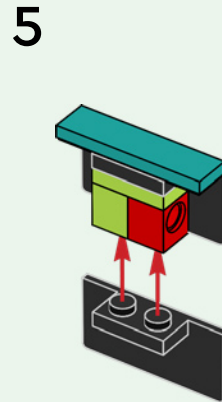
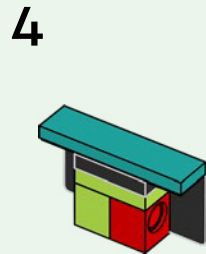
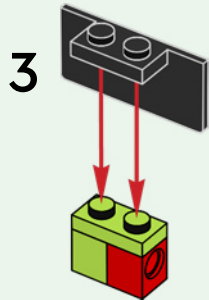
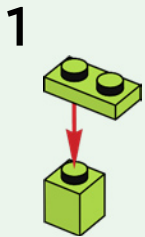

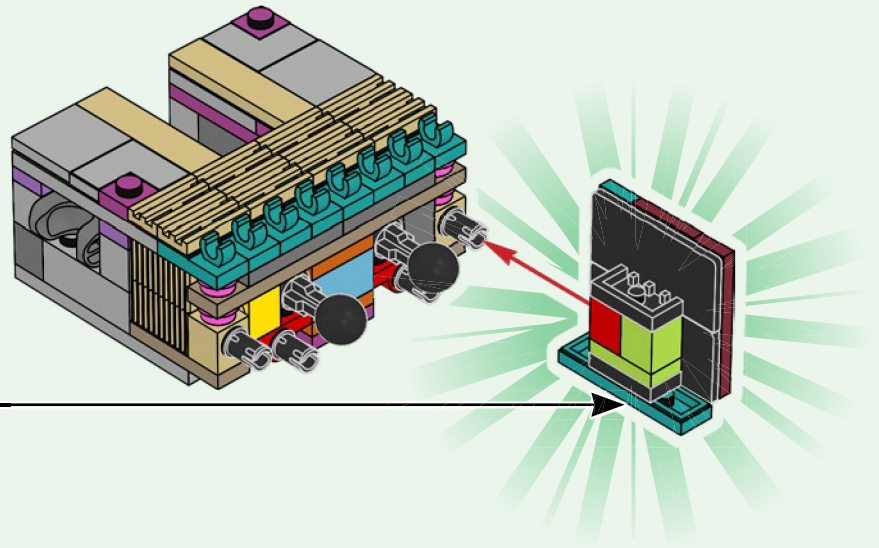

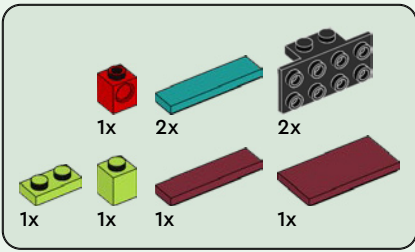

30

1

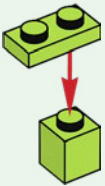

2



3

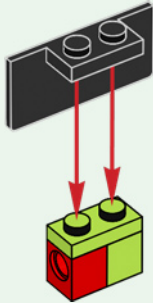

4



5

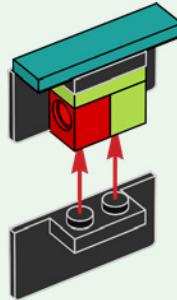

6

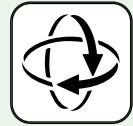
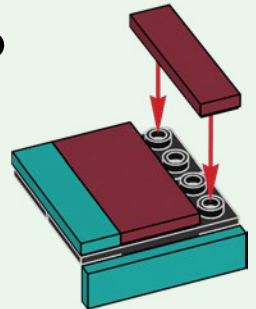

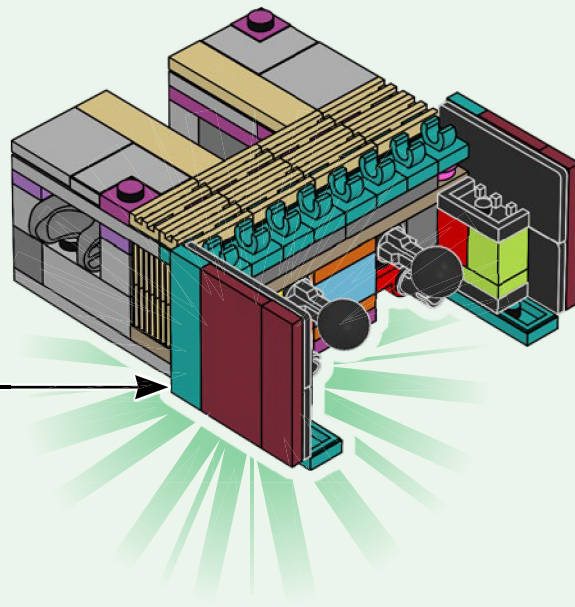

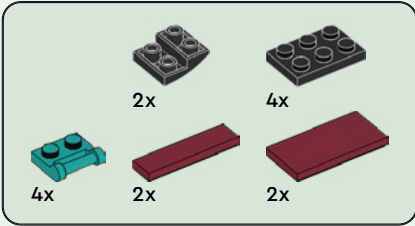

31

1

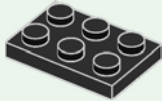

2

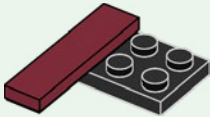

3



4



5

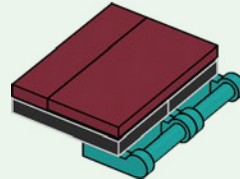

6

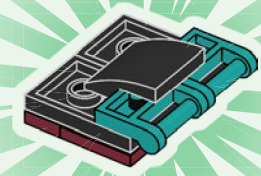
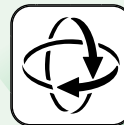

2x

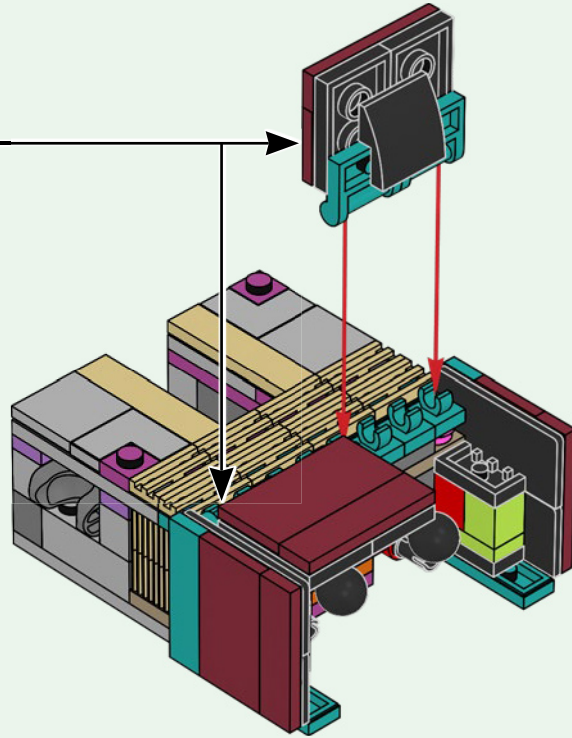

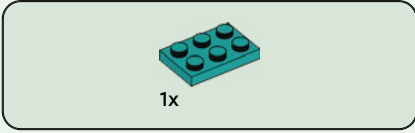

32

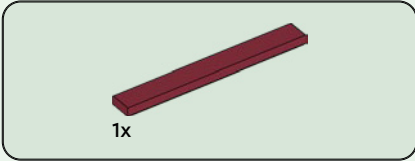
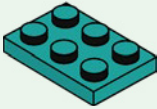

33

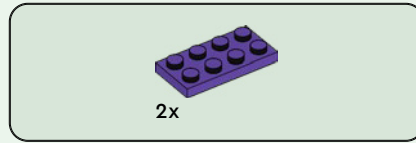
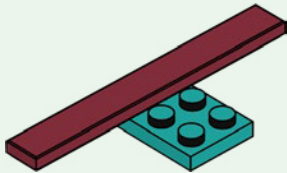

34

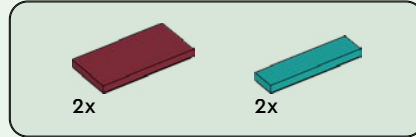
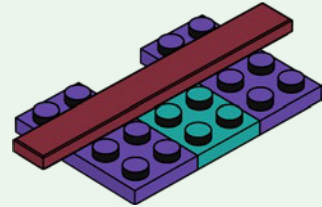

35

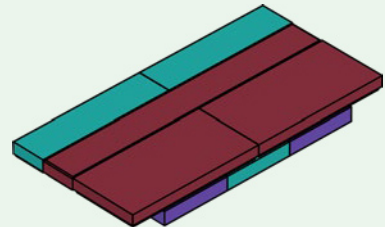

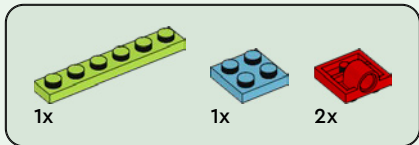

36

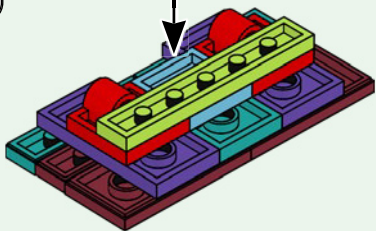
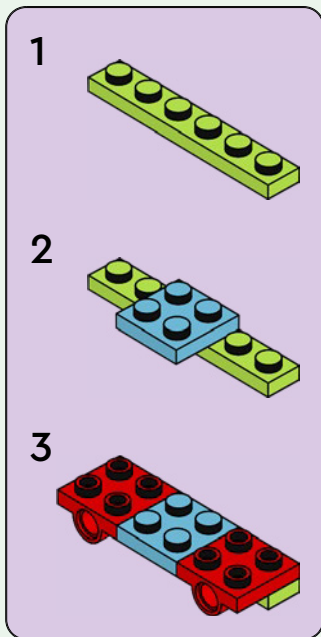

37

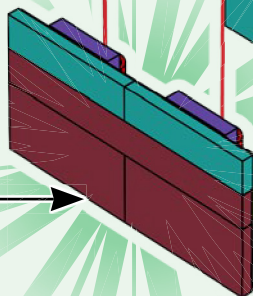
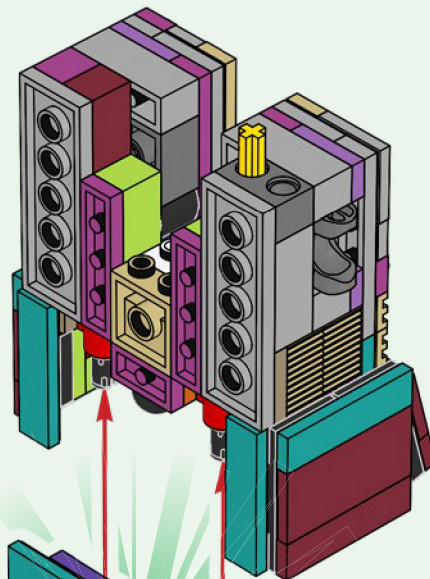

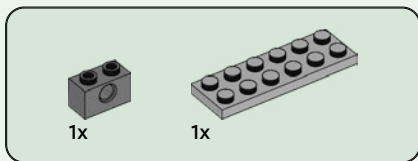
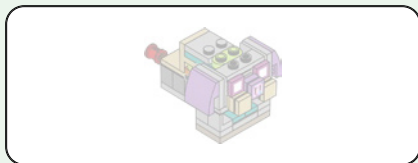

38

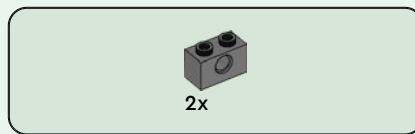
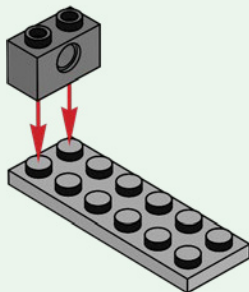

39

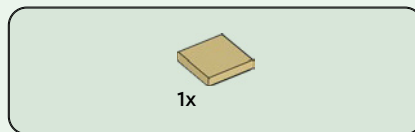
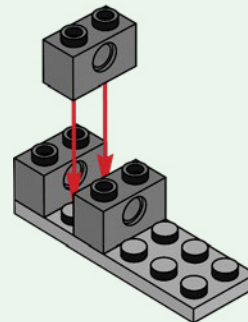

40

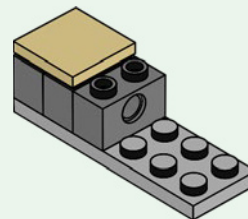

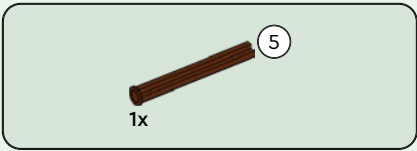

41

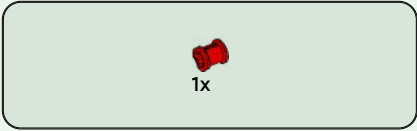
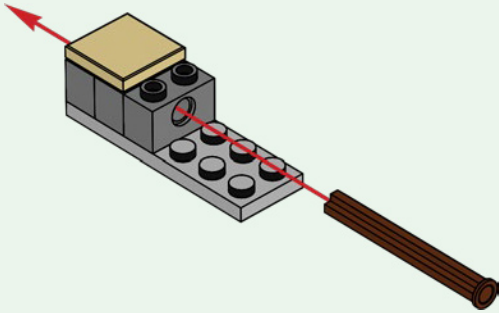

42

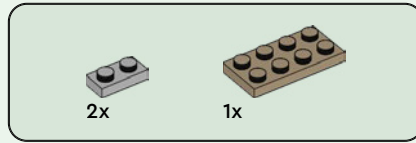
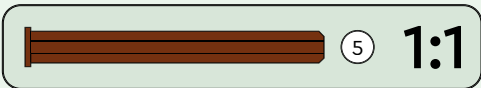
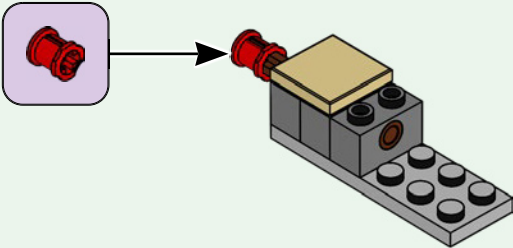

43

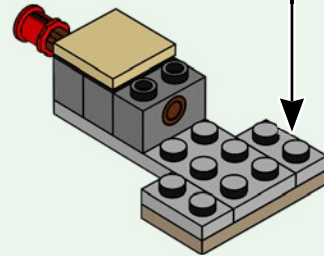
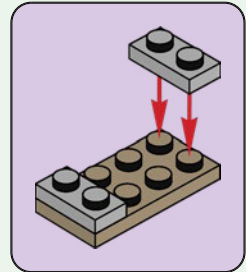

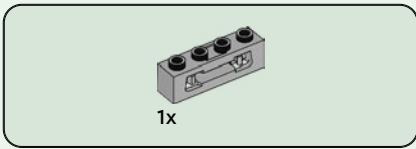

44

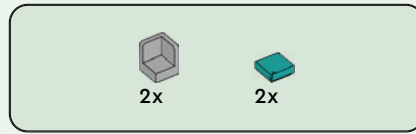
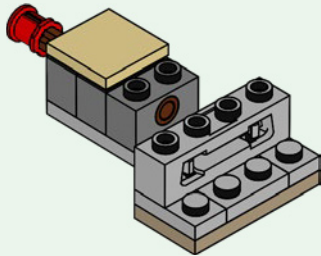

45

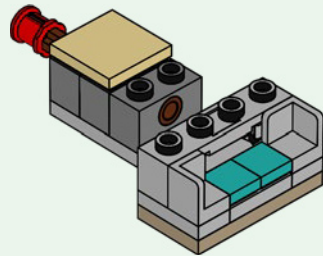

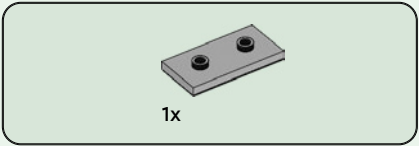

46

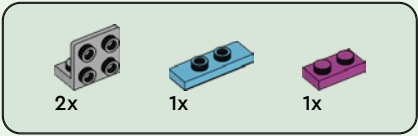
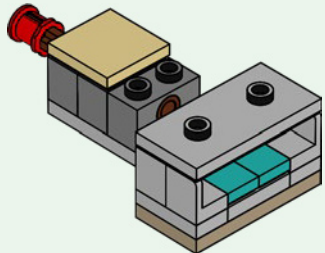

47

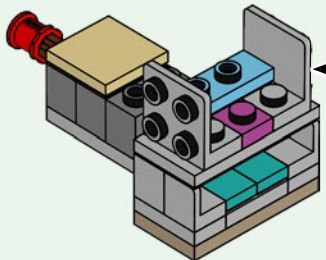
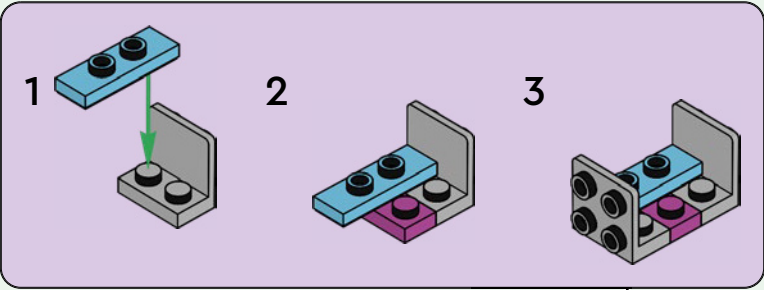

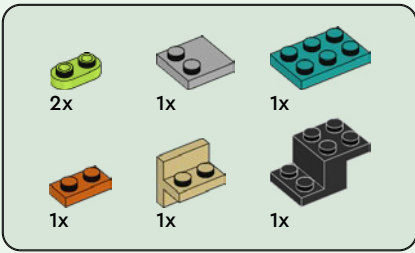

48

1

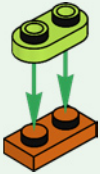

2



3

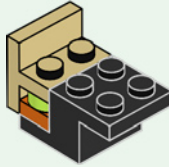

4



5

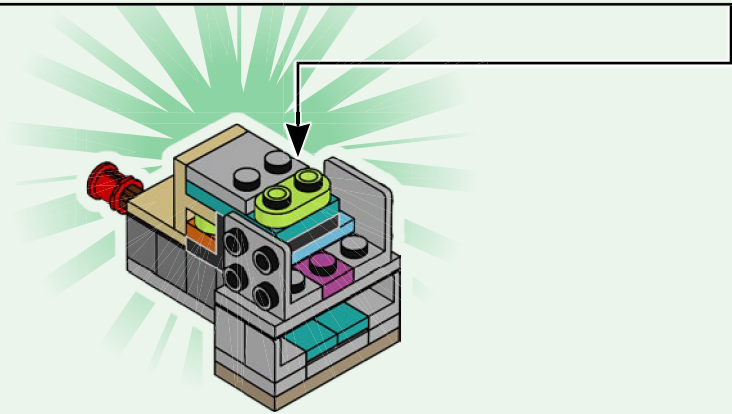
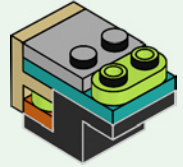



1x



2x

49

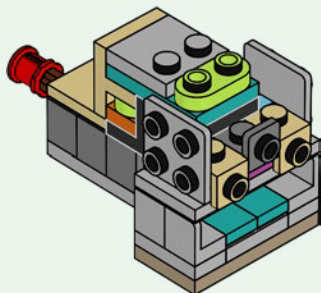

1x



2x

50

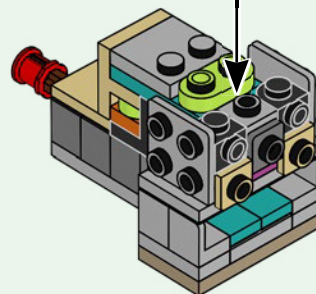
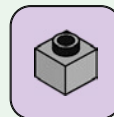

1x

51

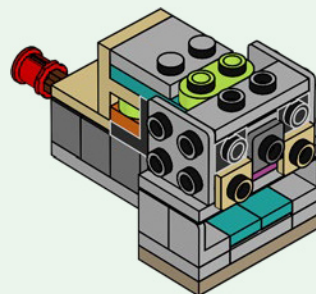



52

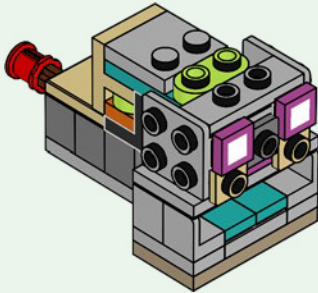

53

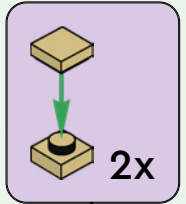
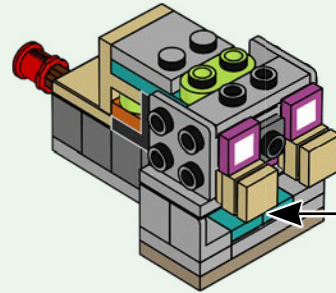

54

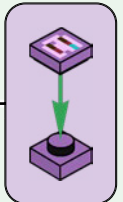
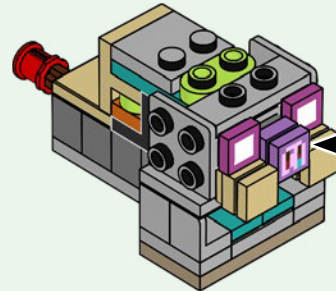



2x

55

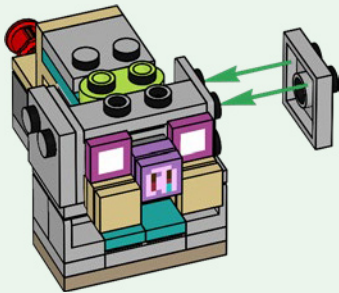

2x



2x

56

1

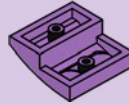

2



2x

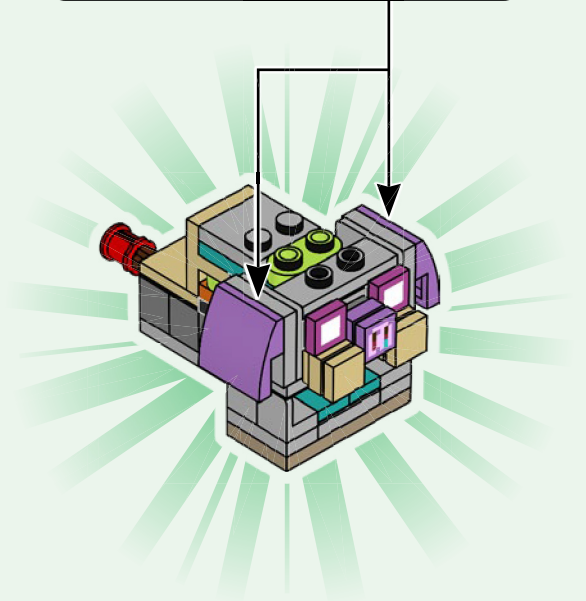

57

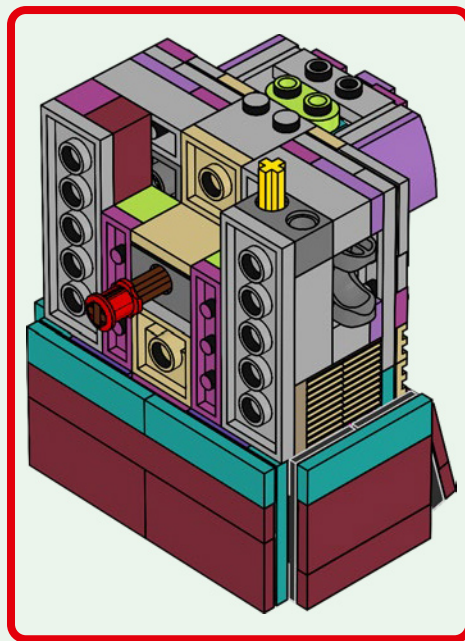
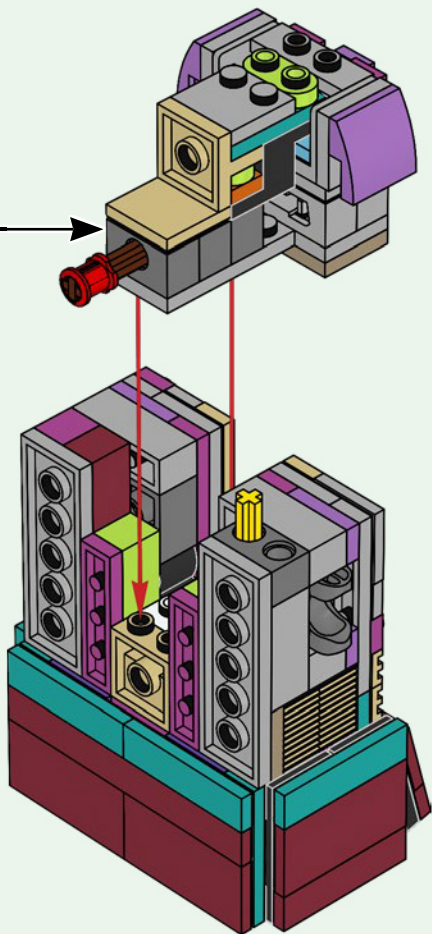

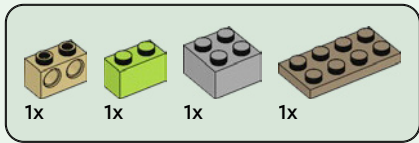

58

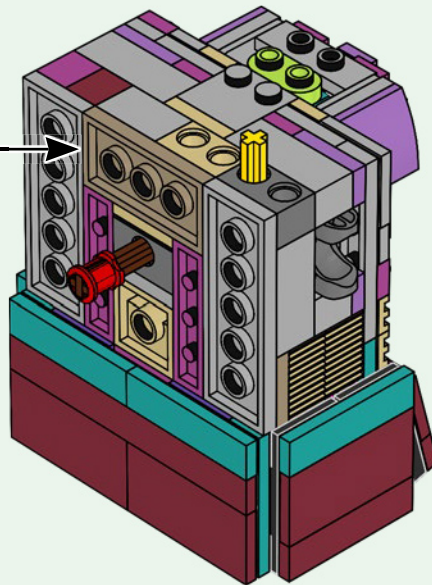
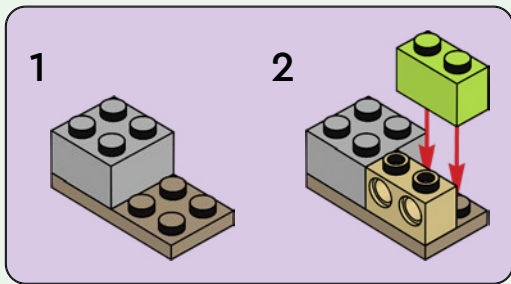

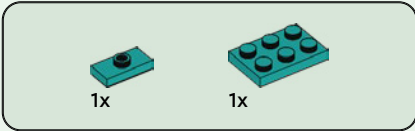
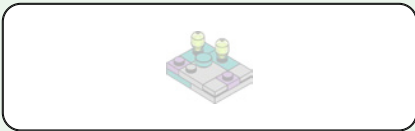

59

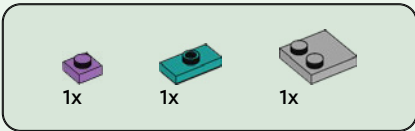
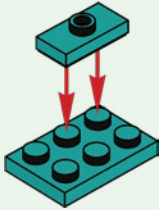

60

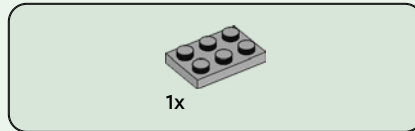
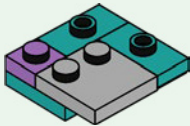

61

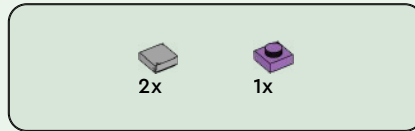
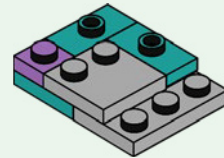

62

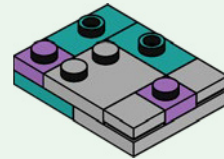



2x



1x

63

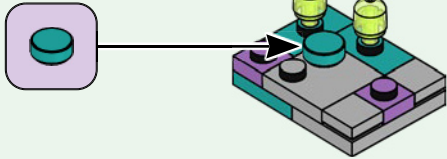

64

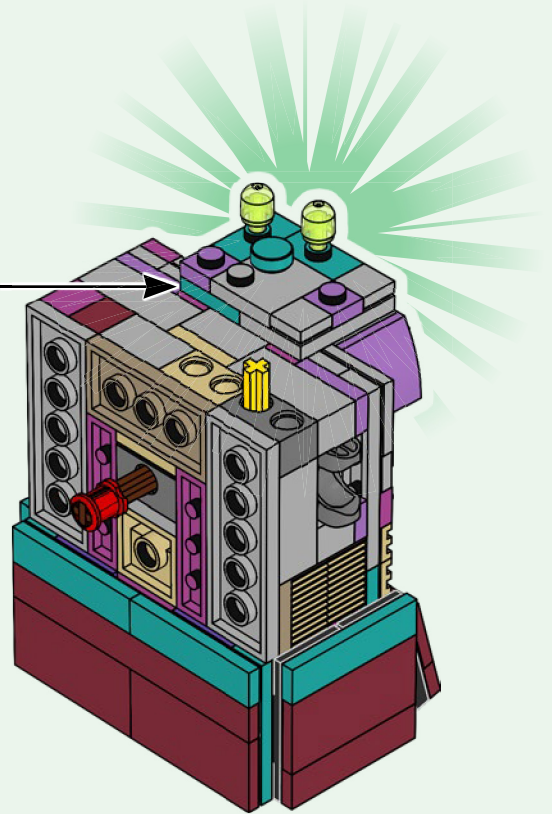

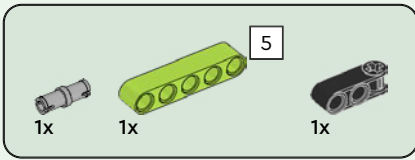

65

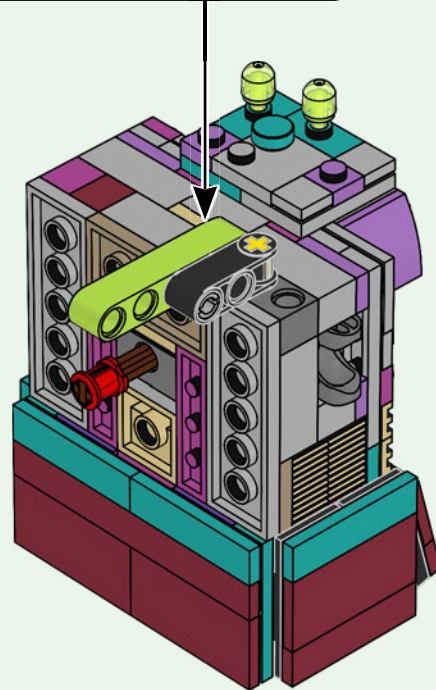
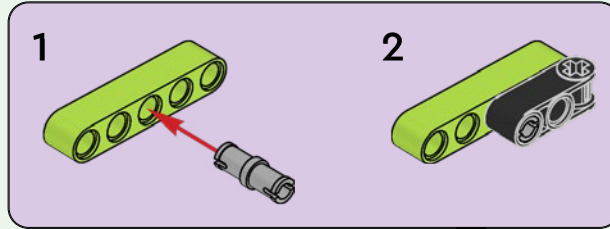
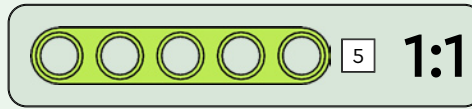

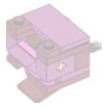

1x

66

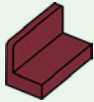

2x

67



1x

68

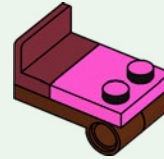

1x

69

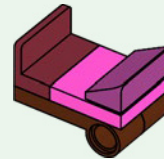

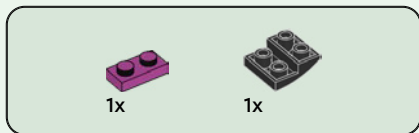

70

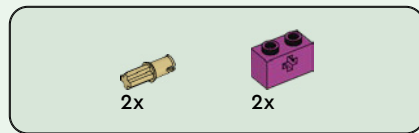
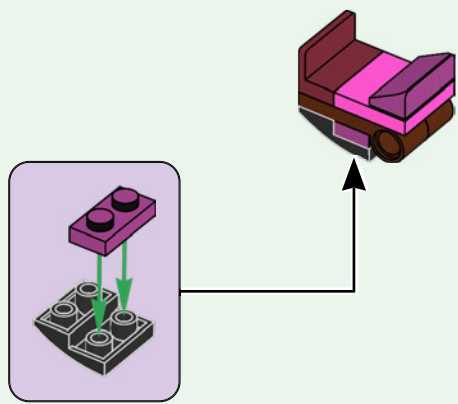

71

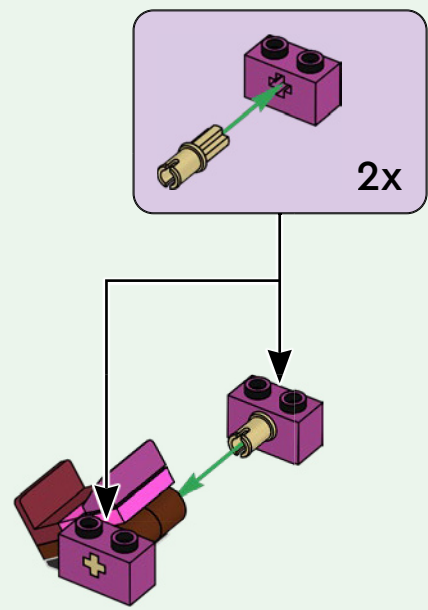

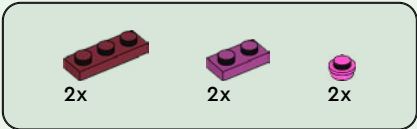

72

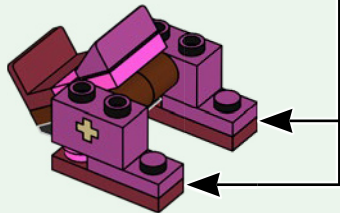
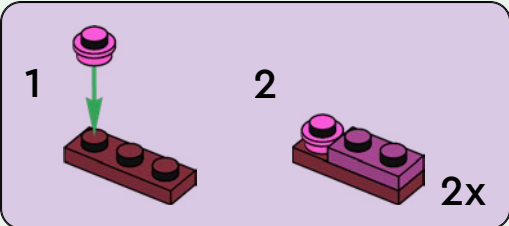

73

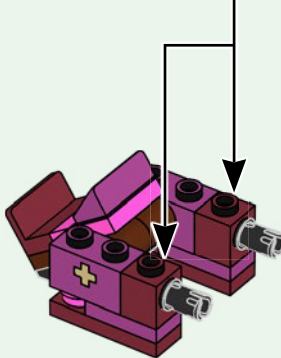
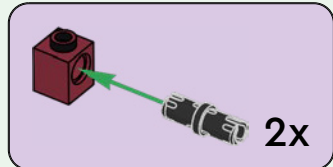

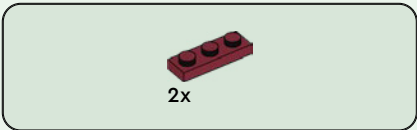

74

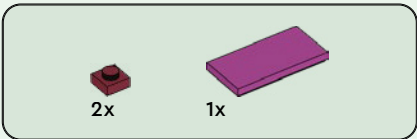
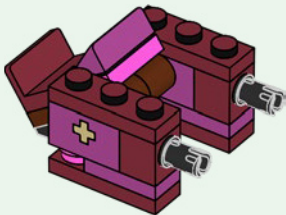

75

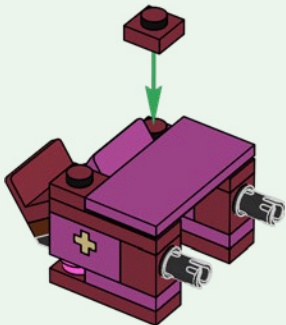

76

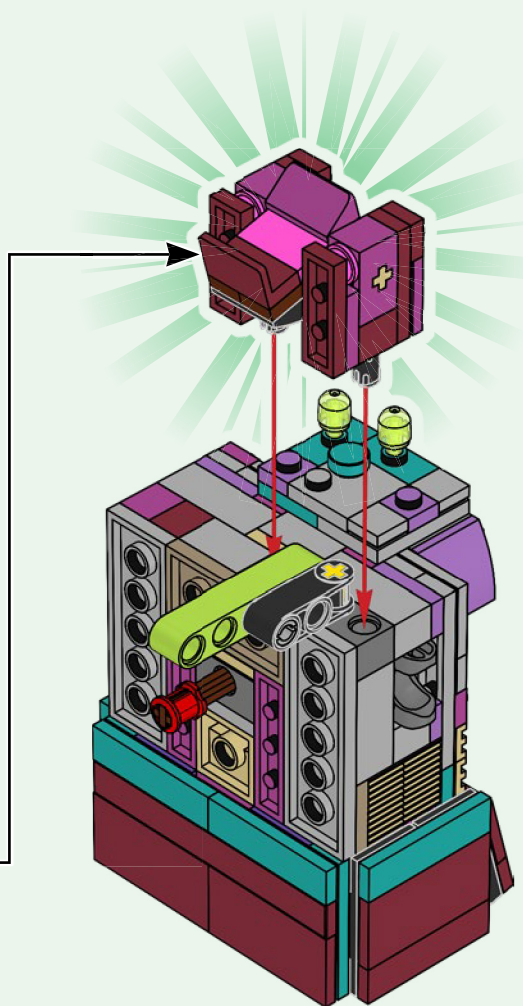

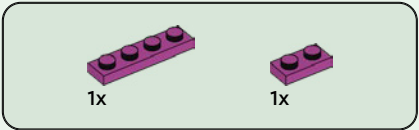

77

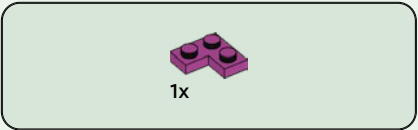
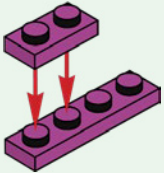

78

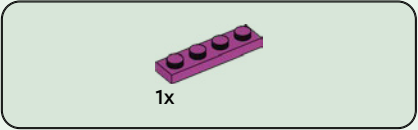
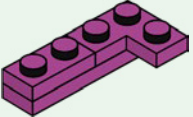

79

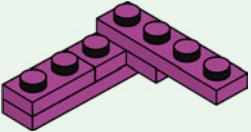

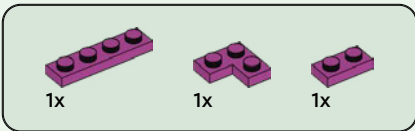

80

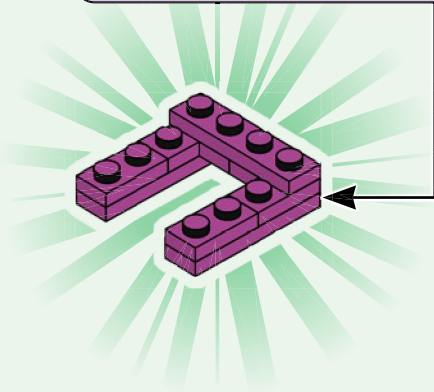
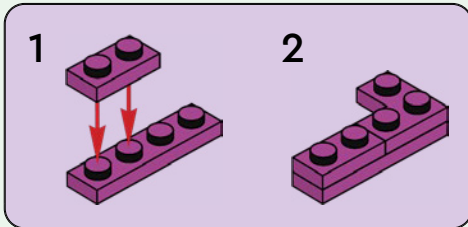

81

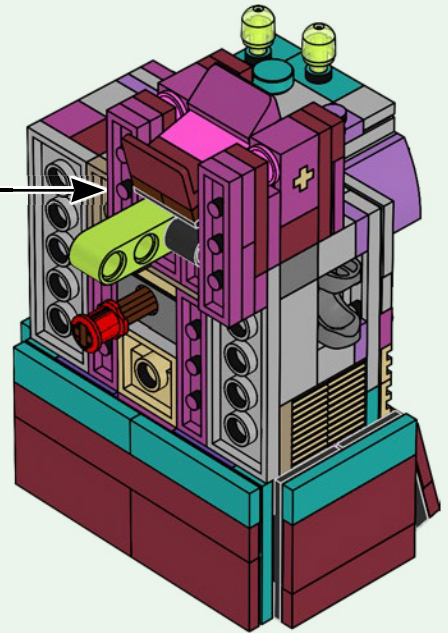



82

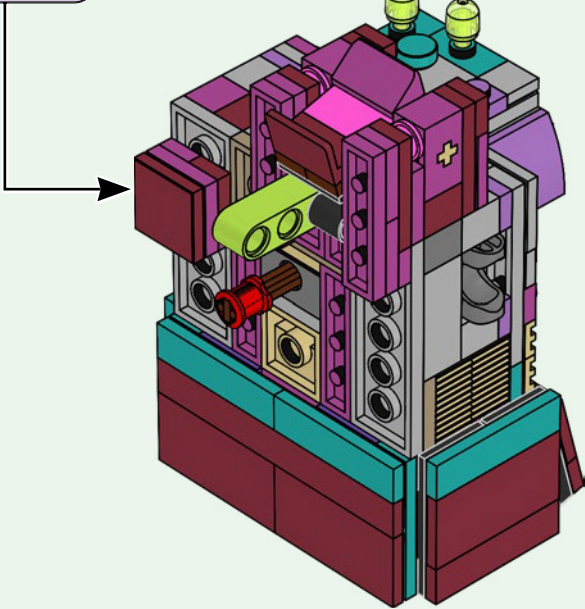
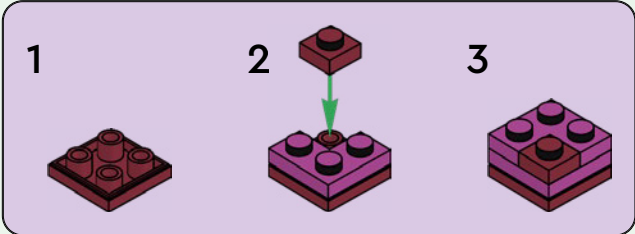

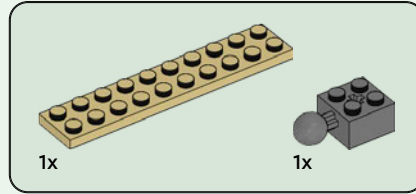
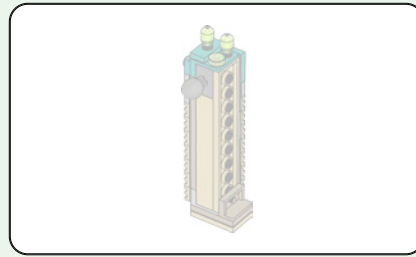

83

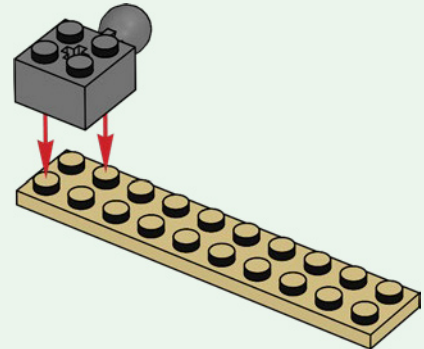

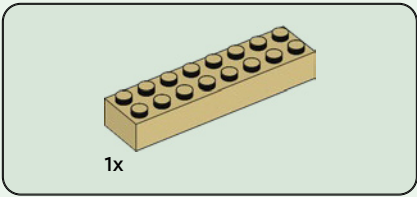

84

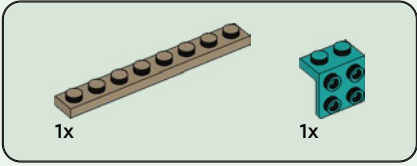
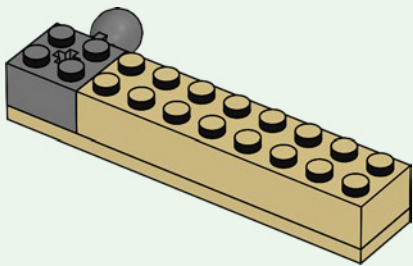

85

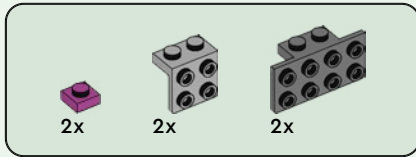
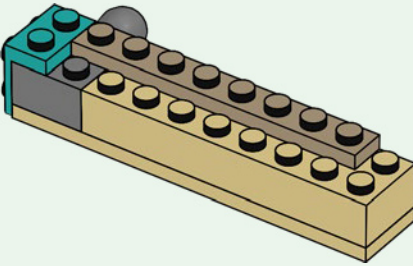

86

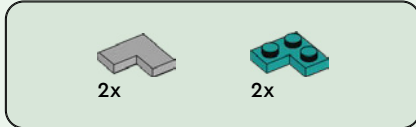
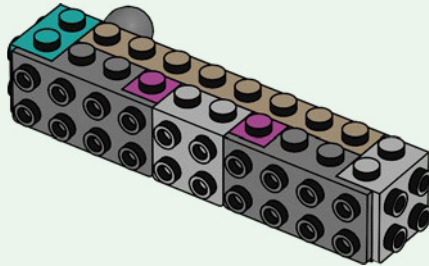

87

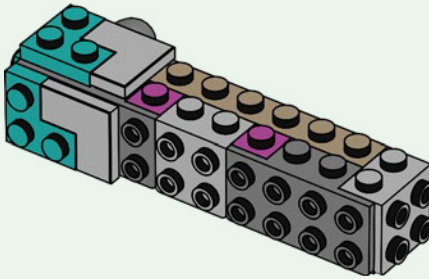



14x

88

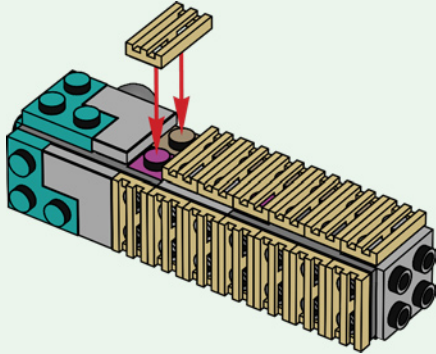

1x

89

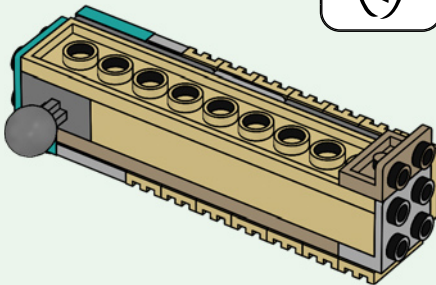

1x



1x

90

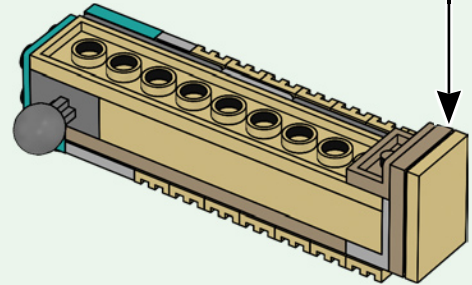
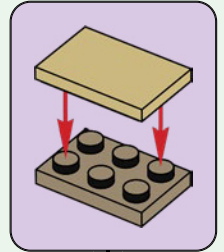



1x



1x

91

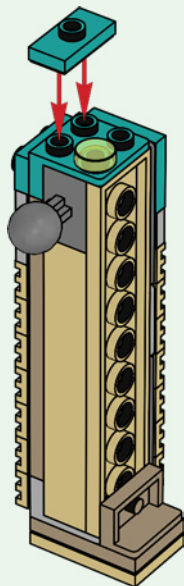

2x

92

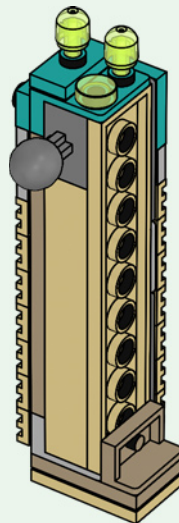

93

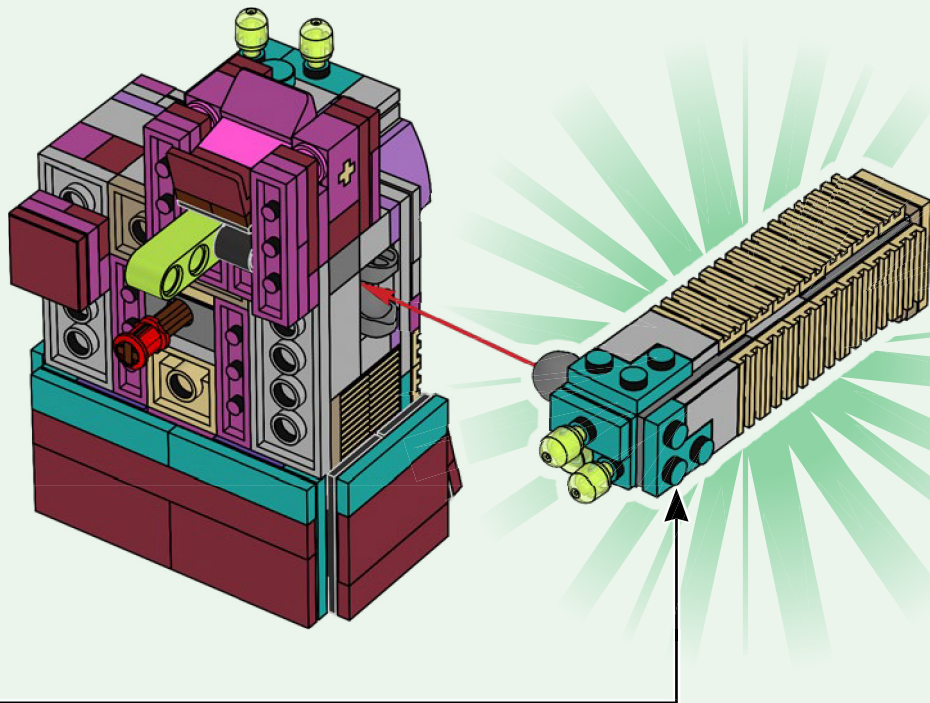

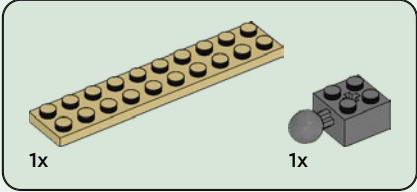
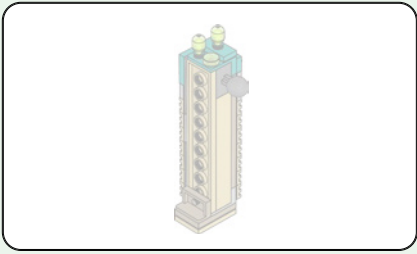

94

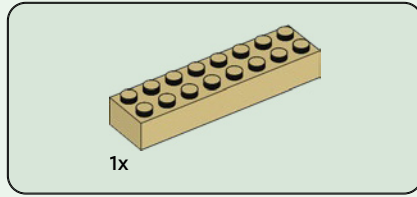
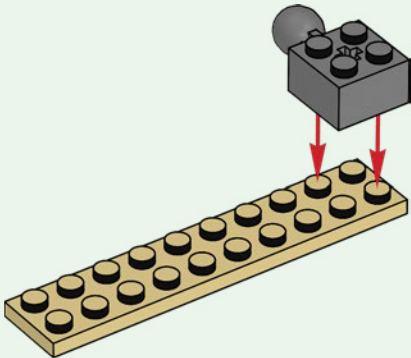

95

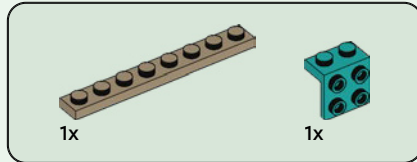
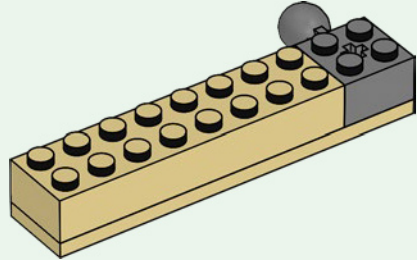

96

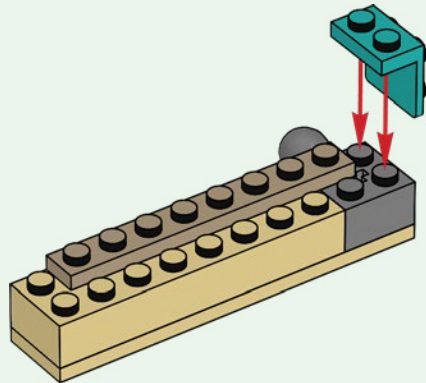

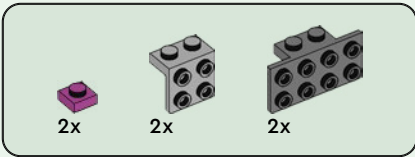

97

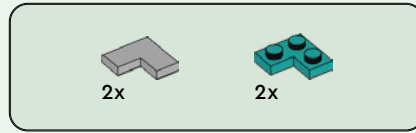
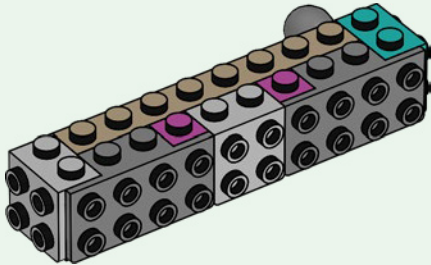

98

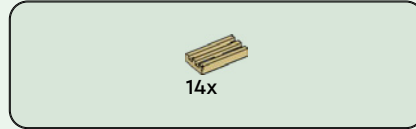
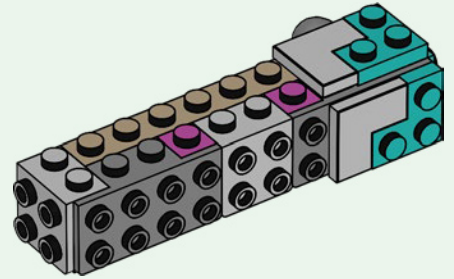

99

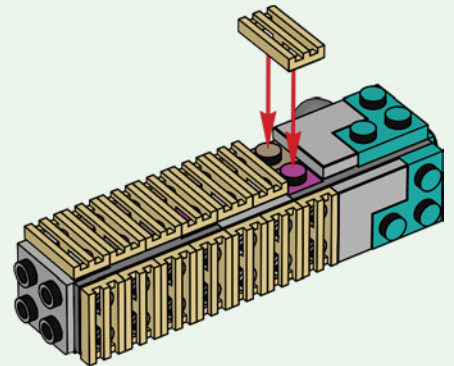



1x

100

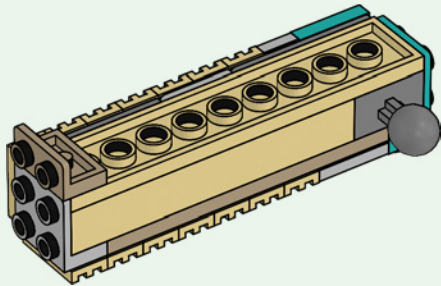

1x



1x

101

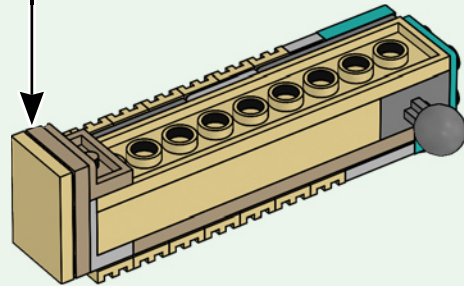
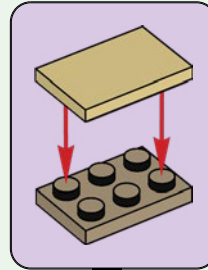



1x



1x

102

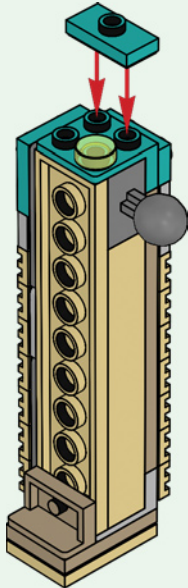

2x

103

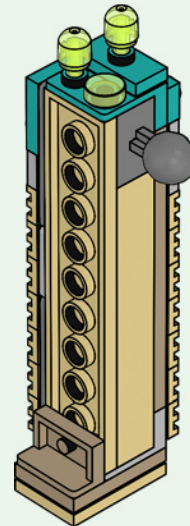



104

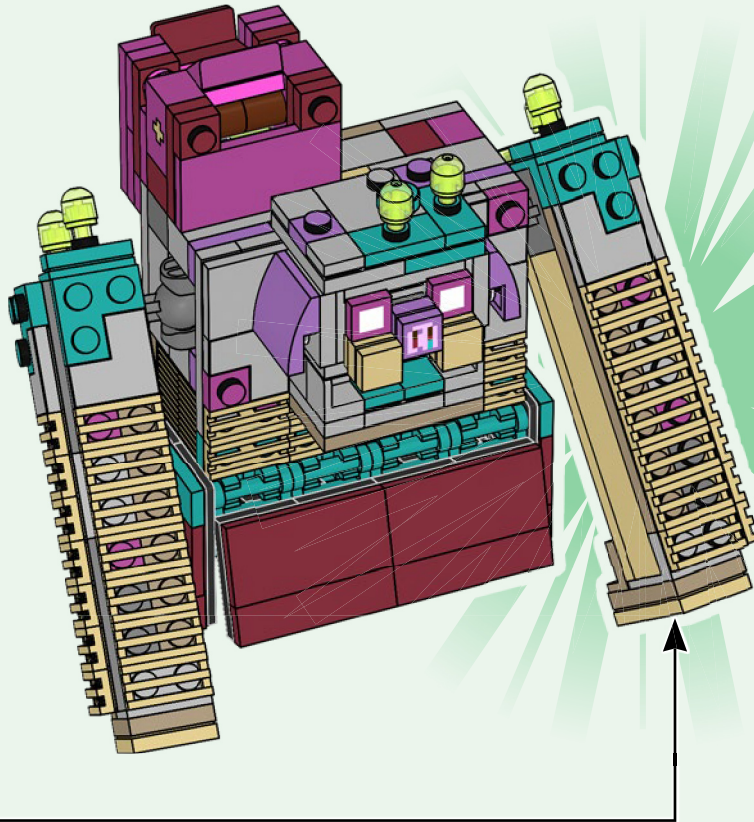



1x



1x

105

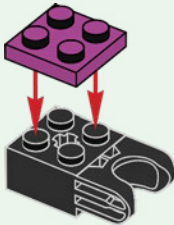

1x



1x

106

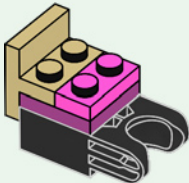

1x

107

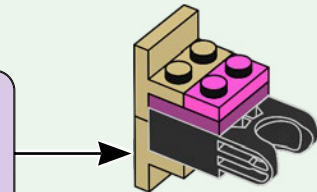
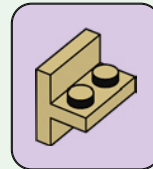



2x



1x

110

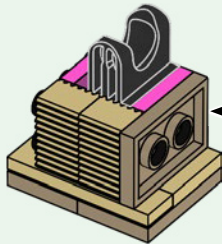
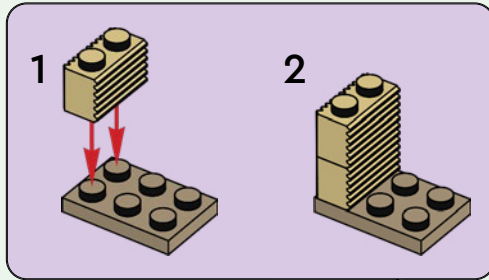

1x

111

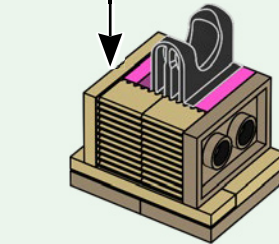
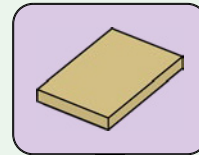

112

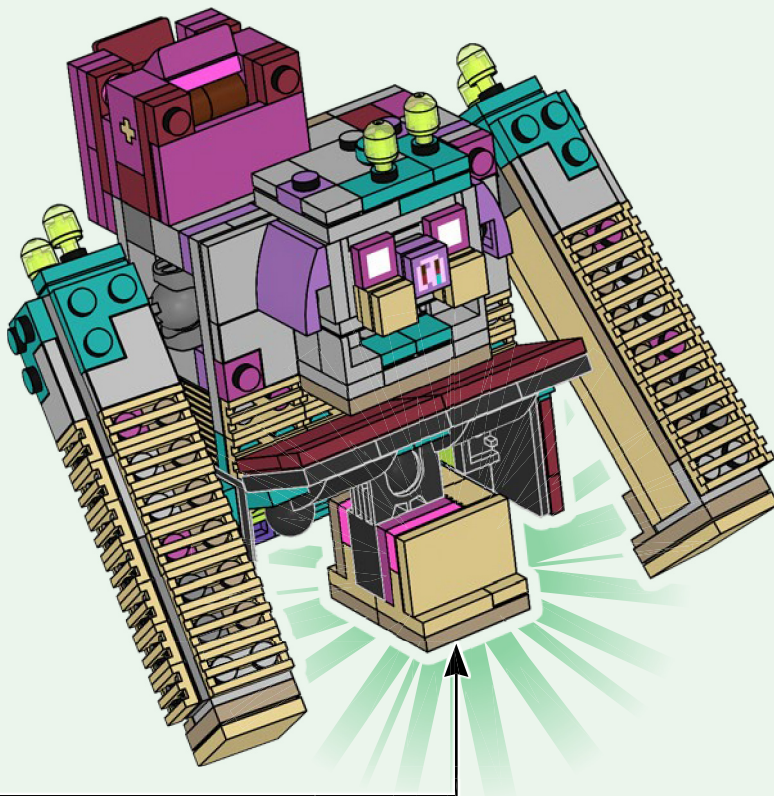



1x



1x

113

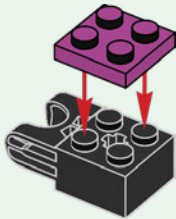

1x



1x

114

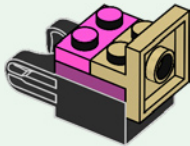

1x

115

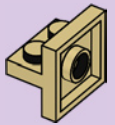
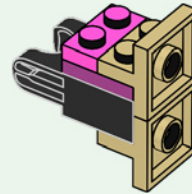

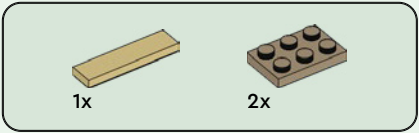

116

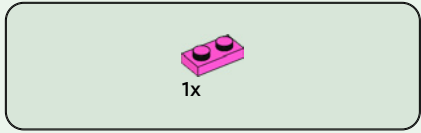
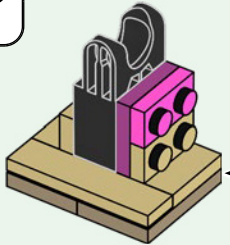
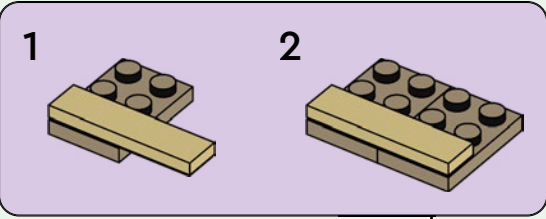

117

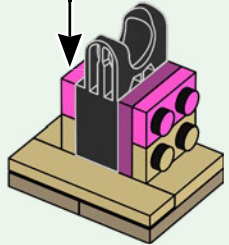
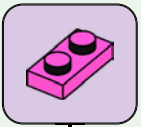



2x



1x

118

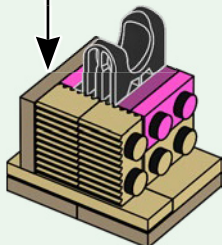
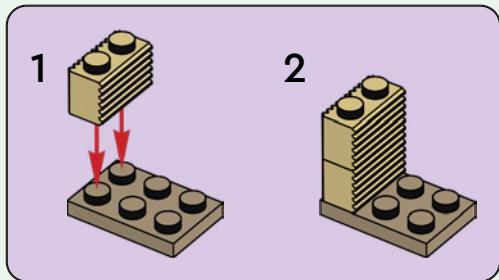

1x

119

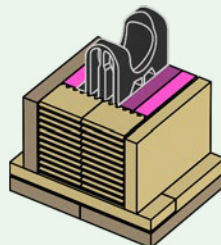

120

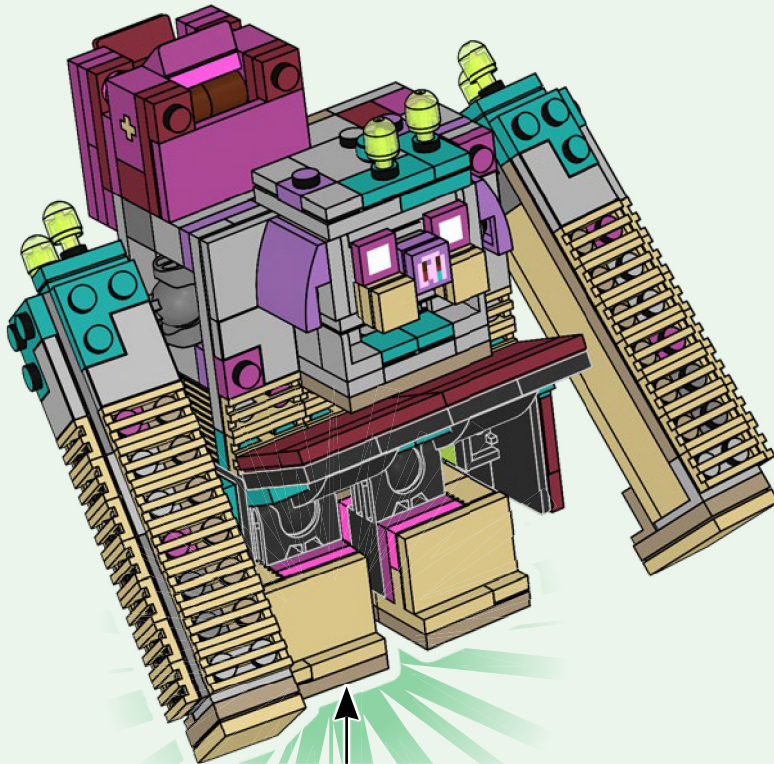



2x

121

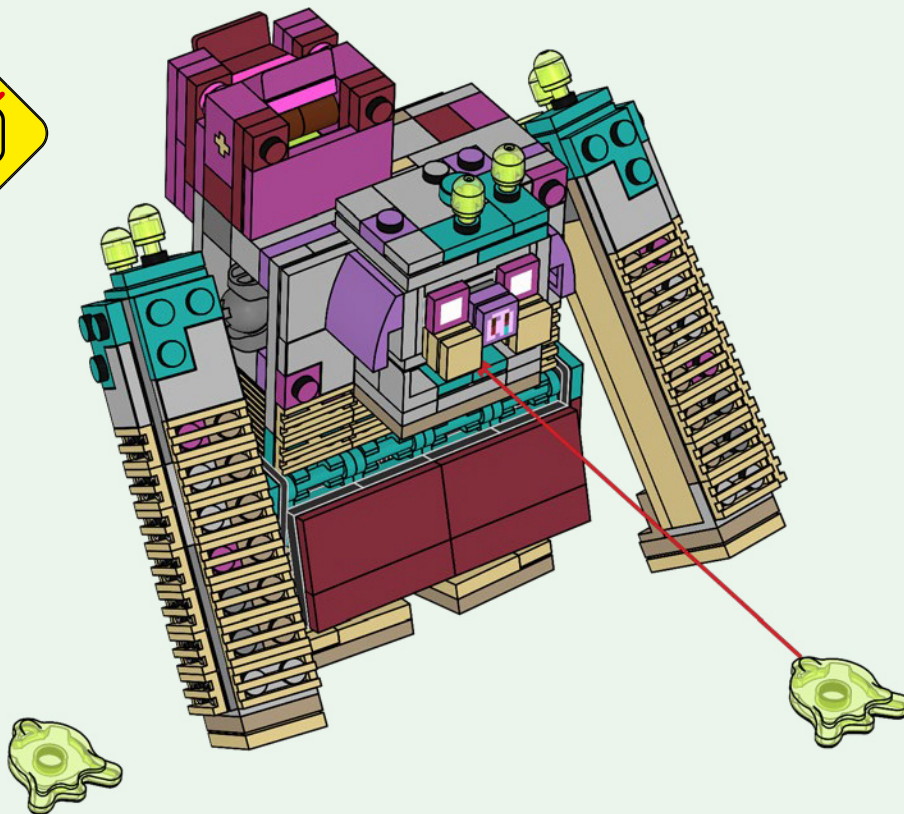

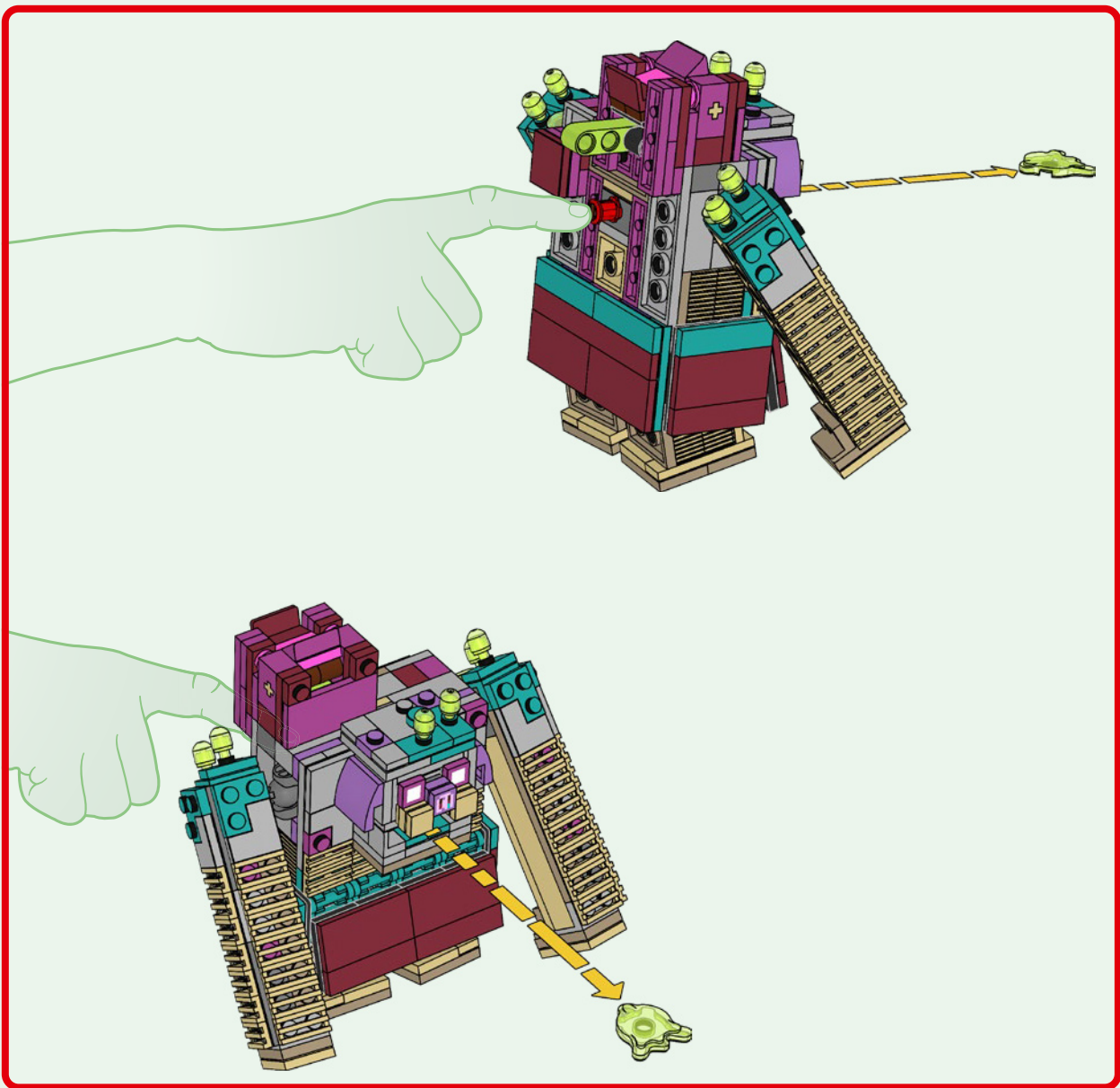



2x

122

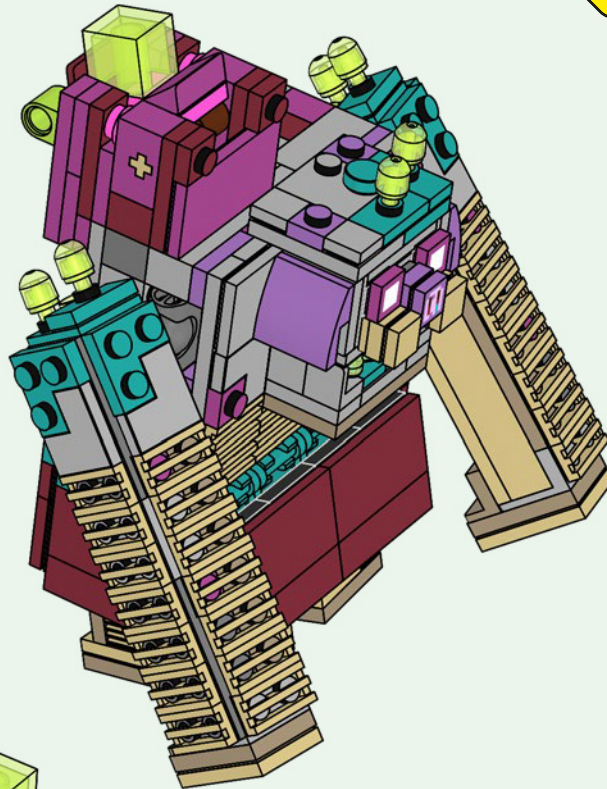

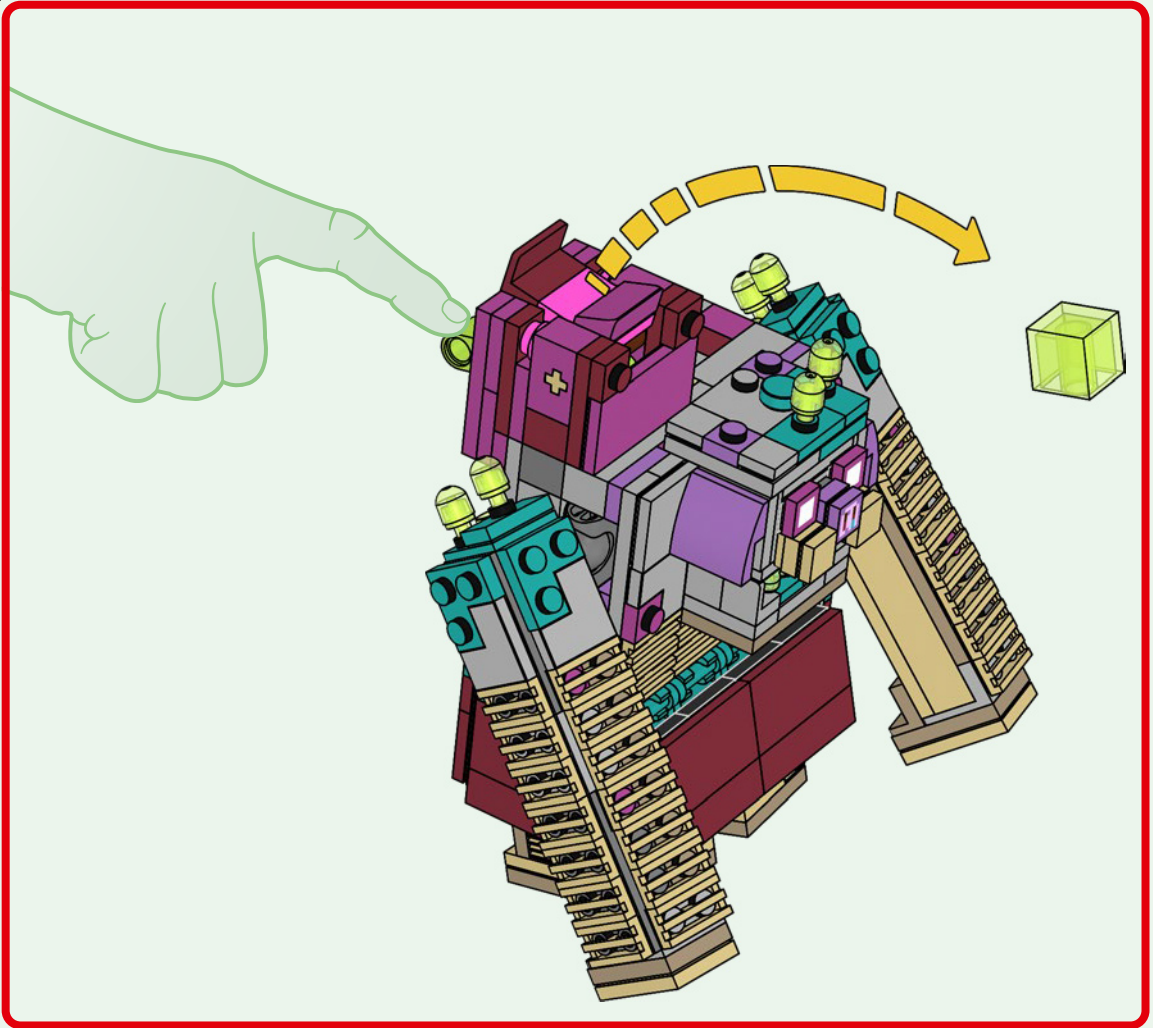





MINECRAFT

21256



21257



21251



21255



21252

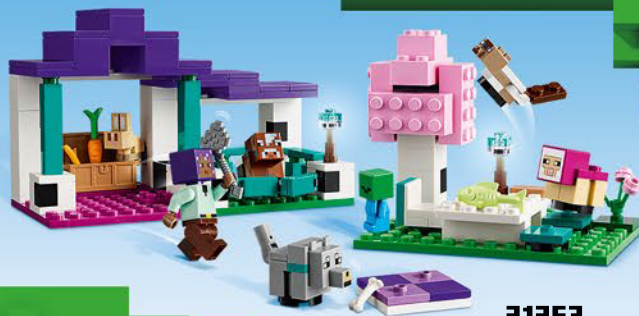

21253



21254



4x
4539060

6x
6186003

1x
4539083

1x
6065504

2x
6442899

1x
4622062

2x
6468493

1x
4221886

1x
6089103

2x
6415991

1x
6159763

1x
6170468

2x
4211525

4x
4211535

2x
4215513

2x
4211415

1x
6401023

1x
4211807

4x
4211398

2x
4654580

4x
6117967

3x
4211413

2x
4211349

6x
6065824

1x
4211387

4x
6212077

3x
4211428

2x
6471716

1x
6211969

1x
6472550

3x
4211396

1x
6351294

2x
6372029

3x
4211452

2x
6030277

2x
4211098

1x
6225494

1x
6221607

1x
6233908

1x
4211063

1x
6266248

2x
4210762

3x
4211111

4x
6118832

2x
4497253

2x
6338291

2x
6039176

6x
6195315

4x
6057387

1x
6293401

1x
6093529

1x
6464580

2x
6336983

2x
6274748

2x
6472551

6x
6171864

1x
6214216

1x
6151671

1x
6152110

3x
6236583

1x
6468492

1x
6473649

1x
6468495

3x
6466720

1x
6093623

2x
4625032

1x
6360056

1x
4653970

1x
6465291

1x
6472347

3x
4619521

4x
4619517

2x
6139090

1x
6470181

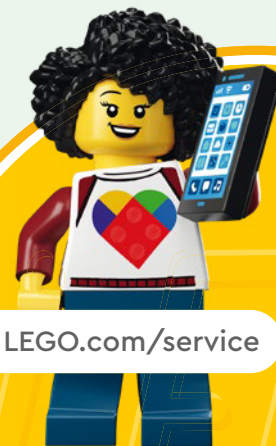

 [LEGO.com/service](https://www.LEGO.com/service)

YOU COULD **WIN**



Scan this QR code or go to **LEGO.COM/PRODUCTFEEDBACK** and give us your short feedback about this LEGO® set for a chance to win a cool LEGO prize.

Terms and Conditions apply*

EN: YOU COULD WIN. Terms and Conditions apply* **DE: Du könntest GEWINNEN.** Es gelten die Teilnahmebedingungen* **FR: Tu pourrais GAGNER.** Des conditions s'appliquent* **IT: Potresti VINCERE tu.** Termini e condizioni sono applicabili* **ES: Puedes GANAR.** Aplican términos y condiciones* **PT: Poderá GANHAR.** Aplicam-se termos e condições* **ZH: 轻松获奖. 条款和条件适用*** **PL: Szansa na WYGRANĄ.** Obowiązują warunki korzystania* **CS: Máte šanci VYHRÁT.** Platí všeobecné smluvní podmínky* **SK: Máte šancu VYHRAŤ.** Platia všeobecné zmluvné podmienky* **HU: TE IS NYERHETSZ.** Felhasználási feltételek érvényesek* **RO: Ai putea CÂȘTIGA.** Se aplică termeni și condiții* **BG: Можете да СПЕЧЕЛИТЕ.** Има определени правила и условия* **LV: Tu vari LAIMĒT.** Ir spēkā noteikumi un nosacījumi.* **ET: Sul on võimalus VÕITA.** Kehtivad tingimused* **LT: Jūs galite LAIMĖTI.** Taikomos sąlygos*

*[LEGO.com/productfeedback-terms](https://www.lego.com/productfeedback-terms)