

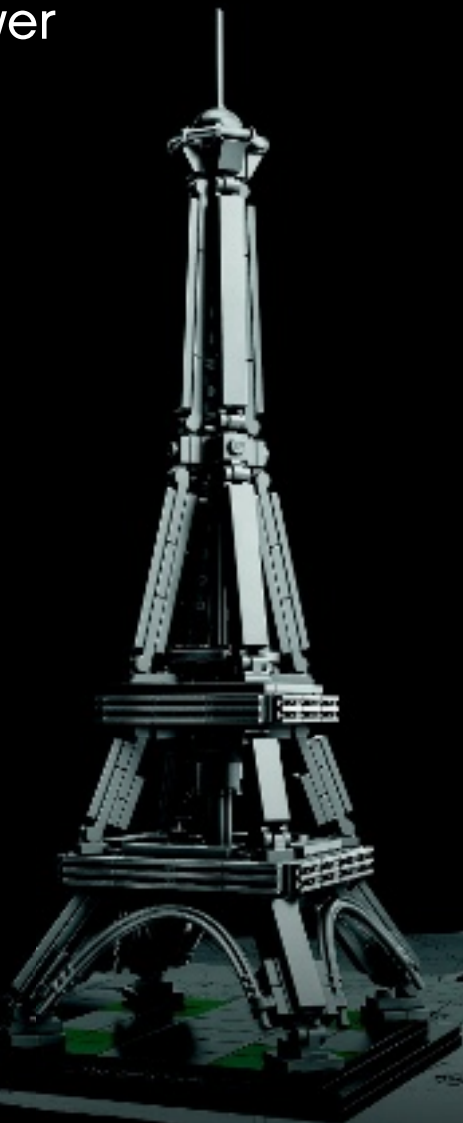





Architecture

The Eiffel Tower

La tour Eiffel
Paris, France



-  Booklet available in English on
-  Livret disponible en français sur
-  Folleto disponible en español en [LEGO.com/Architecture](https://www.lego.com/Architecture)

The Eiffel Tower

The Eiffel Tower (La tour Eiffel) is the famous, iron lattice structure located on the Champ de Mars in Paris, France. It is named after the engineer, Gustave Eiffel, whose company designed and built the tower as the entrance to the 1889 Exposition Universelle, or World's Fair. The tower is one of the most recognizable structures in the world and has become an iconic symbol of both Paris and France.

[Can one think that because we are engineers, beauty does not preoccupy us or that we do not try to build beautiful, as well as solid and long lasting structures?]

Gustave Eiffel

La tour Eiffel

La tour Eiffel est la célèbre structure en treillis métallique située sur le Champ-de-Mars à Paris. Elle doit son nom à l'ingénieur Gustave Eiffel, dont l'entreprise a conçu et construit la Tour comme entrée de l'Exposition universelle de 1889. La Tour est l'une des plus célèbres structures du monde et est devenu un symbole de Paris et de la France.

[Parce que nous sommes des ingénieurs, croit-on donc que la beauté ne nous préoccupe pas dans nos constructions et qu'en même temps que nous faisons solide et durable, nous ne nous efforçons pas de faire élégant ?]

Gustave Eiffel



History

In 1889 Paris hosted a World's Fair to mark the 100-year anniversary of the French Revolution. Three years before, an official competition had been launched to find a suitable centerpiece for the exhibition. Gustave Eiffel's plan for a 985-foot (300-meter) tall iron tower was selected from among the 107 different projects submitted.

Two chief engineers from Eiffel's company, Maurice Koechlin and Emile Nouguier, had already been working on an idea for an iron tower since 1884. Their design was based on a large pylon with four columns of latticework girders, separated at the base and coming together at the top. The four columns would be joined together by metal girders at regular intervals.

In order to make the proposed project more acceptable to public opinion, Nouguier and Koechlin turned to the head of the company's architectural department, Stephen Sauvestre, and asked him to work on the tower's overall appearance.

Sauvestre proposed stonework pedestals to dress the legs, and added decorative arches to link the columns at the first level. He also suggested a bulb-shaped design for the top and various other ornamental decorations, but these were rejected to create the simplified appearance we recognize today.

While Gustave Eiffel believed the structure would symbolize "not only the art of the modern engineer, but also the century of Industry and Science in which we are living," the proposed tower soon attracted criticism. Many of the country's leading art figures campaigned against it, calling

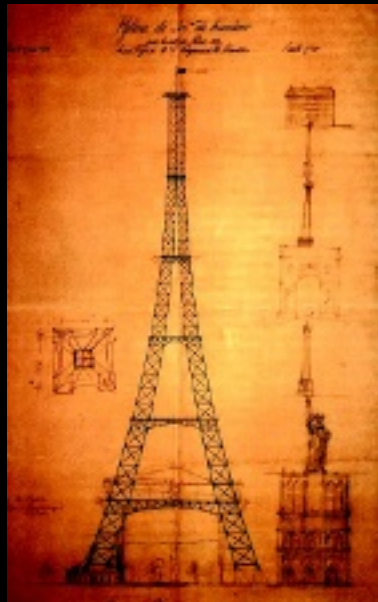

An early sketch of the tower from circa 1884
Une esquisse préliminaire de la Tour datant de 1884 environ

© Wikipedia

L'histoire

Paris accueillit en 1889 une Exposition universelle pour marquer le premier centenaire de la Révolution française. Trois ans auparavant, un concours officiel avait été lancé pour trouver une pièce centrale pour l'exposition. Le projet de Gustave Eiffel pour la construction d'une tour métallique de 300 mètres de hauteur fut sélectionné parmi les 107 projets qui avaient été soumis.

Deux ingénieurs en chef de l'entreprise d'Eiffel, Maurice Koechlin et Emile Nouguier travaillaient déjà sur une idée de tour en fer depuis 1884. Leur projet était conçu comme un grand pylône formé de quatre poutres en treillis écartées à la base et se rejoignant au sommet. Les quatre colonnes devaient être reliées entre elles par des poutres métalliques placées à intervalles réguliers.

Afin de rendre le projet proposé plus acceptable pour l'opinion publique, Nouguier et Koechlin ont demandé au responsable du service d'architecture de la société, Stephen Sauvestre, de travailler sur l'aspect général de la Tour.

© Wikipedia



*The tower lights up the World's Fair
La Tour illumine l'Exposition universelle*

Sauvestre proposa des piliers en maçonnerie pour habiller les jambes et ajouta des arches décoratives pour relier les colonnes au premier niveau. Il suggéra également une forme de bulbe pour le sommet et diverses décorations, mais ceci fut rejeté pour aboutir à l'aspect simplifié que nous connaissons aujourd'hui.

Si Gustave Eiffel pensait que la structure allait symboliser « l'art de l'ingénieur moderne mais aussi le siècle de l'Industrie et de la Science dans lequel nous vivons », la tour proposée s'attira rapidement des critiques. De nombreuses personnalités

the structure both “useless and monstrous,” and a “hateful column of bolted sheet metal.”

Many of the protestors, however, changed their minds once the tower was built, and today it is widely considered to be a striking piece of structural art.

When the main work was completed in March 1889, Eiffel led a group of government officials, accompanied by representatives of the press, to the top of the tallest structure in the world. Since the elevators were not yet in operation, the ascent was made by foot, and took over an hour. Here Eiffel unfurled a large Tricolore to the accompaniment of a 25-gun salute.



© Wikipedia

*The tower as a gateway to the World's Fair
La Tour comme entrée de l'Exposition universelle*



© Wikipedia

The tower under construction in 1888
La construction de la Tour en 1888

artistiques françaises firent campagne contre elle, jugeant la structure « inutile et monstrueuse » et une « odieuse colonne de tôle boulonnée ».

De nombreux critiques changèrent cependant d'avis après la construction de la Tour et elle est aujourd'hui considérée comme un ouvrage d'art exceptionnel.

Lorsque les travaux principaux furent achevés en mars 1889, Eiffel emmena un groupe de membres du gouvernement, accompagnés de journalistes, au sommet de la plus haute structure du monde. Les ascenseurs ne fonctionnaient pas encore, et l'ascension à pied dura plus d'une heure. Eiffel déploya au sommet un grand drapeau tricolore, au son de 25 coups de fusil.

Design and Construction

It took an enormous amount of preparatory work before construction on the tower could begin. The company's drawing office produced over five thousand drawings describing the complex angles involved and the degree of precision needed to join the 18,038 individual iron parts together. Work on the foundations started in January 1887, and by the end of June the four pedestals were ready. The assembly of the tower began on July 1, 1887, and after two years, two months, and five days, the structure was completed.

All the elements were prepared in Eiffel's factory located at Levallois-Perret on the outskirts of Paris. Each individual piece was traced out to an accuracy of a tenth of a millimeter and then connected to the other pieces to form larger elements approximately 16.4 feet (5 meters) in length.

First the pieces were assembled in the factory using bolts, later to be replaced one by one with thermally assembled rivets, which contracted during cooling to ensure a very tight fit. The pieces were hauled up by steam cranes, which themselves climbed up the tower as they went along, using the runners intended for the tower's elevators. Hydraulic jacks – replaced after use by permanent wedges – allowed the metal girders to be positioned to an accuracy of 0.04 inch (1 millimeter).

As the tower neared completion, many people were alarmed by its daring design and criticized Eiffel for not paying enough attention to the engineering challenges involved in building the world's tallest structure. Eiffel and his engineers were, however, masters of building complex iron bridges, and, for them, the tower project was a natural extension of the company's earlier pioneering work.



*It took two years, two months, and five days to complete the tower.
Il fallut deux ans, deux mois et cinq jours pour terminer la Tour.*

Conception et construction

Il fallut d'énormes travaux de préparation avant que la construction de la Tour ne puisse commencer. Le bureau d'études de l'entreprise produisit plus de 5 000 dessins décrivant les angles complexes impliqués et le degré de précision nécessaire pour assembler les 18 038 pièces de fer. Les travaux des fondations commencèrent en janvier 1887 et les piliers furent terminés fin juin. L'assemblage de la Tour commença le 1^{er} juillet 1887 et après deux ans, deux mois et cinq jours, la structure fut terminée.

Tous les éléments furent préparés dans l'usine d'Eiffel située à Levallois-Perret dans la banlieue de Paris. Chaque pièce individuelle fut découpée avec une précision d'un dixième de millimètre puis reliée aux autres pour former des éléments plus grands d'environ cinq mètres de long.

Les pièces furent tout d'abord assemblées dans l'usine en utilisant des boulons, qui furent par la suite remplacés par des rivets posés à chaud. Les pièces furent transportées par des grues à vapeur qui s'élevèrent avec la Tour en utilisant les glissières prévues pour les ascenseurs. Des vérins hydrauliques, remplacés après leur utilisation par des cales permanentes, permettaient aux poutres métalliques d'être placées avec une précision d'un millimètre.

Alors que la construction de la Tour s'achevait, de nombreuses personnes furent alarmées par sa conception audacieuse et critiquèrent Eiffel pour ne pas avoir accordé assez d'attention aux défis d'ingénierie posés par la construction de la plus haute structure du monde. Eiffel et ses ingénieurs étaient cependant des experts dans la construction de ponts métalliques complexes et le projet de la Tour était pour eux une extension naturelle du travail de pionnier de la société.

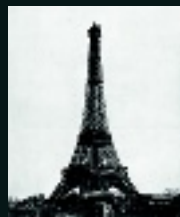

From 1889 to Today

The tower was an immediate success with the public, and lengthy queues formed to make the ascent. Tickets cost two francs for the first level, three for the second, and five for the top, with half-price admission on Sundays. By the end of the 1889 World's Fair, there had been nearly two million visitors.

Eiffel had a permit for the tower to stand for twenty years; it was to be dismantled in 1909, when its ownership would revert to the City of Paris. The city had originally planned to take it down (part of the original contest rules for designing the tower was that it could be easily demolished), but Eiffel argued that the structure was valuable for communication and scientific purposes. After a short campaign, it was allowed to remain after the original permit expired.

Eiffel installed a meteorology lab on the third floor and later also constructed a small wind tunnel at the foot of the tower. He carried out five thousand tests there and encouraged others to use the tower to study subjects such as meteorology, astronomy, and physics. It was the advent of wireless telegraphy that finally secured the structure's future. The

top of the tower would be modified over the years to accommodate an ever-growing number of antennas. It is currently home to 120 antennas, plus a television mast that extends the height of the tower to 1,063 feet (324 meters).



© Shutterstock

Today the Eiffel Tower remains one of the most recognizable structures on the planet, welcoming more visitors than any other paid monument in the world—an estimated seven million people per year. Some five hundred employees are responsible for its daily operation, ensuring that eager crowds enjoy panoramic views of the city.

De 1889 à aujourd'hui

La Tour remporta un succès immédiat auprès du public et de longues files d'attente se formèrent pour effectuer l'ascension. Les billets coûtaient 2 francs pour le premier étage, 3 pour le deuxième et 5 pour le sommet, avec un billet à moitié prix le dimanche. À la fin de l'Exposition universelle en 1889, la Tour avait accueilli près de deux millions de visiteurs.

Eiffel avait un permis pour que la tour reste érigée pendant 20 ans, avant d'être démontée en 1909, lorsque la Ville de Paris en deviendrait propriétaire. La ville avait à l'origine prévu de la démonter (l'une des règles du concours pour la conception de la Tour était qu'elle devait être facilement démontée), mais Eiffel exposa que la structure était utile à des fins de communication et scientifiques. Après une courte campagne, elle fut autorisée à perdurer après l'expiration du permis original.

Eiffel installa un laboratoire de météorologie au troisième étage et construisit également par la suite une petite soufflerie au pied de la Tour. Il y réalisa cinq mille tests et encouragea des scientifiques à utiliser la Tour pour étudier des sujets tels que la météorologie, l'astronomie et la physique. L'arrivée de la télégraphie sans fil assura finalement l'avenir de la structure. Le sommet de la Tour allait être modifié au fil des ans pour accueillir un nombre toujours croissant d'antennes. Elle accueille aujourd'hui 120 antennes, plus une antenne de télévision qui élève la hauteur de la Tour à 324 mètres.

La tour Eiffel reste aujourd'hui l'une des structures les plus célèbres de la planète, accueillant plus de visiteurs que tout autre monument payant au monde, environ sept millions de personnes par an. Cinq cents employés assurent son fonctionnement quotidien, permettant à des foules enthousiastes d'admirer des vues panoramiques sur la ville.

The Architect

Born on December 15, 1832, in Dijon, Gustave Eiffel was an exceptionally gifted engineer and builder. He graduated from the *École Centrale des Arts et Manufactures* in 1855, the same year that Paris hosted the first World's Fair. He spent several years in southwestern France, where he supervised work on the great railway bridge in Bordeaux. In 1864, he set up in his own right as a "constructor," specializing in metal structural work.

Eiffel would go on to build hundreds of different types of metal structures all around the world. Bridges, particularly railway bridges, were his favorite field of work, but he also won renown for his metal structural work and industrial installations. His career was marked by a large number of fine structures and buildings, two of the most outstanding being the twin edifices of the Porto viaduct and the Garabit viaduct in the Cantal region of France.

Equally outstanding are the other structures where the pure inventiveness of Eiffel's company was allowed free rein, such as the "portable" bridges sold around the world as "kits," and the ingenious structure of the Statue of Liberty in New York. His entrepreneurial career culminated in 1889 with the completion of the Eiffel Tower.

Two years earlier, in 1887, Eiffel had agreed to build the locks of the Panama Canal. It was an immense undertaking, but the project was badly managed and went on to become one of the biggest financial scandals of the century.

After clearing his name, Eiffel retired to devote the final thirty years of his life to scientific research. He died on December 27, 1923, at the age of 91.



A handwritten signature of Gustave Eiffel in dark ink. The signature is stylized and cursive, starting with a large 'G' and ending with a long, sweeping flourish.

L'architecte

Né le 15 décembre 1832, à Dijon, Gustave Eiffel était un ingénieur et un constructeur exceptionnellement doué. Il obtint son diplôme à l'École Centrale des Arts et Manufactures en 1855, l'année où Paris accueille la première Exposition universelle. Il passa plusieurs années dans le sud-ouest de la France, où il supervisa les travaux du grand pont de chemin de fer de Bordeaux. En 1864, il s'établit à son compte comme « constructeur », se spécialisant dans la construction de structures métalliques.

Eiffel construisit des centaines de structures métalliques différentes dans le monde entier. Les ponts, en particulier les ponts de chemins de fer, constituaient son domaine de prédilection, mais il devint aussi célèbre pour ses structures métalliques et ses installations industrielles. Sa carrière fut marquée par de nombreux bâtiments et structures magnifiques. Parmi les plus exceptionnels figurent les édifices jumeaux du viaduc de Porto et du viaduc de Garabit dans le Cantal.

Toutes aussi exceptionnelles sont les autres structures où la société d'Eiffel laissa libre cours à son inventivité, notamment les ponts « portatifs » vendus dans le monde entier en « kits » et la structure ingénieuse de la Statue de la Liberté à New York. Le sommet de sa carrière d'entrepreneur eut lieu en 1889 avec la fin de la construction de la tour Eiffel.

Deux ans plus tôt, en 1887, Eiffel avait accepté de construire les écluses du canal de Panama. Il s'agissait d'une entreprise énorme, mais le projet fut mal géré et devint l'un des plus grands scandales financiers du siècle.

Après avoir blanchi sa réputation, Eiffel se retira pour consacrer les trente dernières années de sa vie à la recherche scientifique. Il est mort le 27 décembre 1923, à l'âge de 91 ans.

Facts about the Eiffel Tower

Location:	Paris, France
People:	Entrepreneur: Gustave Eiffel Engineers: Maurice Koechlin and Emile Nouguier Architect: Stephen Sauvestre
Materials:	Wrought iron with stonework pedestals
Construction:	Started January 1887 – completed March 1889
Number of iron parts:.....	18,038
Weight:	Iron structure: 8,047 tons (7,300 metric tons) Total structure: 11,133 tons (10,100 metric tons)
Height:	Initial height: 1,024 feet (312 meters) (to the top of the flagpole) – Current height (including antennas): 1,063 feet (324 meters)
Cost of construction:	7,799,401.31 French gold francs (1889)



© Shutterstock

Informations sur la tour Eiffel

Lieu :	Paris, France
Personnes :	Entrepreneur : Gustave Eiffel. Ingénieurs : Maurice Koechlin et Emile Nouguier. Architecte : Stephen Sauvestre.
Matériaux :	Fer forgé et piliers en maçonnerie
Construction :	Commencée en janvier 1887 - Terminée en mars 1889
Nombre de pièces en fer :	18 038
Poids :	Structure métallique : 7 300 tonnes Structure totale : 10 100 tonnes
Hauteur :	Hauteur initiale 312 m (en haut du mât du drapeau) - Hauteur actuelle (antennes incluses) 324 m
Coût de la construction : ..	7 799 401,31 francs or français (1889)



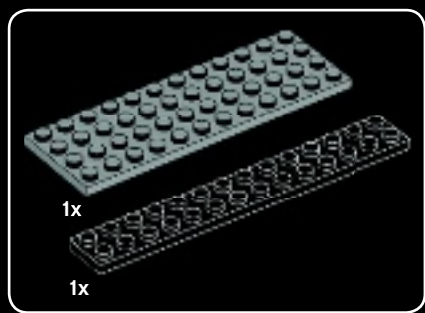

1





2

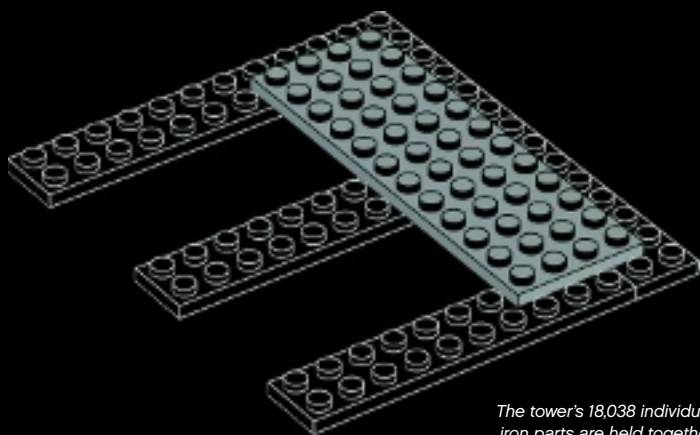

The tower's 18,038 individual iron parts are held together by a total of 2,500,000 rivets.

Les 18 038 pièces en fer de la Tour sont assemblées par un total de 2 500 000 rivets.



© Shutterstock

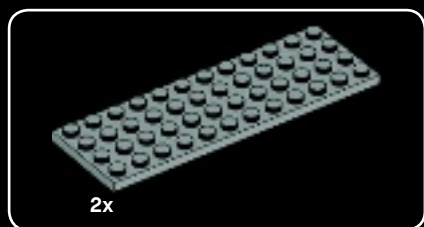

3

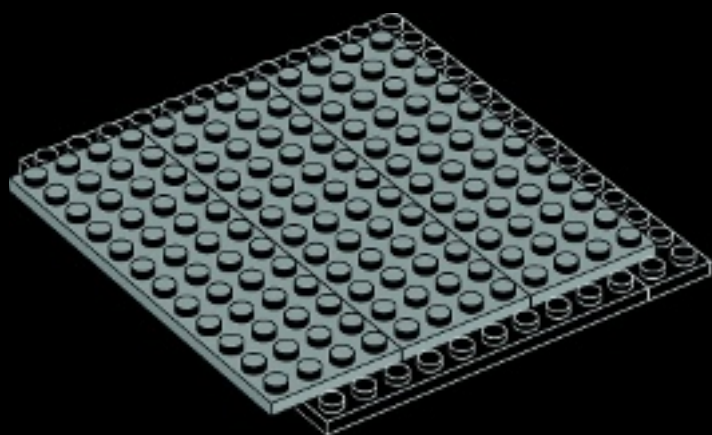

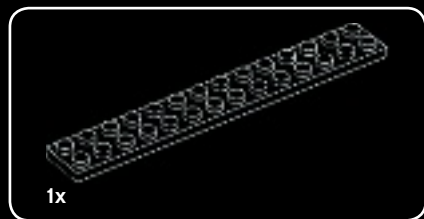

4

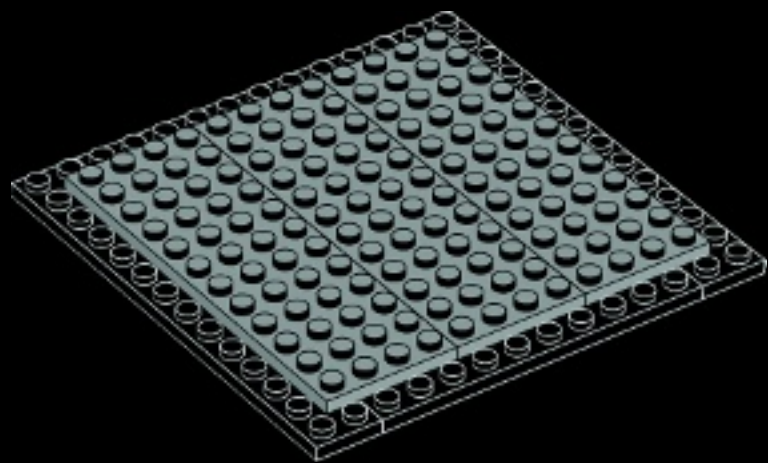



5

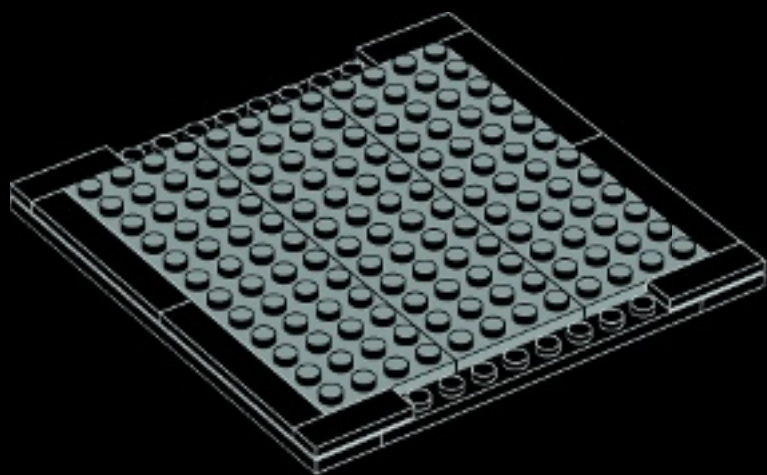

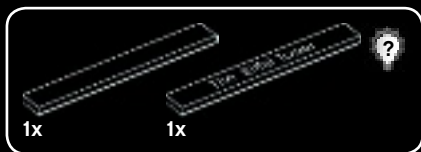

6

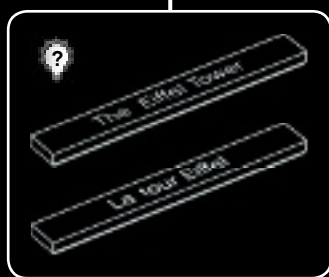
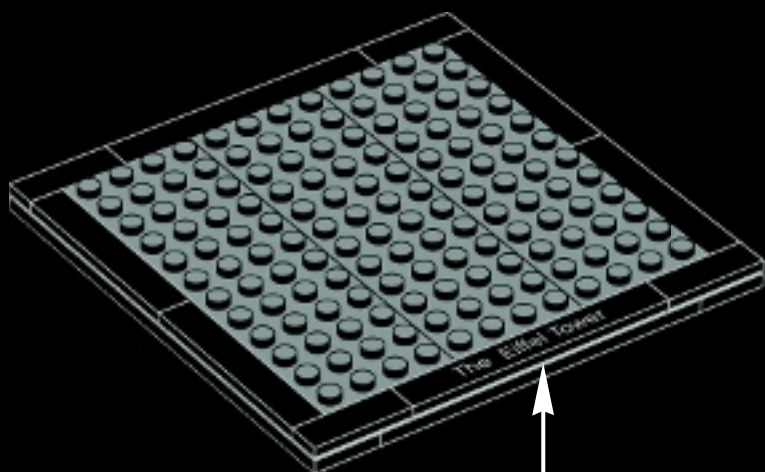



4x



12x

7

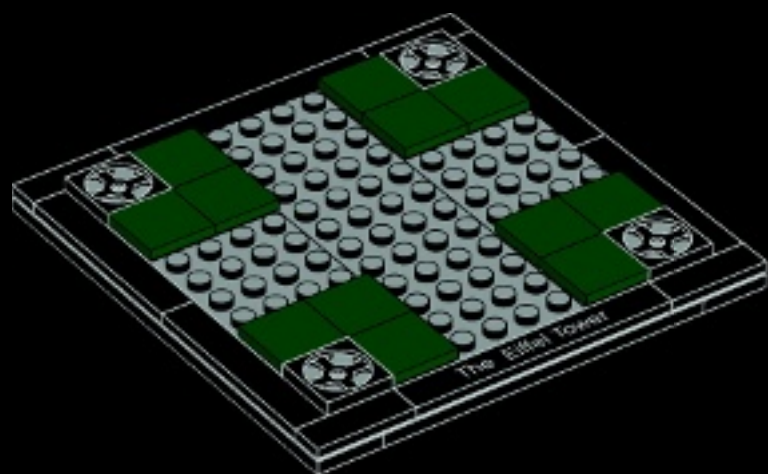



4x

8

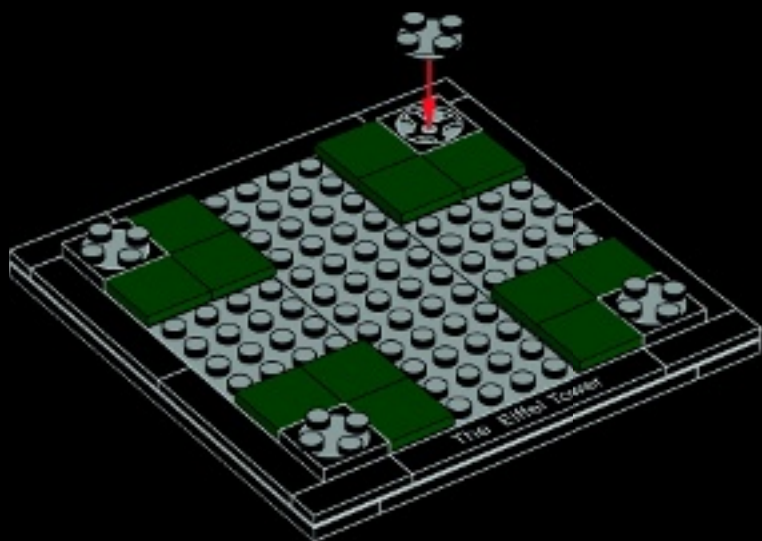



4x



8x

9

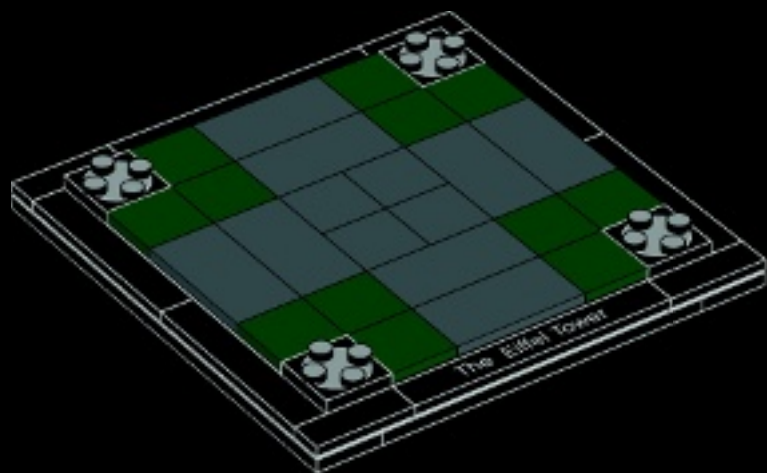



8x

10

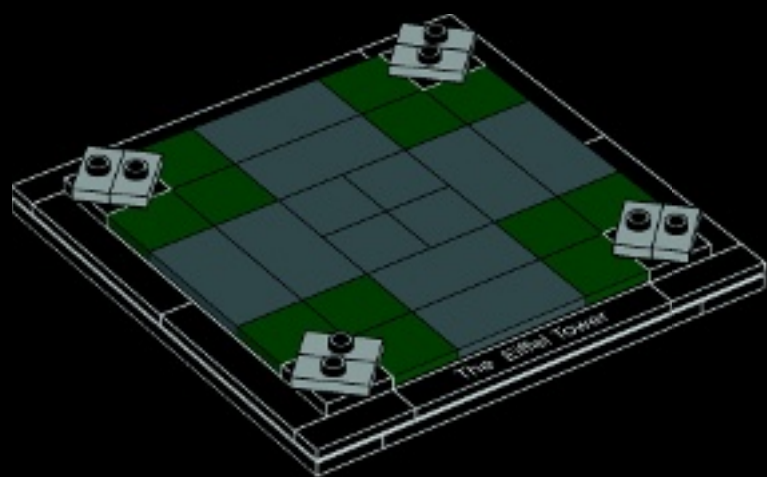



4x

11

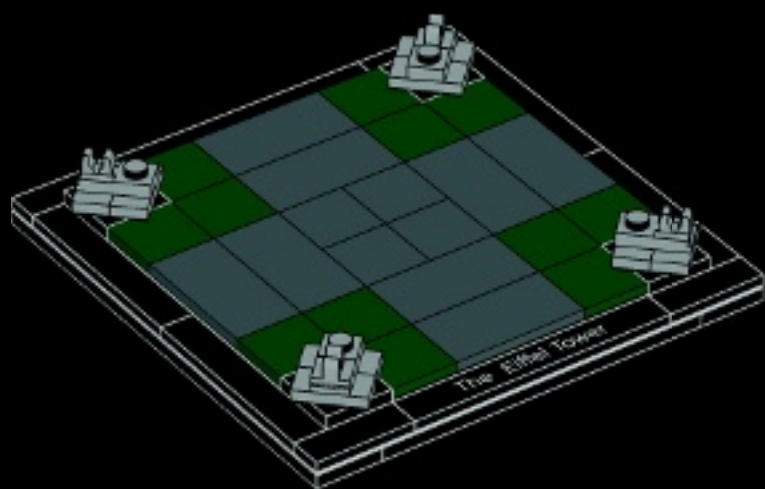

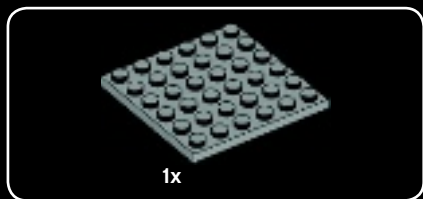
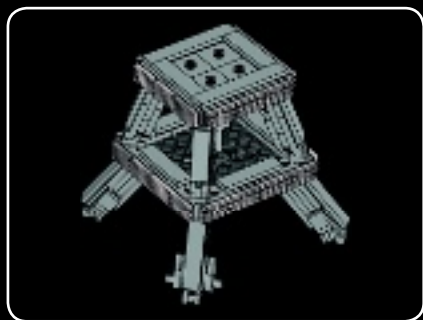

1



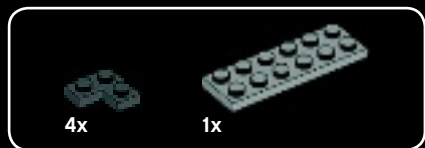

2





1x



2x

3



4x

4

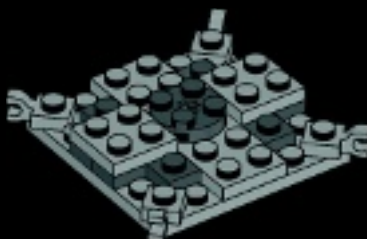



4x



4x

5



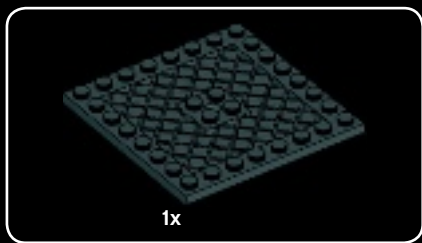

6



7

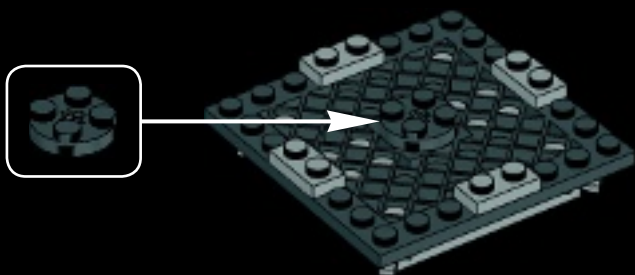



16x



8x

8

1



2



8x

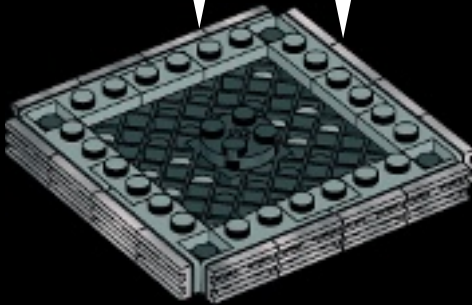



4x



4x

9

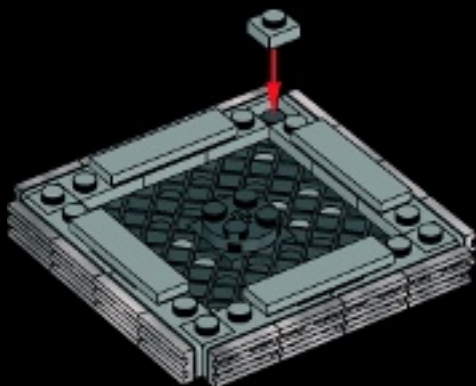

4x

10

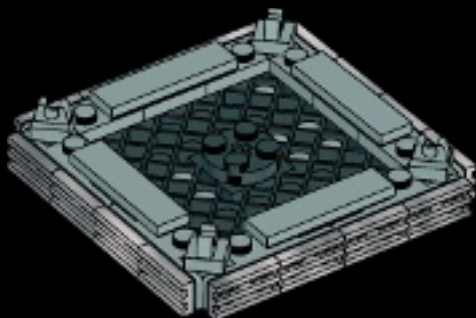



2x



1x

11

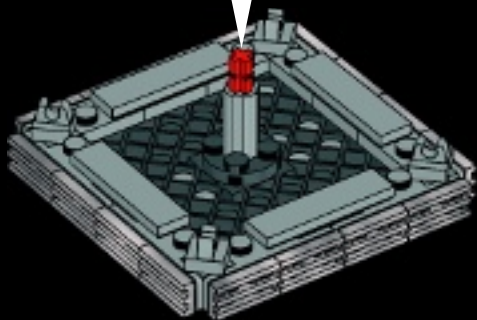



12

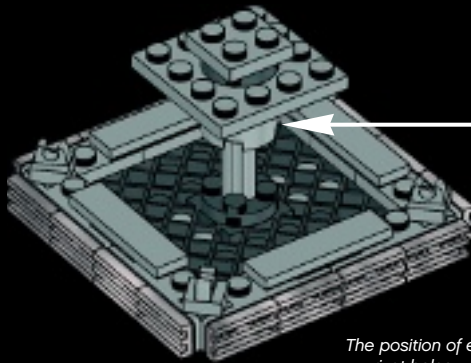

The position of each of the 2,500,000 rivet holes was specified to within 0.04 inch (0.1 millimeter).

La position de chacun des 2 500 000 trous de rivet fut spécifiée avec une précision de 0,1 mm.



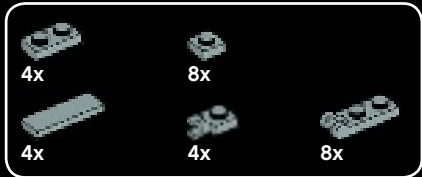

13

1



2



3



4

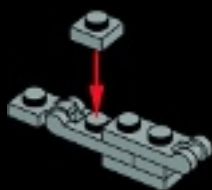

5

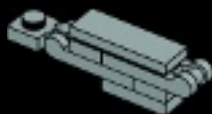

4x

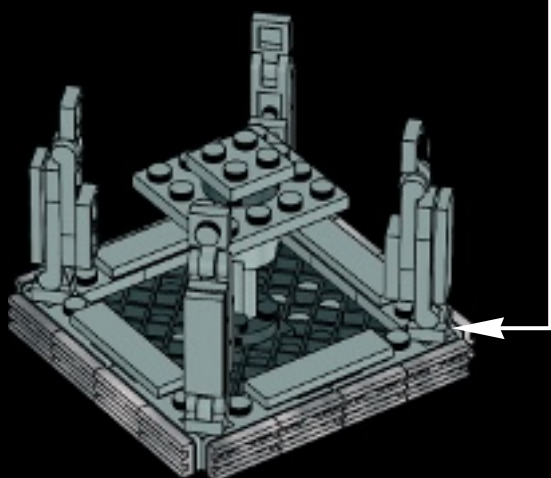

14

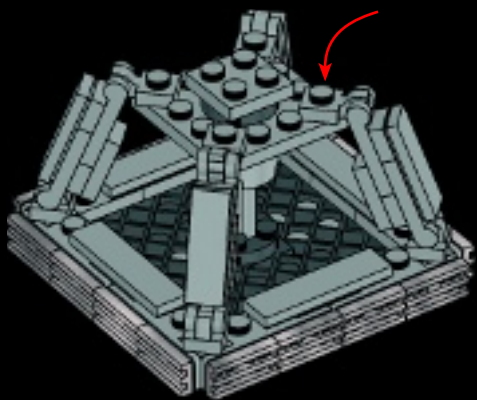



4x

15

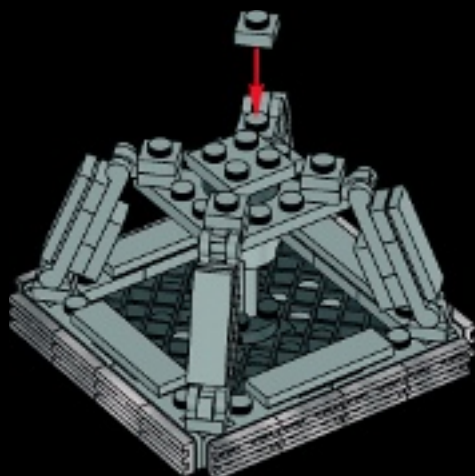

1x

16

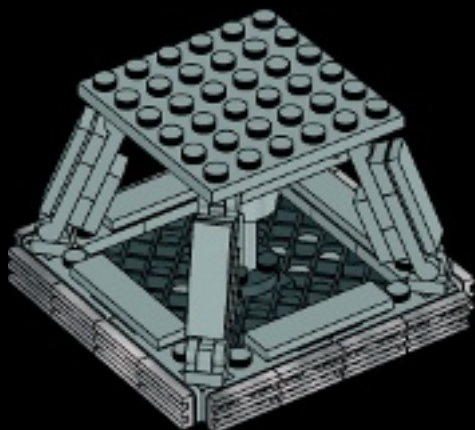



4x

17

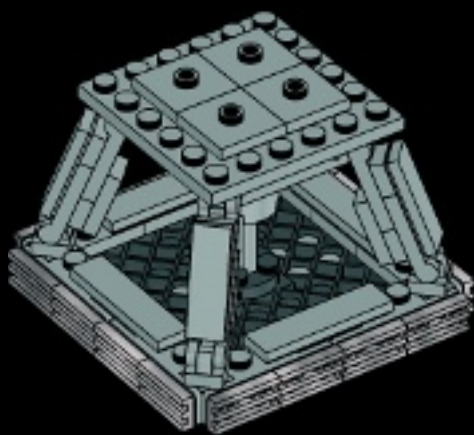



18

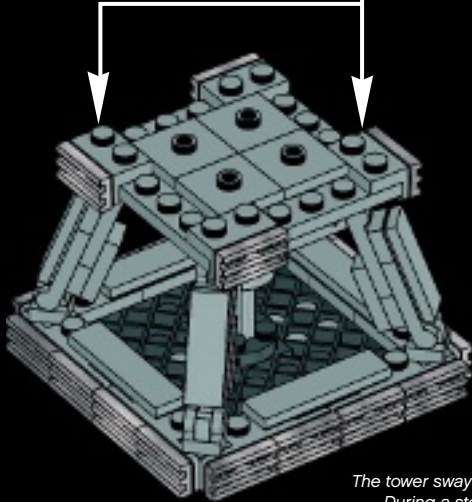

The tower sways slightly in the wind. During a storm in 1999, it moved approximately 5.12 inches (13 centimeters) from its initial position.

La Tour bouge légèrement dans le vent. Lors d'une tempête en 1999, elle s'est déplacée d'environ 13 cm de sa position initiale.



© Shutterstock



8x



4x

19

1



2



4x

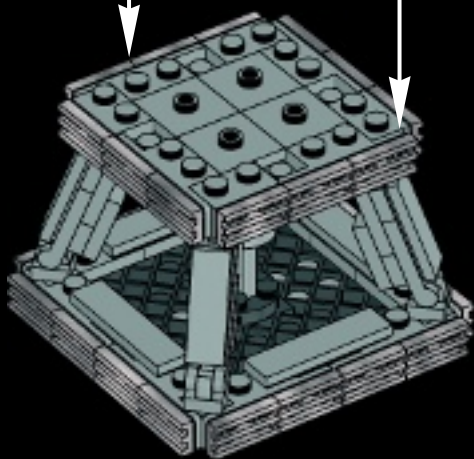

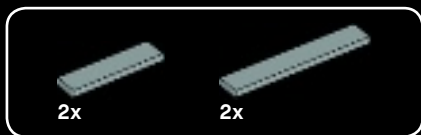

20

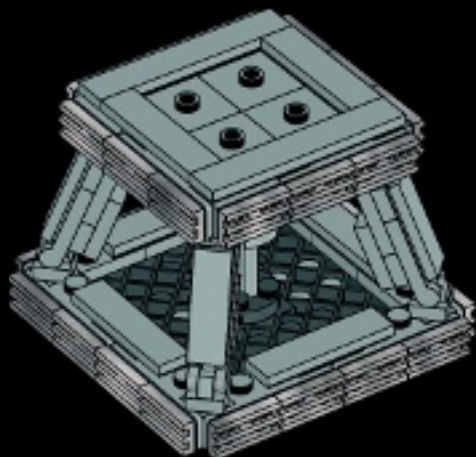

The Eiffel Tower is open 365 days a year and welcomes almost seven million visitors annually.

La tour Eiffel est ouverte 365 jours par an et accueille près de sept millions de visiteurs chaque année.



© Shutterstock



4x



4x



8x



4x



8x



4x



8x



4x



8x

21

1



2



3



4



5



6



7



4x

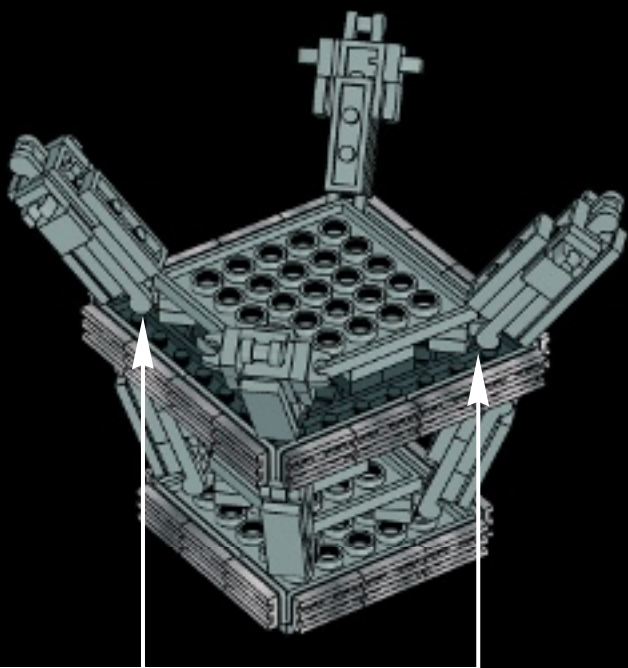

12

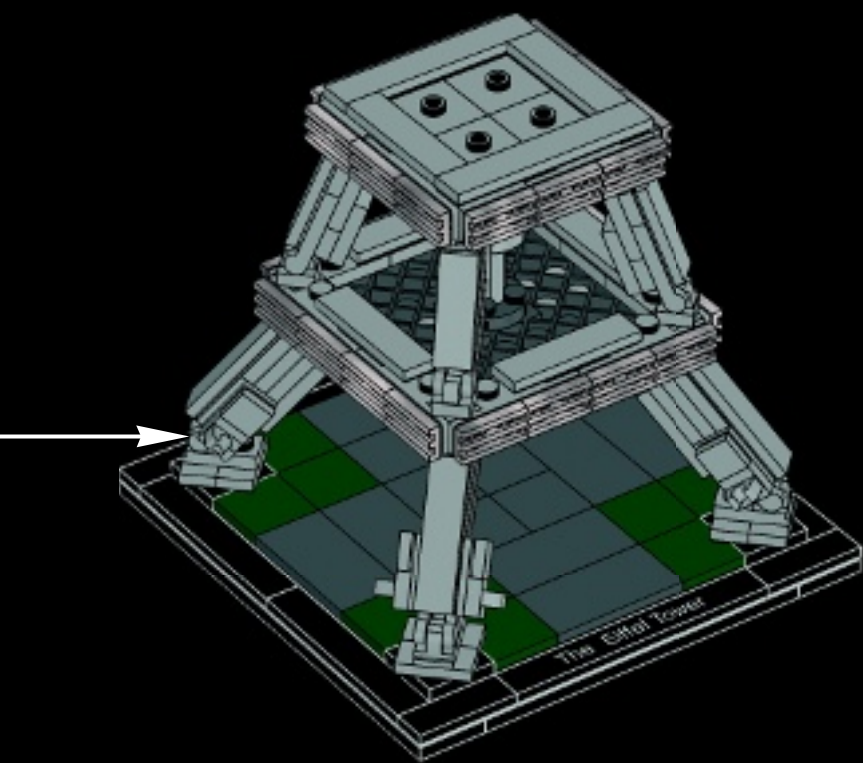

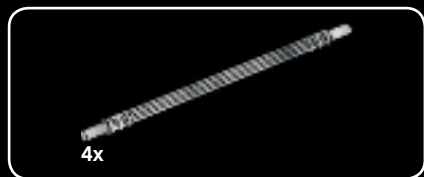

13

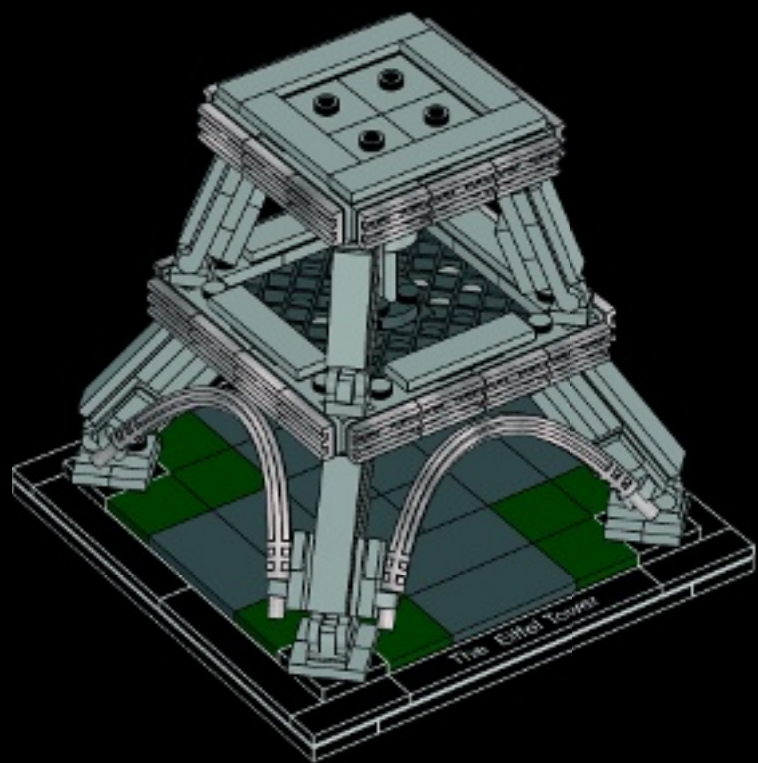

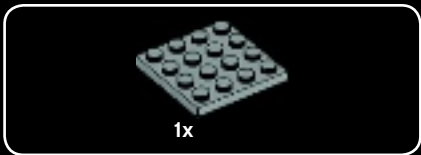
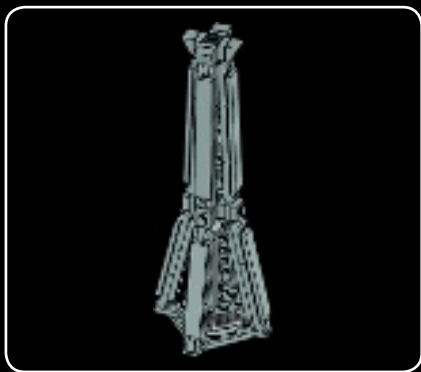

1



2



The Eiffel Tower is repainted every seven years. It takes twenty-five painters between fifteen and eighteen months to complete the work.

La tour Eiffel est repeinte tous les sept ans, et 25 peintres mettent entre 15 et 18 mois pour la repeindre.



© eiffel-tower.com

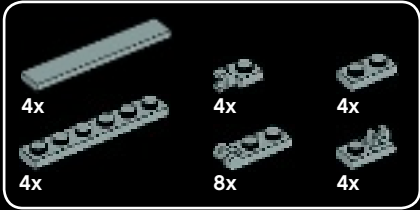

3

1

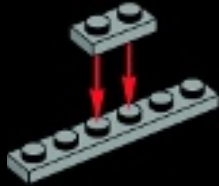

2



3

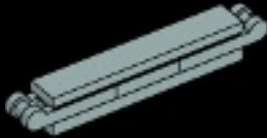

4

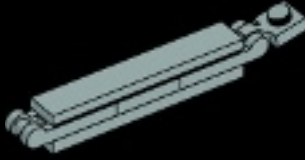

5

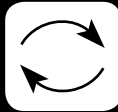
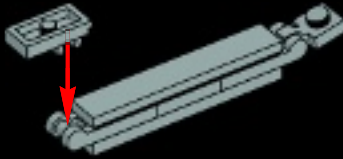

6

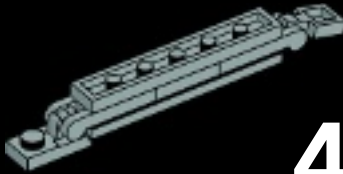

4x

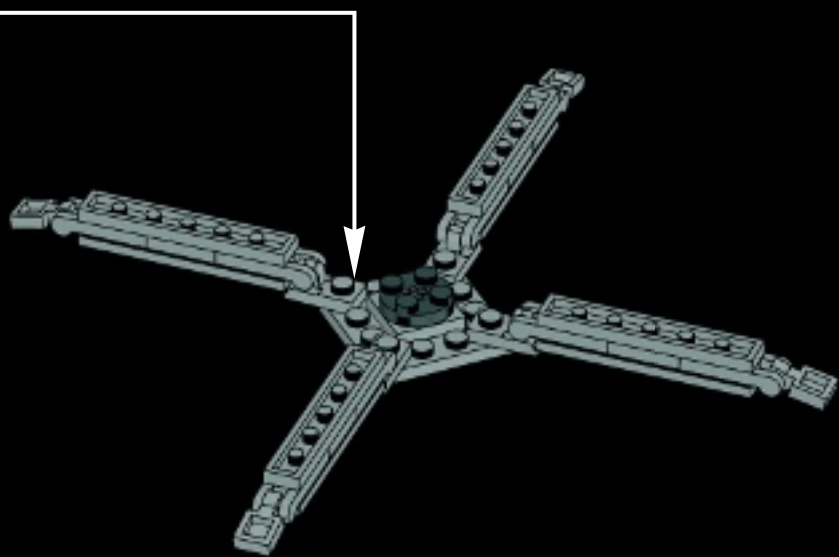



1x

4

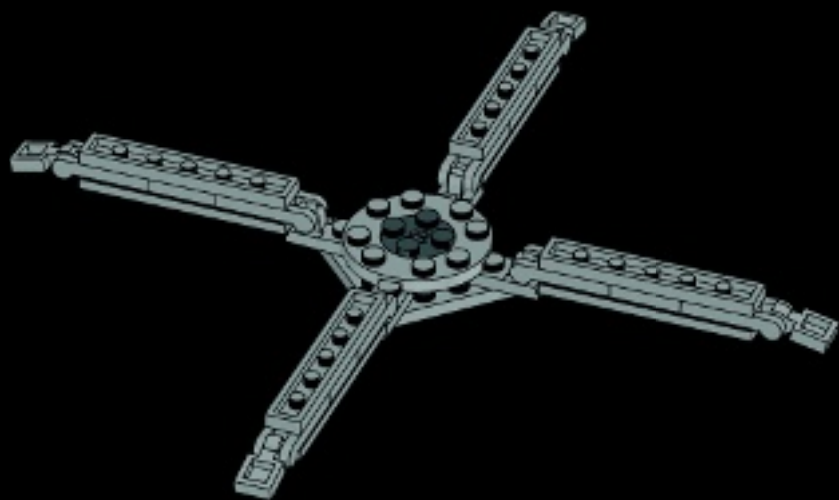



1x



2x

5

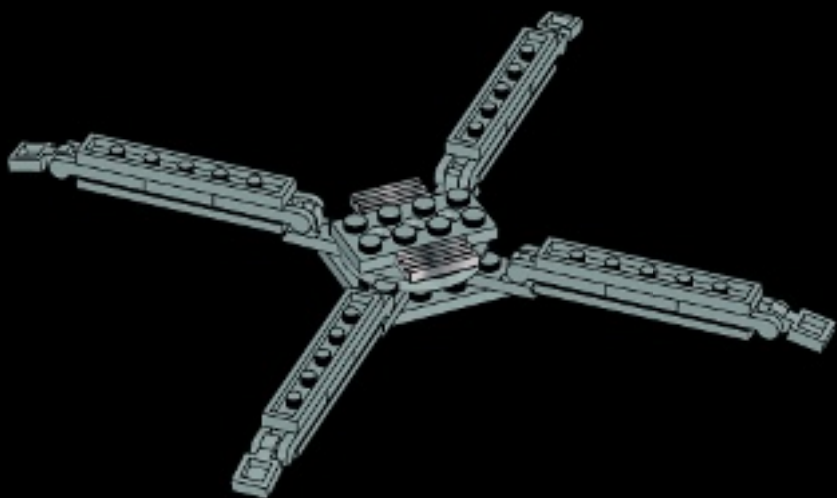



6

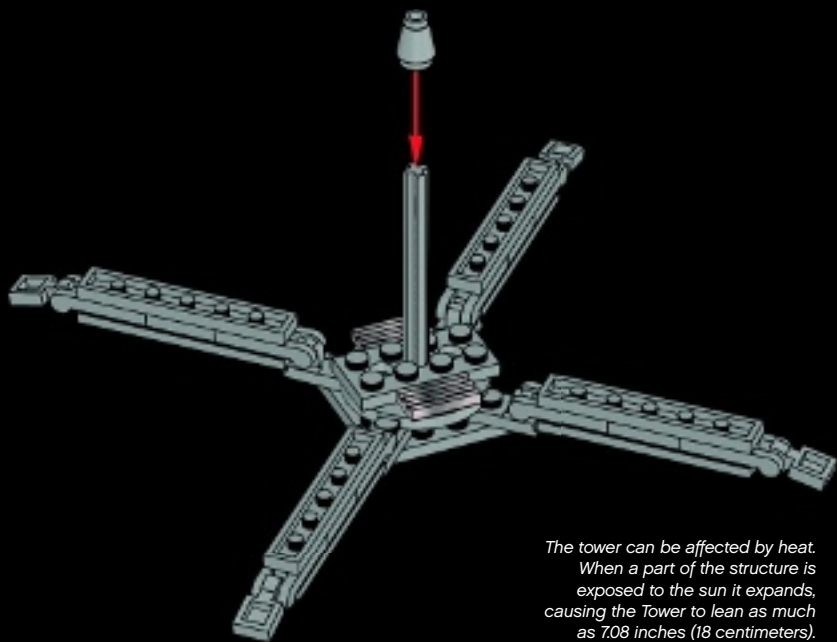

The tower can be affected by heat. When a part of the structure is exposed to the sun it expands, causing the Tower to lean as much as 7.08 inches (18 centimeters).

La Tour peut être affectée par la chaleur. Lorsqu'une partie de la structure est exposée au soleil, elle se dilate, entraînant une inclinaison de la Tour allant jusqu'à 18 cm.



© Shutterstock



1x



4x



4x

7

1



2



3

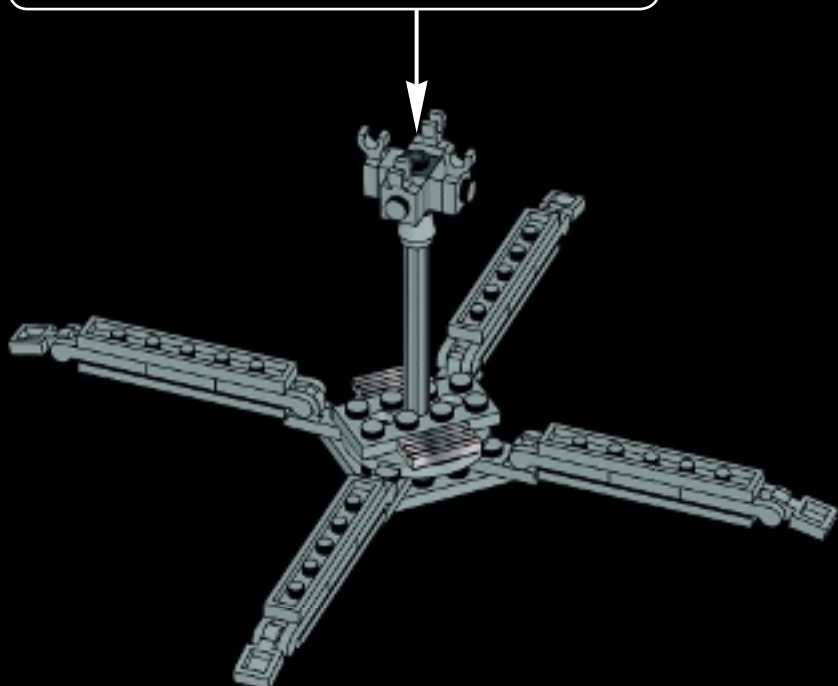

8

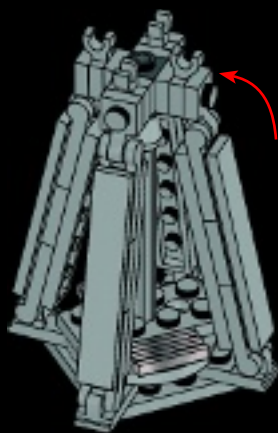

If the 8,047 tons (7,300 metric tons) of the metal structure were melted down, it would fill the 125-meter-square base to a depth of only 2.36 inches (6 centimeters).

Si les 7 300 tonnes de la structure métallique étaient fondues, elles rempliraient la base de 125 mètres carrés avec une profondeur de 6 cm seulement.



© Shutterstock

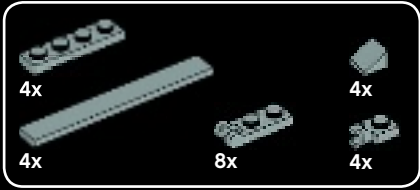

9

1



2

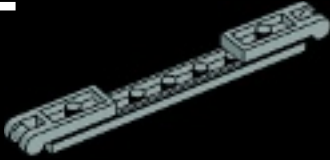

3

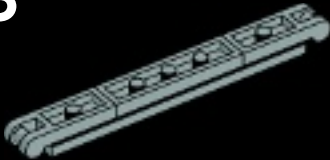

4

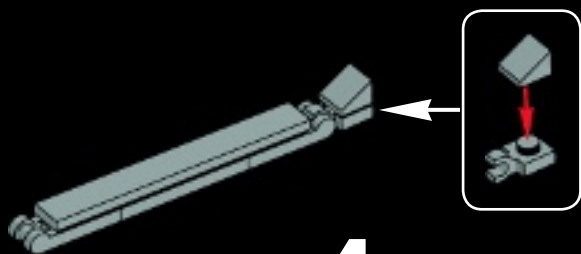

4x

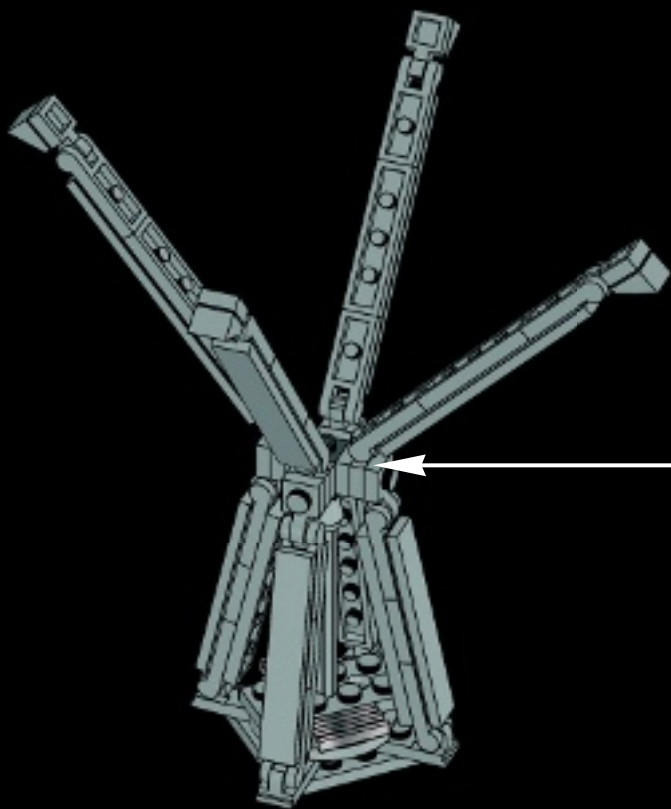



1x

10



11

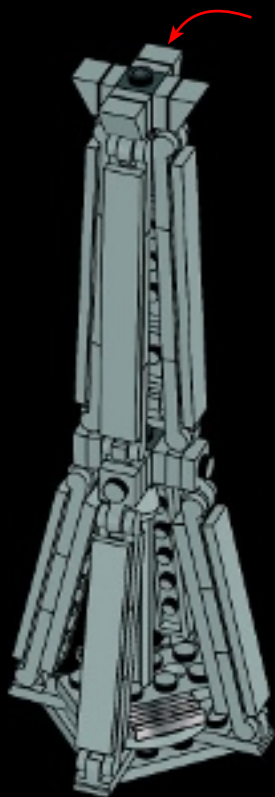

The tower remains the tallest structure in Paris, and from 1889 to 1930 was the tallest structure in the world.

La Tour reste la structure la plus haute de Paris et de 1889 à 1930 elle fut la plus haute structure du monde.



© Shutterstock

14

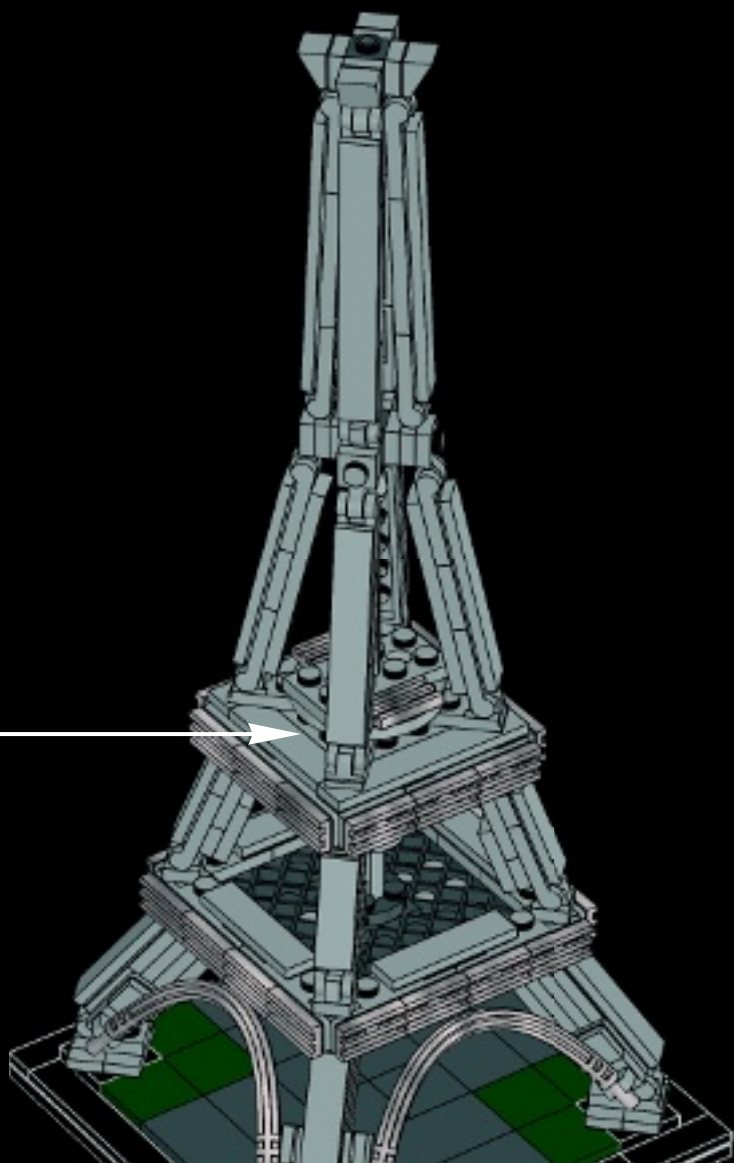



15

1



2



3



In order to enhance the impression of height, three separate colors of paint are used on the tower, with the darkest on the bottom and the lightest at the top.

Afin de renforcer l'impression de hauteur, trois couleurs de peinture différentes sont utilisées sur la Tour, la plus foncée à la base et la plus claire au sommet.



© Shutterstock

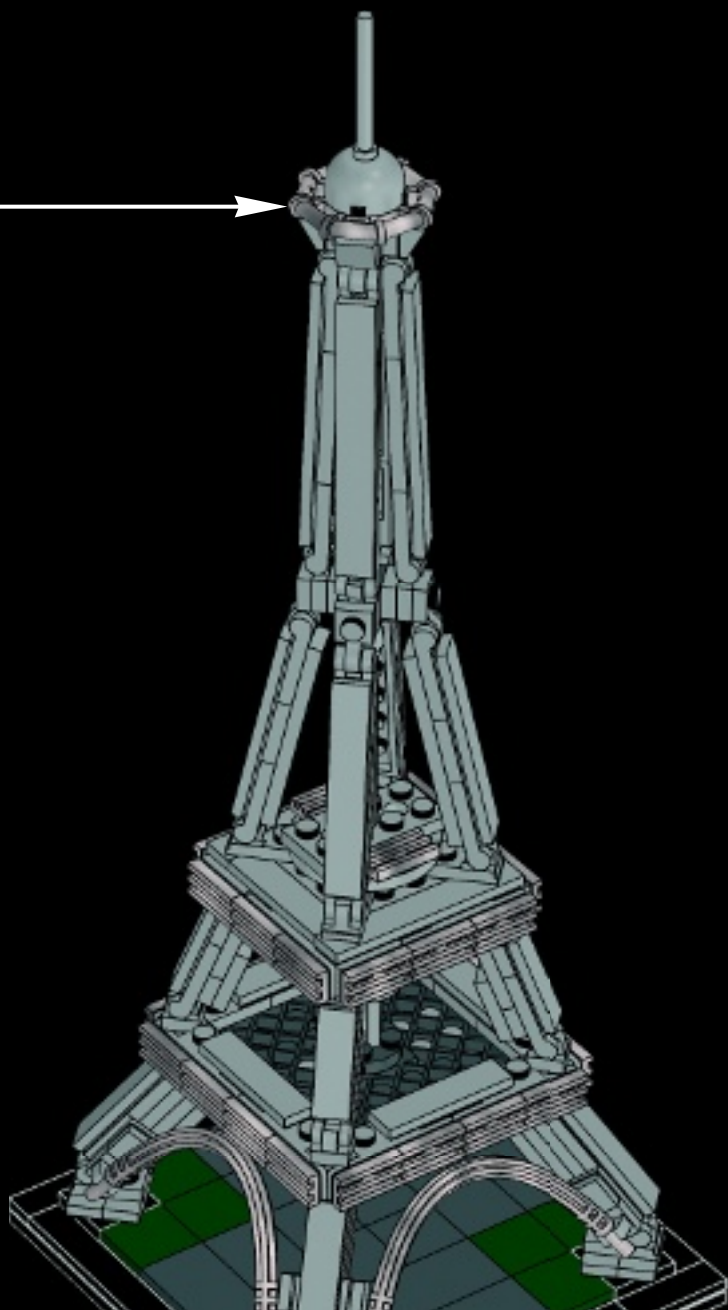

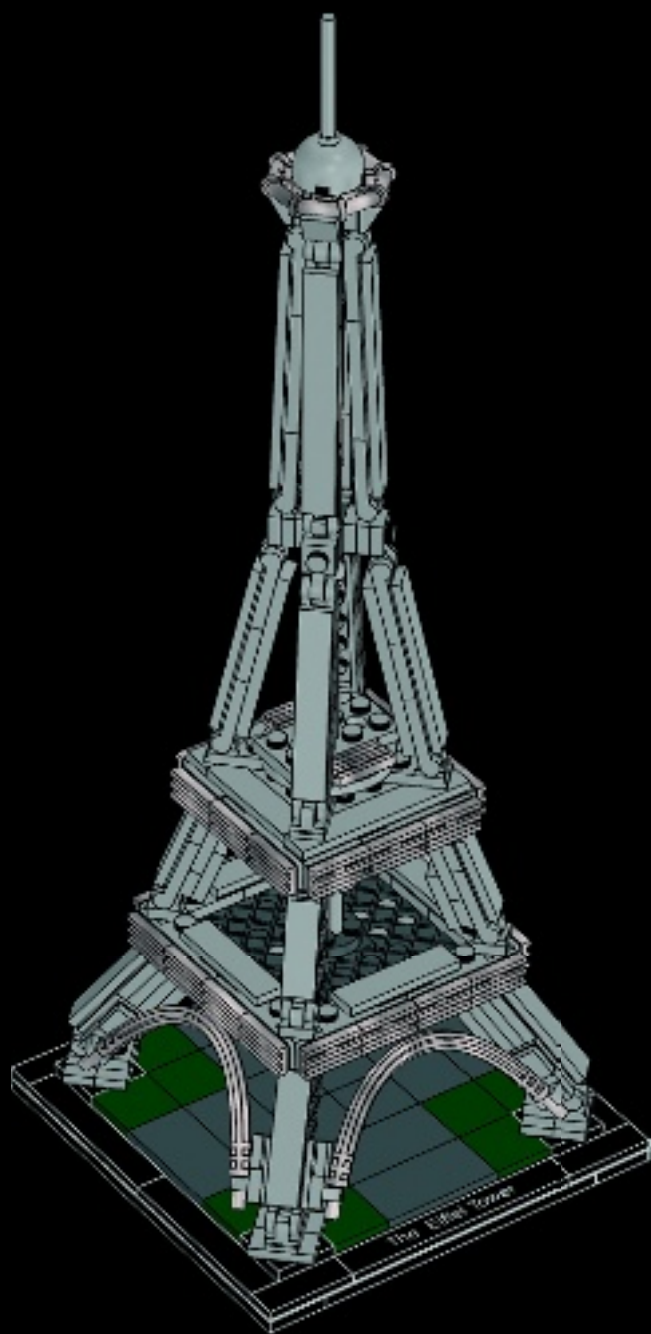

The “Scale Model” line – LEGO® Architecture in the 1960s

The history of the current LEGO® Architecture series can be traced back to the beginning of the 1960s, when the popularity of the LEGO brick was steadily increasing. Godtfred Kirk Christiansen, the then owner of the company, began looking for ways to further expand the LEGO system and asked his designers to come up with a set of components that would add a new dimension to LEGO building.

Their answer was as simple as it was revolutionary: five elements that matched the existing bricks, but were only one-third the height. These new building “plates” made it possible to construct more detailed models than before.

This greater LEGO flexibility seemed to match the spirit of the age; modernist architects were redefining how houses looked, and people were taking an active interest in the design of their dream home. It was from these trends that the LEGO “Scale Model” line was born in early 1962.

The name itself was a direct link to the way architects and engineers worked, and it was hoped that they and others would build their projects “to scale” in LEGO elements. As with LEGO Architecture today, the original sets were designed to be different from the normal, brightly colored LEGO boxes, and also included “An Architectural Book” for inspiration.

Though the five elements remain an integral part of the LEGO building system today, the “Scale Model” line was phased out in 1965. Many of the principles from the series would re-emerge over forty years later in the LEGO Architecture Series we know today.



La gamme « Maquettes à l'échelle » - LEGO® Architecture dans les années 1960

L'histoire de l'actuelle série LEGO® Architecture remonte au début des années 1960 lorsque la popularité de la brique LEGO augmentait toujours. Godtfred Kirk Christiansen, alors propriétaire de la société, commença à rechercher des façons d'étendre le système LEGO et demanda à ses designers de trouver un ensemble de nouveaux composants pour ajouter une nouvelle dimension à la construction LEGO.

Leur réponse fut aussi simple que révolutionnaire : cinq éléments qui correspondaient aux briques existantes, mais trois fois moins hauts. Ces nouvelles « plaques » de construction ont permis de construire des modèles plus détaillés que par le passé.

Cette plus grande flexibilité LEGO semblait correspondre à l'esprit de l'époque, alors que les architectes modernes redéfinissaient les maisons, et que les gens s'intéressaient activement à la conception de la maison de leurs rêves. C'est à partir de ces tendances que la gamme « Maquettes à l'échelle » vit le jour au début de 1962.

Le nom lui-même était un lien direct avec la façon dont les architectes et les ingénieurs travaillaient, en espérant qu'ils allaient, ainsi que d'autres, construire leurs projets « à l'échelle » avec des éléments LEGO. Comme avec LEGO Architecture aujourd'hui, les ensembles originaux étaient conçus pour être différents des boîtes LEGO normales aux couleurs vives, et incluaient aussi « un livret d'architecture » comme source d'inspiration.

Ces cinq éléments font toujours partie du système de construction LEGO actuel mais la gamme « Maquettes à l'échelle » fut interrompue en 1965. Il fallut 40 ans pour que ses principes reprennent vie dans la série LEGO Architecture que nous connaissons aujourd'hui.



Architect Series

Série Architecture

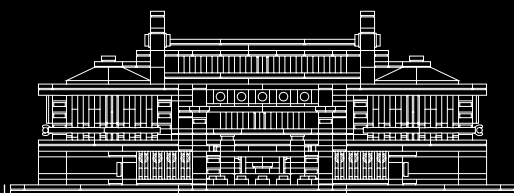

21017
Imperial Hotel
L' Hôtel Impérial

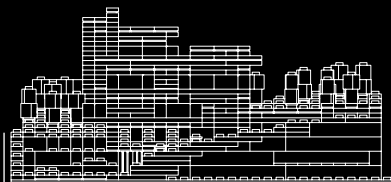

21005
Fallingwater®

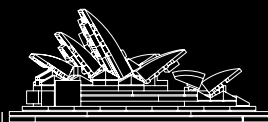

21012
Sydney Opera House™

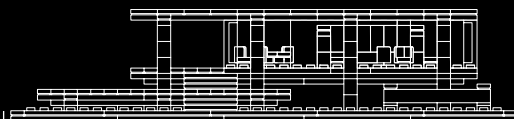

21009
Farnsworth House™

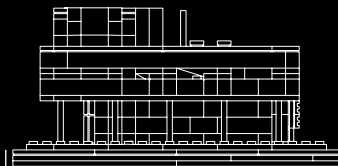

21014
Villa Savoye

Landmark Series

Série Édifices historiques

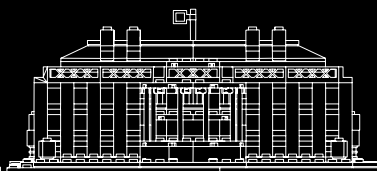

21006
The White House
La Maison-Blanche

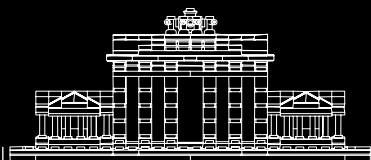

21011
Brandenburg Gate
La porte de Brandebourg

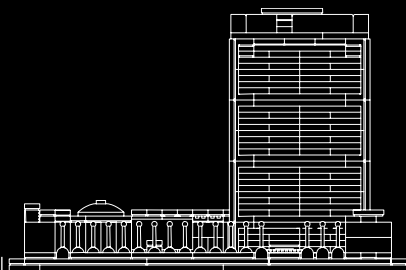

21018
United Nations Headquarters
Le siège des Nations Unies



21003
Seattle
Space Needle

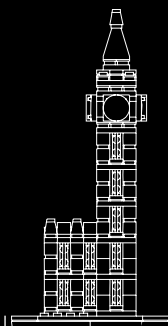

21013
Big Ben

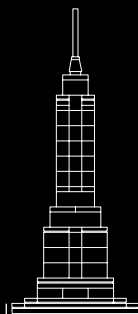

21002
Empire State Building

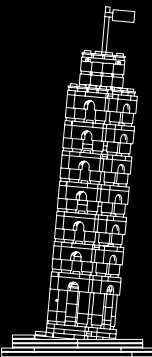

21015
The Leaning Tower of Pisa
La tour penchée de Pise

References

Text credits:

www.tour-eiffel.fr

en.wikipedia.org

Photo credits:

www.shutterstock.com

www.gettyimages.com

en.wikipedia.org

Références

Crédits textes :

www.tour-eiffel.fr

en.wikipedia.org

Crédits photos :

www.shutterstock.com

www.gettyimages.com

en.wikipedia.org

Customer Service
Kundenservice
Service Consommateurs
Servicio Al Consumidor

LEGO.com/service or dial



00800 5346 5555 :



1-800-422-5346 :





Architecture

LEGO and the LEGO logo are trademarks of the/sonit, des marques de commerce
de/son marcas registradas de LEGO Group. ©2014 The LEGO Group. 6089600



LEGO.com/architecture