



CLASSIC

11022





We're switching from plastic to paper-based packaging. That's why you might find a mix of paper and plastic in our boxes!

Wir stellen von Kunststoffverpackungen auf Verpackungen auf Papierbasis um. Möglicherweise findest du deshalb sowohl Papier als auch Kunststoff in unseren Boxen!

Nous abandonnons progressivement les emballages en plastique au profit d'emballages à base de papier. Il est donc possible que vous trouviez à la fois du papier et du plastique dans nos boîtes !

Stiamo passando dagli imballaggi di plastica a quelli basati su carta. Ecco perché potreste trovare un mix di carta e di plastica nelle nostre confezioni!

Estamos sustituyendo las bolsas de plástico por bolsas con base de papel. ¡Por eso, puede que encuentres una mezcla de papel y de plástico en nuestras cajas!

Estamos a substituir as nossas embalagens de plástico por embalagens à base de papel. Por isso poderá encontrar um misto de papel e plástico nas nossas caixas!

Átállunk a műanyagról a papír alapú csomagolásra. Ezért előfordulhat, hogy a dobozainkban papír és műanyag zacskót egyaránt találsz!

Mēs pāejam no plastmasas iepakojuma uz iepakojumu, kurā izmantots papīrs. Tāpēc mūsu kārbās var būt gan papīra, gan plastmasas daļas.

Trecem de la ambalajele din material plastic la ambalaje pe bază de hârtie. Iată de ce s-ar putea să găsești un amestec de hârtie și material plastic în cutiile noastre!

我们正在从塑料包装向纸基包装过渡。这就是为什么你可能会发现我们的包装盒中同时出现塑料和纸质材料！

[LEGO.com/sustainable-packaging](https://www.LEGO.com/sustainable-packaging)



乐高®拼搭指引

LEGO® Building Instructions



Check for compatibility
Kompatibilität prüfen
Vérifier la compatibilité
Controla la compatibilitat
Comprueba tu compatibilidad
Verificar a compatibilidade
Ellenőrizd a kompatibilitást
Pärbaudīt saderību
Verificarea compatibilității
检查兼容性

[LEGO.com/devicecheck](https://www.lego.com/devicecheck)

Apple and the Apple logo are trademarks of Apple Inc.
Google Play and the Google Play logo are trademarks of Google LLC.
Tencent and the Tencent logo are trademarks of Tencent Inc.

Page
8



Page
16

Page
12



Page
Seite
Pagina
Página
Oldalszám
Lpp.
页码



Page
20



Page
30





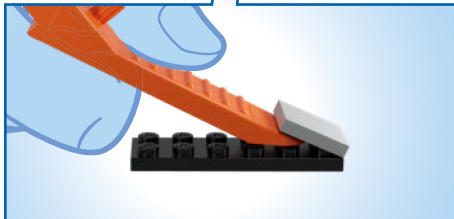
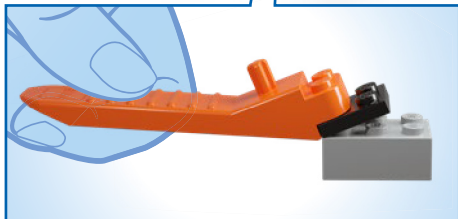
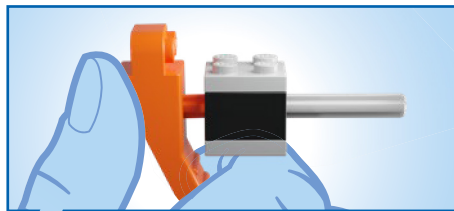
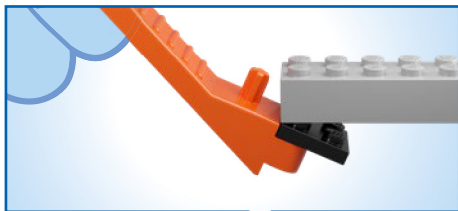





1x



1x

1

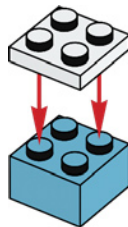

2x

2

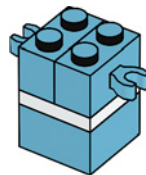



1x



1x

3

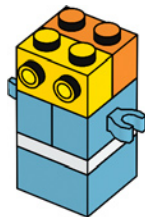

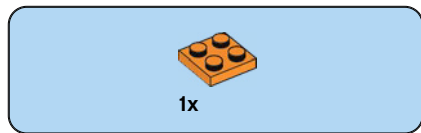

4

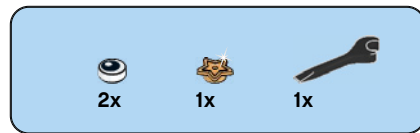
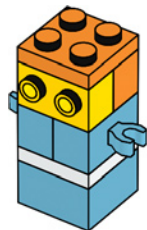

5

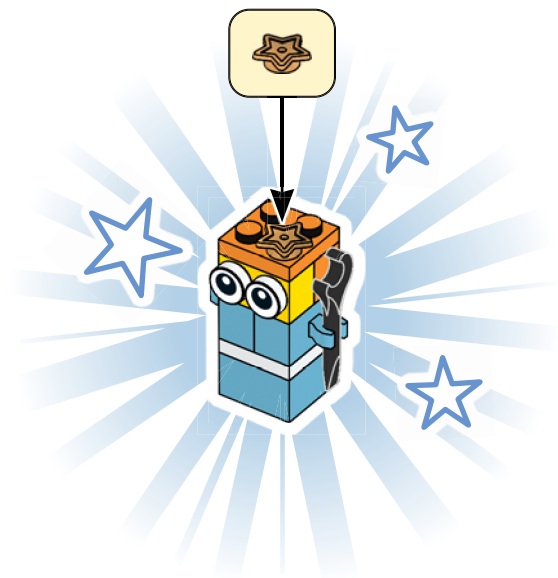



1x



1x

1

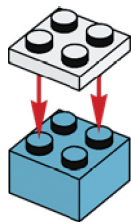



2x

2

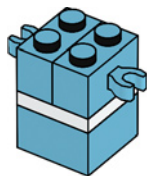

1x



1x

3

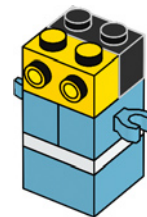



1x

4

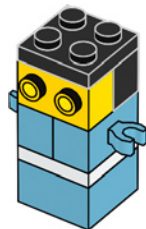



2x

5

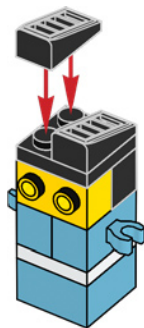

1x



2x

6

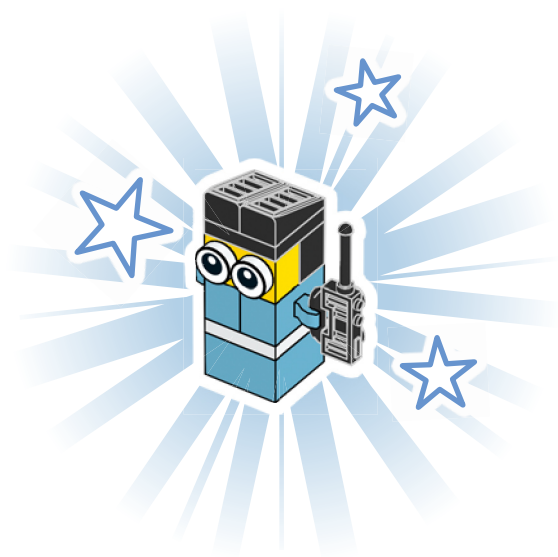

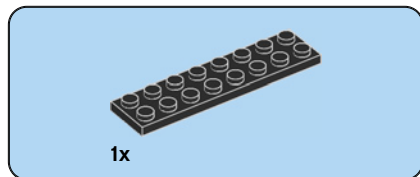

1



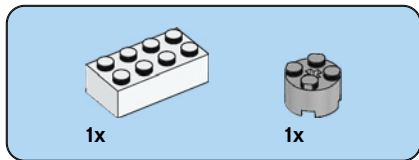

2

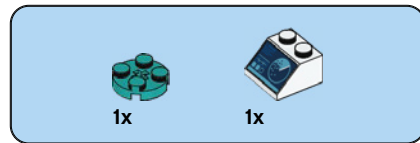
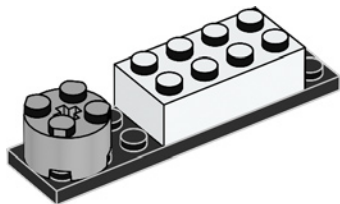

3

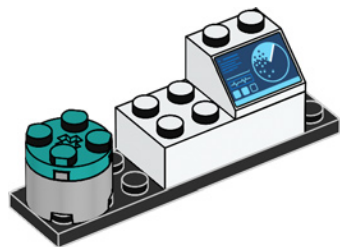



1x



1x

4

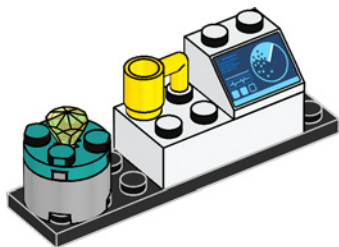



5

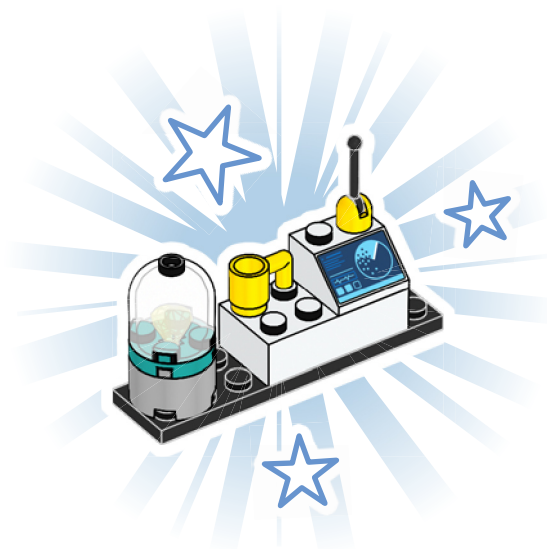

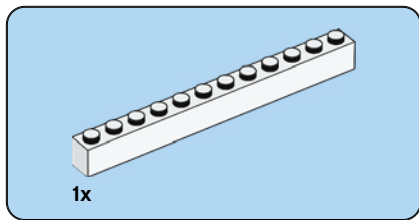

1

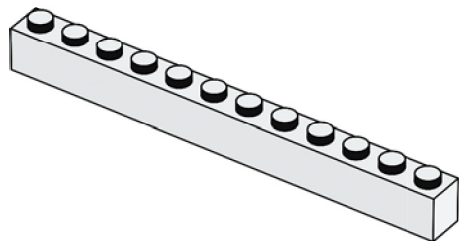

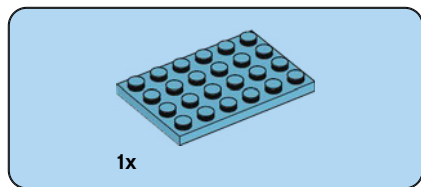

2

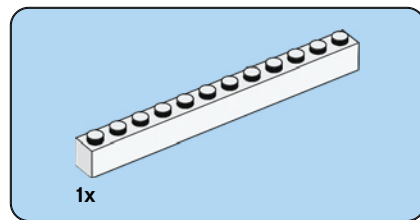
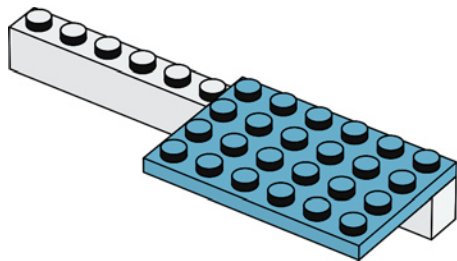

3

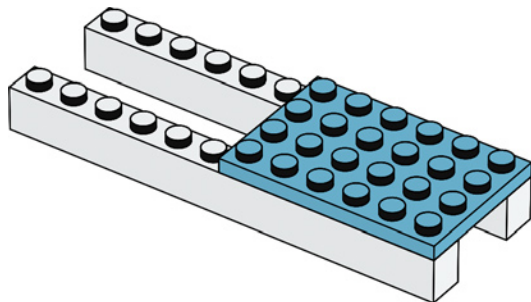

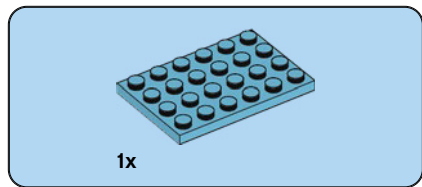

4

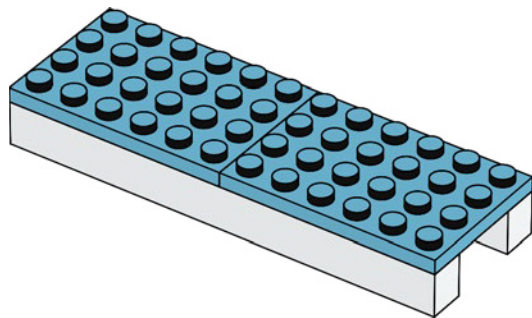

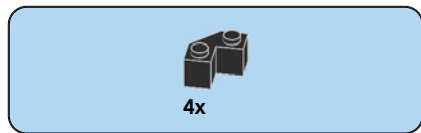

5

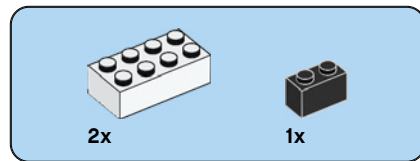
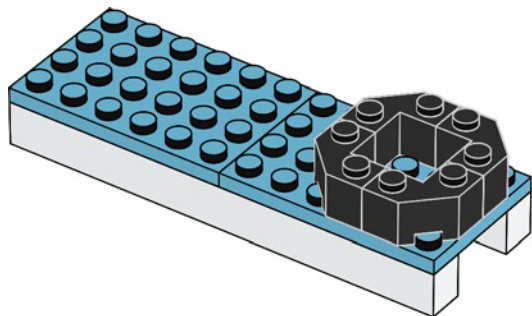

6

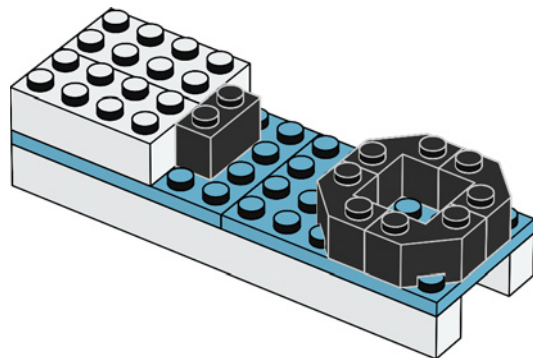

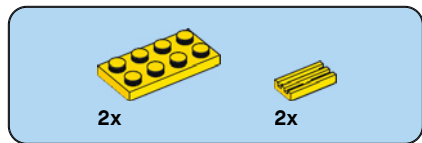

7

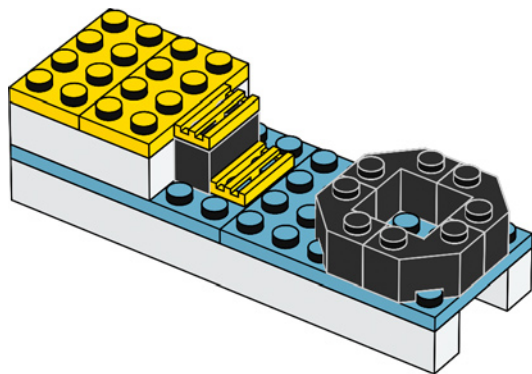

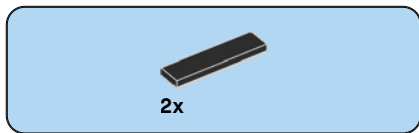

8

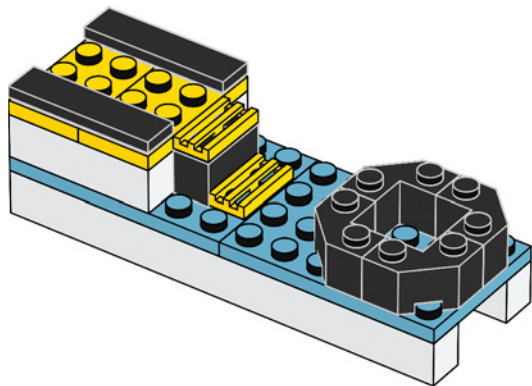

9

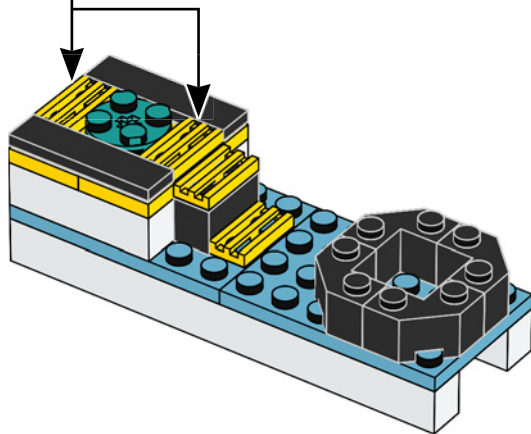
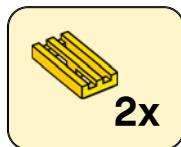

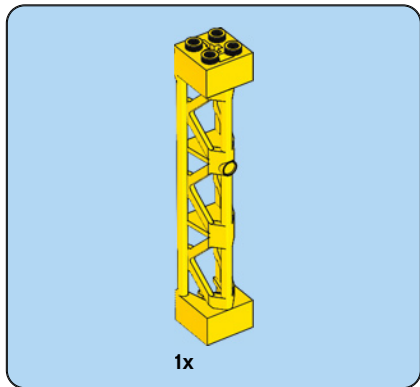
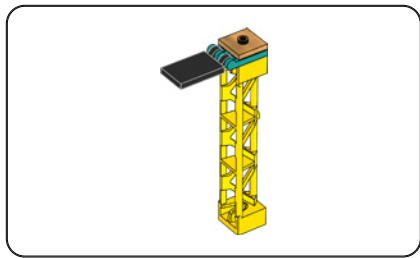

10

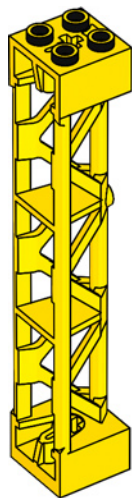



2x

11

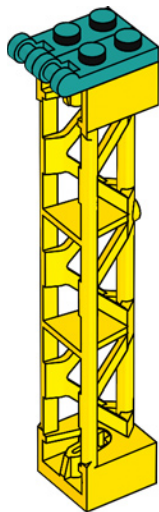

1x

12

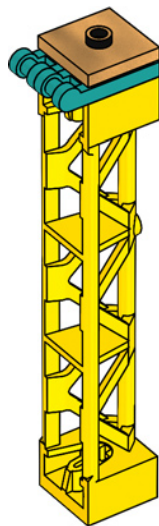

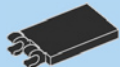

1x

13

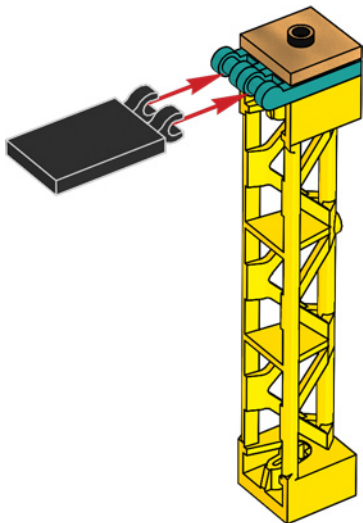

14

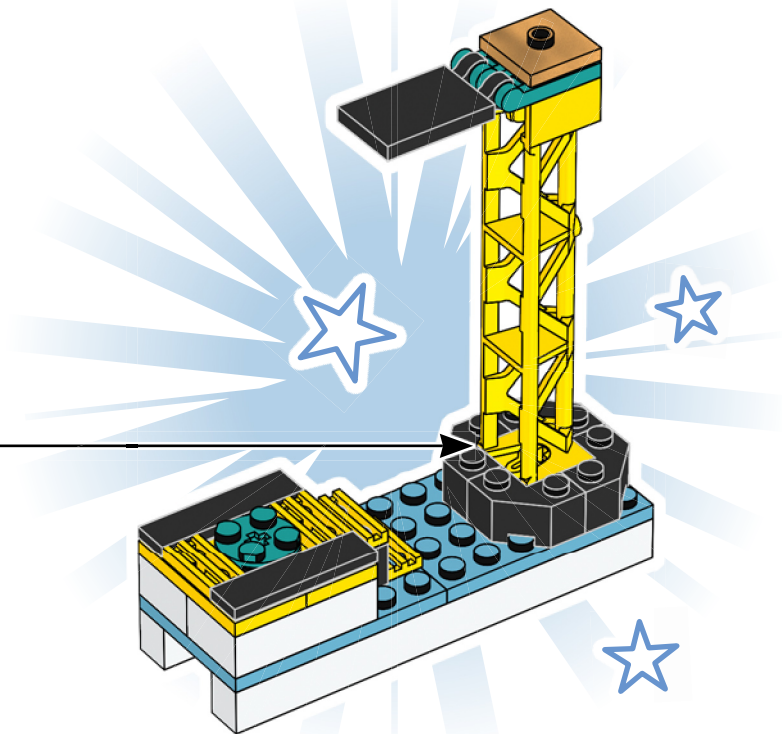

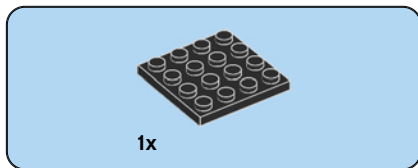

1

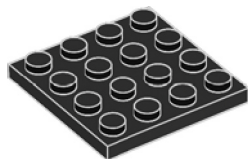

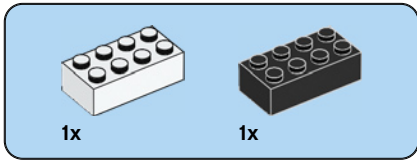

2



3

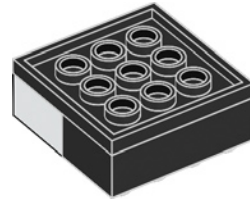
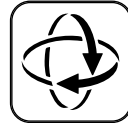



4x

4

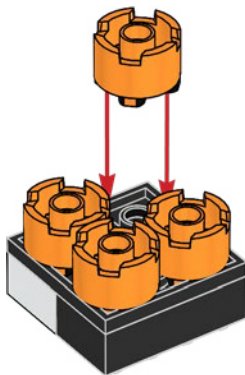

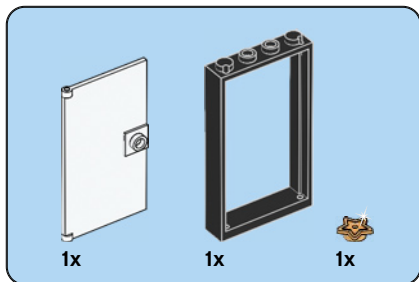

5

1

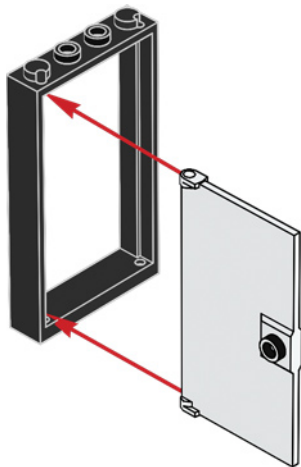

2

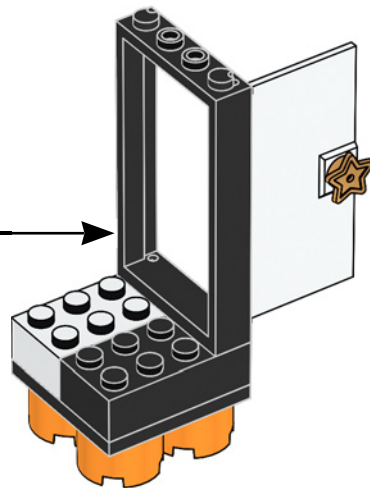

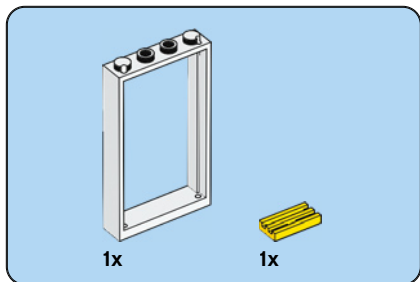

6

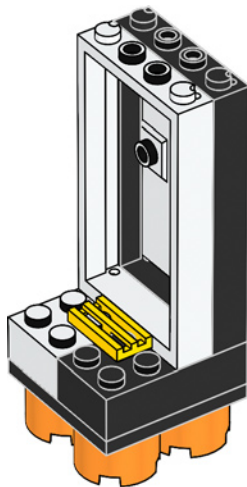

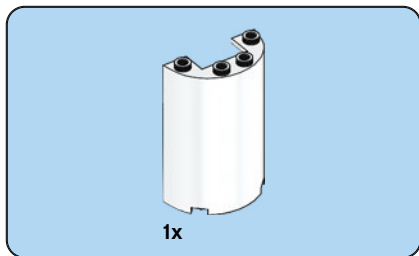

7

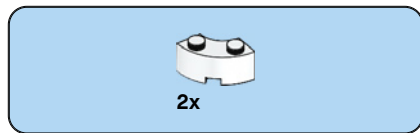

8

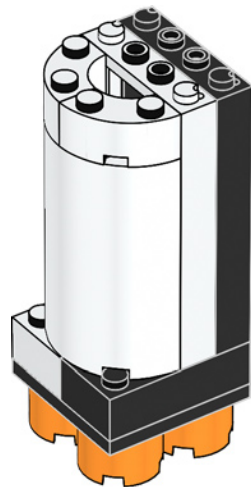

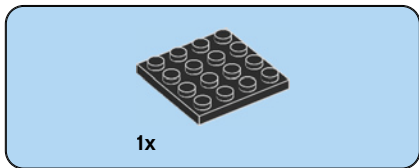

9

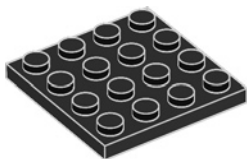

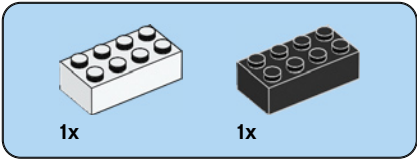

10



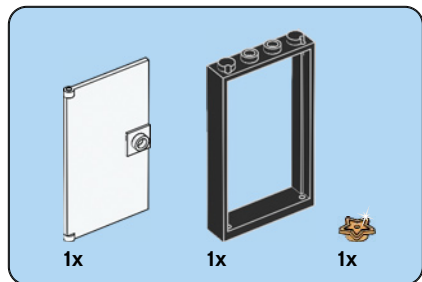

11

1

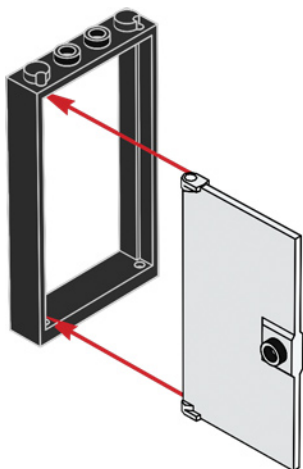

2

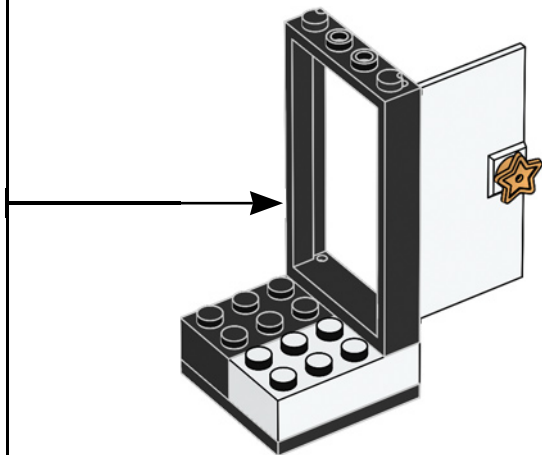
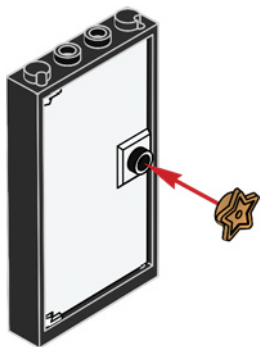

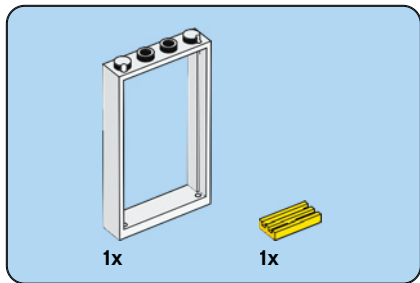

12

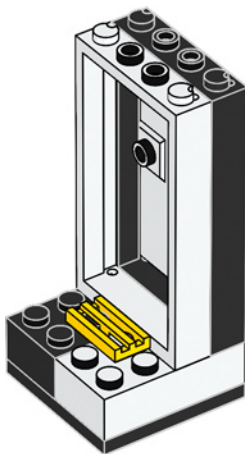

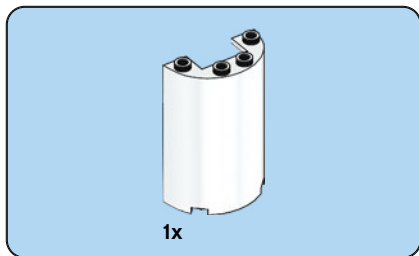

13

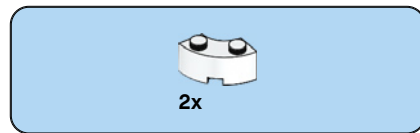
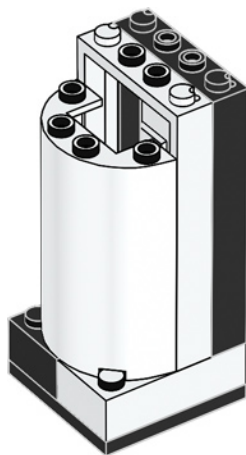

14



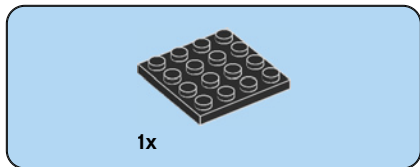

15





1x

16



2x



2x

17



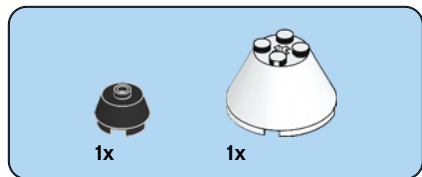

18

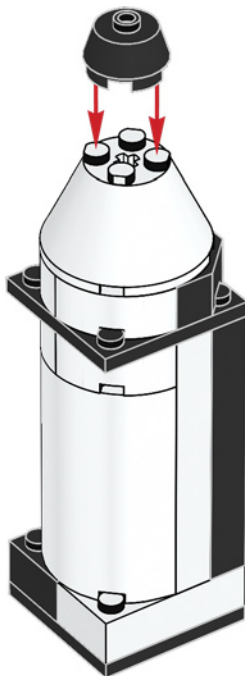

19



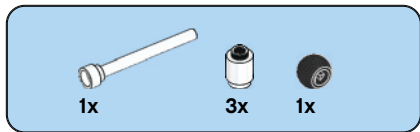

20

1



2



3



4

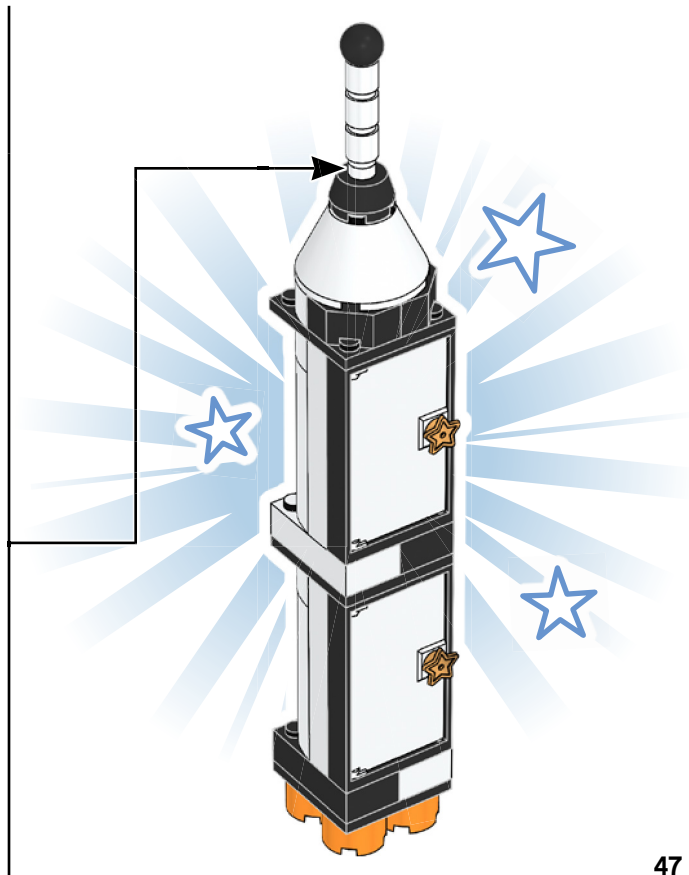

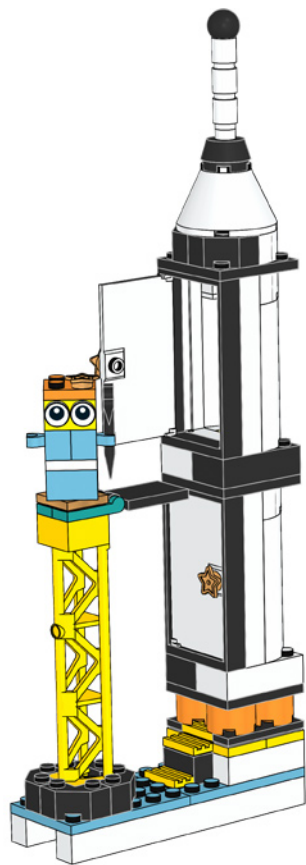

What else can you build?

What else can you build?
Was kannst du noch bauen?
Que peux-tu encore construire ?
Cos'altro puoi costruire?
¿Qué más puedes construir?
Que mais consegues construir?
Mit tudnál még építeni?
Ko vēl tu vari uzbūvēt?
Ce altceva poți construi?
还能拼搭些什么呢?

For more inspiration visit
Finde weitere Inspirationen unter
Pour plus d'inspiration, visitez
Per tante altre idee, visita
Para más ideas, visita
Para mais inspiração visita
További inspirációért látogass el ide:
Vairāk iedvesmas meklē vietnē
Pentru mai multă inspirație vizitează
更多灵感, 请访问:
LEGO.com/classic



What else can you build?

What else can you build?
Was kannst du noch bauen?
Que peux-tu encore construire ?
Cos'altro puoi costruire?
¿Qué más puedes construir?
Que mais consegues construir?
Mit tudnál még építeni?
Ko vēl tu vari uzbūvēt?
Ce altceva poți construi?
还能拼搭些什么呢?



For more inspiration visit
Finde weitere Inspirationen unter
Pour plus d'inspiration, visitez
Per tante altre idee, visita
Para más ideas, visita
Para mais inspiração visita
További inspirációért látogass el ide:
Vairāk iedvesmas meklē vietnē
Pentru mai multă inspirație vizitează
更多灵感, 请访问:
LEGO.com/classic



4

What else can you build?

What else can you build?
Was kannst du noch bauen?
Que peux-tu encore construire ?
Cos'altro puoi costruire?
¿Qué más puedes construir?
Que mais consegues construir?
Mit tudnál még építeni?
Ko vēl tu vari uzbūvēt?
Ce altceva poți construi?
还能拼搭些什么呢？



For more inspiration visit
Finde weitere Inspirationen unter
Pour plus d'inspiration, visitez
Per tante altre idee, visita
Para más ideas, visita
Para mais inspiração visita
További inspirációért látogass el ide:
Vairāk iedvesmas meklē vietnē
Pentru mai multă inspirație vizitează
更多灵感, 请访问:
LEGO.com/classic

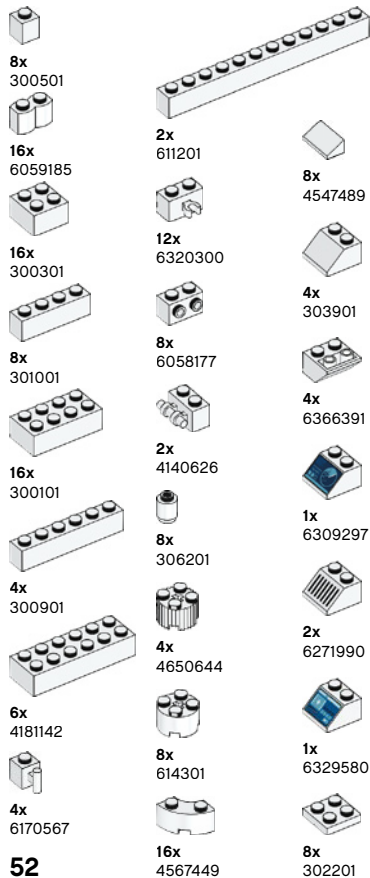

52

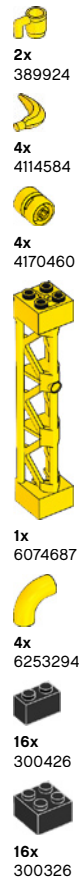
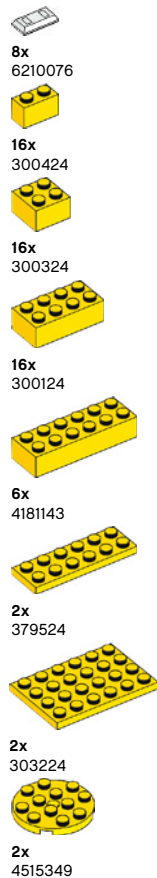
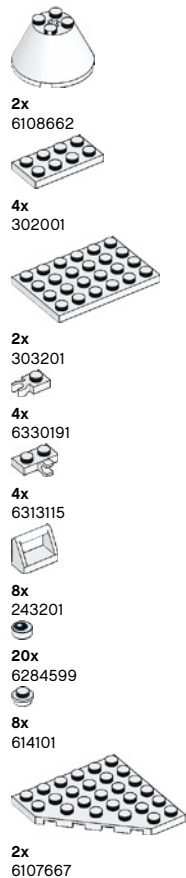



8x
301026



16x
300126



6x
4181144



4x
6170566



8x
6330197



8x
6138173



2x
4288212



8x
306226



4x
4653822



8x
614326



12x
4584274



4x
4618880



4x
4581280



8x
4290713



8x
302226



4x
302126



4x
243126



4x
4243819

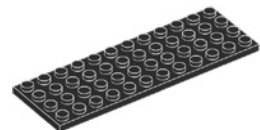

2x
302926



2x
303426



4x
6330189



8x
6196548



4x
6336989



2x
6360129



1x
6187587



4x
6382697



8x
6326681



2x
6170545



1x
4106552



2x
434926



2x
400626



2x
6382249



4x
4568644



2x
6337273



4x
6255875



2x
4660876



4x
6106280



8x
4541191



4x
6321194



4x
4141580



8x
6156991



2x
6325525



2x
6408022



16x
4647553



8x
6310856



8x
6331100



2x
6182664



8x
6314378



4x
6357612

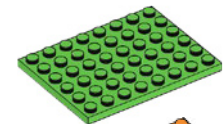

1x
6340684



4x
6141590



2x
6399741



4x
6138624



8x
6182261



4x
4143562



4x
6331087



4x
4119479



8x
4173805



16x
4121739



16x
4153825



8x
4118827



16x
4153827



8x
4518029



8x
4141089



8x
6068996



4x
4616279



4x
4118828



2x
6287382



4x
4159007



4x
6267125



4x
6103249



8x
6149656



1x
6240515



1x
6131694

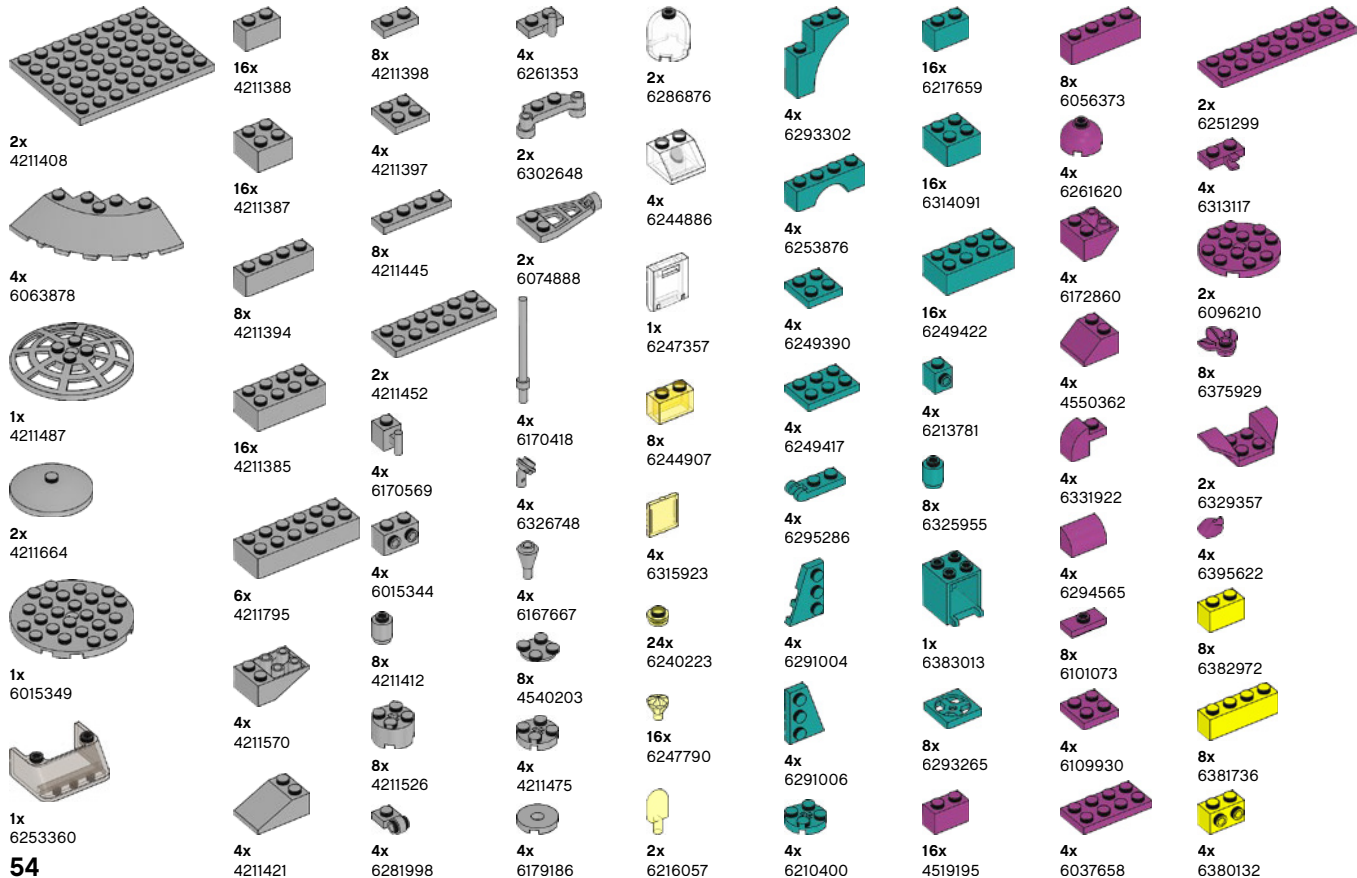



4x
6380129



4x
6382805



8x
6382324



4x
6388037



4x
6381708



2x
6388225



8x
6403130



16x
4653960



16x
4626935



4x
6310169



8x
6070305



4x
6133921



4x
6331924



4x
6293404



4x
6047422



16x
6104154

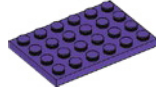

2x
6147032



4x
6270093



8x
6394865



8x
6186383



4x
6262138



8x
6335111



4x
6337403



4x
6295686



4x
6290401



42x
6184647



2x
6138068



4x
6214208



4x
6171138



4x
6296657



4x
6107389



4x
6222063



4x
6046398



2x
6320173



16x
6092674



16x
4653970



8x
4619652



8x
6036238



16x
4625629



6x
6022000



4x
6391117



8x
6224282



4x
6070769



4x
6173655



4x
6335566



4x
6357619



8x
6097419



8x
4625032



8x
6070757



4x
4655256



2x
4619515



16x
6258572



4x
6261292



4x
6261293



2x
6174592



4x
6294492



8x
6258094



4x
6305455



4x
6284154



8x
6295242



8x
6375789



4x
6399743

Customer Service
 Kundenservice
 Service Client
 Assistenza clienti
 Atención al cliente
 Serviço de Apoio ao Consumidor
 Ügyfélszolgálat
 Klientu apkalpošanas dienests
 Serviciul pentru clienți
 客户服务
 コンシューマーサービス
 고객 서비스

LEGO.com/service

WIN

Terms & Conditions apply

Scan this QR code or go to **LEGO.COM/PRODUCTFEEDBACK** and give us your short feedback about this LEGO® set for a chance to win a cool LEGO prize.



GEWINNE

Scanne diesen QR-Code oder geh auf LEGO.COM/PRODUCTFEEDBACK

und gib uns dein kurzes Feedback zu diesem LEGO® Set. Dann hast du die Chance, einen coolen LEGO Preis zu gewinnen.

Es gelten die Teilnahmebedingungen

GAGNE

Scannez ce code QR ou rendez-vous sur LEGO.COM/PRODUCTFEEDBACK

pour donner votre avis sur ce produit LEGO® et avoir une chance de gagner un prix LEGO.

Voir Conditions Générales

GANAN

Escanea este código QR o visita LEGO.COM/PRODUCTFEEDBACK

y comparte con nosotros tu opinión sobre este set LEGO® para tener la oportunidad de ganar un fantástico premio LEGO.

Términos y Condiciones aplicables

获取奖品

只需扫描此二维码或访问 LEGO.COM/PRODUCTFEEDBACK,

就这款乐高®套装提供简短反馈,就有机会赢得很酷的乐高奖品。

《条款及条件》适用

LEGO and the LEGO logo are trademarks of the LEGO Group. ©2022 The LEGO Group.

6420248