

LEGO

duplo

**SON ET
LUMIERE**

**LUZ Y
SONIDOS**



**LIGHT &
SOUND**



10903

LEGO.com/DUPLO



duplo



10886
Ages 1½+



10871
Ages 2+



Ages/edades

1½



10847
Ages 1½+



10903
Âges 2+



10902
Âges 2+



10900
Âges 2+

**SON ET
LUMIERE**

**LUZ Y
SONIDOS**

5



duplo

**CONSTRUIRE ET
CRÉER DES LIENS**

CREATE & CONNECT



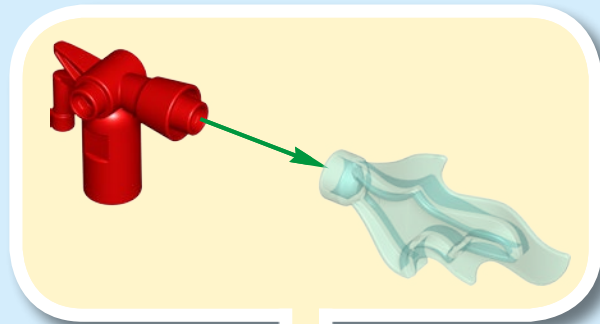

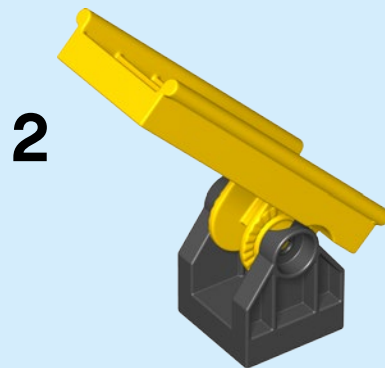
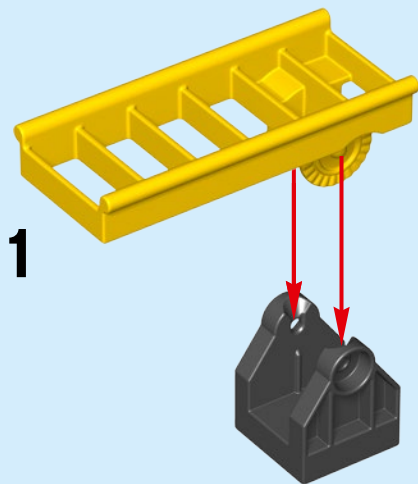
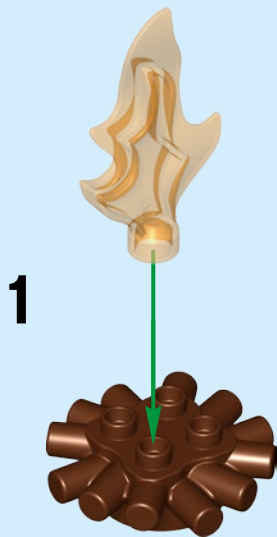
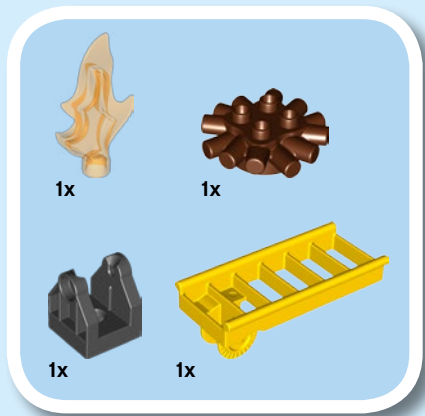

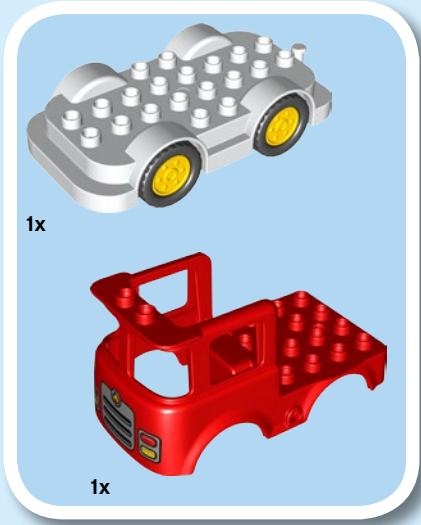

1

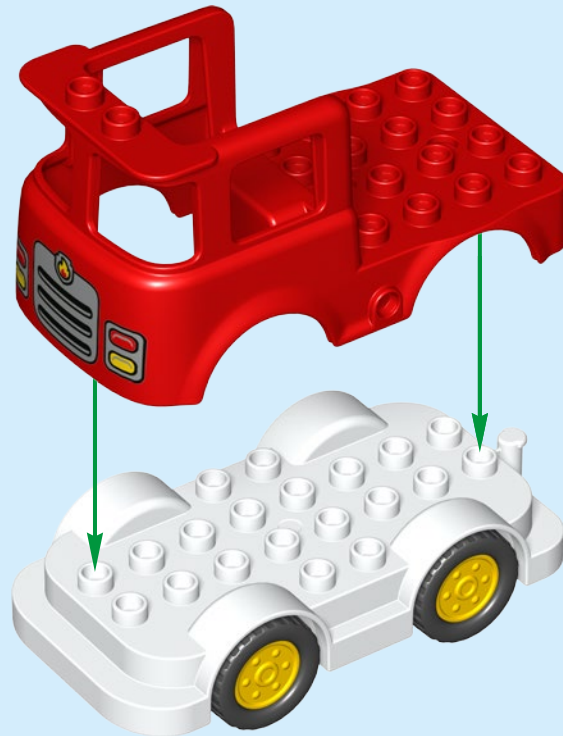

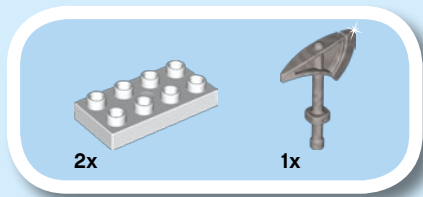

2

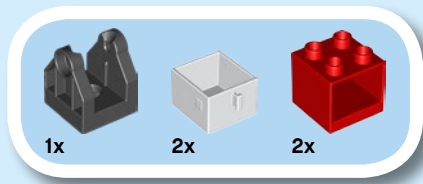

3

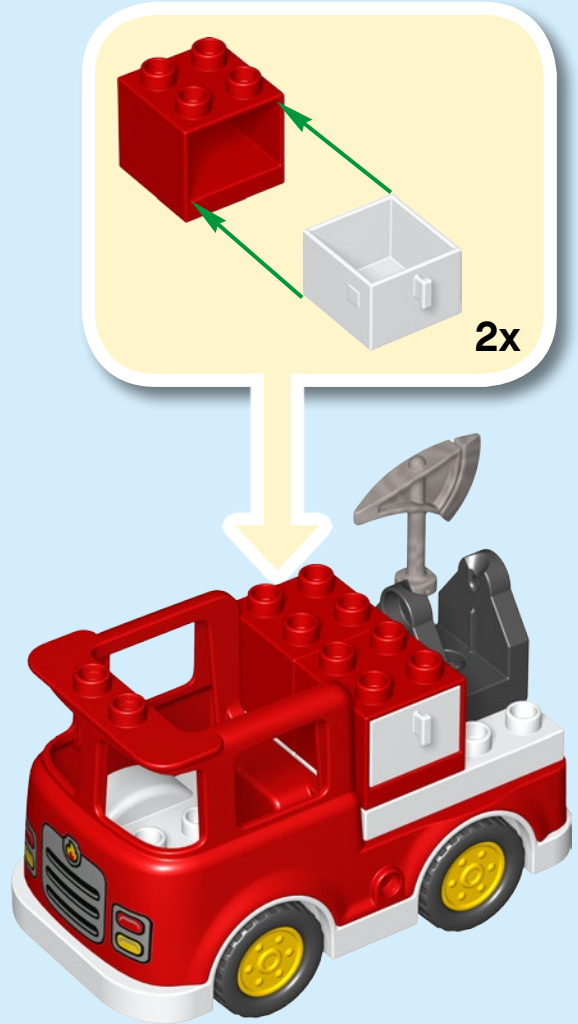

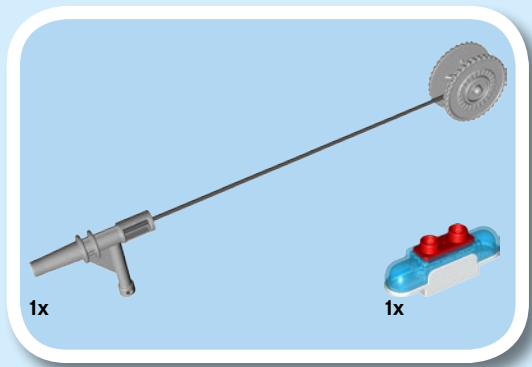

4



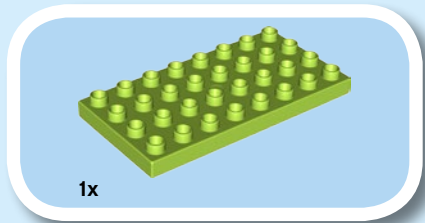

1

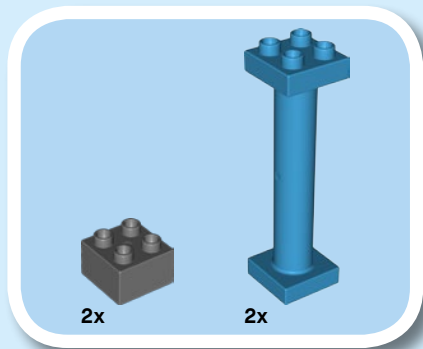
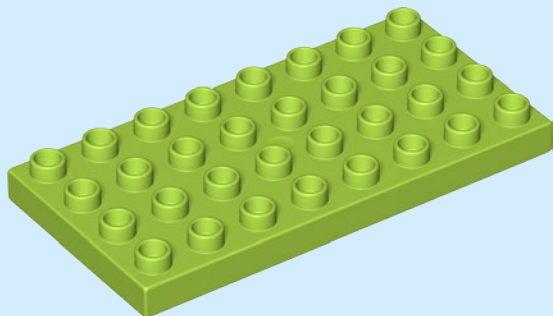

2

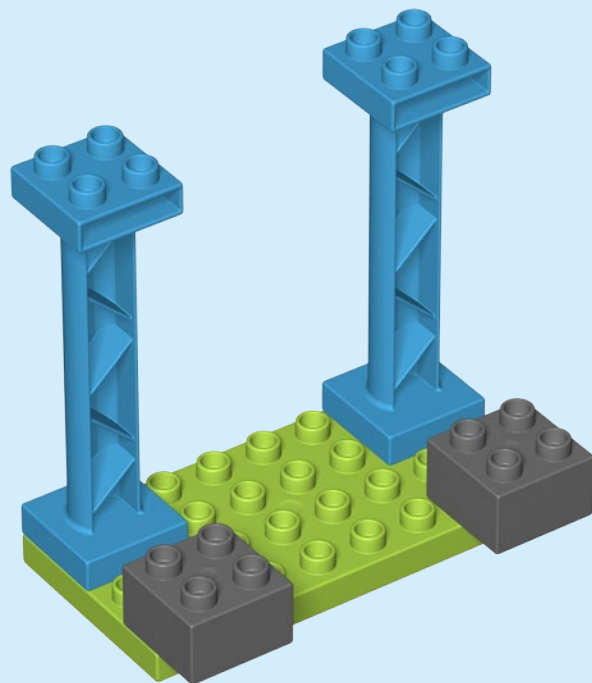

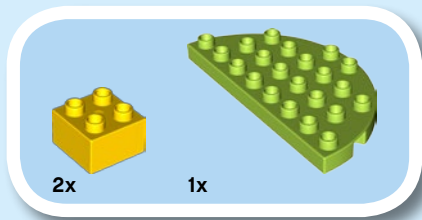

3

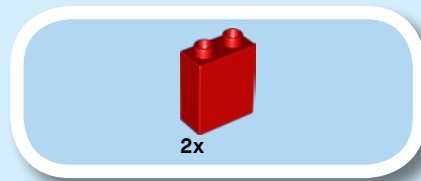
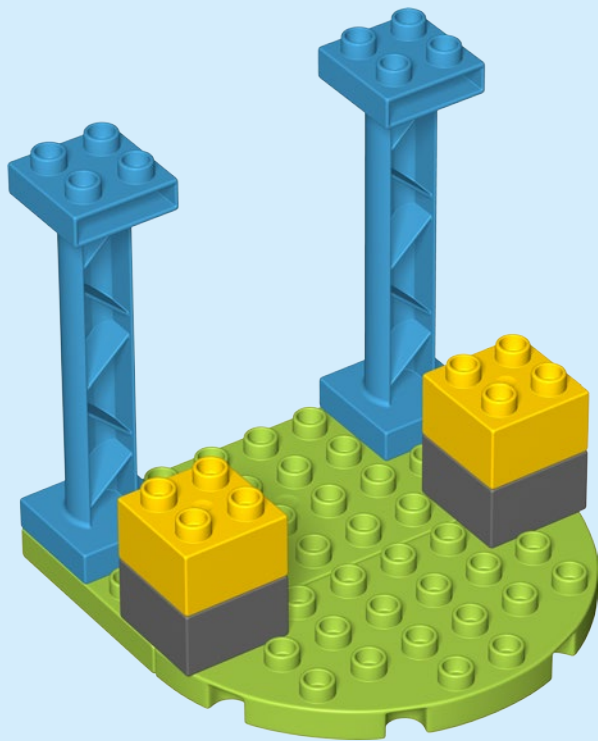

4

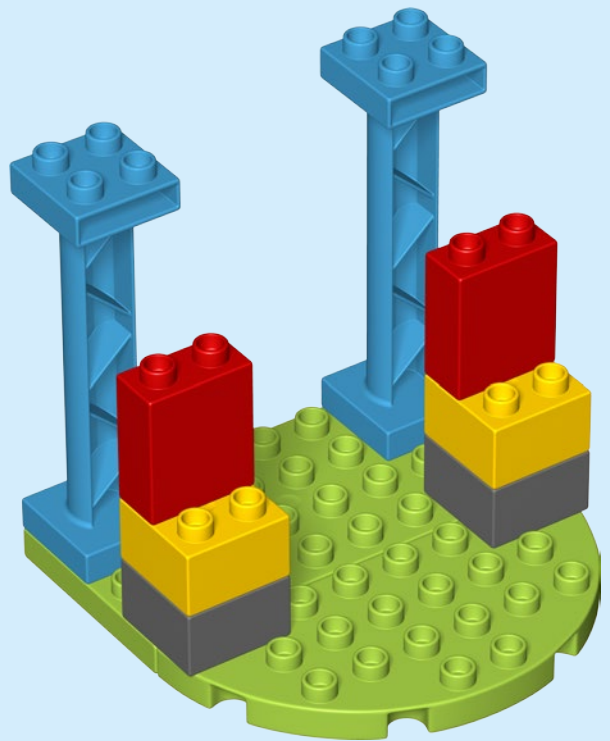

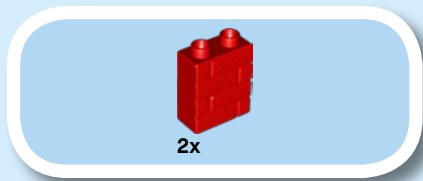

5

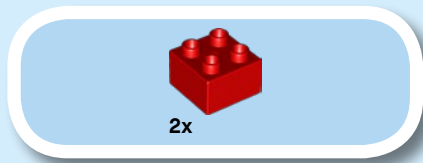
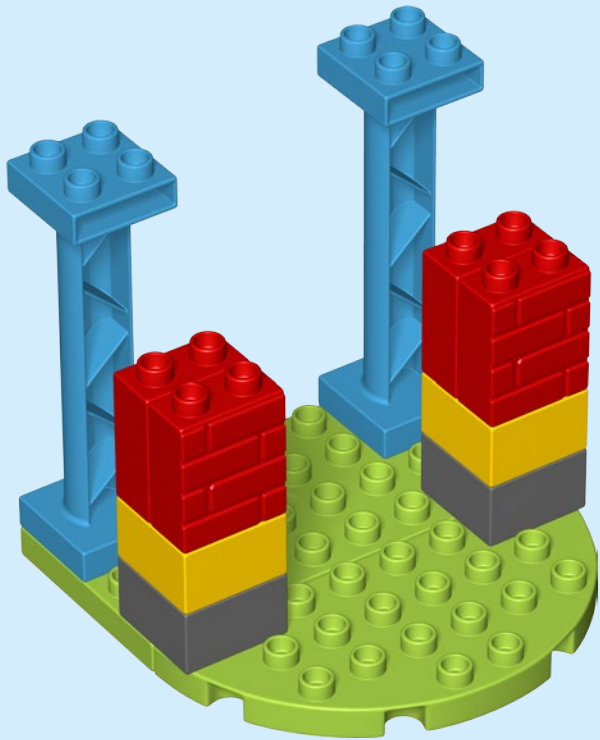

6

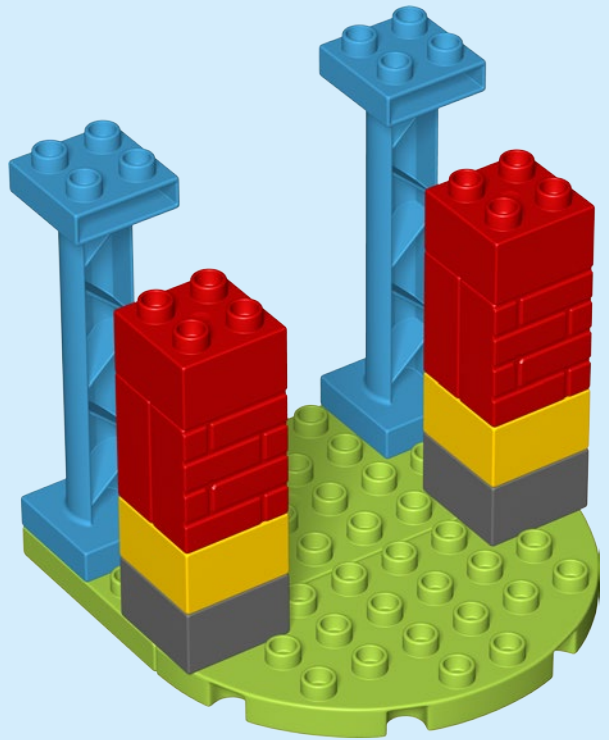

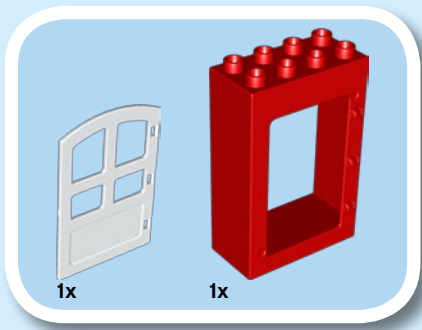

7

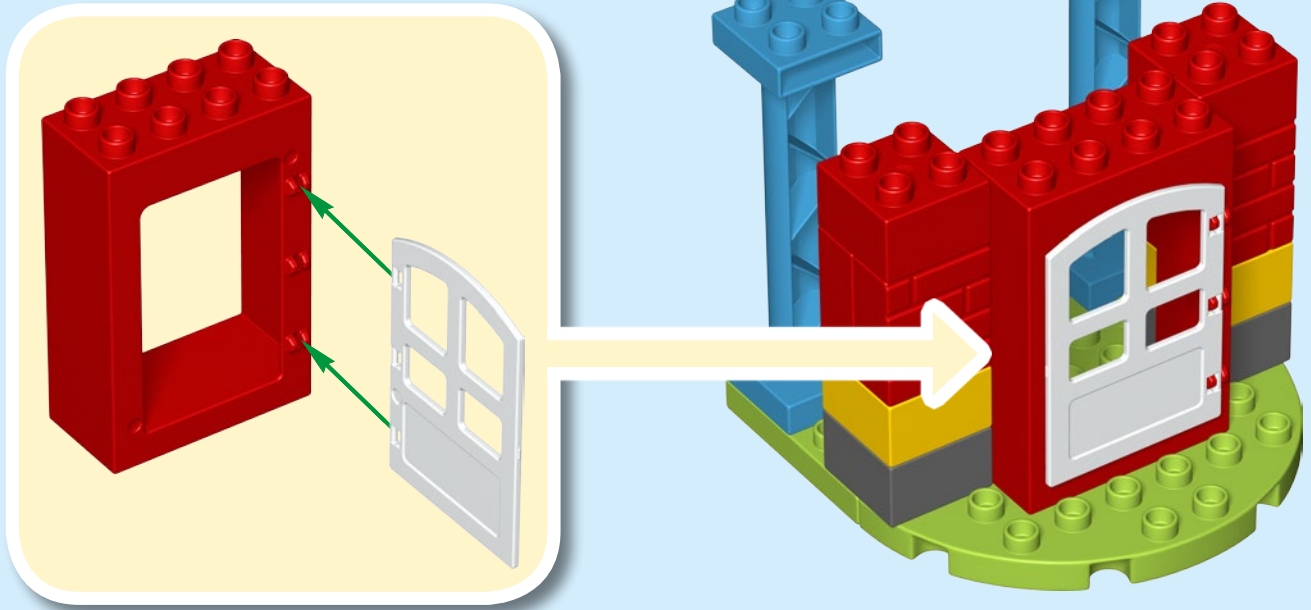

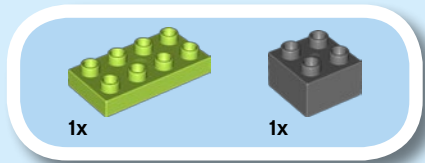
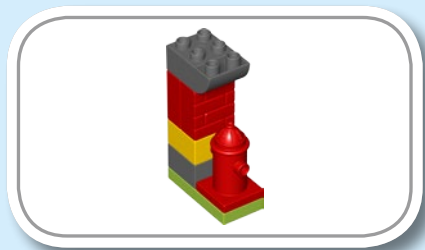

8

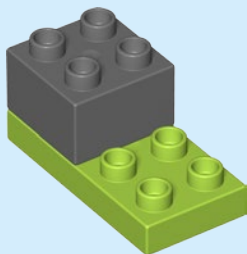

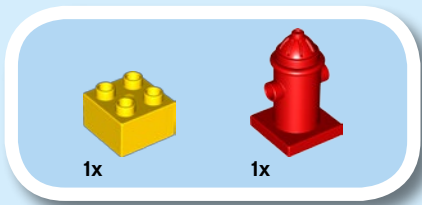

9

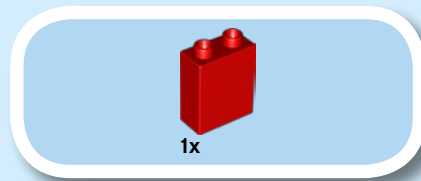
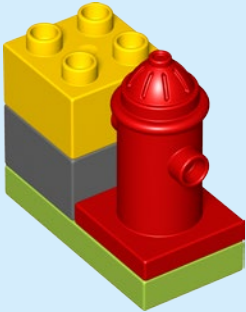

10

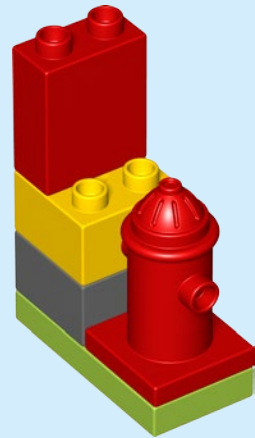

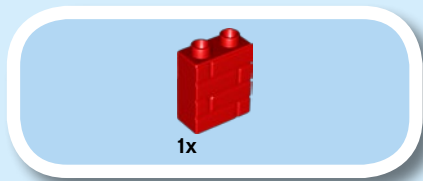

11

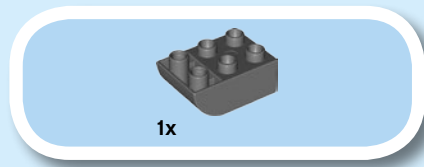
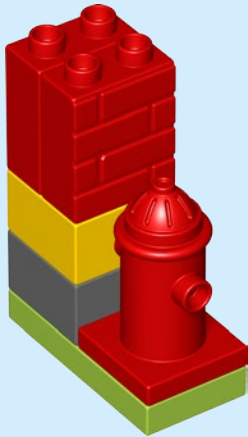

12

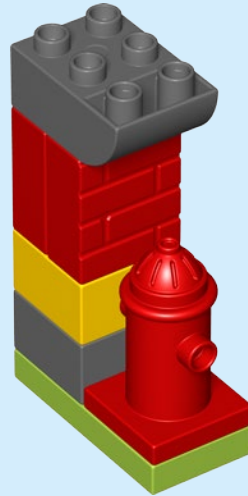

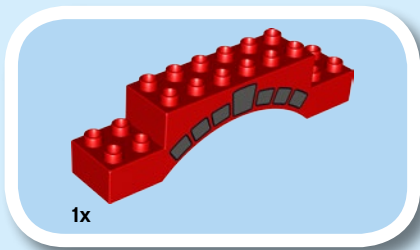

13

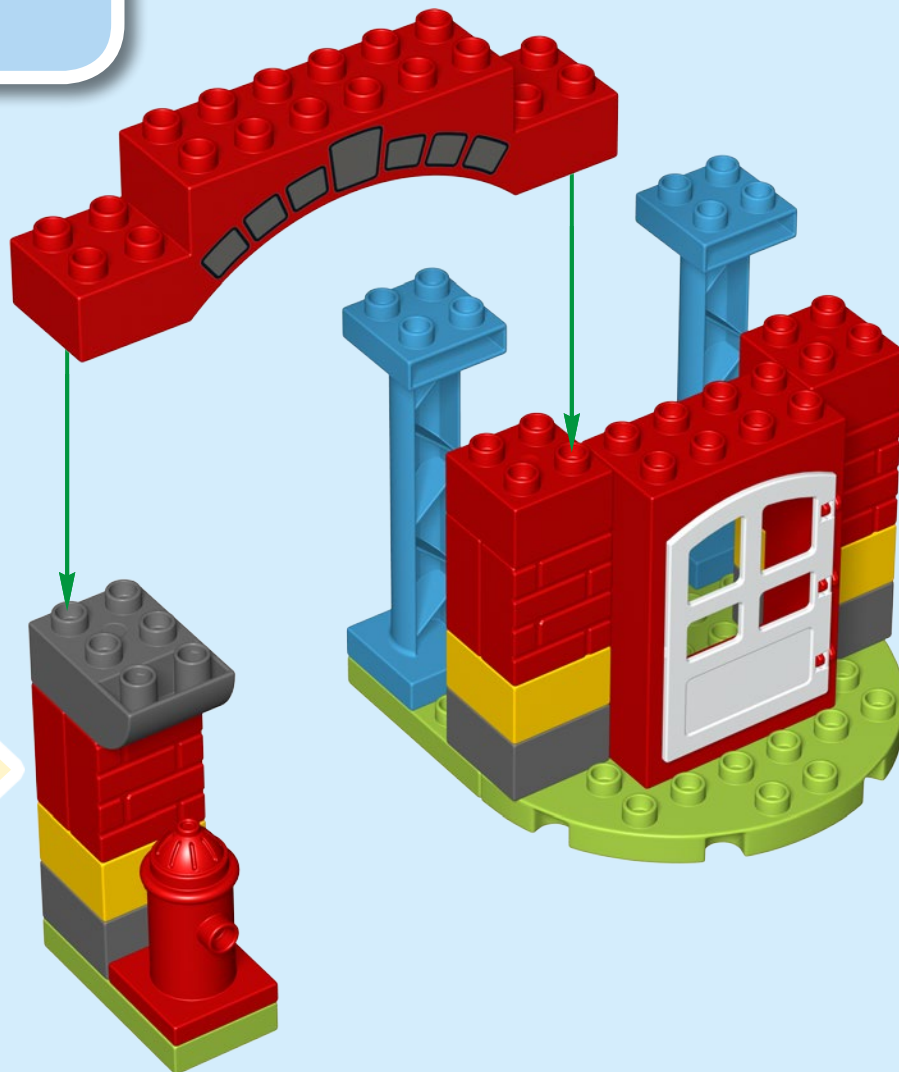

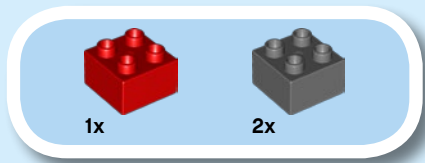

14

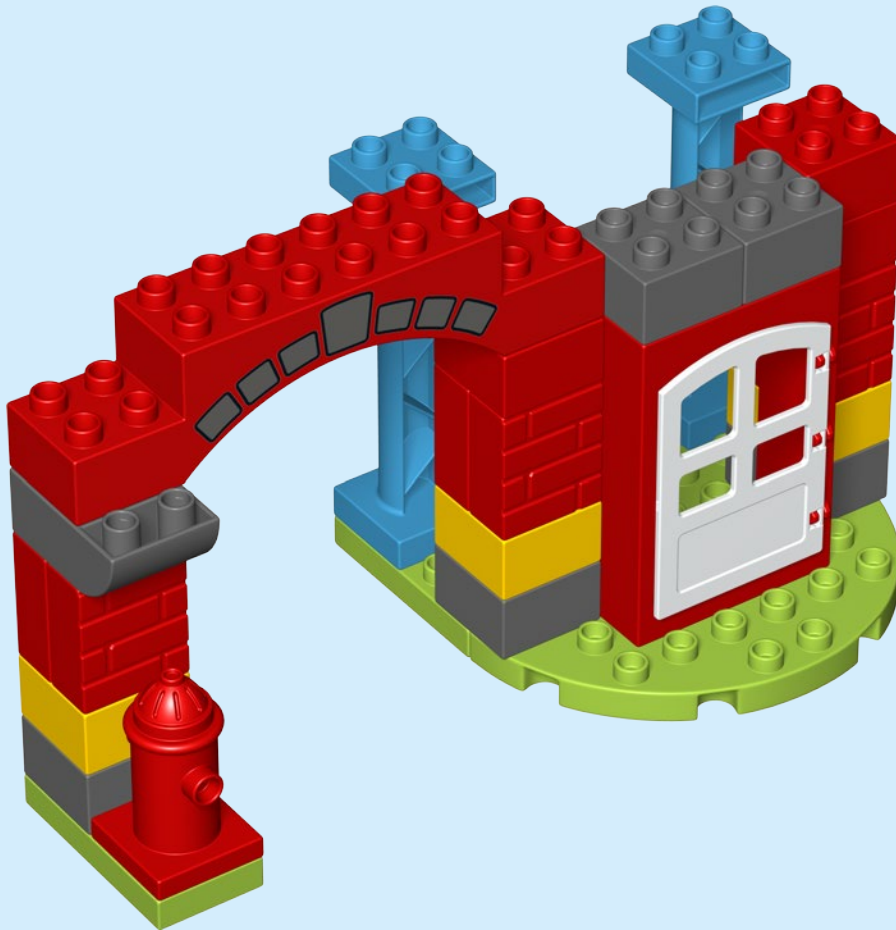

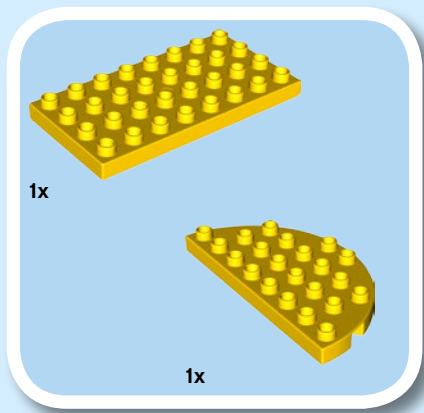

15



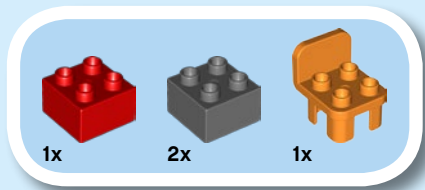

16

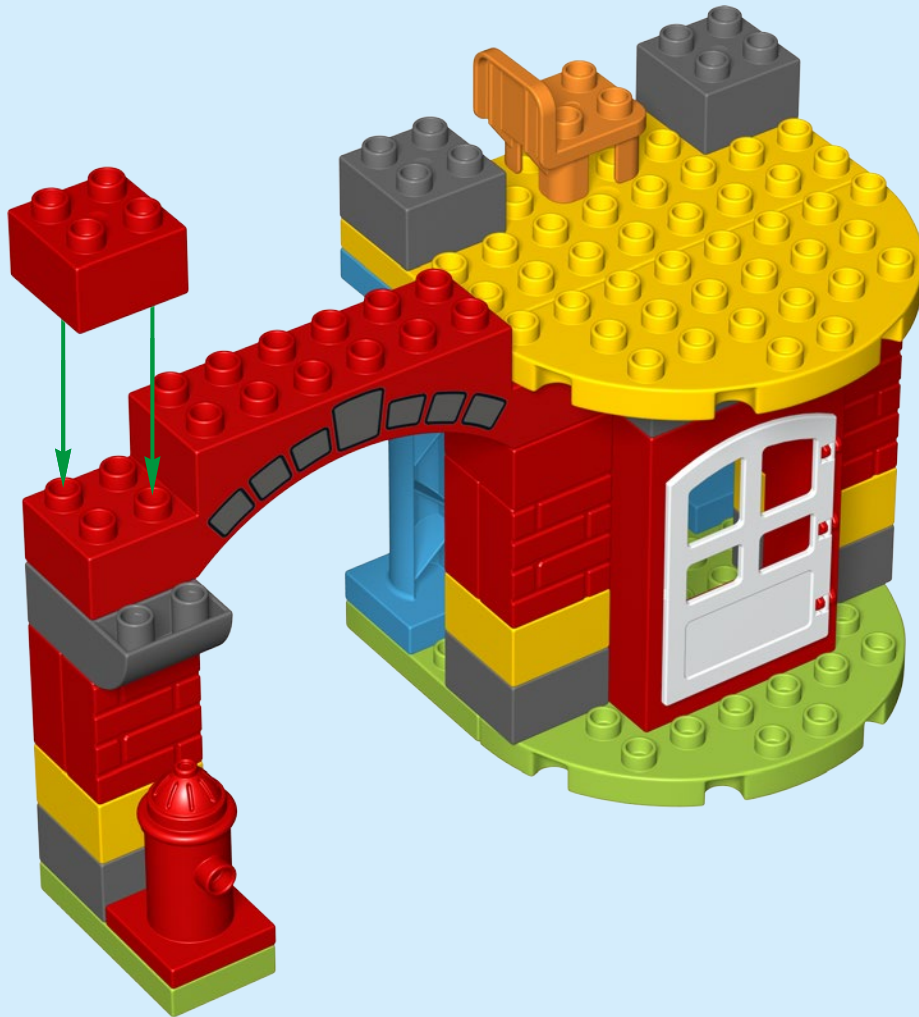

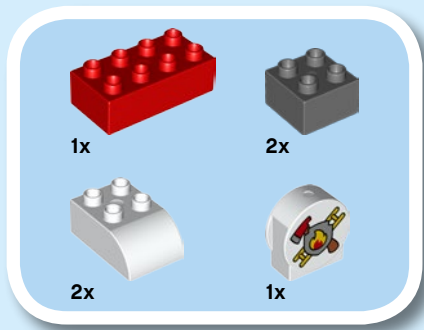

17



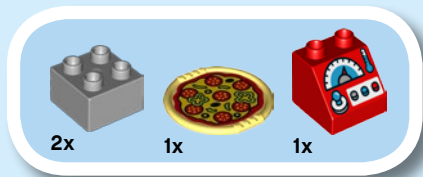

18



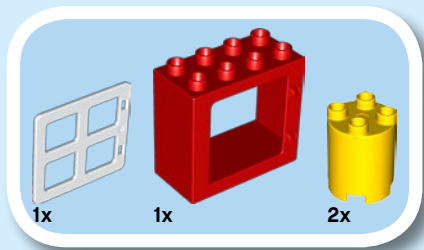

19

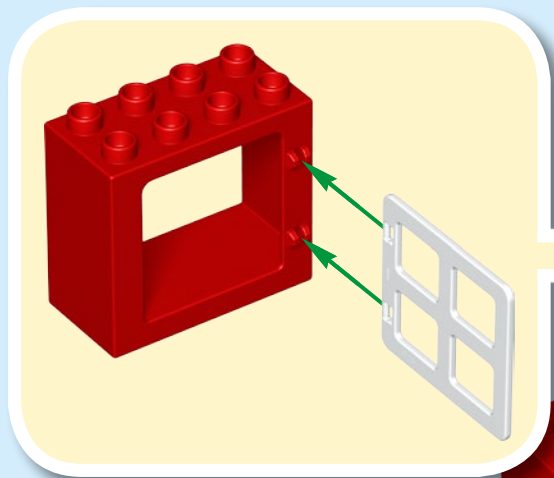

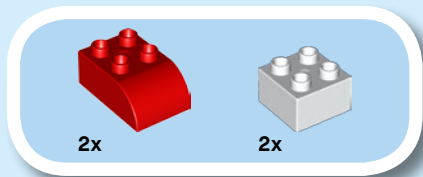

20



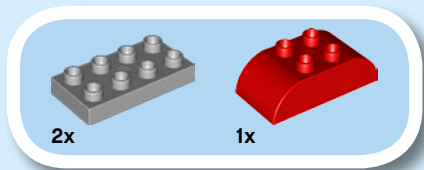

21

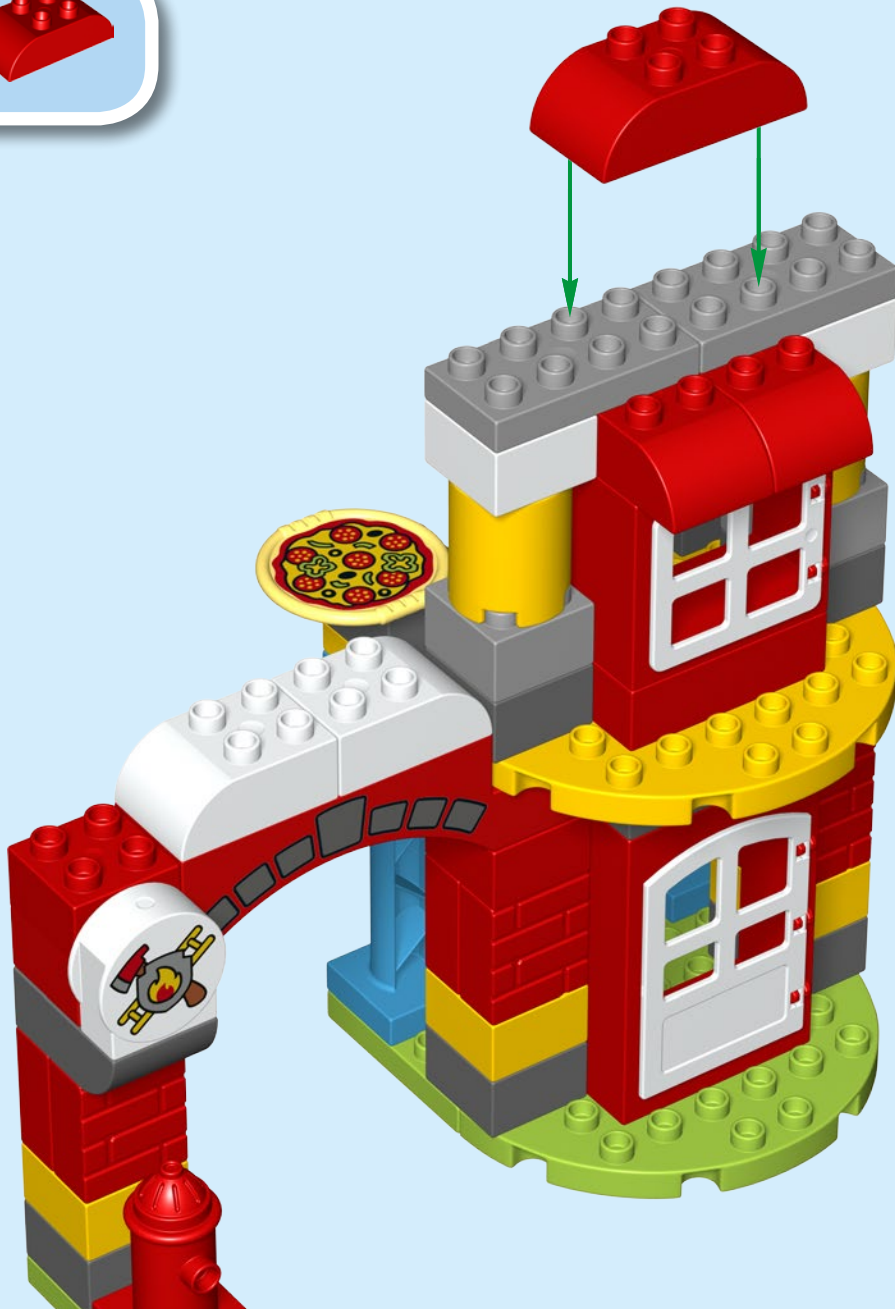



1x

22







Customer Service
Kundenservice
Service Consommateurs
Servicio Al Consumidor
LEGO.com/service or dial



 00800 5346 5555 : 

 1-800-422-5346 : 

LEGO

duplo



**IMAGINATION
& CREATIVITY**

**IMAGINATION
ET CRÉATIVITÉ**

**IMAGINACIÓN
Y CREATIVIDAD**



**SOCIAL &
EMOTIONAL SKILLS**

**APTITUDES SOCIALES
ET ÉMOTIONNELLES**

**HABILIDADES SOCIALES
Y EMOCIONALES**



duplo

Parents ▶

**FREE APPS
APPLIS
GRATUITES
APPS GRATIS**

The LEGO Group



Our games are available
for download for both
Android and iOS.

Nos jeux peuvent être
téléchargés sur les
appareils Android et iOS.

Nuestros juegos están
disponibles para
dispositivos Android e iOS.



duplo

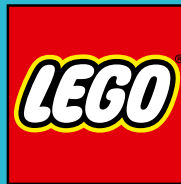

The fun continues!
L'amusement continue !
¡La diversión continúa!

Ages/edades

1½+

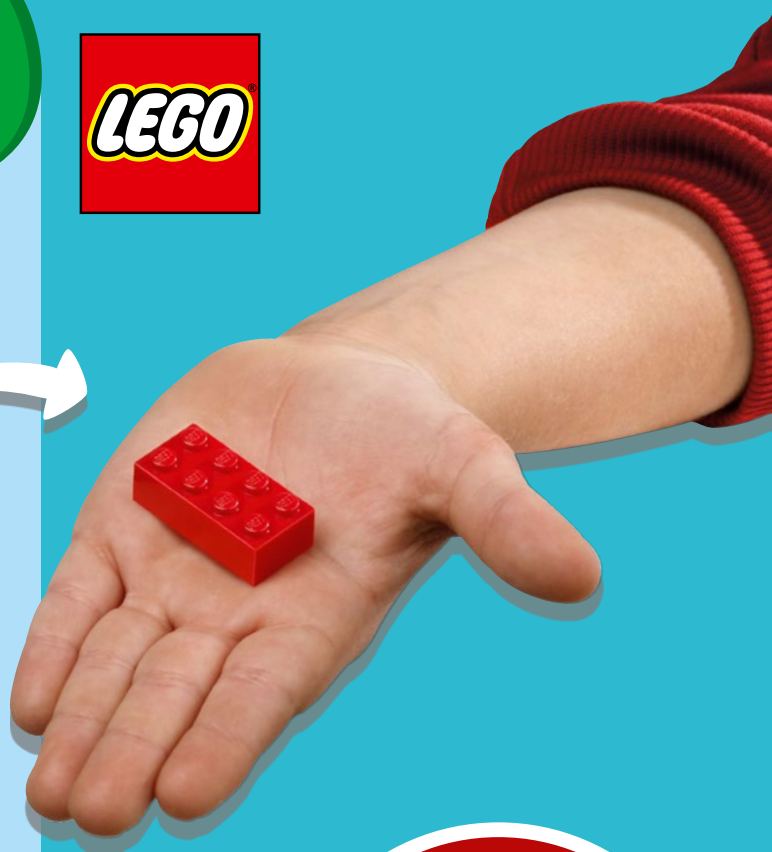

Ages/edades



win

Go to
www.LEGO.com/productfeedback
and give us your short
feedback about this LEGO® DUPLO®
set for a chance to win
a cool LEGO prize

Terms & Conditions apply



LEGO.com/productfeedback

GEWINNE

Erzähle uns auf
www.LEGO.com/productfeedback

etwas über die Erfahrungen, die du mit
diesem LEGO® Set gemacht hast, und
sichere dir die Chance auf einen coolen
LEGO Preis!

Es gelten die Teilnahmebedingungen

GAGNE

Rends-toi sur
www.LEGO.com/productfeedback

et donne-nous quelques commentaires
sur ce produit LEGO® pour avoir une
chance de gagner un prix LEGO !

Voir Conditions Générales

GANAN

Visita
www.LEGO.com/productfeedback

y envíanos tu opinión acerca de este set
LEGO®. ¡Participarás en el sorteo de un
premio LEGO!

Términos y Condiciones aplicables

获取奖品

登录
www.LEGO.com/productfeedback

给出关于此乐高®套装的简短反馈，
就有机会获得炫酷乐高奖品

《条款及条件》适用

LEGO, the LEGO logo, DUPLO and the DUPLO logo are trademarks of the/son des marques de commerce du/son marcas registradas de LEGO Group. ©2019 The LEGO Group.

6268047