

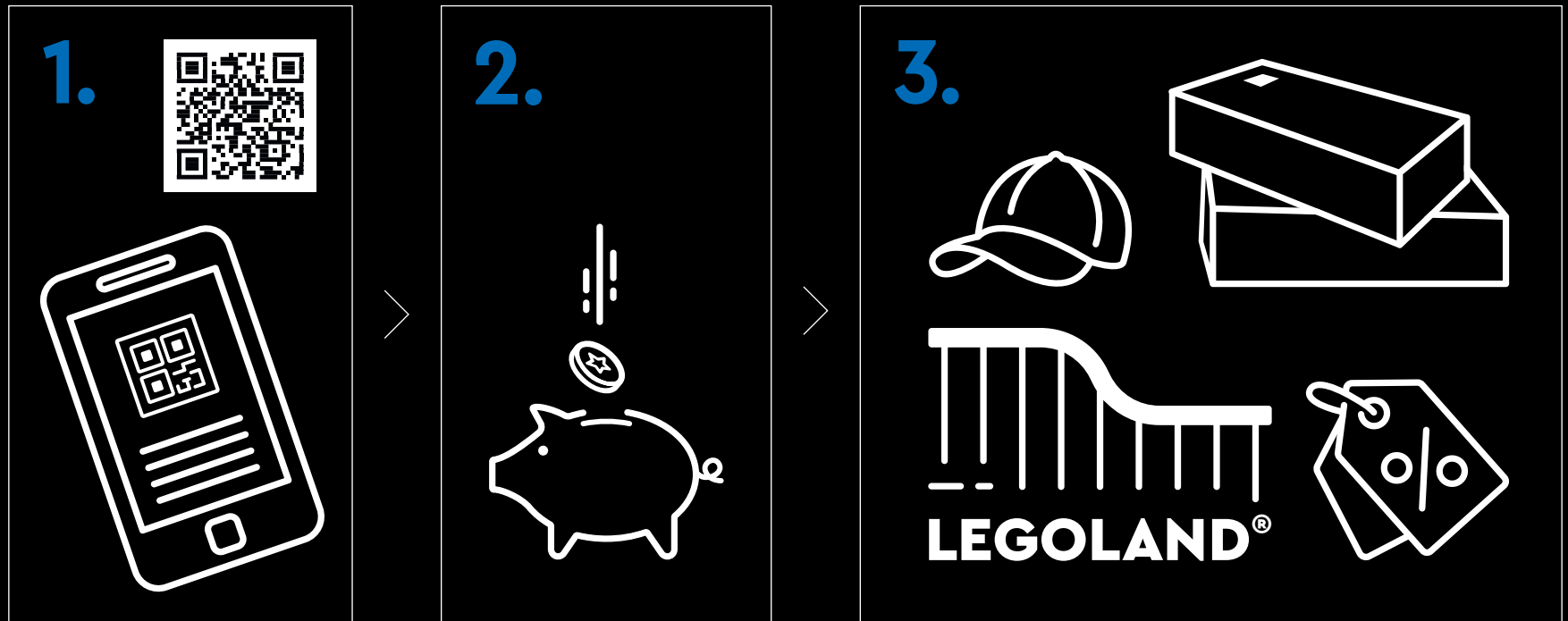



LEGO.com/sustainable-packaging

LEGO® VIP



1. Sign up **2.** Earn points for purchases **3.** Redeem points for rewards, experiences, discounts & more | **1.** Melde dich an **2.** Sammle Punkte bei jedem Kauf **3.** Löse die Punkte für Belohnungen, Erlebnisse, Rabatte und Ähnliches ein | **1.** Inscrivez-vous **2.** Gagnez des points lors de vos achats **3.** Échangez vos points contre des récompenses, des expériences, des remises et bien plus encore | **1.** Iscriviti **2.** Guadagna punti con i tuoi acquisti **3.** Riscatta punti per premi, esperienze, sconti e altro ancora | **1.** Regístrate **2.** Gana puntos por tus compras **3.** Canjea puntos por recompensas, experiencias, descuentos y mucho más | **1.** Registe-se **2.** Ganhe pontos em compras **3.** Troque os pontos para prémios, experiências, descontos e muito mais | **1.** 注册 **2.** 购物赚积分 **3.** 用积分兑换奖励、体验、折扣等 | **1.** Zarejestruj się **2.** Zdobywaj punkty za zakupy **3.** Wymieniaj punkty na rabaty, przygody i inne nagrody | **1.** Zaregistrujte se **2.** Sbírejte body za nákupy **3.** Vyměňujte body za odměny, zážitky, slevy a spoustu dalšího | **1.** Zaregistrujte se **2.** Získavajte body za nákupy **3.** Uplatnite si body a získajte odmeny, rôzne zážitky, zľavy a ešte viac | **1.** Regisztrálj **2.** Szerezz pontokat minden vásárlással **3.** Váltsd be pontjaidat jutalmakra, élményekre, kedvezményekre és egyebekre | **1.** Înscric-te **2.** Câștigă puncte pentru achiziții **3.** Valorifică puncte pentru recompense, experiențe, reduceri și multe altele | **1.** Регистрируйте се **2.** Получайте точки за покупки **3.** Используйте точки за награды, услуги, отстъпки и т.н. | **1.** Reģistrējies **2.** Pelni punktus par pirkumiem **3.** Izmanto punktus, lai saņemtu balvas, izklaides iespējas, atlaides un daudz ko citu | **1.** Registreeru **2.** Teeni ostude eest punkte **3.** Lunasta punktide eest preemiad, elamused, allahindlused ja muu | **1.** Užsiregistruokite **2.** Pelnykite taškų už pirkinius **3.** Panaudokite taškus atlygiui, funkcijoms, nuolaidoms ir ne tik





"Al giorno d'oggi,
essere nella Natura
sta diventando
un evento raro.
Siamo una società

urbana e dipendente dalla tecnologia.
Ma abbiamo bisogno della Natura per
relazionarci e capire noi stessi. Il Giardino
Tranquillo LEGO®, ispirato ai giardini
giapponesi, ci riporta alla mente la Natura,
almeno simbolicamente. Che è una delle
cose più importanti per la nostra vita".

HOICHI KURISU

Designer e costruttore di giardini giapponesi



Creato per una vita ricca di mindfulness

● Segui i gradini fino al tuo padiglione privato, mettiti comodo, rilassati e diventa, almeno per un attimo, tutt'uno con la natura. Oppure rimani tutto il tempo che vuoi.

Ispirato ad elementi delle tradizioni millenarie dei giardini giapponesi, questo set è stato creato in collaborazione con Hoichi Kurisu, che vanta un'esperienza pluriennale nella creazione di giardini orientati alla mindfulness. Un rifugio sereno dove riflettere e ricaricarsi senza distrazioni. Ogni elemento del giardino permette di soffermarsi sulle meraviglie colorate e sulla bellezza giocosa della Madre Terra. Mentre trascorri del tempo nel tuo giardino, lascia che le stagioni vadano e vengano. Senti la tua creatività sbocciare a ogni visita, riorganizza il paesaggio, pianta nuova vegetazione LEGO® o aggiungi gli ornamenti decorativi che ti stanno più a cuore. Prepara una teiera con il tuo tè matcha preferito, sintonizzati su una colonna sonora rilassante, indossa le tue pantofole più comode e goditi il tuo spazio mentale.





Prenditi cura del tuo giardino

● Costruire un set LEGO® può essere un'evasione immersiva, come leggere un bellissimo libro. Ti permette di concentrarti su un'attività divertente e ti dà una sensazione di orgoglio e gratificazione anche molto tempo dopo il completamento. Puoi tornare in questo giardino tutte le volte che vuoi. Cura gli elementi e cambia il paesaggio come faresti con un vero giardino o con un bonsai. Pota o ripianta i ciliegi in fiore, i lussureggianti sempreverdi e il bambù, oppure sposta le lanterne di pietra per adattare al tuo stile e al tuo umore. Osserva i vibranti pesci Koi e le ninfee nello stagno gorgogliante e arrenditi alla tua libertà creativa.

"Dai al set il tuo tocco personale
in base al tuo umore".

MICHAEL PSIAKI E CARL MERRIAM
Designer del modello LEGO® Icons



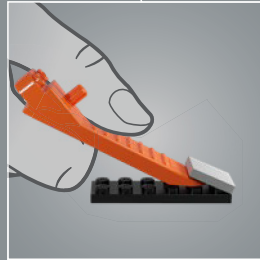
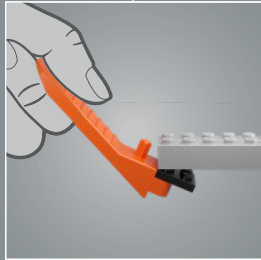
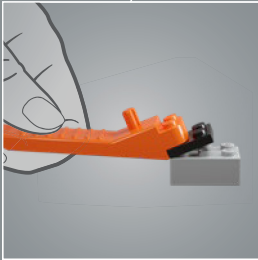
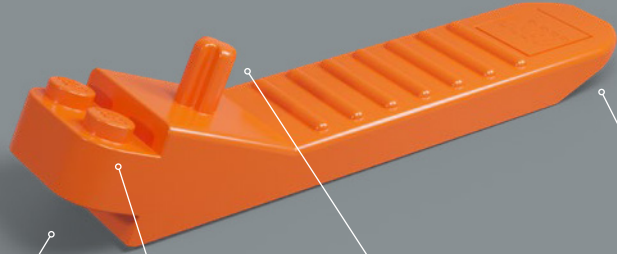

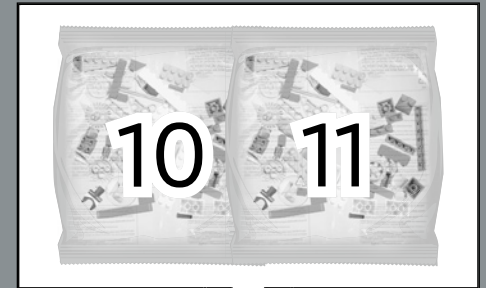
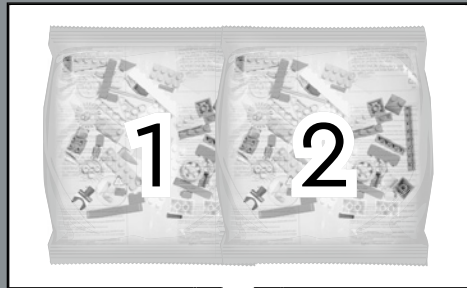

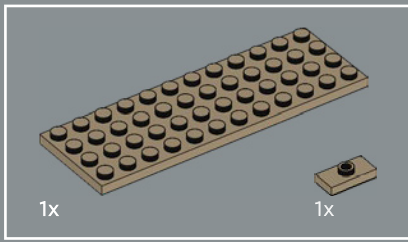
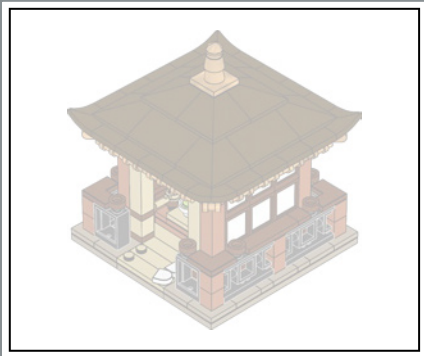

1

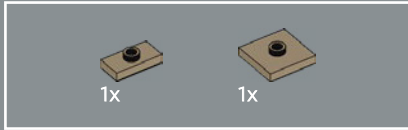
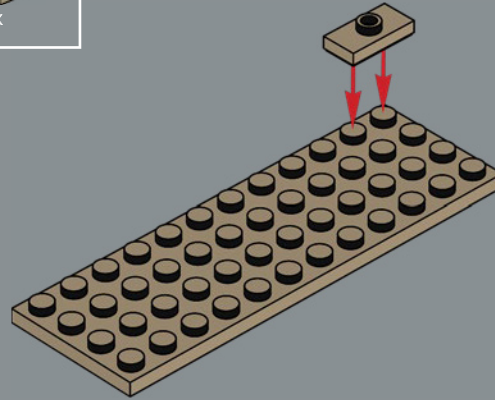

2

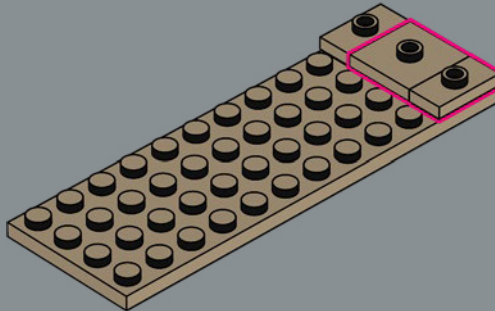

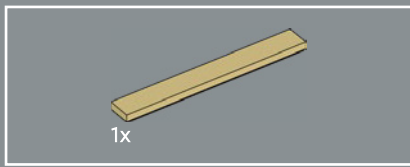

3

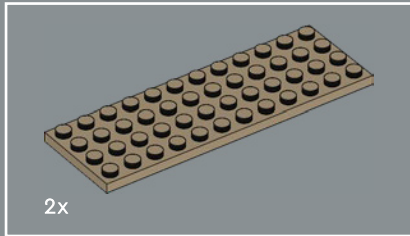
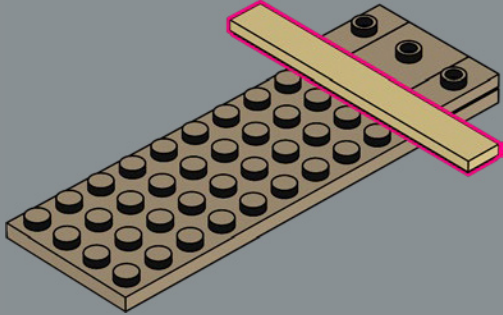

4

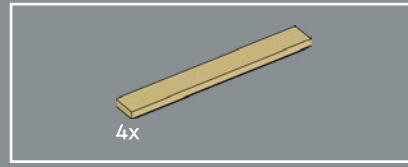
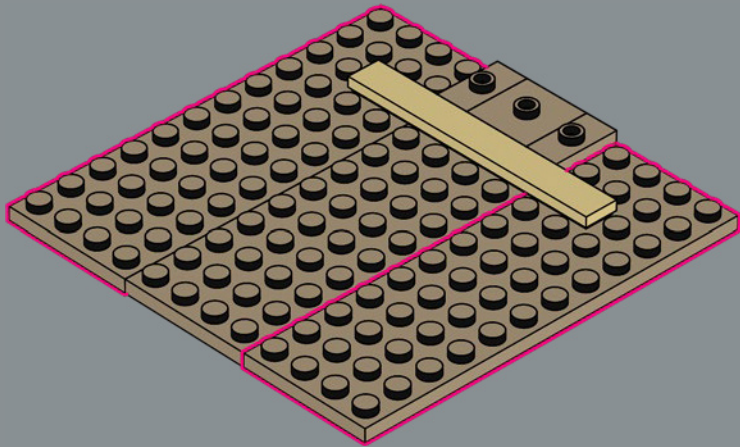

5

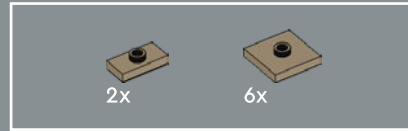
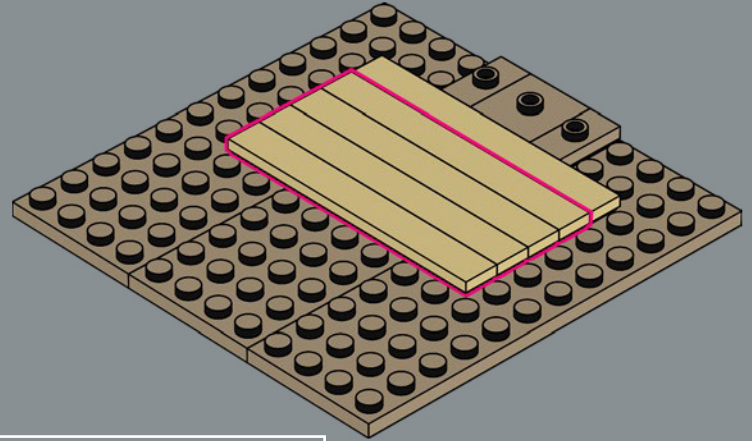

6

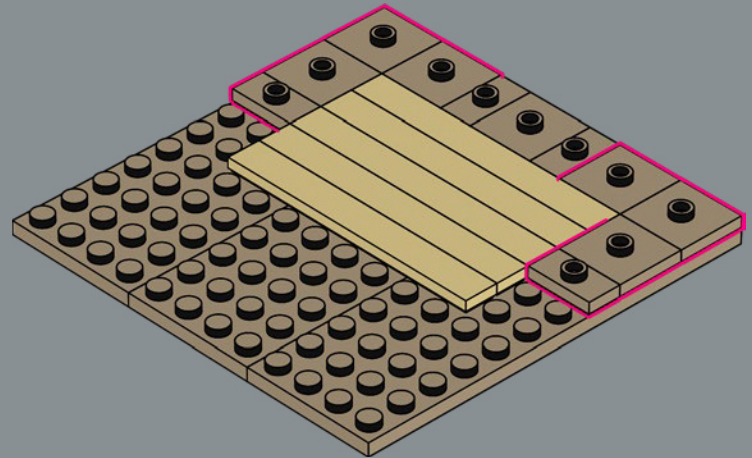

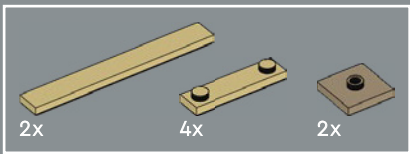

7

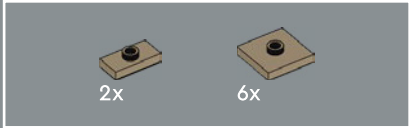
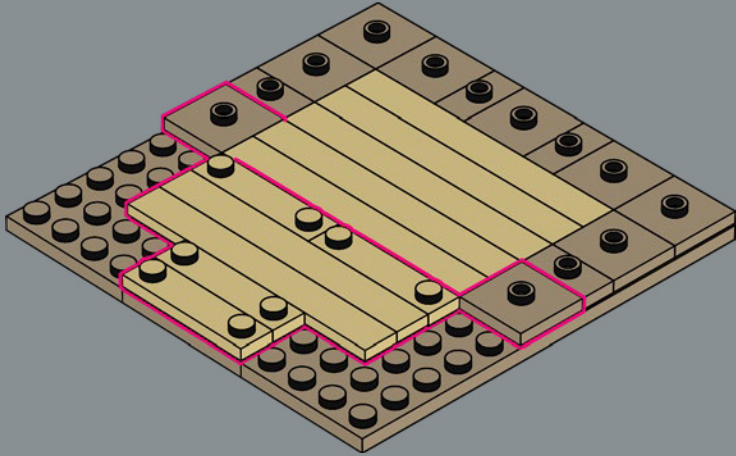

8

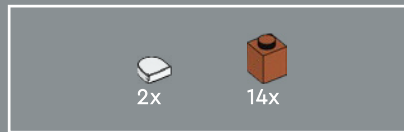
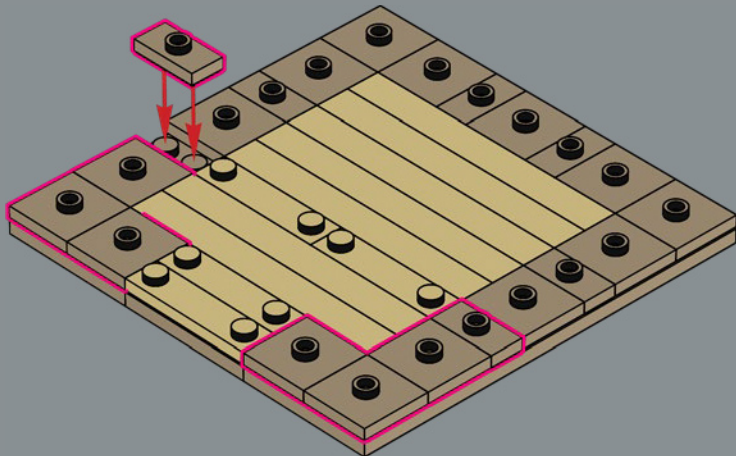

9

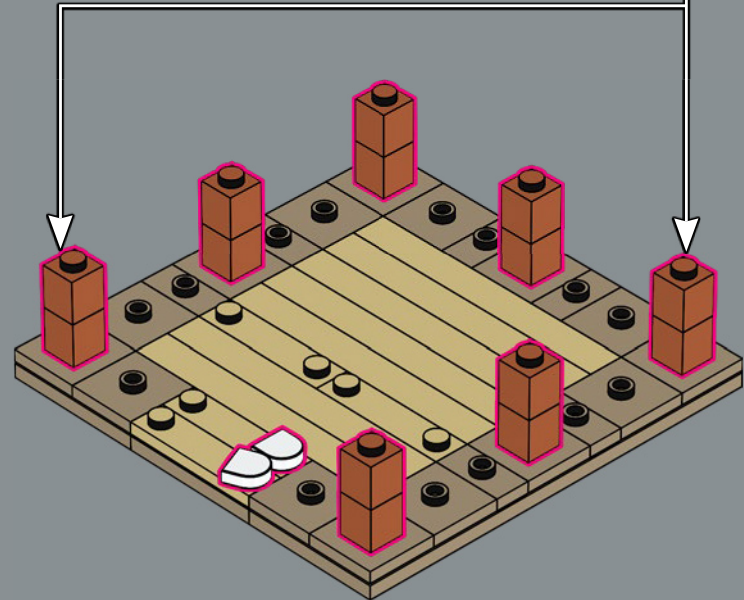
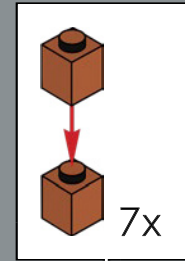

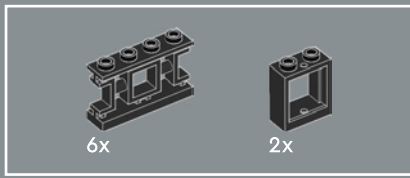

10

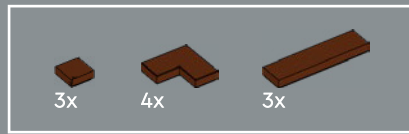
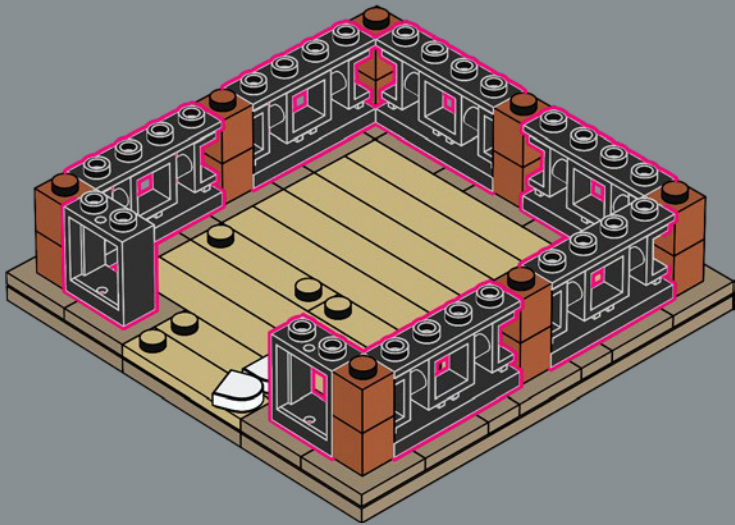

11

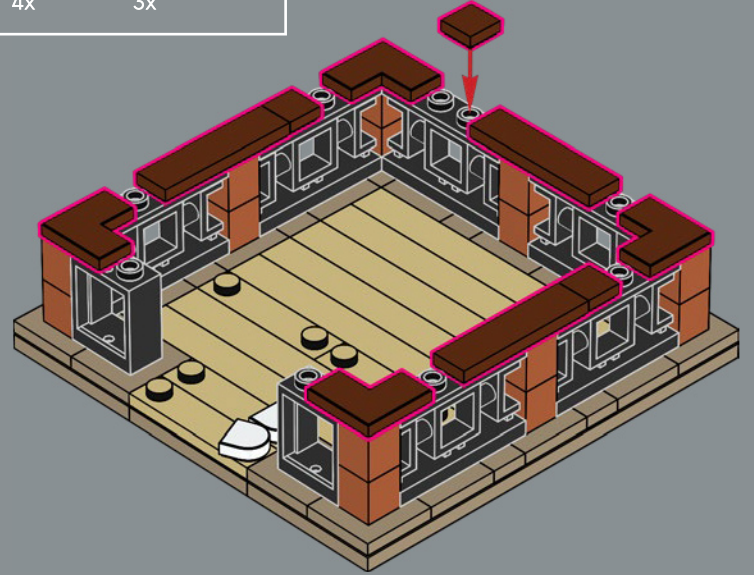

12

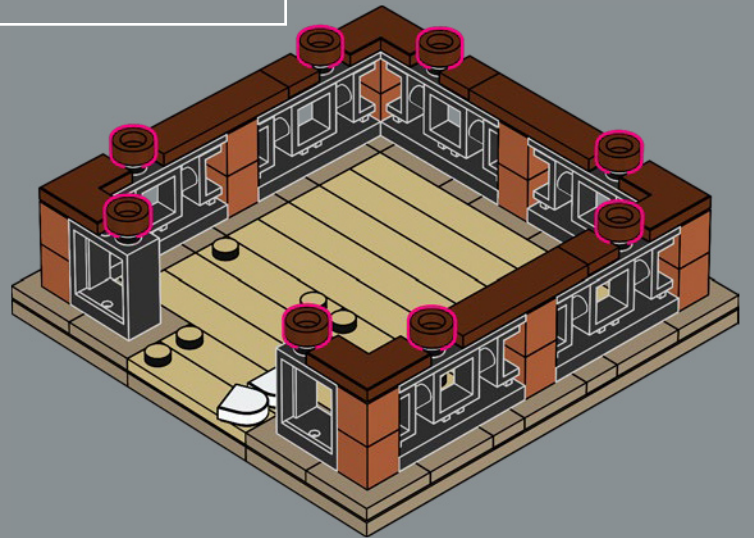

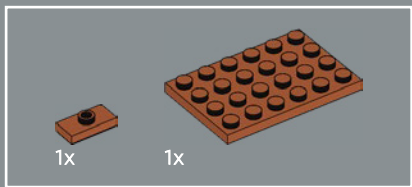

13

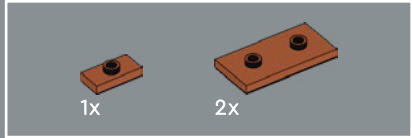
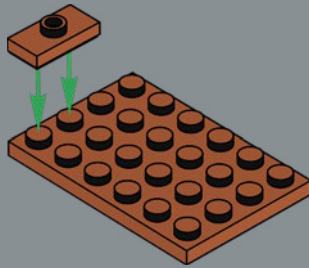

14

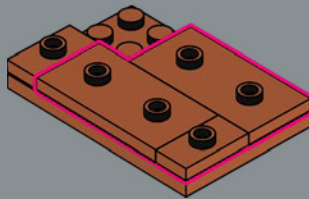

15

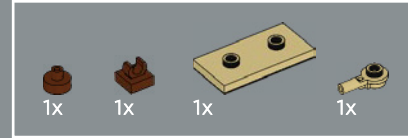
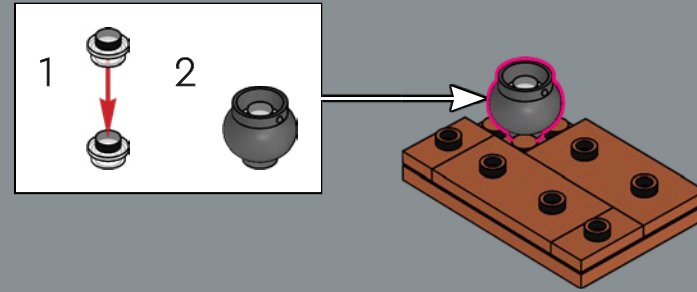

16

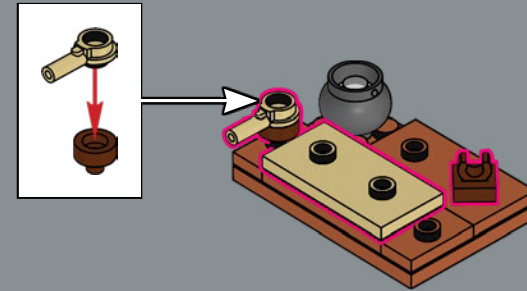

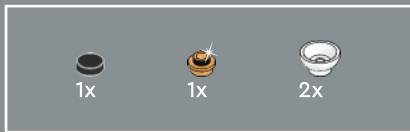

17

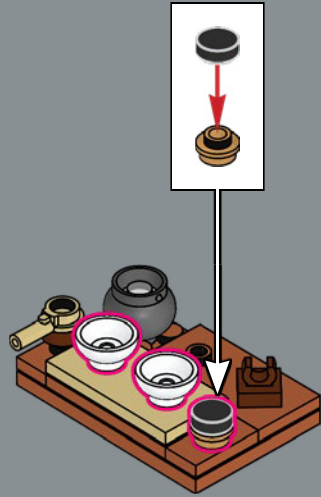

18

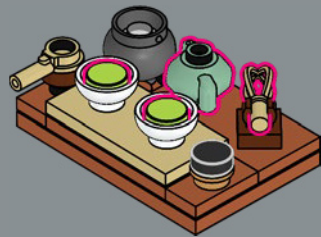

19



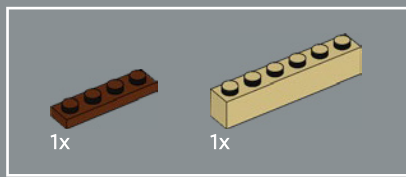

20

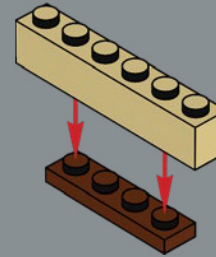

21

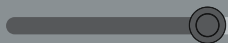
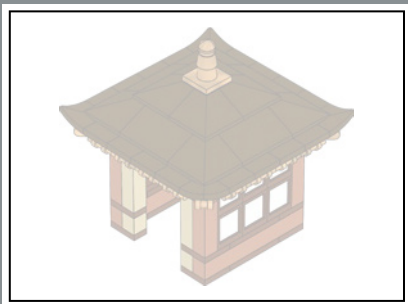
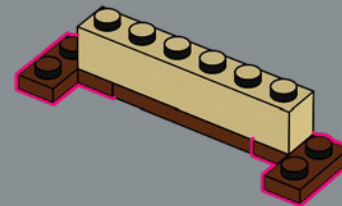

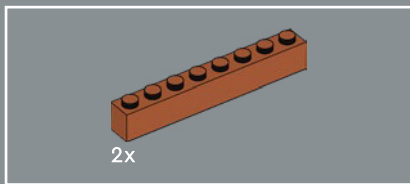

22

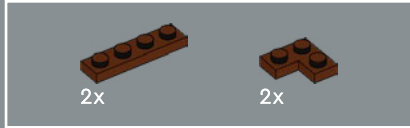
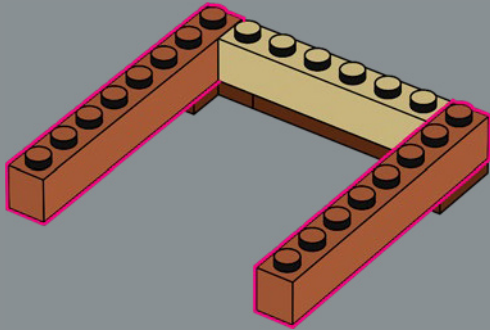

23

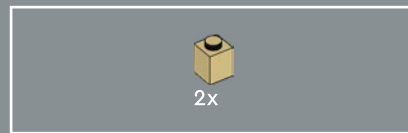
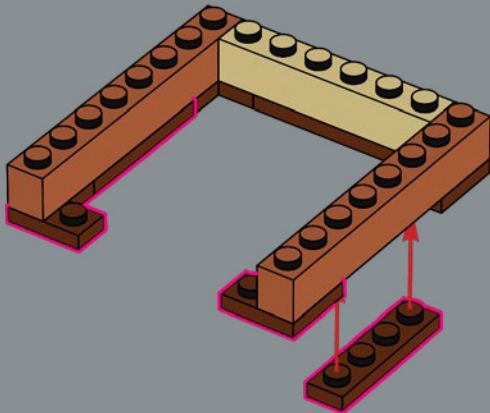

24

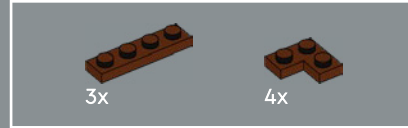
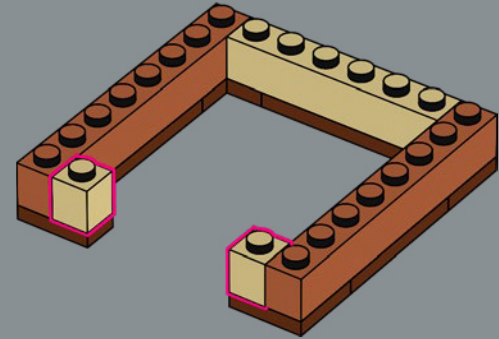

25

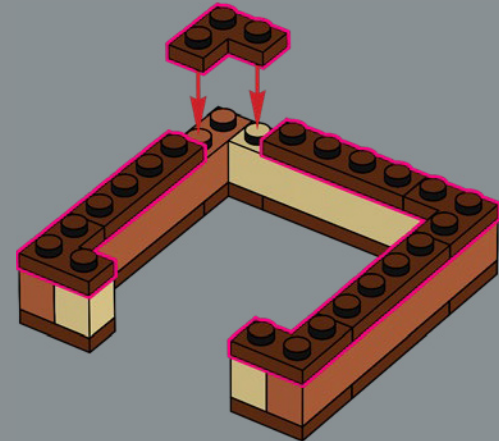

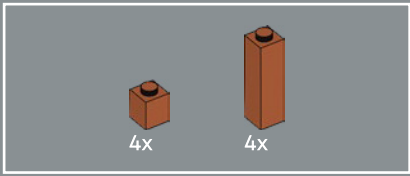

26

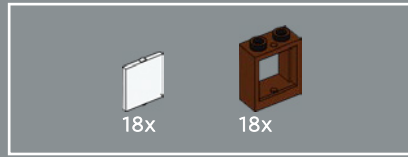
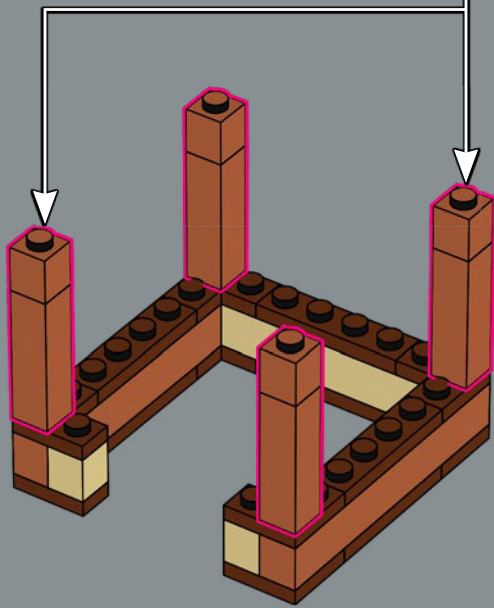
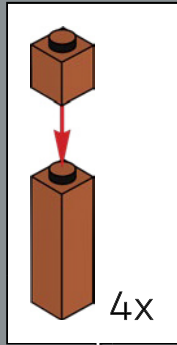

27

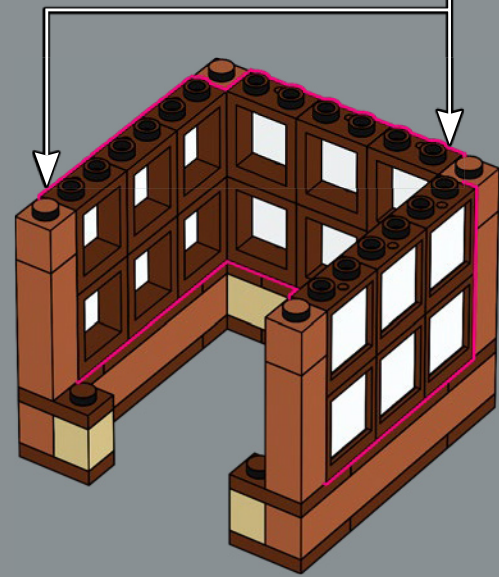
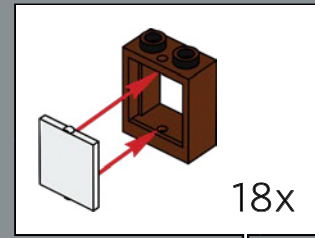

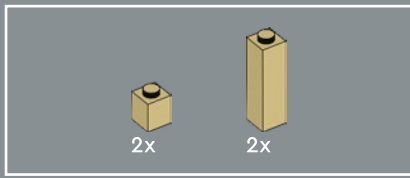

28

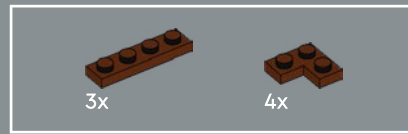
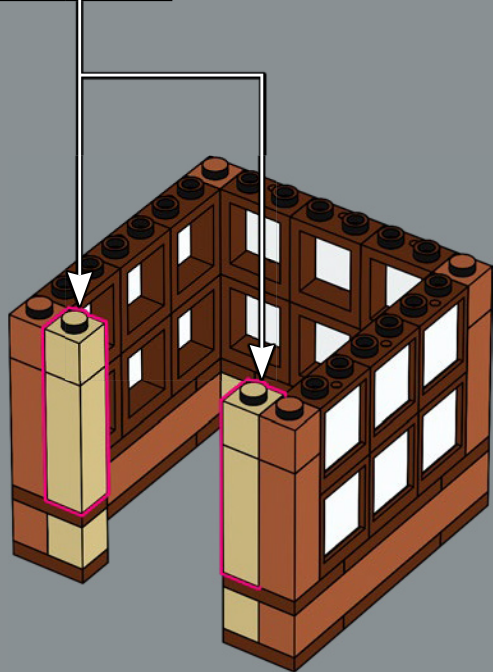
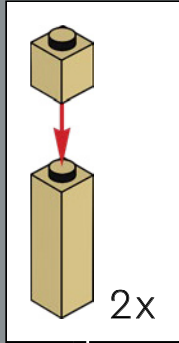

29

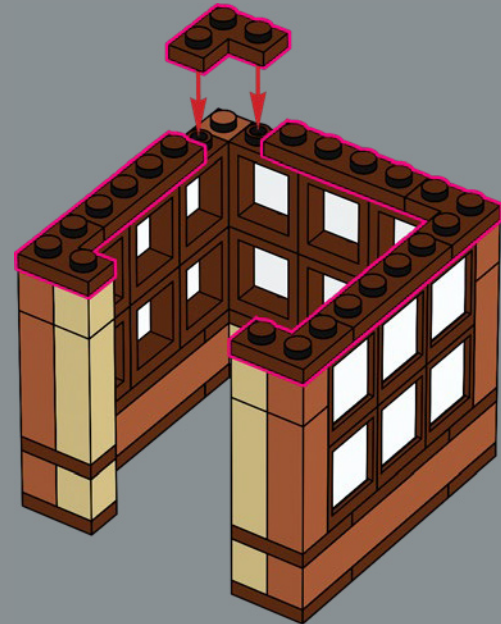

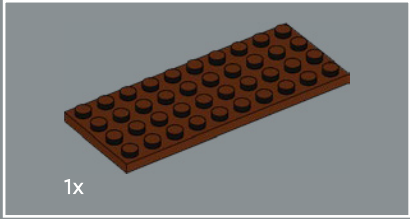
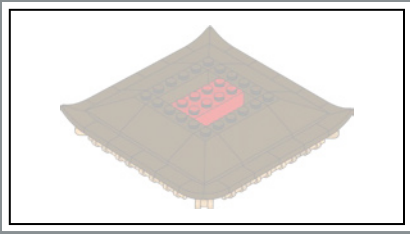

30

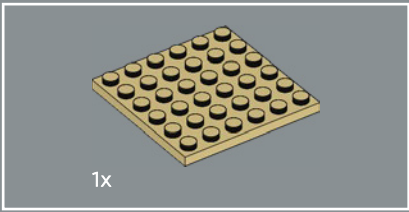
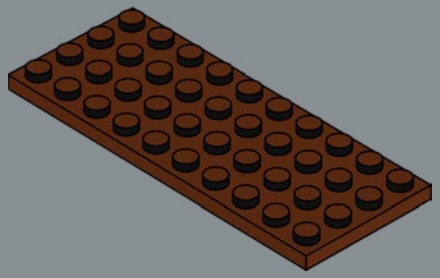

31

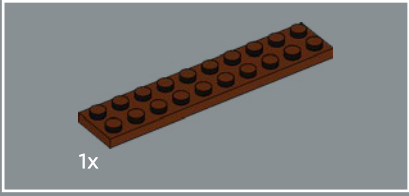
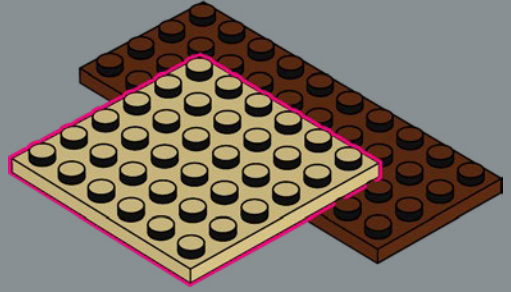

32

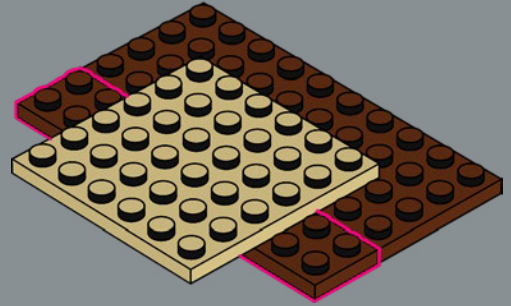

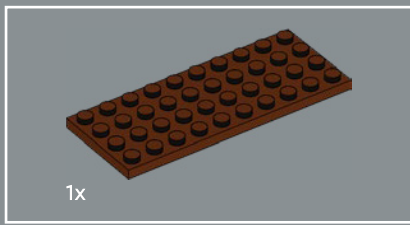

33

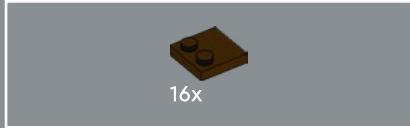
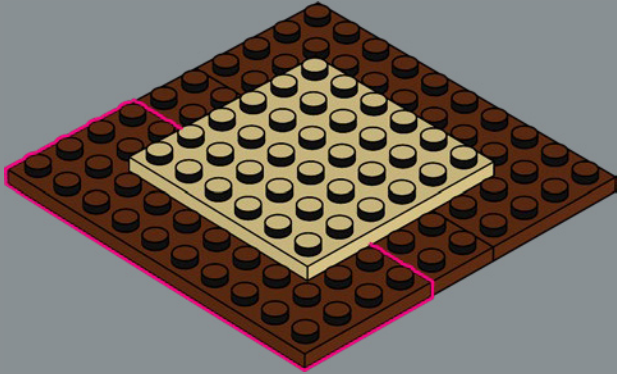

34

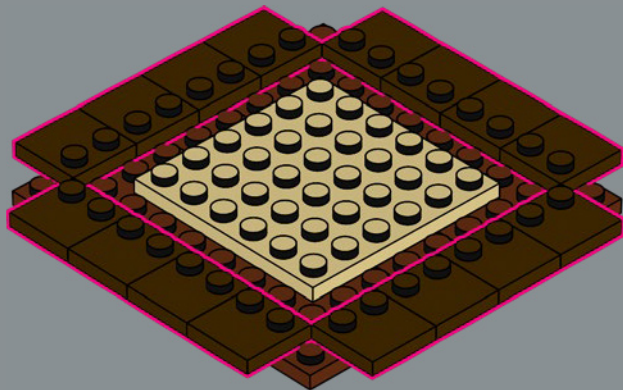

35

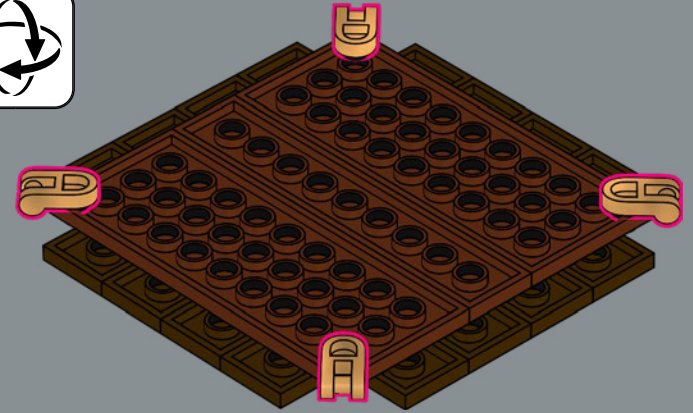

36

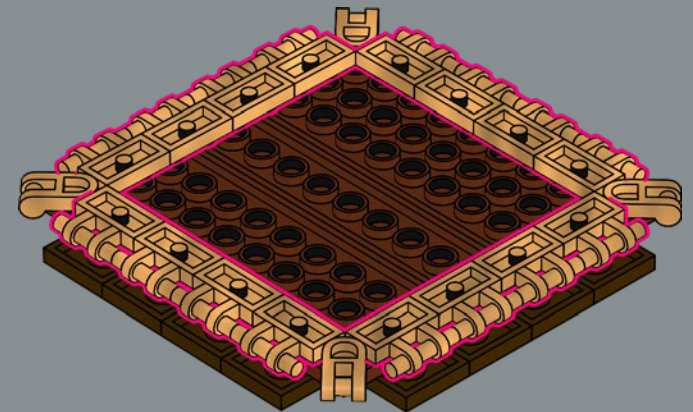

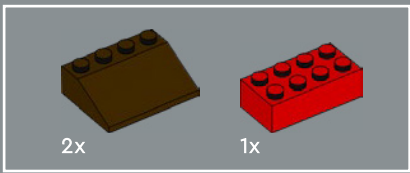

37

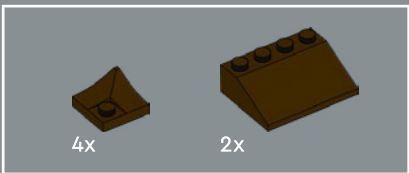
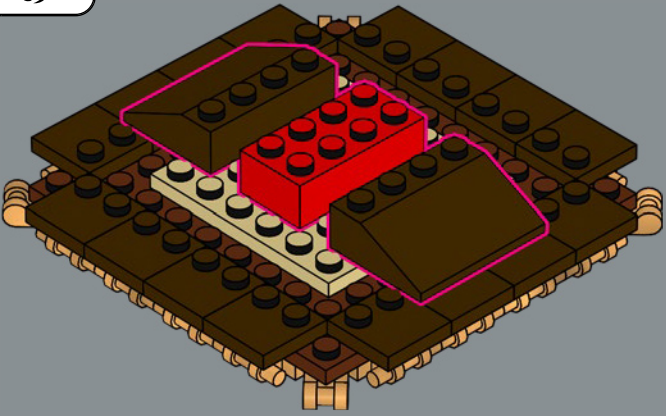

38

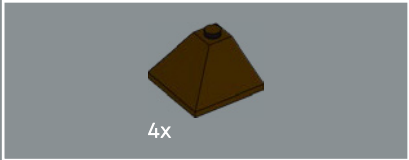
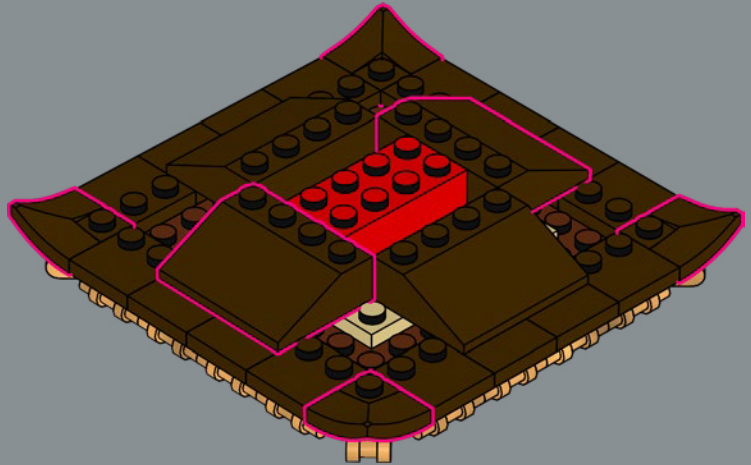

39

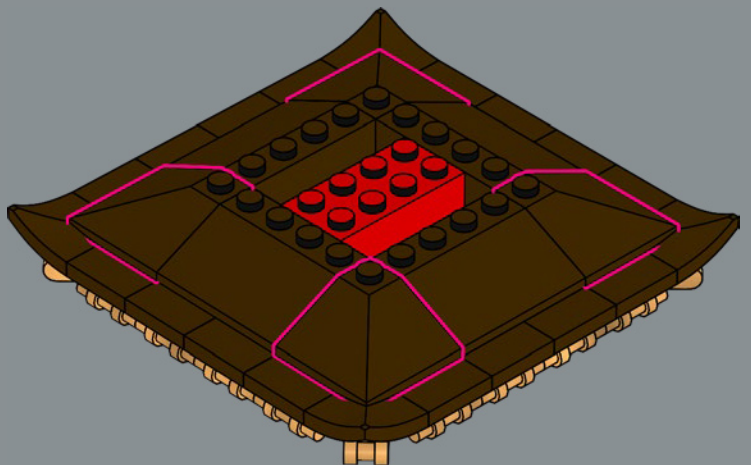

40



41

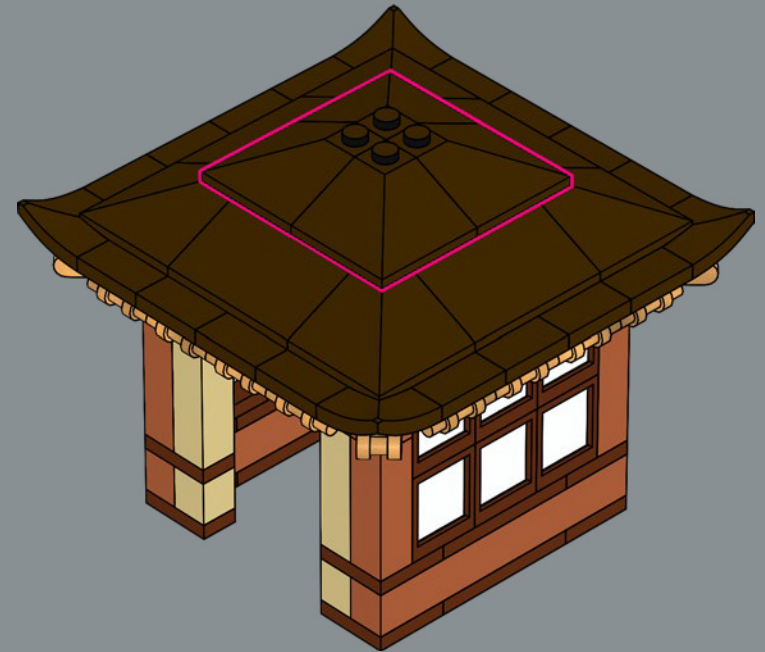
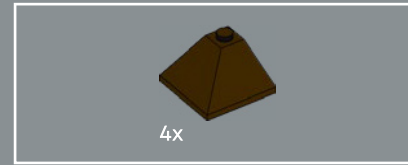



42

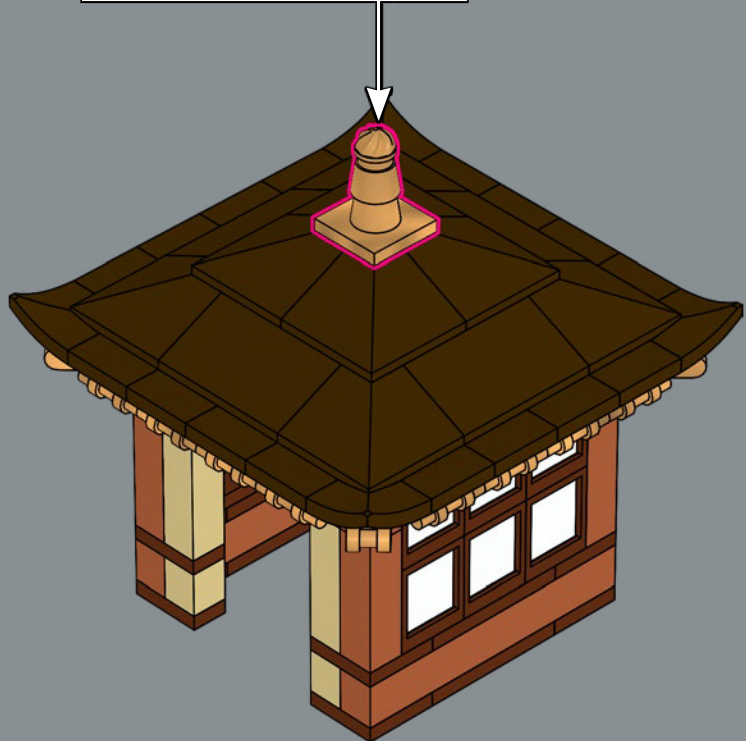
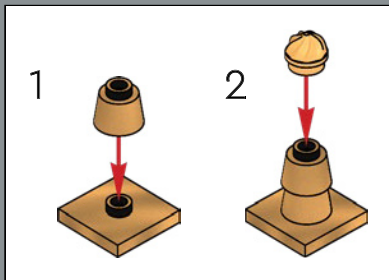

I padiglioni dei giardini giapponesi sono realizzati in legno per fondersi con l'ambiente naturale.

43

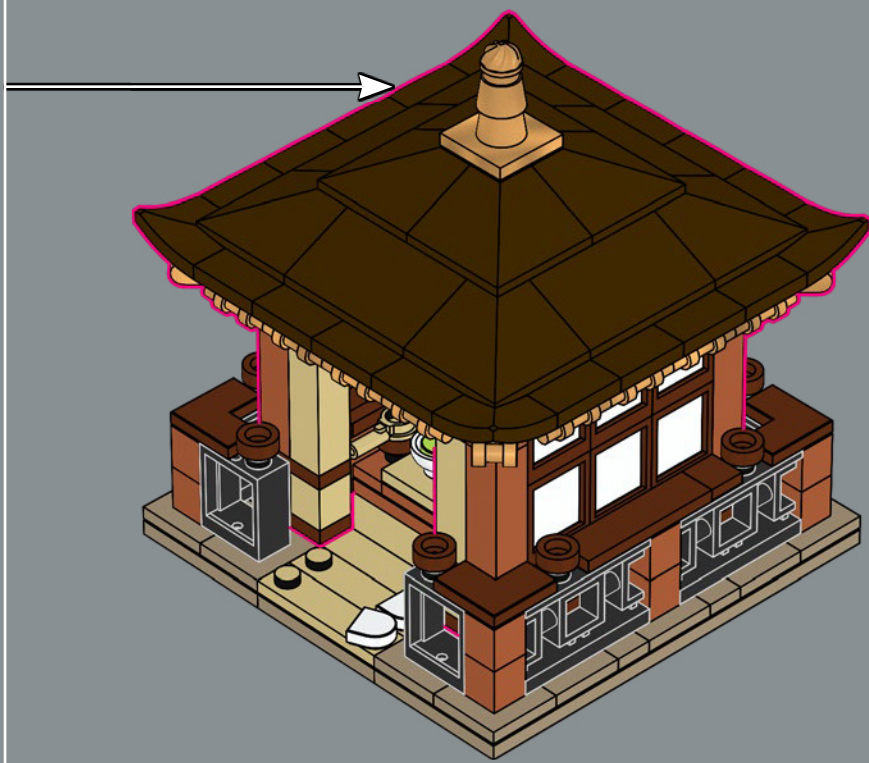

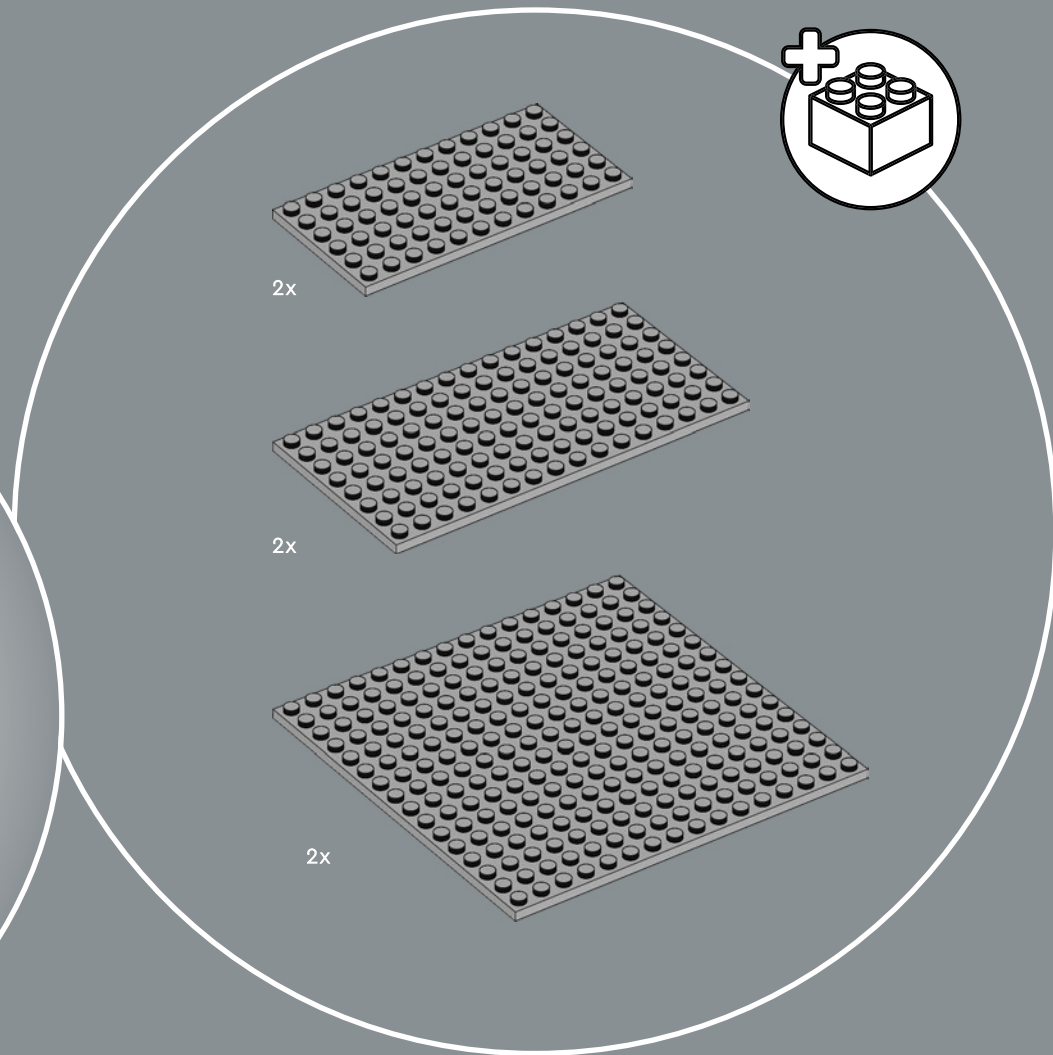

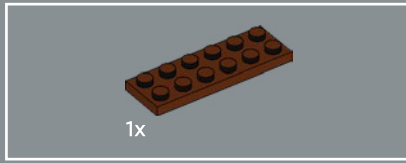
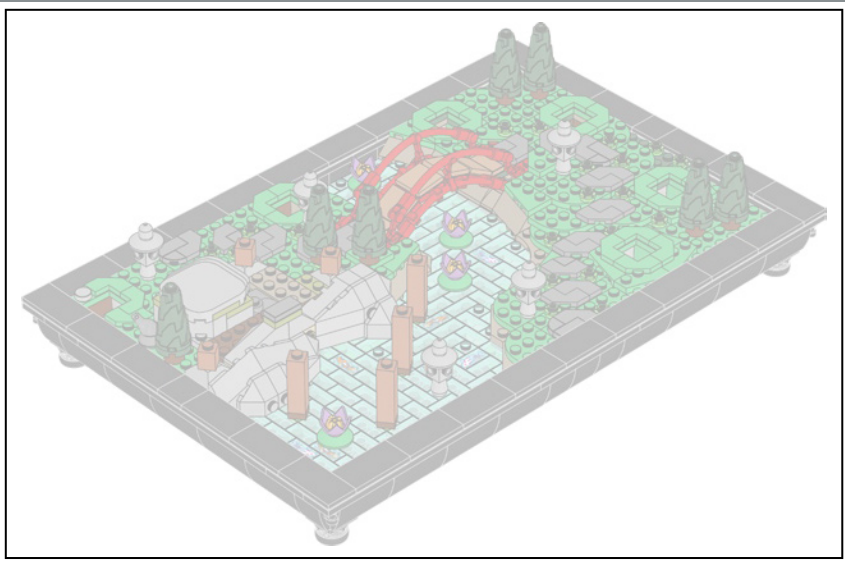

44

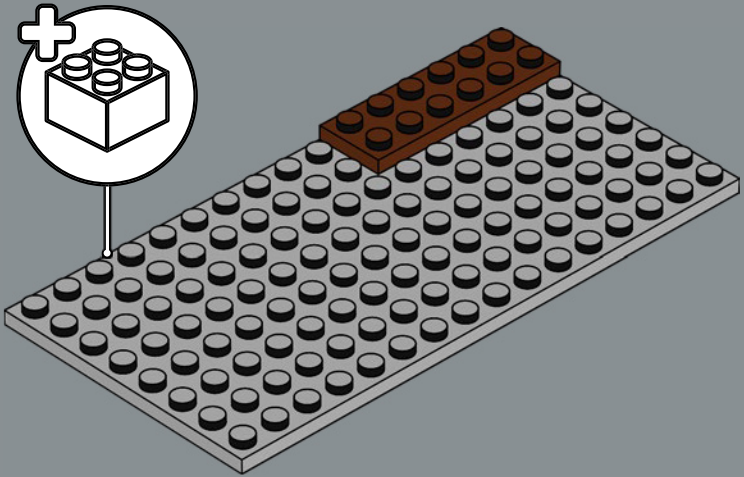

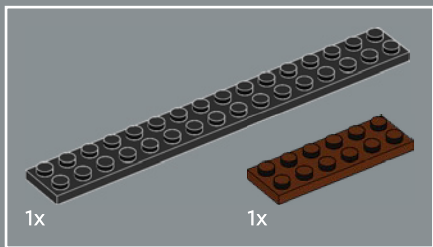

45

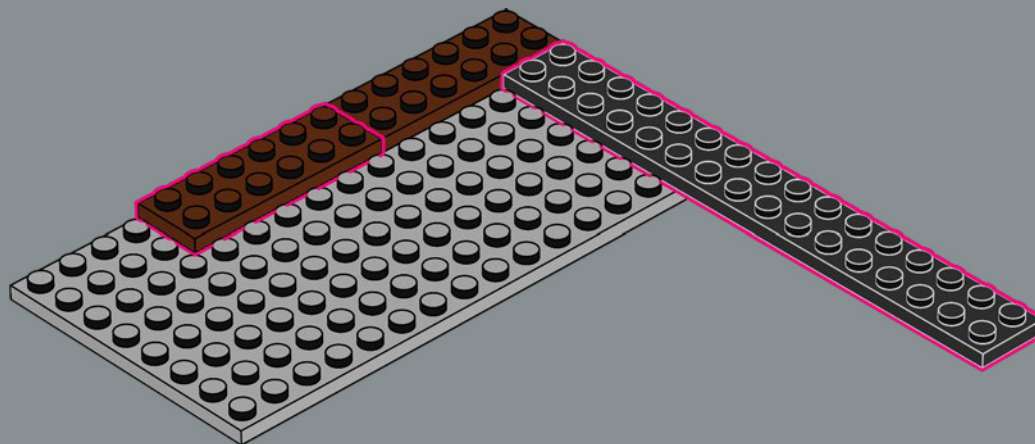

46

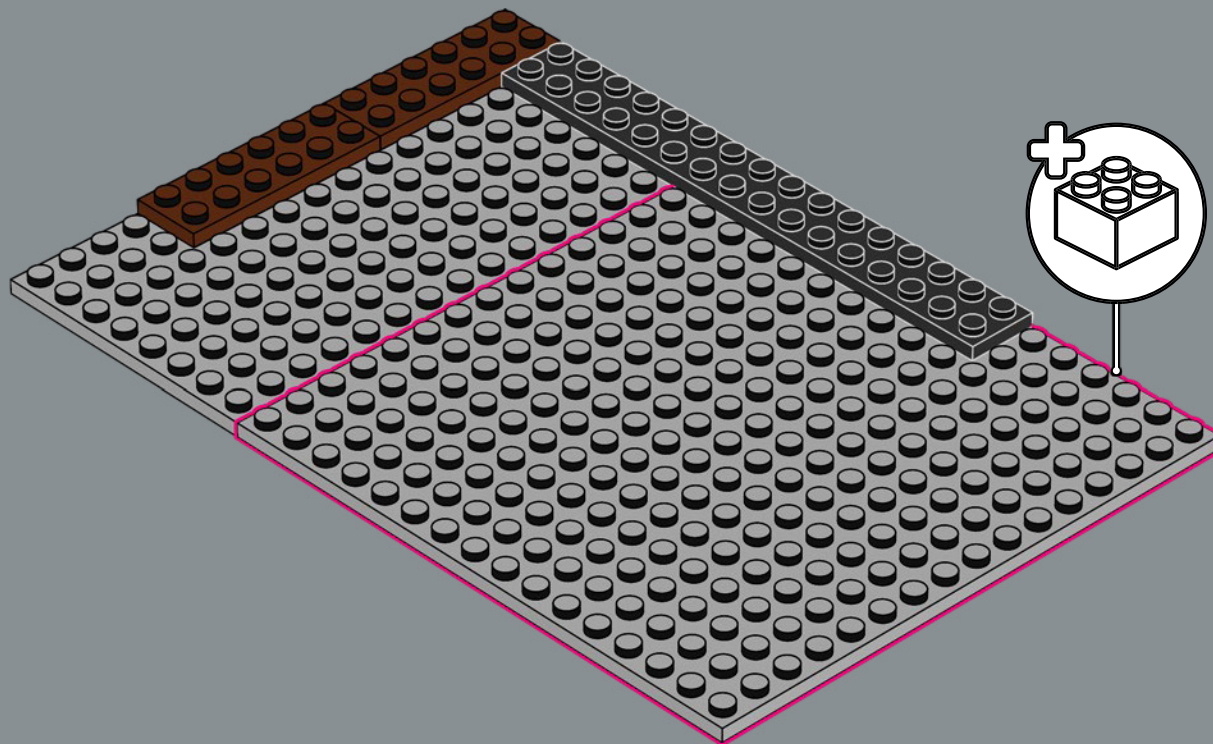

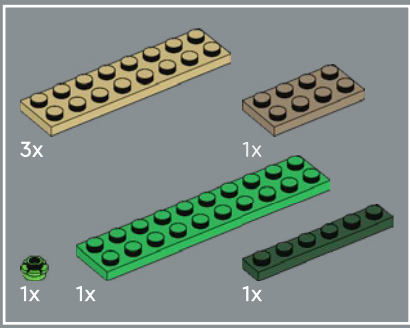

47

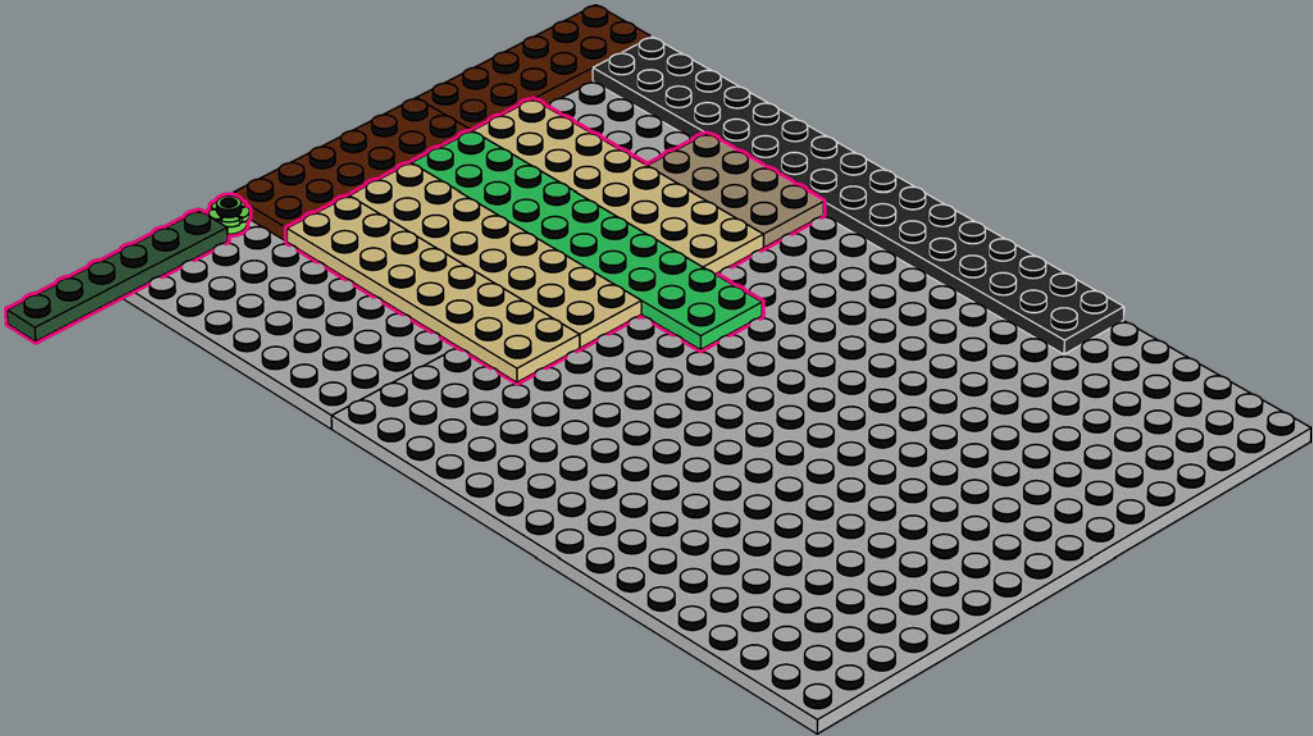

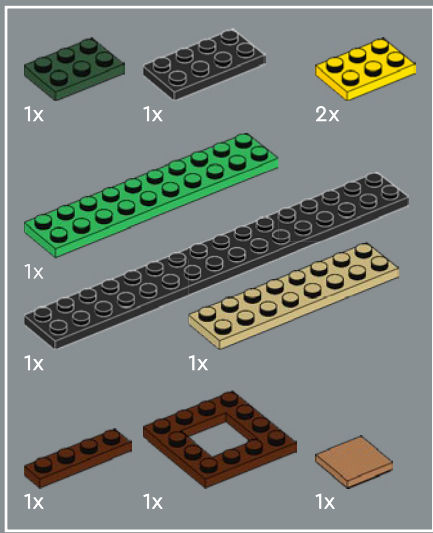

48

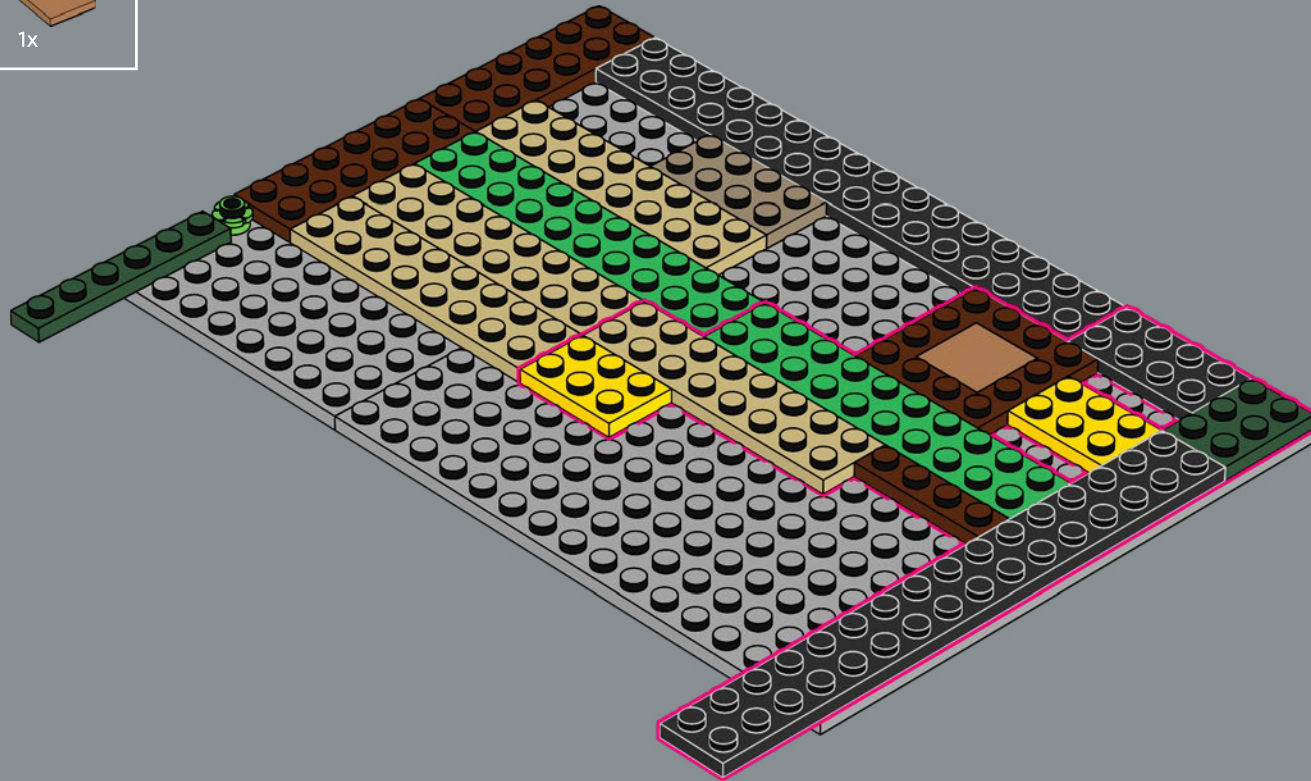

49

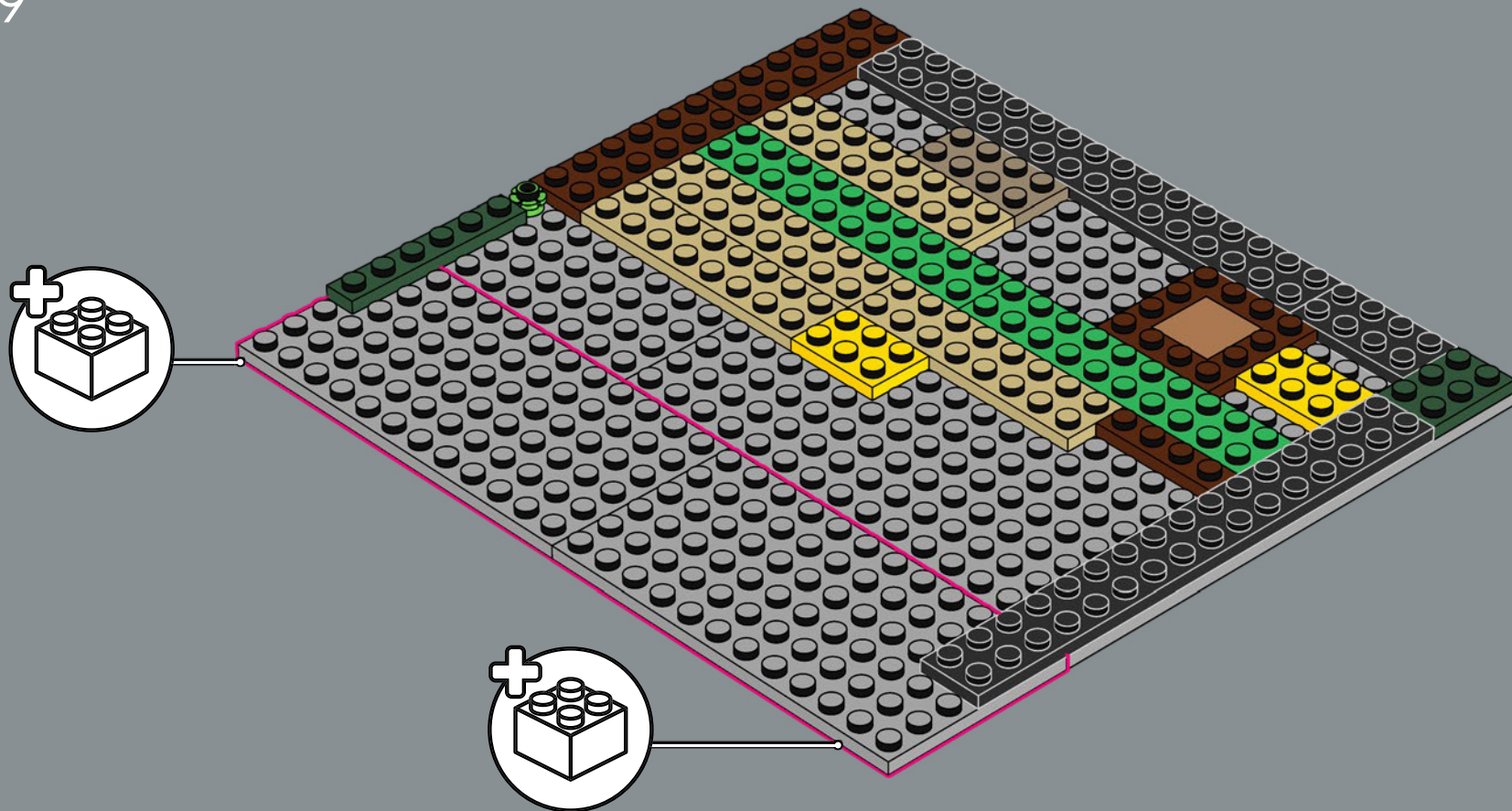

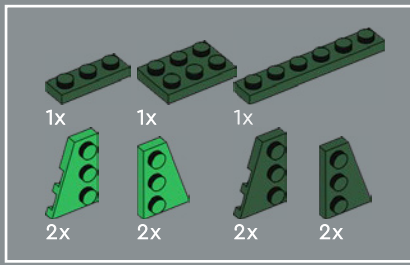

50

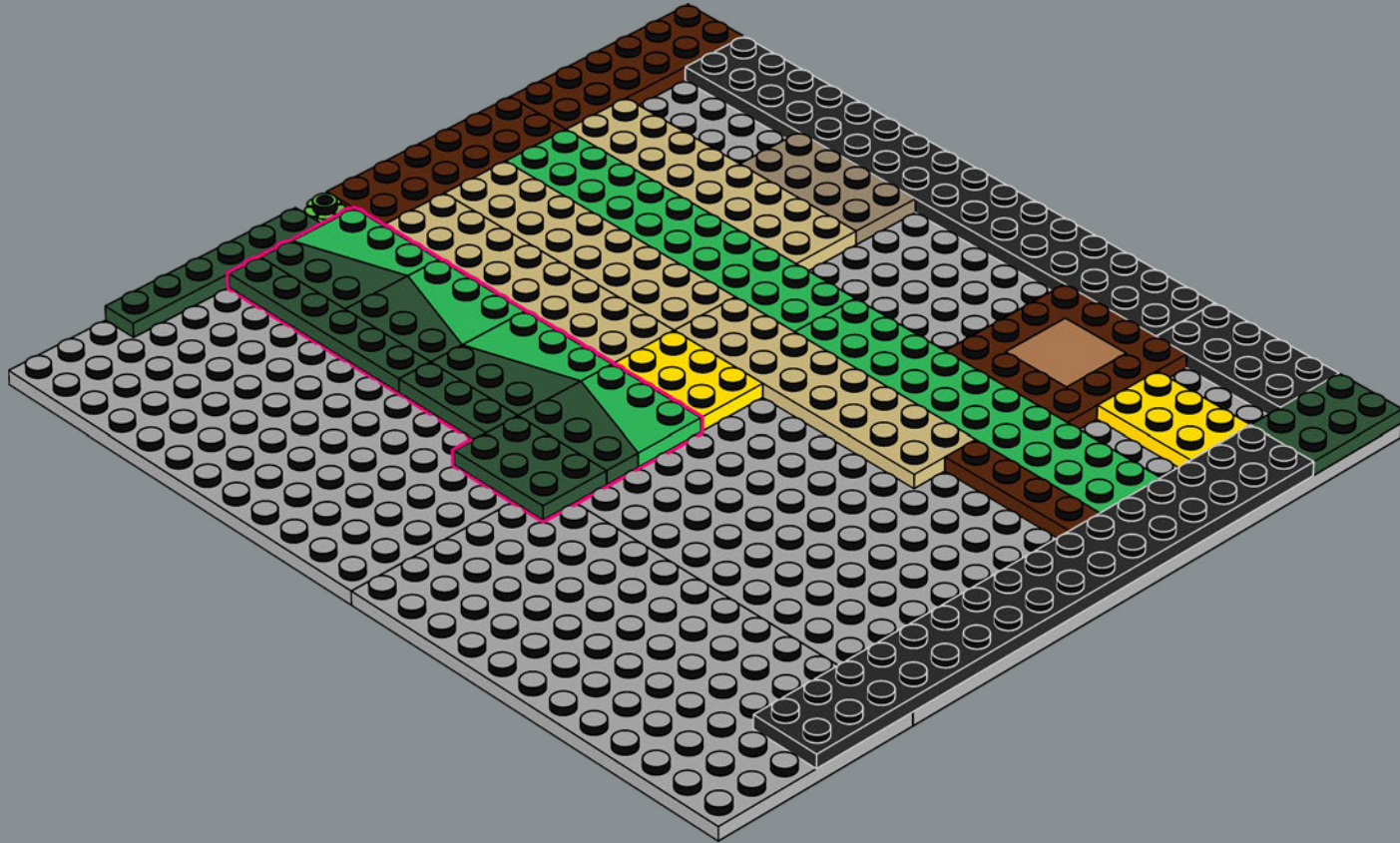

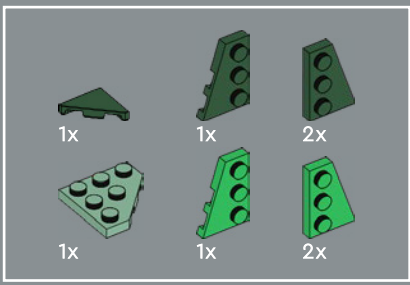

51

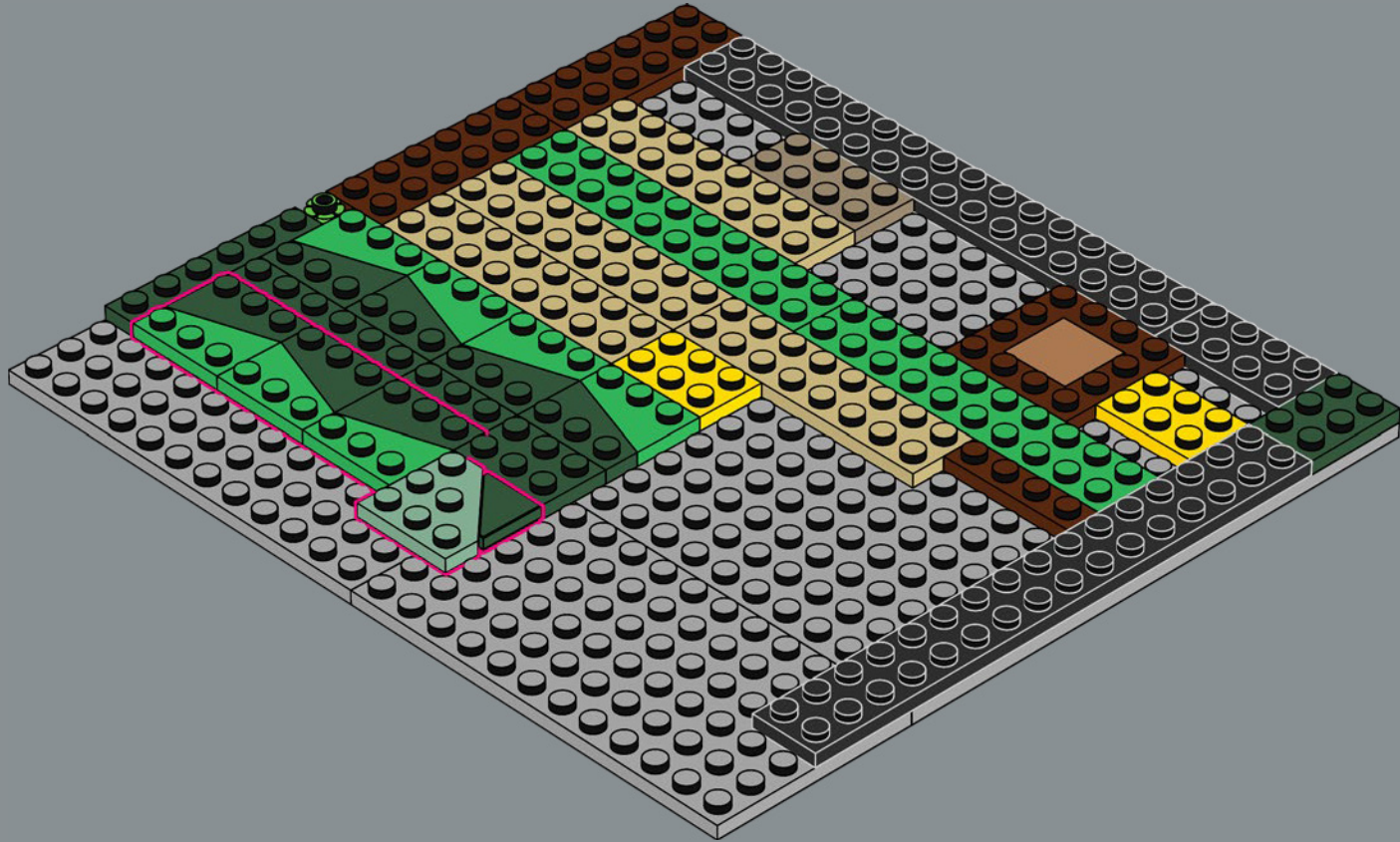

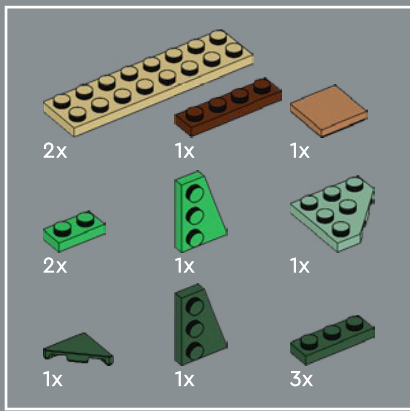

52

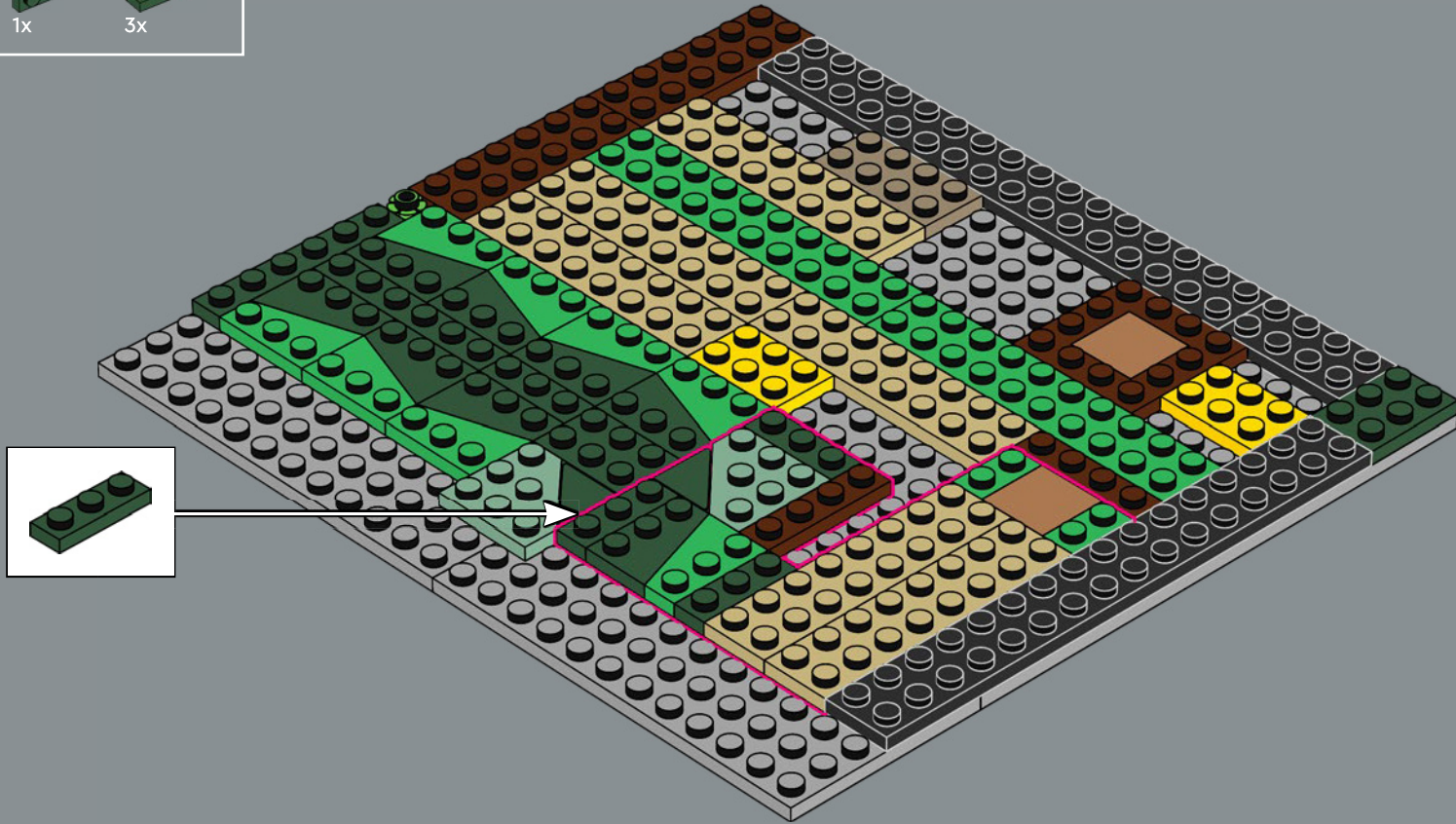

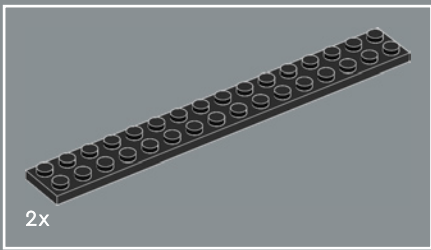

53

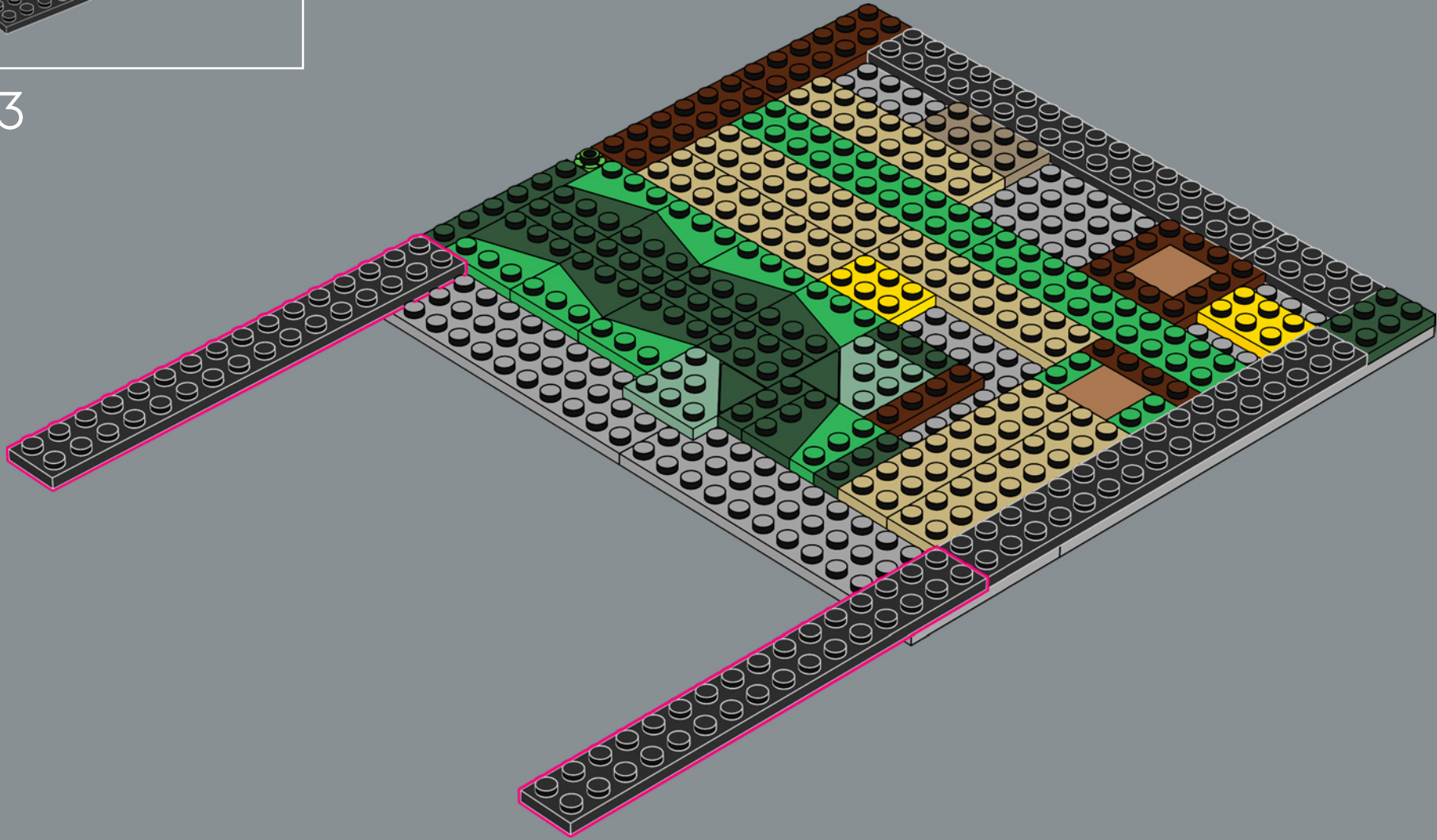

54

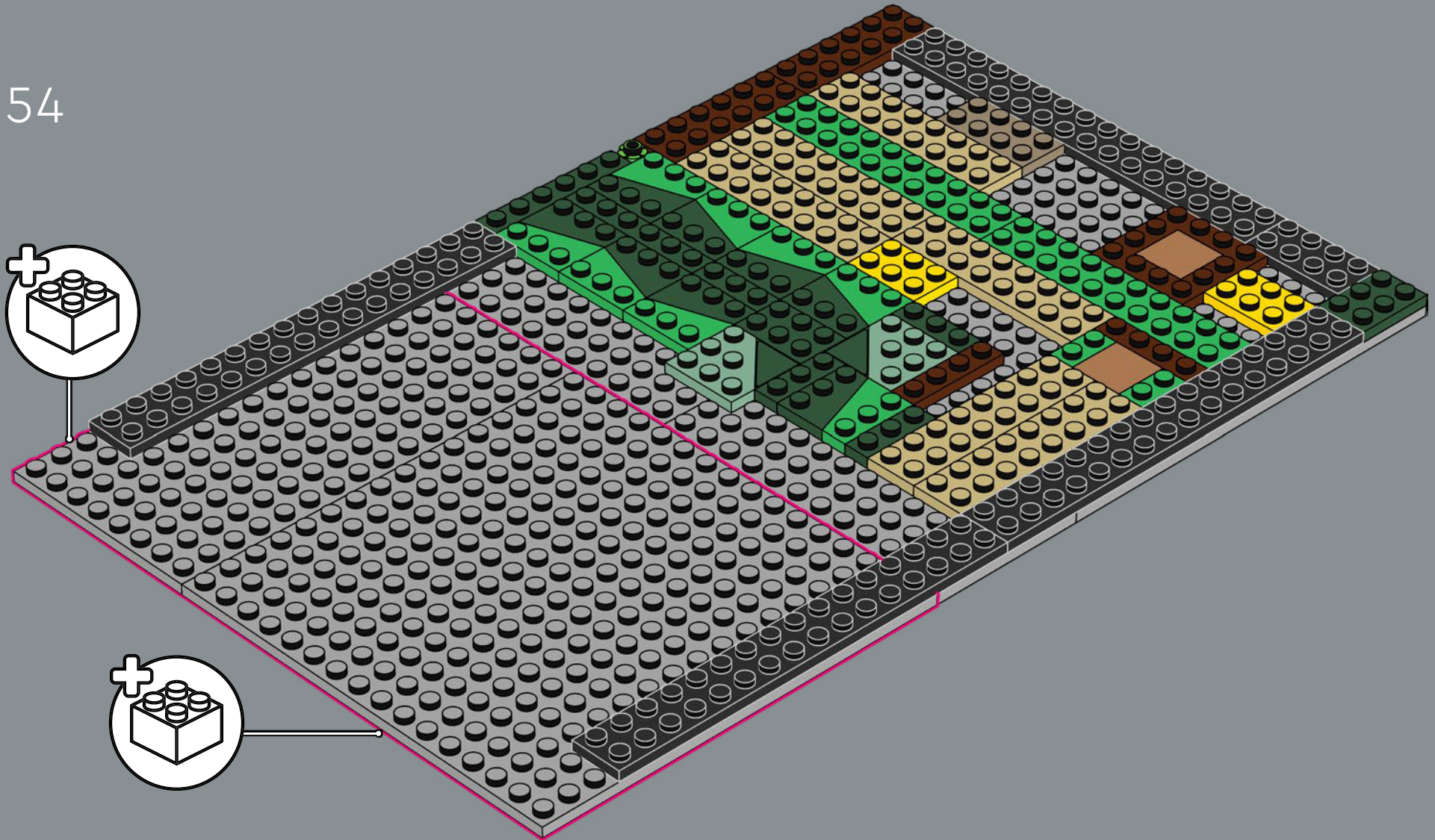

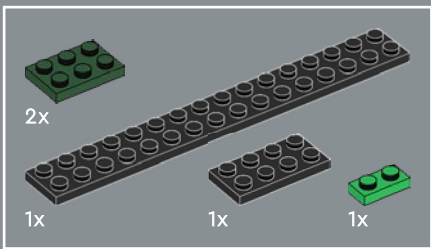

55

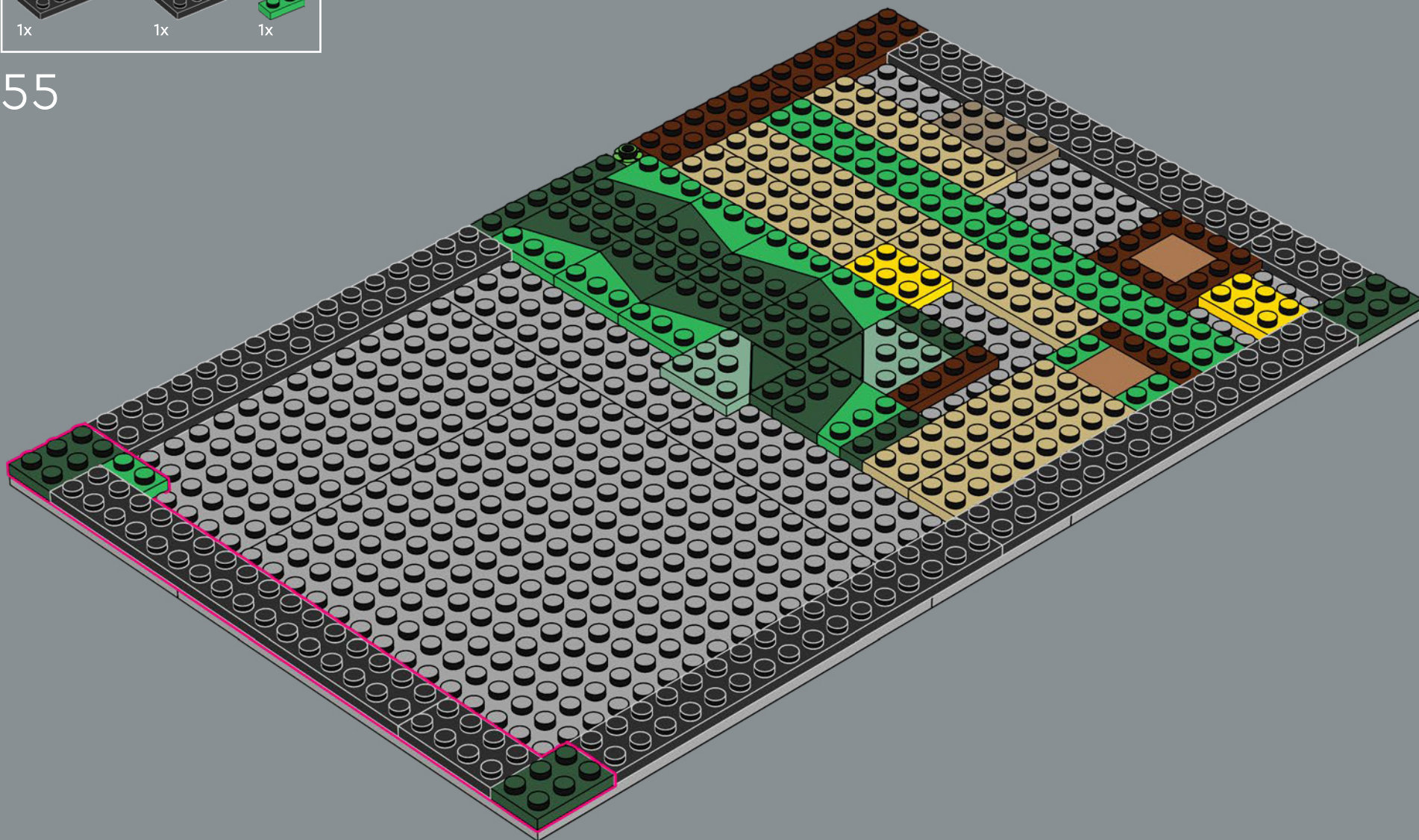

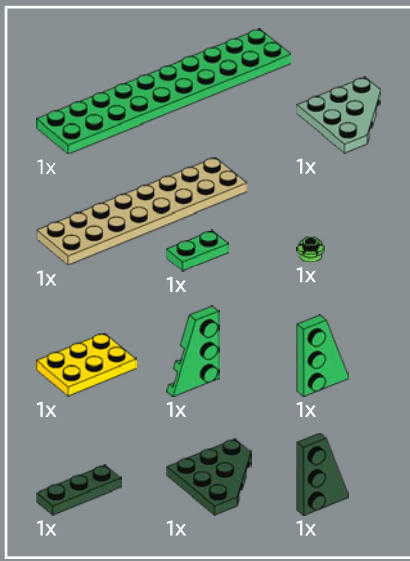

56

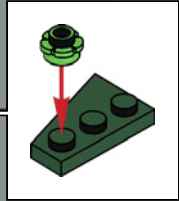
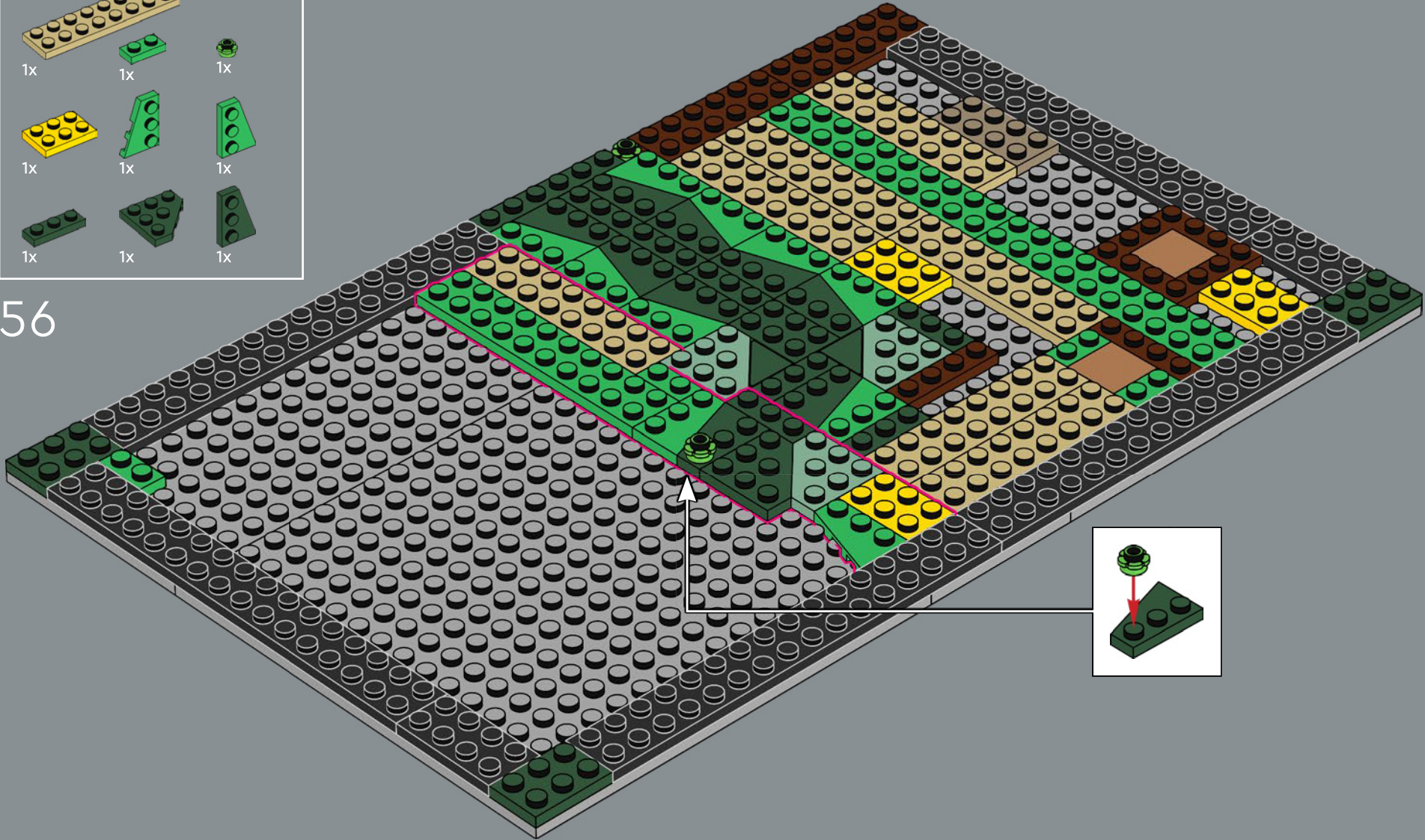

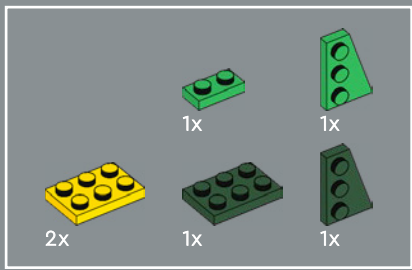

57

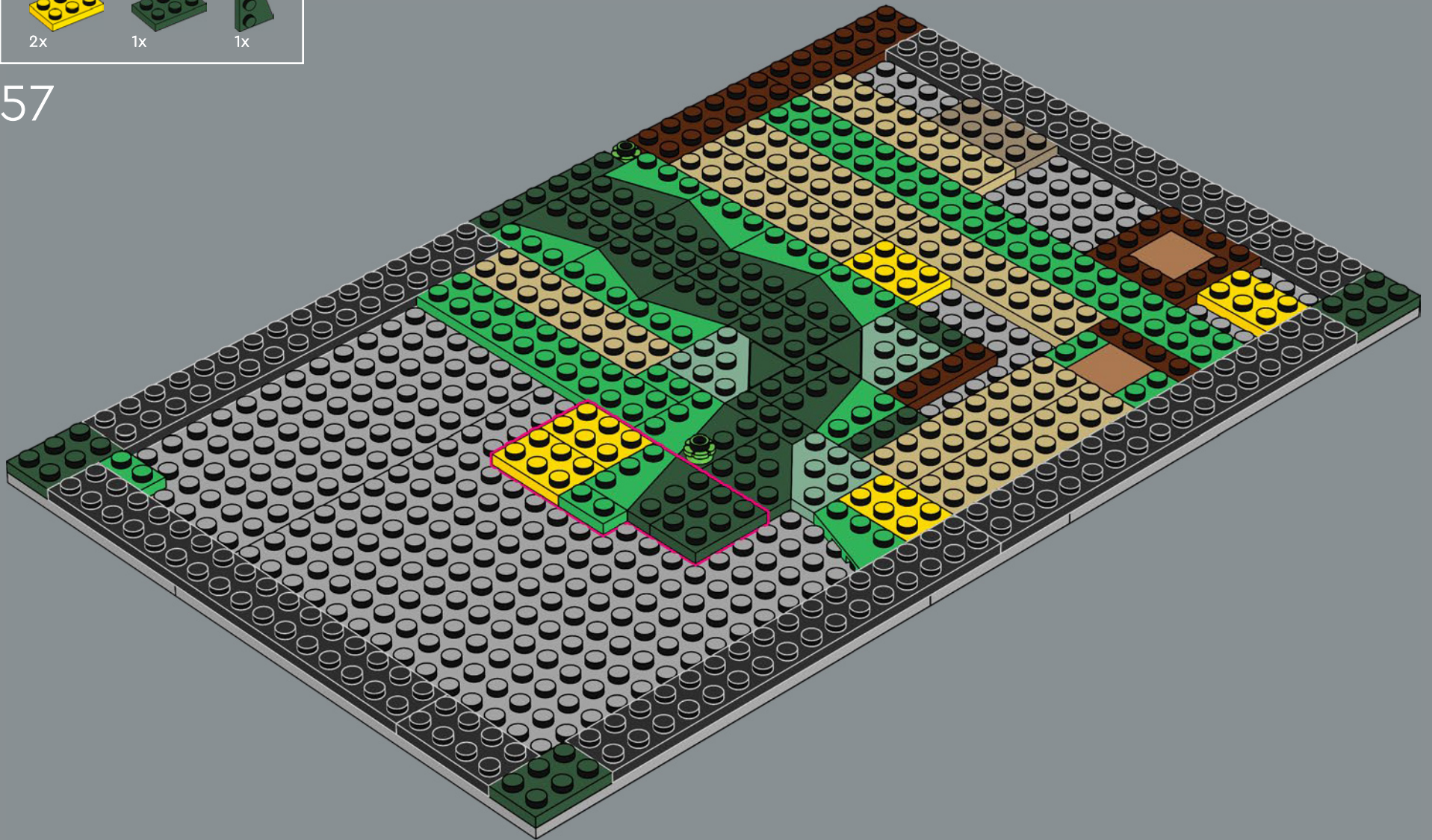

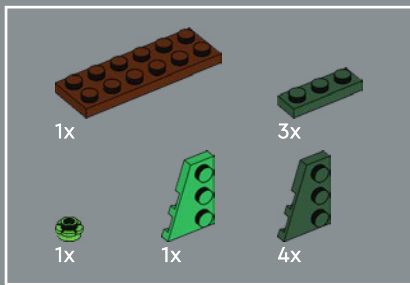

58

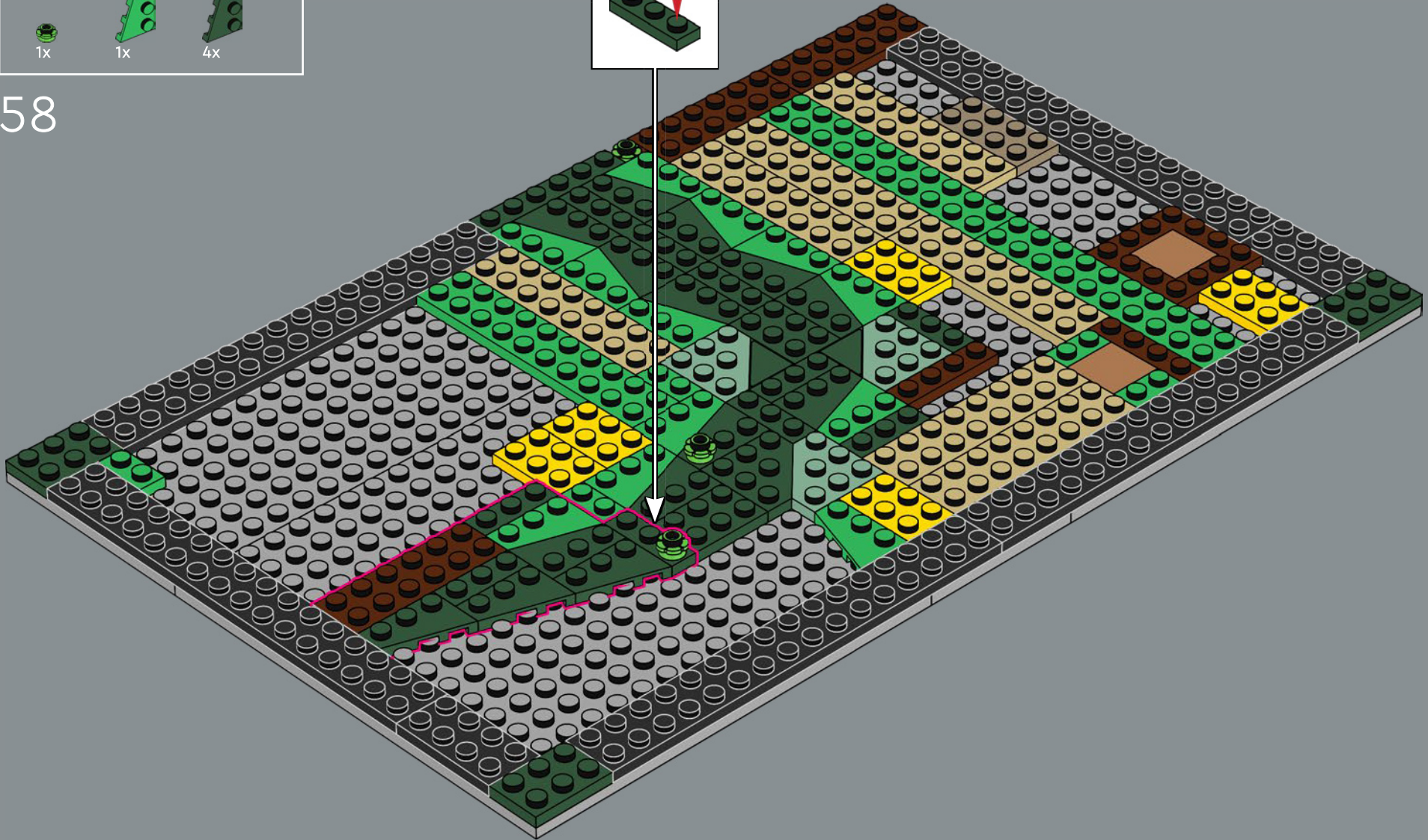
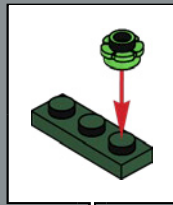

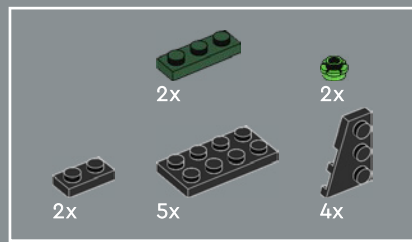

59

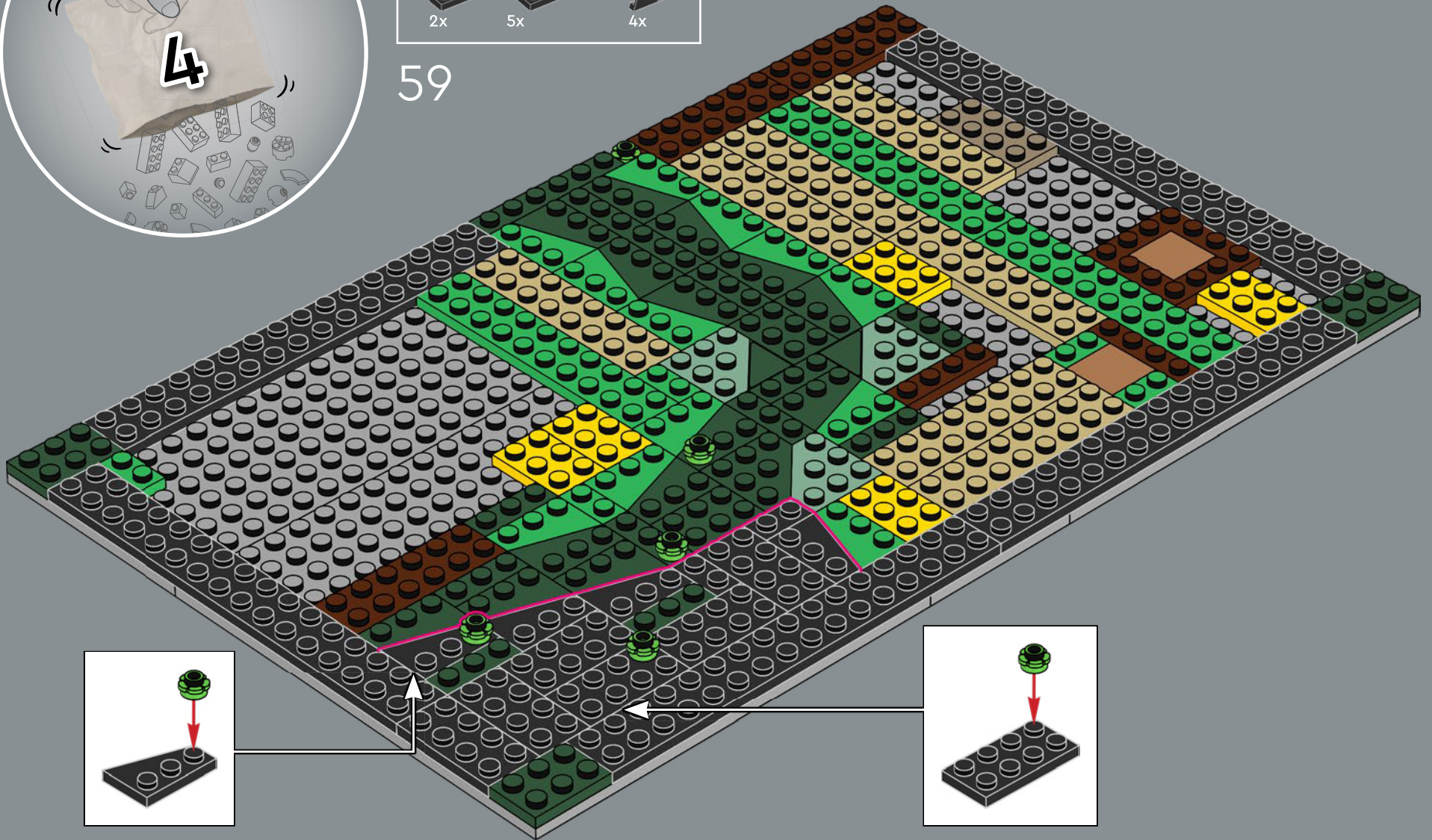

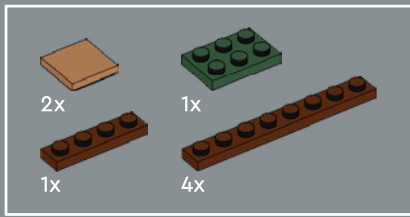

60

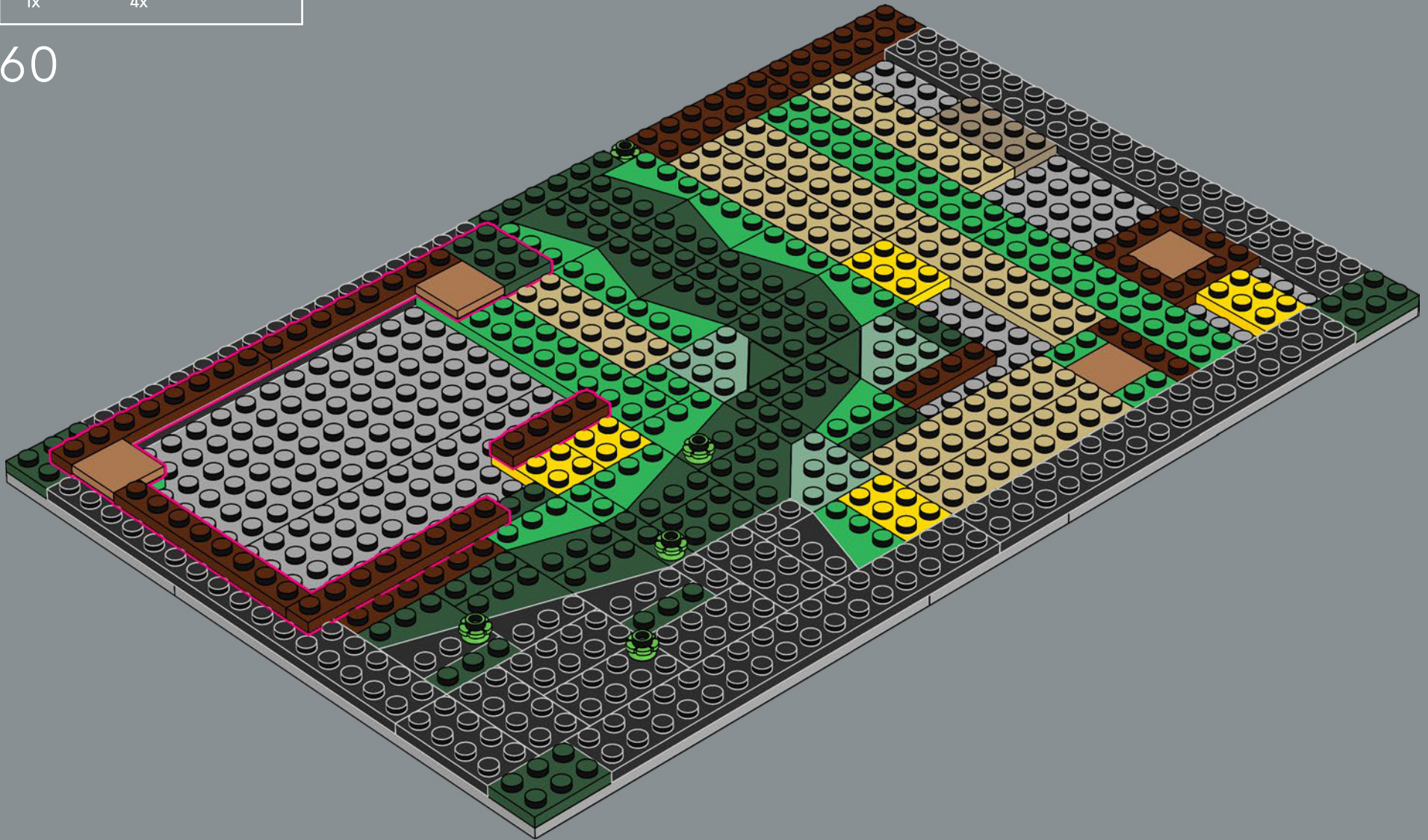

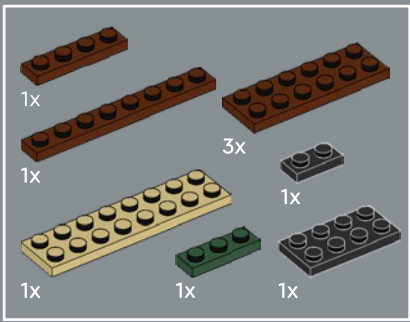

61

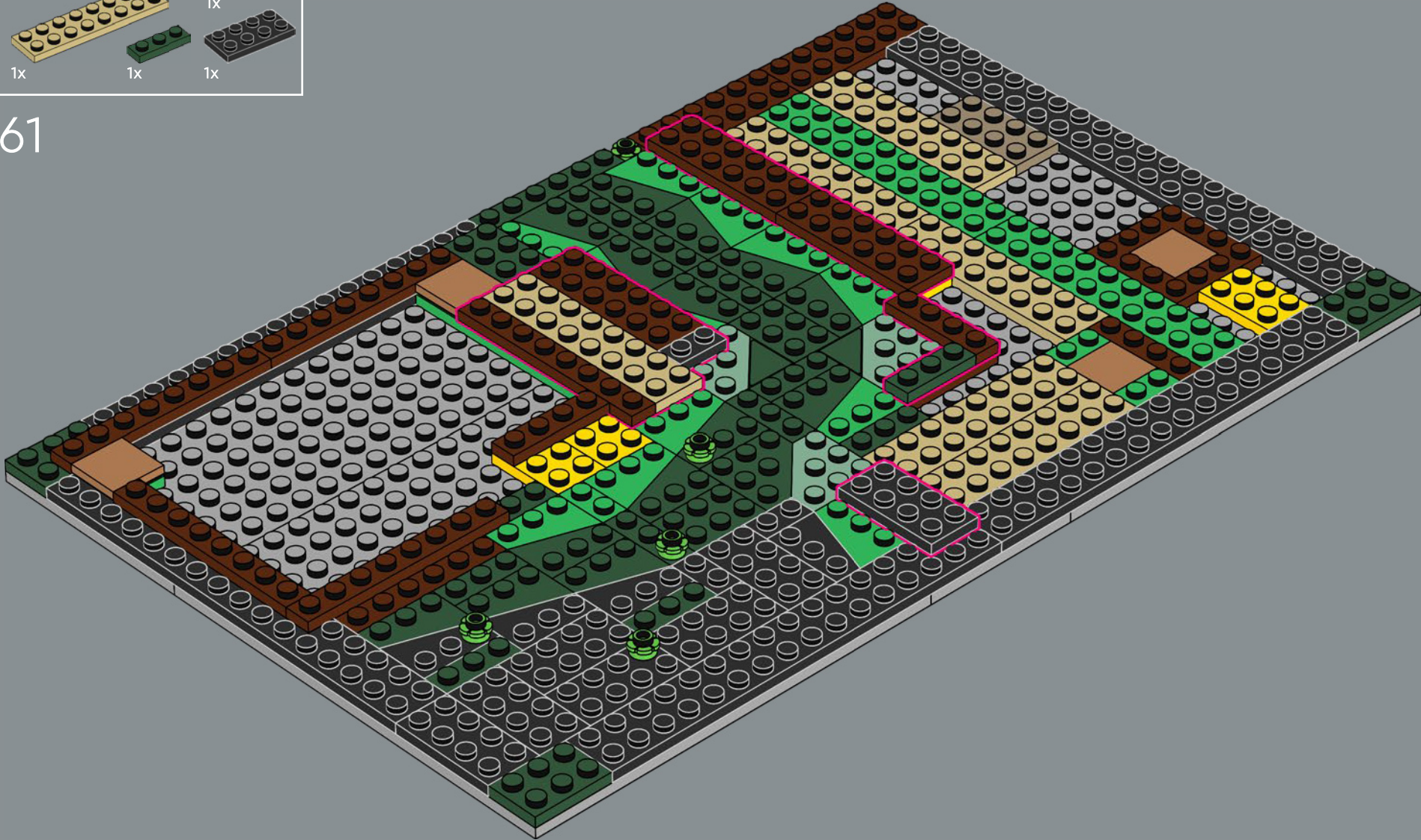

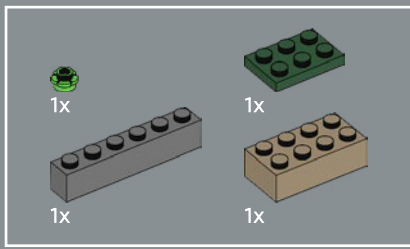

62

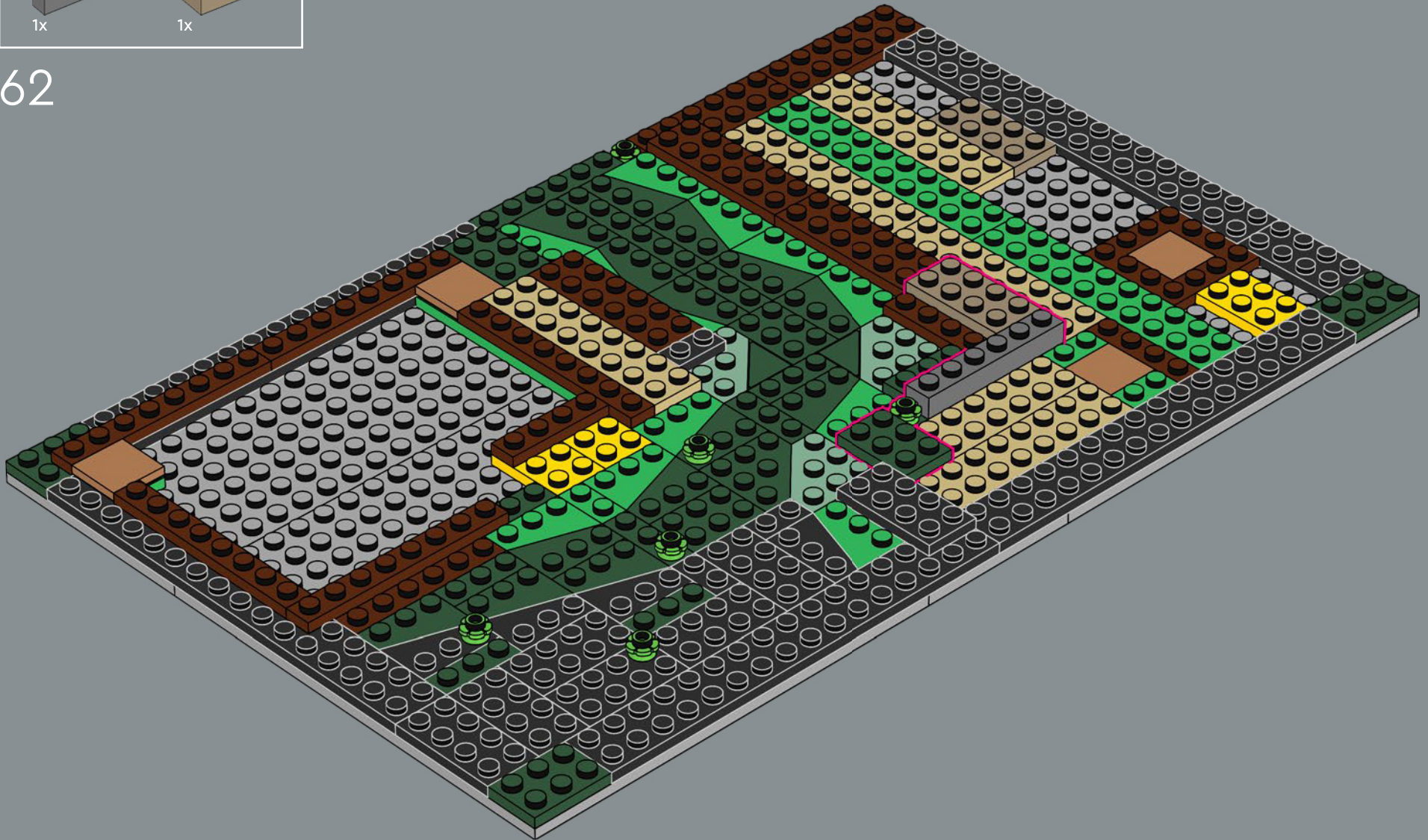

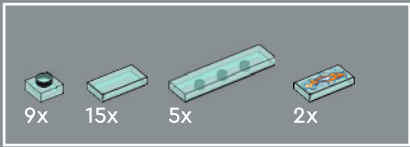

63

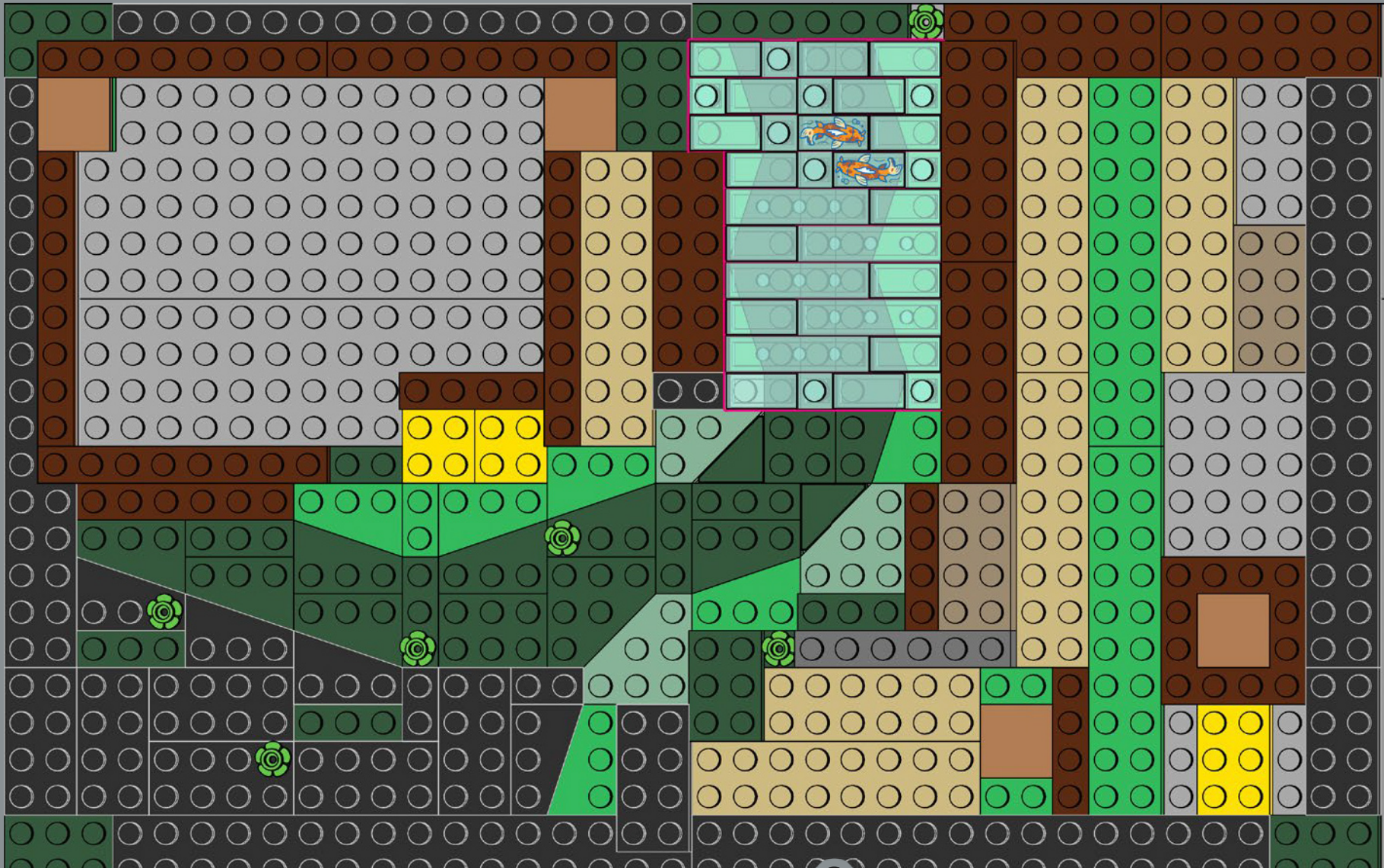

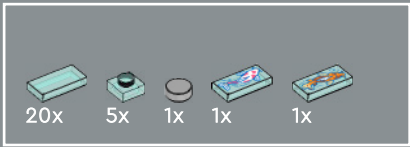

65

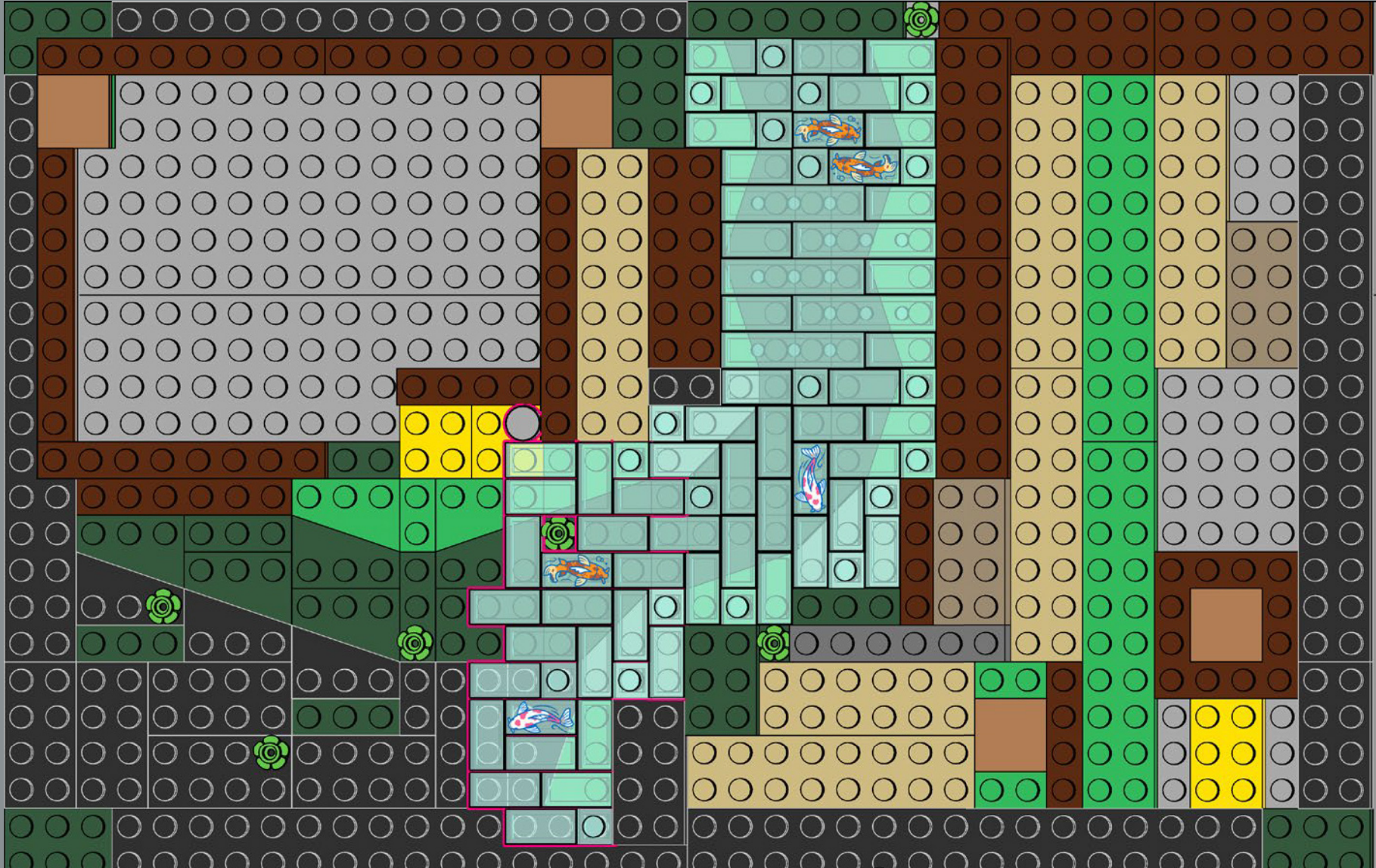

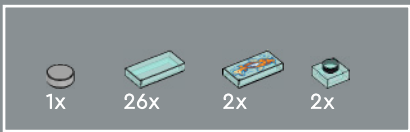

66

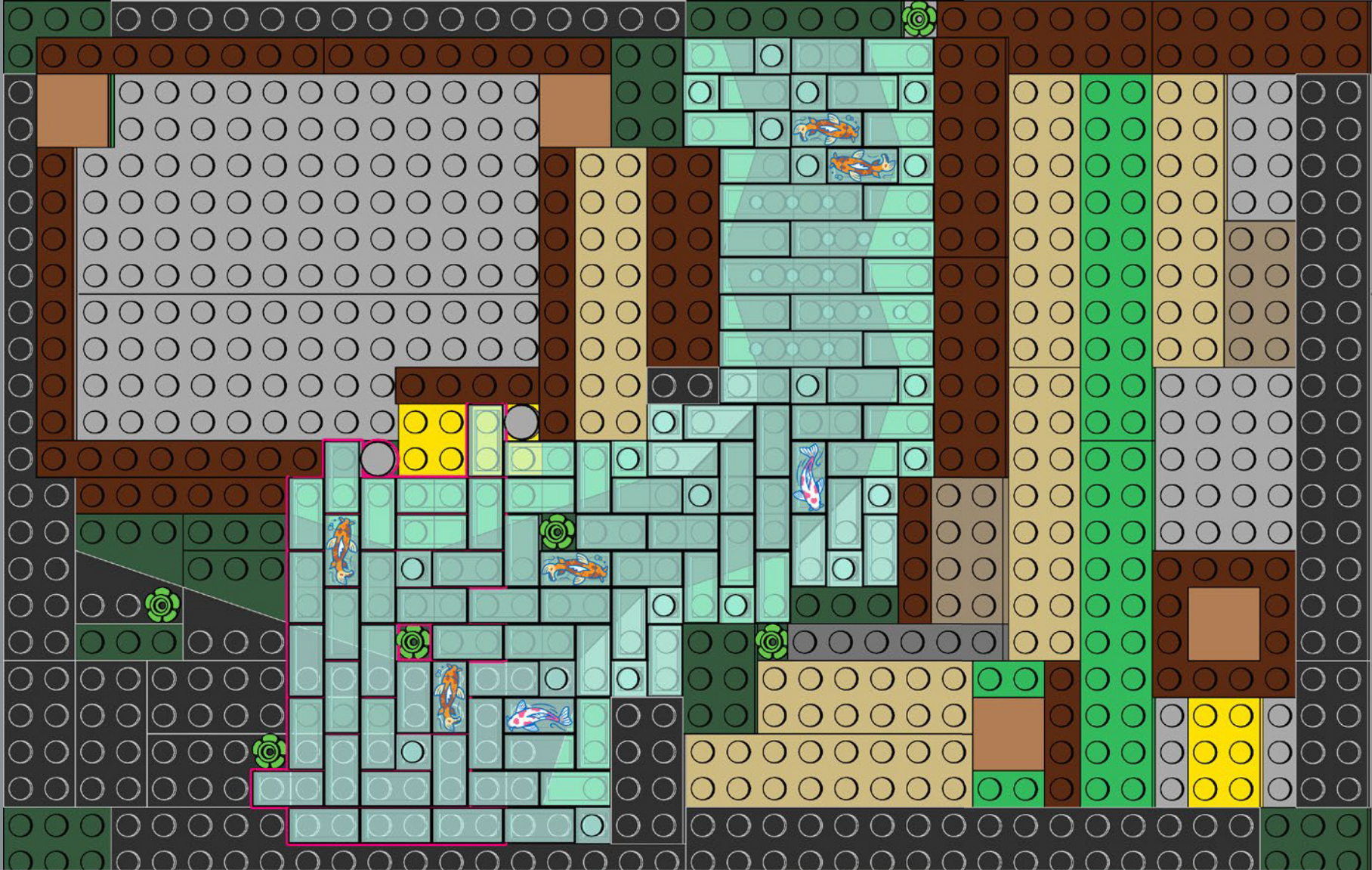

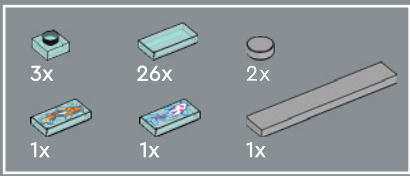

67

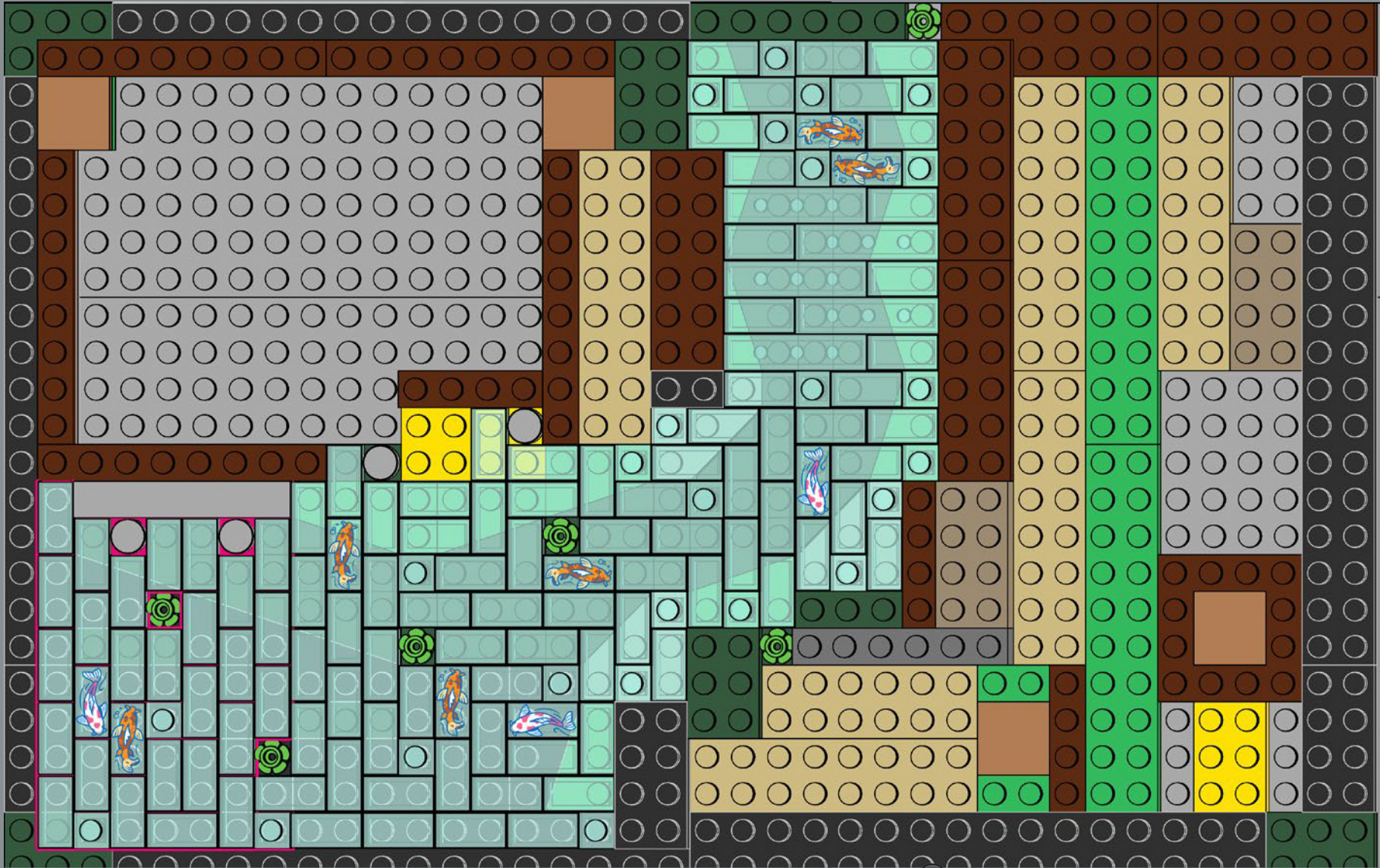



Le forme degli stagni di solito rappresentano un *kanji* (caratteri della scrittura giapponese) con un significato importante, come *kokoro*, o "cuore".

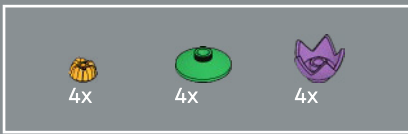

68

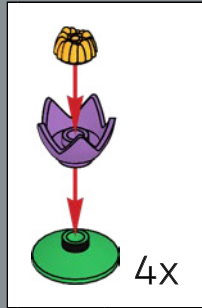

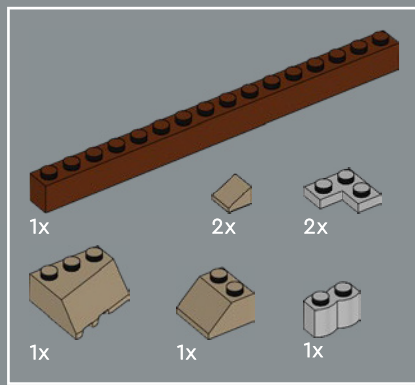

69



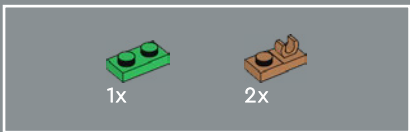

70



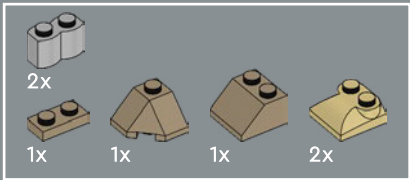

71

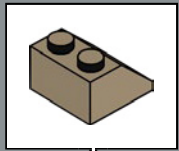
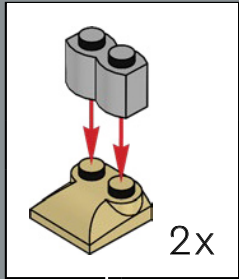

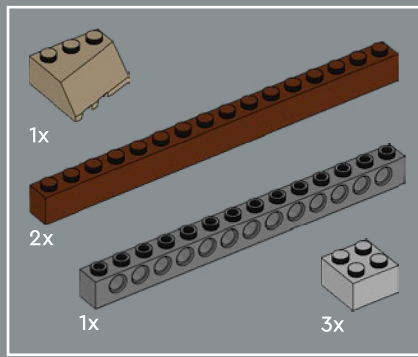

72



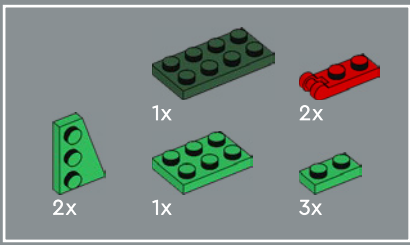

73

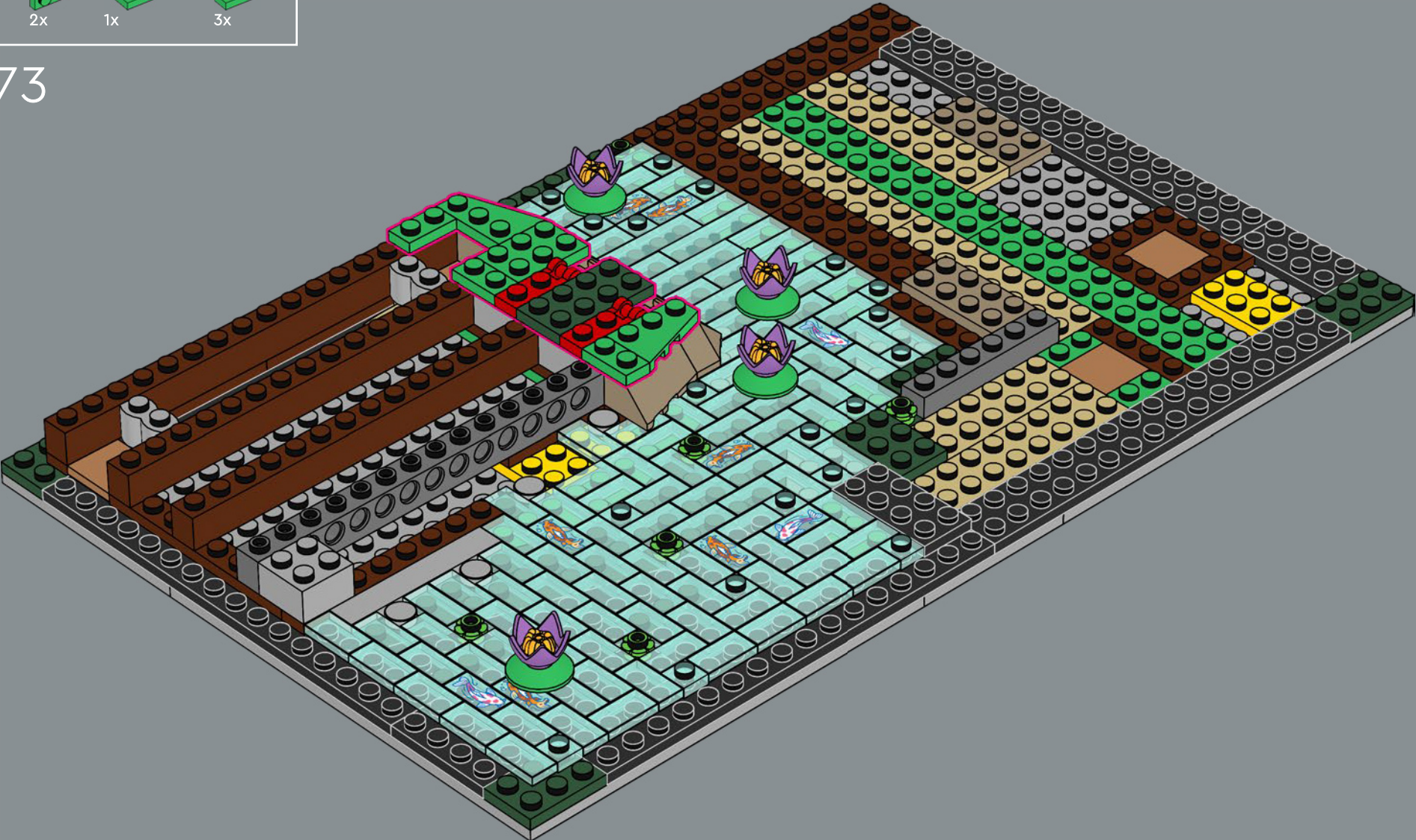

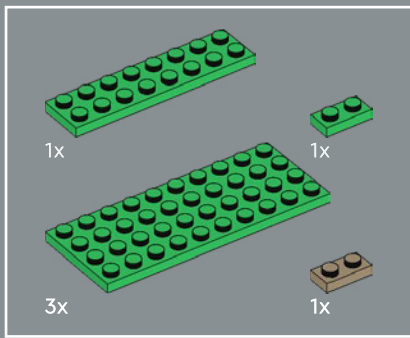

74



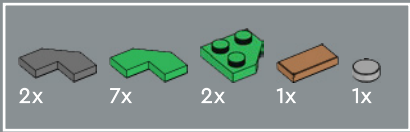

75



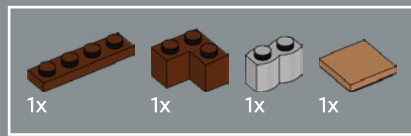

76



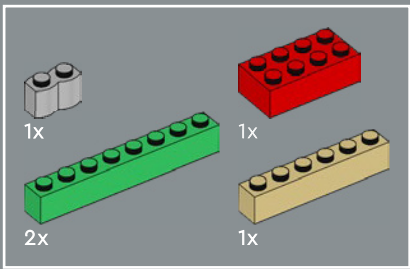

77



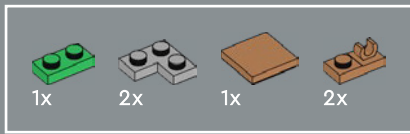

78

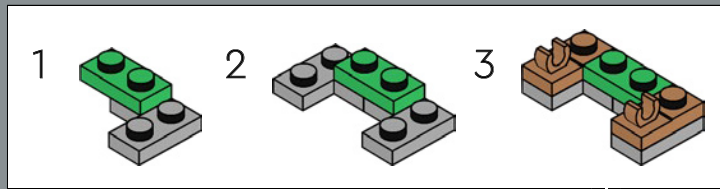

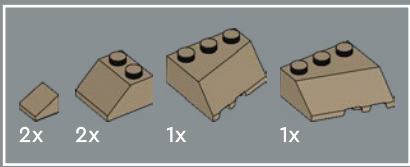

79

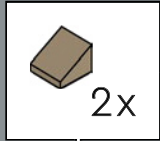

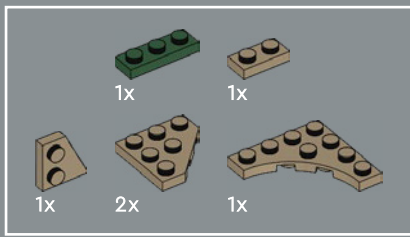

80



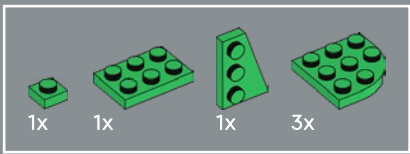

81



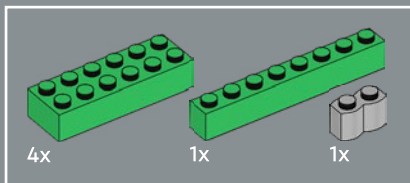

82



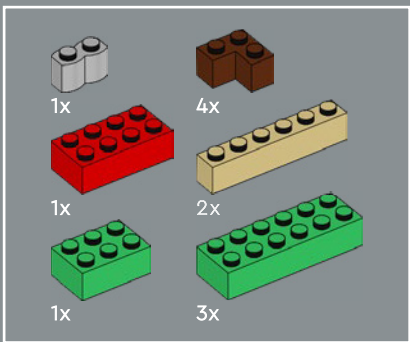

83



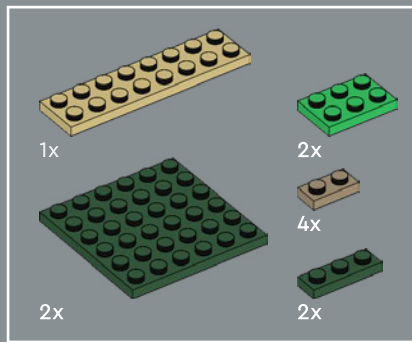

84



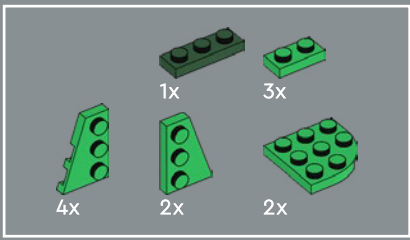

85



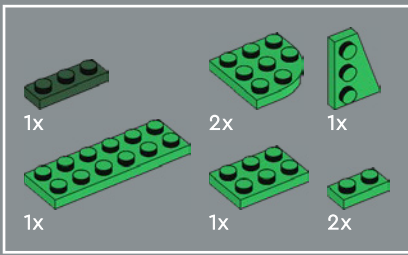

86



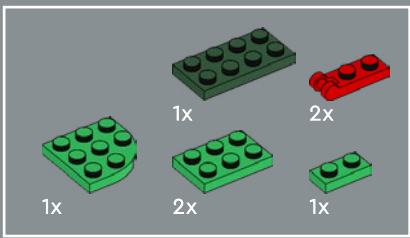

87



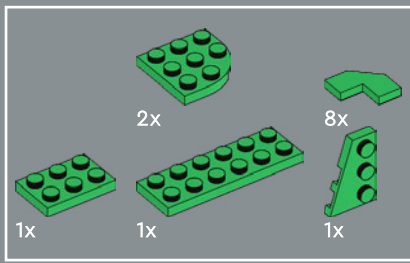

88





Le isole in questi giardini possono essere simboli di montagne mistiche o mitiche, tartarughe o gru (spesso associate alla longevità).

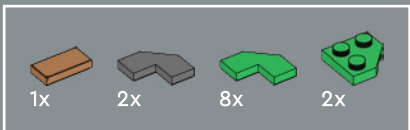

89



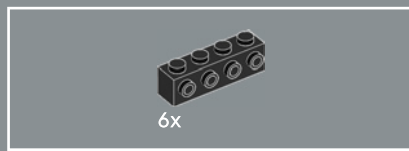

90



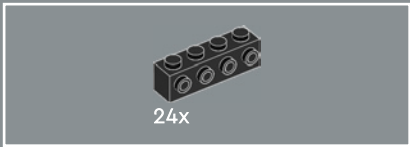

91



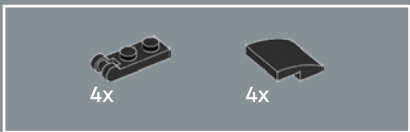

92

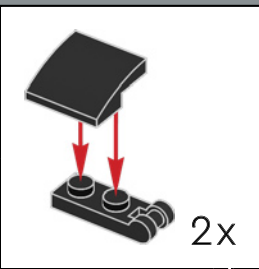
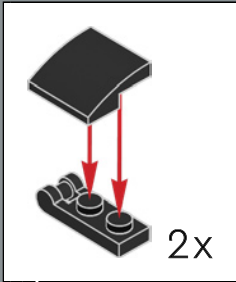

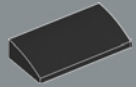

26x

93



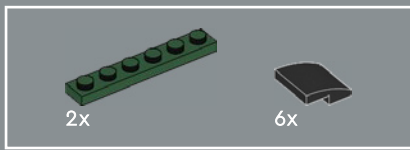

94

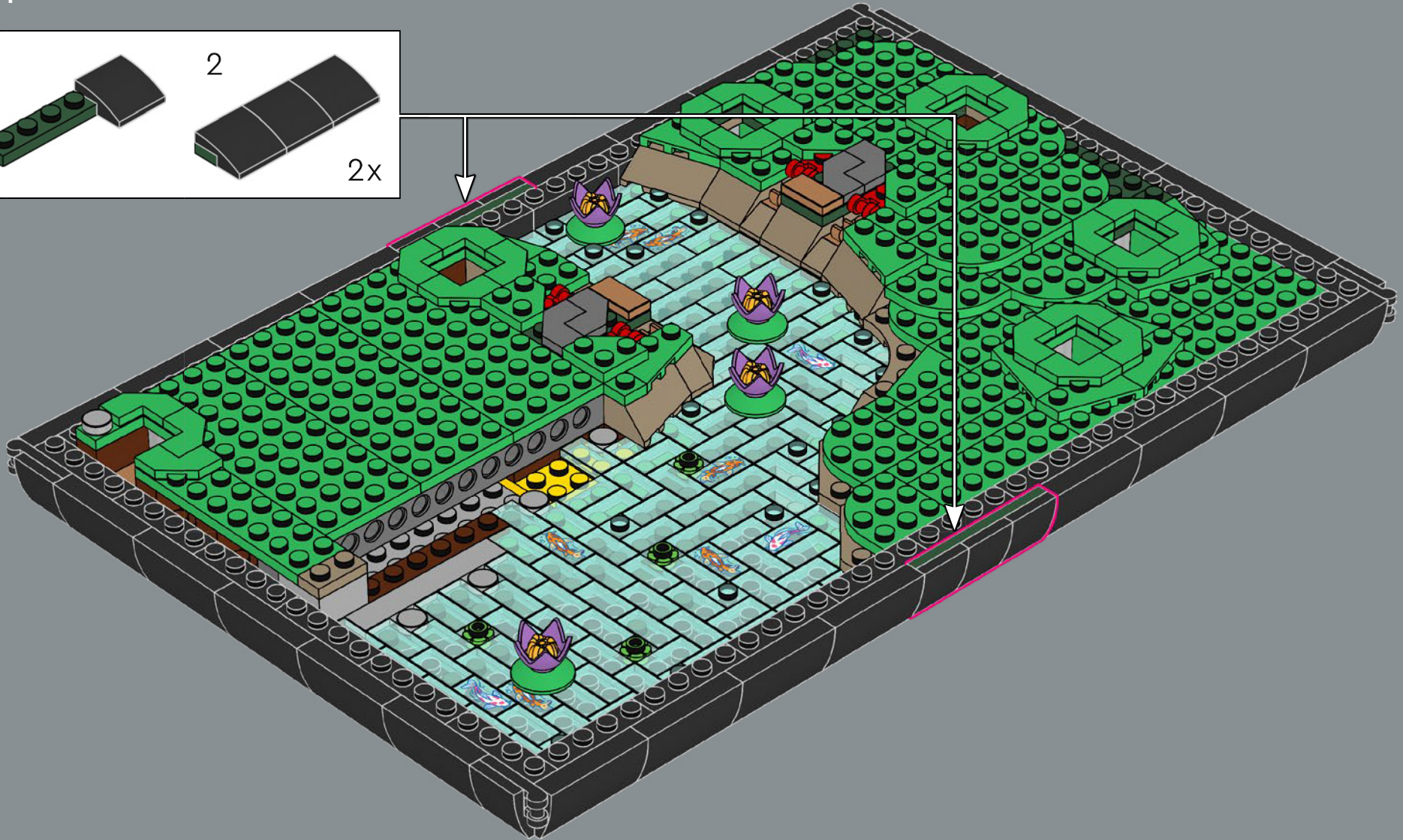
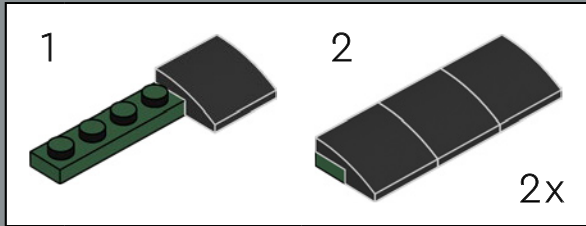

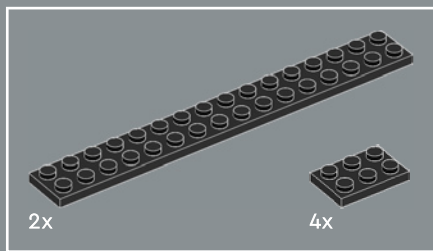

95



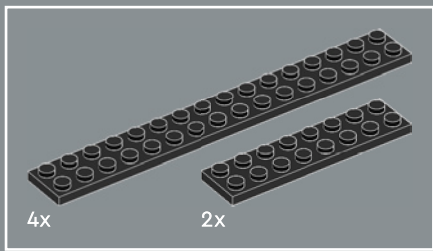

96



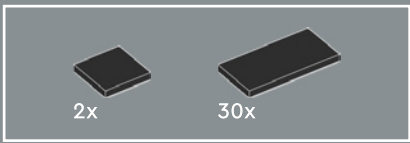

Riconosci il design del telaio di base di questo modello?
Abbiamo riutilizzato il design del vaso dei fiori del set Albero
Bonsai LEGO® Icons 10281 per ricreare un aspetto simile.

97

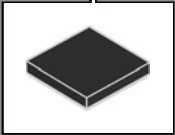
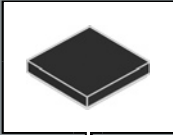

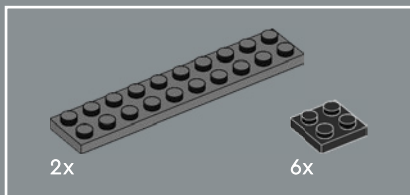

98

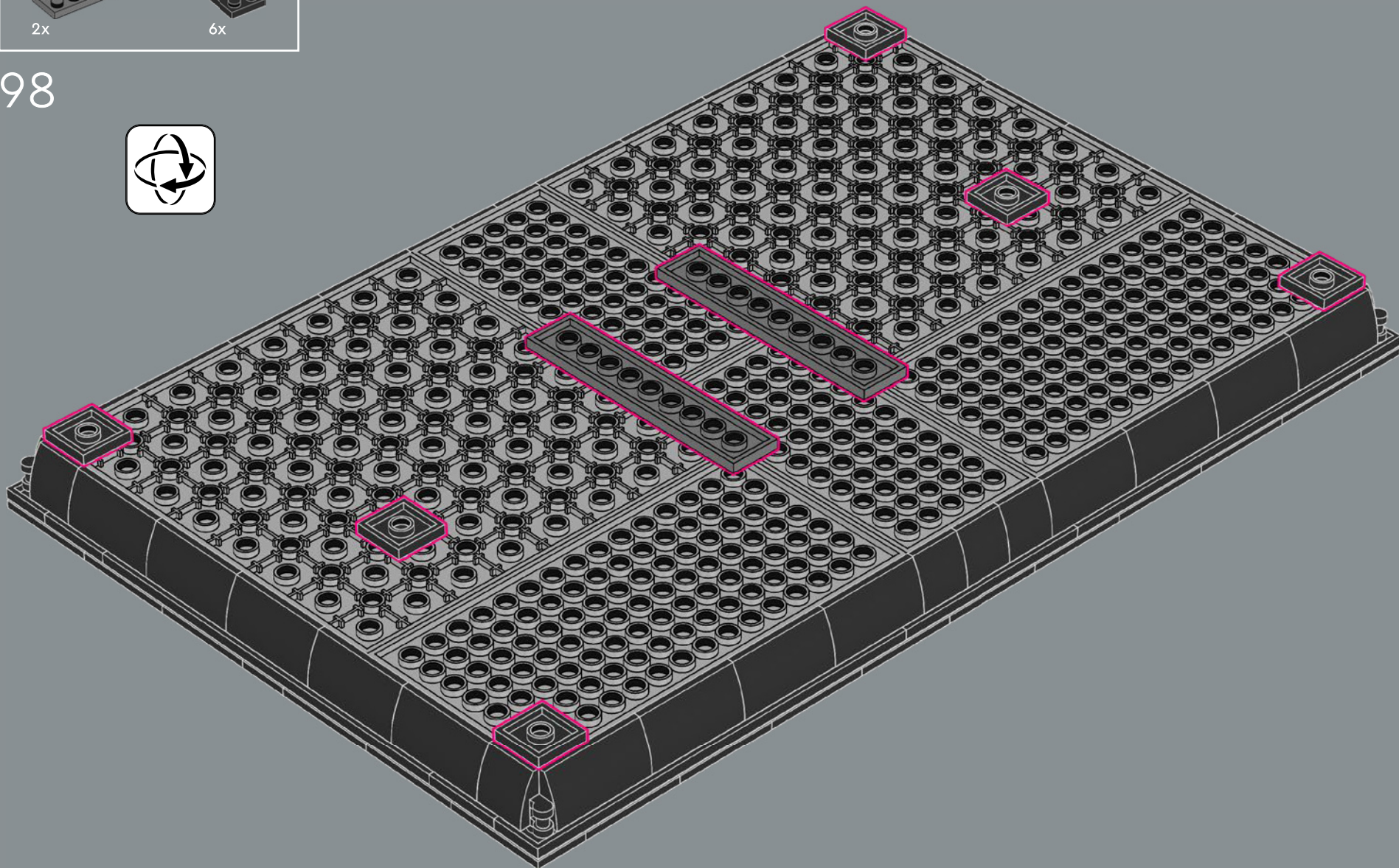



99

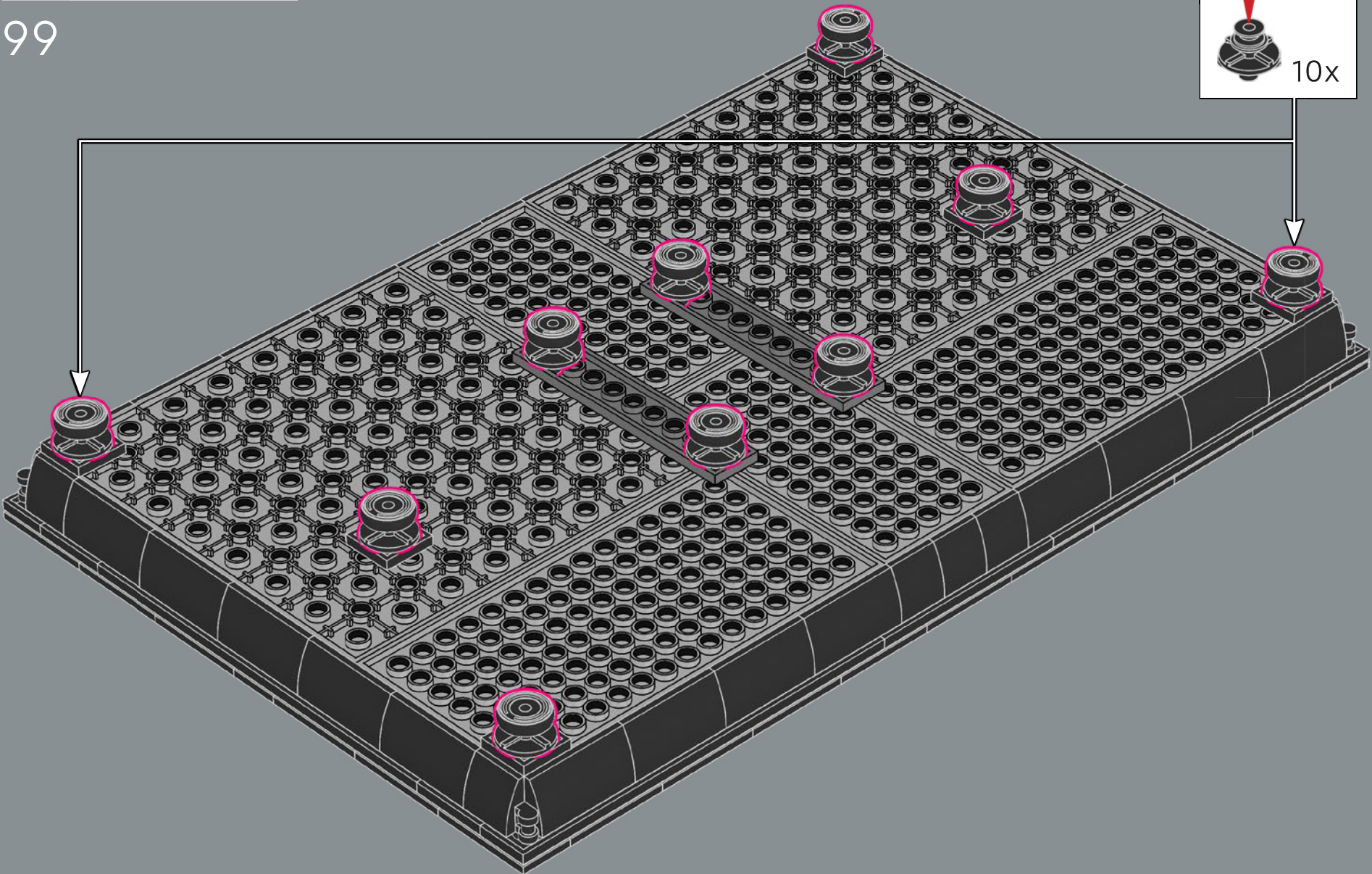
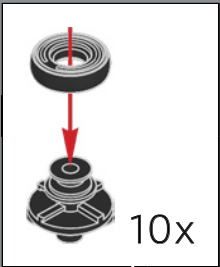



2x 12x 4x 16x



100

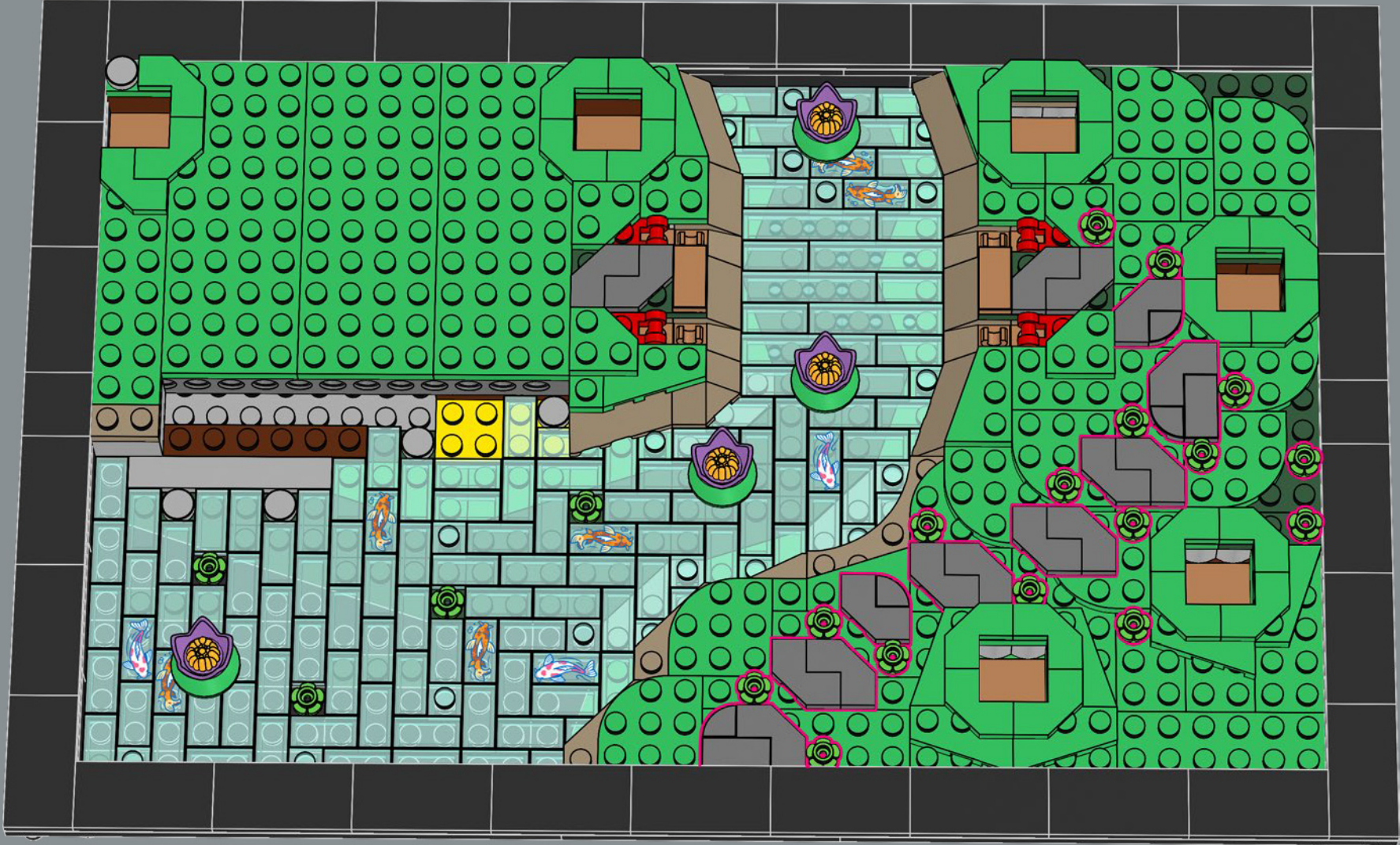

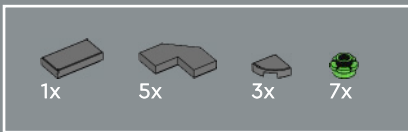

I sentieri tortuosi invitano a osservare il giardino (e forse anche altre cose?) da diverse prospettive.

101

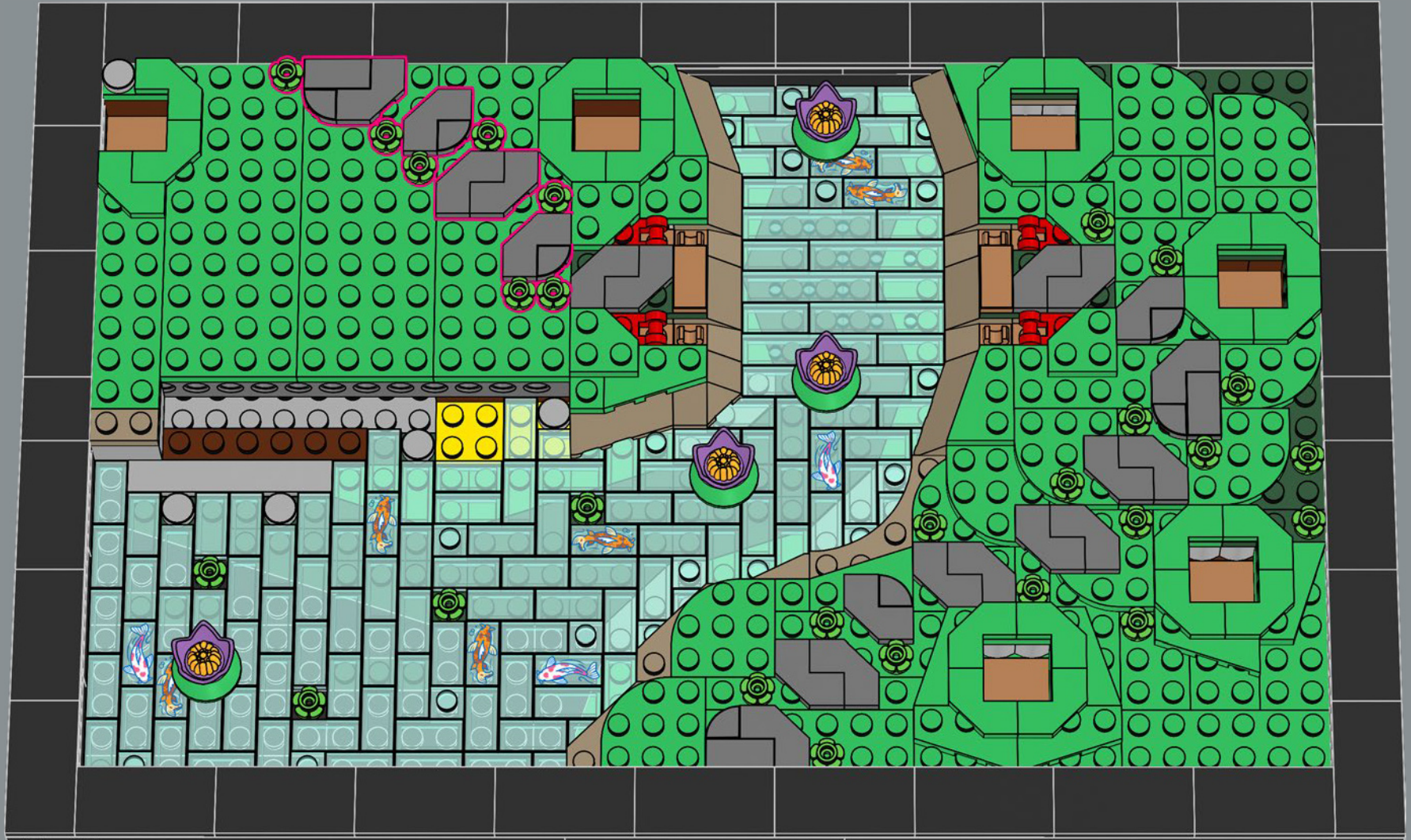

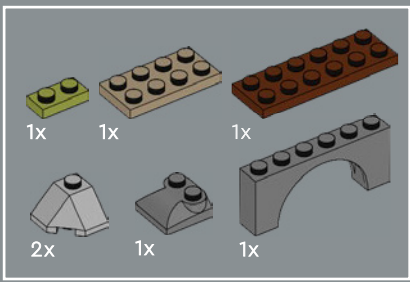

102

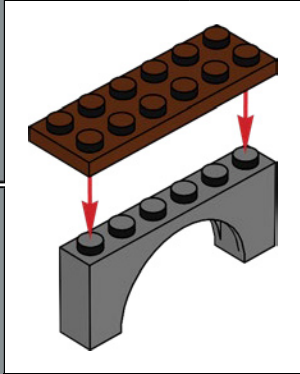

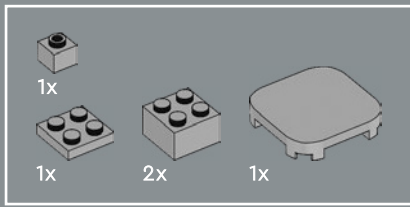

103

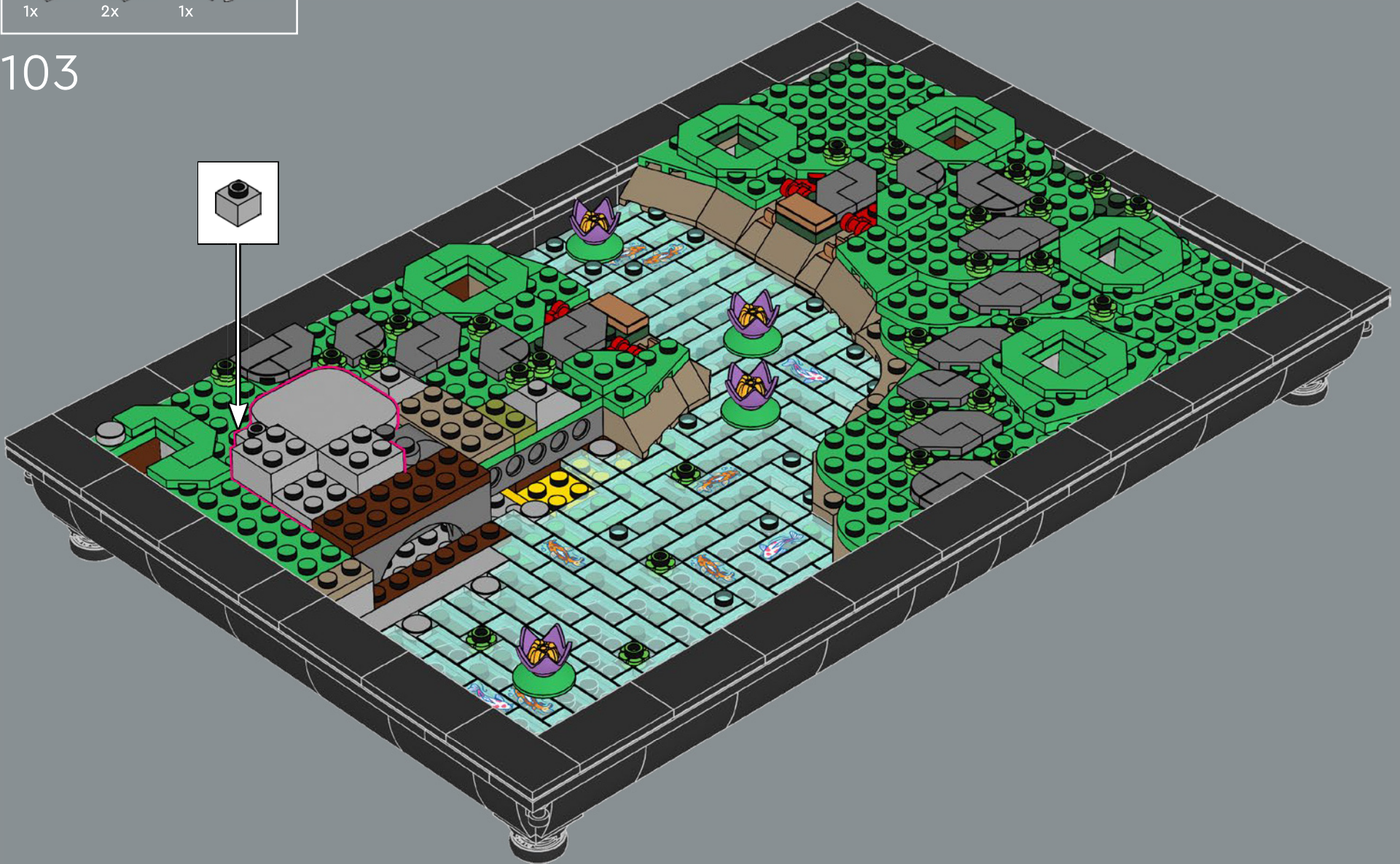
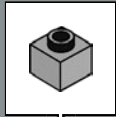

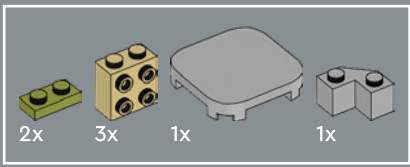

104

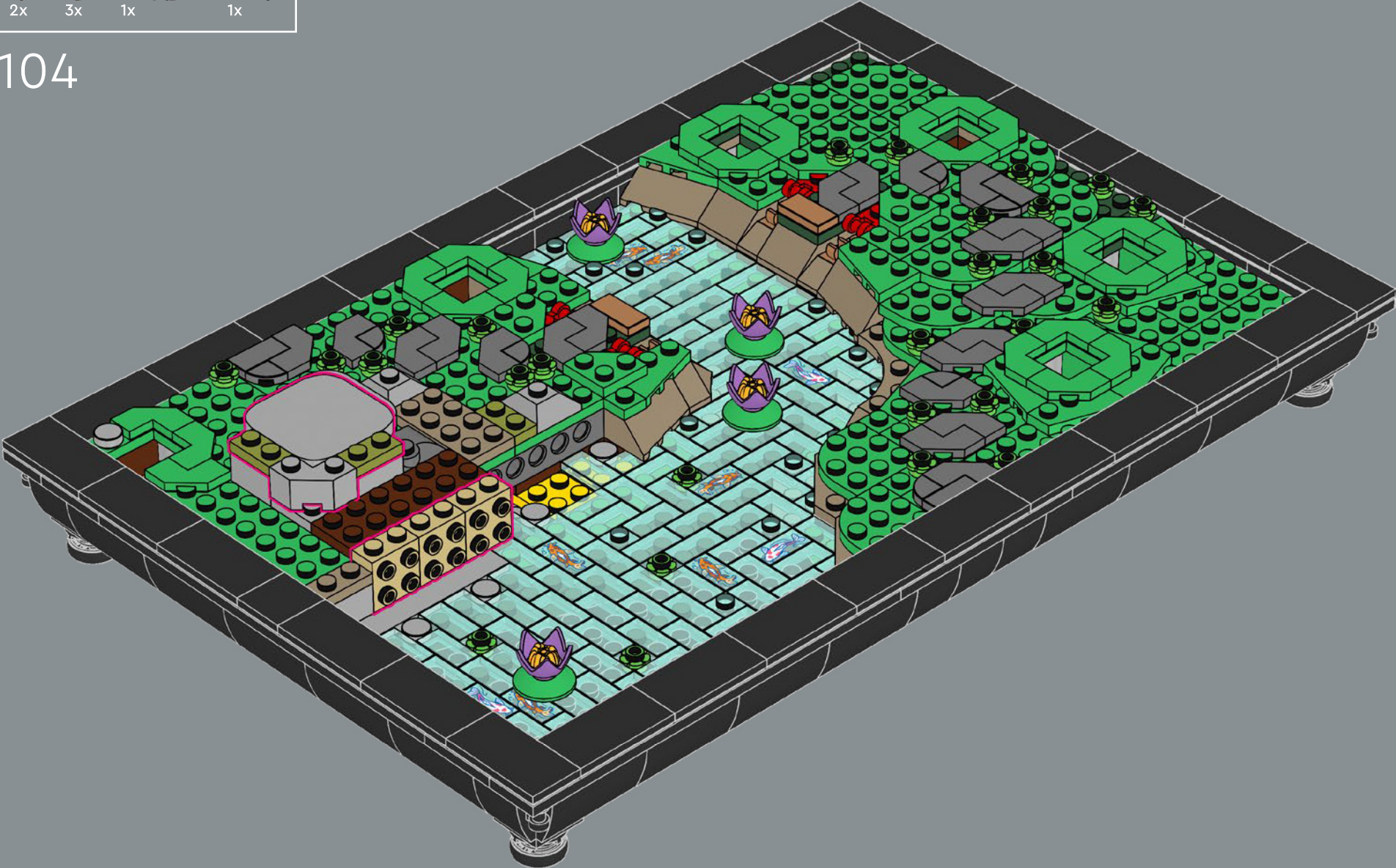

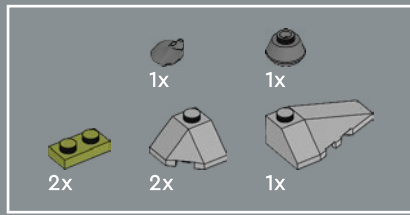

105

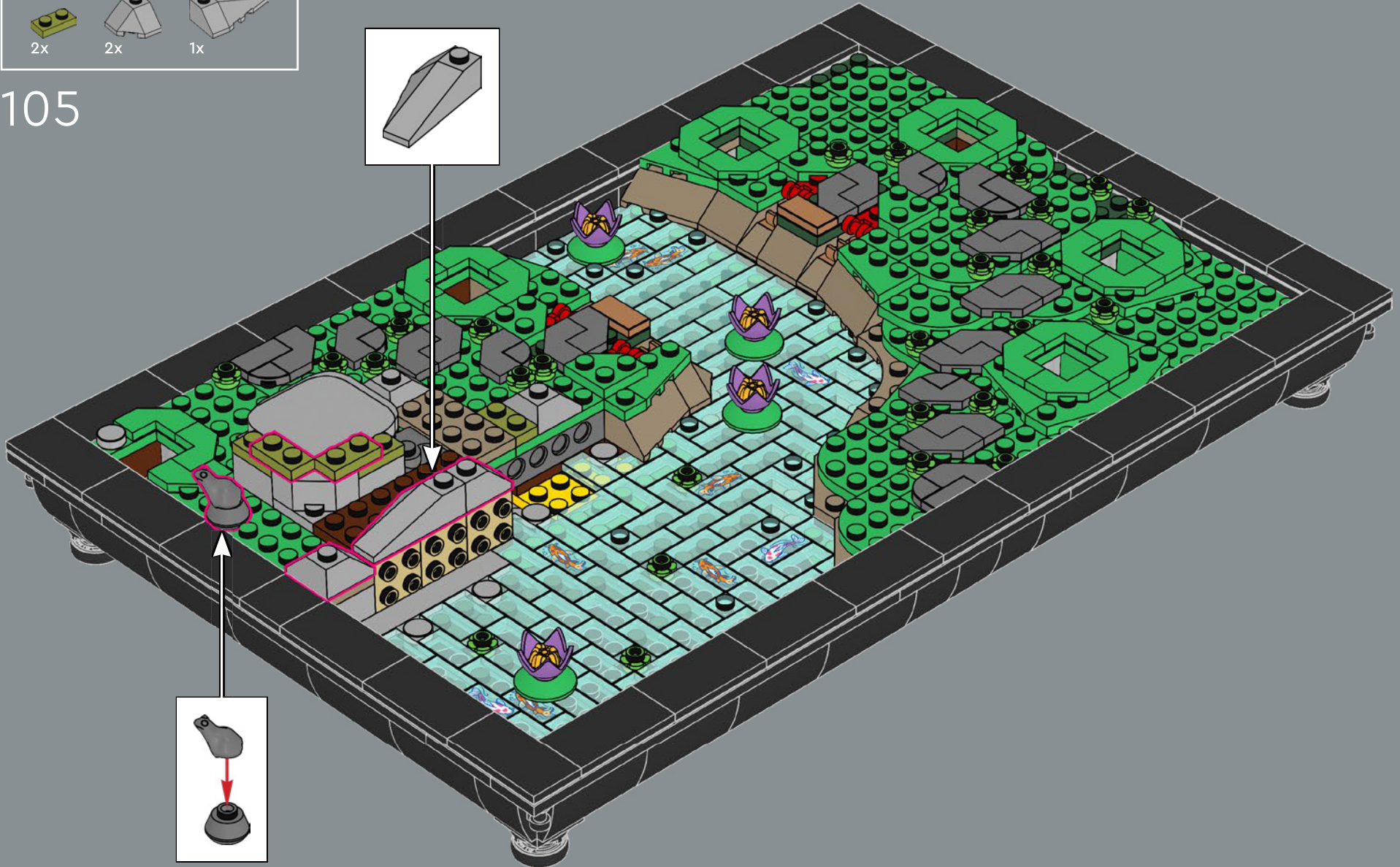
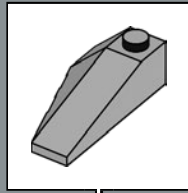

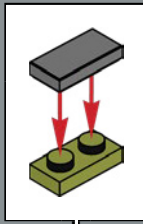
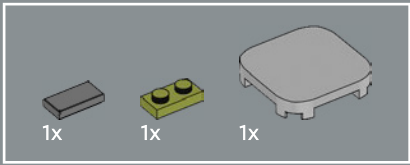

106



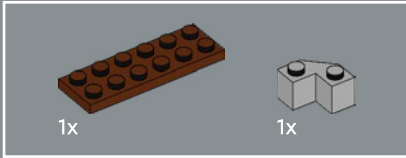
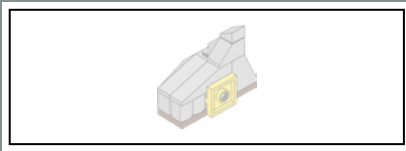

107

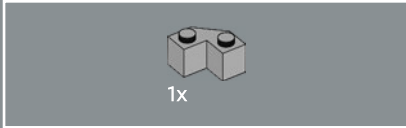
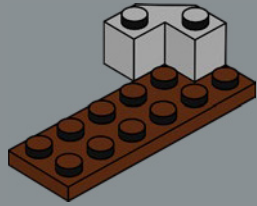

108

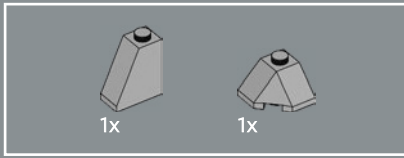
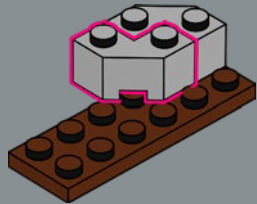

109

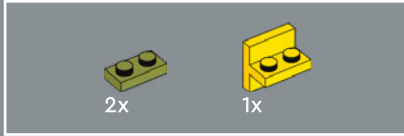
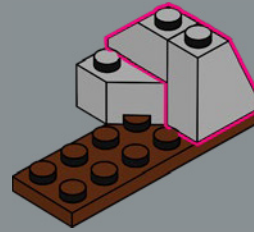

110

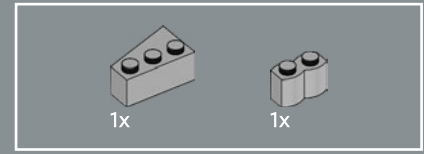
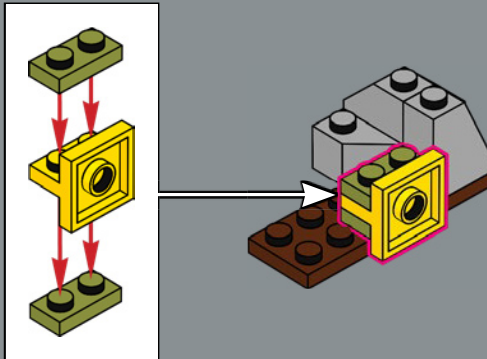

111

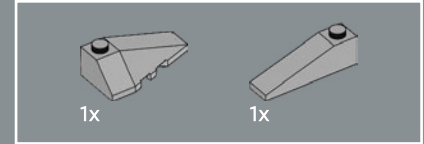
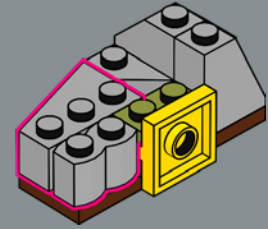

112

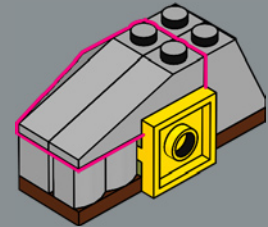

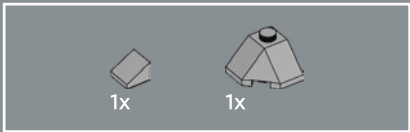

113

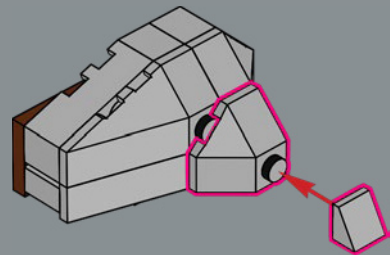

114



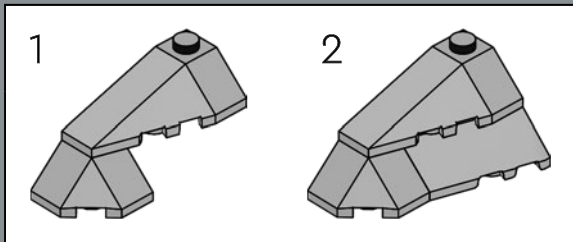
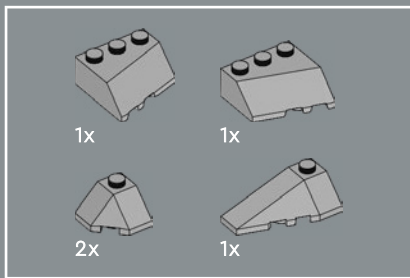

115

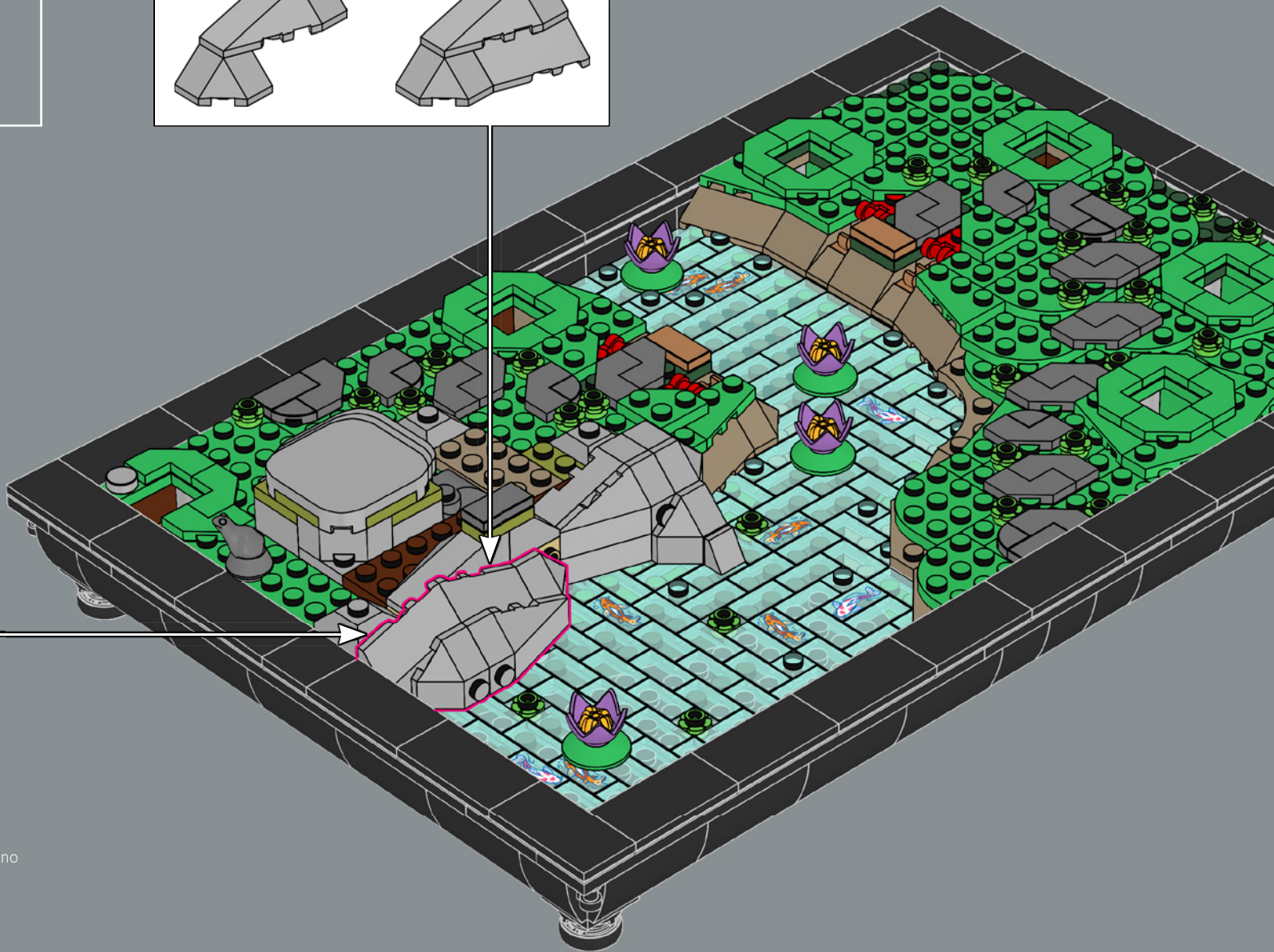
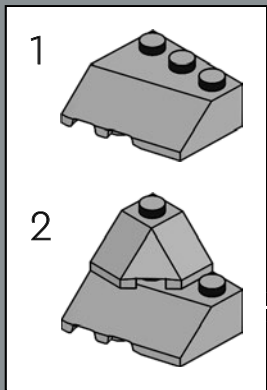

Pietre, rocce e sabbia spesso conferiscono un significato più profondo al terreno.

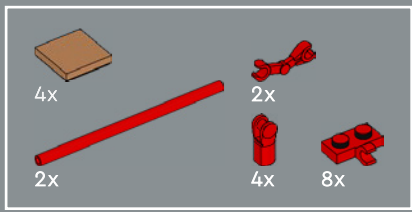

116

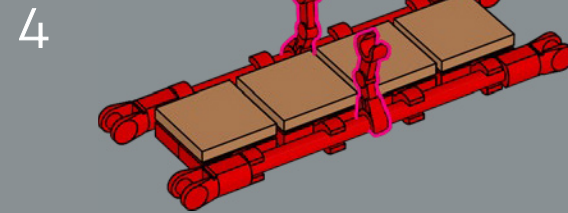
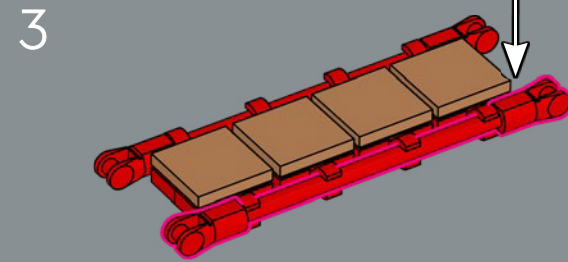
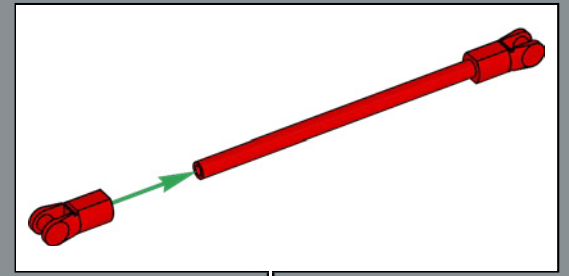
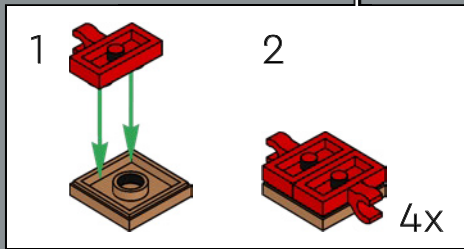
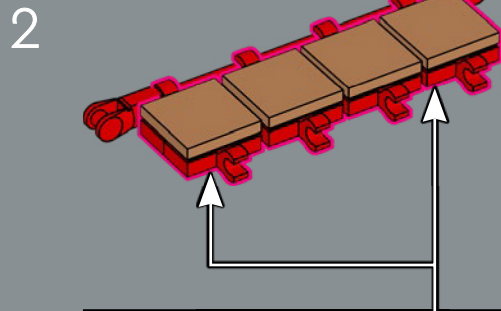
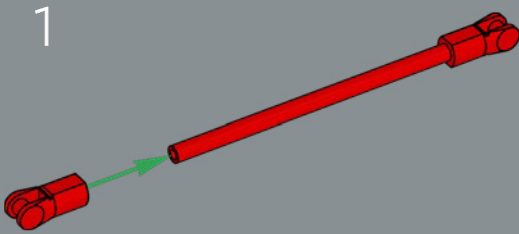

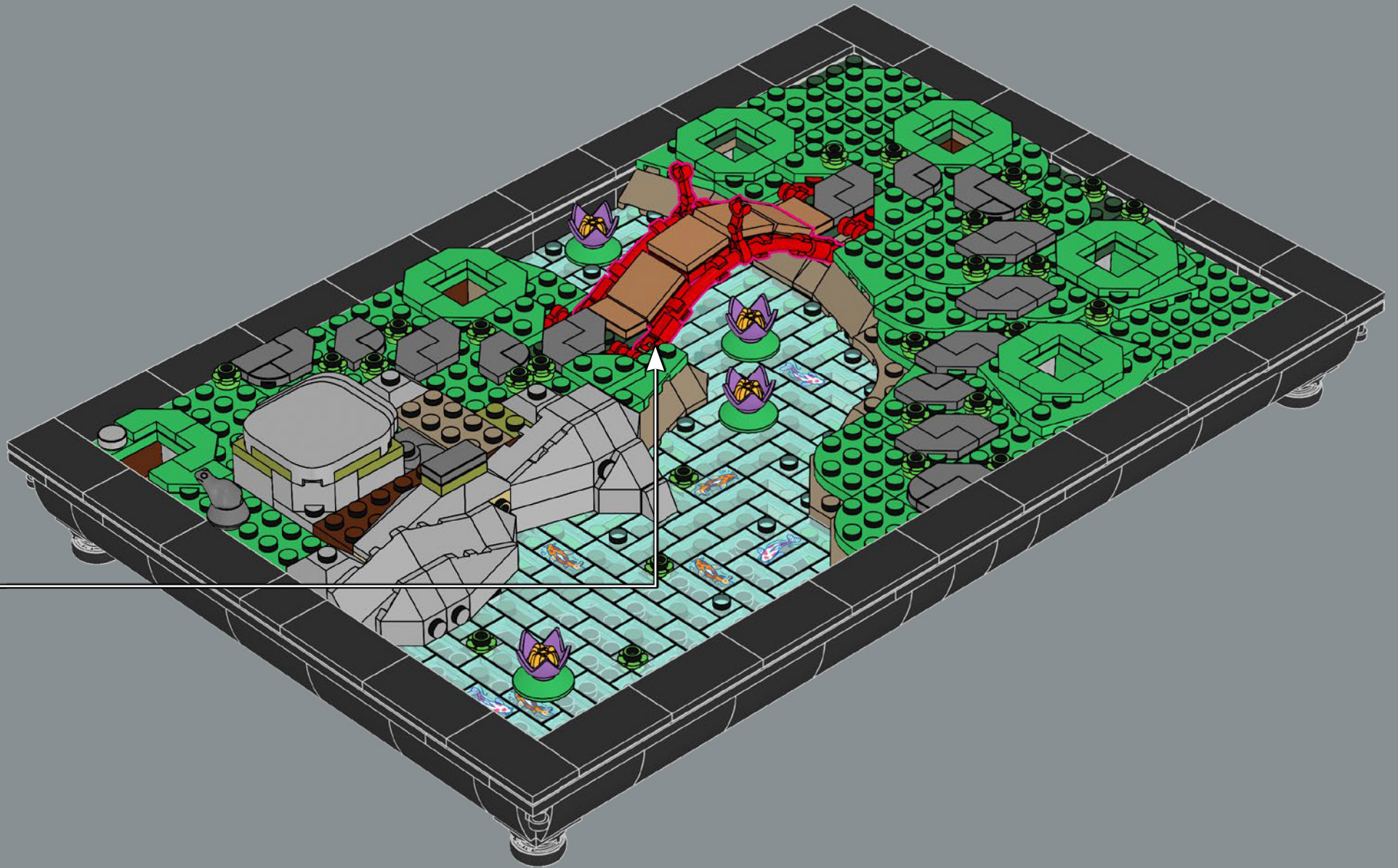

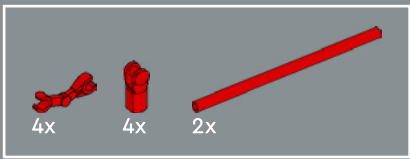

117

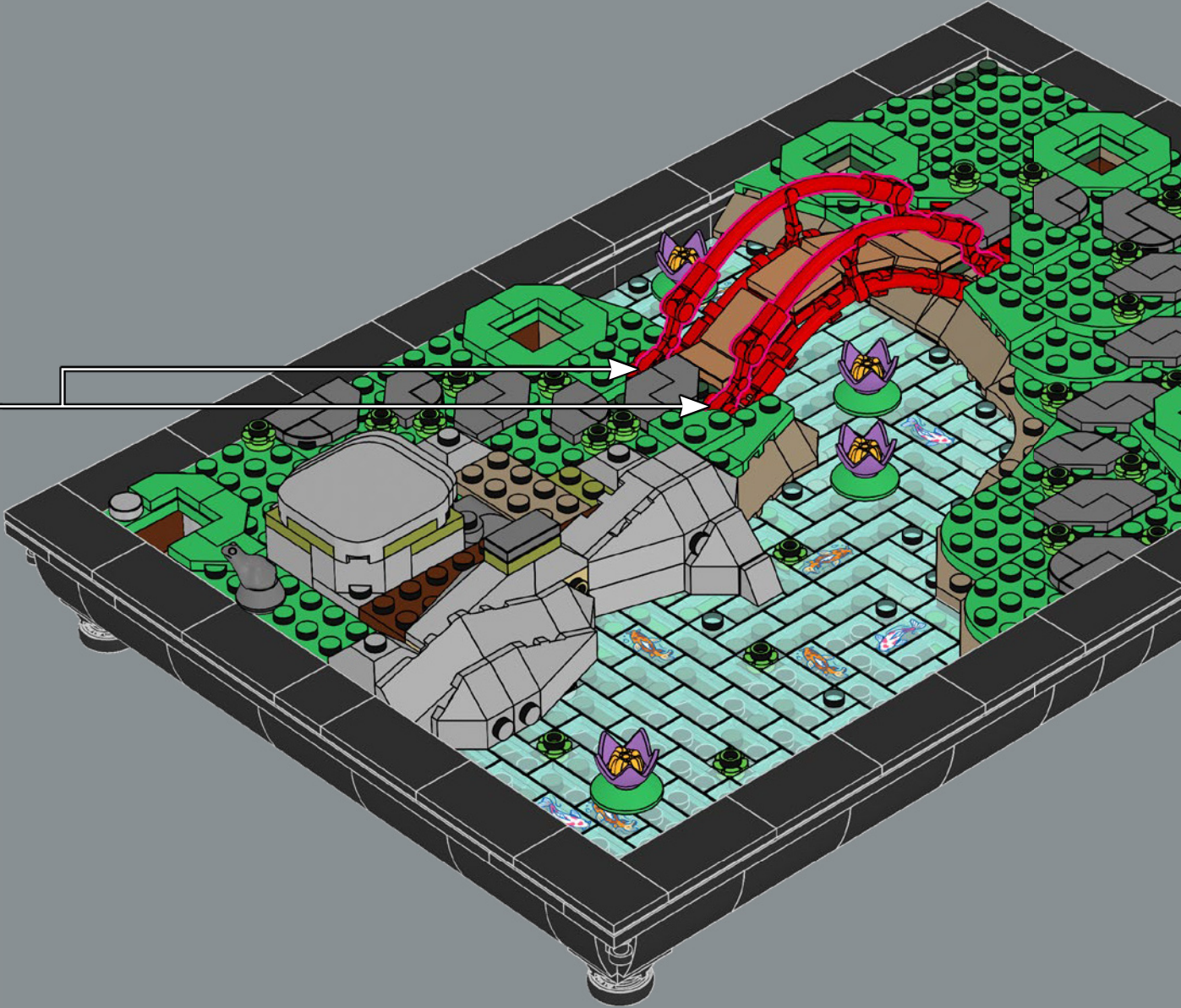
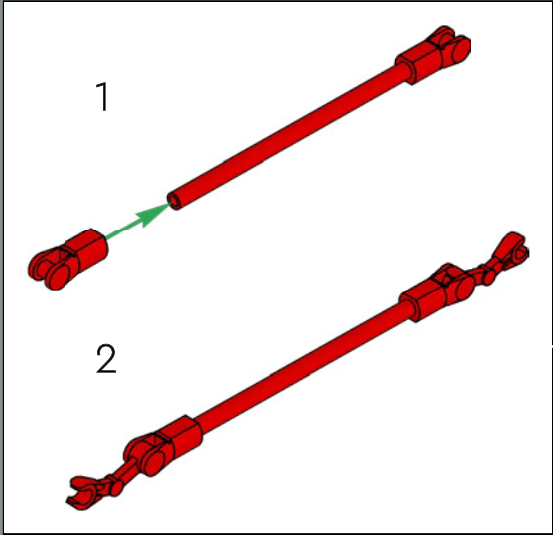



118

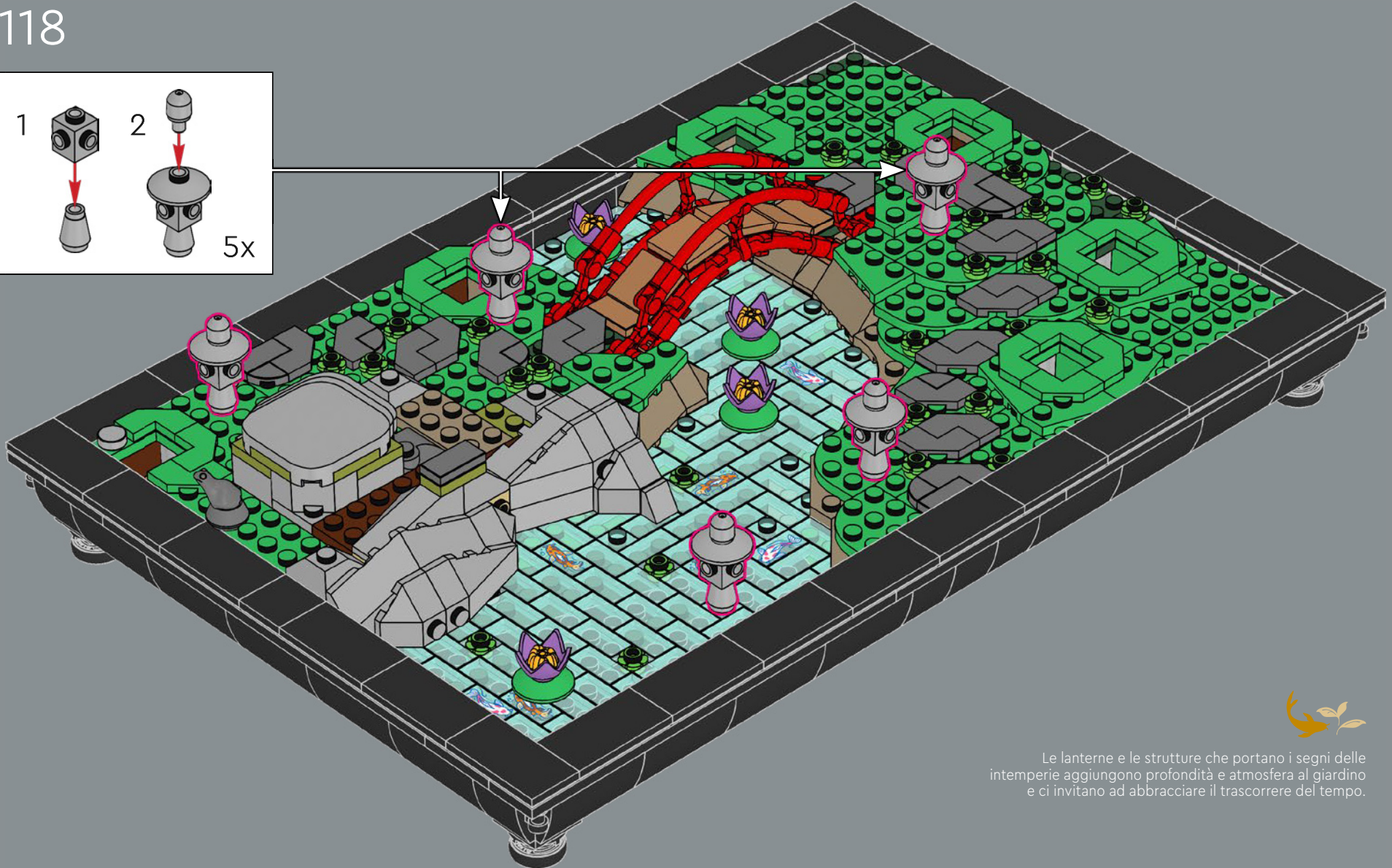
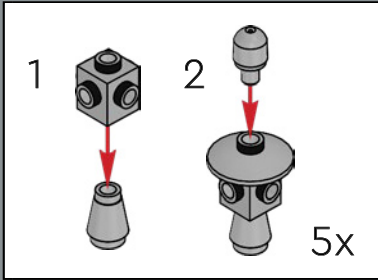

Le lanterne e le strutture che portano i segni delle intemperie aggiungono profondità e atmosfera al giardino e ci invitano ad abbracciare il trascorrere del tempo.

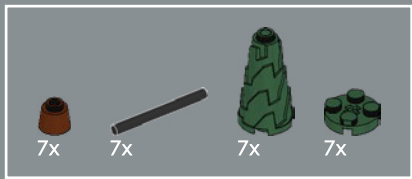

119

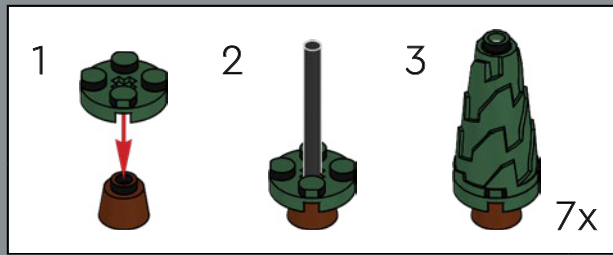

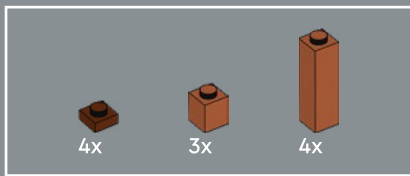

120

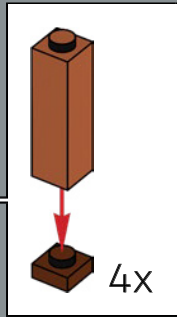
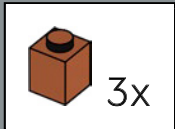

121



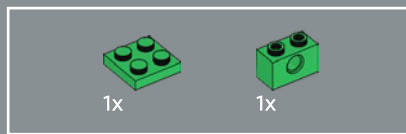

122

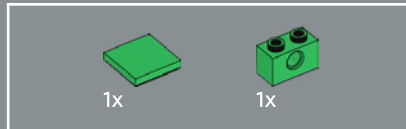
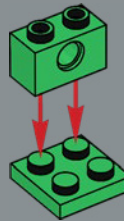

123

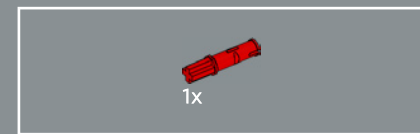
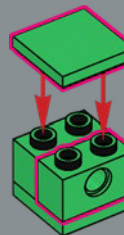

124

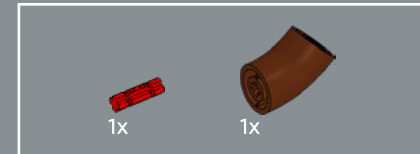
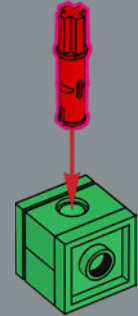

125

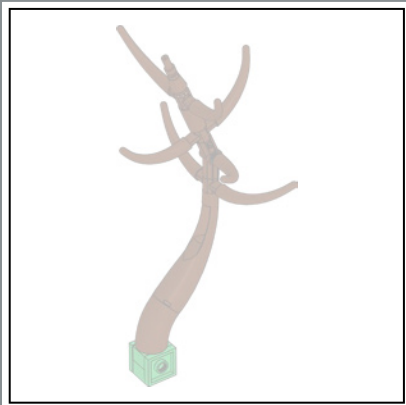
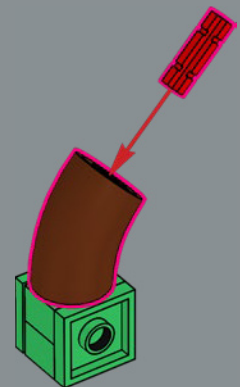

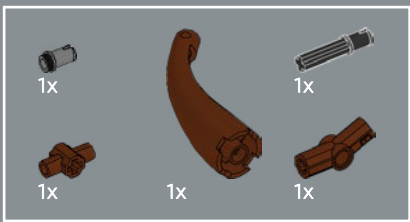

126

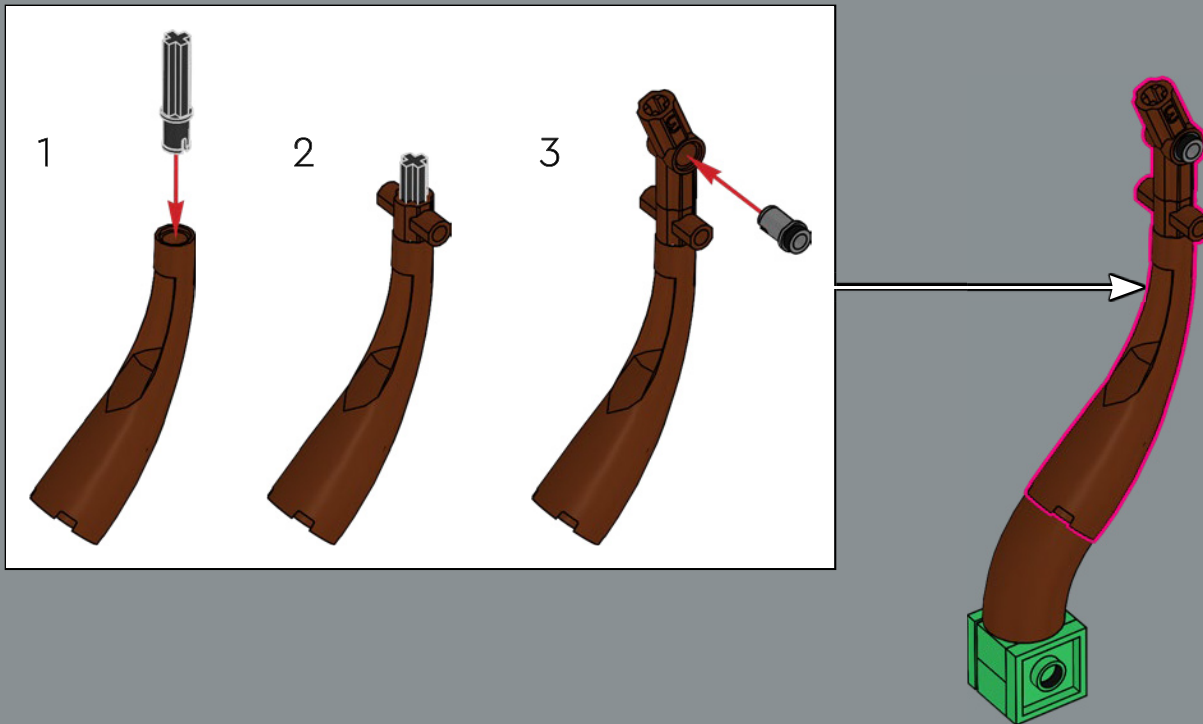

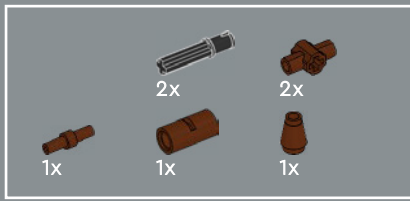

127

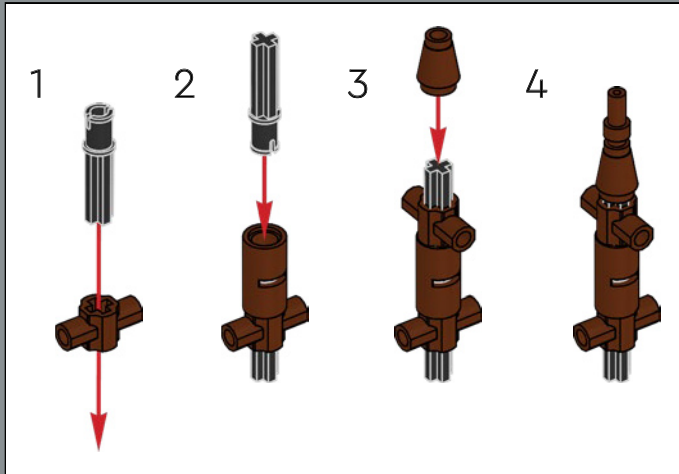

128





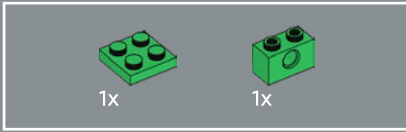
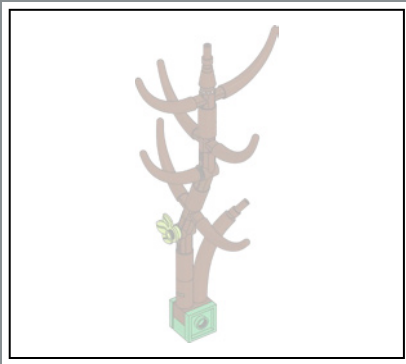

130

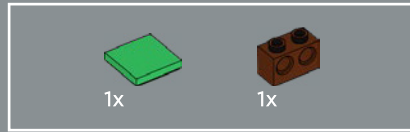
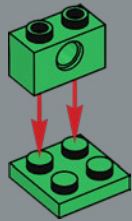

131

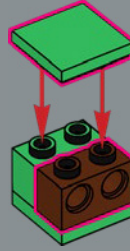

132

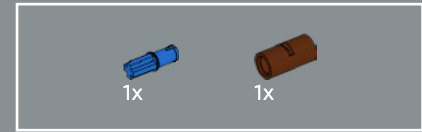
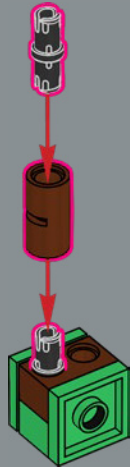

133

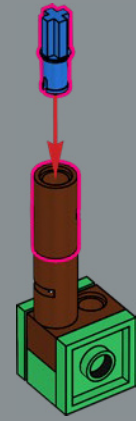

134

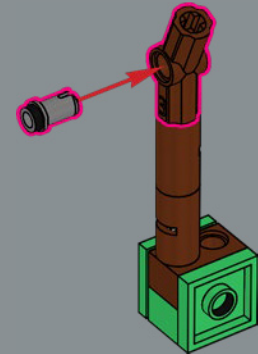

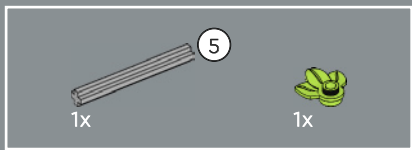

135

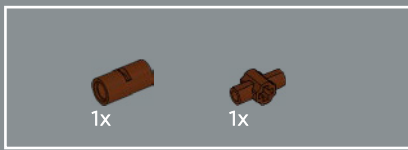
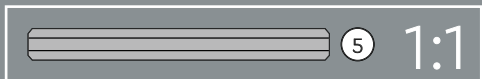

136

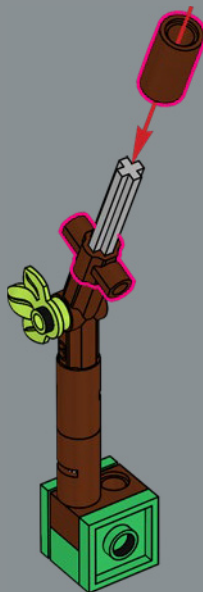

137



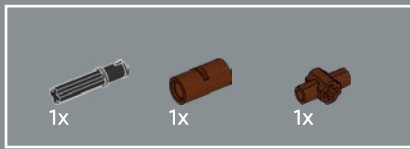

138

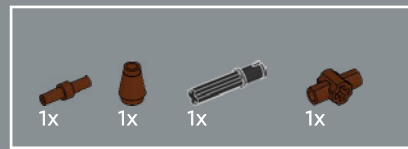
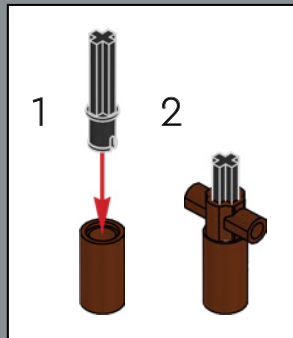

139

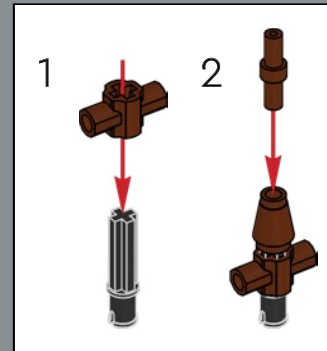

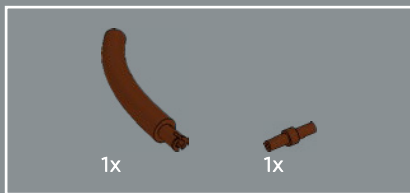

140

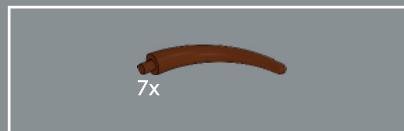
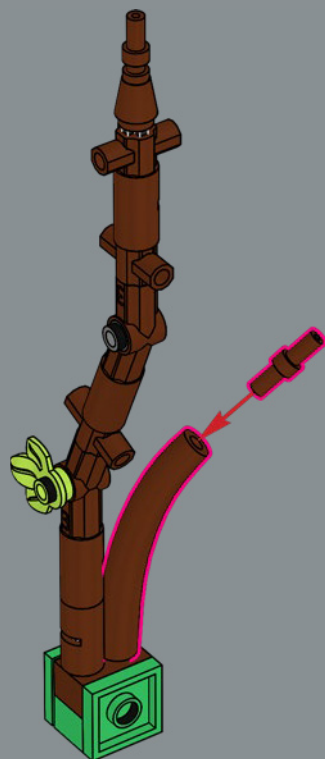

141

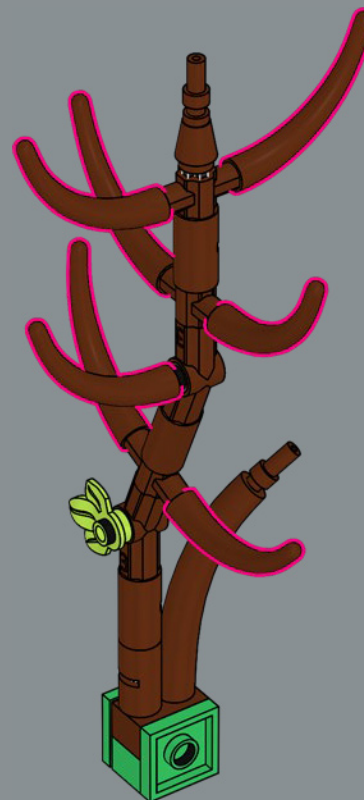

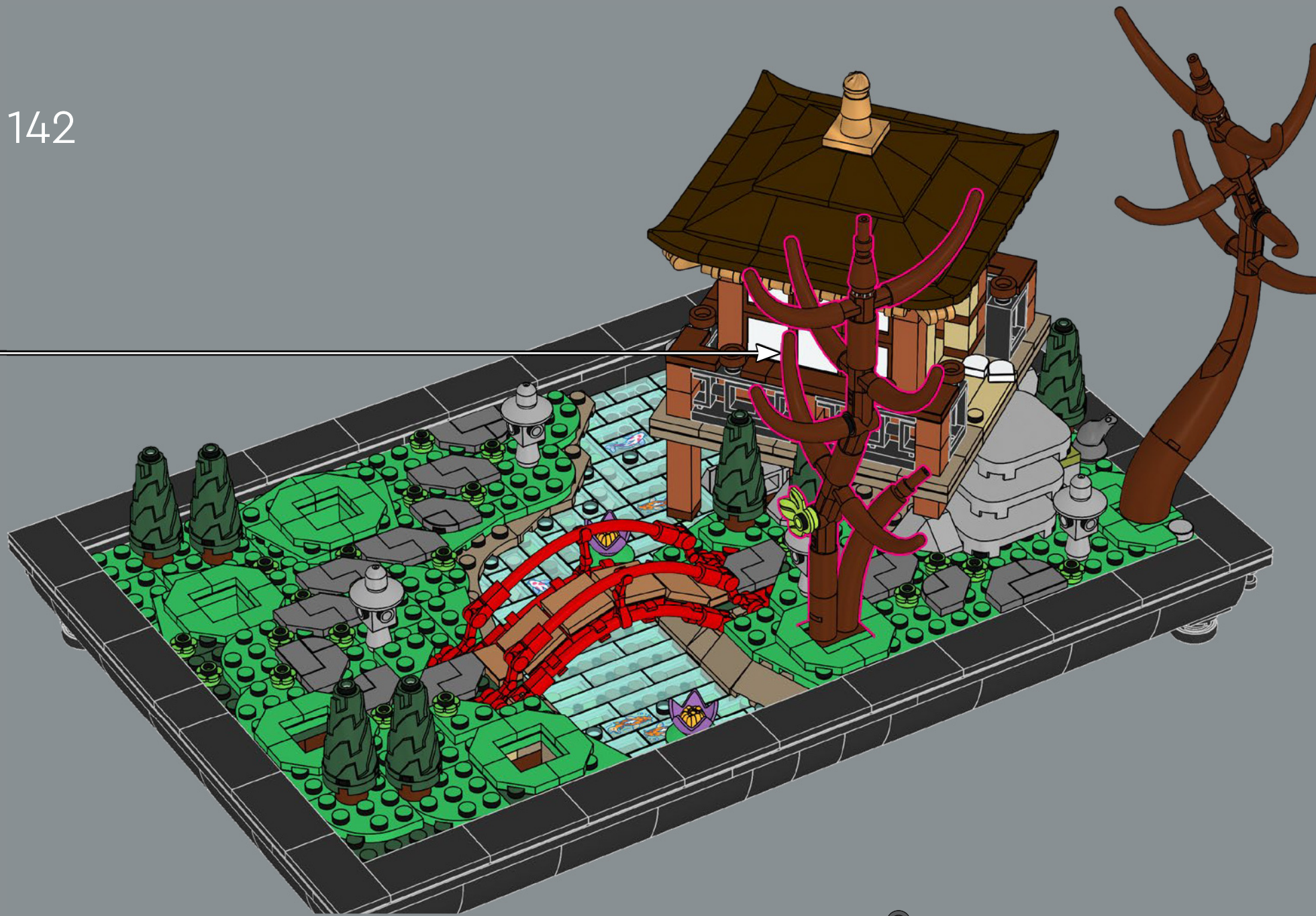

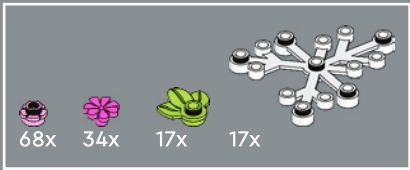

143

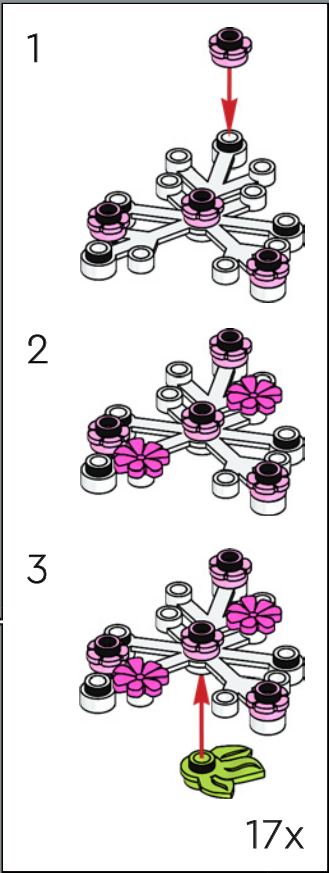

Un equilibrio di elementi come l'acqua, piante accuratamente selezionate e diversi usi delle rocce aiuta a creare un ambiente tranquillo nel tuo giardino.

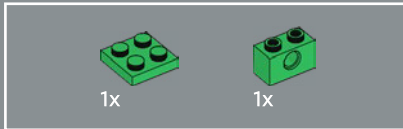
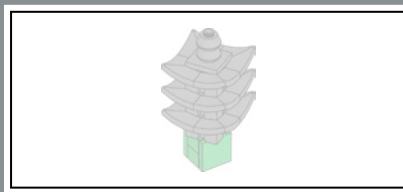

144

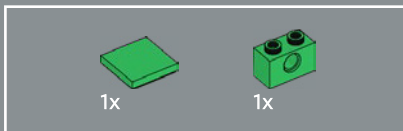
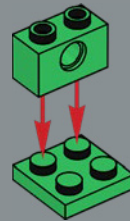

145

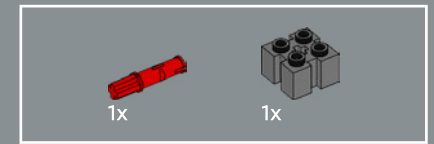
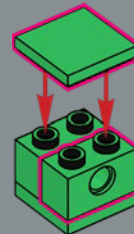

146

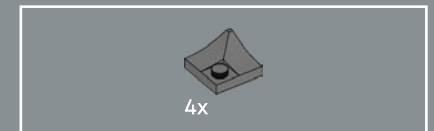
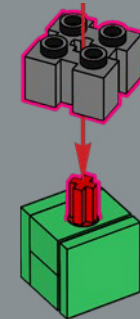

147

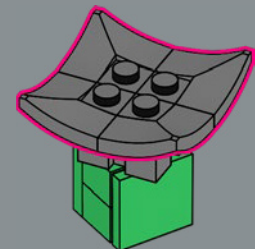

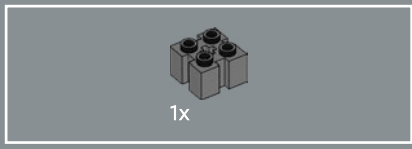

148

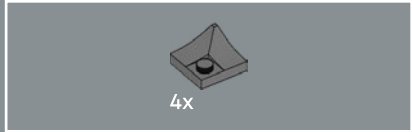
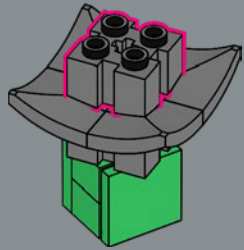

149

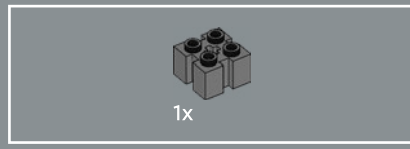
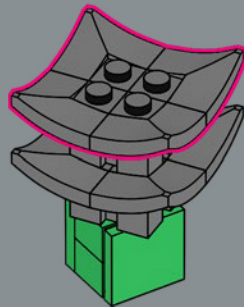

150

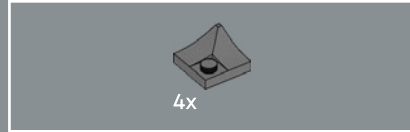
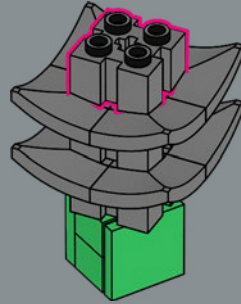

151

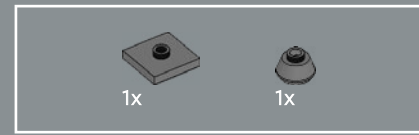
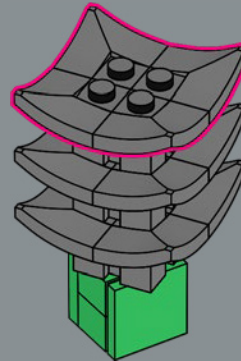

152

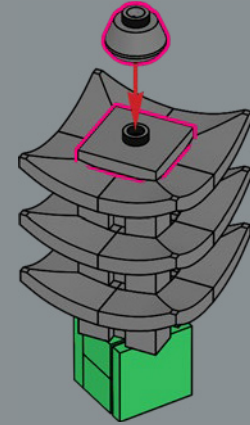

153

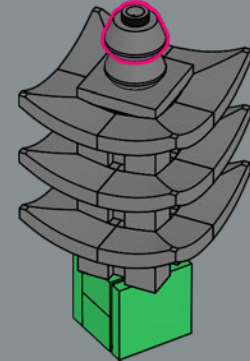

154

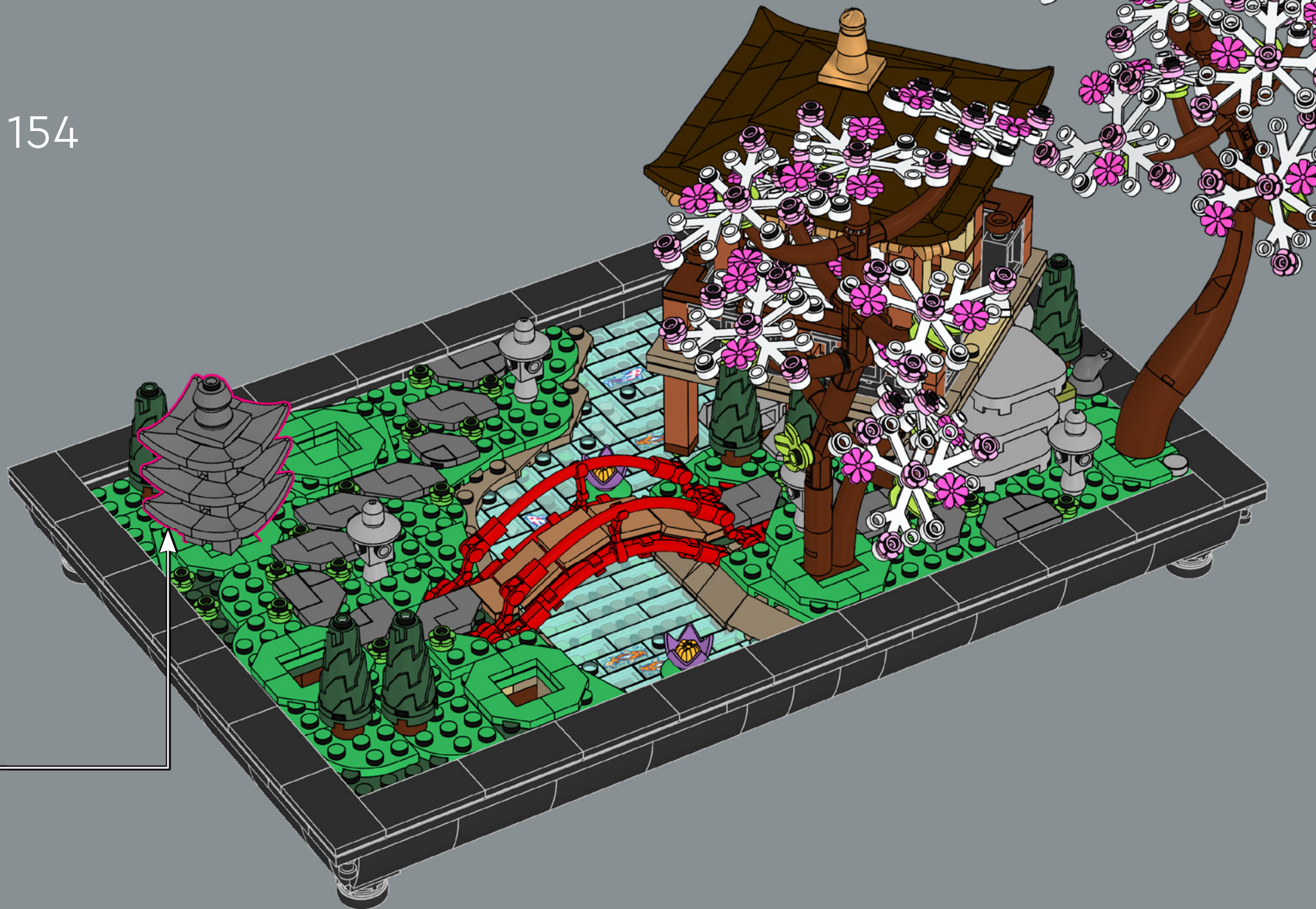

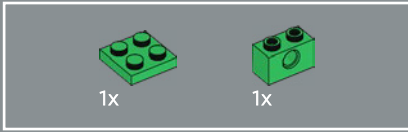
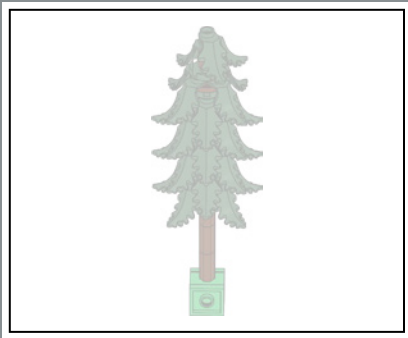

155

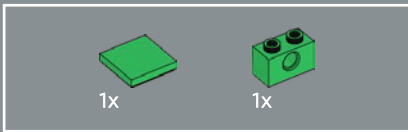
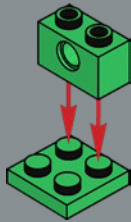

156

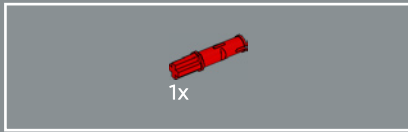
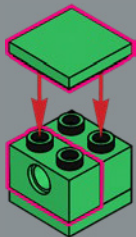

157

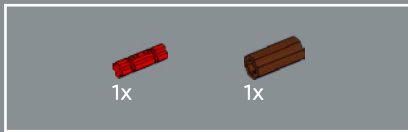
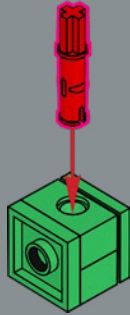

158

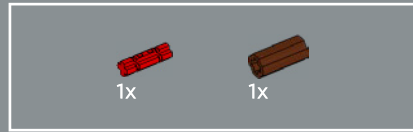
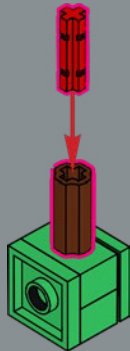

159

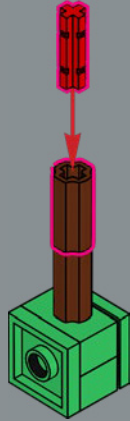

160

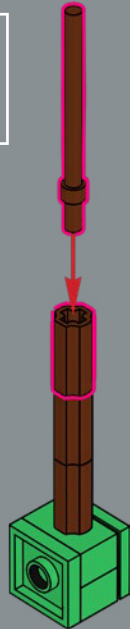



161

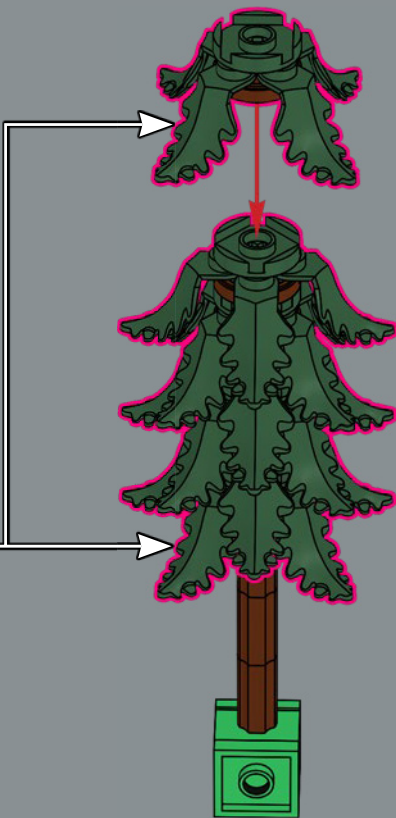

162

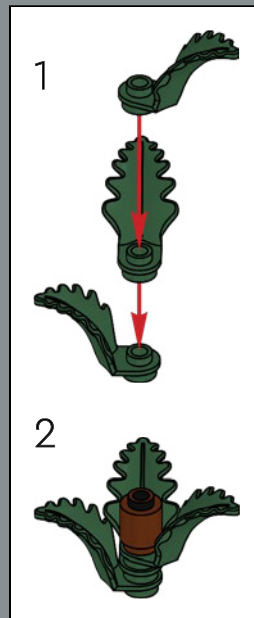



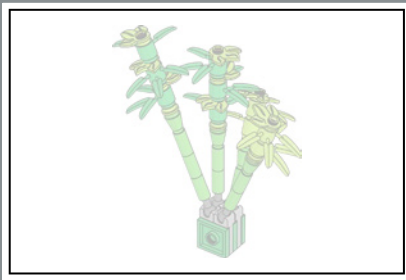

164

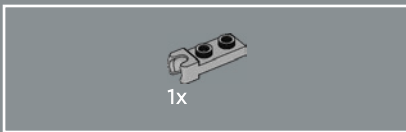
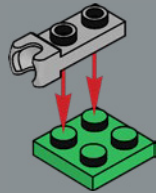

165

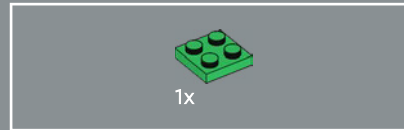
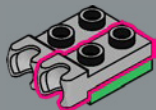

166

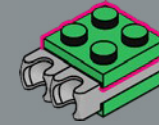

167

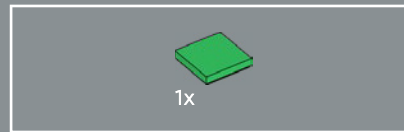
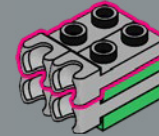

168

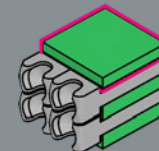



169

1



2

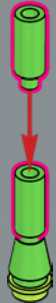

3



4



5

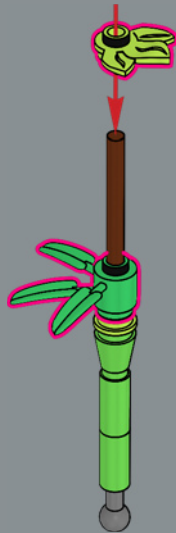

6

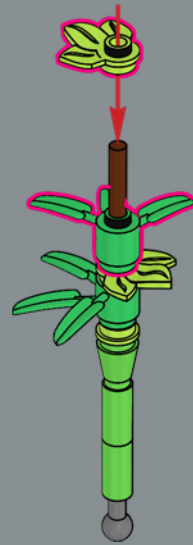

7

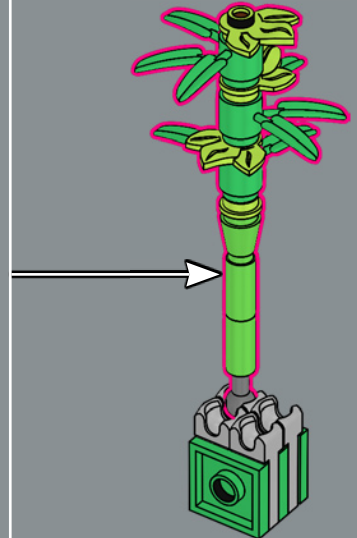
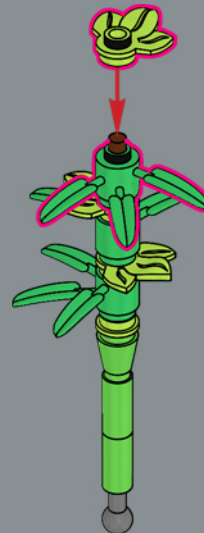



170

1



2

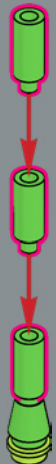

3



4



5

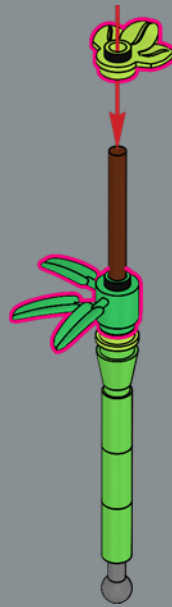

6

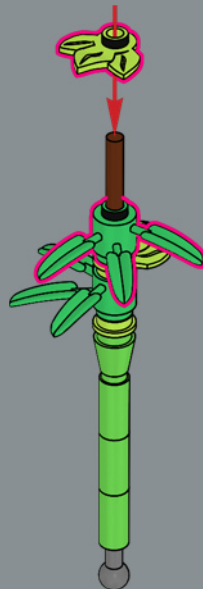

7

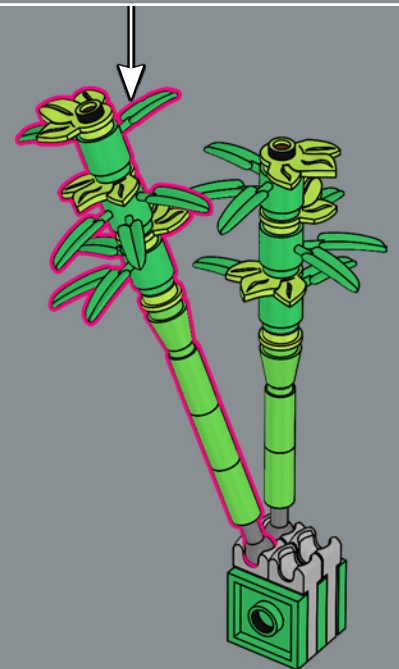
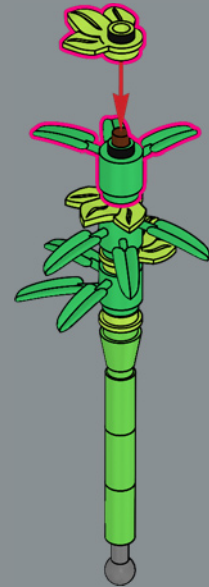

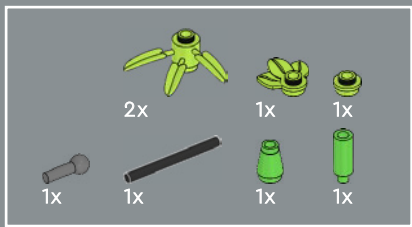

171

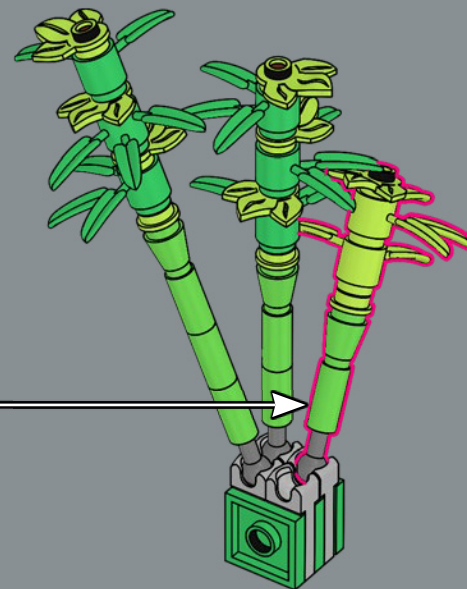
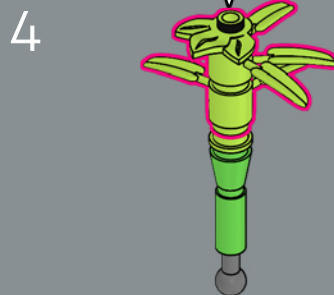
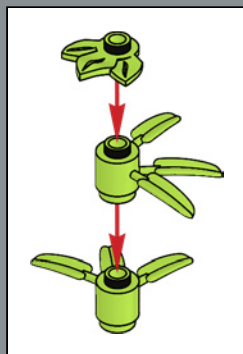
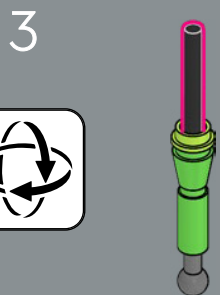
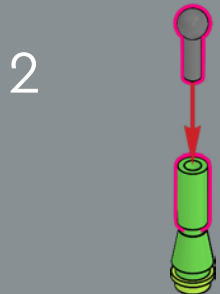
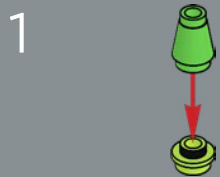

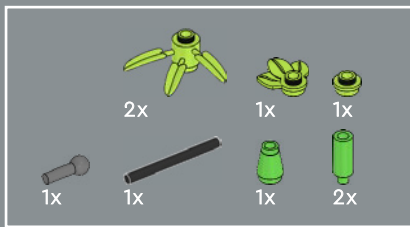

172

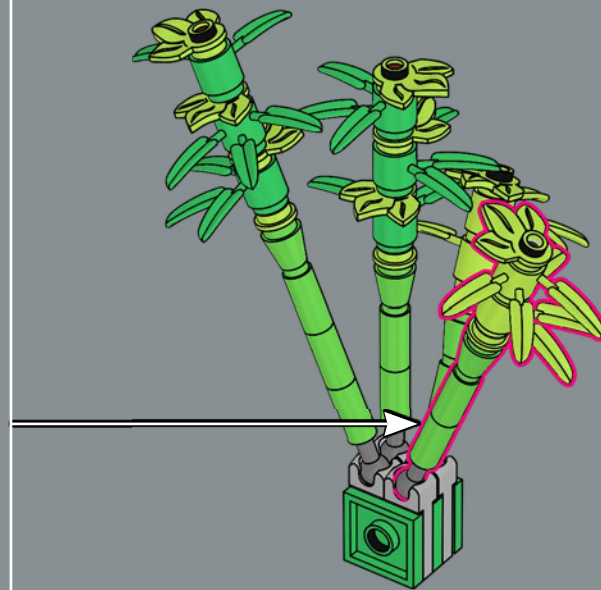
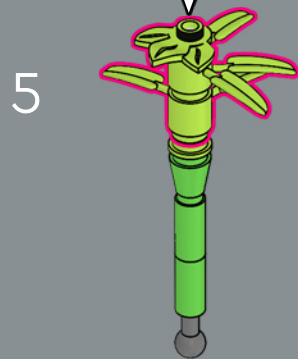
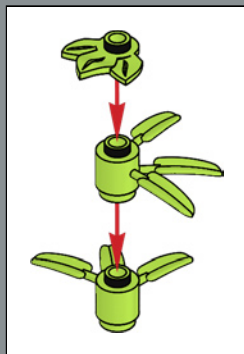
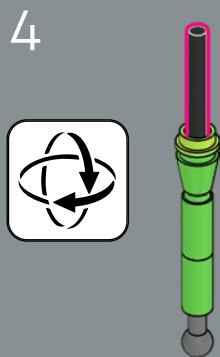
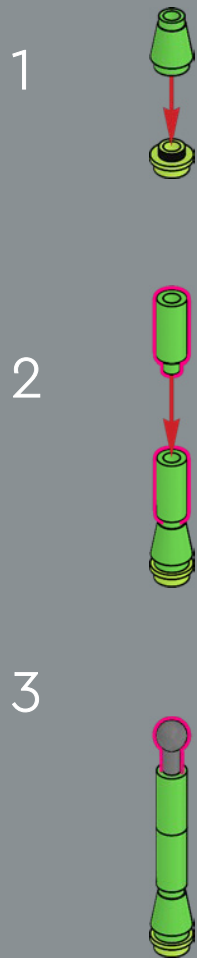



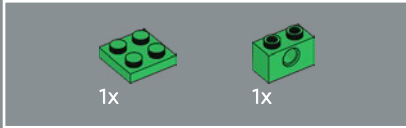

174

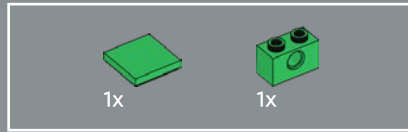
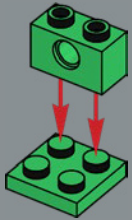

175

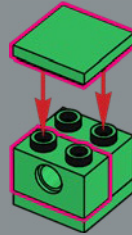

176

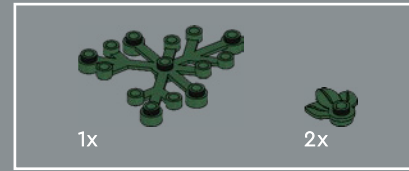
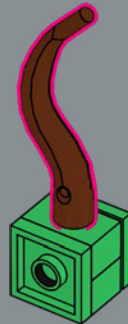

177

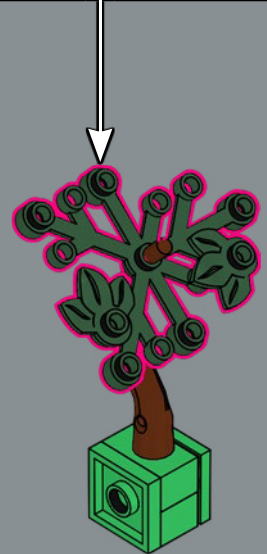
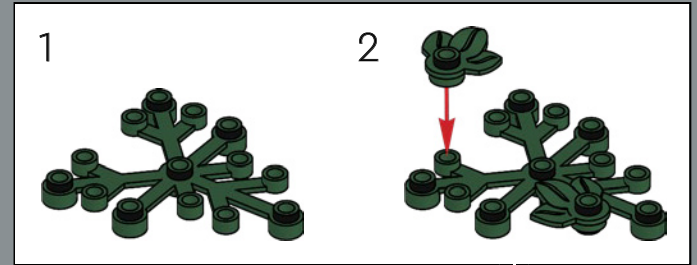

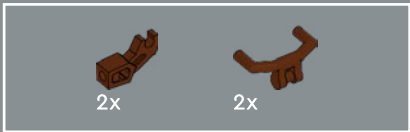

178

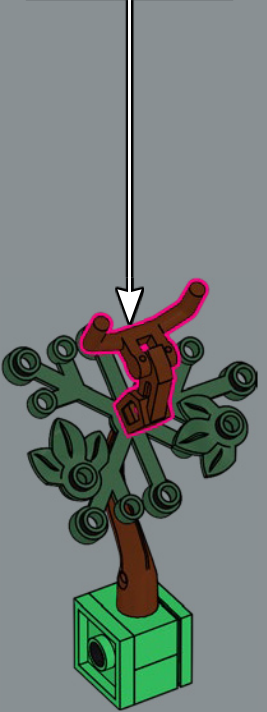
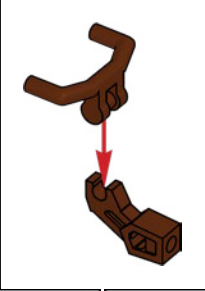

179

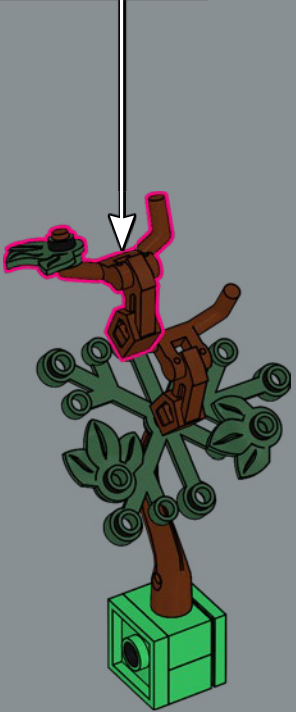
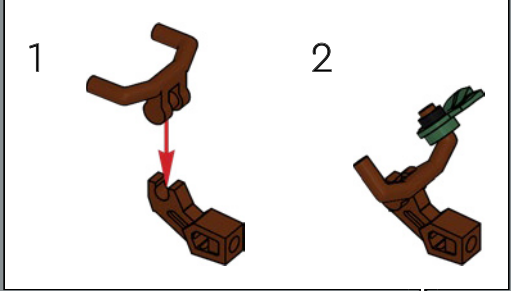

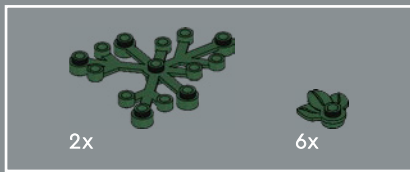

180

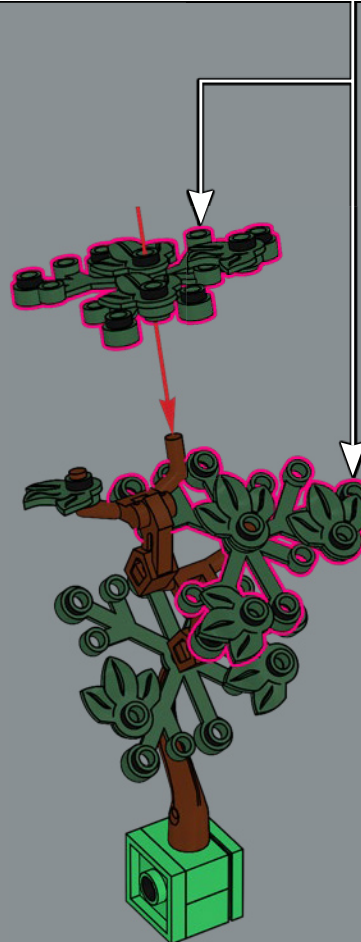
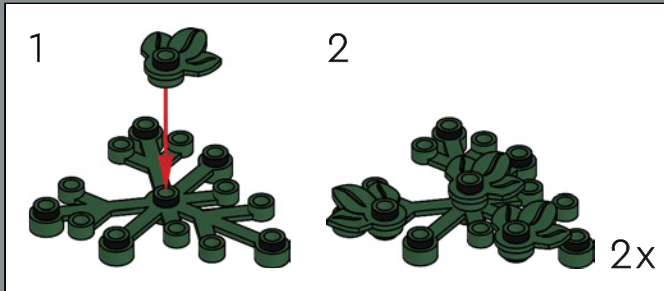



Vuoi aggiungere il tuo tocco personale al modello?
Lasciati ispirare dai cinque principi dei giardini giapponesi:
contenimento, equilibrio, paesaggio in prestito,
simbolismo e asimmetria.

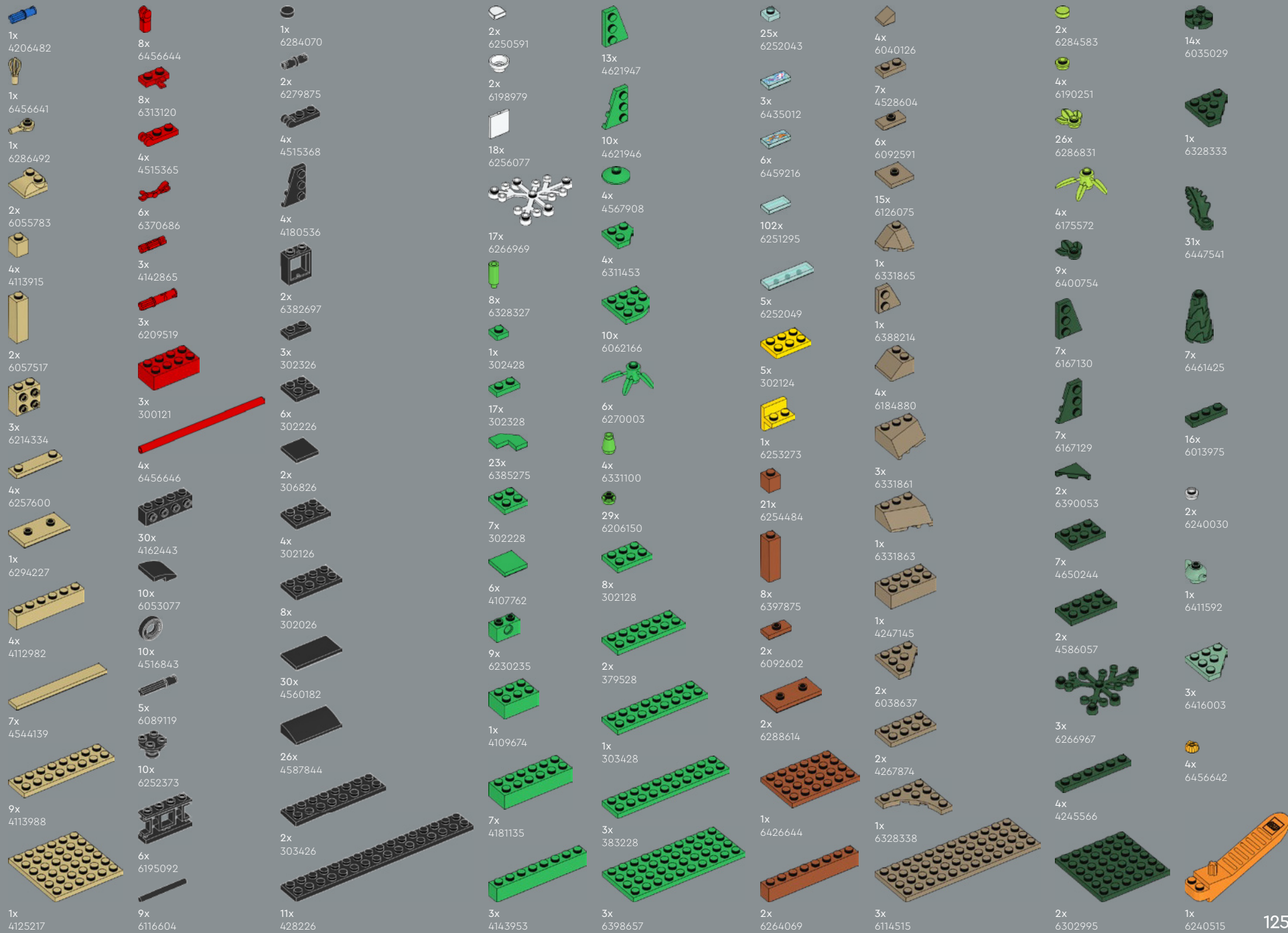

- 1x 4211183
- 3x 4211288
- 4x 4221744
- 1x 6151461
- 14x 4211190
- 5x 4216945
- 1x 4211214
- 2x 4225715
- 3x 6258989

- 1x 6348057
- 2x 4529242
- 7x 6173143
- 7x 6102360
- 3x 6451002
- 3x 4531751
- 2x 6276868
- 18x 6382102
- 1x 6326087
- 1x 6383996
- 1x 6327811

- 9x 6186673
- 12x 4211257
- 4x 6221608
- 2x 6327818
- 5x 6173132
- 3x 6261388
- 5x 4211200
- 3x 4211194
- 6x 6459423
- 3x 6170468
- 1x 6292952
- 14x 6372430
- 1x 6070442
- 8x 4211247

- 8x 4550325
- 5x 4211387
- 5x 4211511
- 3x 4651063
- 1x 4526932
- 1x 4521921
- 1x 4515374
- 8x 6034676
- 1x 6013497
- 1x 6315580
- 2x 4180418
- 1x 6315579

- 1x 4180408
- 1x 6401023
- 1x 4211397
- 1x 4211549
- 1x 4211639
- 5x 4211512
- 2x 4211400
- 2x 4598522
- 2x 4620130

5

- 5x 6284071
- 5x 6212288
- 5x 4529241
- 4x 4211353
- 4x 6043639
- 3x 6354325

- 3x 6395635
- 4x 6364352
- 7x 6199549
- 3x 6340333
- 1x 6171103
- 1x 4218696
- 1x 6126083
- 4x 4211052
- 21x 6177079
- 3x 6236949
- 12x 6447212
- 1x 4211100
- 1x 6106191
- 2x 4210678
- 1x 4211137

- 8x 6016483
- 34x 6206151
- 68x 6212501
- 1x 6186383
- 4x 6212377
- 16x 6279731
- 1x 6190252
- 2x 6173139
- 1x 6050916

- 8x 6456639
- 4x 6456643
- 4x 6456663
- 16x 6347604
- 2x 6021997
- 10x 6102990
- 4x 6347304
- 1x 6363146
- 4x 6456640



LEGO.com/service



YOU COULD WIN



YOU COULD WIN

Your feedback will help shape the future development of this product series.

Visit:

DU KÖNNTEST GEWINNEN

Dein Feedback trägt zur Weiterentwicklung dieser Produktreihe bei.

Geh auf:

VOUS POURRIEZ GAGNER

Vos commentaires nous aideront à concevoir les futurs produits de cette gamme.

Visitez :

POTRESTI VINCERE TU

La tua opinione ci aiuterà a migliorare la creazione futura di questa linea di prodotti.

Visita:

PUEDES GANAR

Tu opinión contribuirá al futuro de esta serie de productos.

Visita:

轻松获奖

您的反馈将有助于我们在今后改进本产品系列。

请访问:

[LEGO.com/productfeedback](https://www.lego.com/productfeedback)

You also have the chance to win a LEGO® set.

Terms and conditions apply.*

Außerdem hast du die Chance, ein LEGO® Set zu gewinnen.

Es gelten die Teilnahmebedingungen.*

Vous pourriez également gagner un ensemble LEGO®.

Des conditions s'appliquent.*

Hai anche la possibilità di vincere un set LEGO®.

Termini e condizioni sono applicabili.*

También tienes la oportunidad de ganar un set LEGO®.

Aplican términos y condiciones.*

您还有机会赢取乐高®套装。

条款和条件适用。*

*[LEGO.com/productfeedback-terms](https://www.lego.com/productfeedback-terms)



LEGO and the LEGO logo are trademarks of the LEGO Group.
©2023 The LEGO Group.