

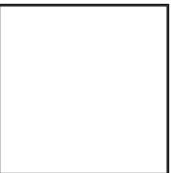

Booklet available in English on
Livret disponible en français sur
Folleto disponible en español en





WE'RE MAKING OUR PACKAGING MORE SUSTAINABLE

We're transitioning from single-use plastic to paper-based packaging. As we progress, you may find a mix of paper and plastic in our boxes.

NOUS RENDONS NOS EMBALLAGES PLUS DURABLES

Nous passons des emballages en plastique à usage unique aux emballages à base de papier. Durant la transition, vous pourriez trouver un mélange de papier et de plastique dans nos boîtes.

QUEREMOS HACER MÁS SUSTENTABLES NUESTROS MATERIALES DE EMBALAJE

Estamos cambiando las bolsas de plástico desechables por bolsas con base de papel. Conforme avanzamos en este propósito, puedes encontrar una mezcla de papel y de plástico en nuestras cajas.

[LEGO.com/sustainable-packaging](https://www.lego.com/sustainable-packaging)



ANDERSON WARD GRUBB

*Designer of the 10312 Jazz Club
Concepteur de Le club de jazz 10312
Diseñador del Club de Jazz (10312)*

WELCOME

Get ready for a great night out with live music, entertainment and delicious food! Inspired by classic architecture and infused with our favorite music from the golden age of jazz, this hot new music venue is a fresh addition to the LEGO® Modular Building series. Whether this is your first modular set, or you have been building your LEGO street from the beginning, you are always invited to build to your own tune.

BIENVENUE

Préparez-vous à passer une excellente soirée avec de la musique, du divertissement et de la nourriture délicieuse ! Inspirée par l'architecture classique et imprégnée de notre musique préférée de l'âge d'or du jazz, cette nouvelle salle de concert s'ajoute à la série des bâtiments modulaires LEGO®. Qu'il s'agisse de votre premier ensemble modulaire ou que vous construisiez votre rue LEGO depuis le début, vous êtes toujours invité à construire à votre propre rythme.

BIENVENIDO

¡Prepárate para una inolvidable velada con música en vivo, entretenimiento y la comida más deliciosa! Inspirado en la arquitectura clásica e indiscutiblemente impregnado de nuestras piezas favoritas de la era dorada del jazz, este nuevo recinto dedicado a la música es una refrescante incorporación a la serie LEGO® Modular Buildings. Tanto si se trata de tu primer set modular como si comenzaste a construir tu vecindario LEGO desde el principio, siempre estás invitado a construir a tu propio ritmo.





They say that in jazz, the notes that you don't play are just as important as the ones you do! Whether you're playing music notes or playing with LEGO® bricks, just play your own way!



LET THE MUSIC PLAY

Music can act as a virtual time machine that instantly takes you back to magical memories and moments in time or invites your imagination to travel to destinations you always dreamed of visiting. Play your favorite album on your vintage record player, jive into the LEGO® Icons Jazz Club and feel the thrilling atmosphere of this vibrant, mid-century magic and music melting pot full of creative, passionate performers, chefs and guests. Watch the show from the manager's office, grow produce for the kitchen in the rooftop greenhouse, feel the jitters in the dressing room, order a late-night snack, or enjoy a meal in the sidewalk café on a sizzling summer evening. No ticket or reservation required; your imagination grants you VIP access.

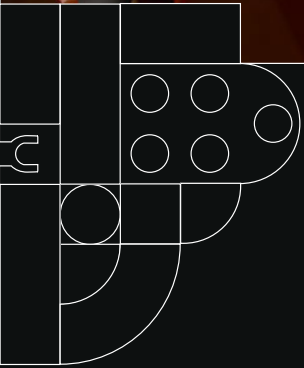

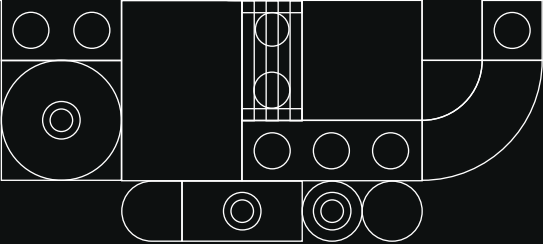

On dit que dans le jazz, les notes que vous ne jouez pas sont tout aussi importantes que celles que vous jouez ! Que vous jouiez de la musique ou que vous jouiez avec des briques LEGO®, jouez à votre façon !

Se dice que, en el jazz, las notas que no se tocan son tan importantes como las que los músicos nos regalan con la ayuda de sus instrumentos. Ya sea que interpretes melodías o construyas con bricks LEGO®, ¡no olvides hacerlo a tu manera!



LAISSEZ JOUER LA MUSIQUE

La musique peut agir comme une machine à remonter le temps virtuelle qui vous ramène instantanément à des souvenirs et à des moments magiques, ou inviter votre imagination à voyager vers des destinations que vous avez toujours rêvé de visiter. Jouez votre album préféré sur votre tourne-disque rétro, dansez dans le Club de jazz LEGO® Icons et imprégnez-vous de l'atmosphère exaltante de ce creuset magique et musical du milieu du siècle dernier, rempli d'artistes, de chefs et d'invités créatifs et passionnés. Assistez au spectacle depuis le bureau du directeur, faites pousser des fruits et légumes pour la cuisine dans la serre sur le toit, ressentez le trac dans la loge, commandez une collation de fin de soirée ou dégustez un repas sur la terrasse du café lors d'une soirée d'été brûlante. Aucun billet ou réservation requis; votre imagination vous donne un accès VIP.

QUE SUENE LA MÚSICA

La música puede funcionar como una máquina del tiempo virtual que te hace viajar instantáneamente a tus recuerdos y momentos más entrañables, así como a destinos que jamás soñaste con visitar. Reproduce tu álbum favorito en nuestro tocadiscos de estilo antiguo, mueve el cuerpo al compás de las notas del Club de Jazz LEGO® Icons y emocionate con la sensacional atmósfera de mediados del siglo XX de este vibrante crisol donde se mezclan la música y la magia con artistas tan creativos como apasionados, los mejores chefs y un público conoecedor. Mira el espectáculo desde la oficina de la encargada, cultiva verduras para la cocina en el invernadero de la azotea, siente el nerviosismo de estar adentro del camerino momentos antes de tu actuación, ordena un bocadillo de medianoche o disfruta una completísima comida en el café de la banqueta una cálida noche de verano. No necesitas boleto ni reservación: tu imaginación te garantiza el acceso vip.



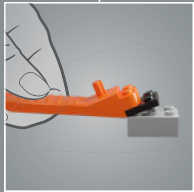
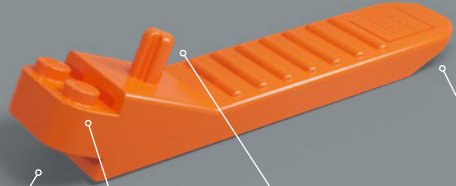

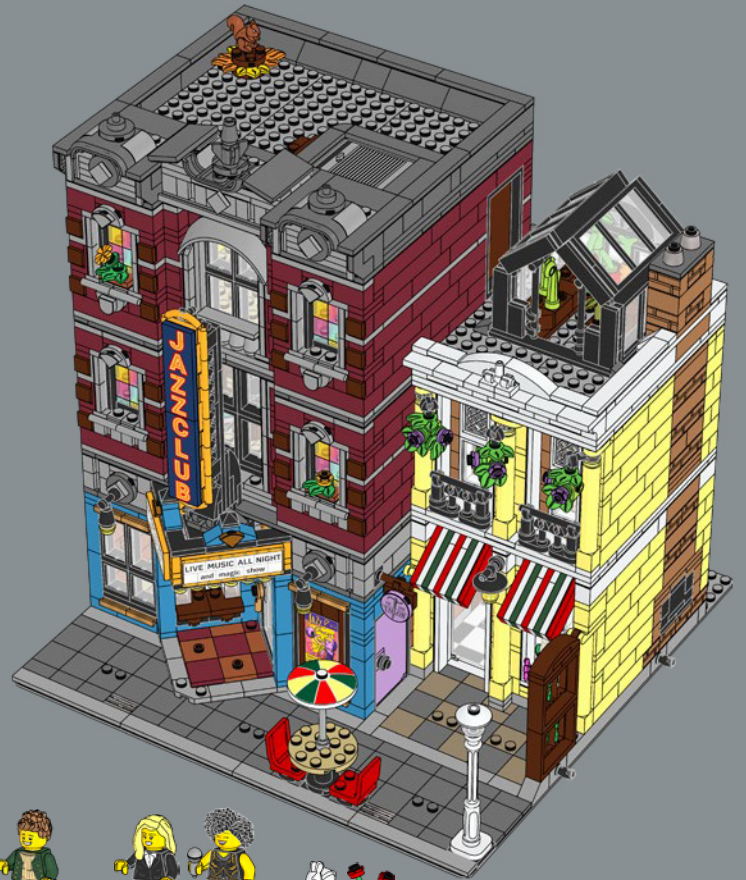
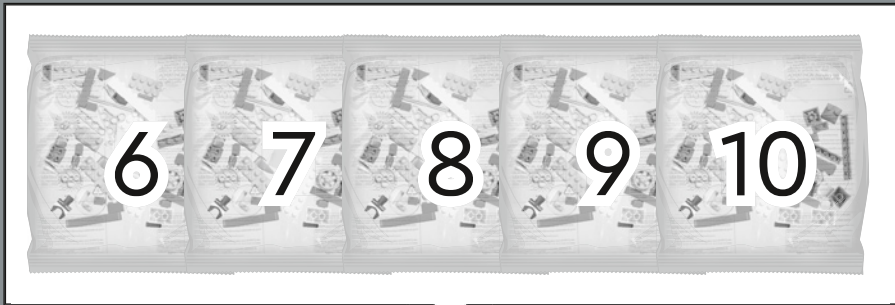

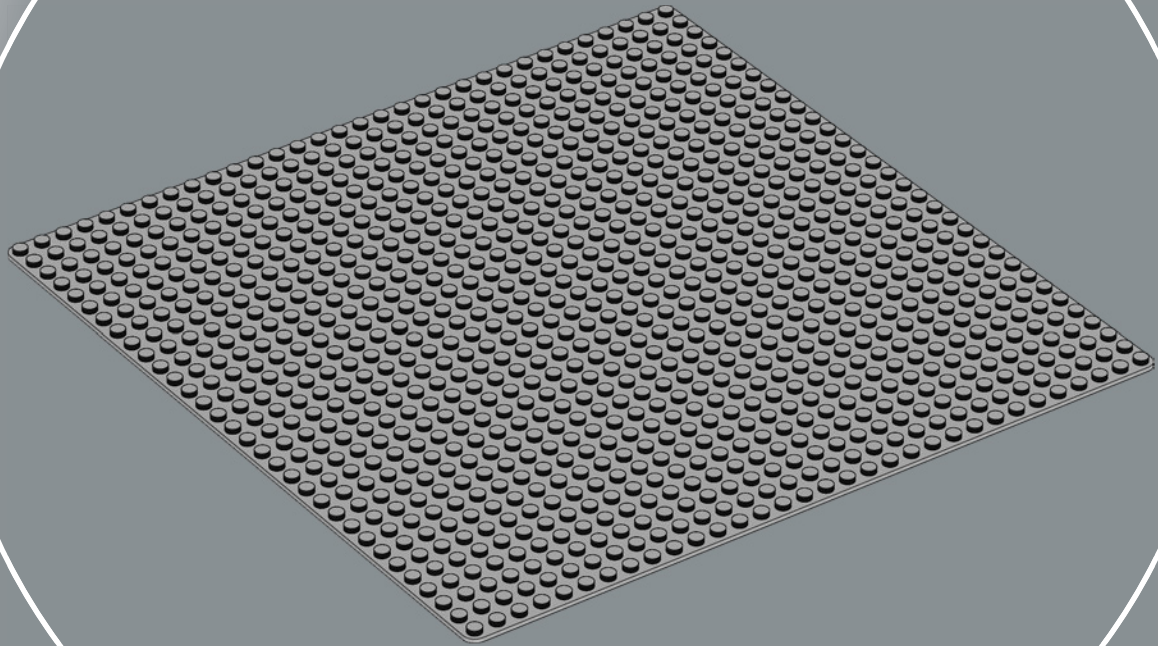
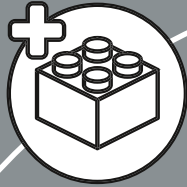

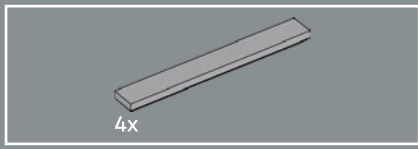

1

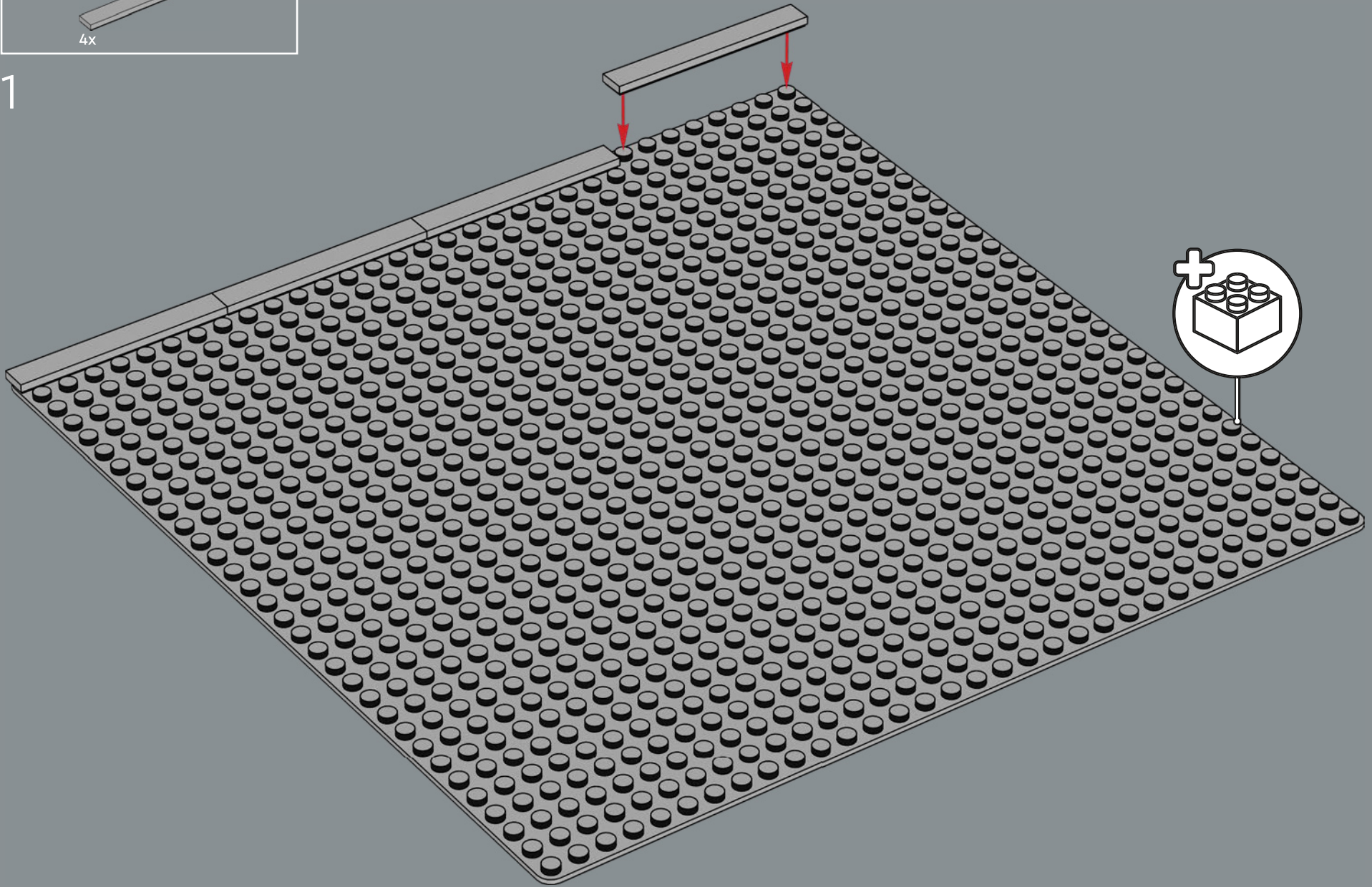

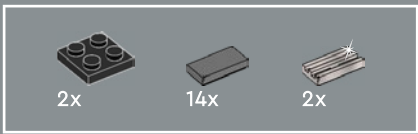

2

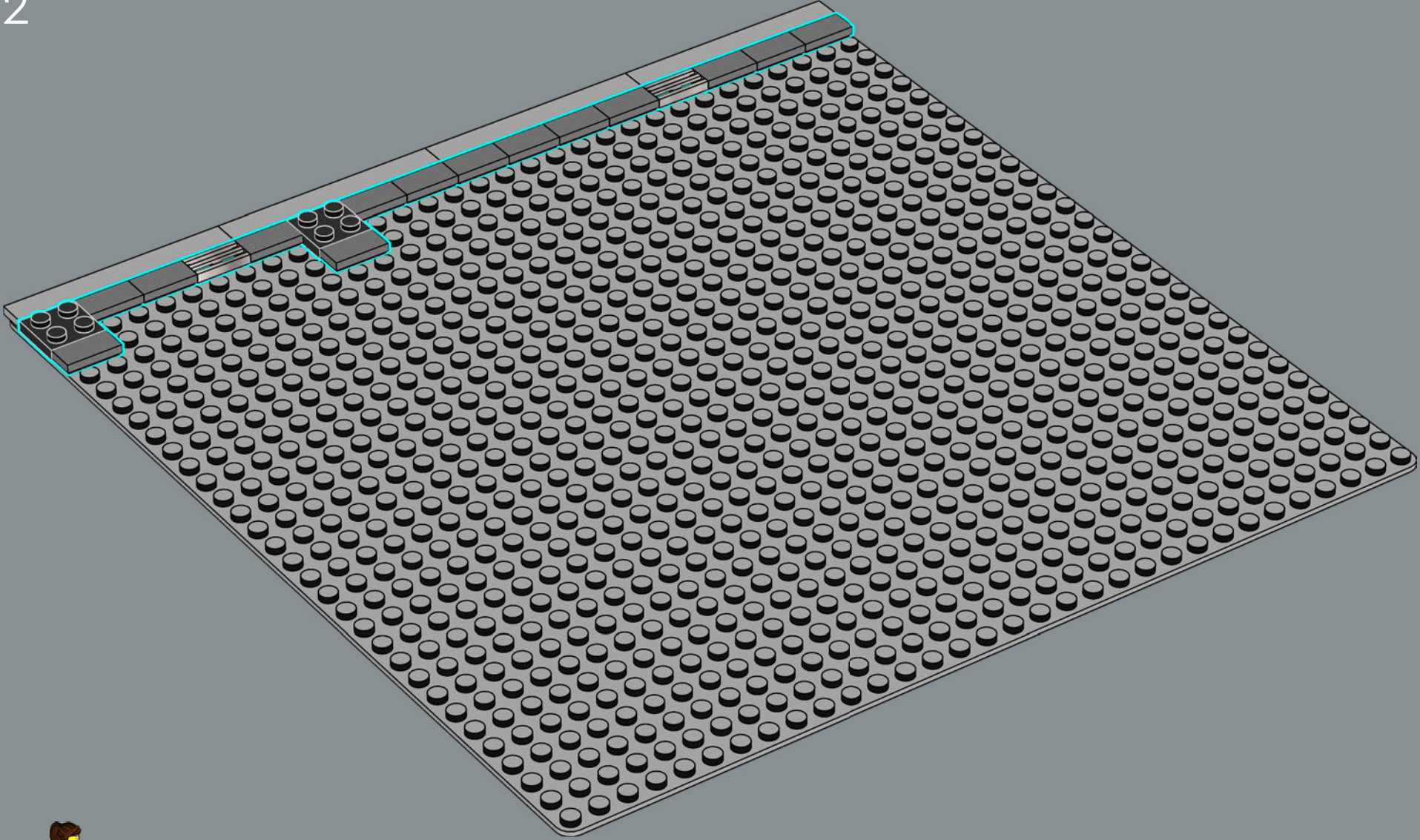

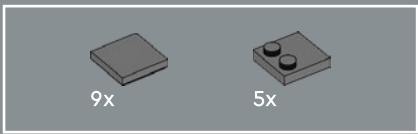

3

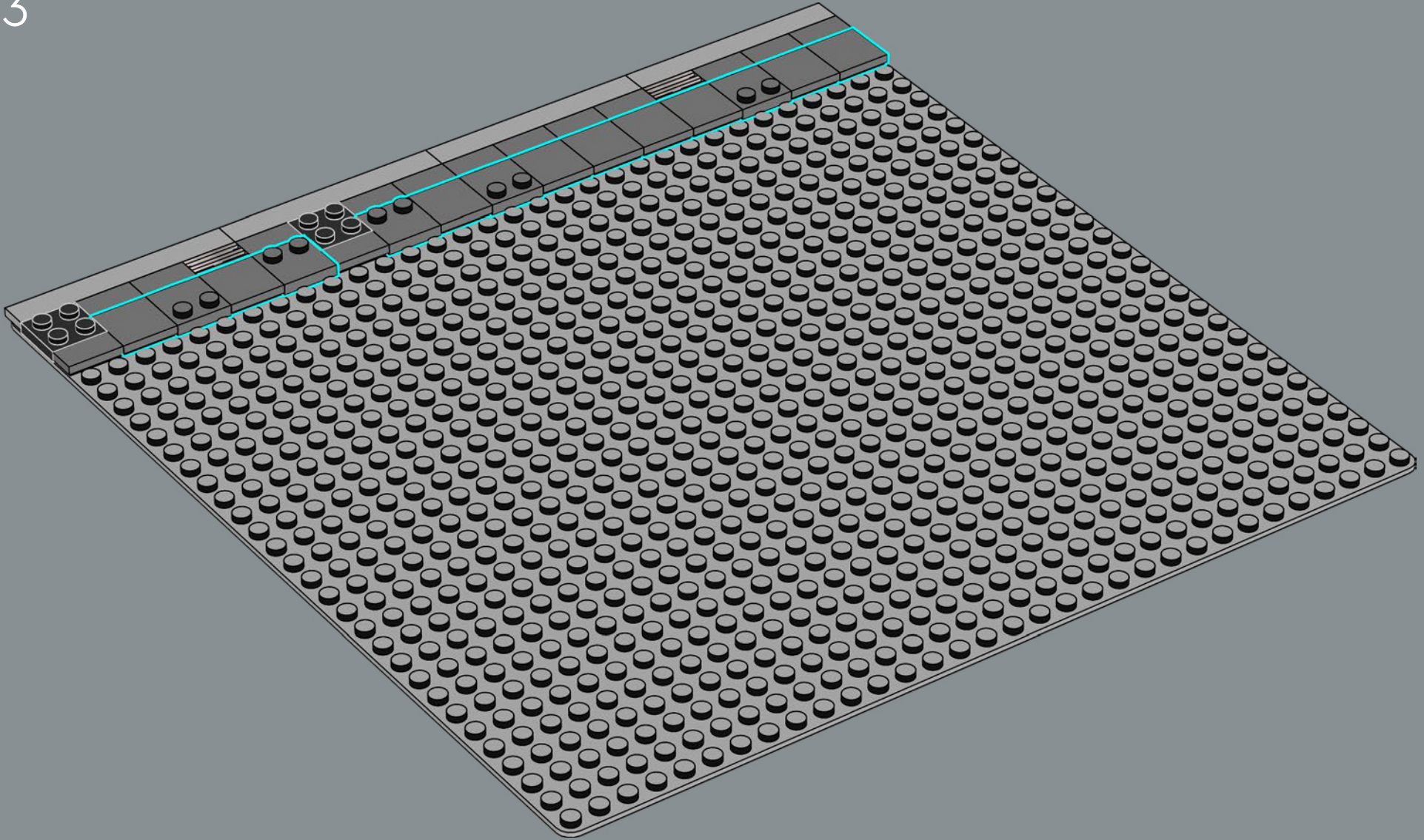

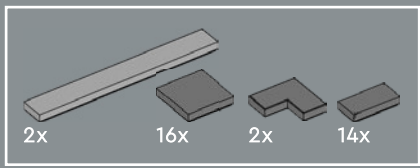

4

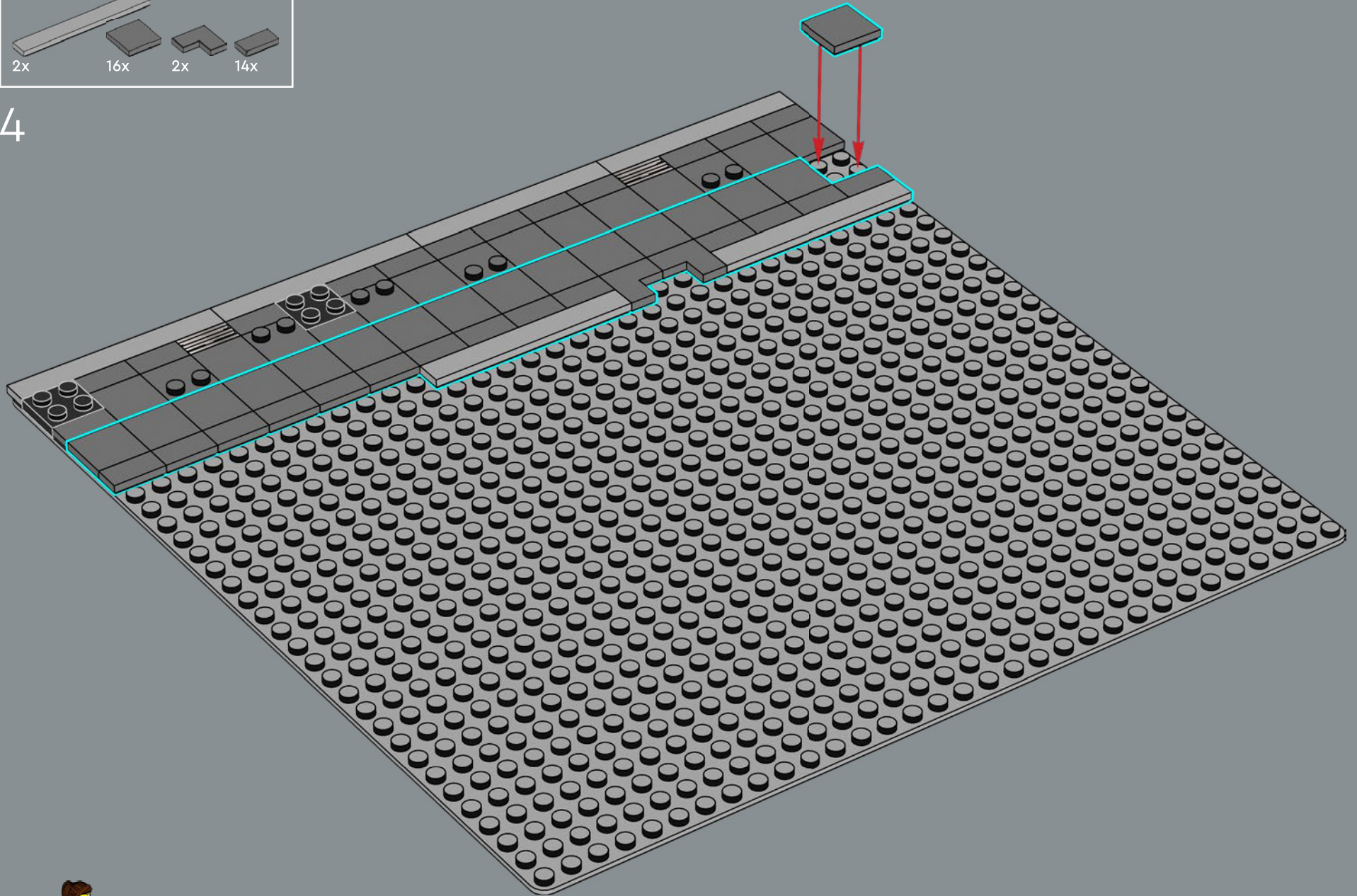

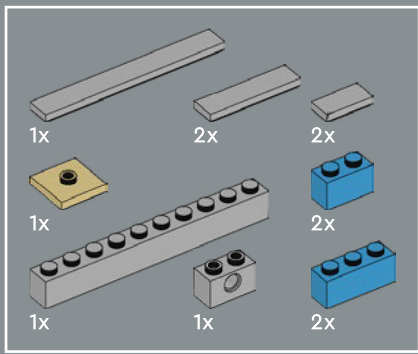

5

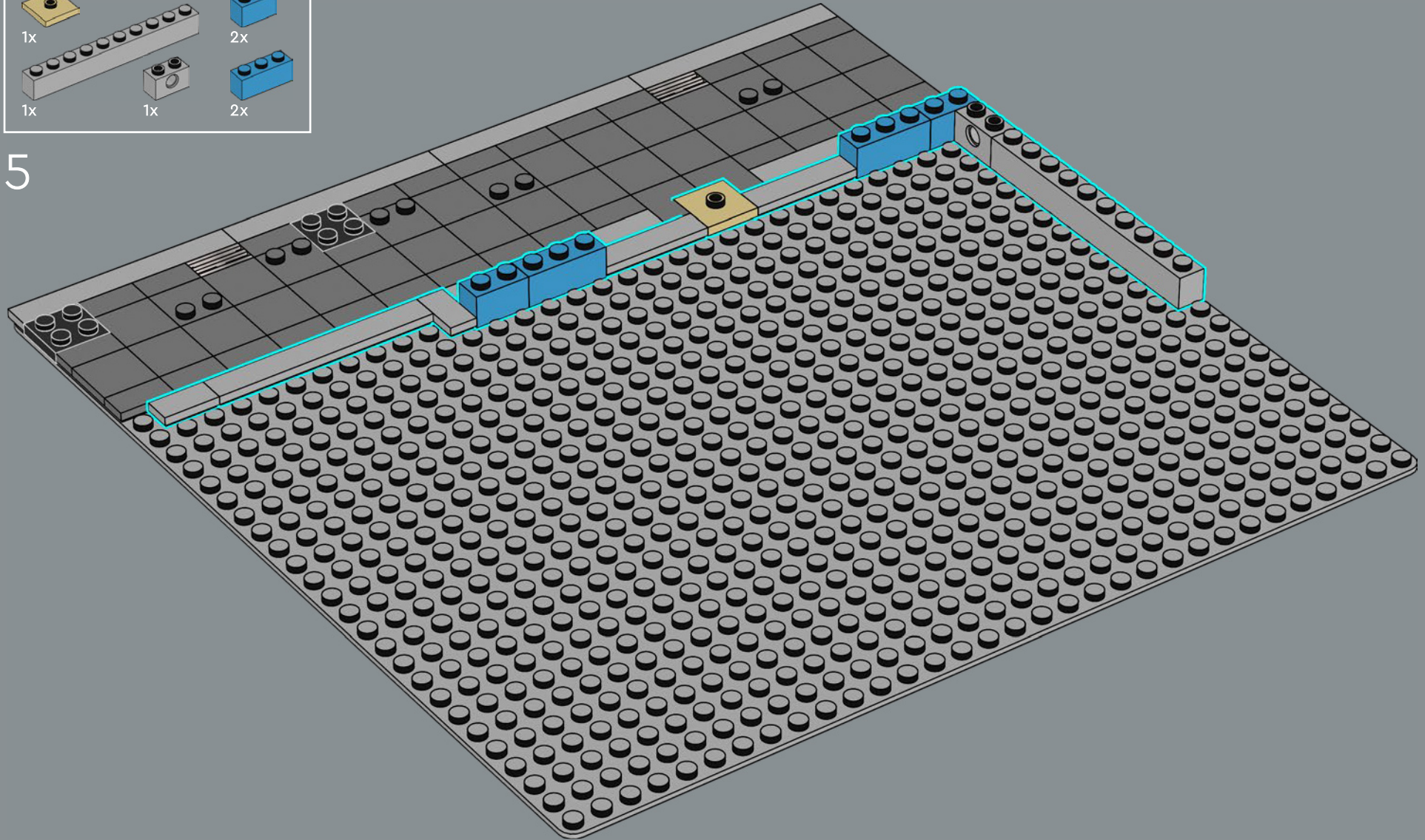

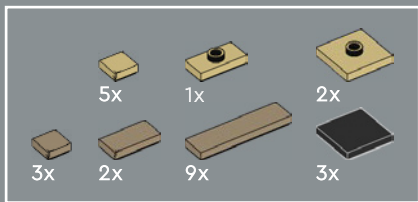

6

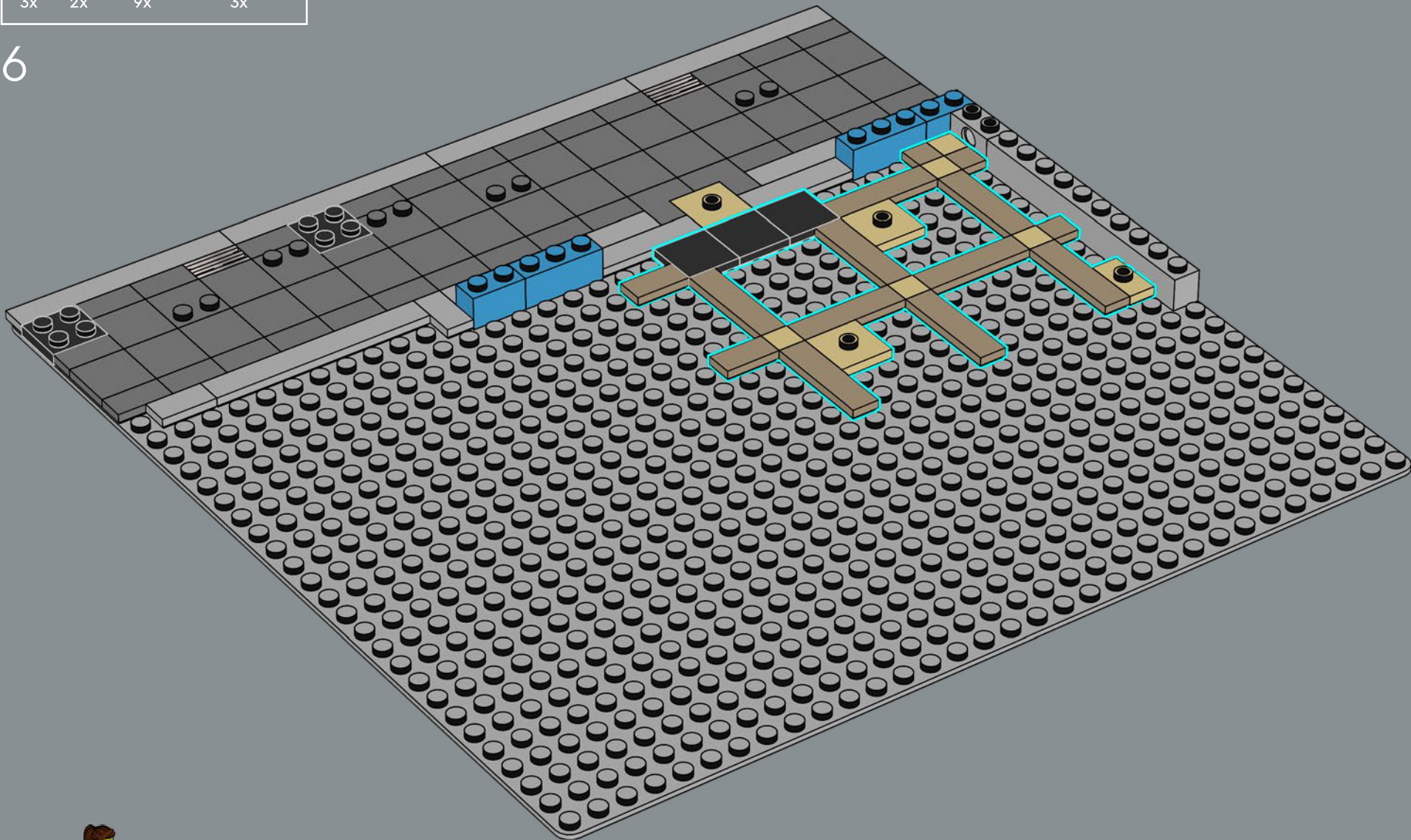

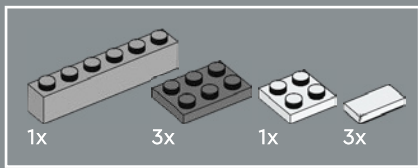

7

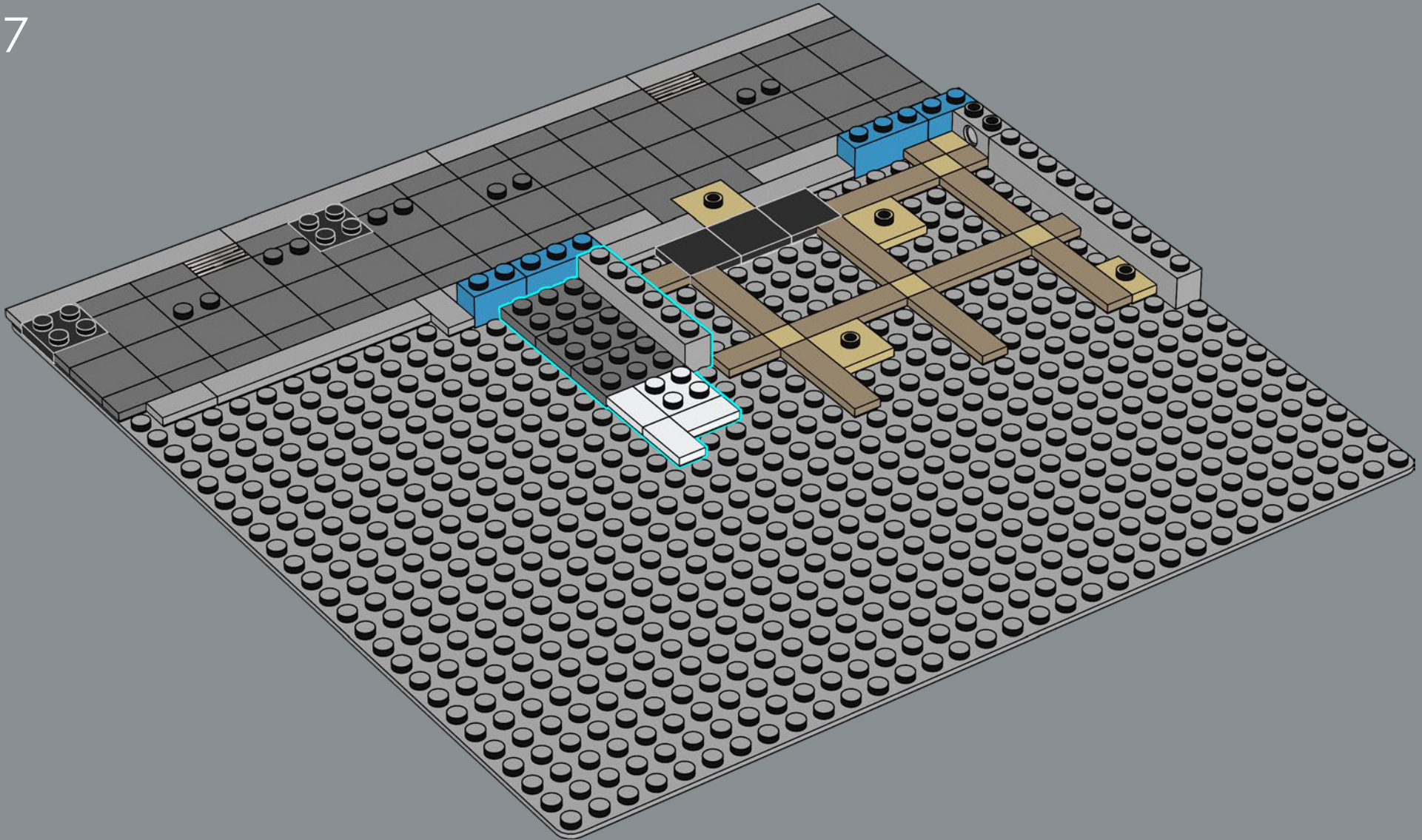

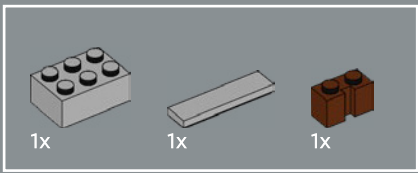

8

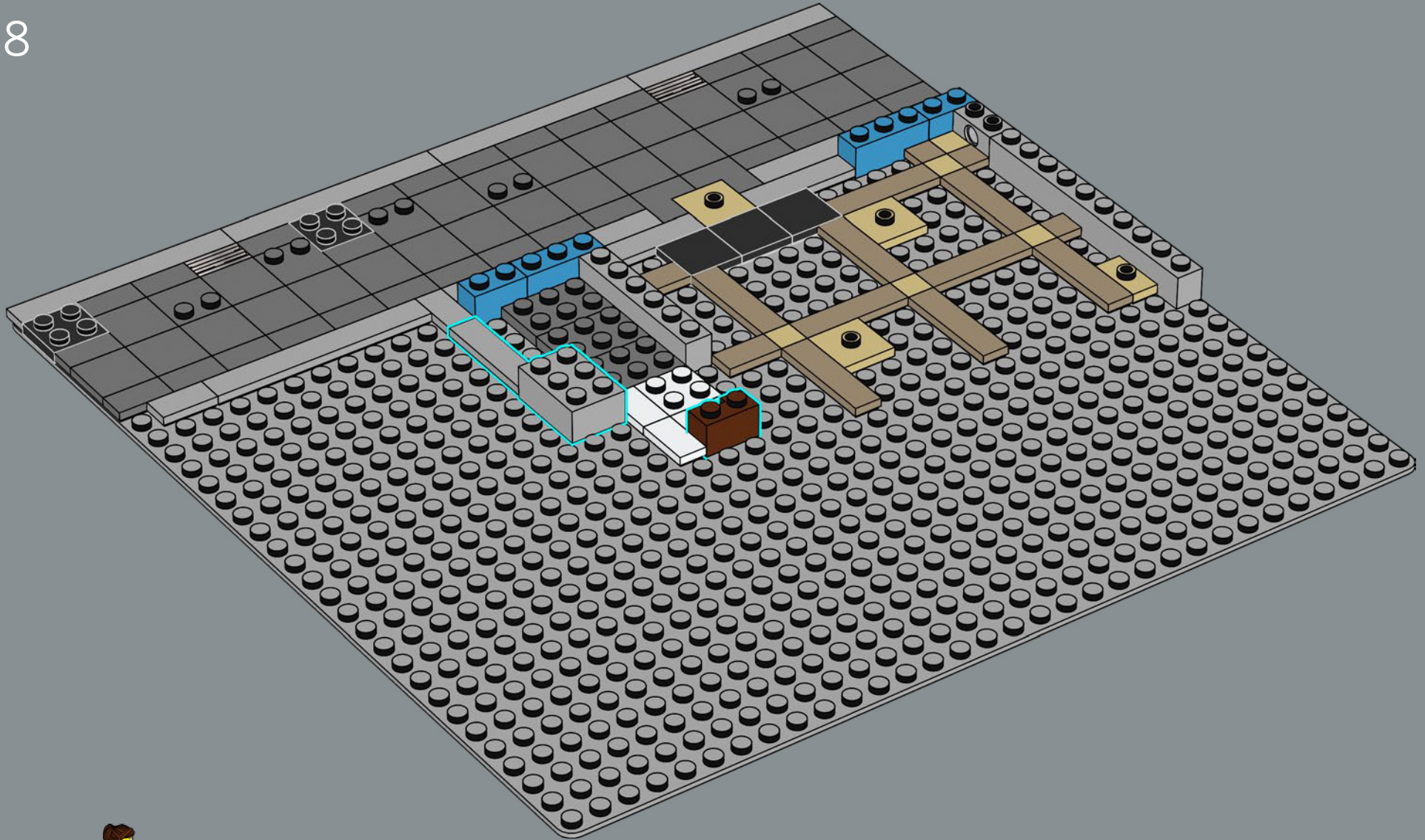

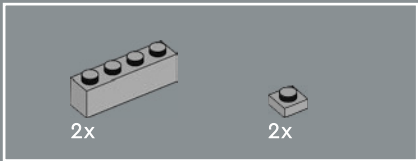

10

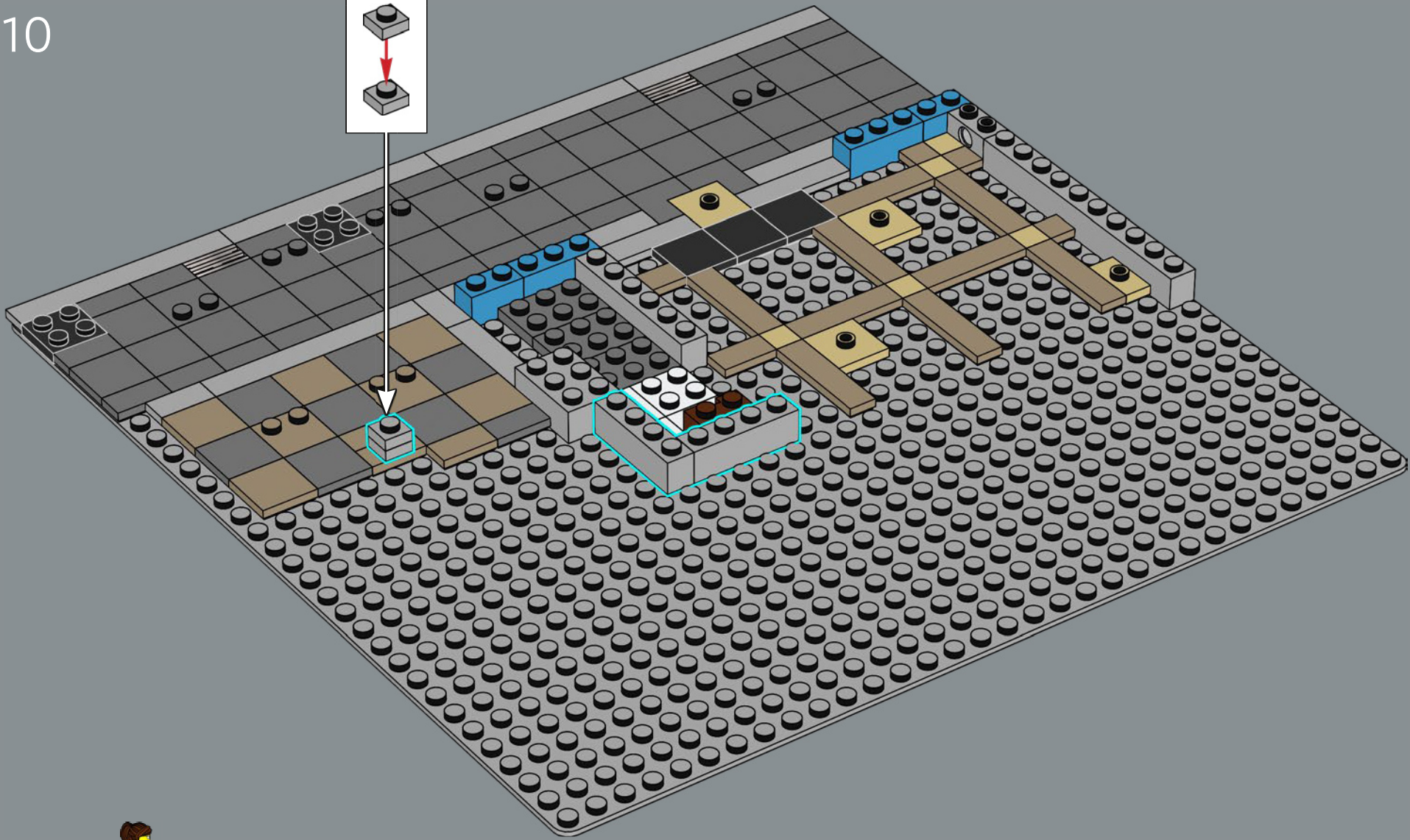
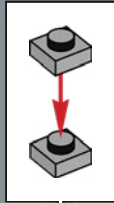

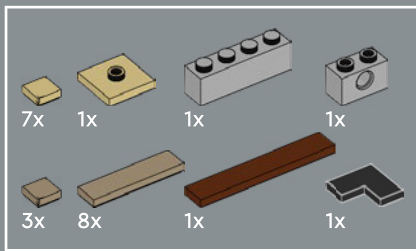

11

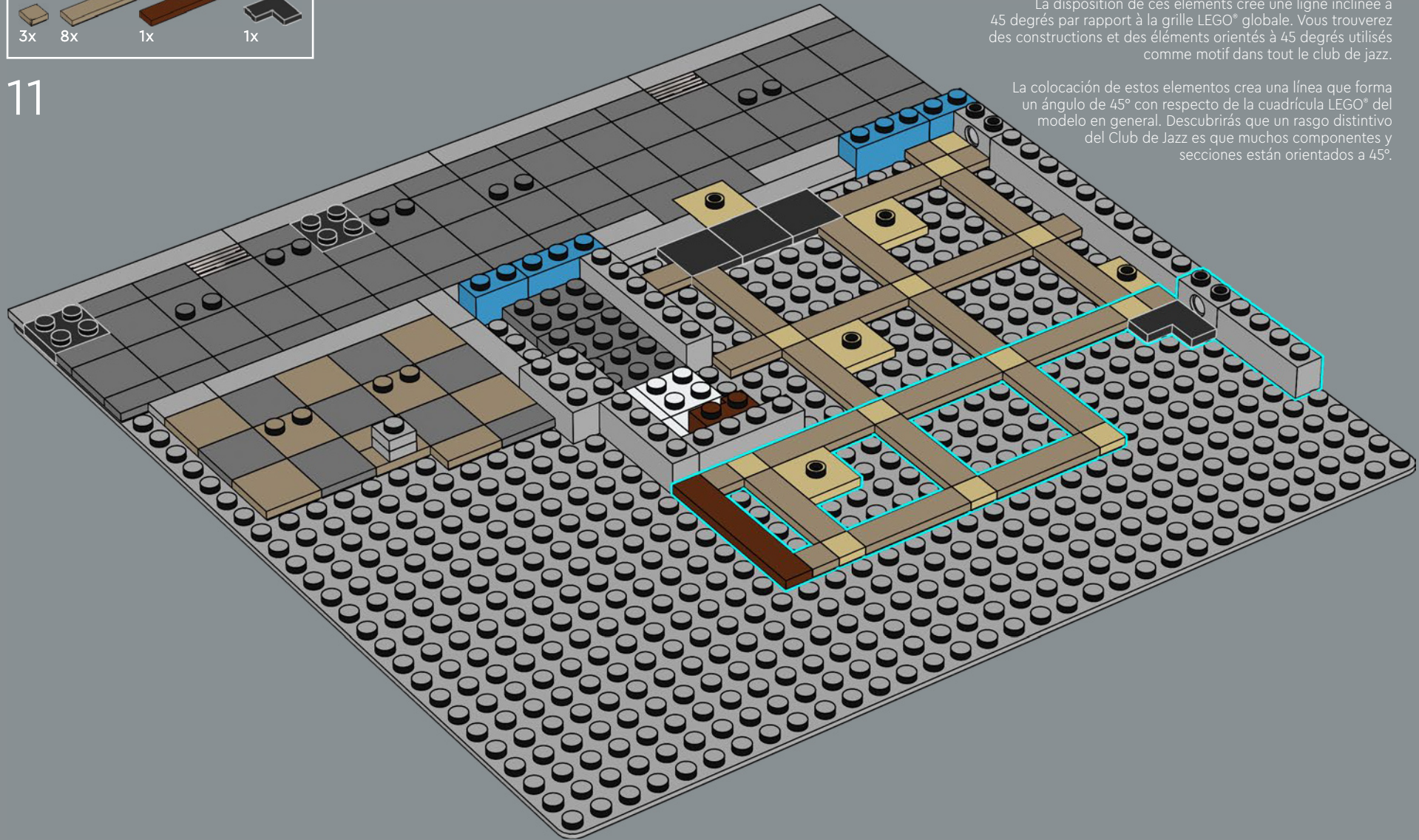

The placement of these elements creates a line angled at 45 degrees to the overall LEGO® grid. You'll find builds and elements oriented at 45 degrees used as a motif throughout the Jazz Club.

La disposition de ces éléments crée une ligne inclinée à 45 degrés par rapport à la grille LEGO® globale. Vous trouverez des constructions et des éléments orientés à 45 degrés utilisés comme motif dans tout le club de jazz.

La colocación de estos elementos crea una línea que forma un ángulo de 45° con respecto de la cuadrícula LEGO® del modelo en general. Descubrirás que un rasgo distintivo del Club de Jazz es que muchos componentes y secciones están orientados a 45°.

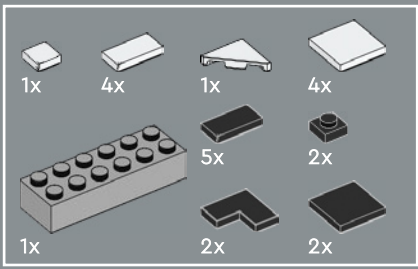



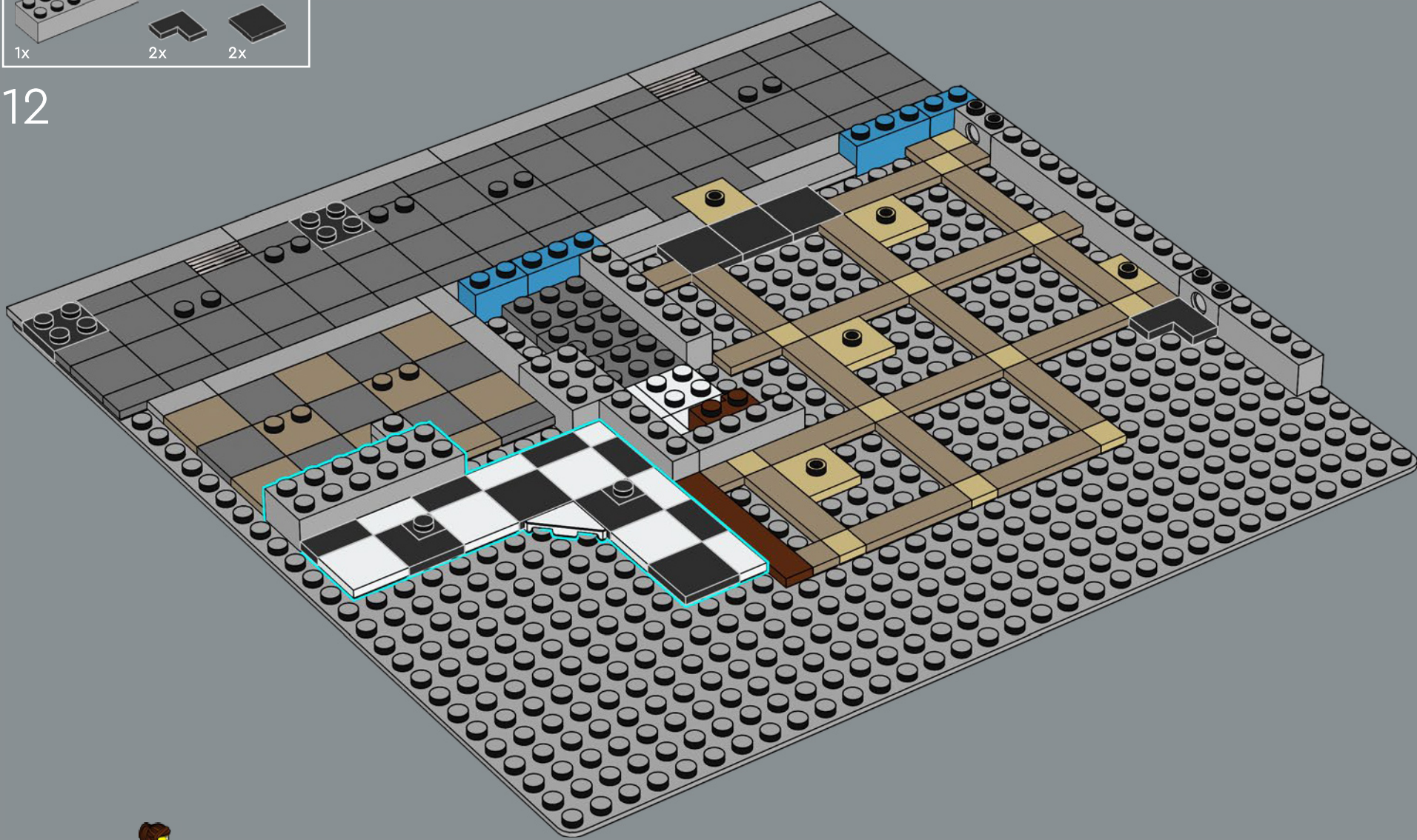

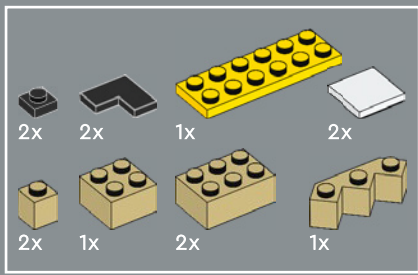



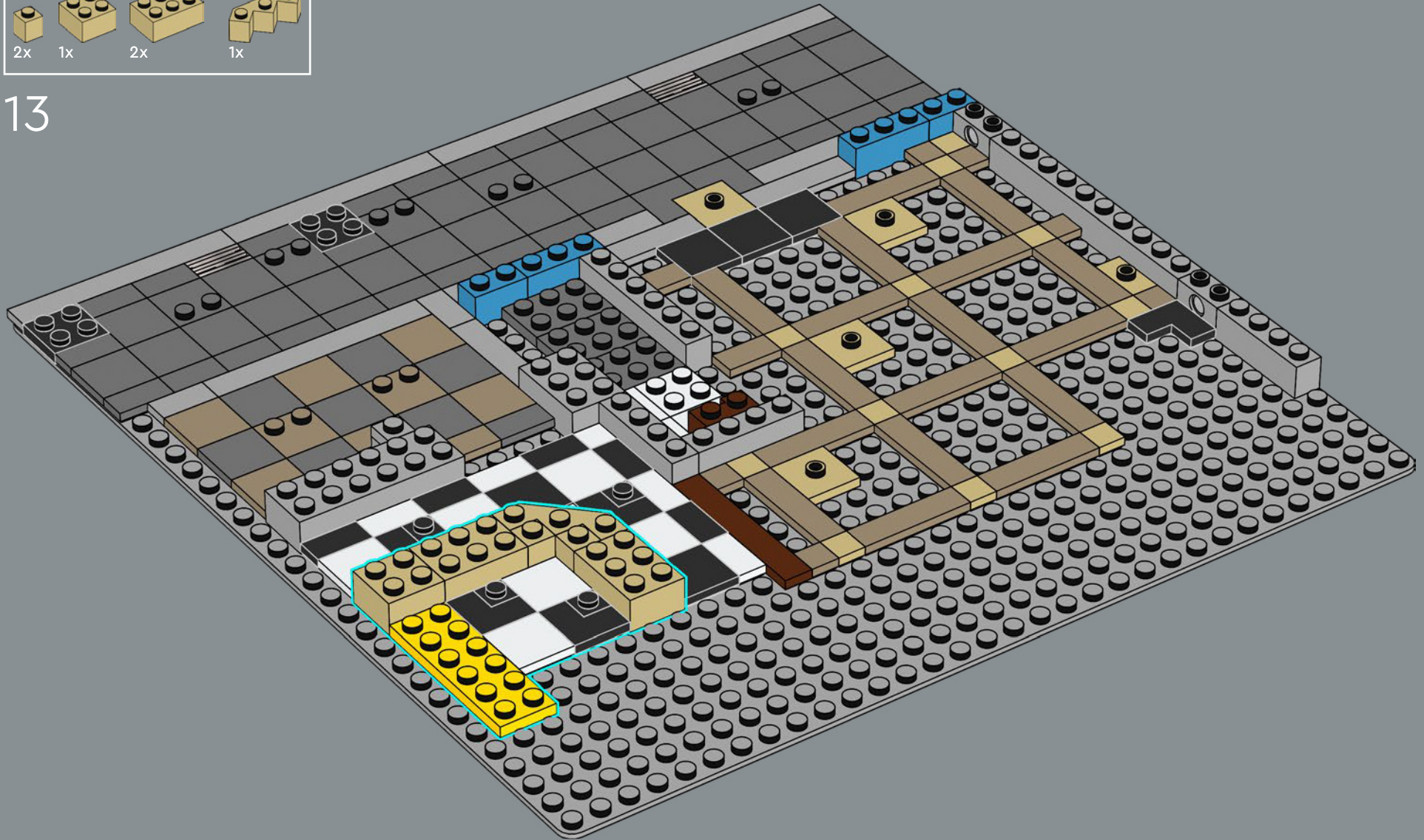

12





13



- | | | | | |
|---|---|---|---|---|
|  |  |  |  |  |
| 2x | 1x | 3x | 1x | 1x |
|  |  |  |  |  |
| 1x | 1x | 2x | 2x | 1x |

14

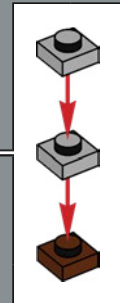
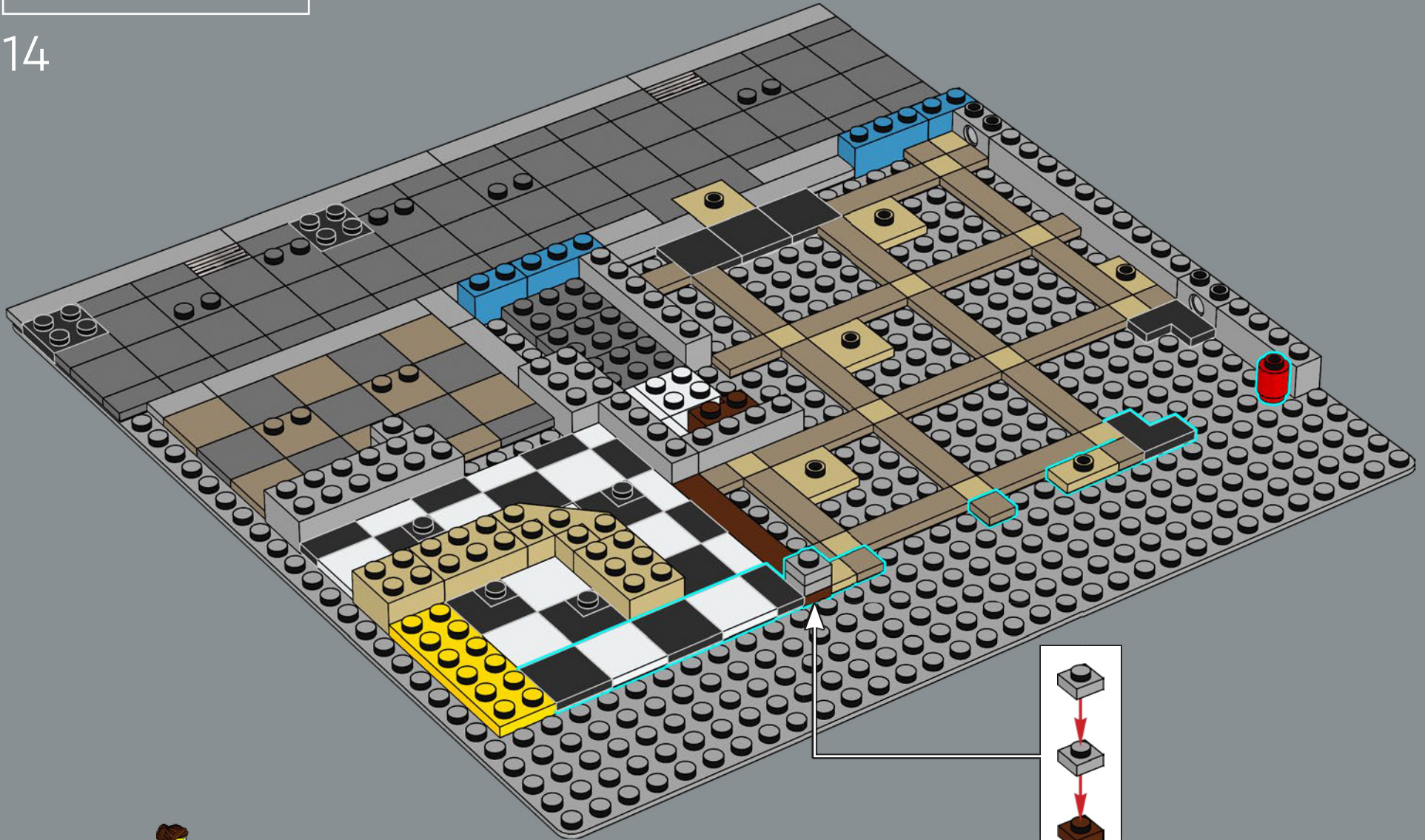

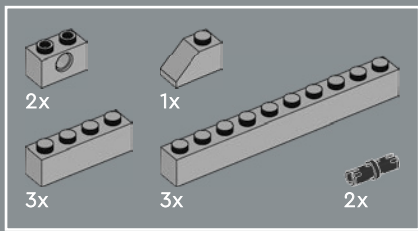

15

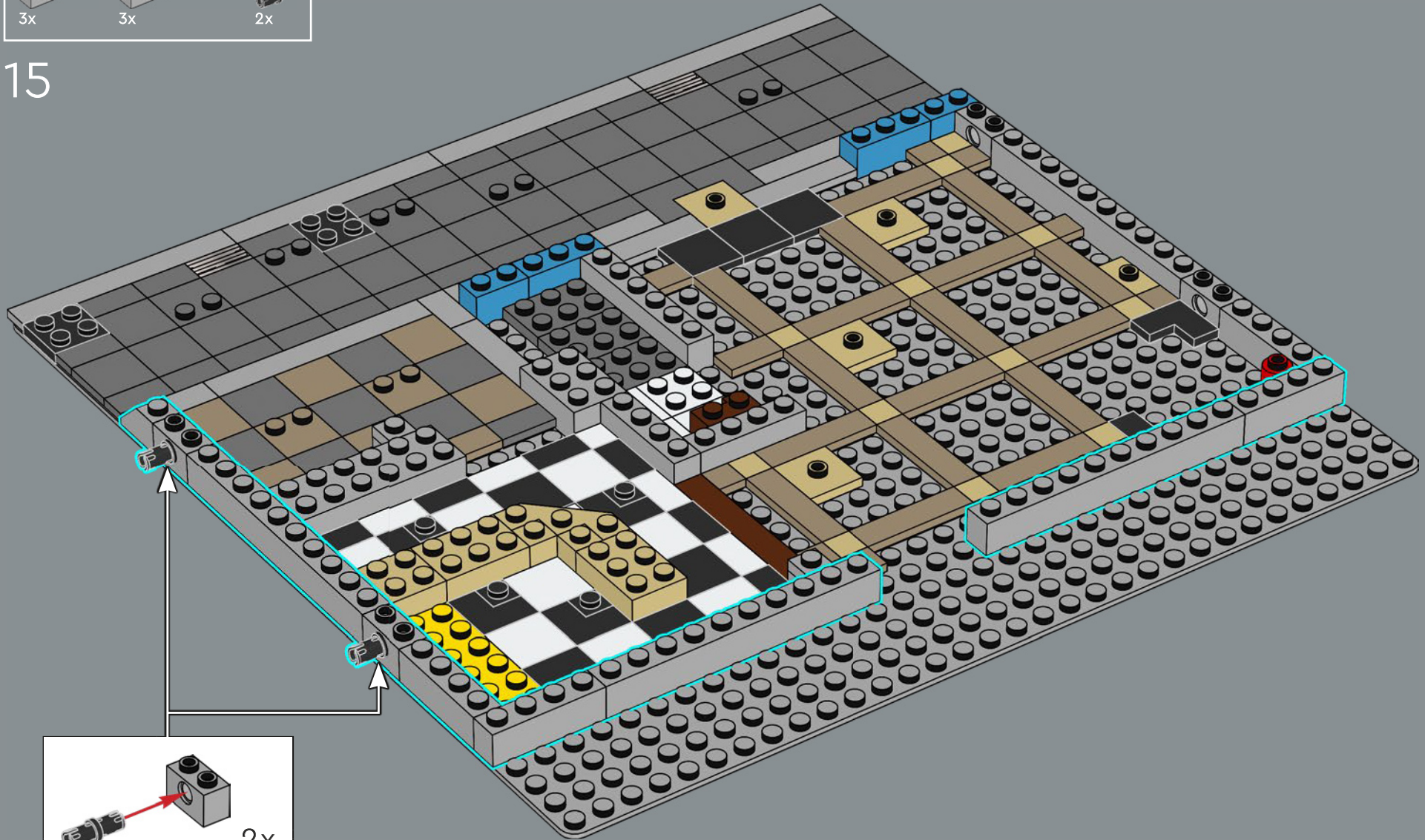

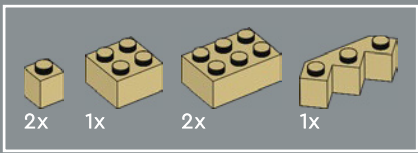

16

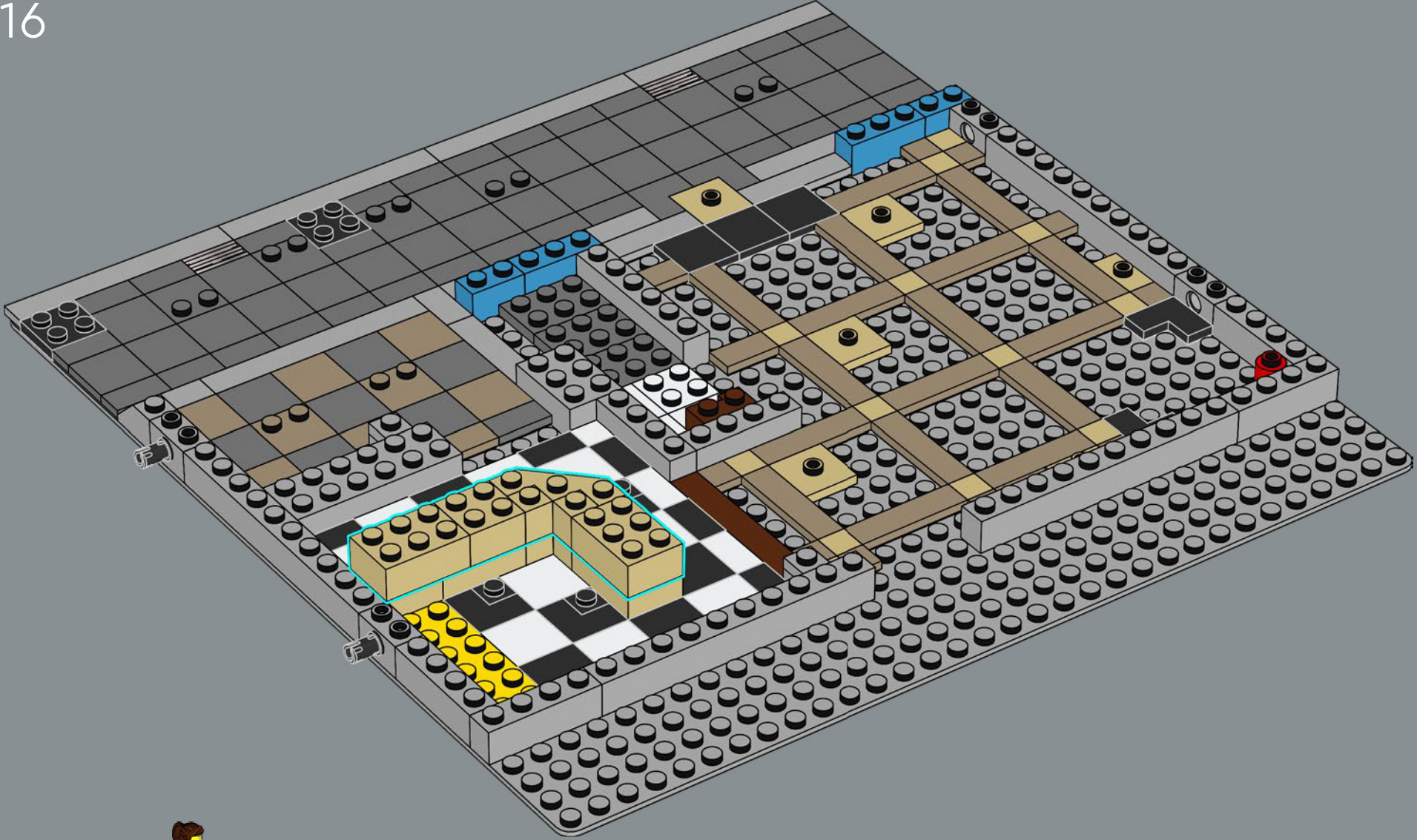



The drummer is excited to try out the new drum kit for sale at the music store located in the LEGO® 10255 Assembly Square.

La batteuse est impatiente d'essayer la nouvelle batterie en vente au magasin de musique situé dans la Place de l'assemblée LEGO® 10255.

El percusionista está probando la nueva batería que está a la venta en la tienda de música de la Gran Plaza LEGO® (10255), ¡y no podría estar más emocionado!

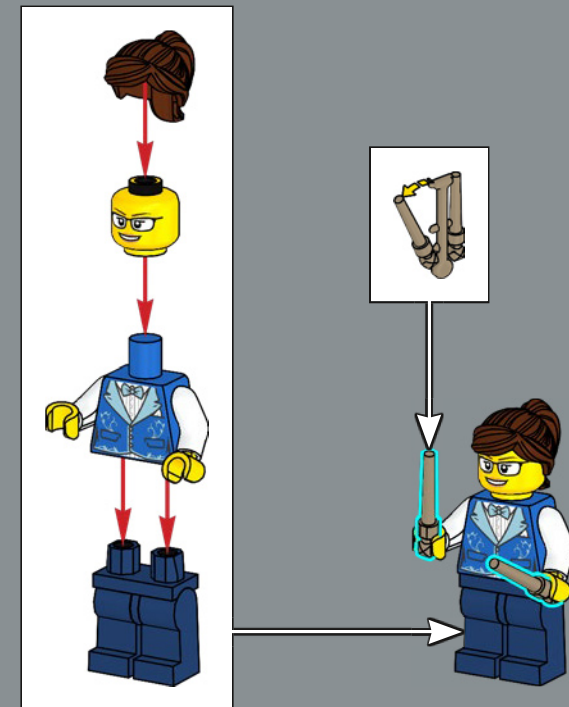

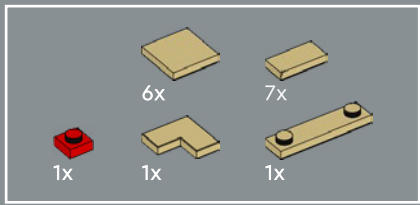

17

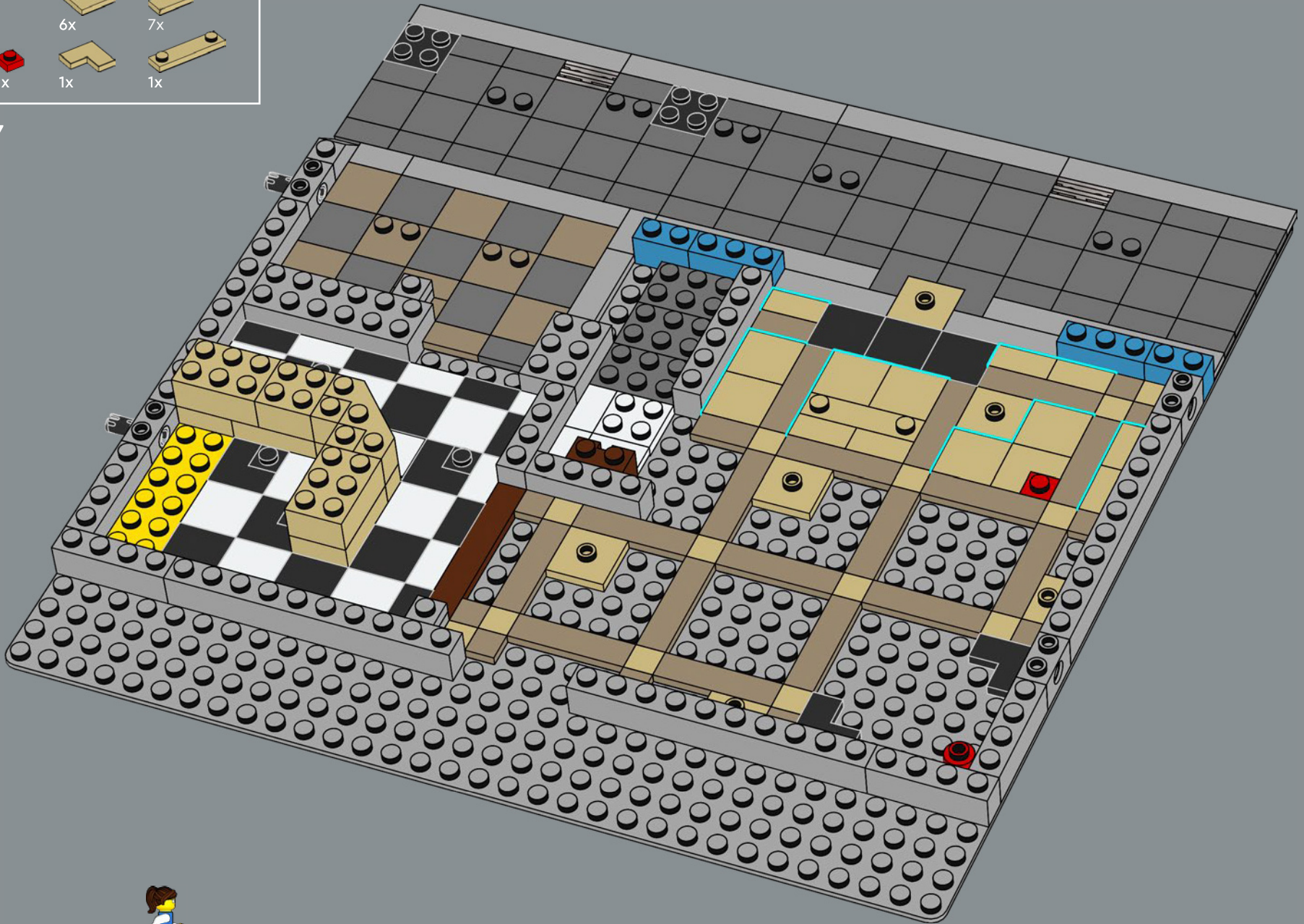

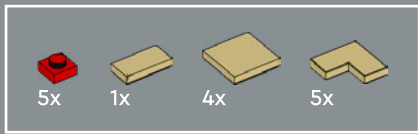

18

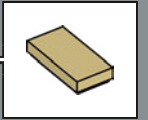
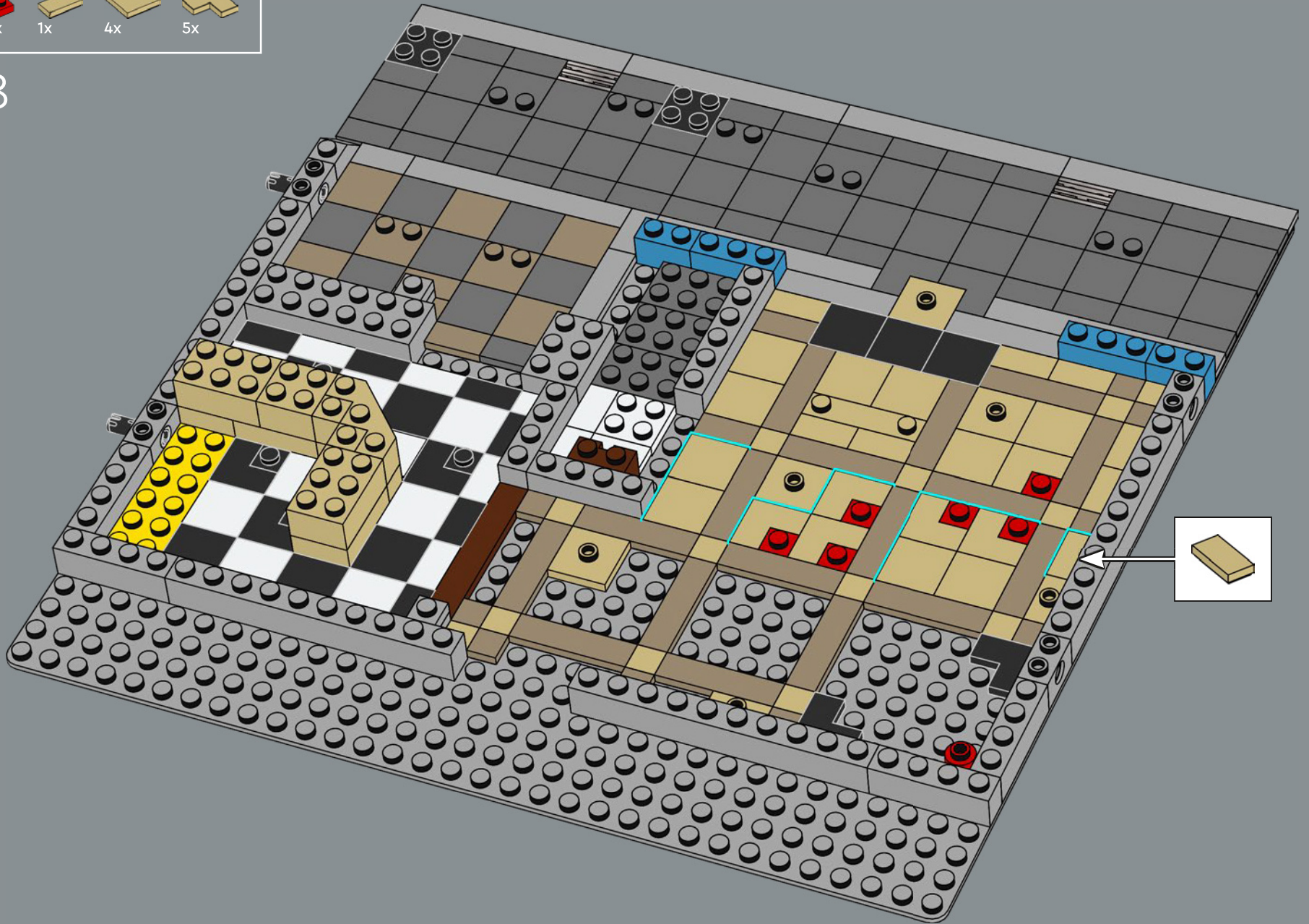

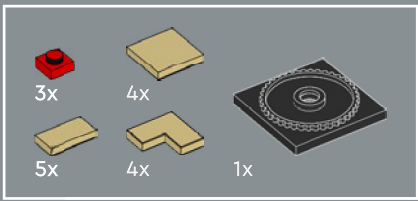

19

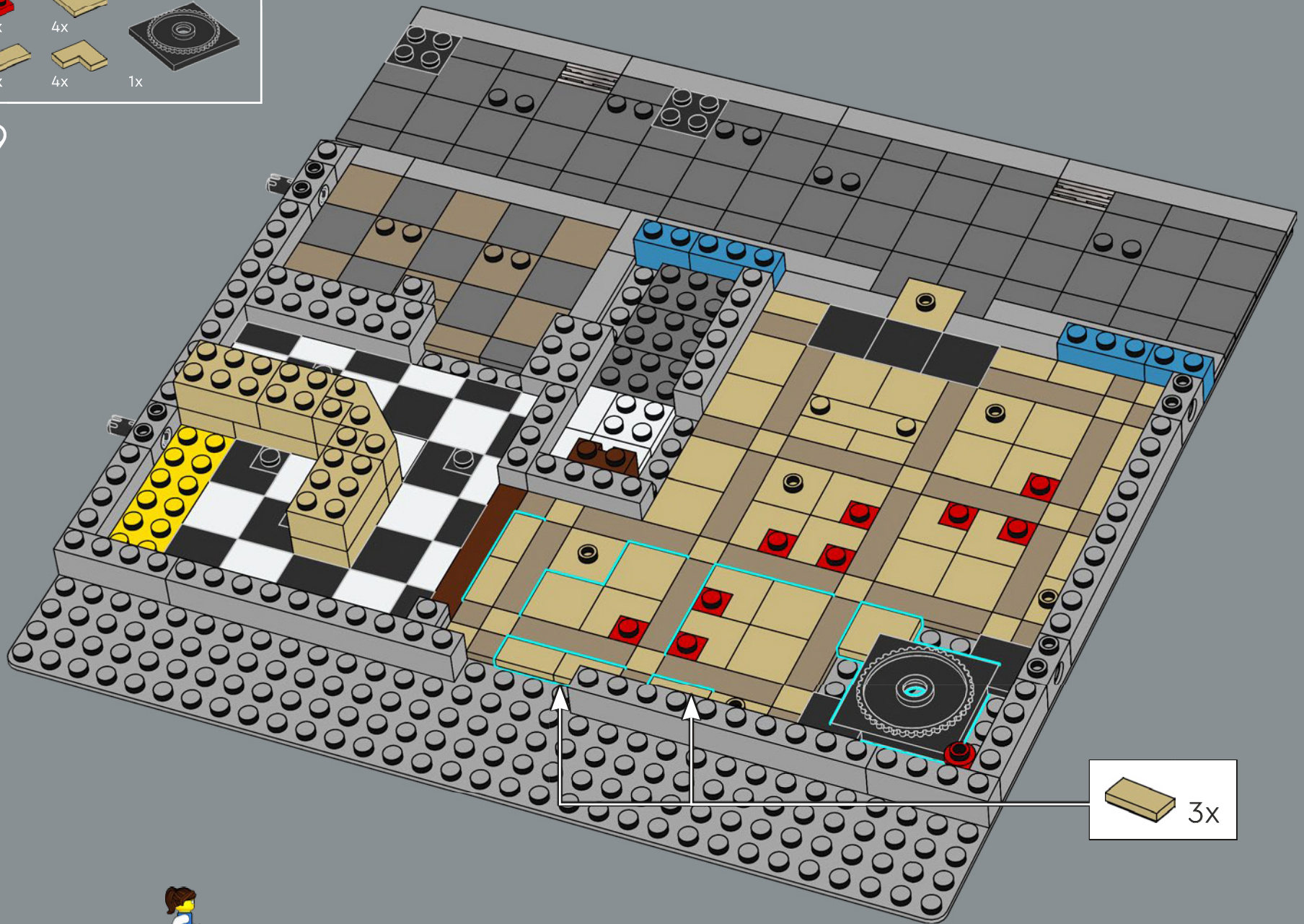

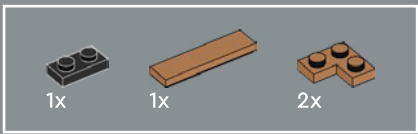

20

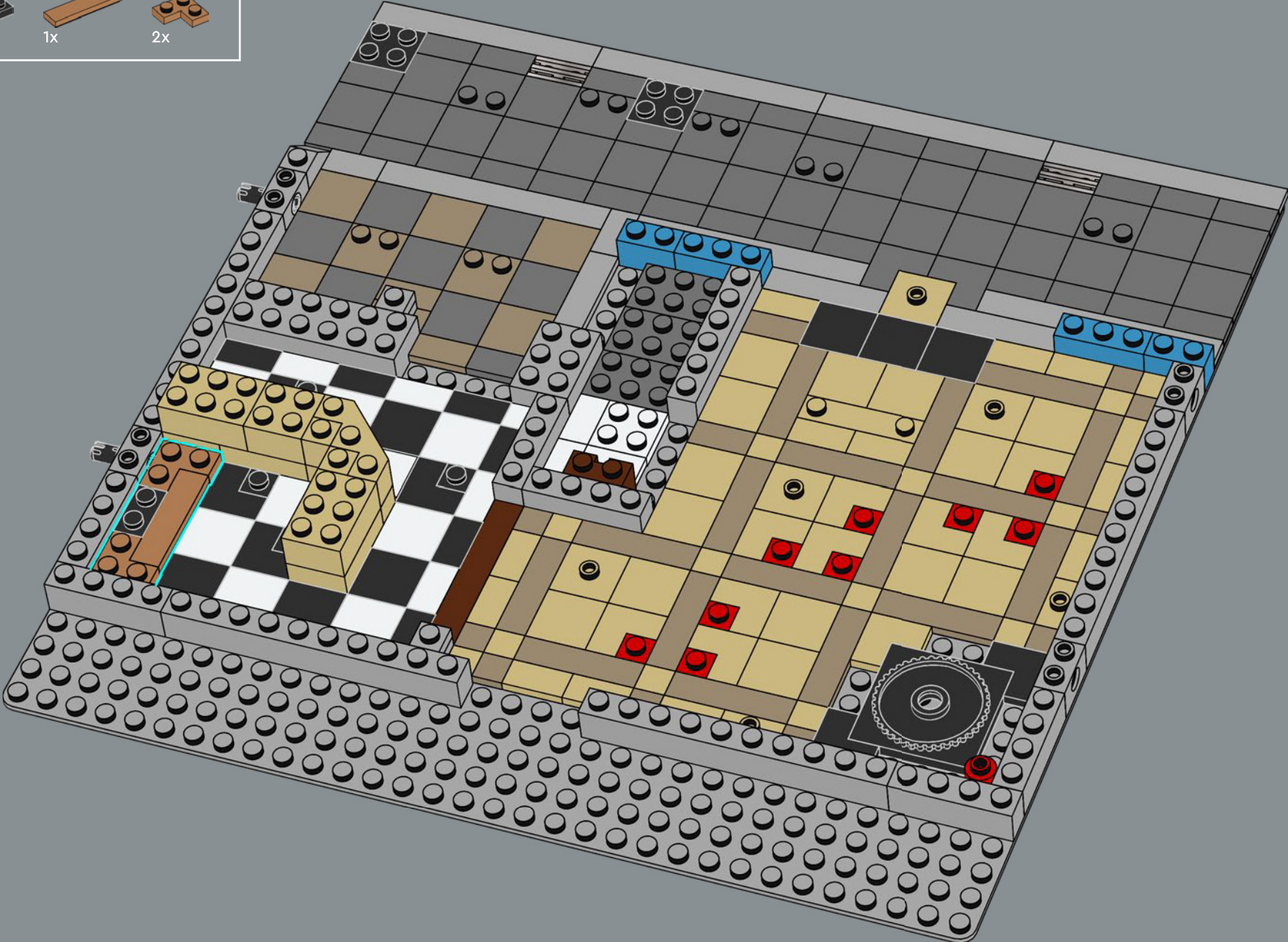

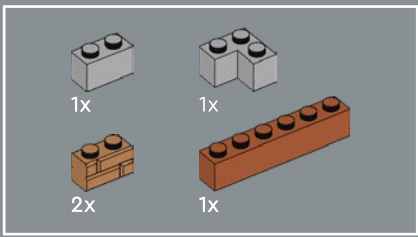

21

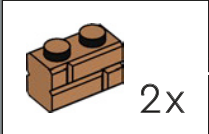
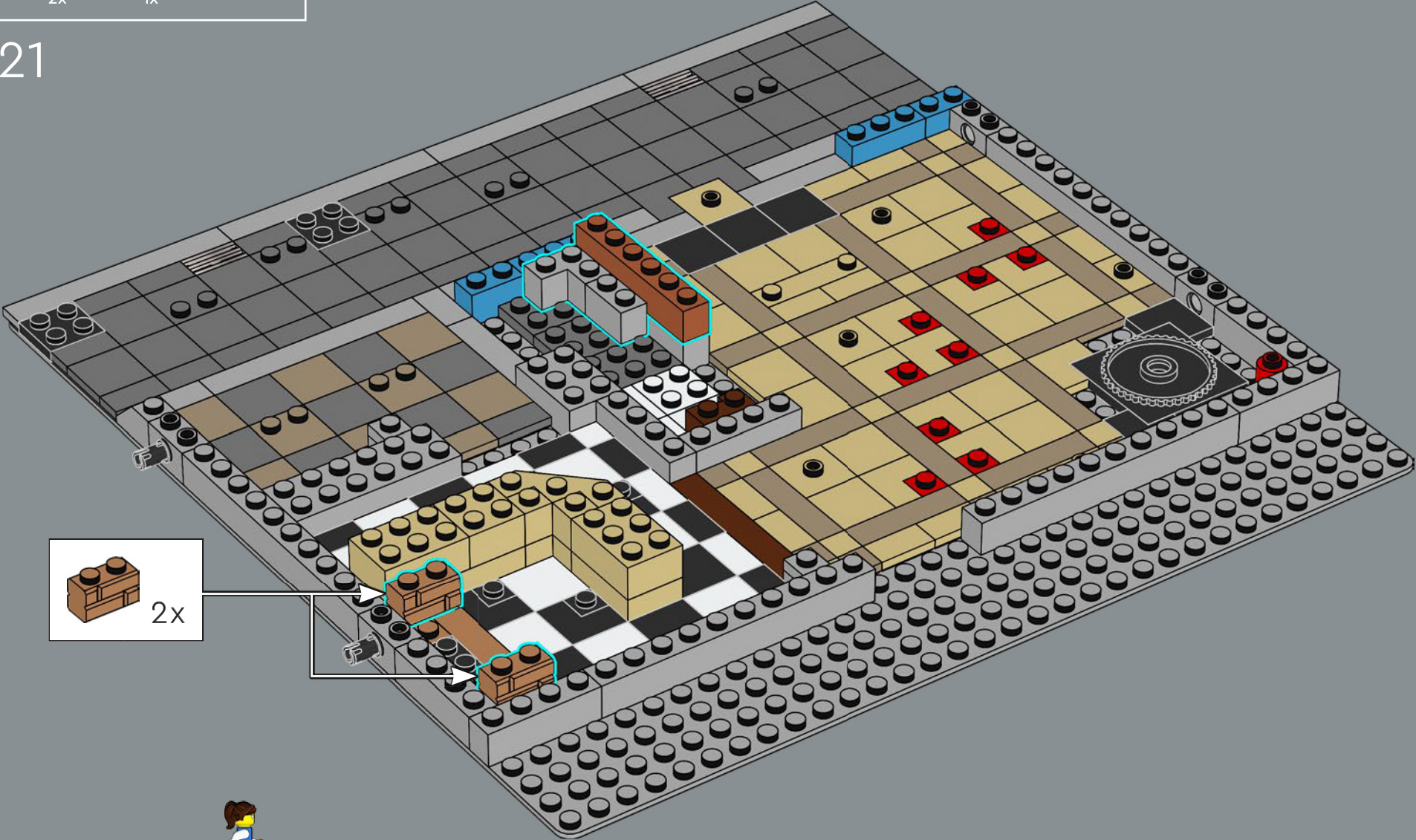

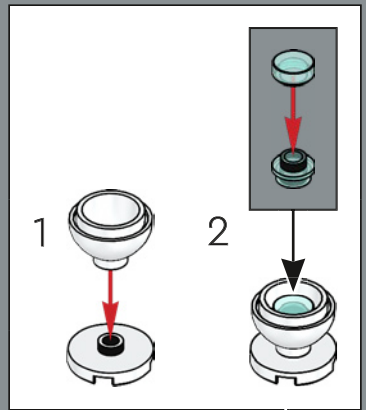
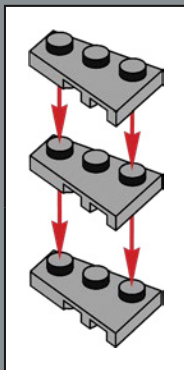
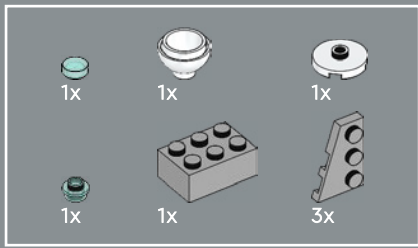

22

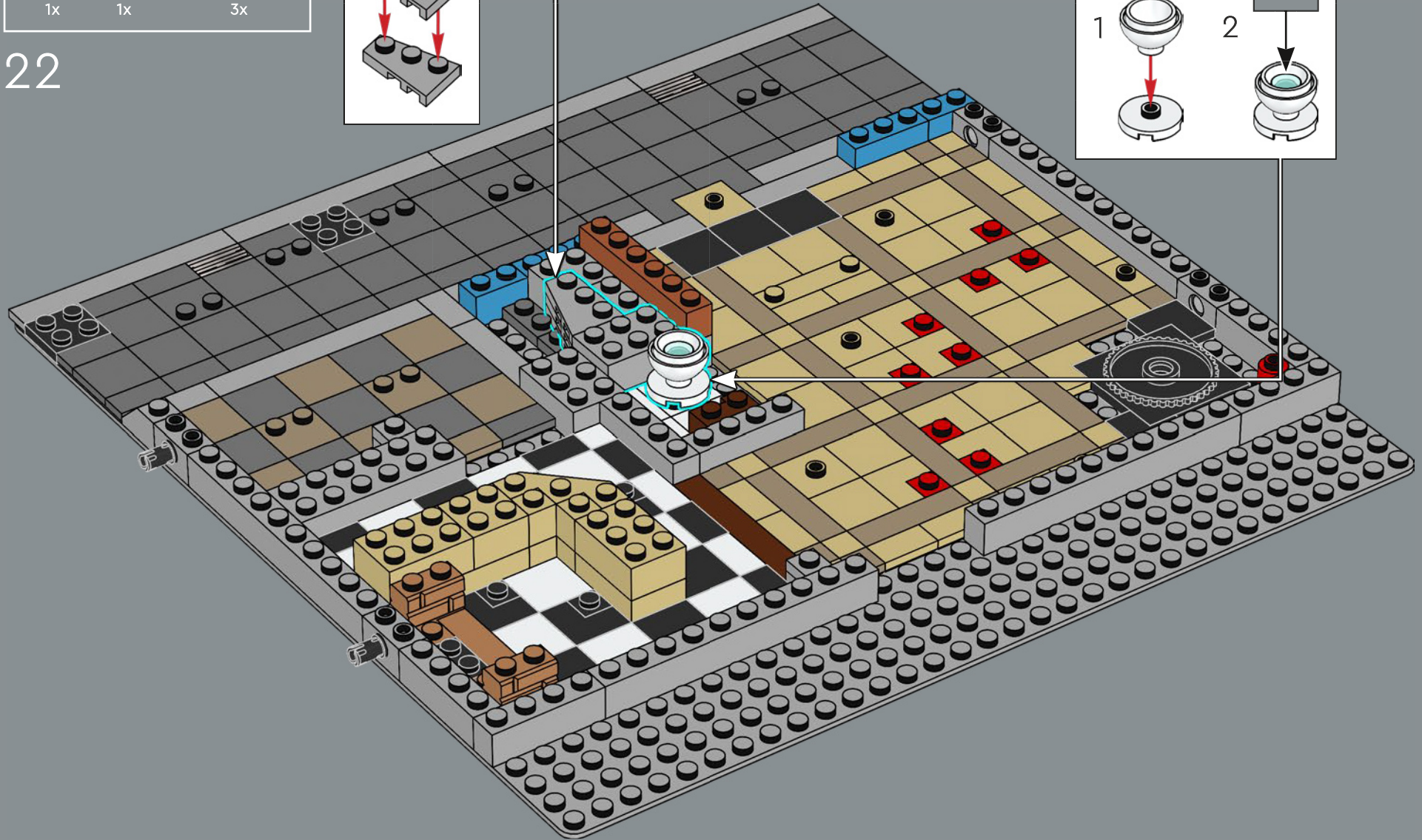

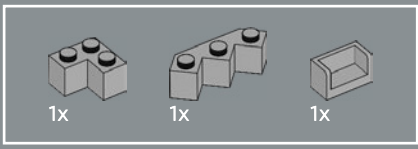

23

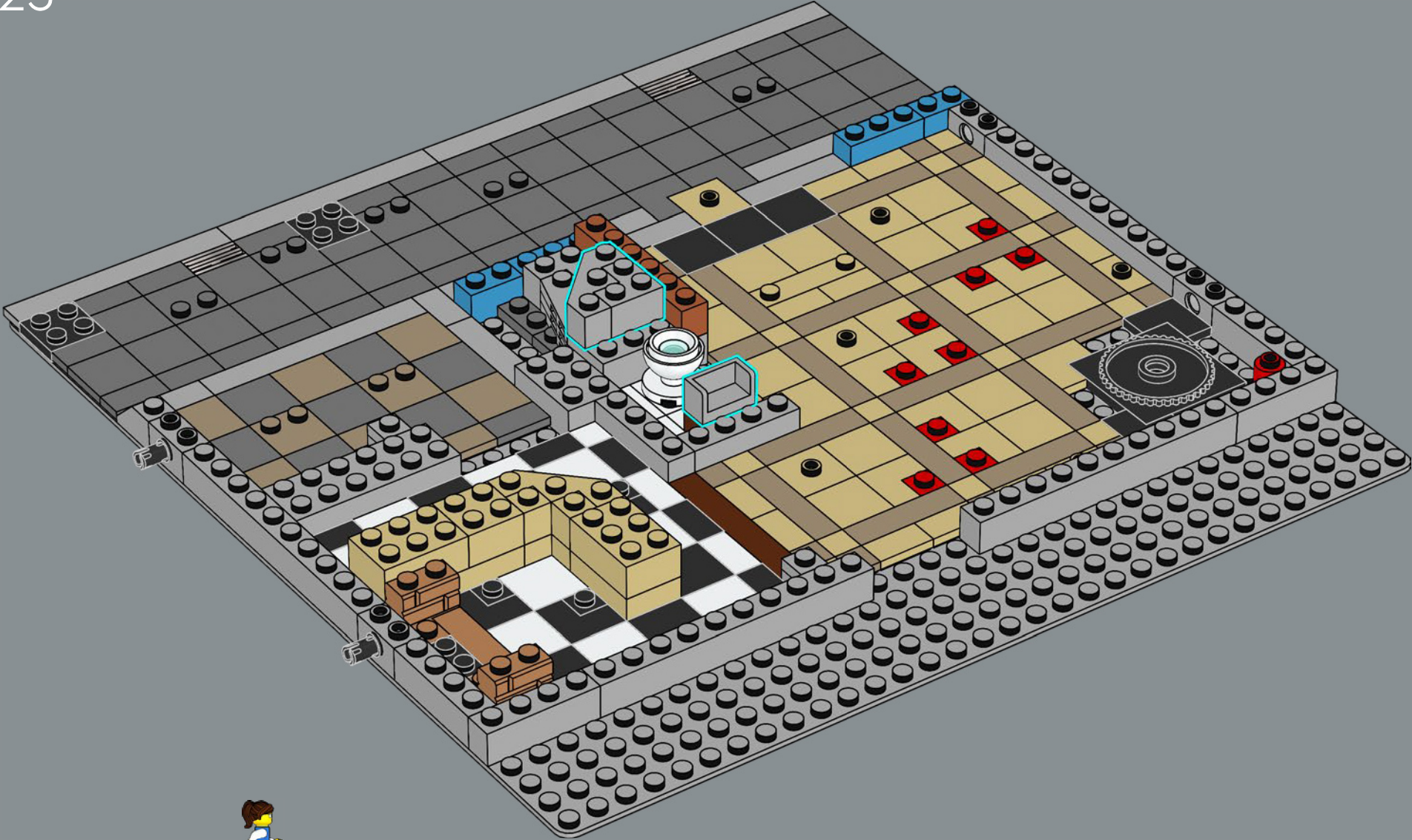

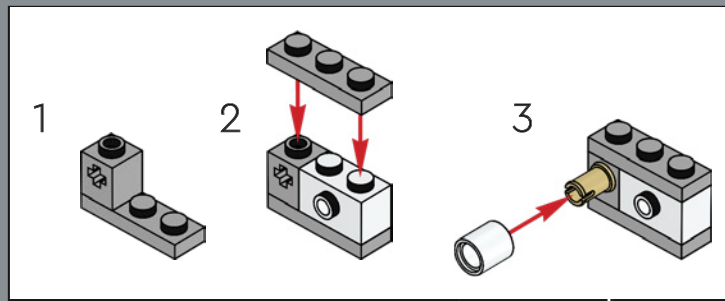
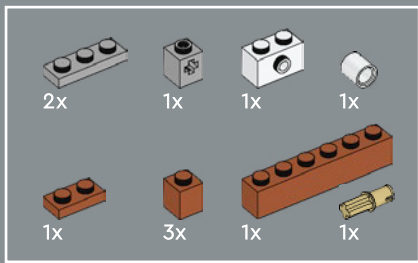

24

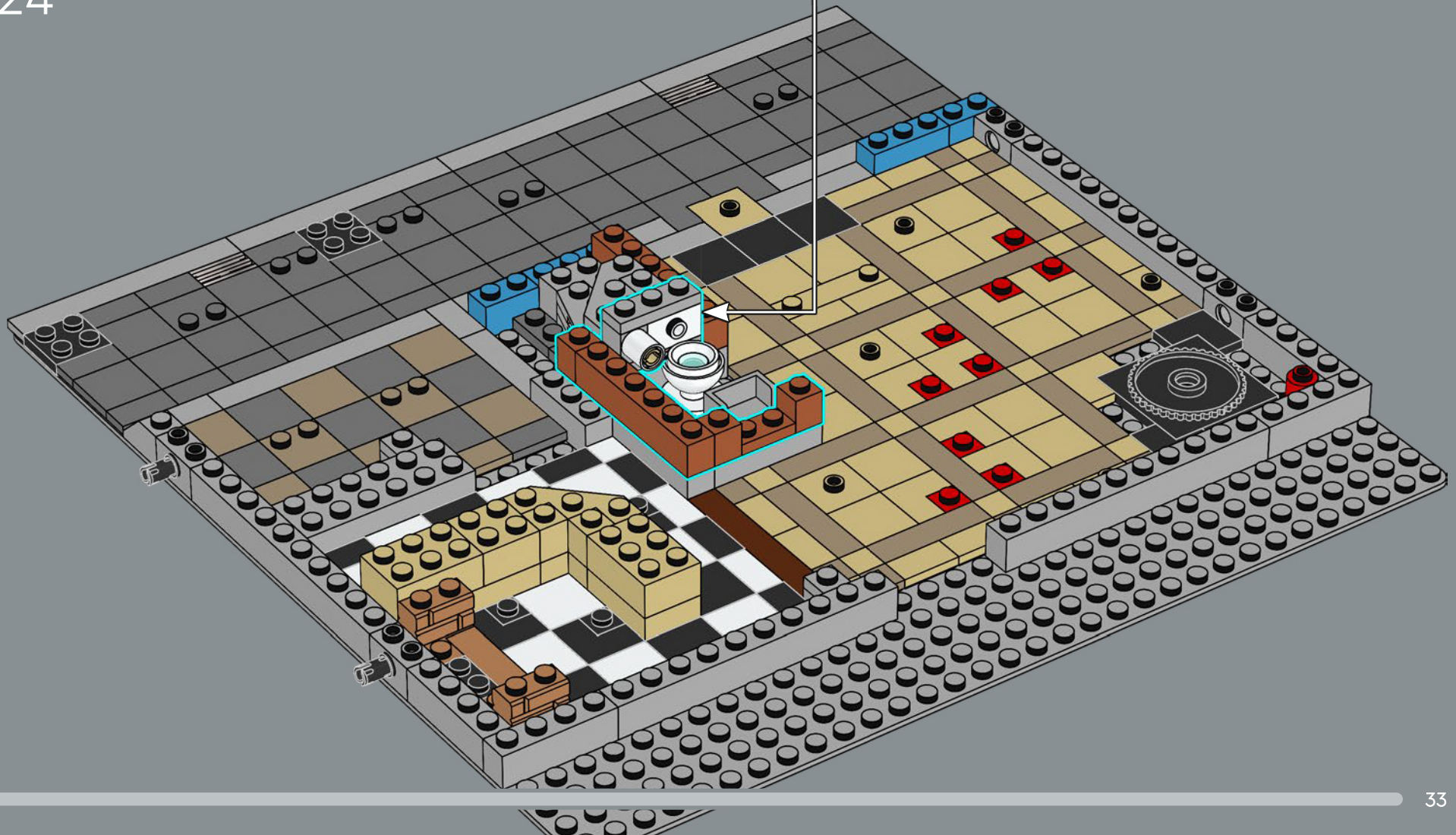

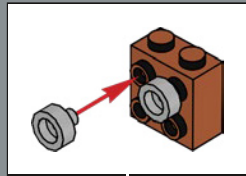
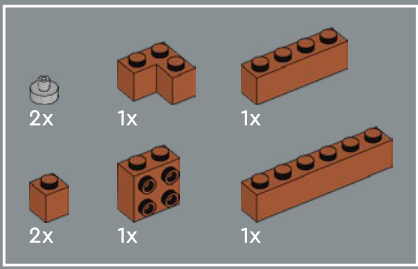

25

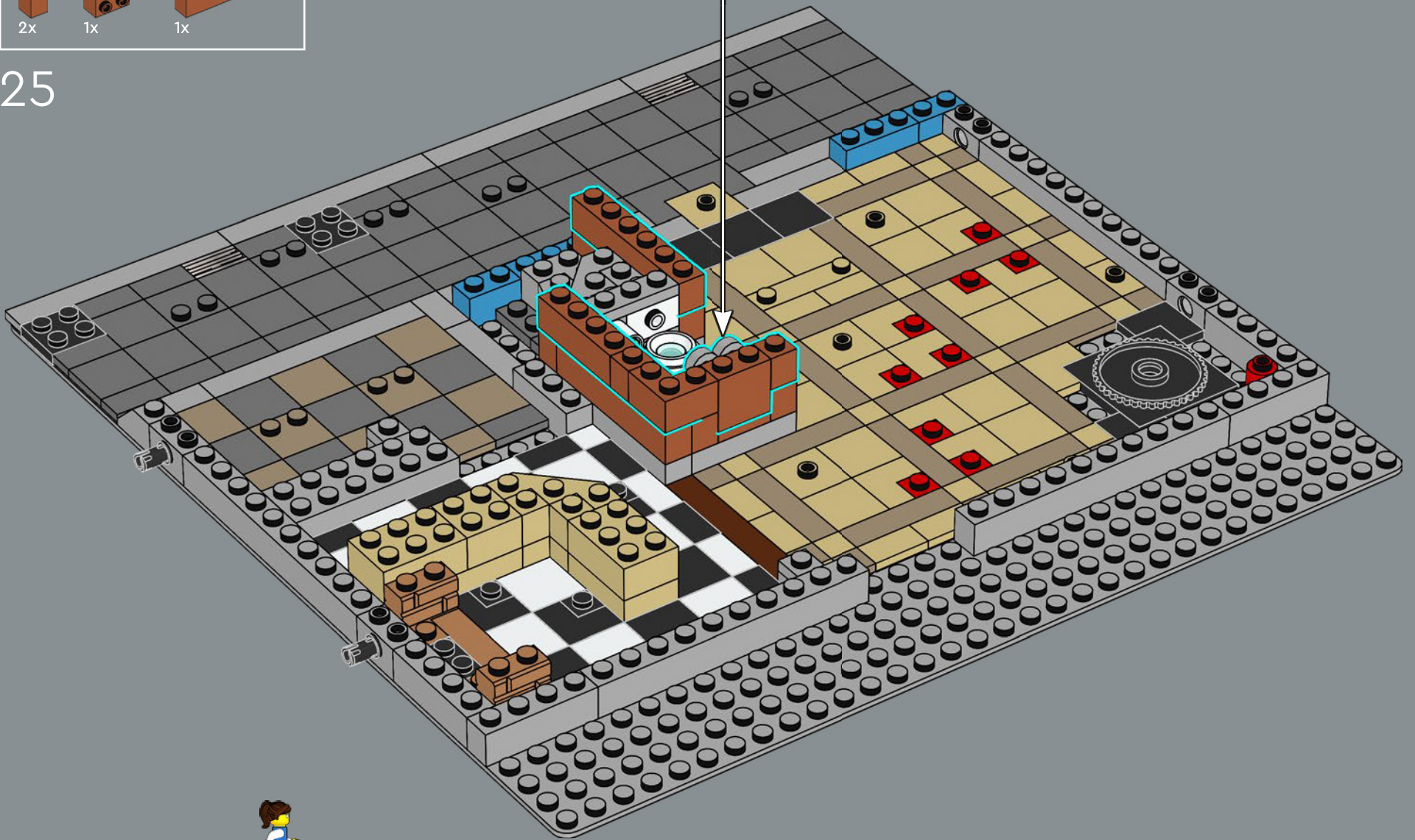

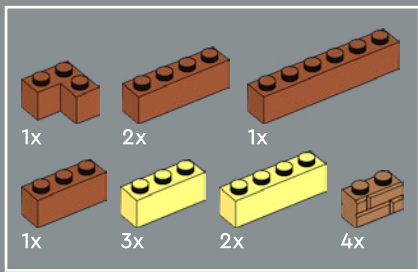

26

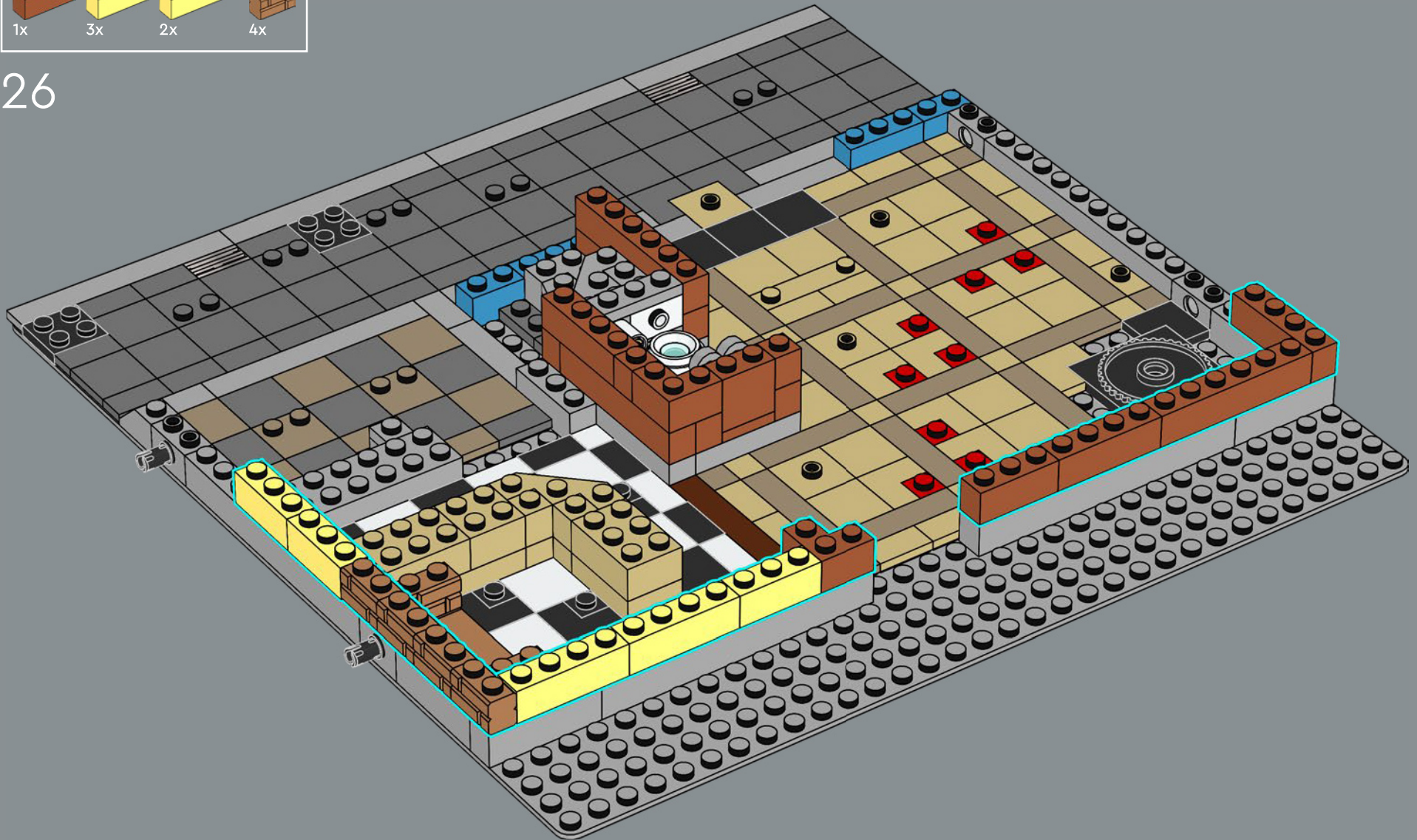

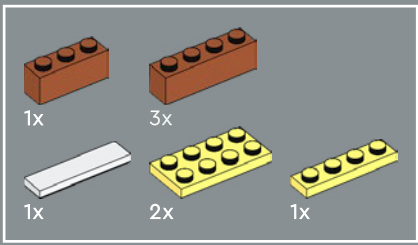

27

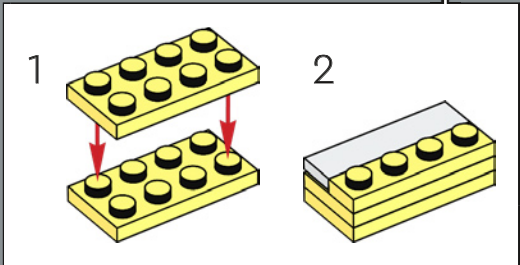
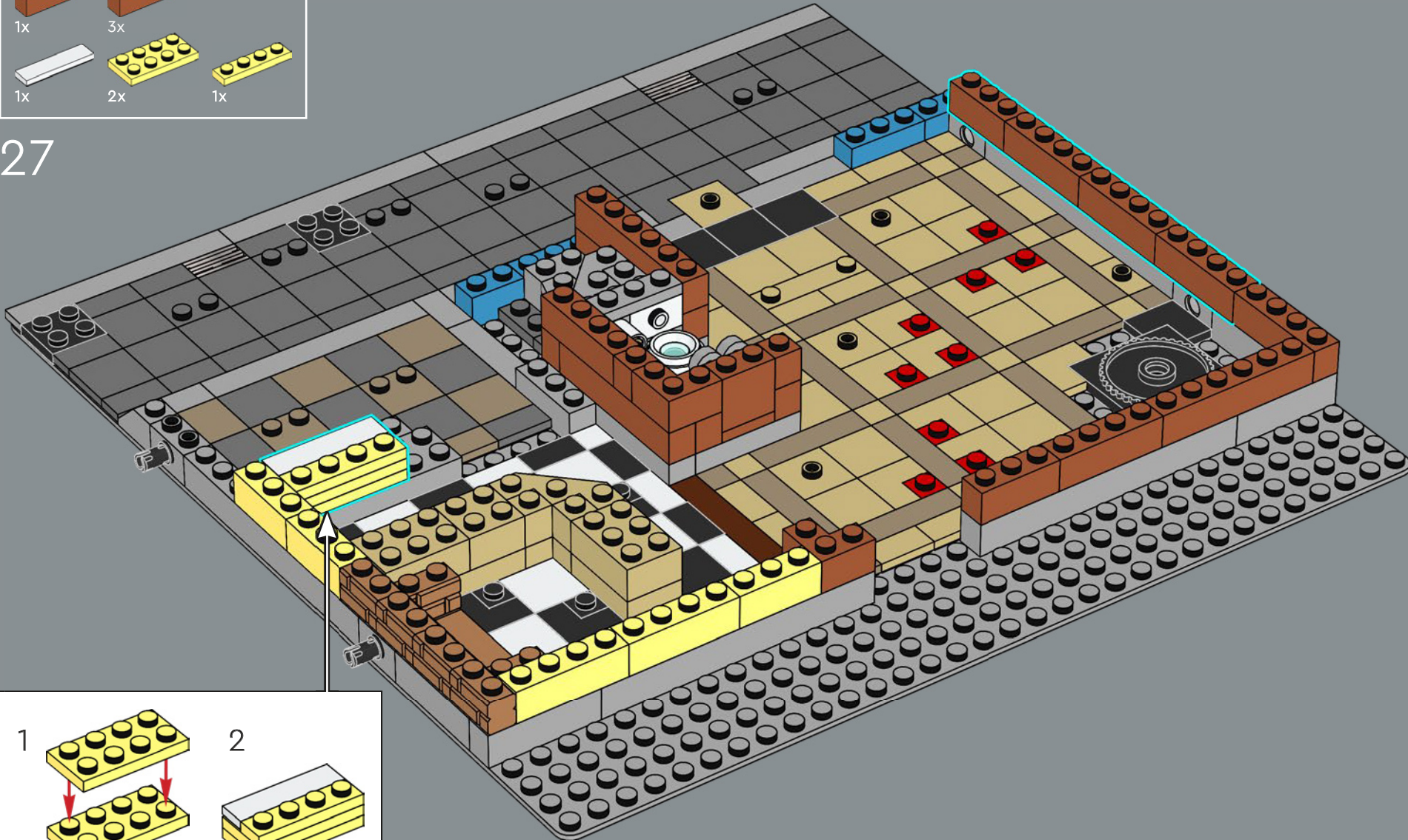

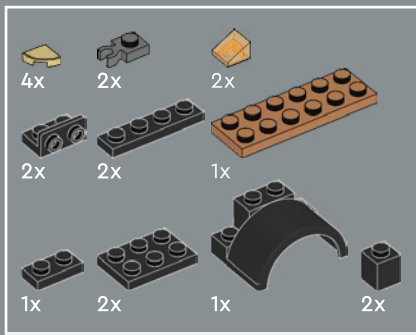

28

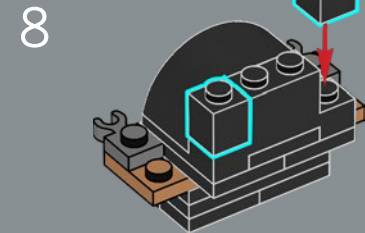
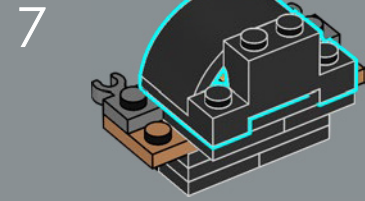
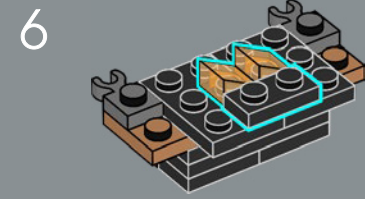
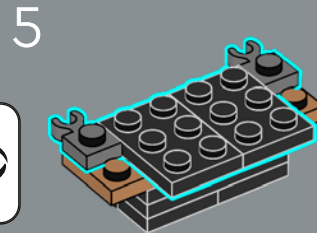
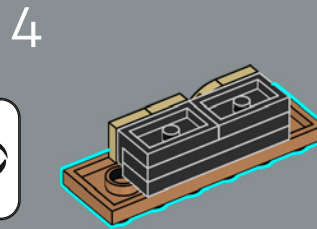
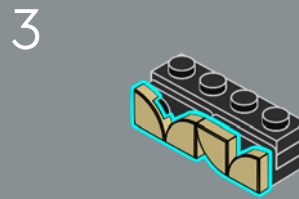
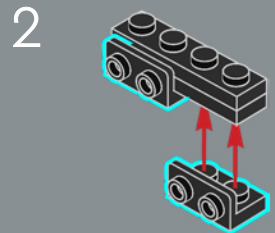
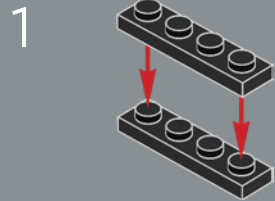

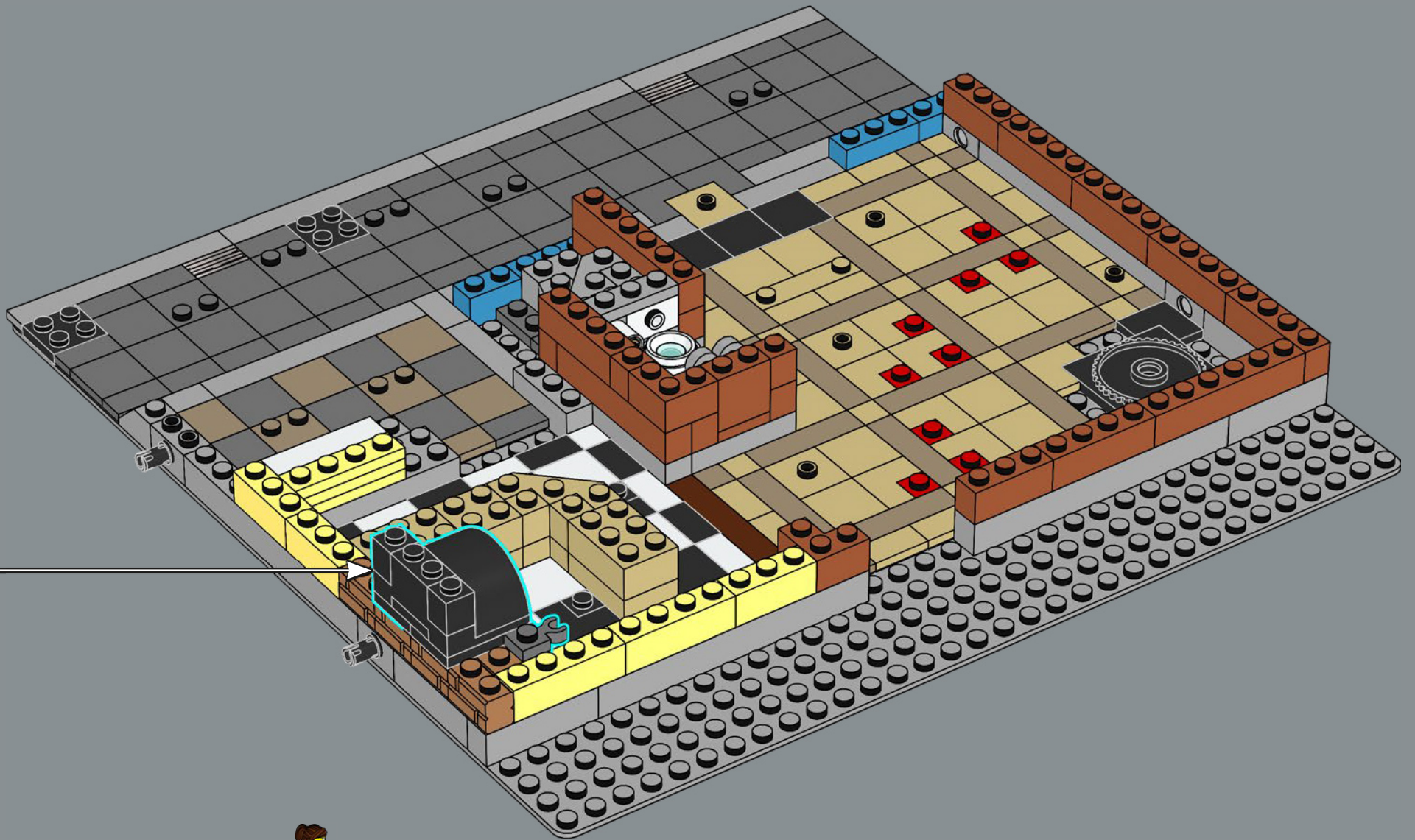

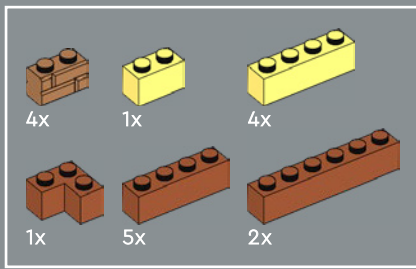

29

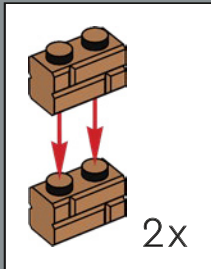
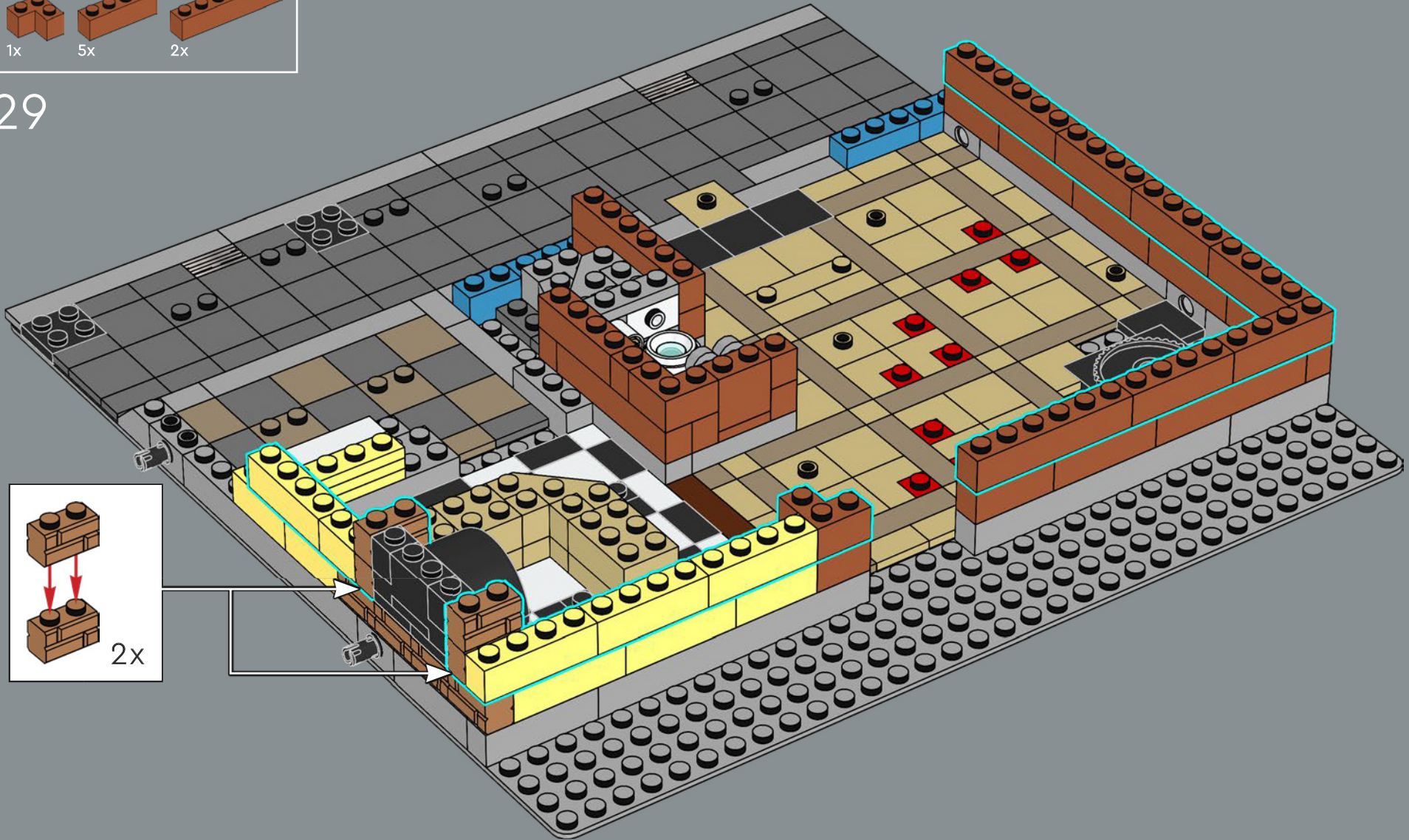

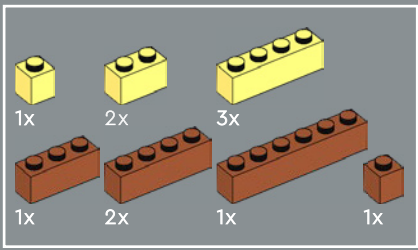

30

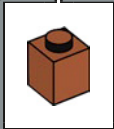
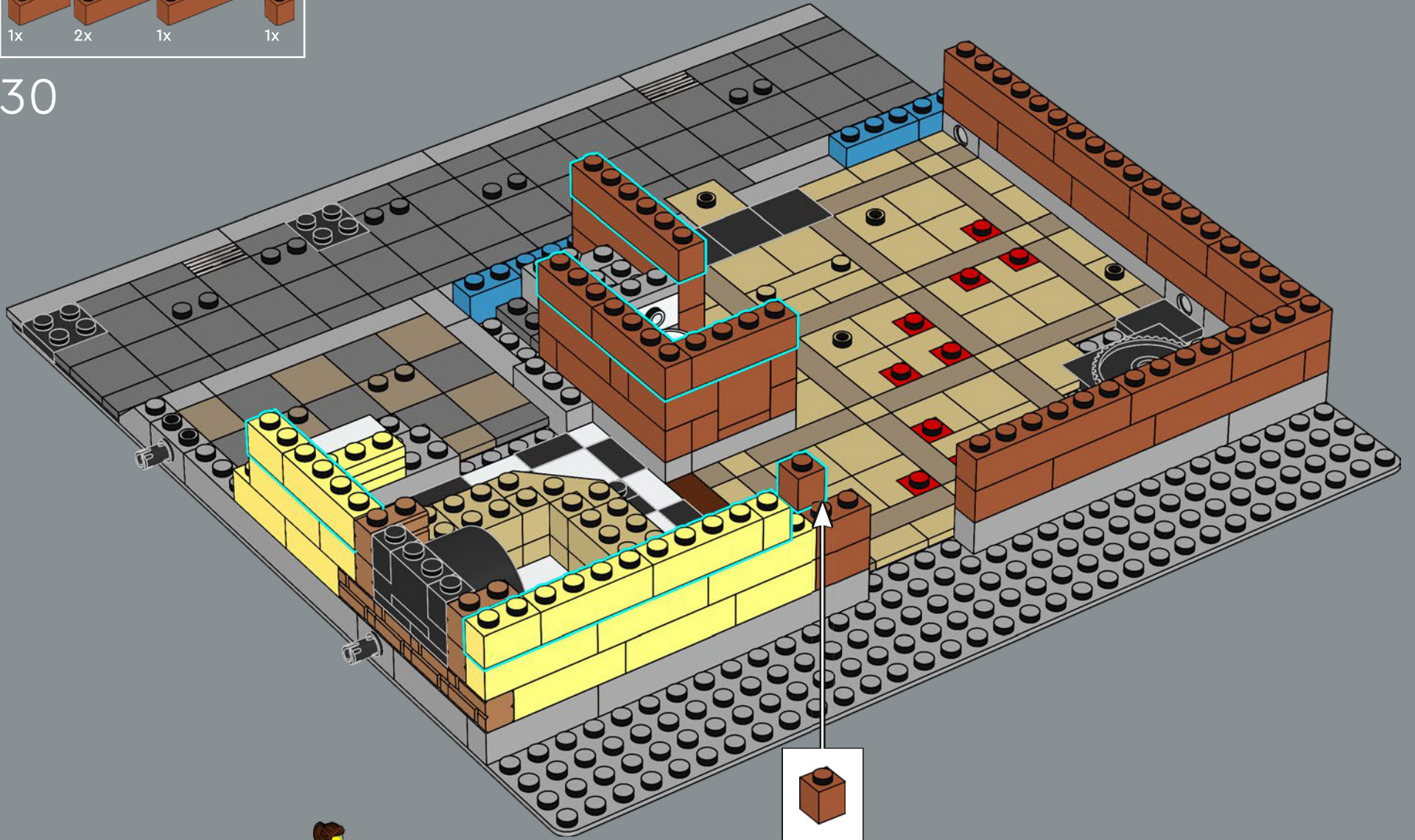

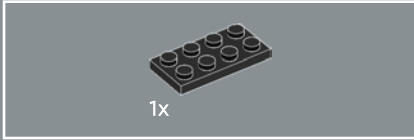

1x

31

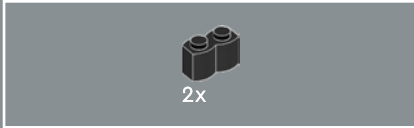
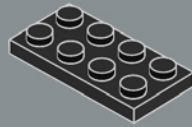

2x

32

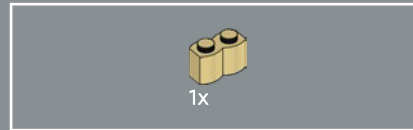
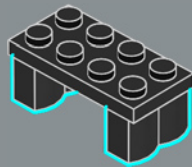

1x

33

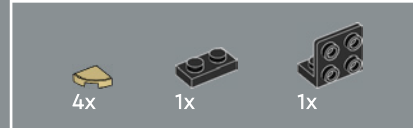
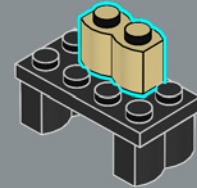

4x

1x

1x

34

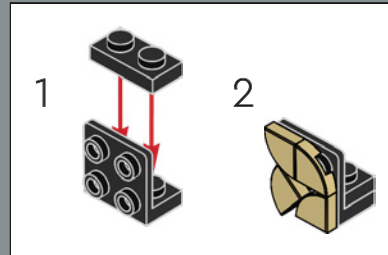

1

2

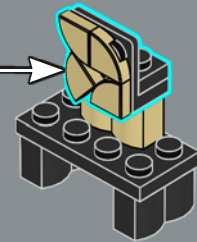

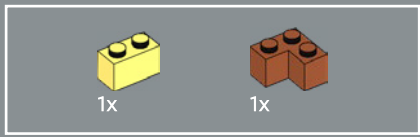

35

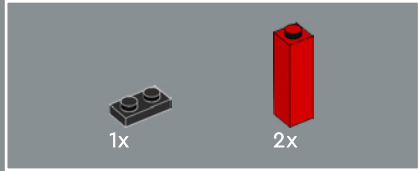
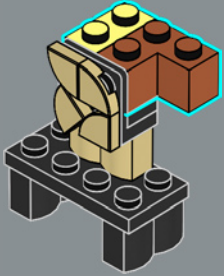

36

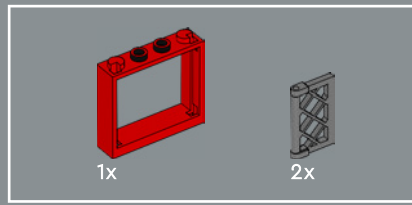
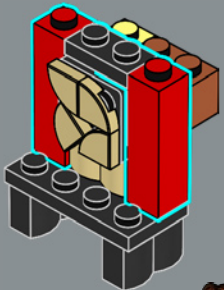

37

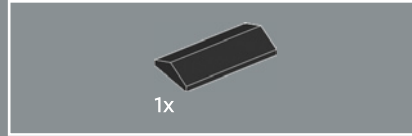
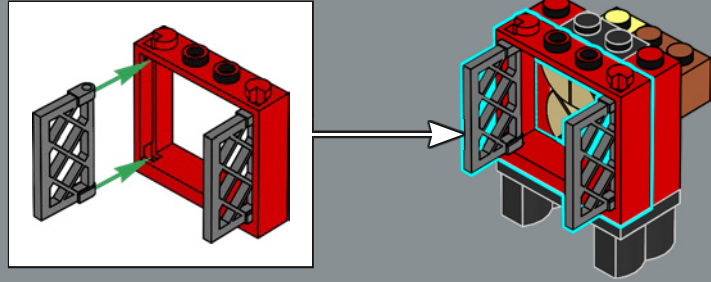

38

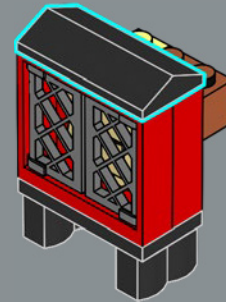



39

The wood-fired pizza oven is heated up and ready to use. You can find extra wood behind the building.

Le four à pizza au feu de bois est chaud et prêt à l'emploi. Vous pouvez trouver du bois supplémentaire derrière le bâtiment.

El horno para cocinar pizza a la leña está caliente y listo para usarse. Podrás encontrar leña adicional detrás del edificio.

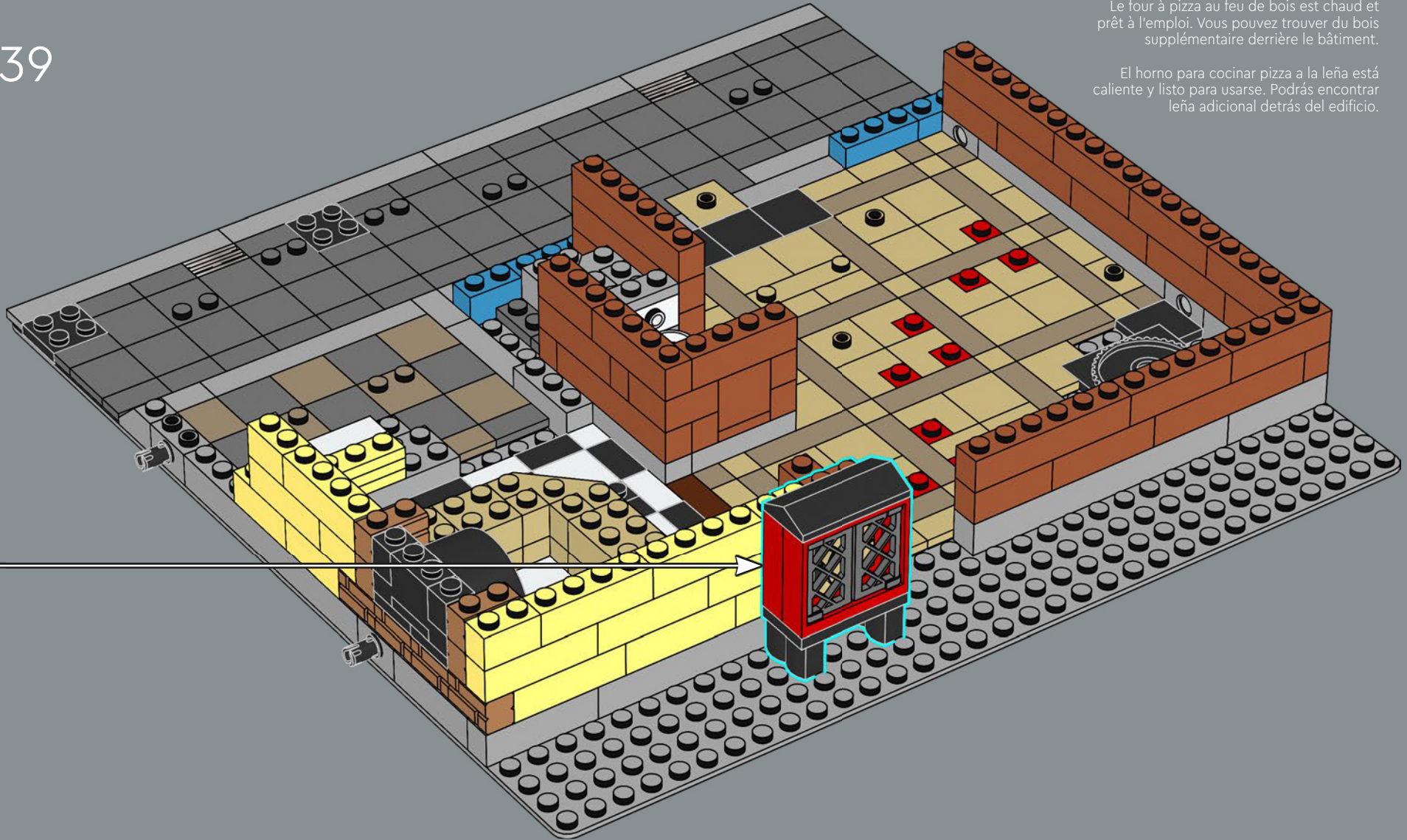

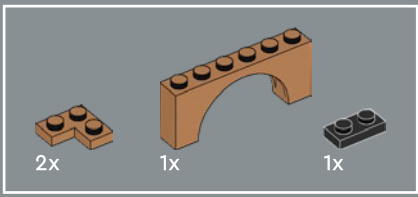

40

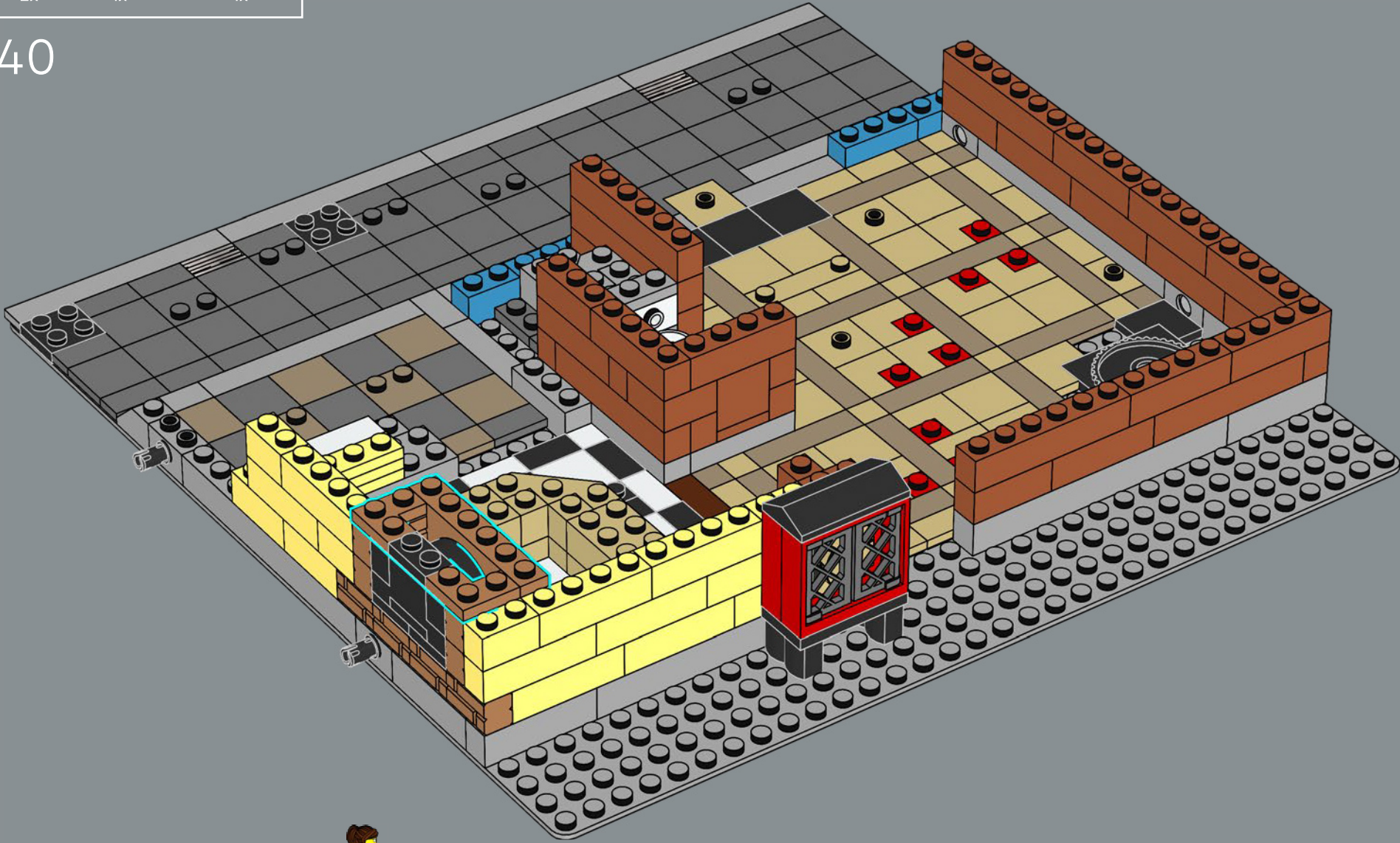

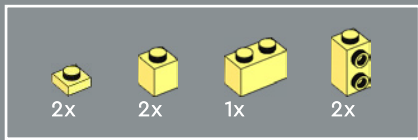

41

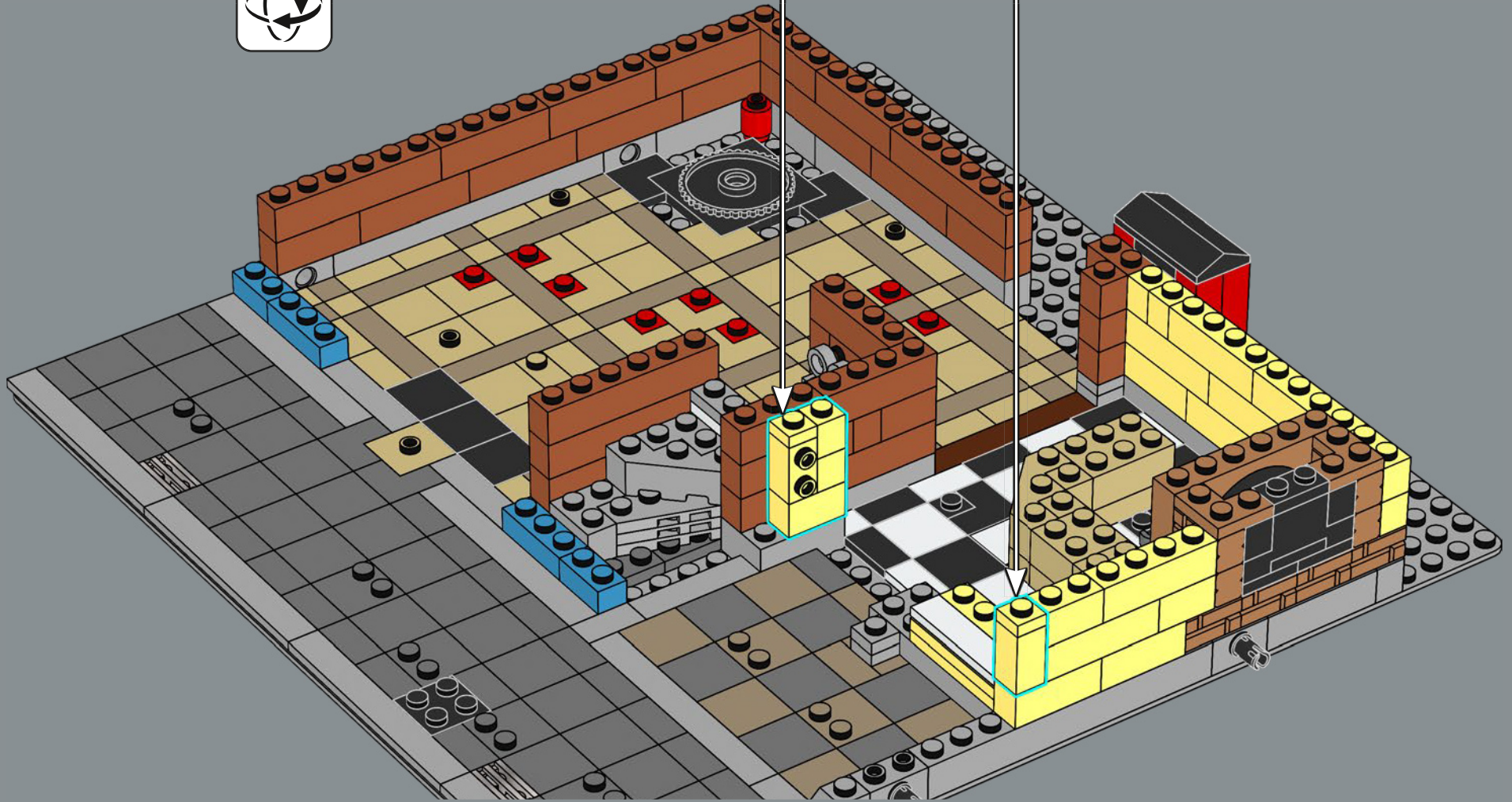
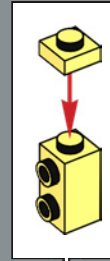
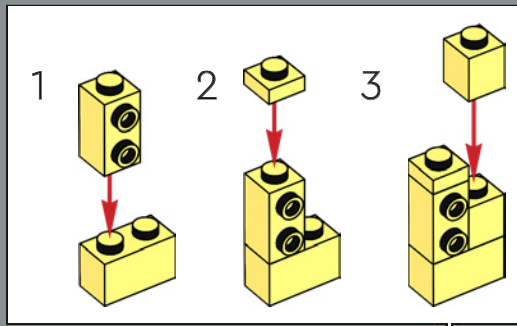

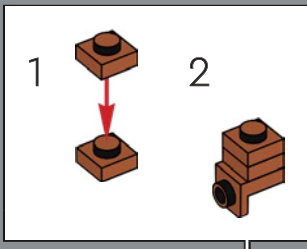
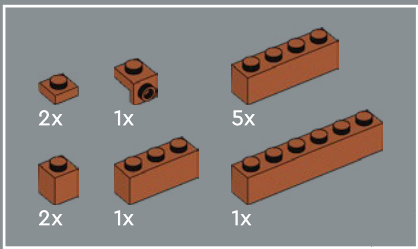

42

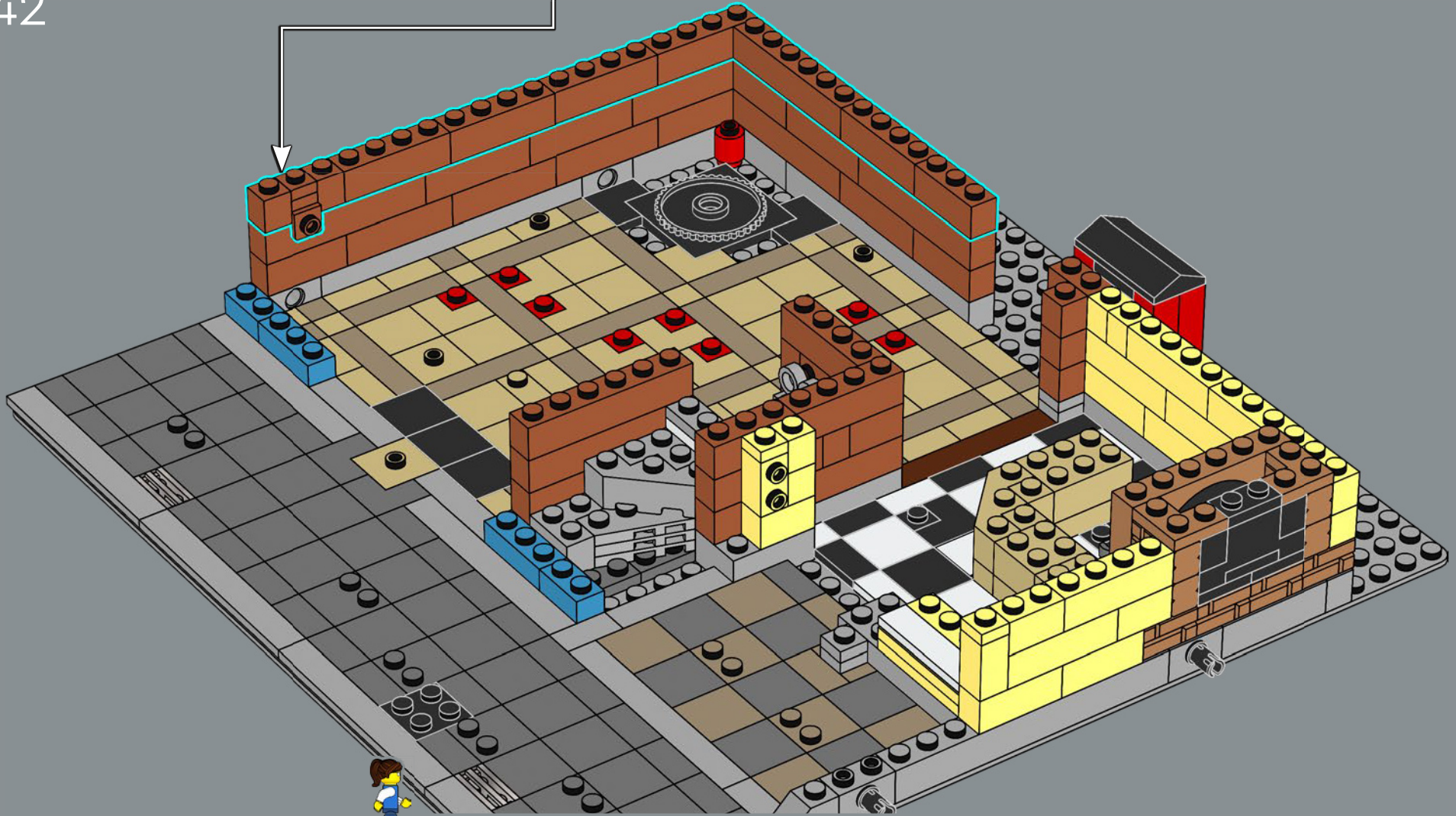

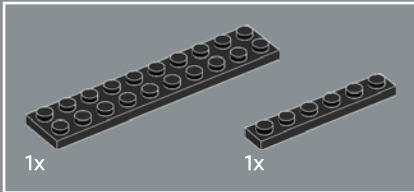
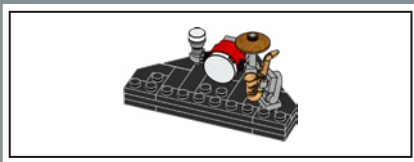

43

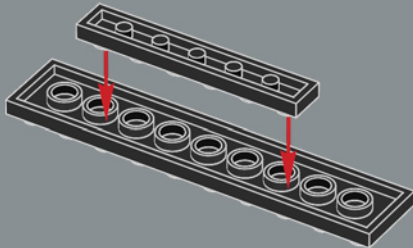

44

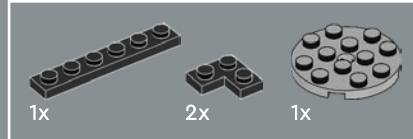
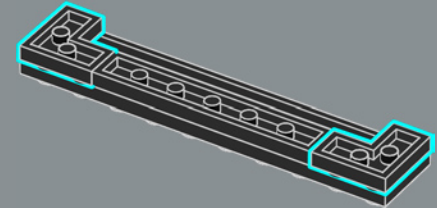

45

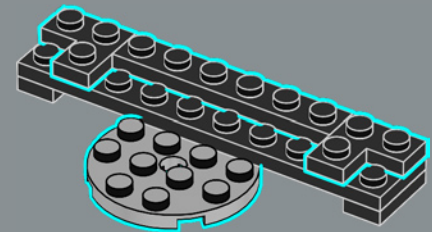



46

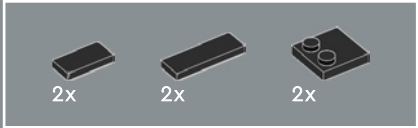
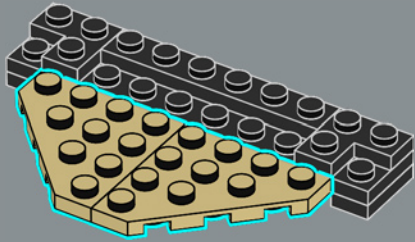

47

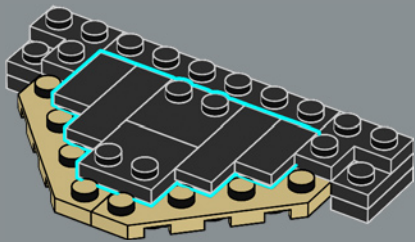

48

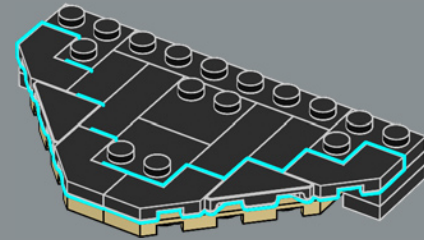

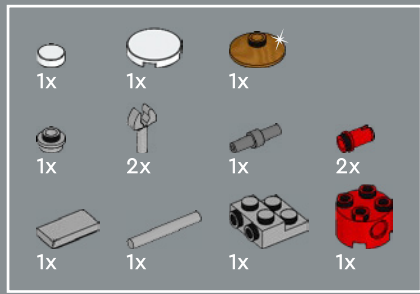

49

1

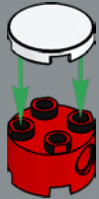

2

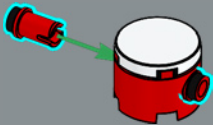

3

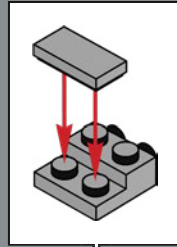

4

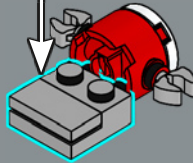

5

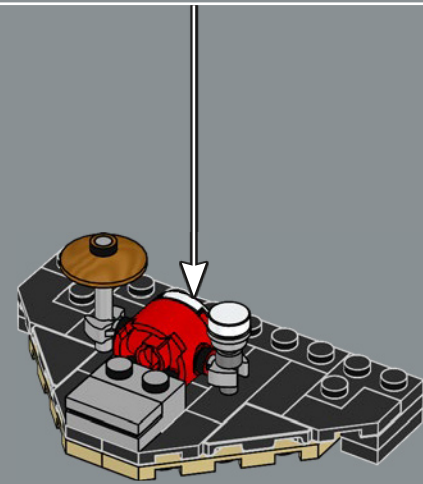
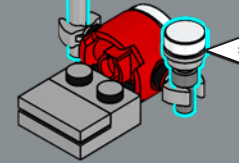
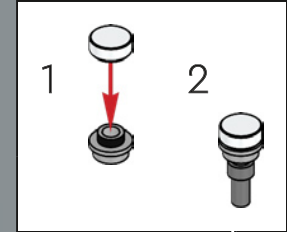
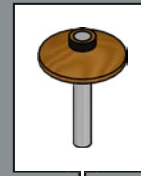



50

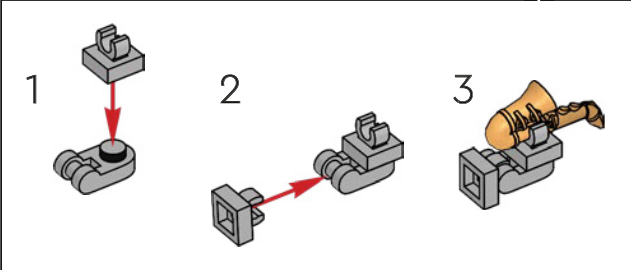
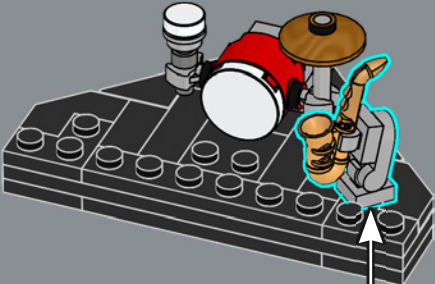

Can't you just hear the 'boom-cht' sound of the bass drum and snare, and the 'tss-t-t-tss' of the cymbal?

N'entendez-vous pas le « boum-cht » de la grosse caisse et de la caisse claire, et le « tss-t-t-tss » de la cymbale ?

¿Escuchas el "bum-cht" del bombo y la tarola, y el "tss-tss" de los platillos?



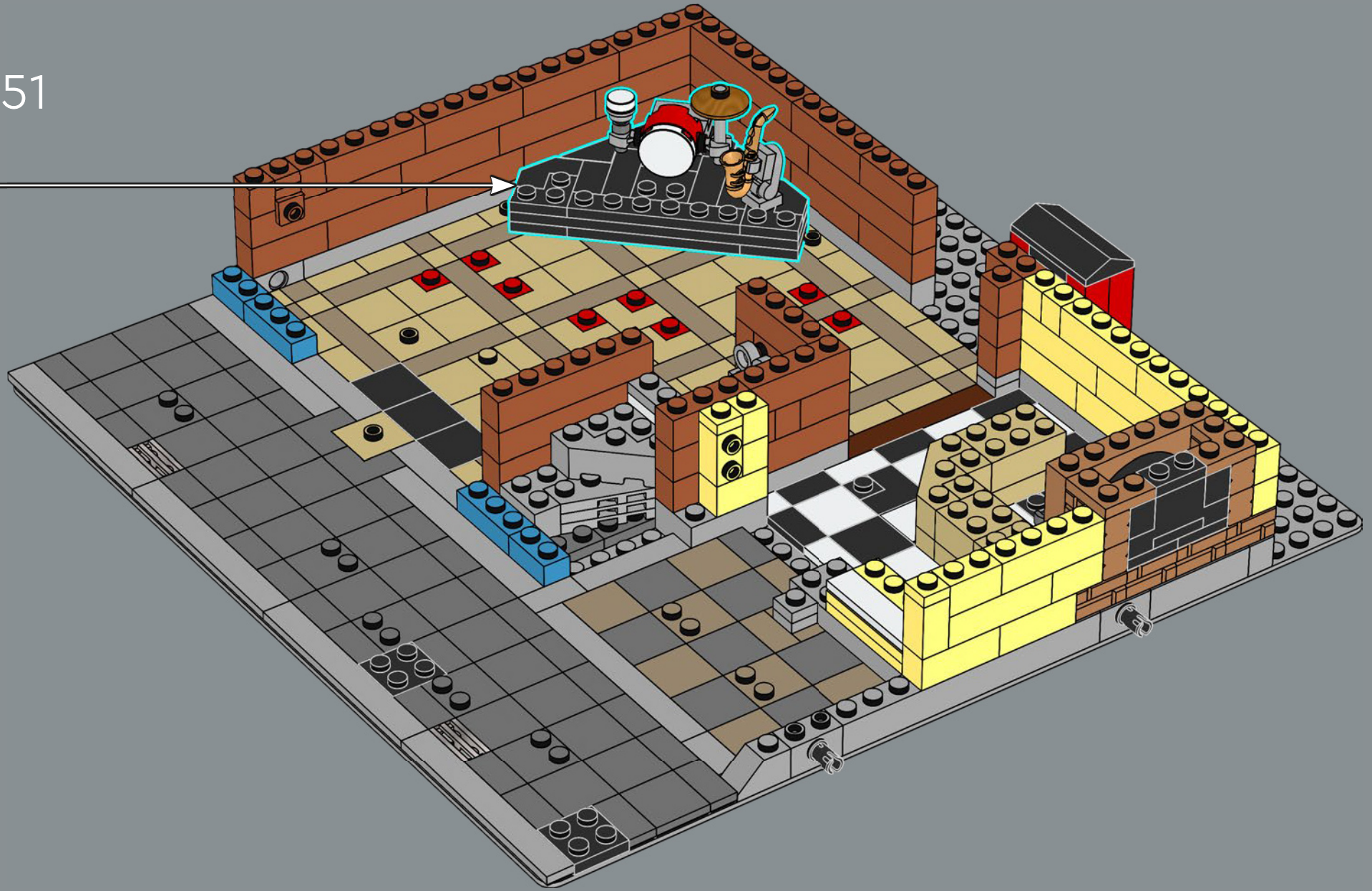



The pizza chef grows some of his own ingredients in the rooftop greenhouse. Others he purchases fresh at the LEGO® 10185 Green Grocer.

Le pizzaiolo cultive certains de ses ingrédients dans la serre sur le toit. Il achète d'autres produits frais à l'Épicerie verte LEGO® 10185.

El pizzero cultiva algunos de sus ingredientes en el invernadero de la azotea. Otros los adquiere frescos en la Tienda de Verduras LEGO® (10185).

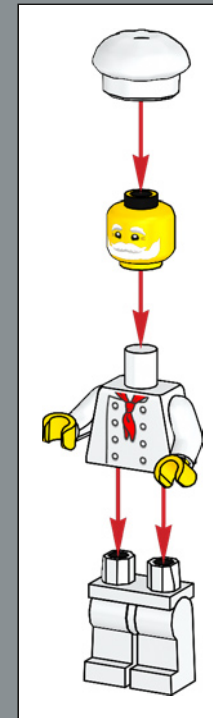

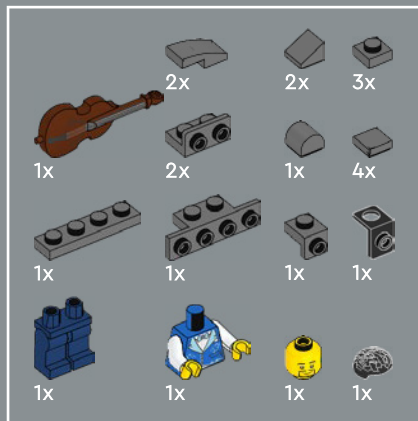

Tonight, the bass player plays his debut performance. He's been practicing very hard when he's not working at the LEGO® 10232 Palace Cinema.

Ce soir, le contrebassiste fait ses débuts sur scène. Il a beaucoup répété en dehors de son travail au Palace Cinema LEGO® 10232.

Esta noche es muy especial porque tendrá lugar la primera actuación del contrabajista. El tiempo que le queda después de trabajar en el Palace Cinema LEGO® (10232) lo ha estado dedicando a practicar muy duro.

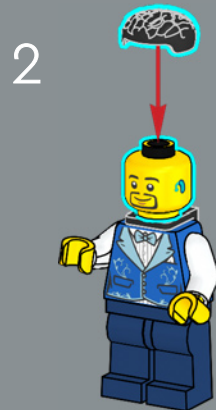
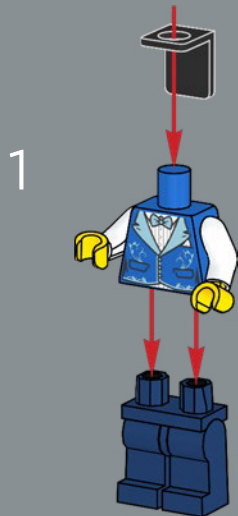
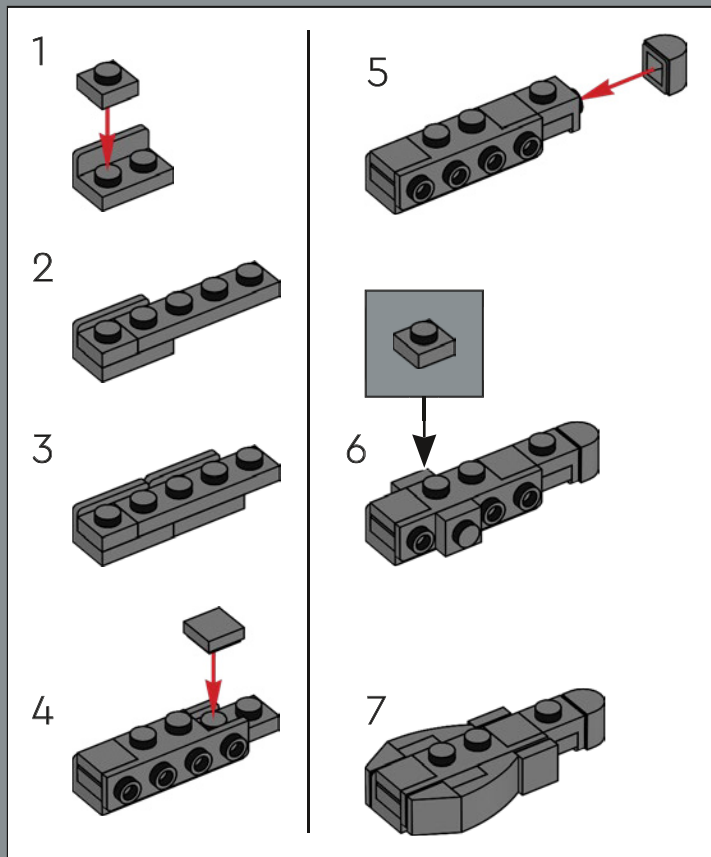



52

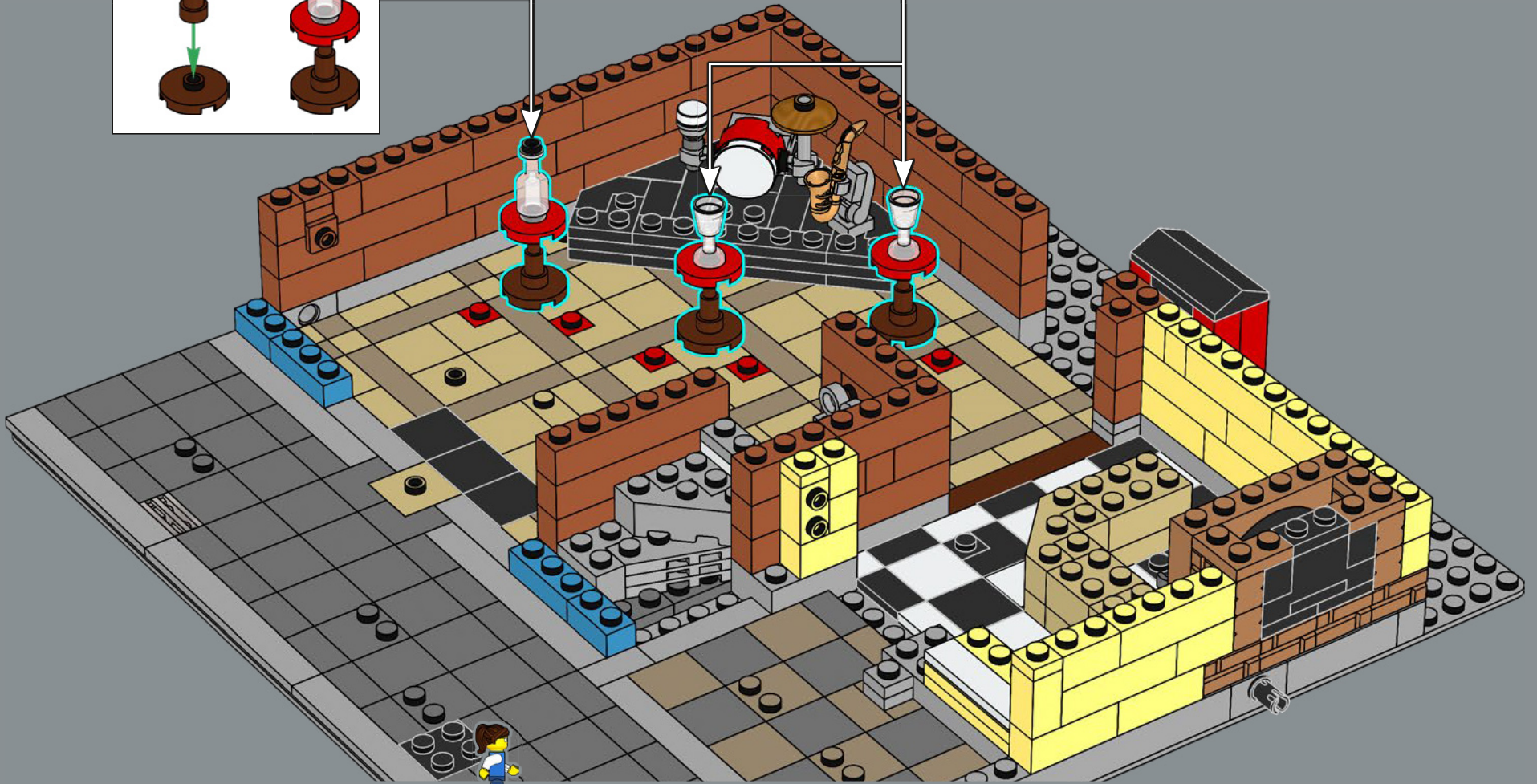
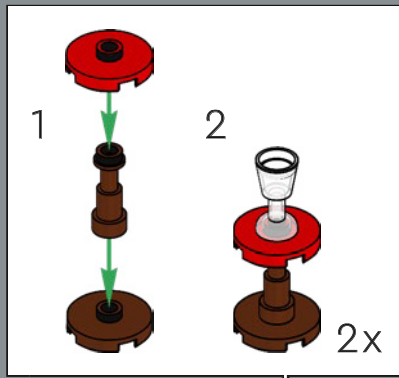
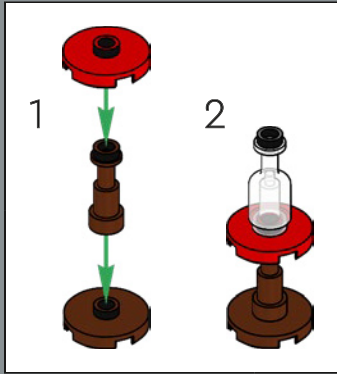



53

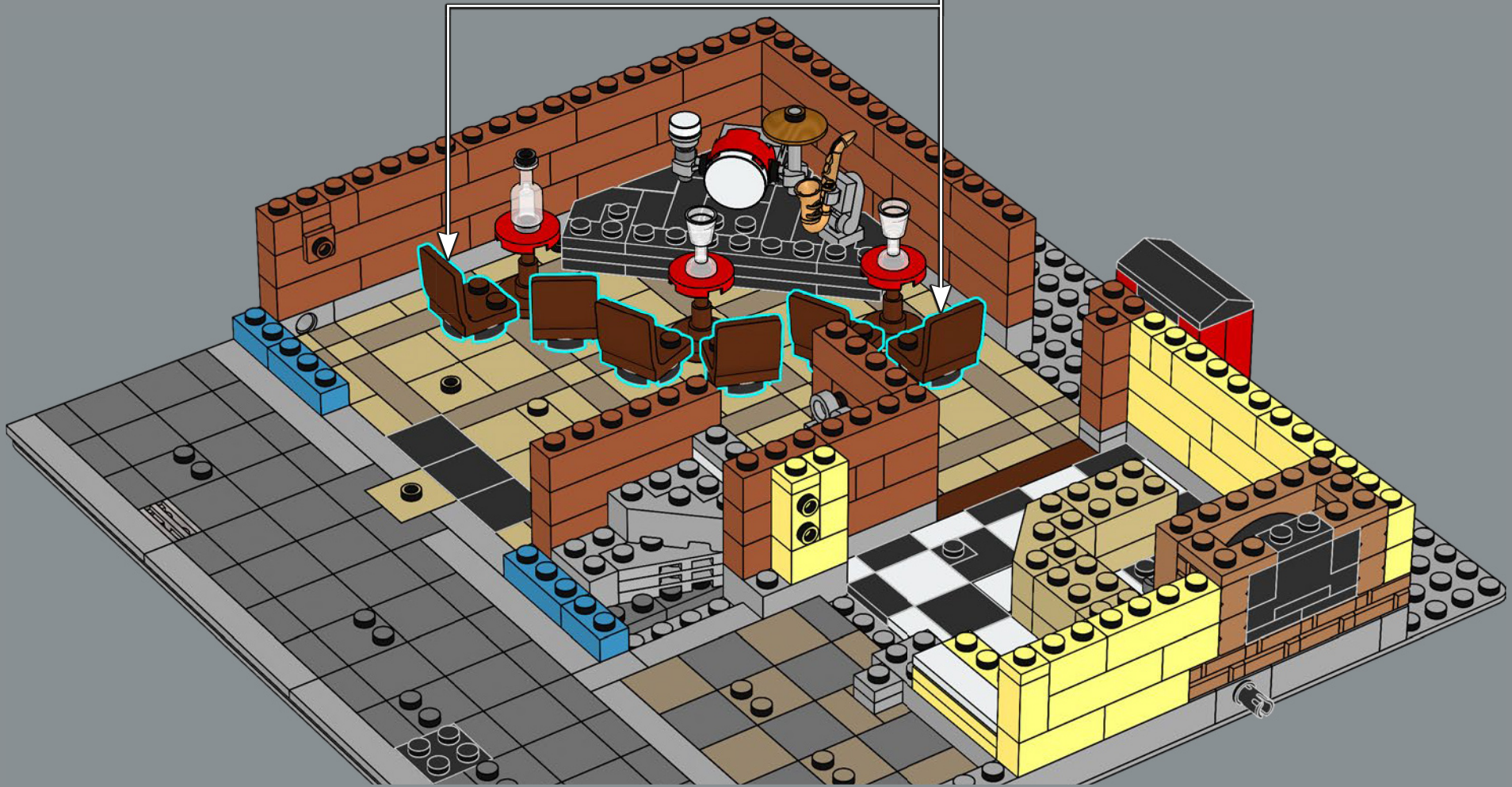
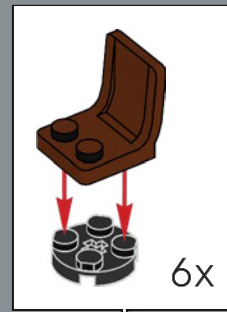

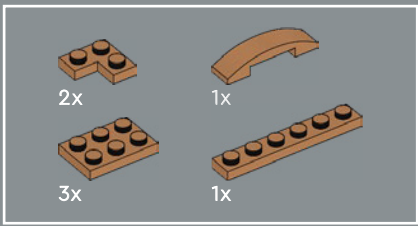

54

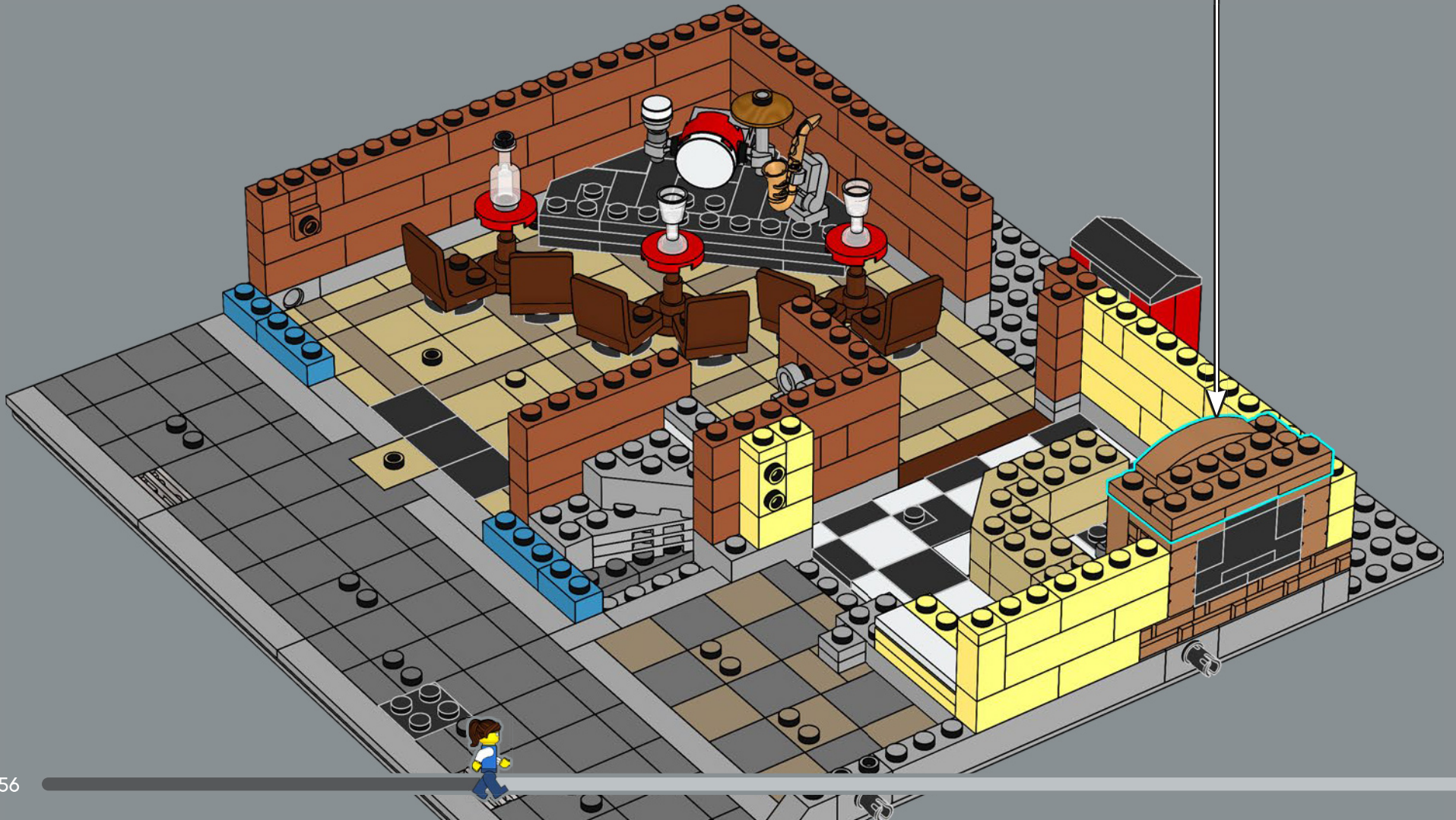
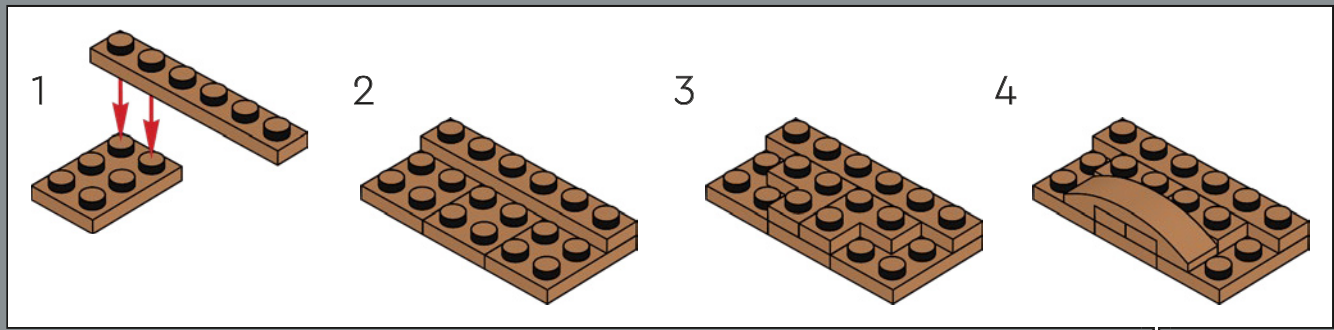

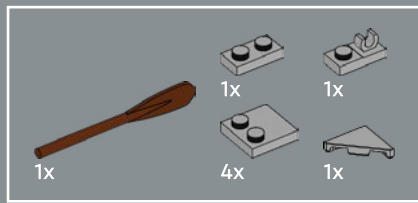

55

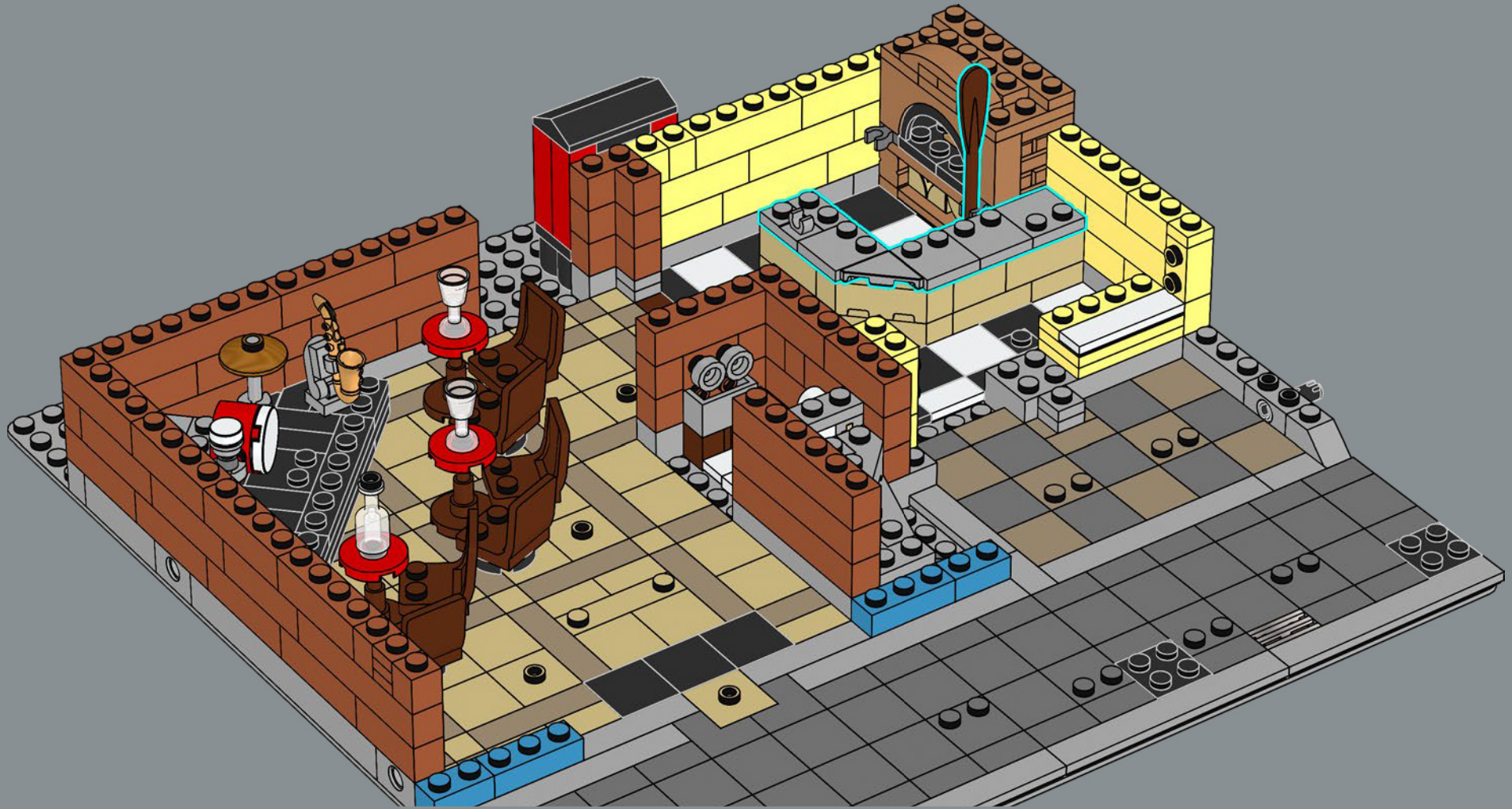

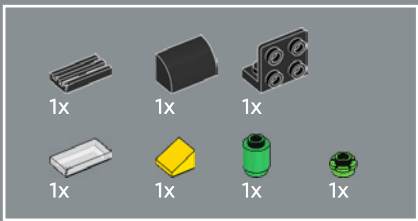

56

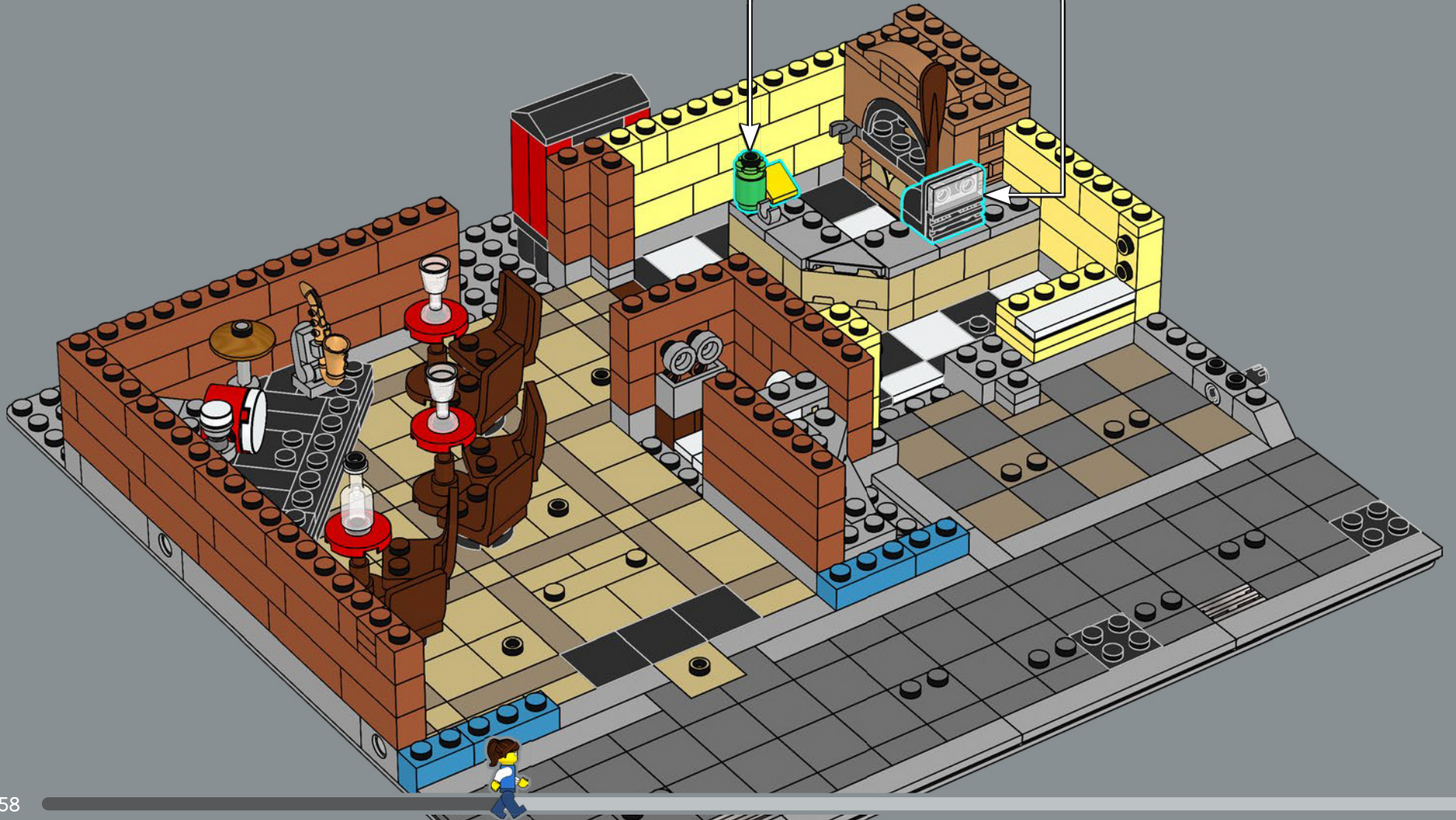
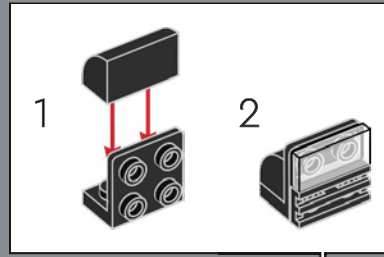
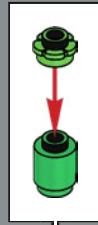

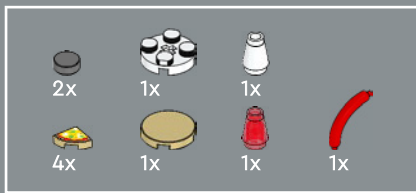

57



One delicious margherita pizza coming right up!
Customers can enjoy the whole pie or buy it by the slice.

Une délicieuse pizza Margherita arrive tout de suite ! Les clients peuvent déguster une pizza entière ou l'acheter à la pointe.

¡Una deliciosa pizza margarita está por salir del horno!
Los clientes pueden disfrutarla completa o comprar solo una rebanada.

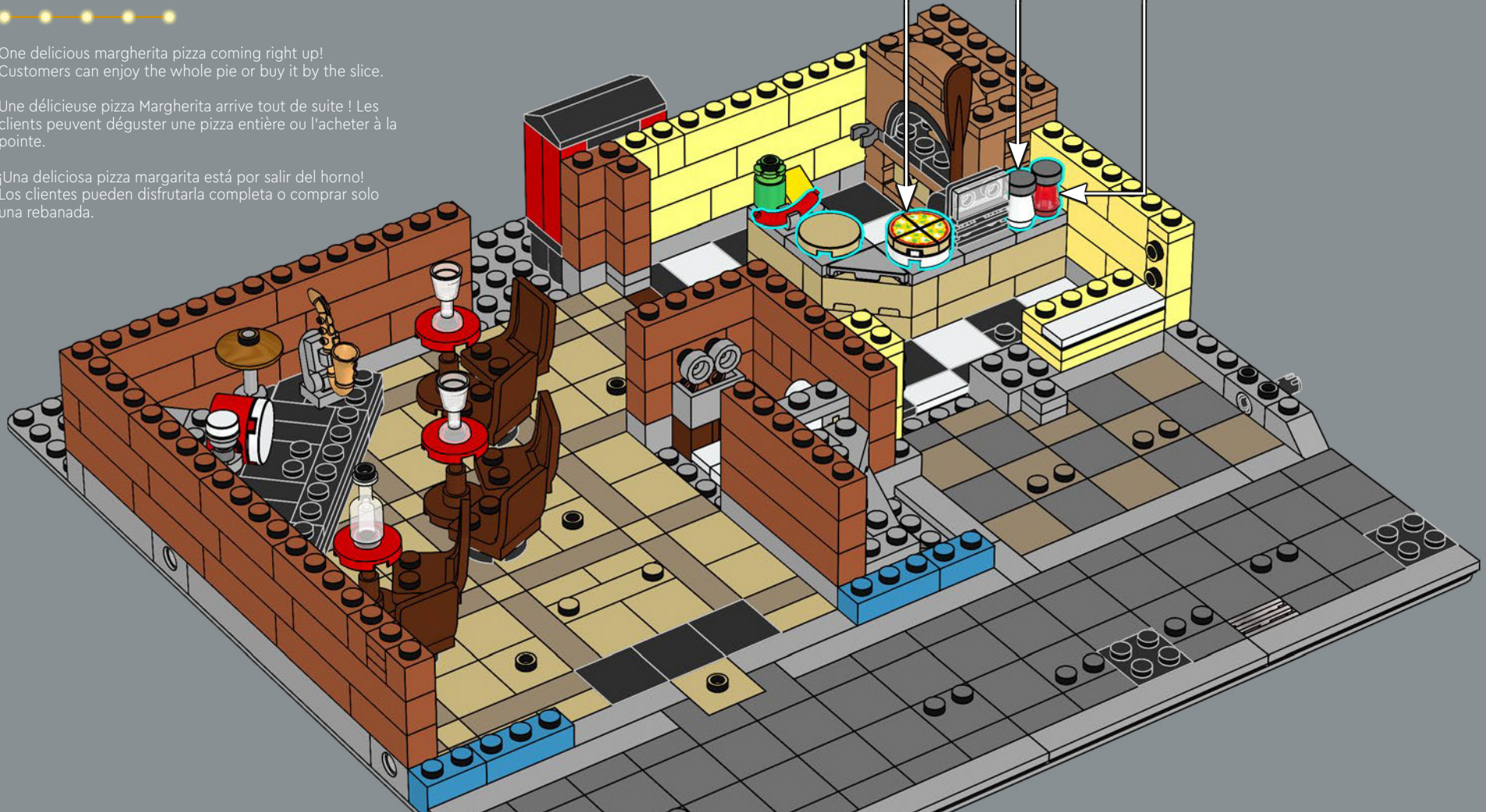

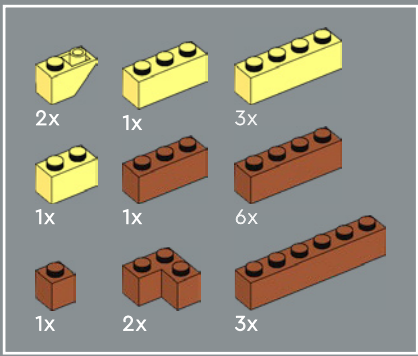

58

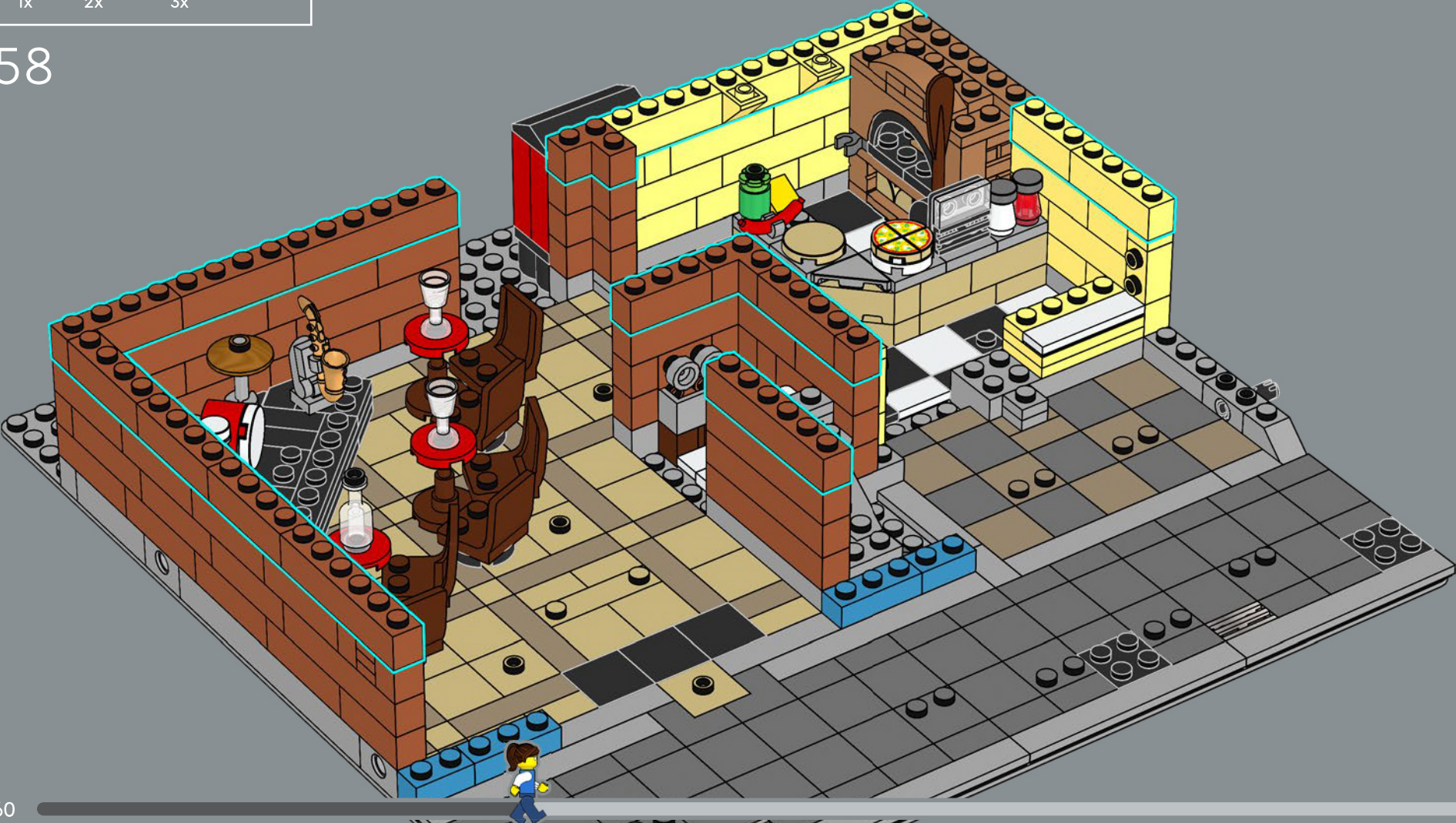

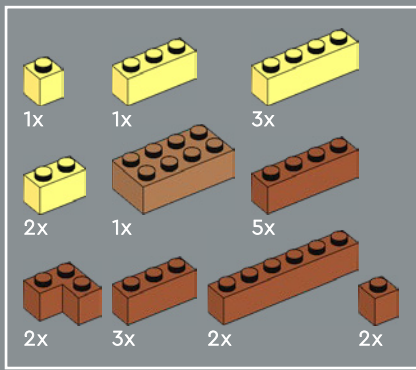

59

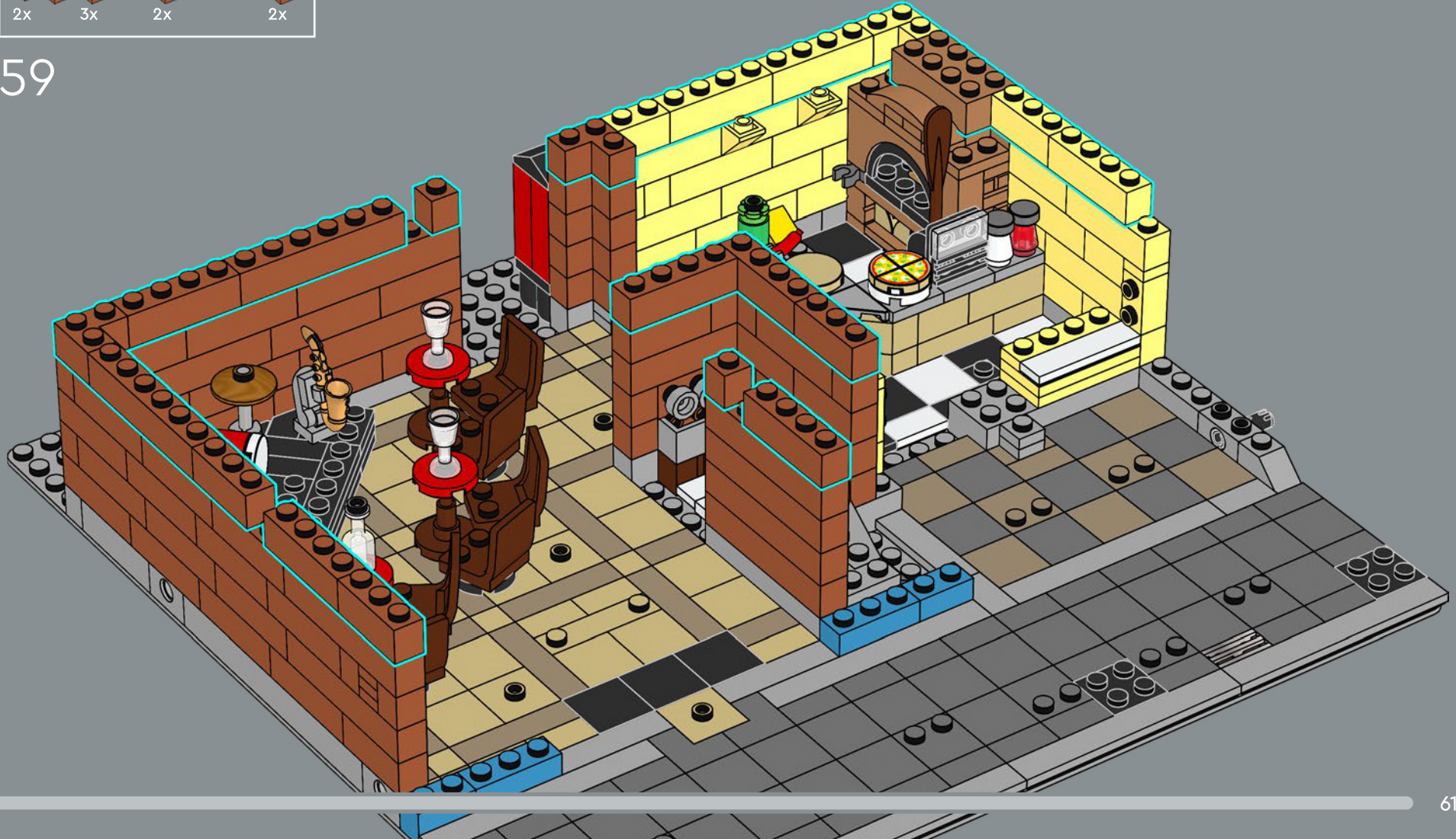

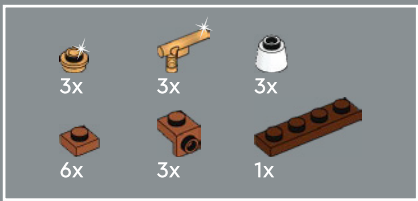

60

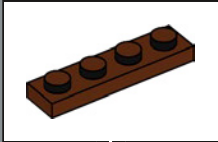
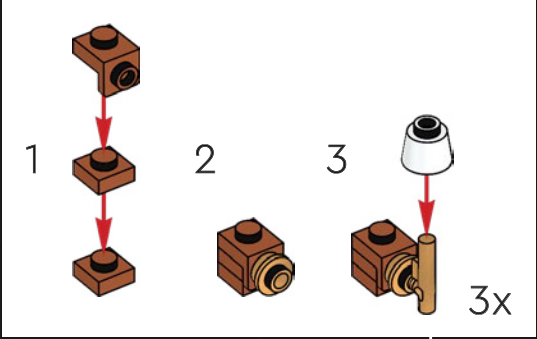

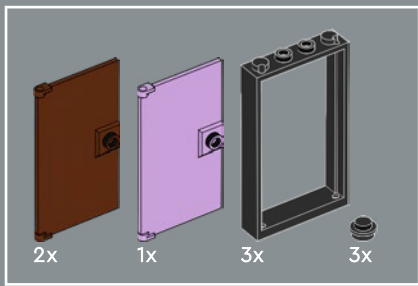

61

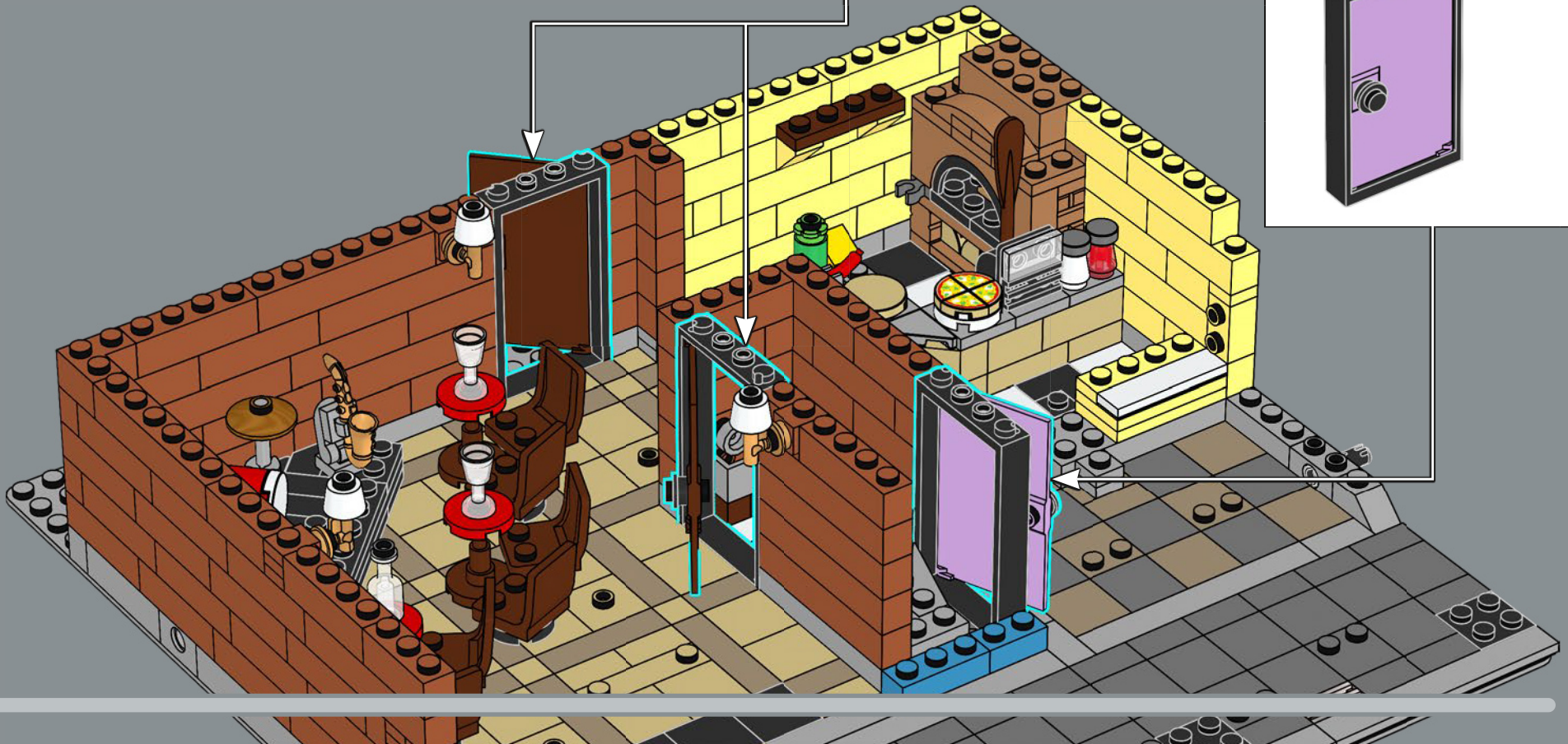
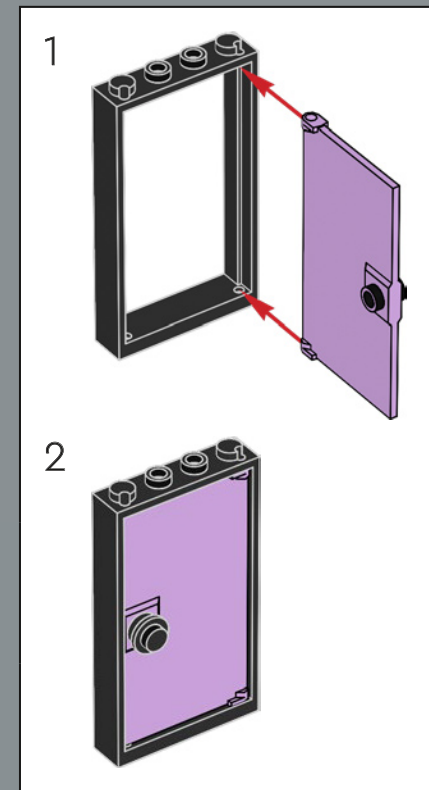
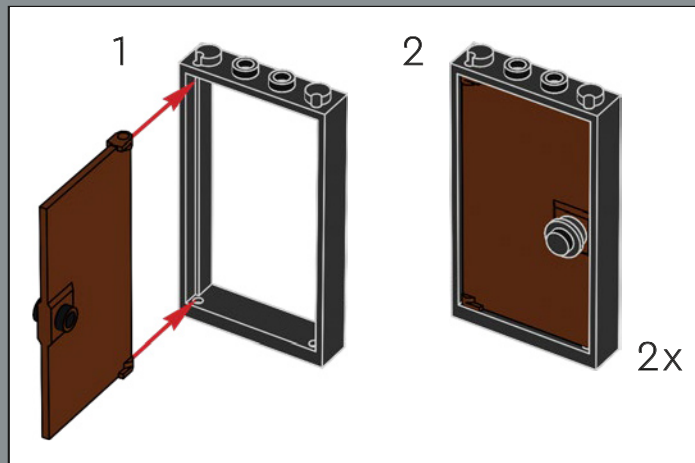

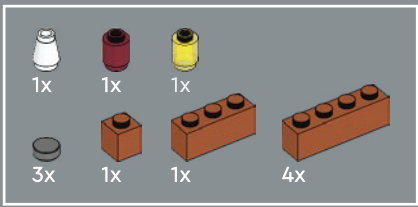

62

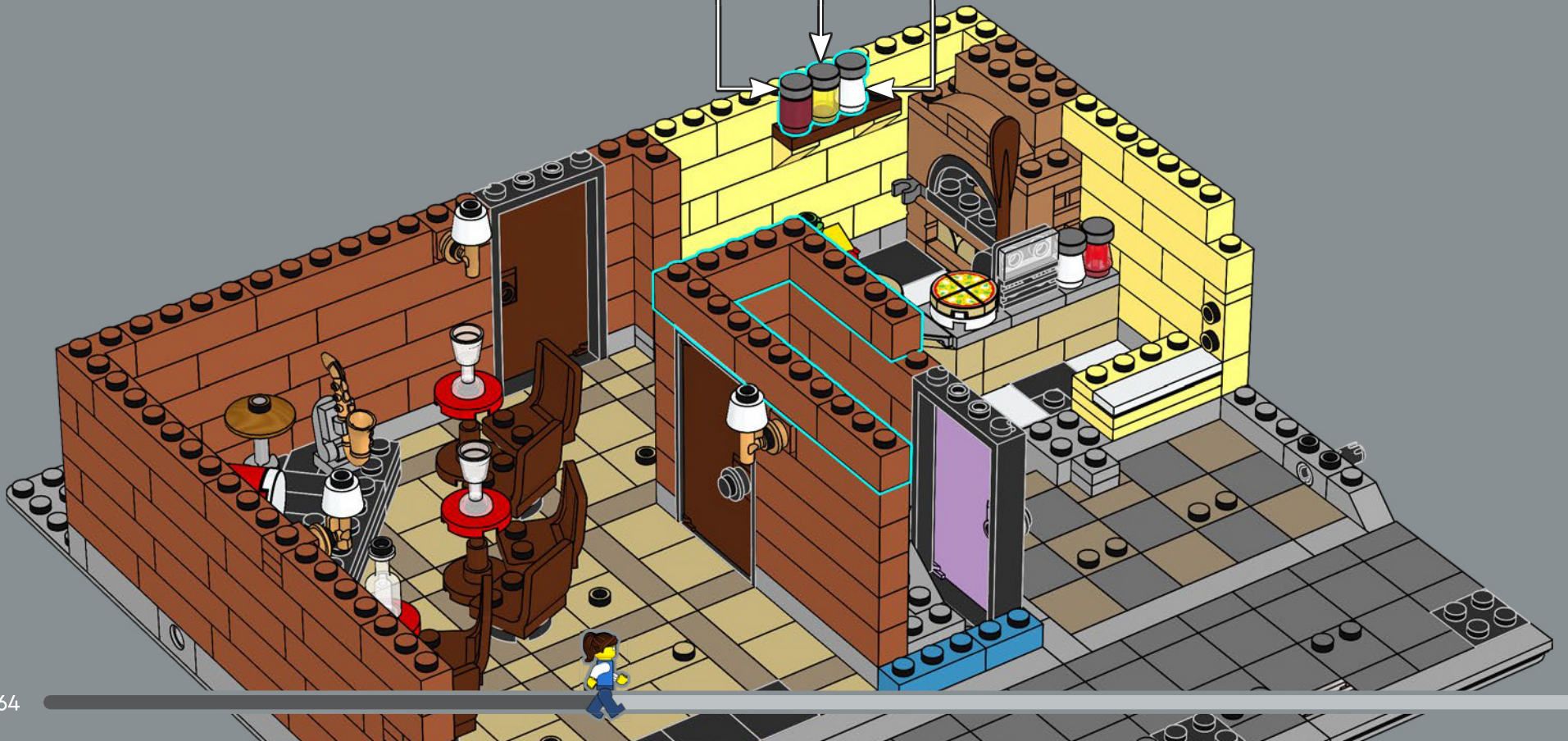
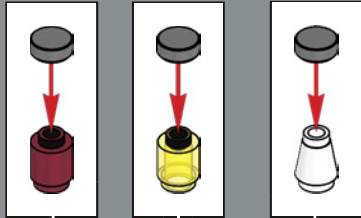

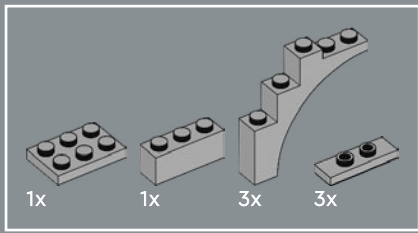

63

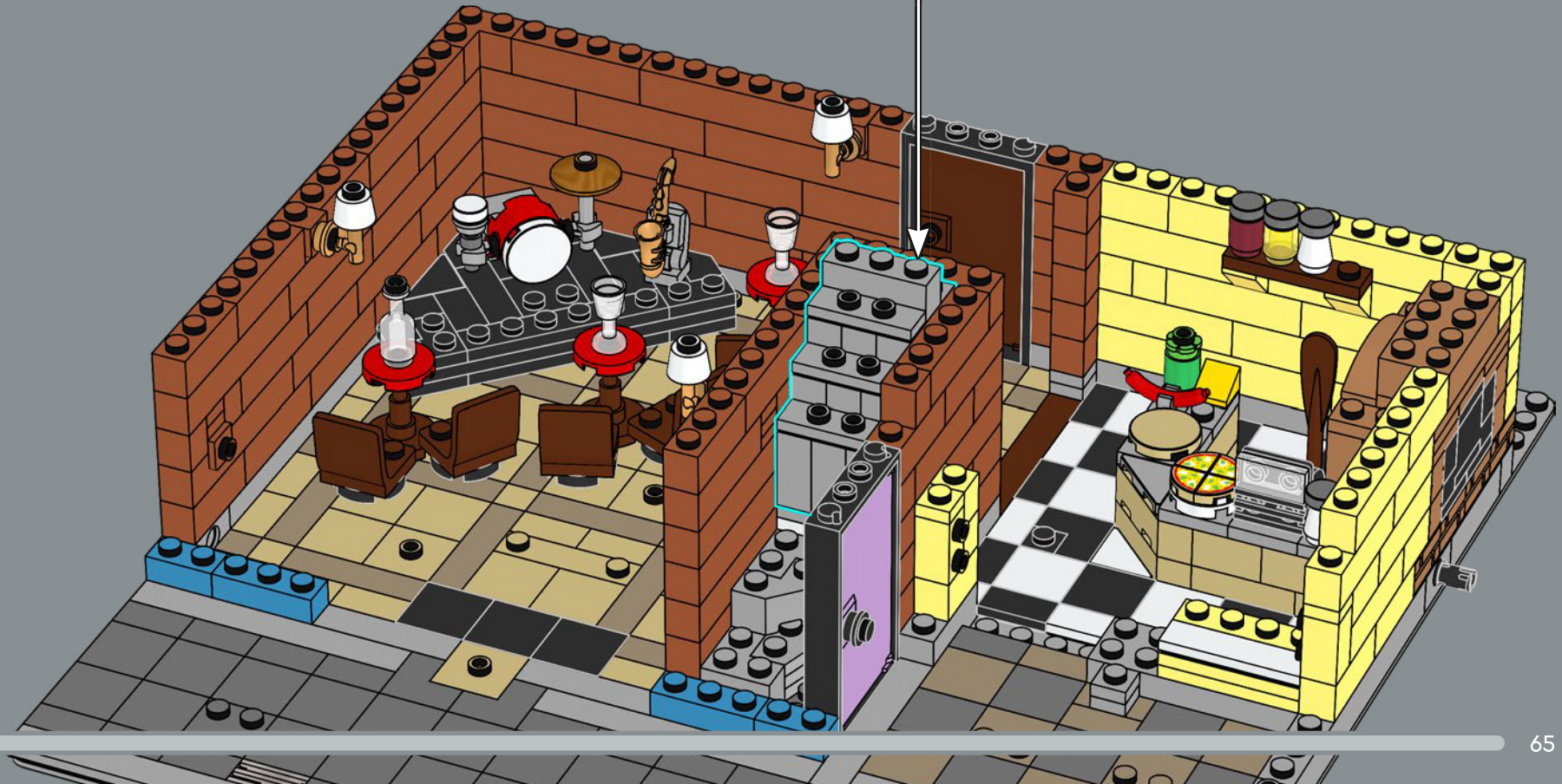
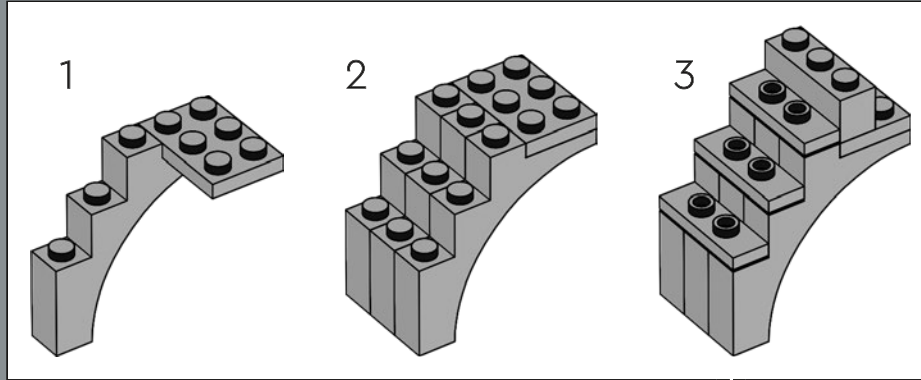

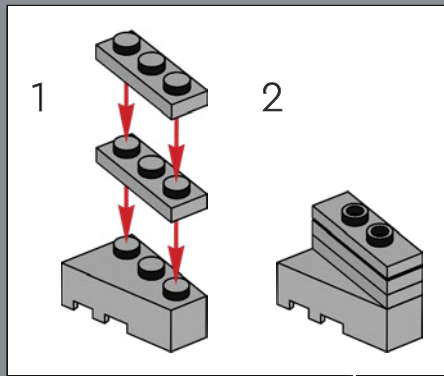
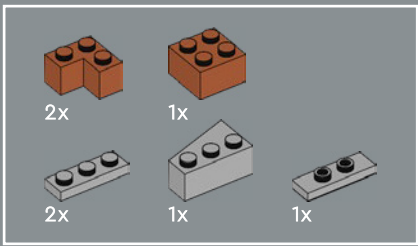

64

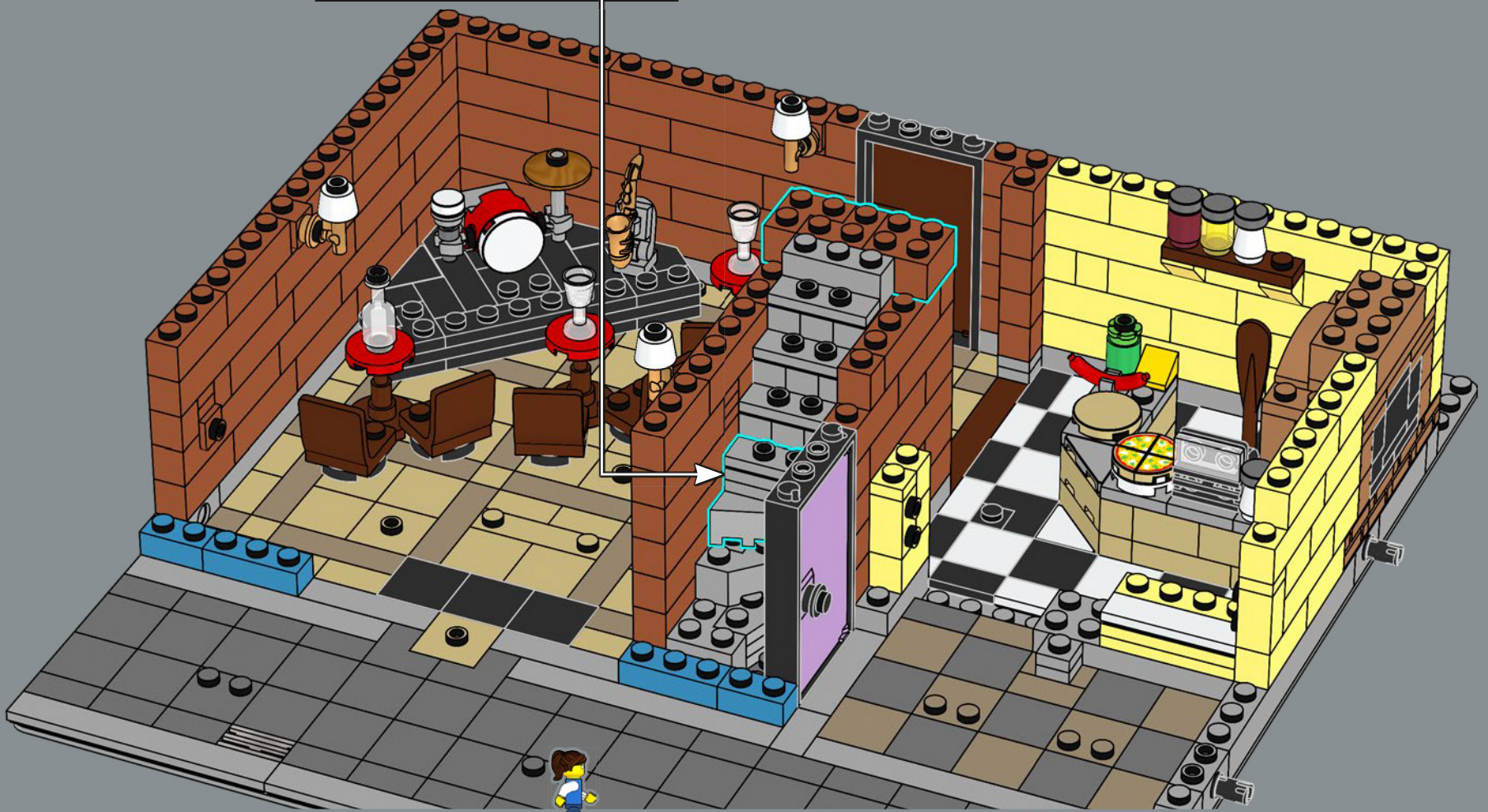

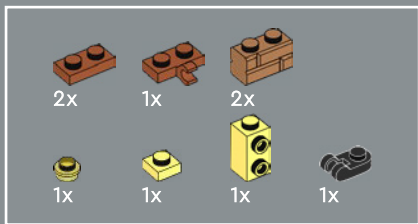

65

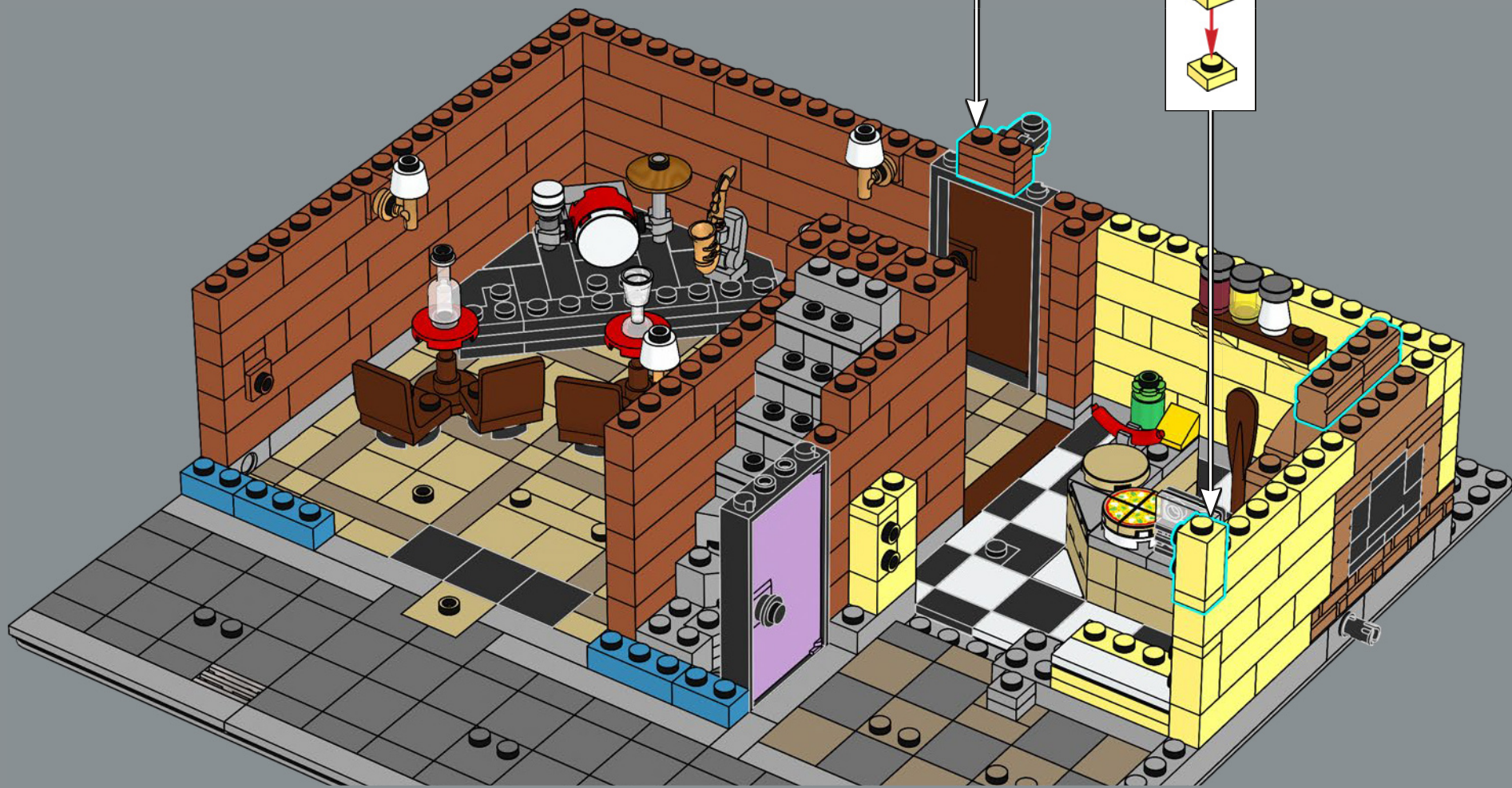
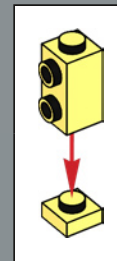
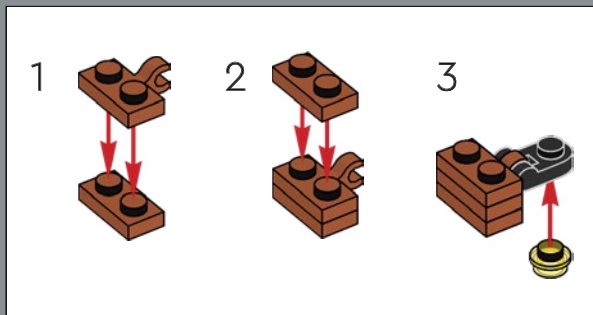

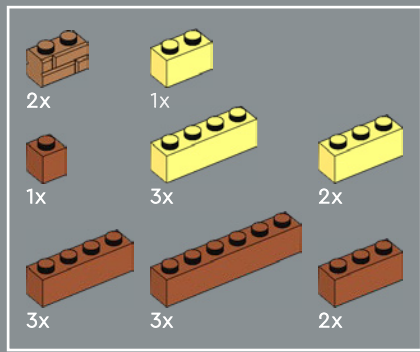

66



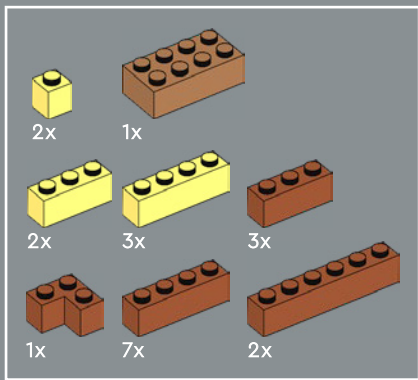

67



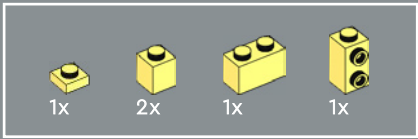

68

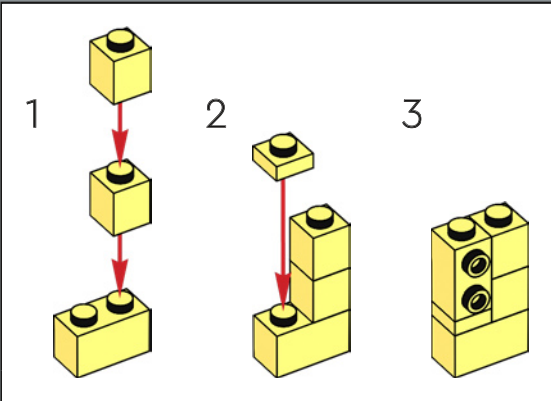

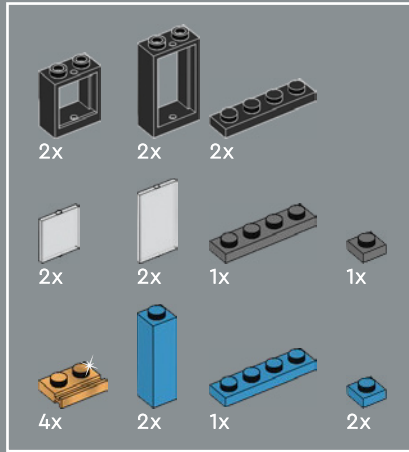
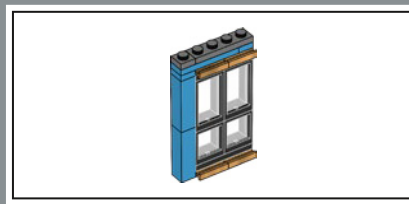

69

1

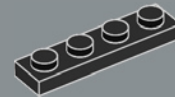

2

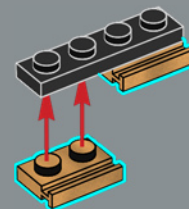

3

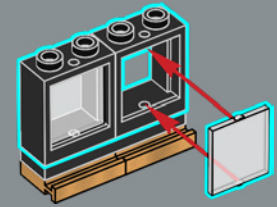

4

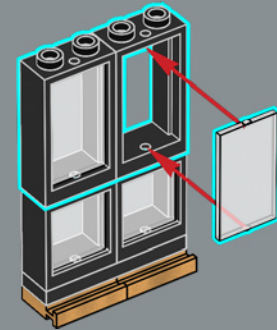

5

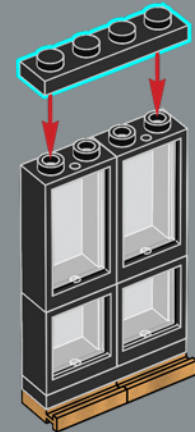

6

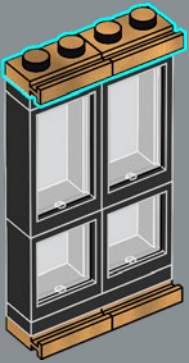

7

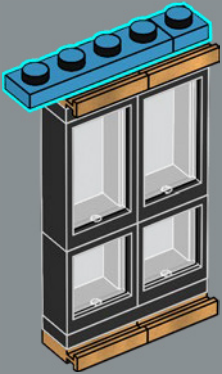

8

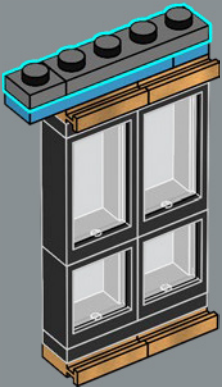

9

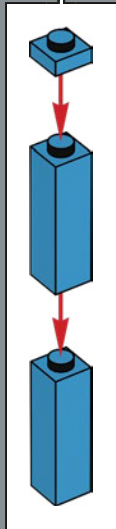
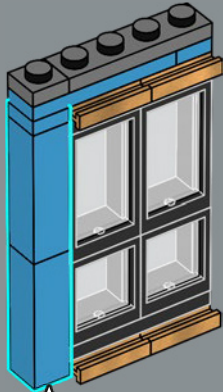

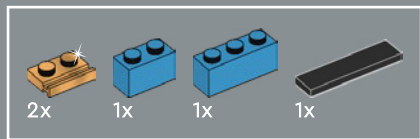

70

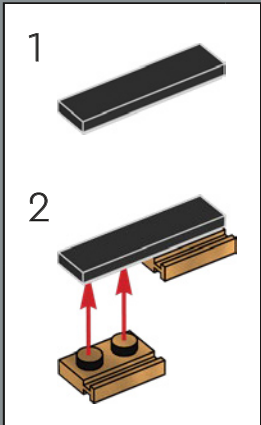
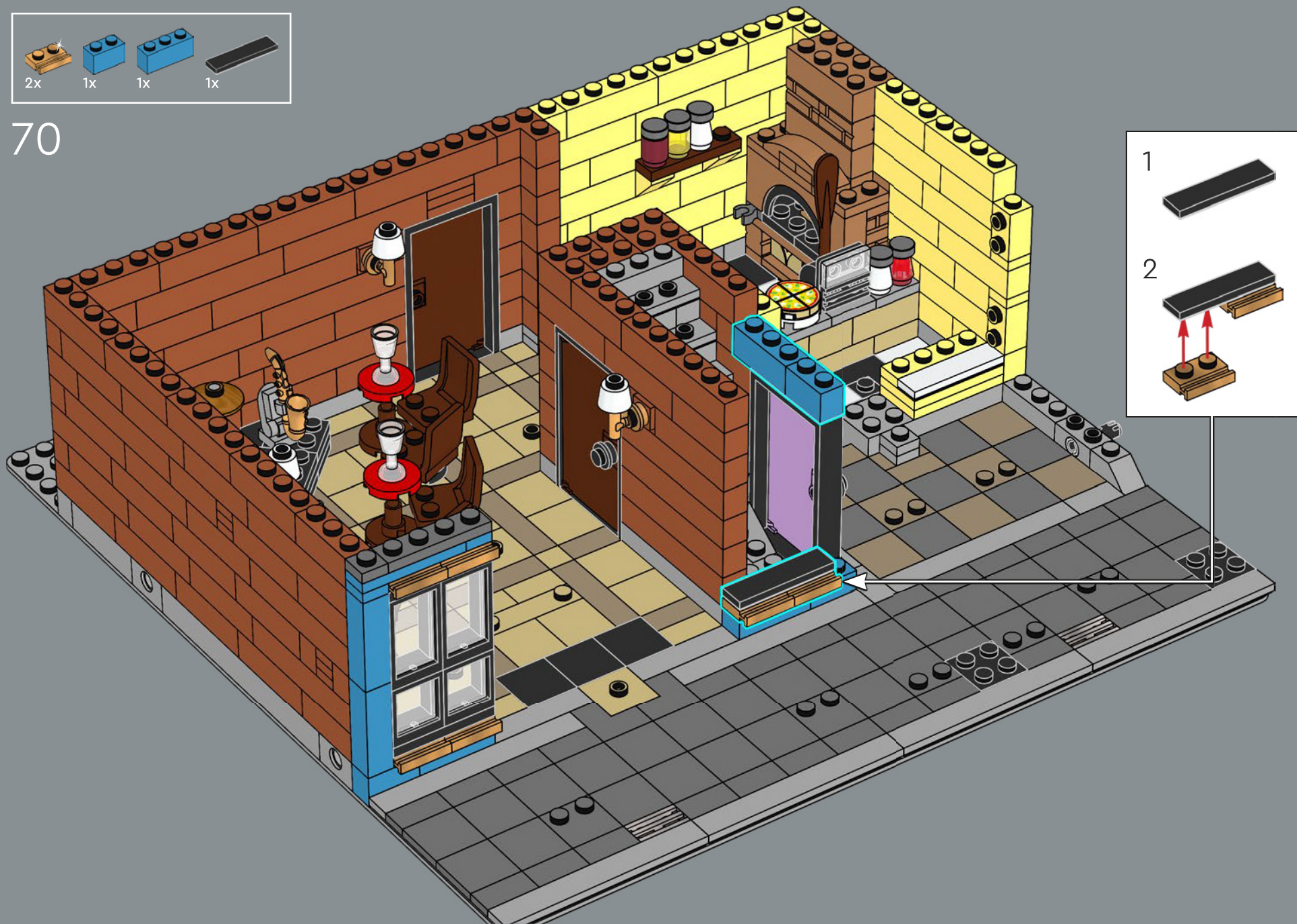

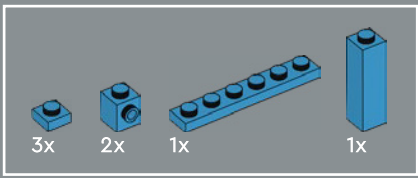

71

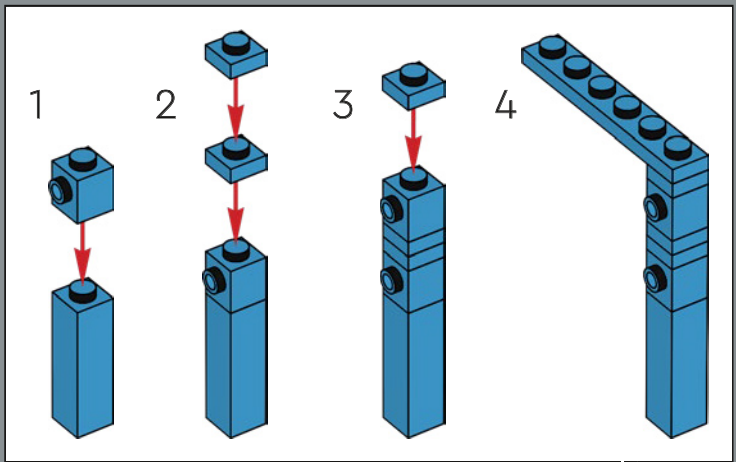

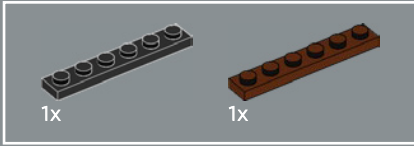

72

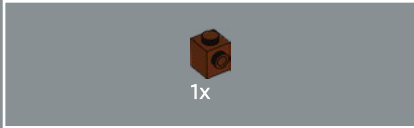
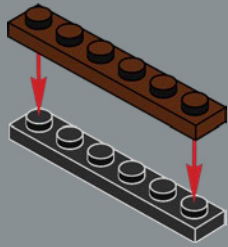

73

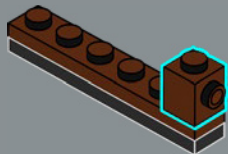

74

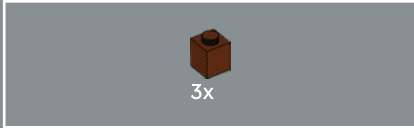

75

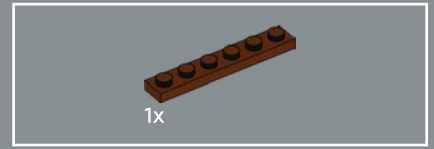

76

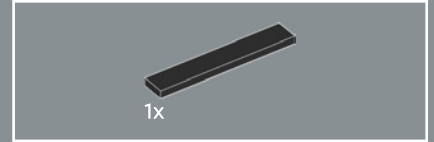

77



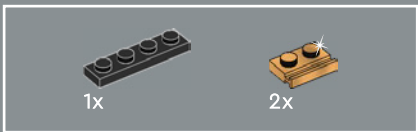

78

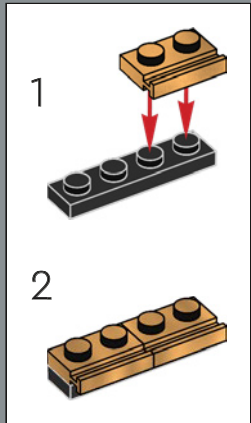

79



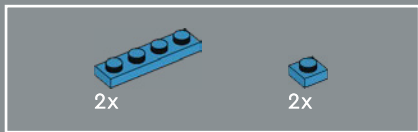

80

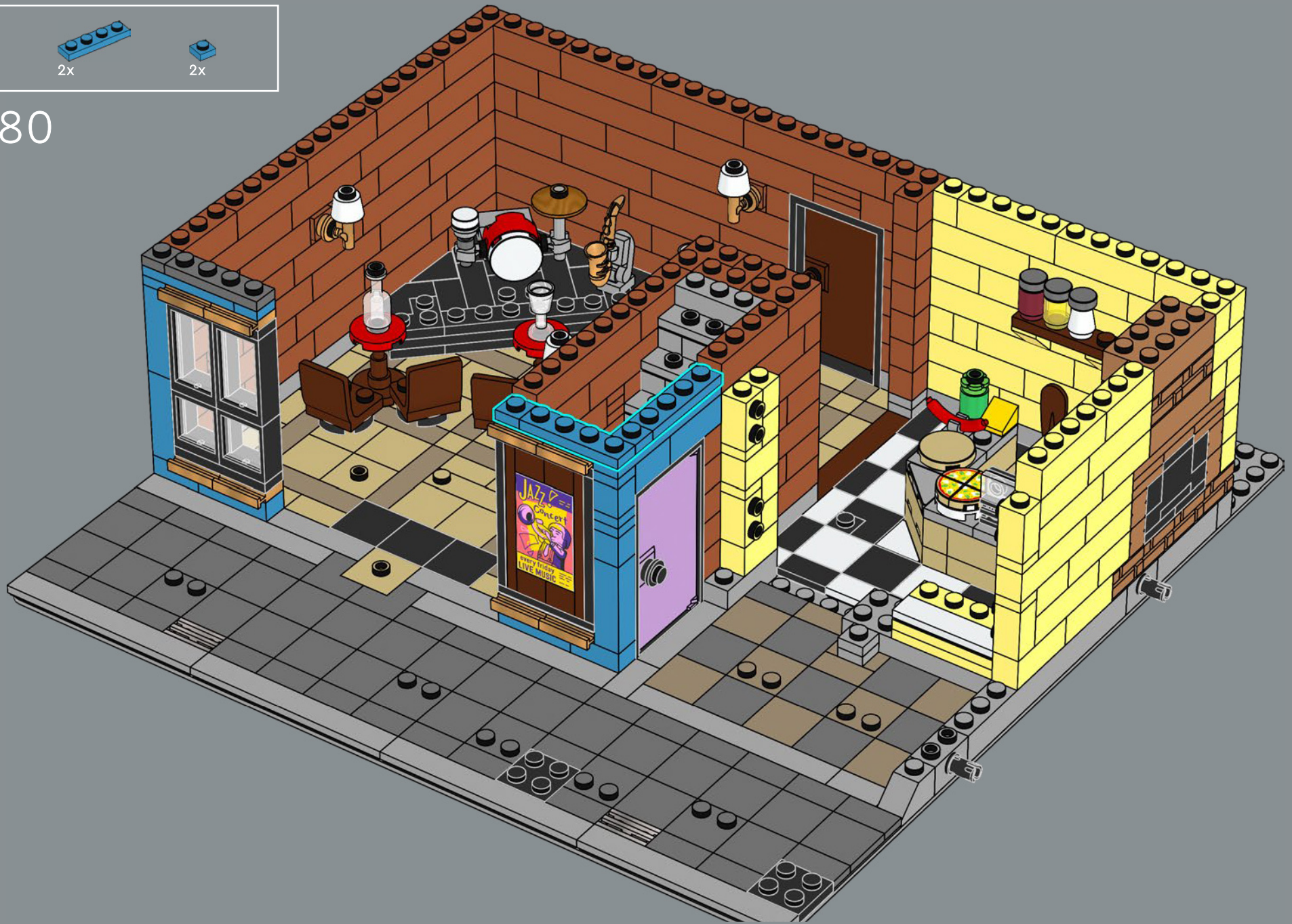

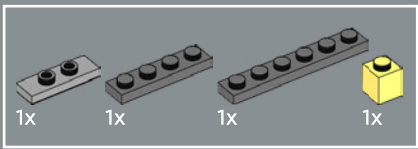

81



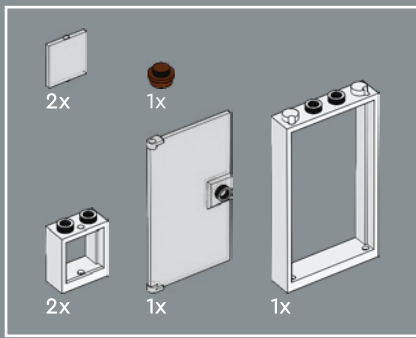

82

1

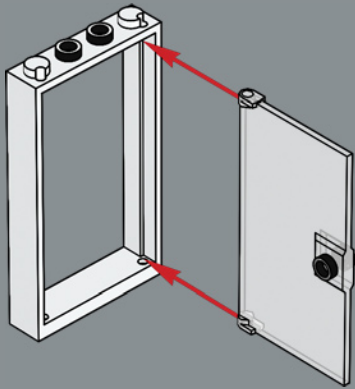

2



3

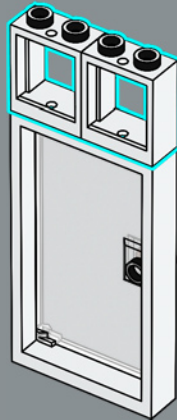

4

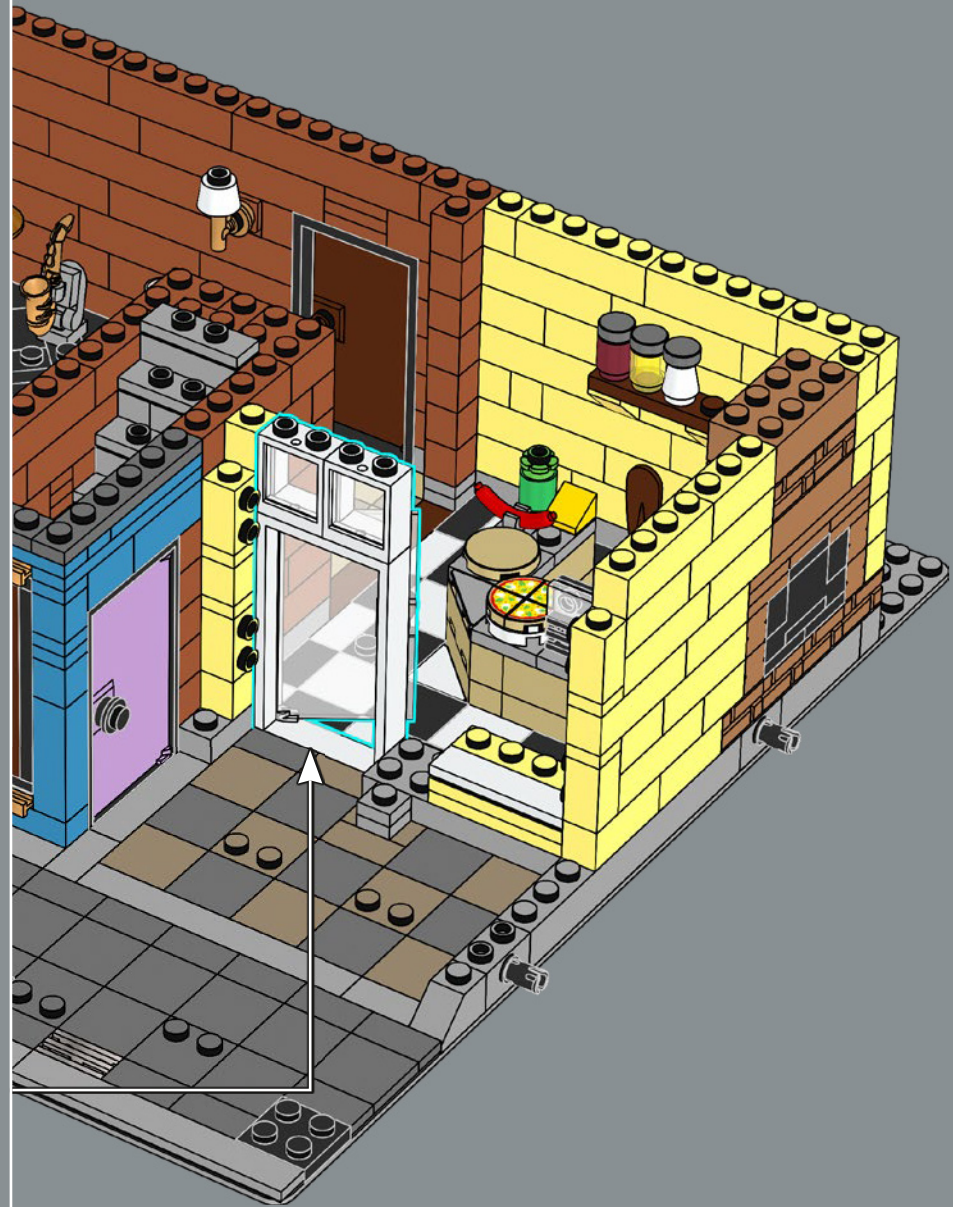
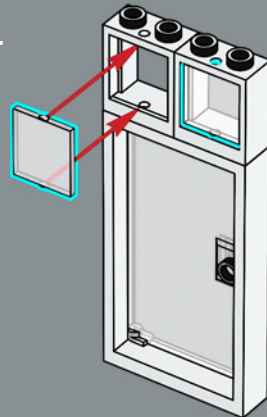

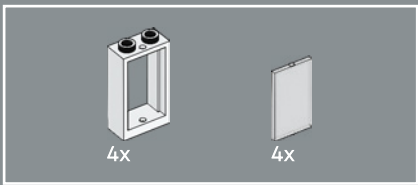

83

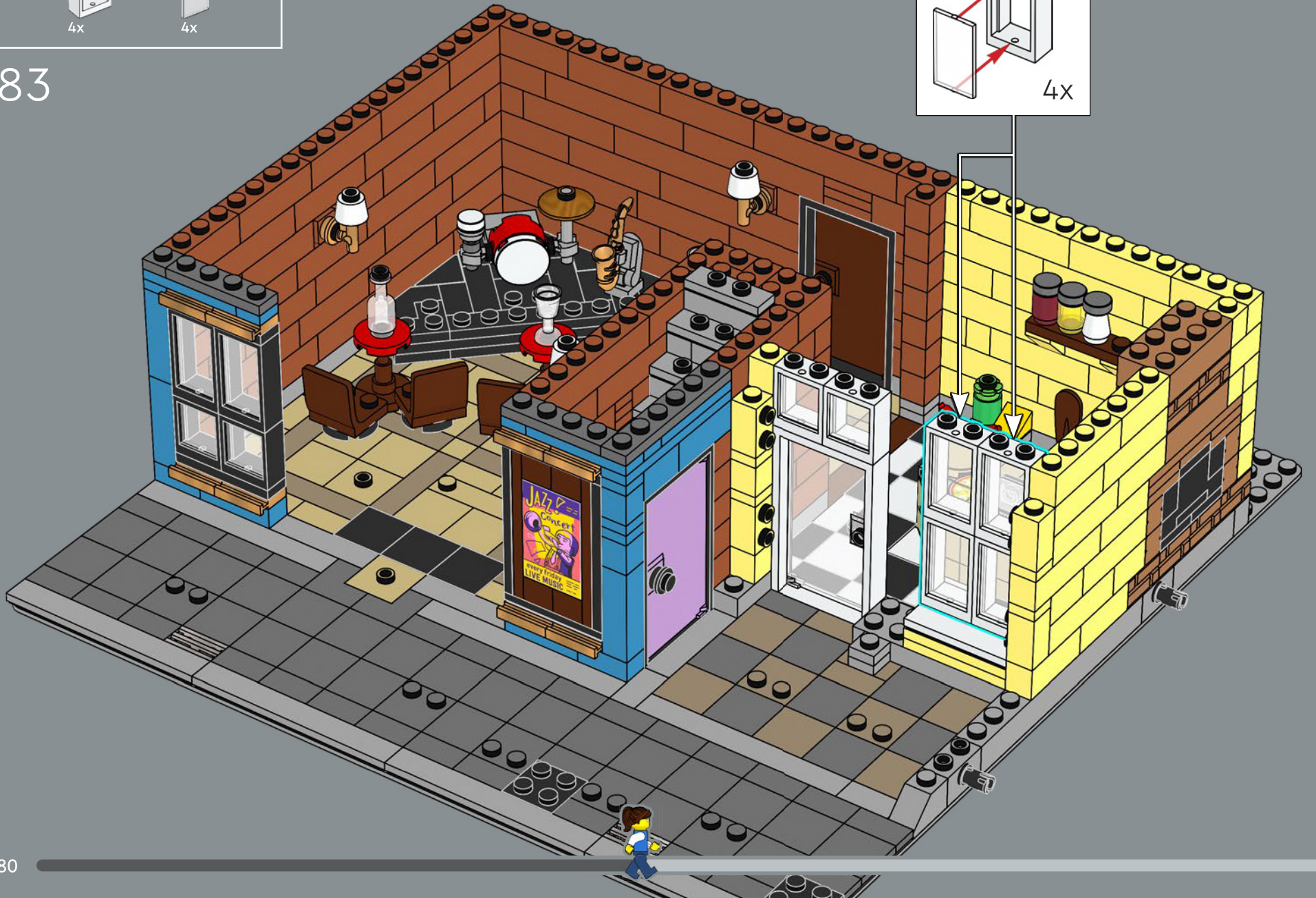
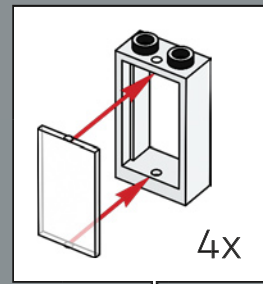

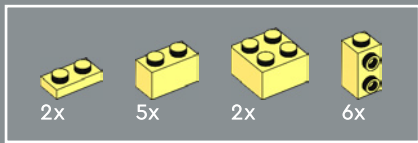

84

1

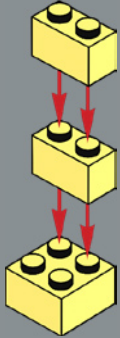

2

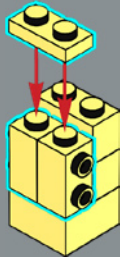

3

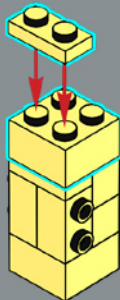

4

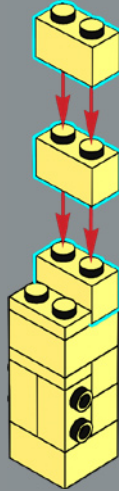

5

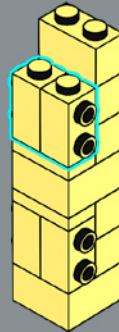

6

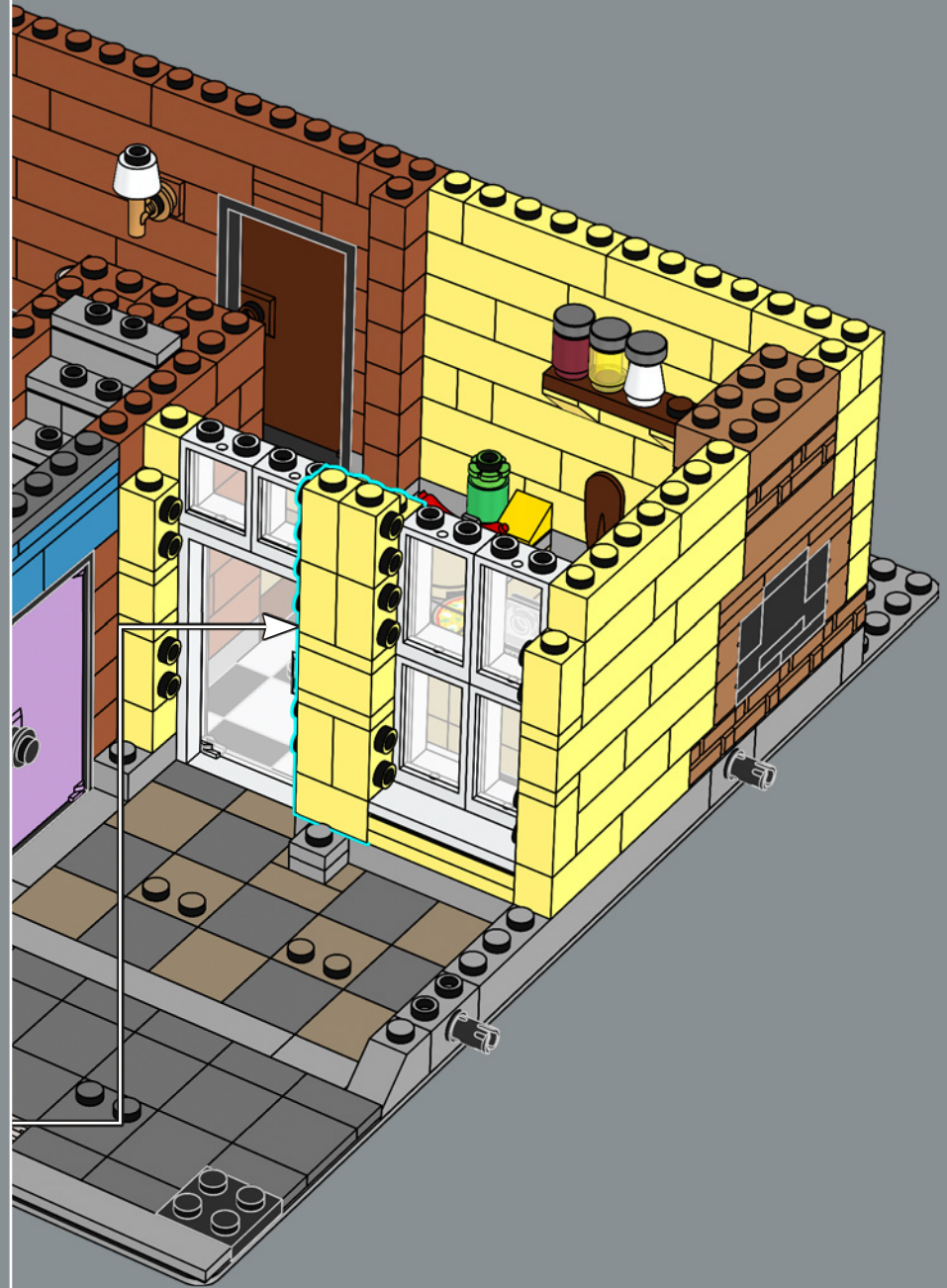
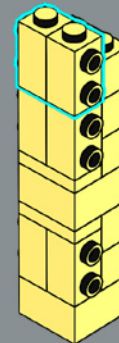



3x

85



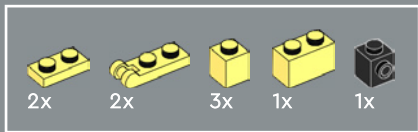

86

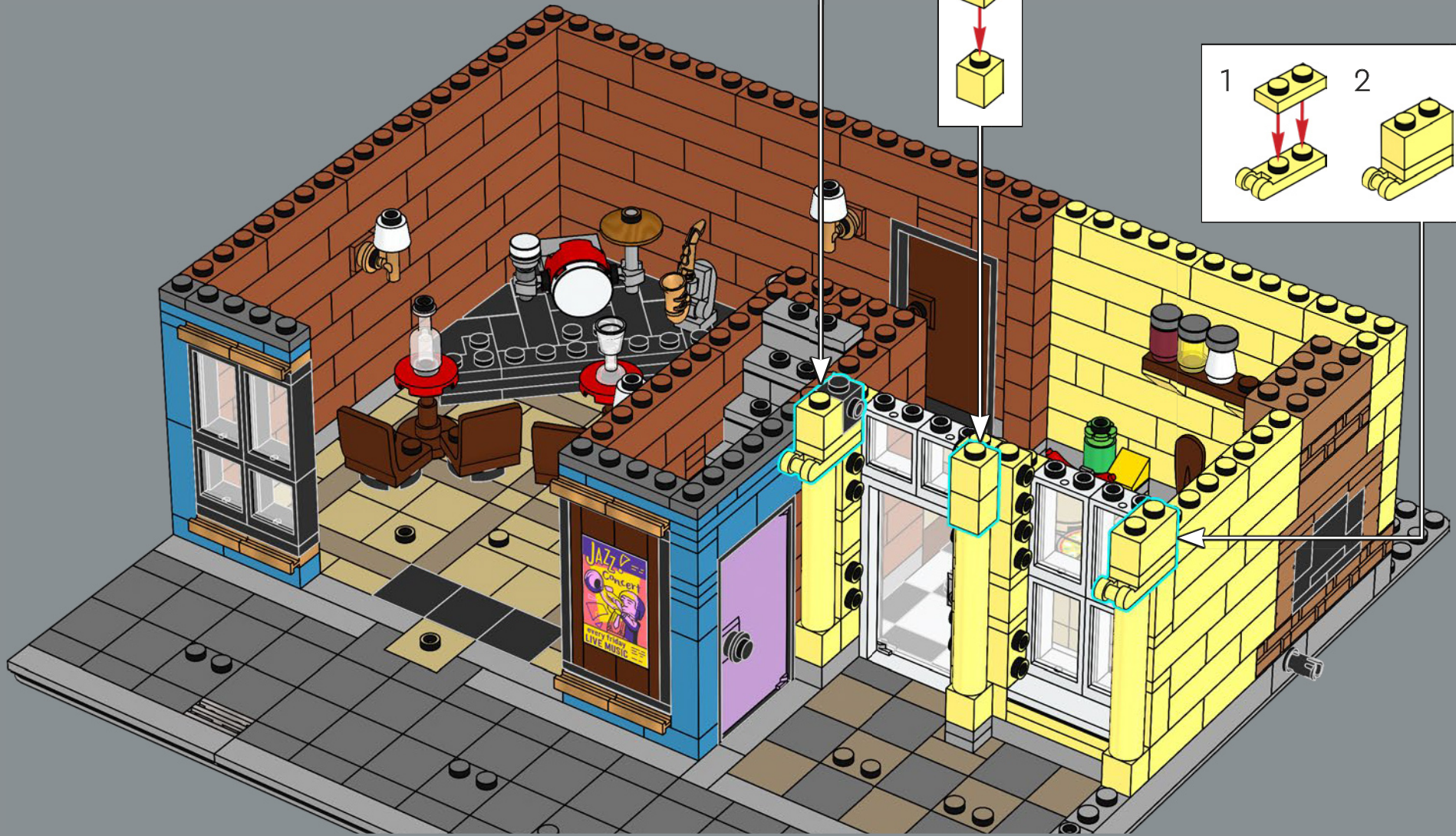
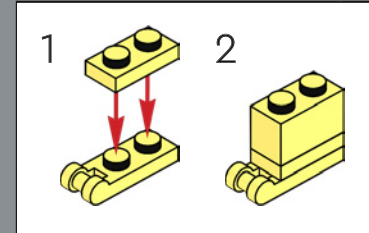
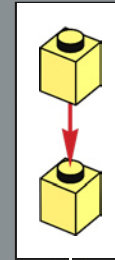
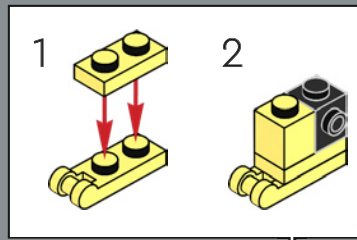

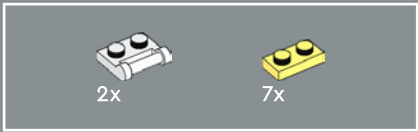

87

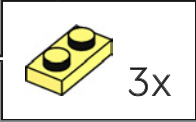
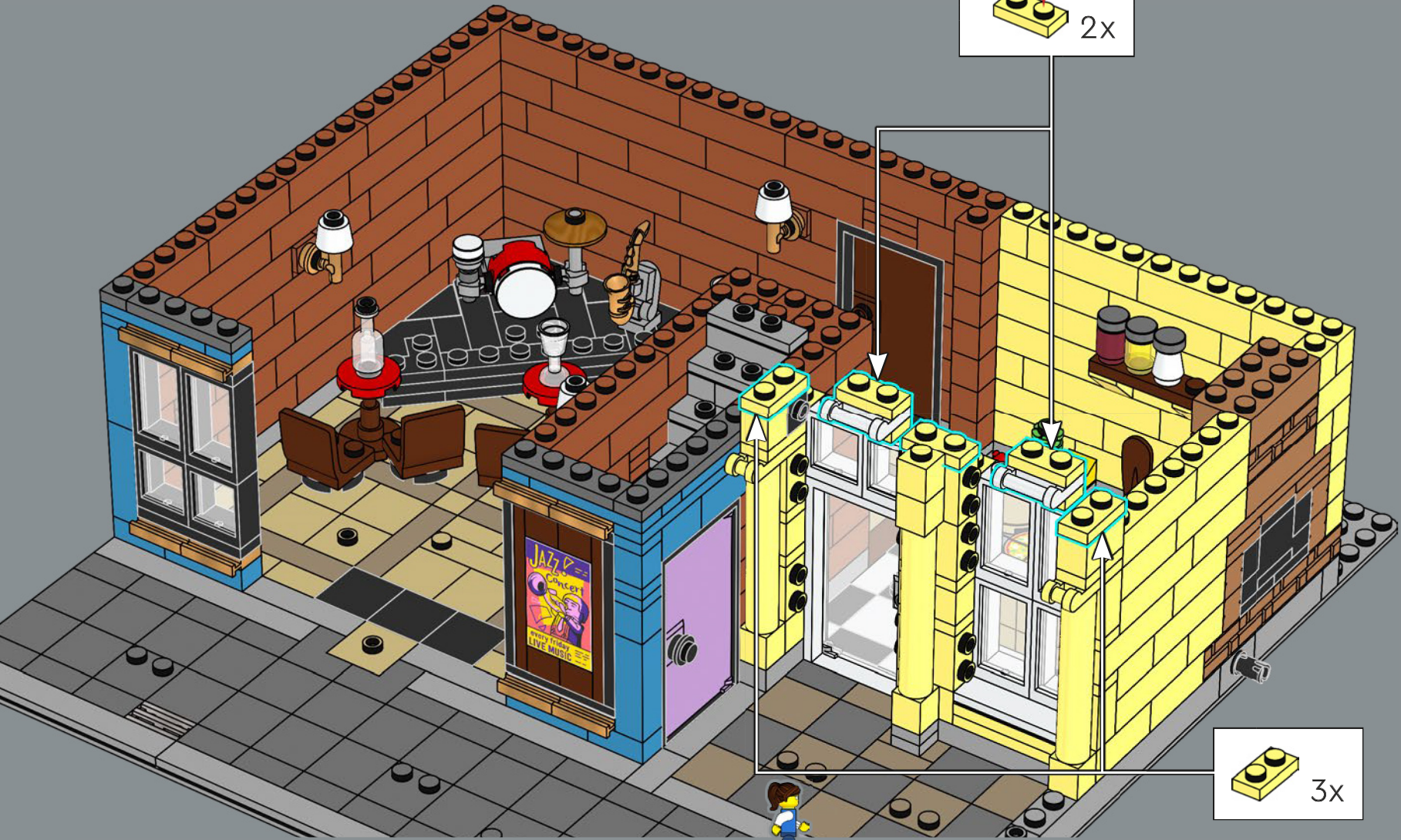
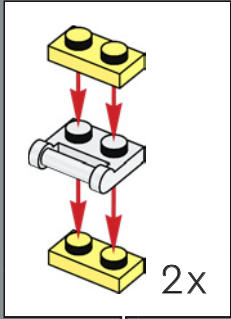

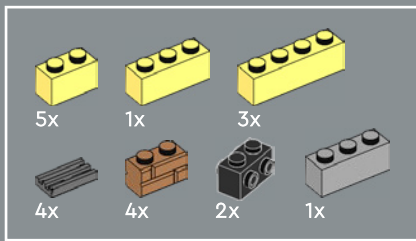

Add in these ventilation units to keep things cool. The oven, and the music, can get pretty hot!

Ajoutez ces unités de ventilation pour garder les lieux au frais. Le four, et la musique, peuvent vraiment chauffer !

Incluye estas unidades de ventilación para mantener la frescura del lugar. El horno, al igual que la música, ¡puede alcanzar temperaturas demasiado altas!

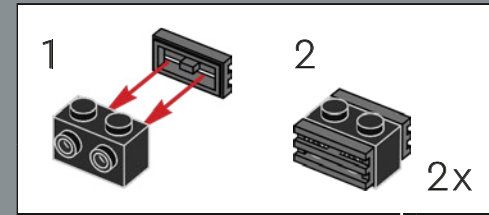

88



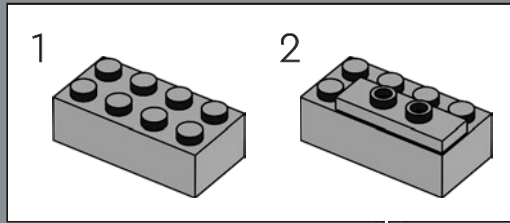
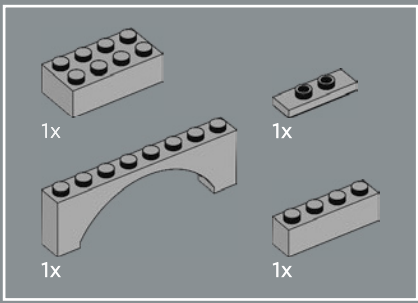

89



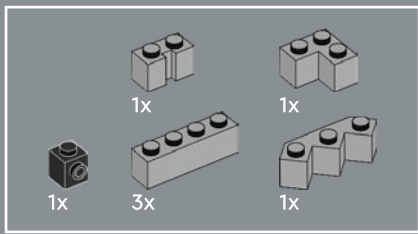

90



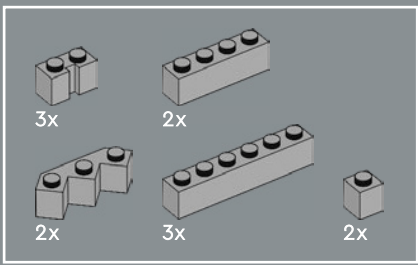

91

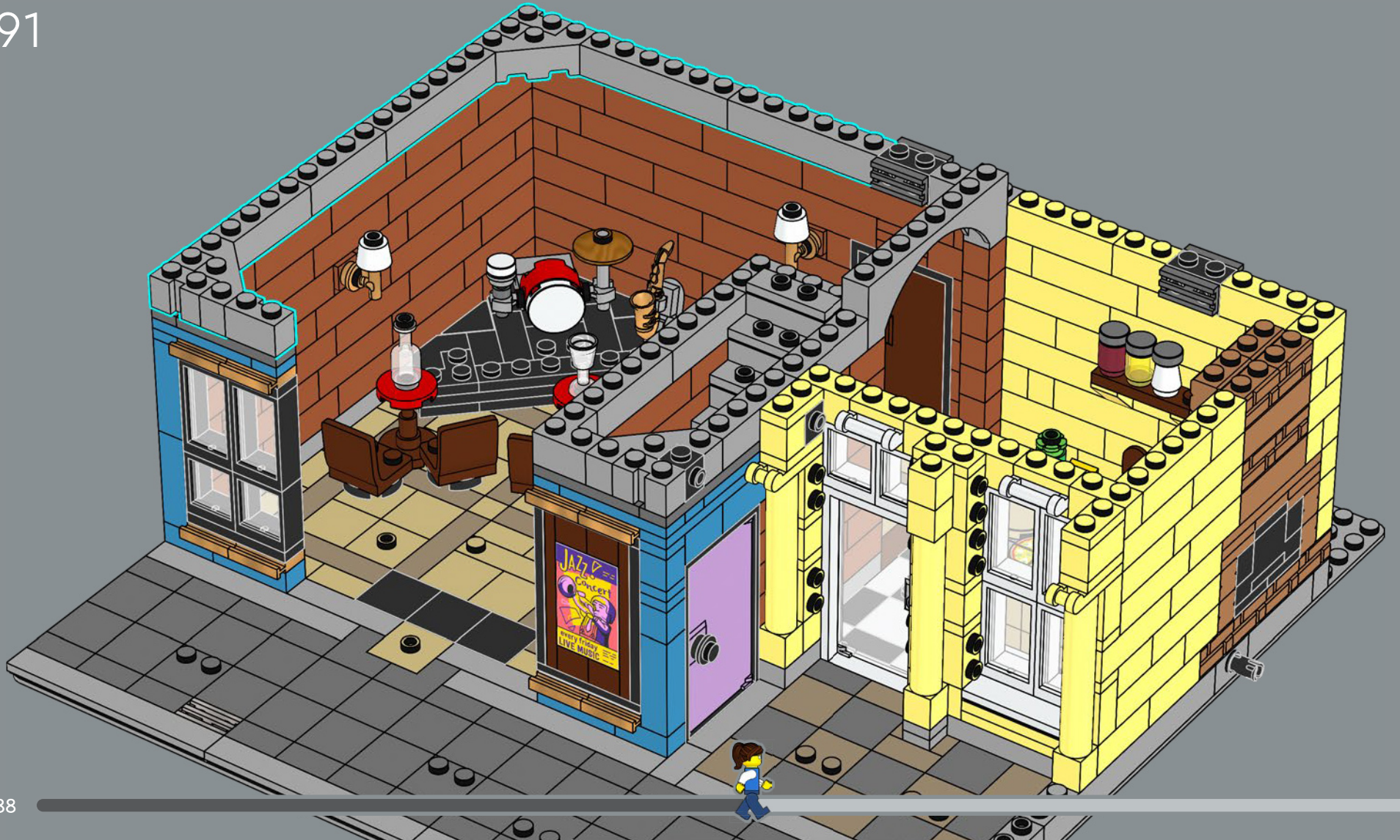

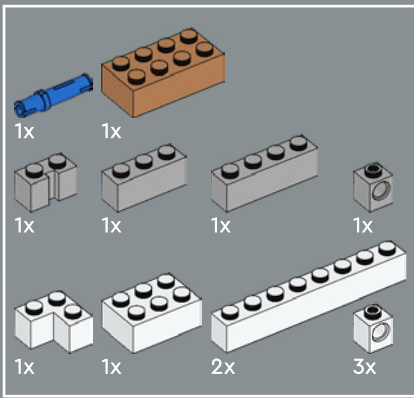

92

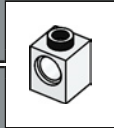
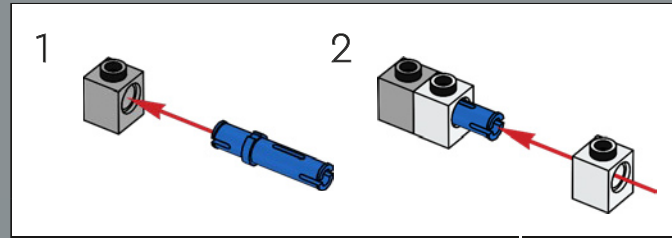

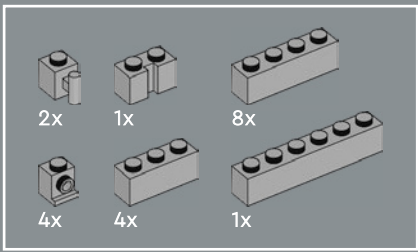

93



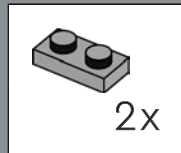
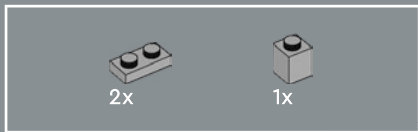

94



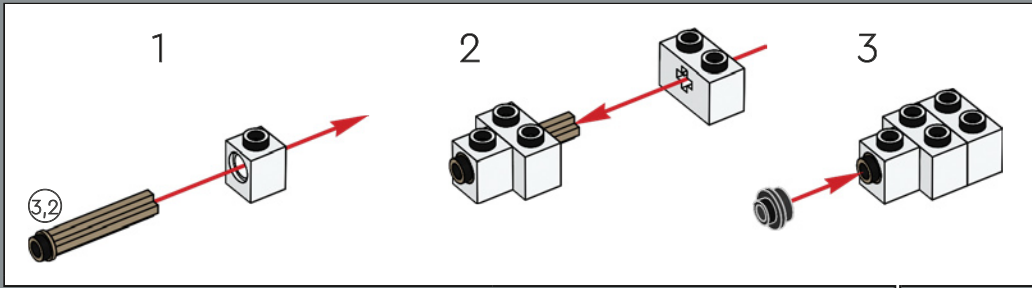
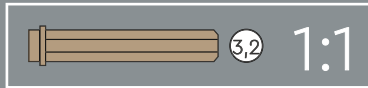
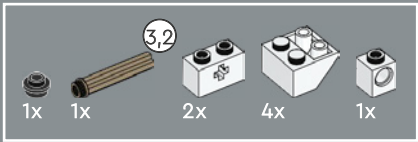

95

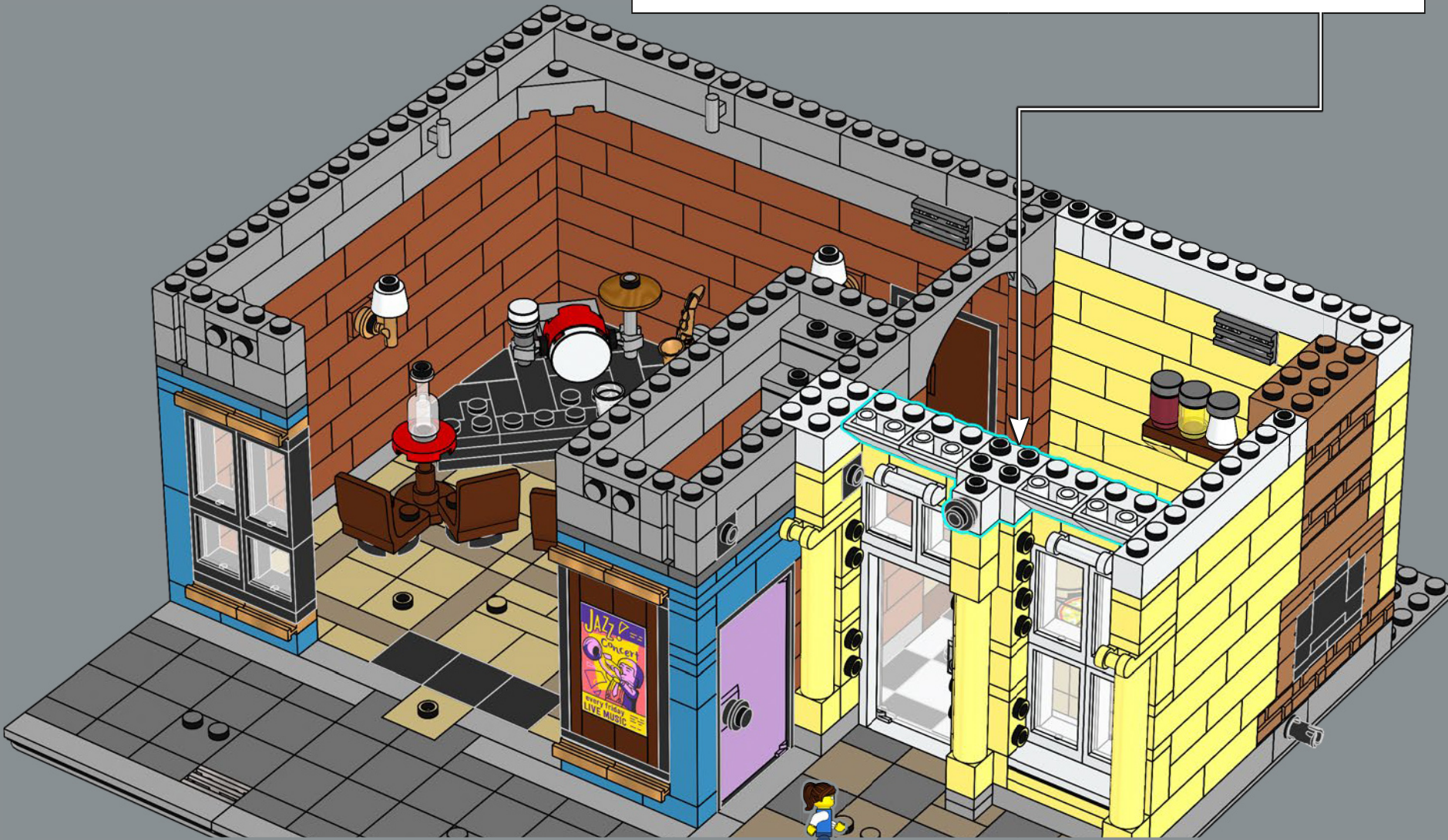

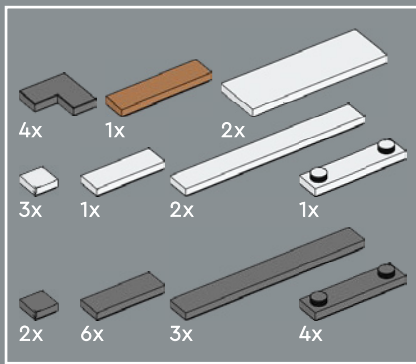

96



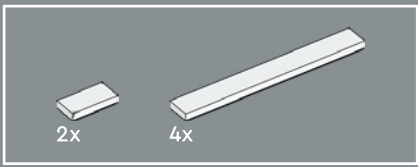

97

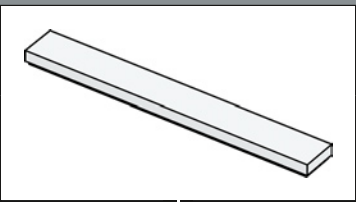



98

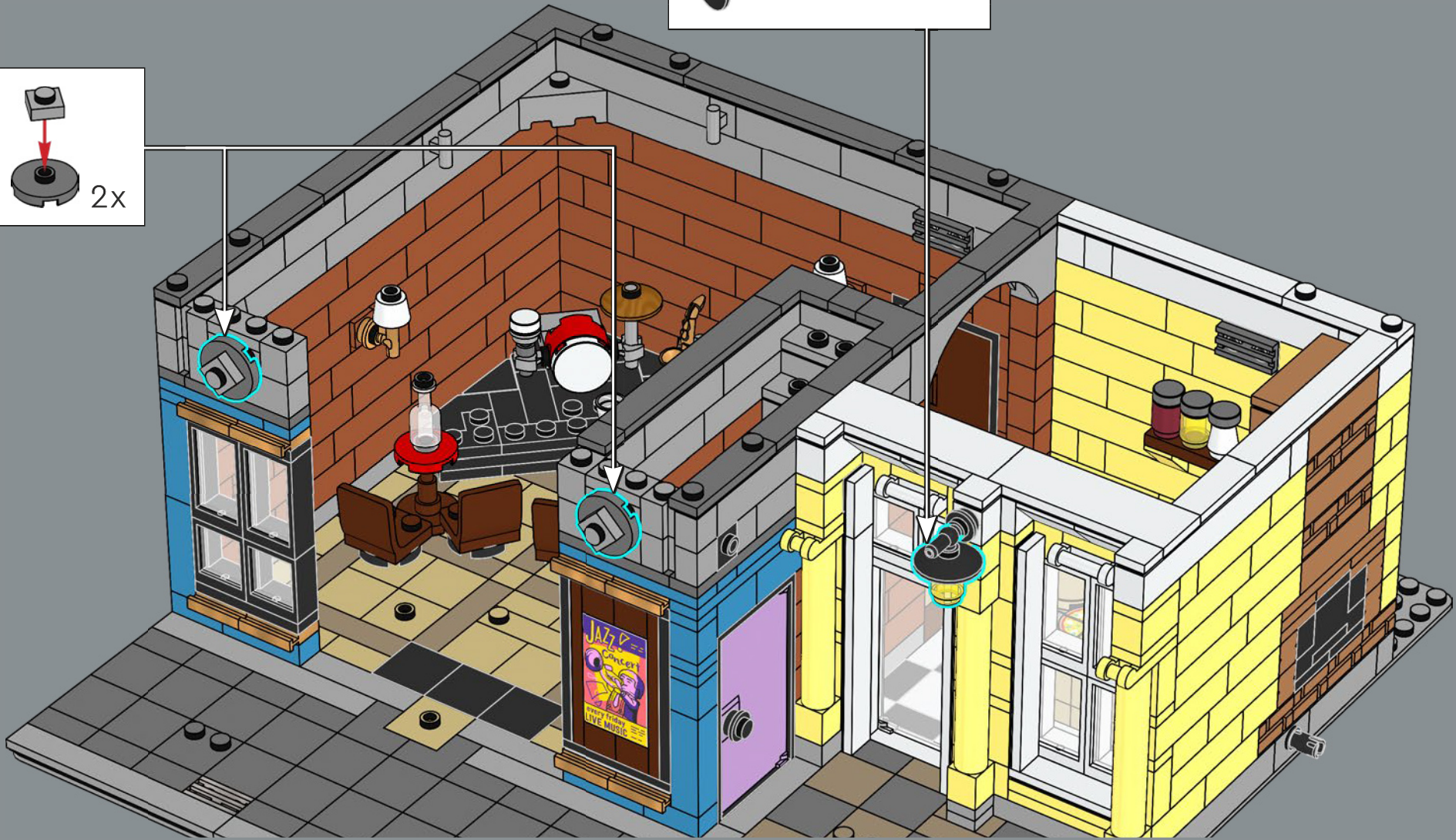
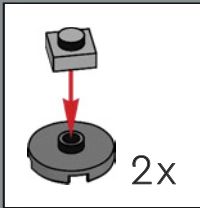
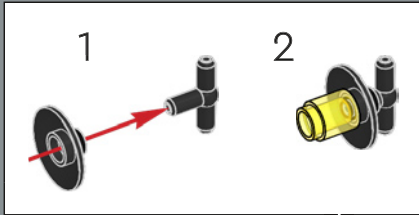

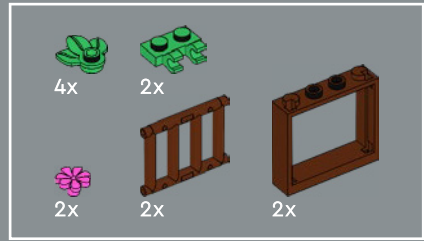

99

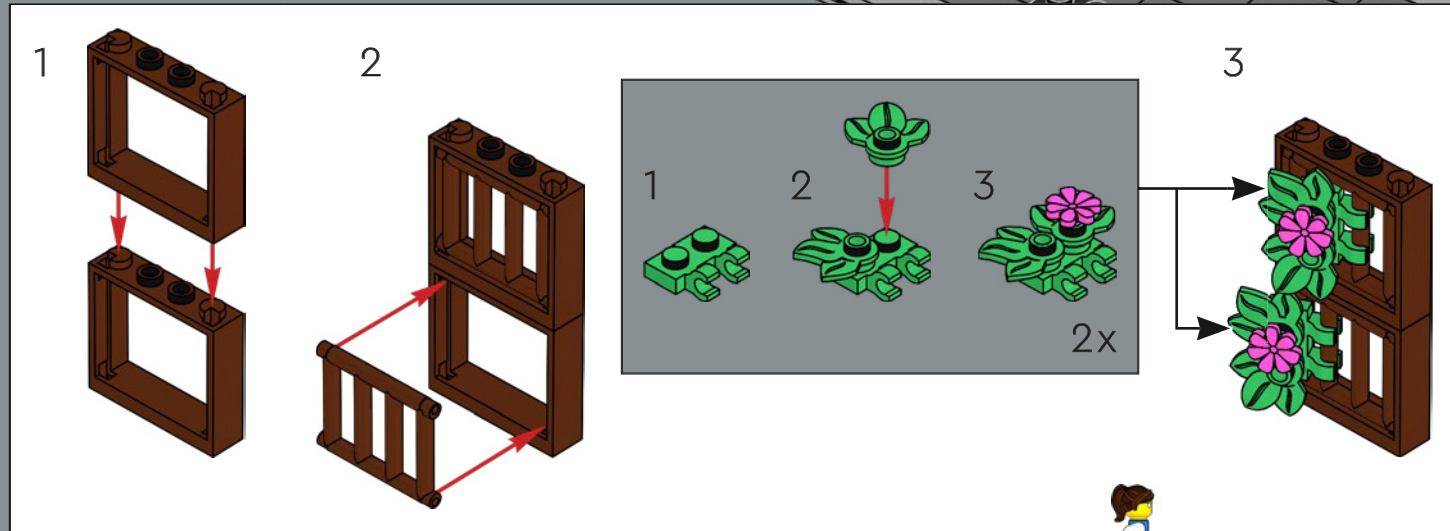

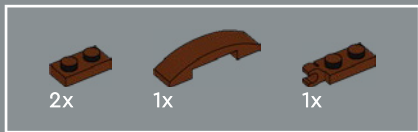

100

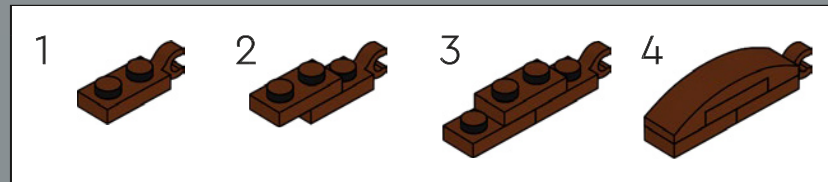

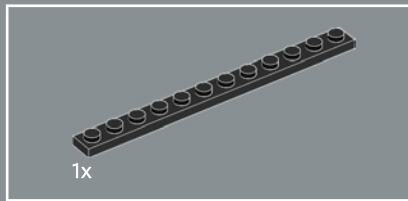

101

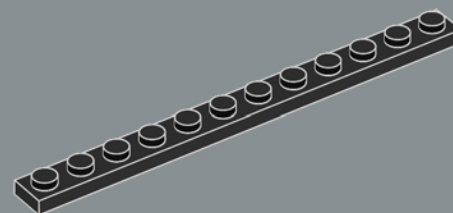

102

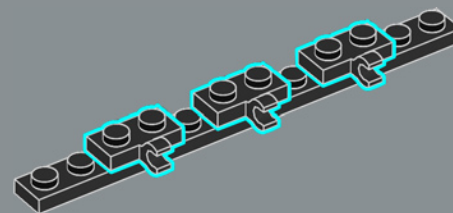

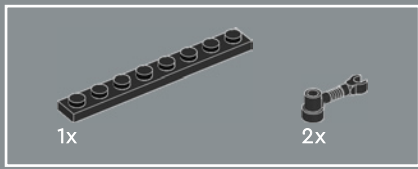

103

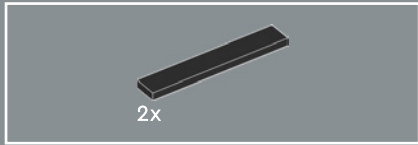
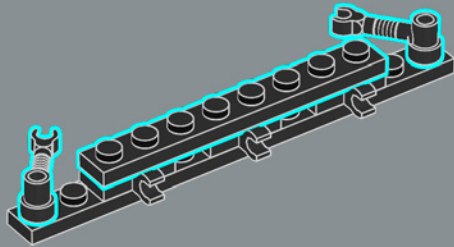

104

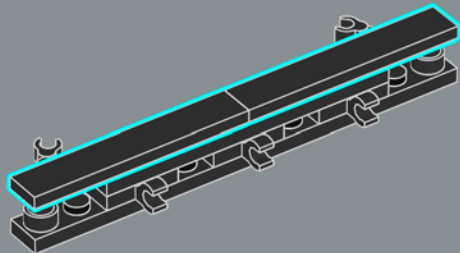

105

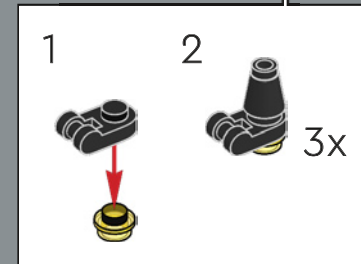
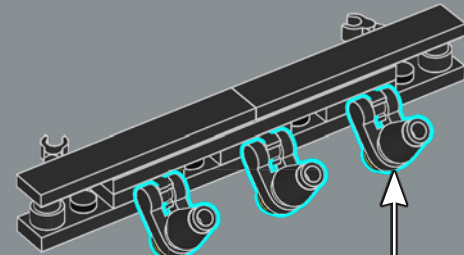

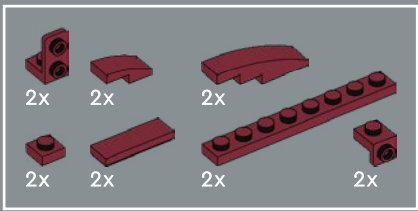

106

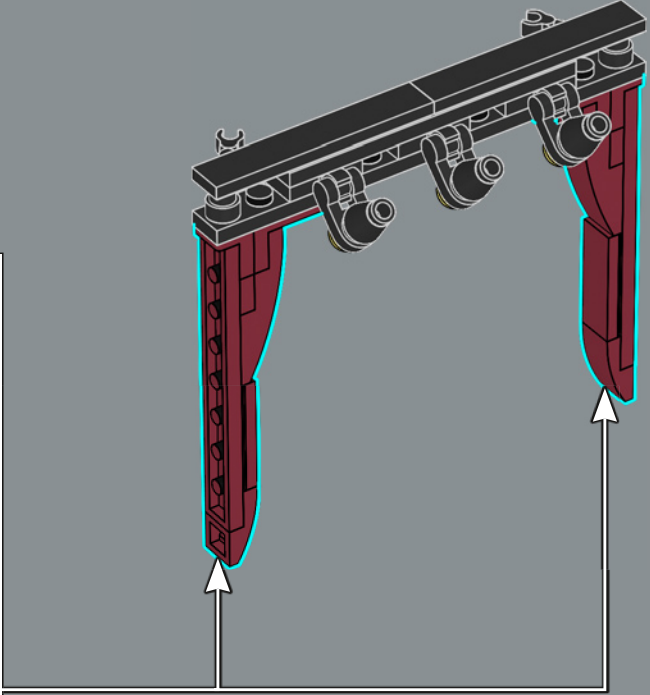
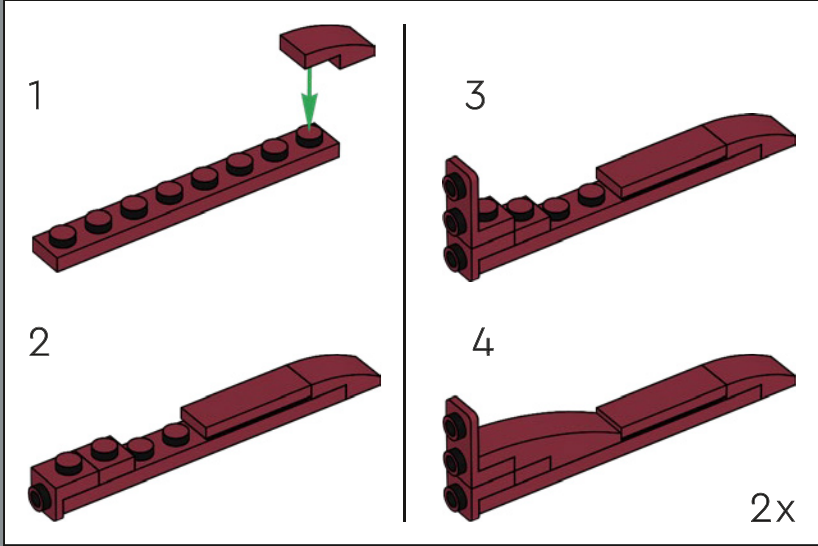

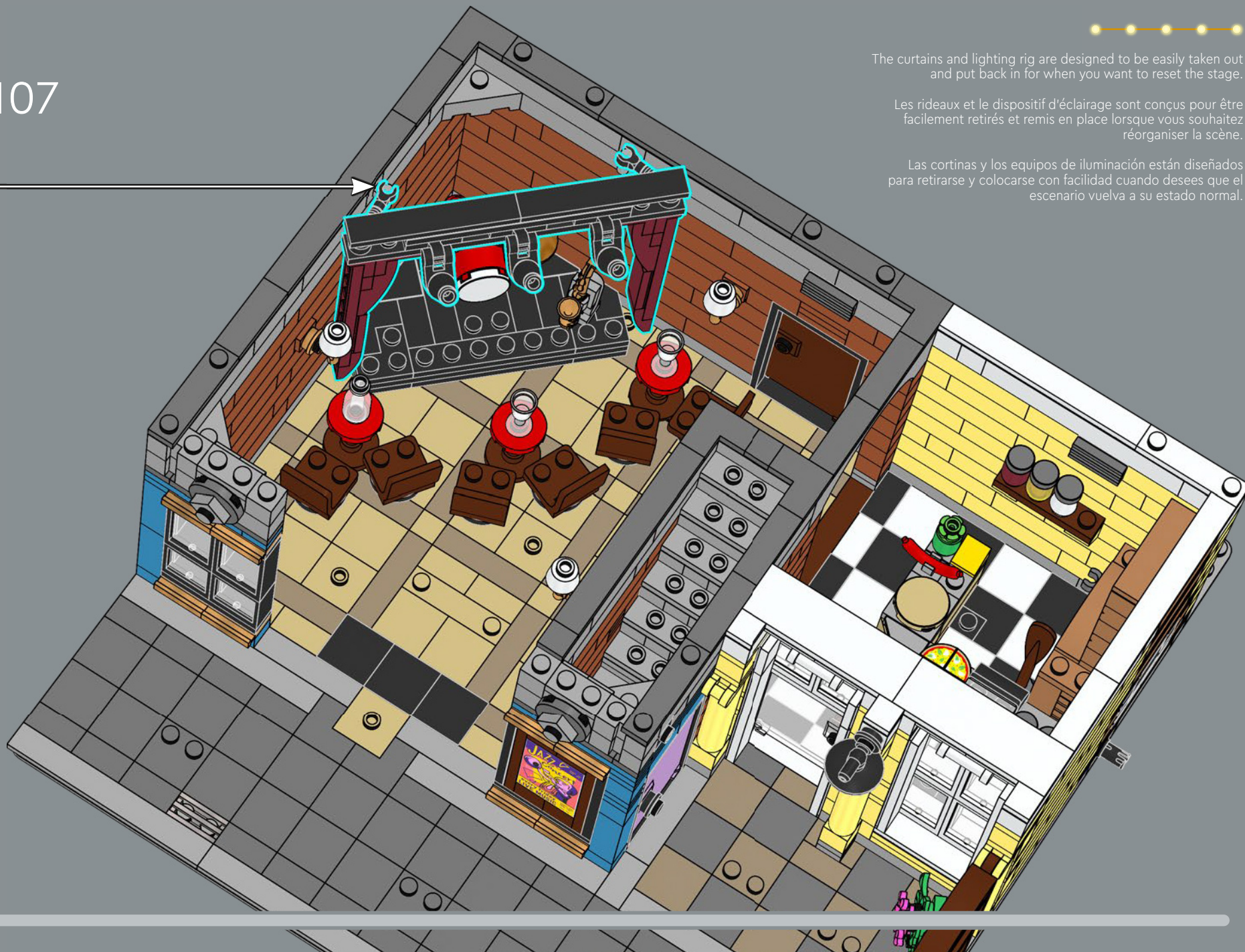

The curtains and lighting rig are designed to be easily taken out and put back in for when you want to reset the stage.

Les rideaux et le dispositif d'éclairage sont conçus pour être facilement retirés et remis en place lorsque vous souhaitez réorganiser la scène.

Las cortinas y los equipos de iluminación están diseñados para retirarse y colocarse con facilidad cuando desees que el escenario vuelva a su estado normal.

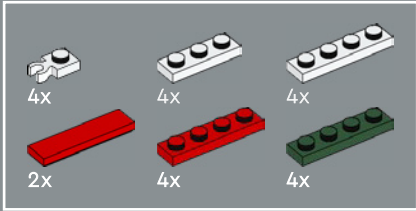

108

1

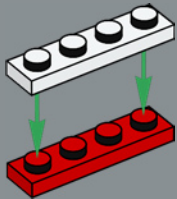

2

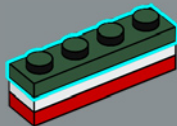

3

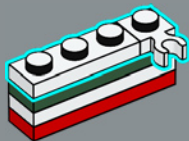

4

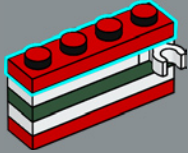

5

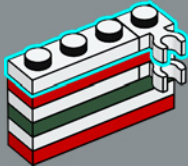

6

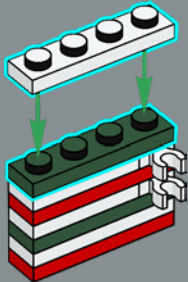

7

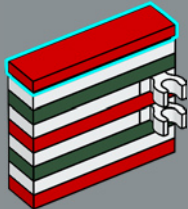

2x





109

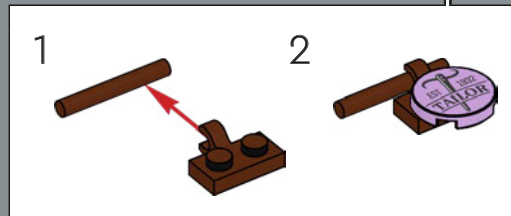
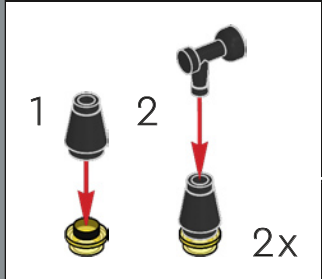

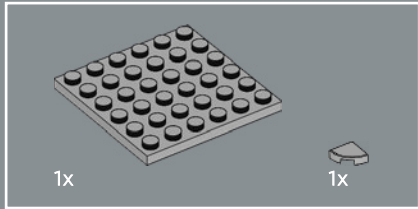
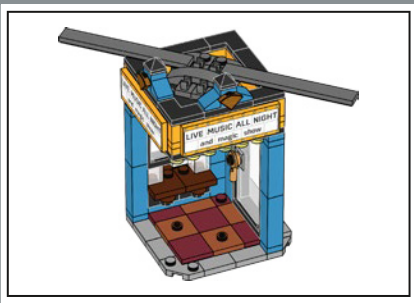

110

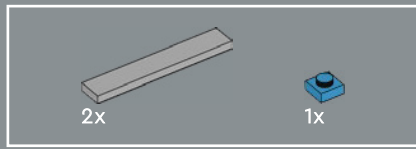
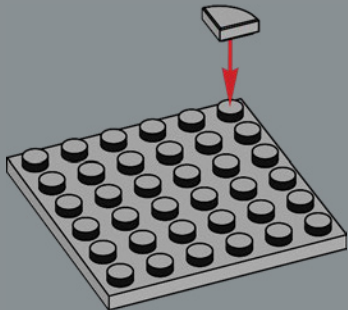

111

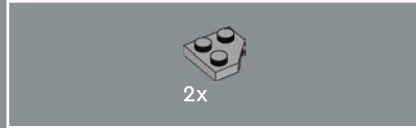
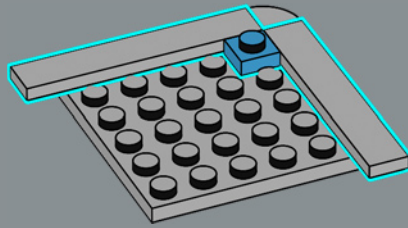

112

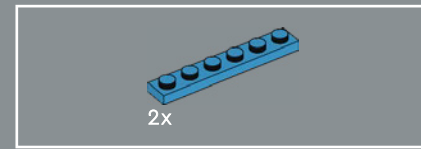
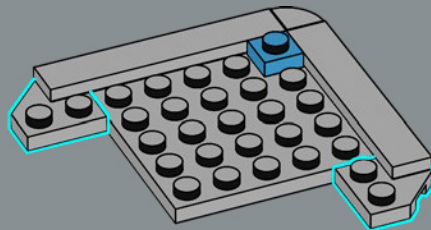

113

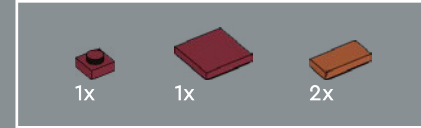
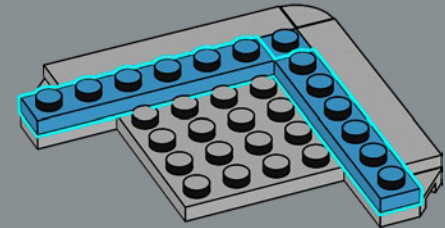

114

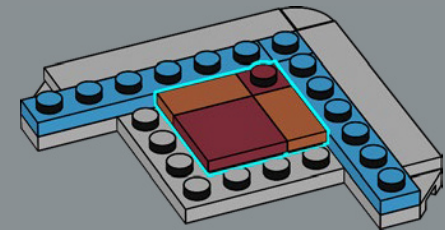

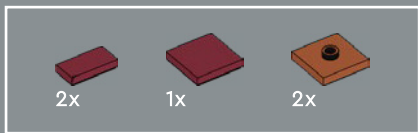

115

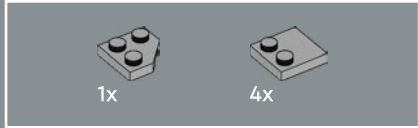
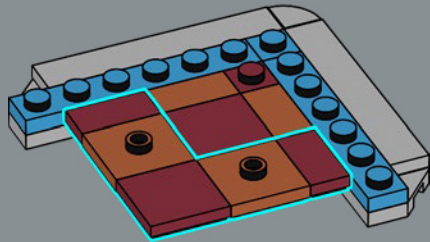

116

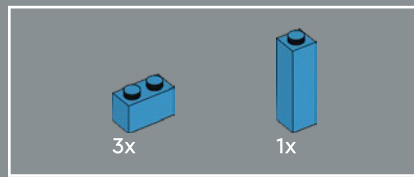
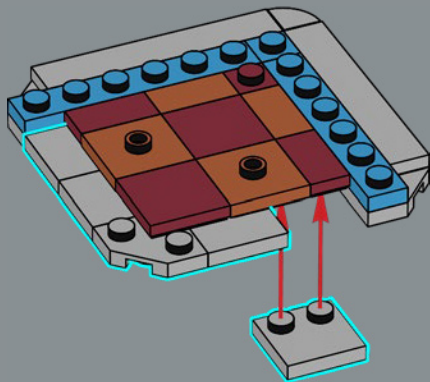

117

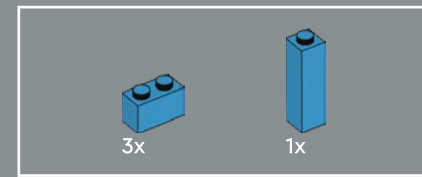
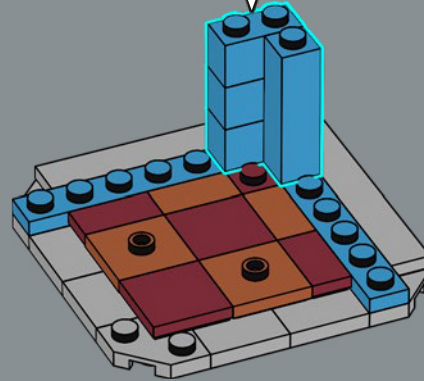
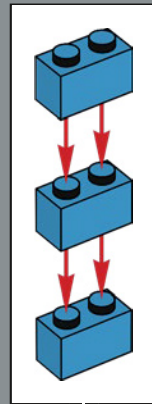

118

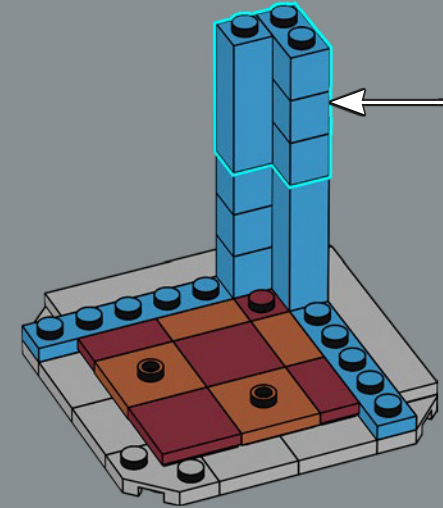
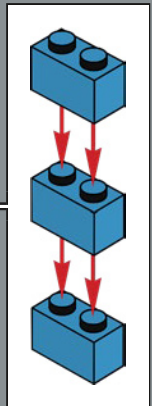

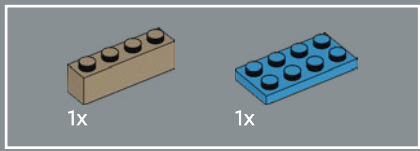

119

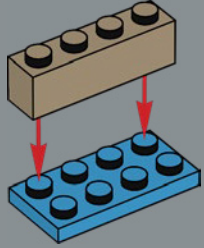

120

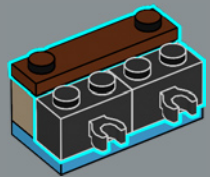

121

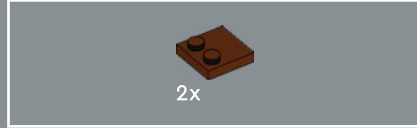
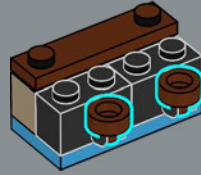

122

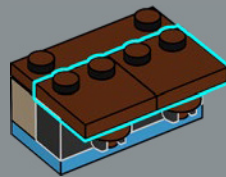

123

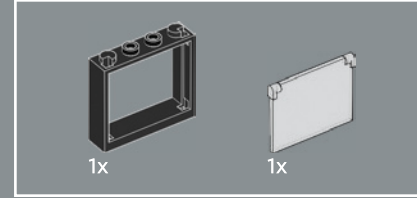
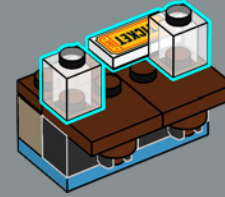

124

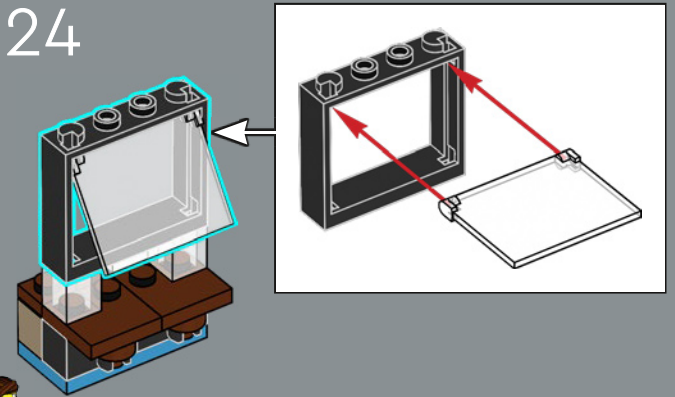

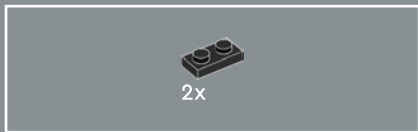

125

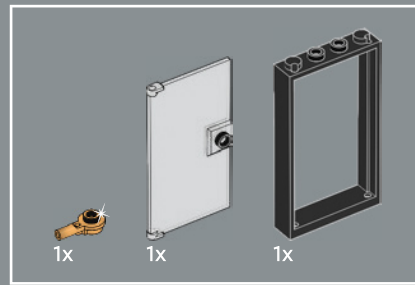
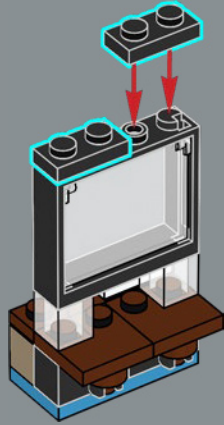

127

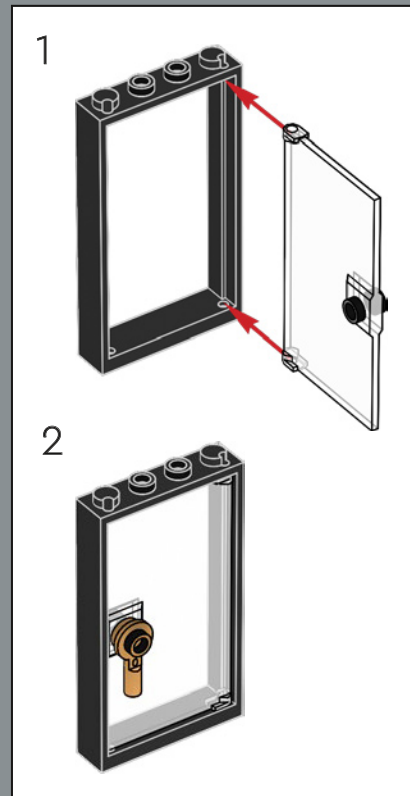

126

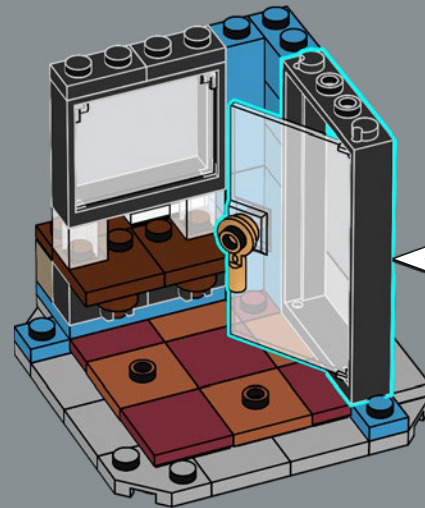
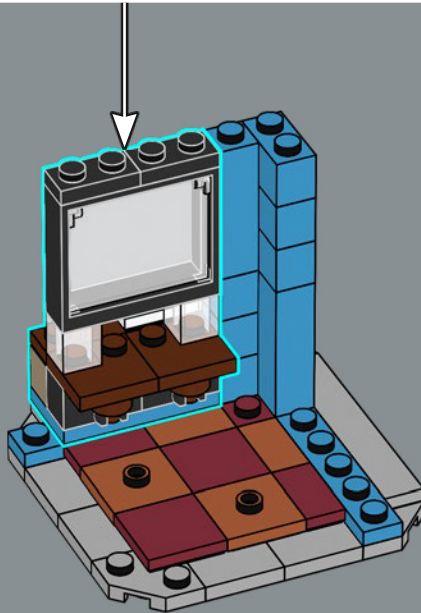



4x

128

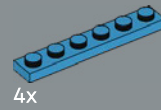
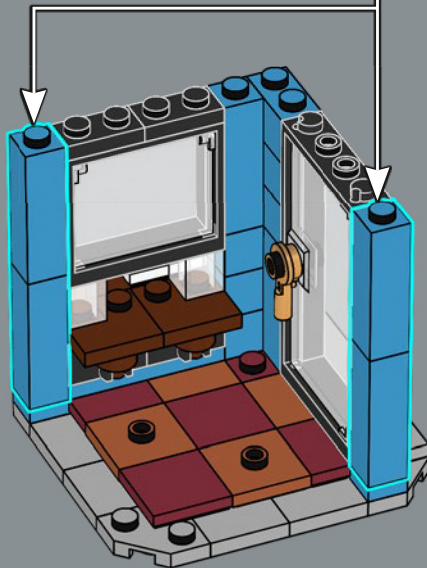
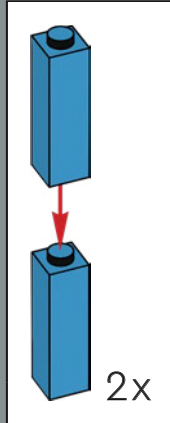

4x



2x

129

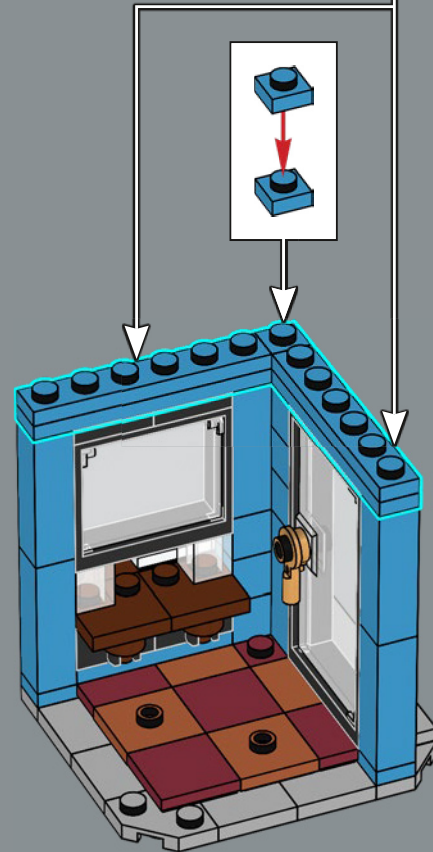
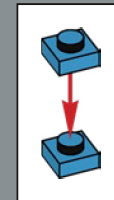
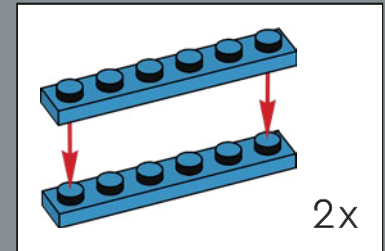

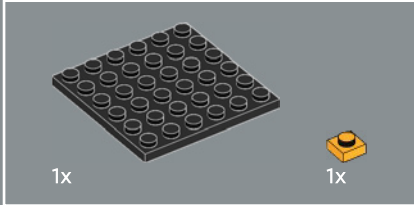

130

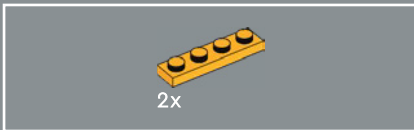
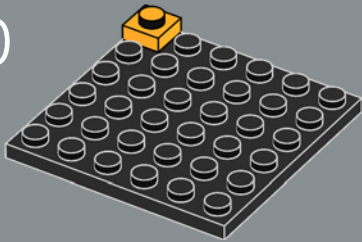

131

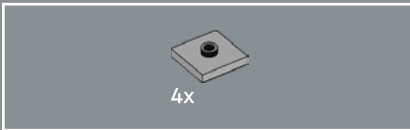
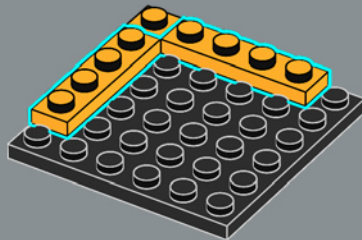

132

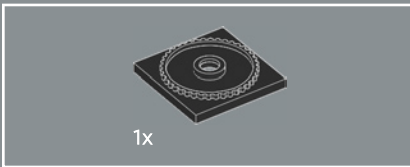
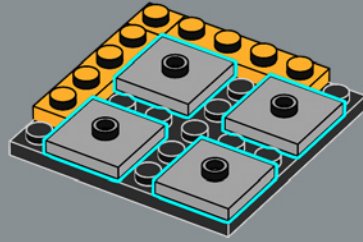

133

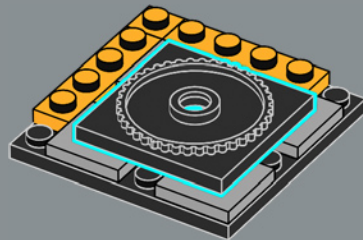

134

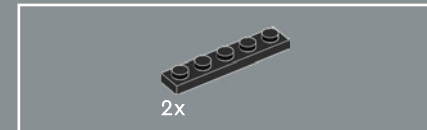
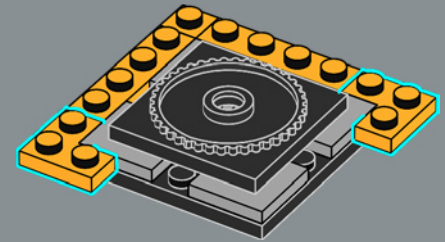

135

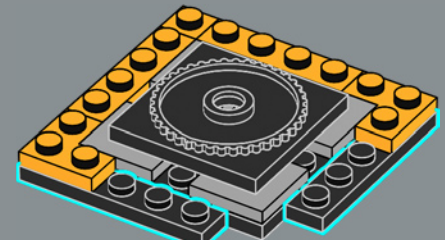

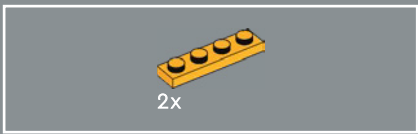

136

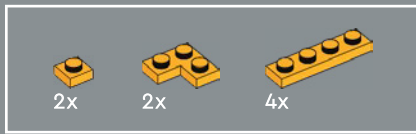
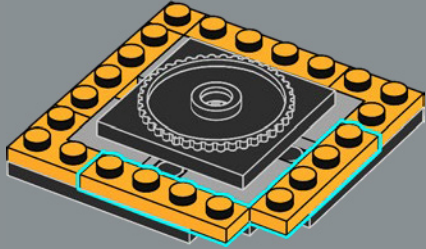

138

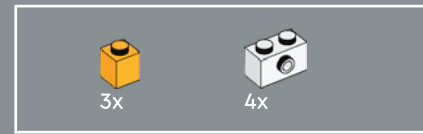
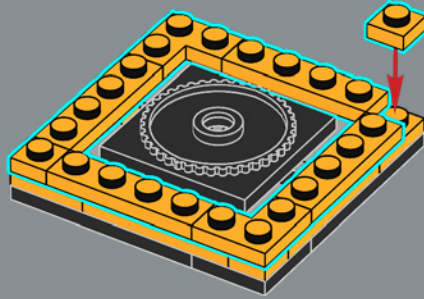

140

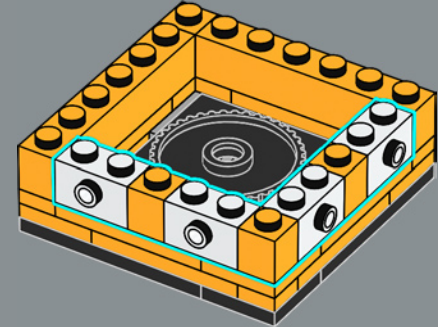

137

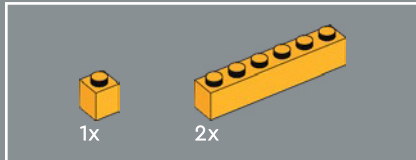
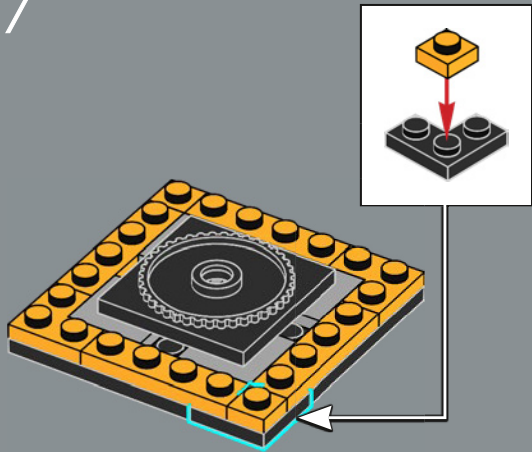

139

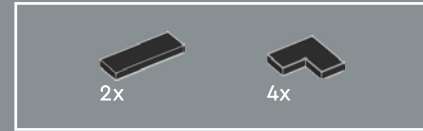
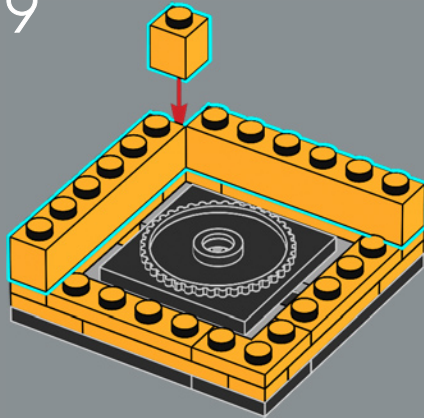

141

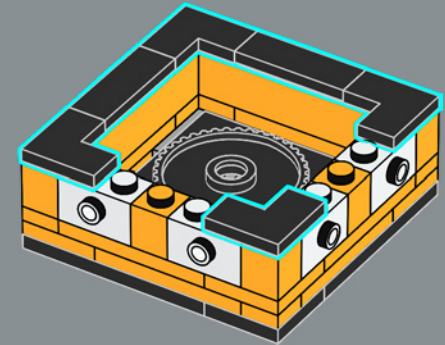



142

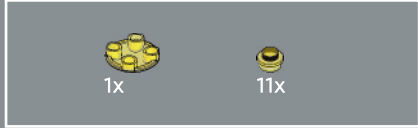
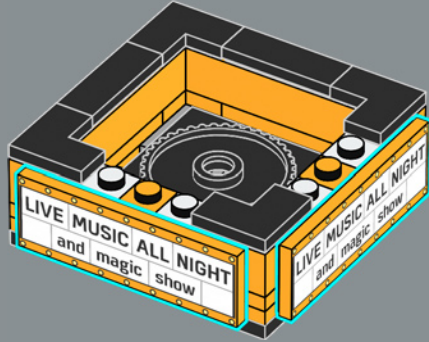

143

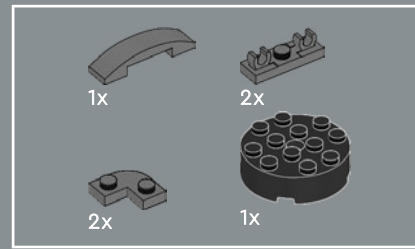
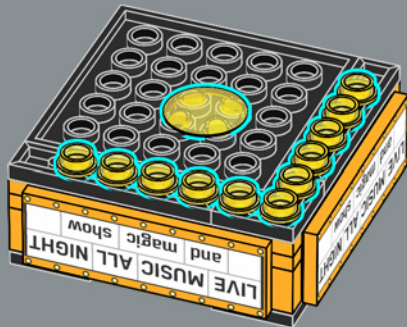

144

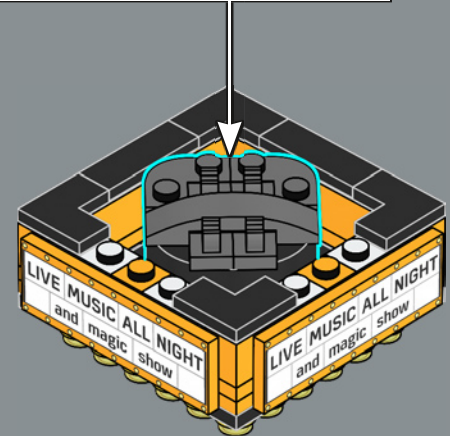
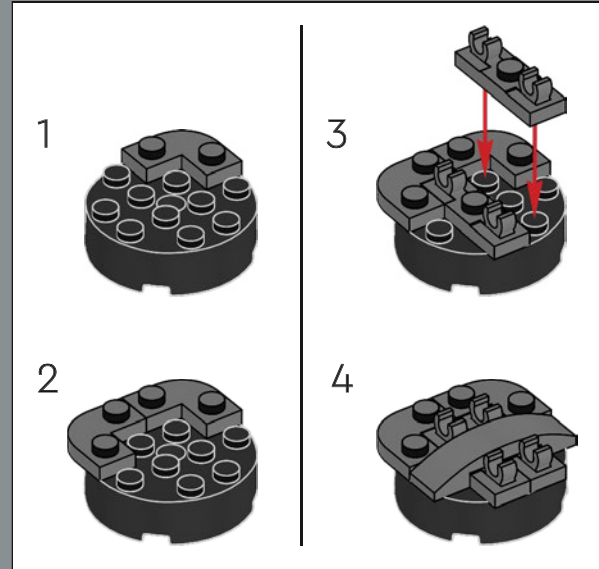

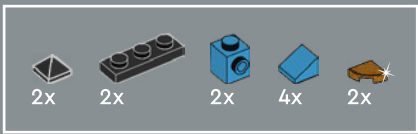

145

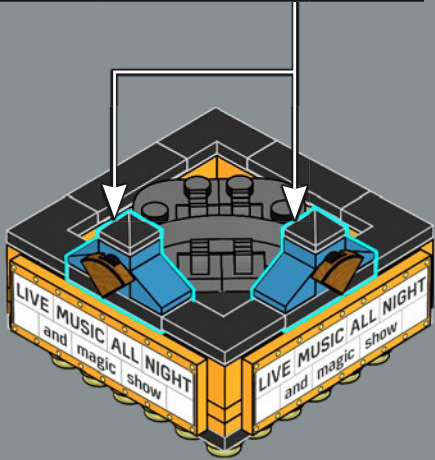
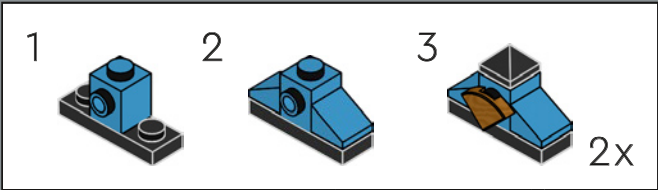

146



The Jazz Club not only supports music but all kinds of performing arts as well. Stay late enough and see what new tricks the local magician has up her sleeve.

Le club de jazz encourage non seulement la musique, mais aussi toutes sortes d'arts du spectacle. Restez assez tard pour voir quels nouveaux tours la magicienne locale a dans sa manche.

Además de apoyar la música, el Club de Jazz alberga todo tipo de artes escénicas. Si te quedas un poco más, podrás ver los nuevos trucos que la maga local tiene bajo la manga.

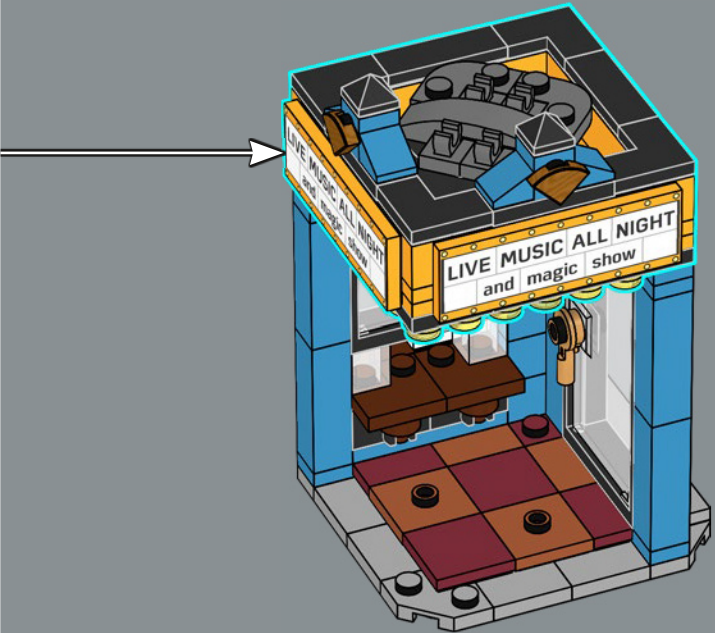

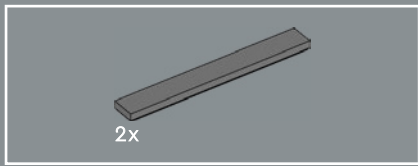

147

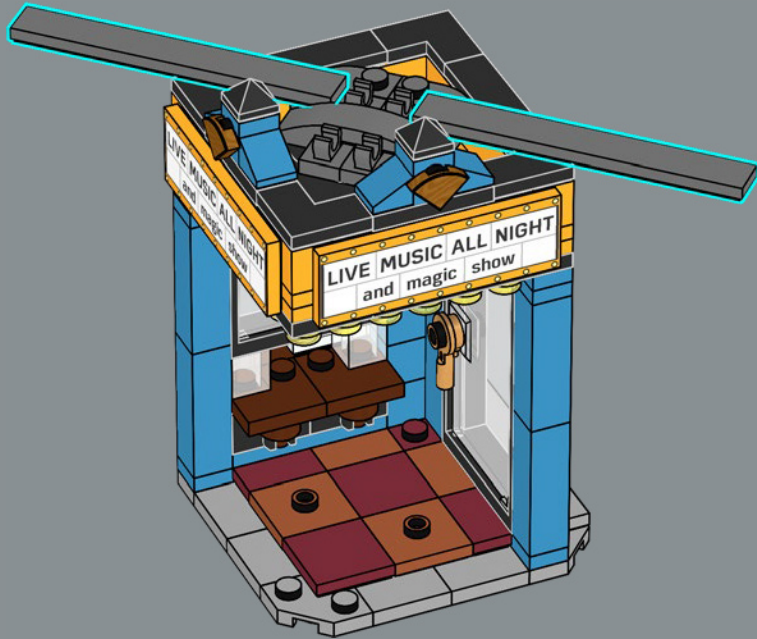

148



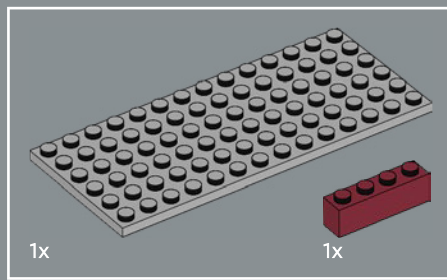

149

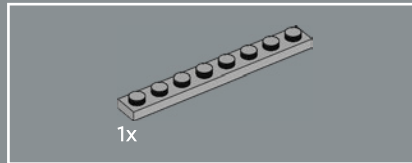
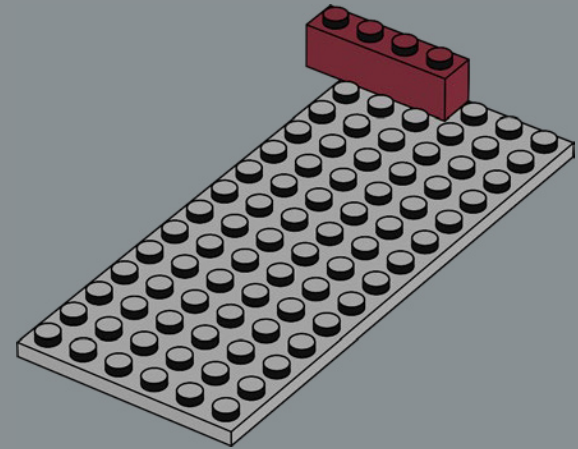

150

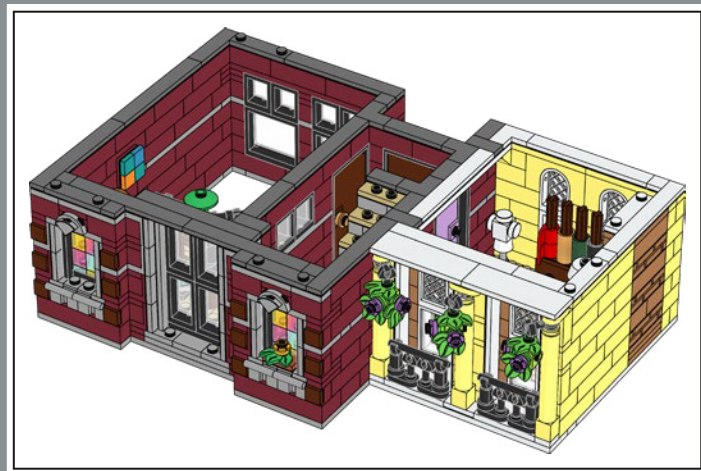
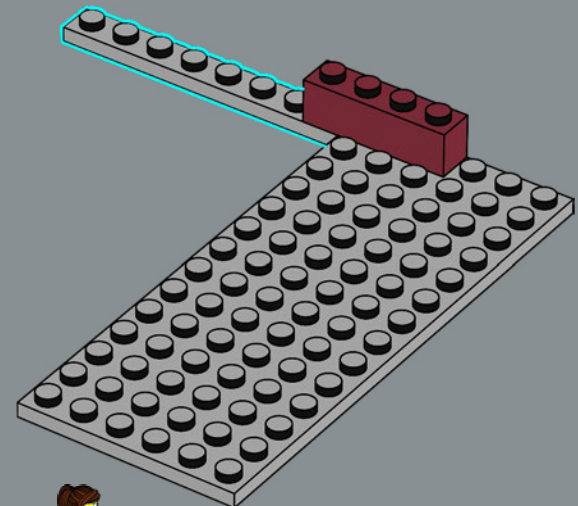

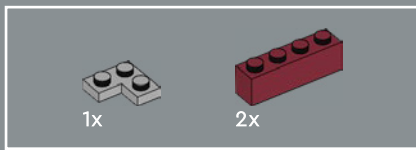

151

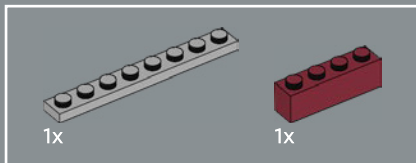
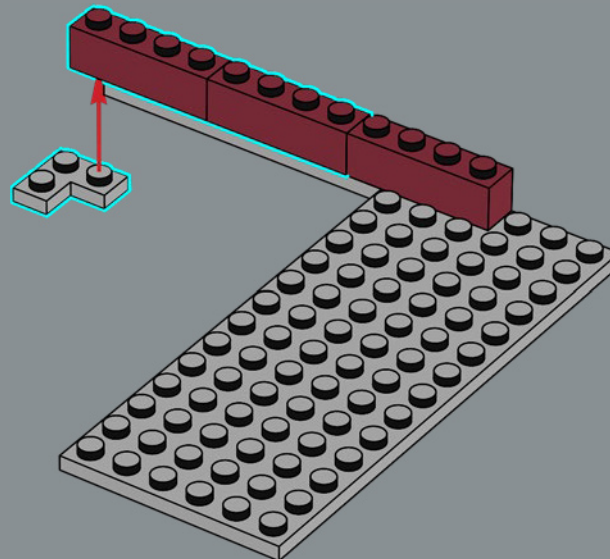

152

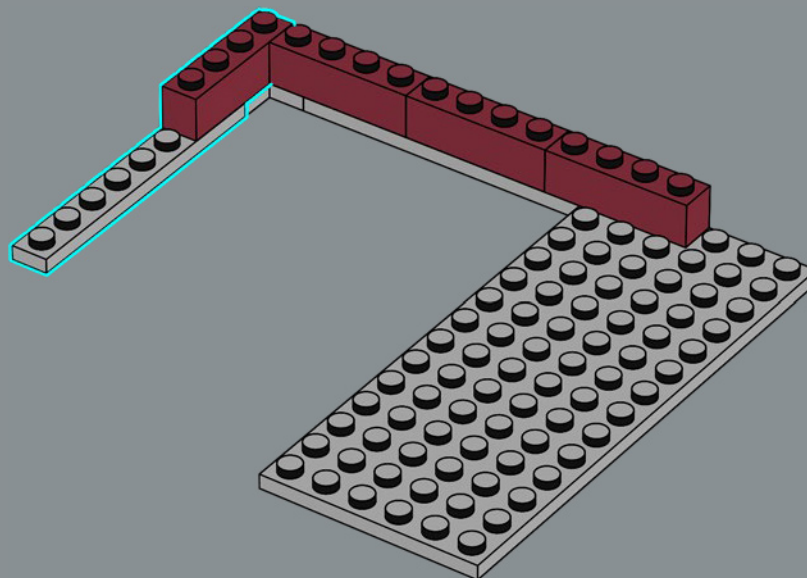

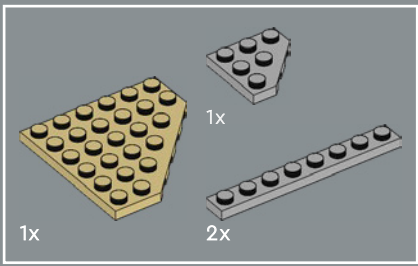

153

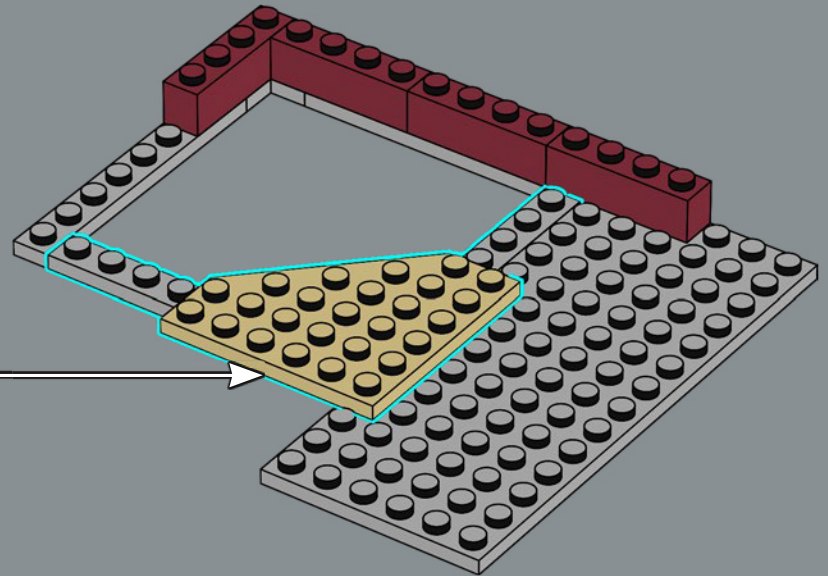
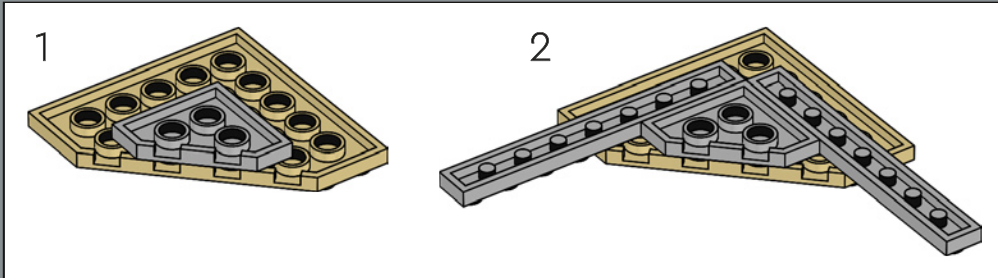

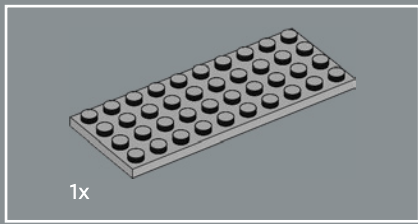

154

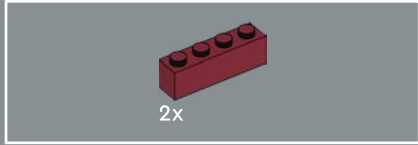
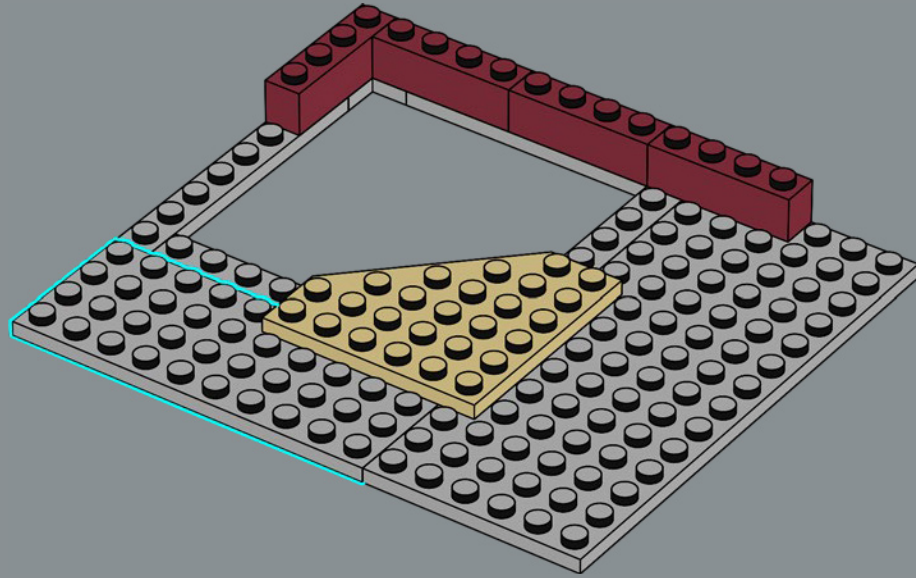

155

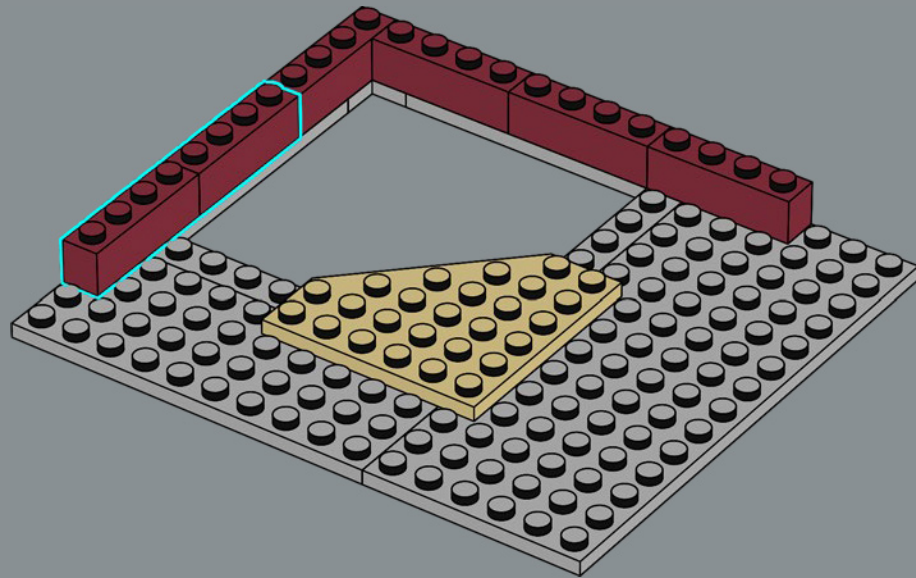

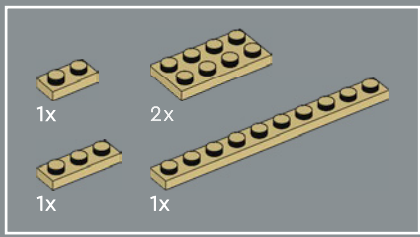

156

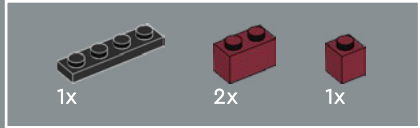
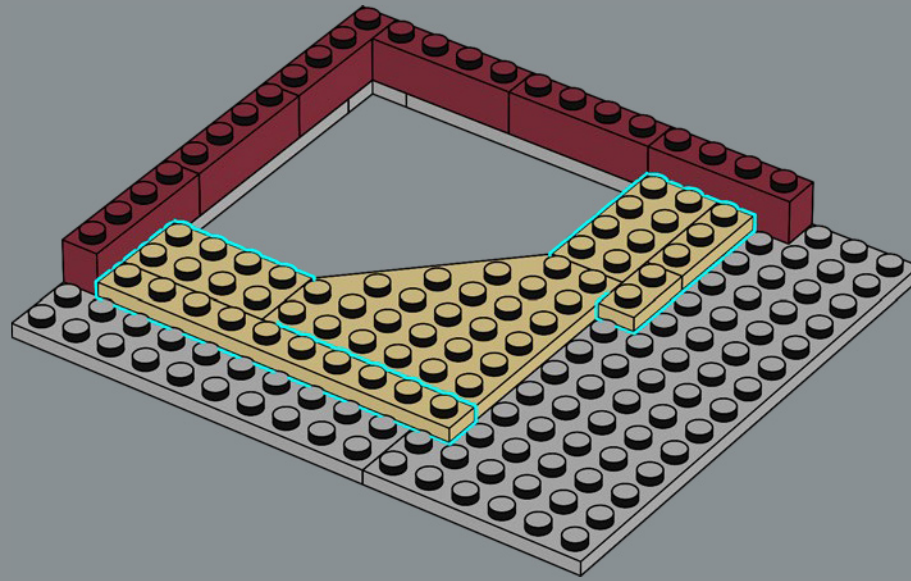

157

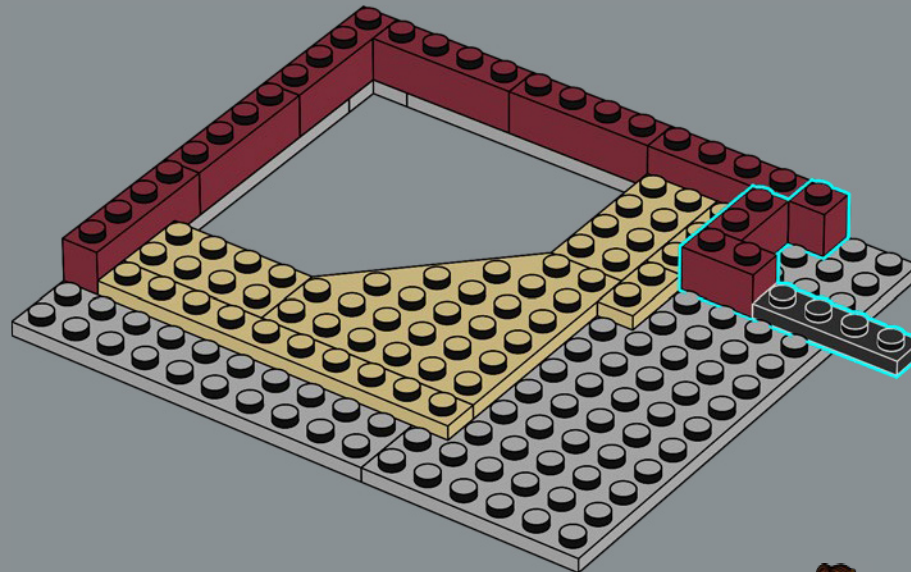

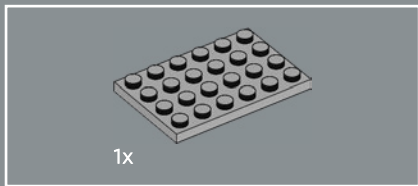

158

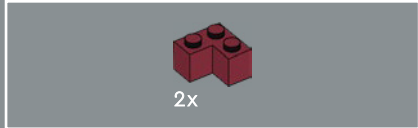
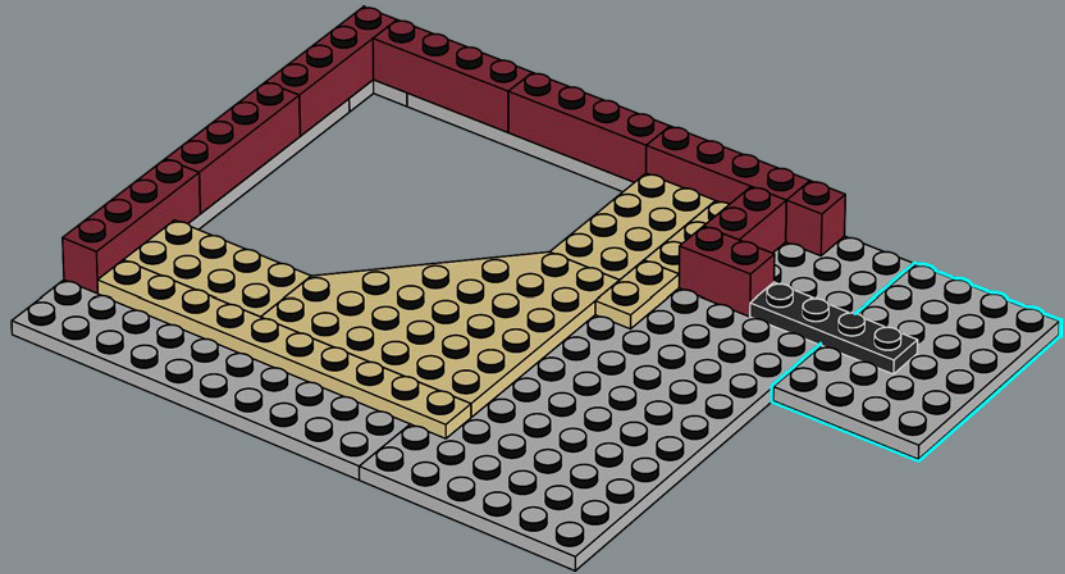

159

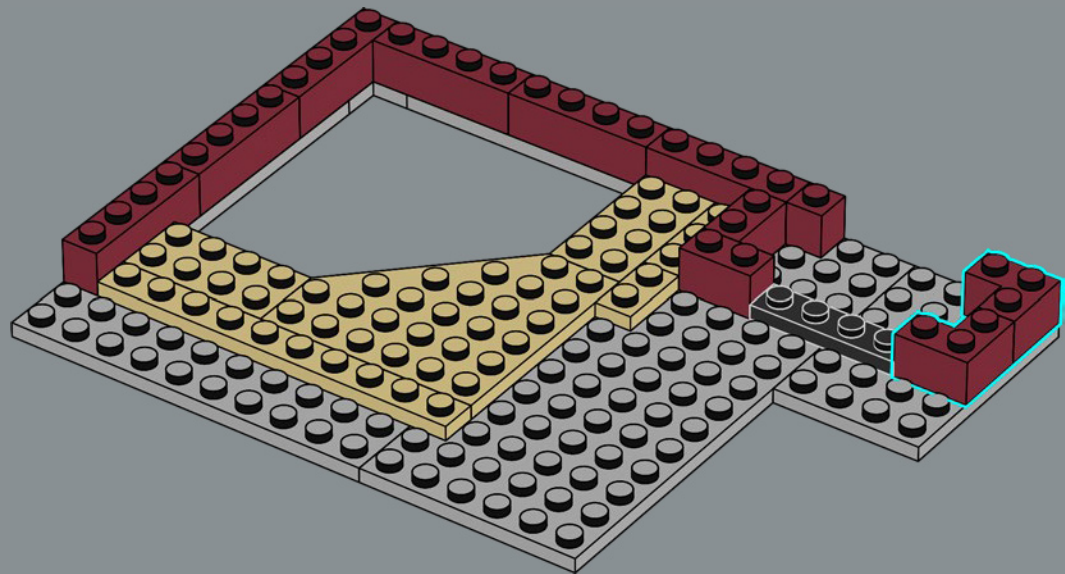

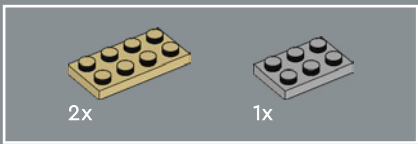

160

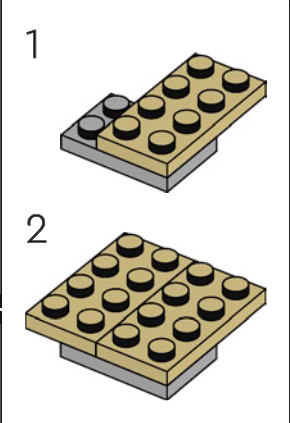
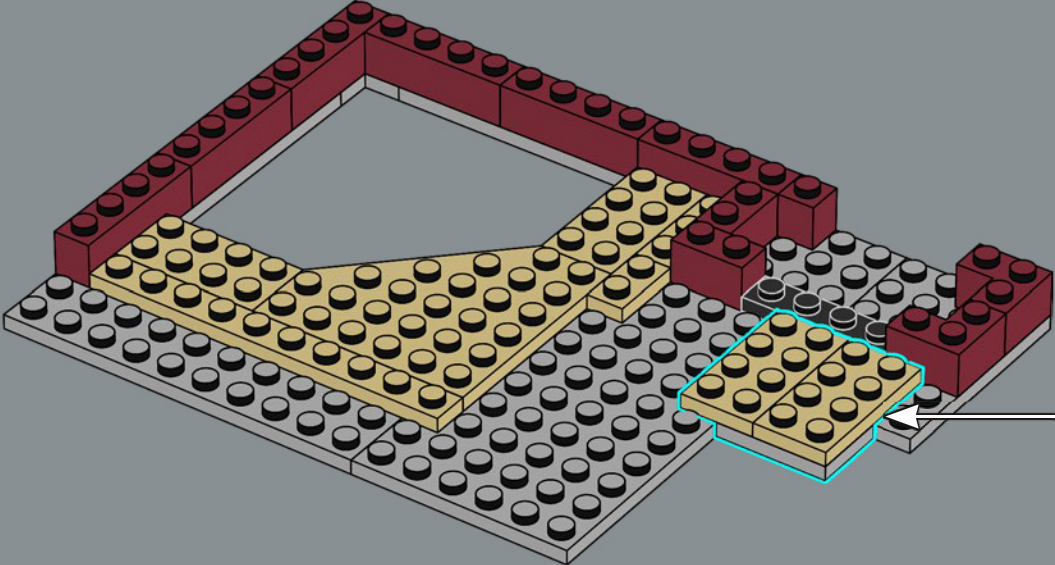

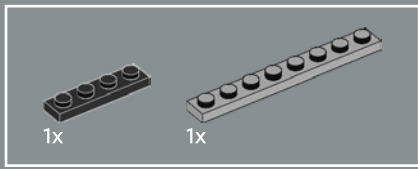

161

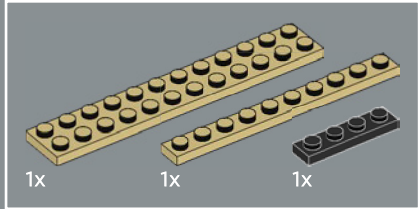
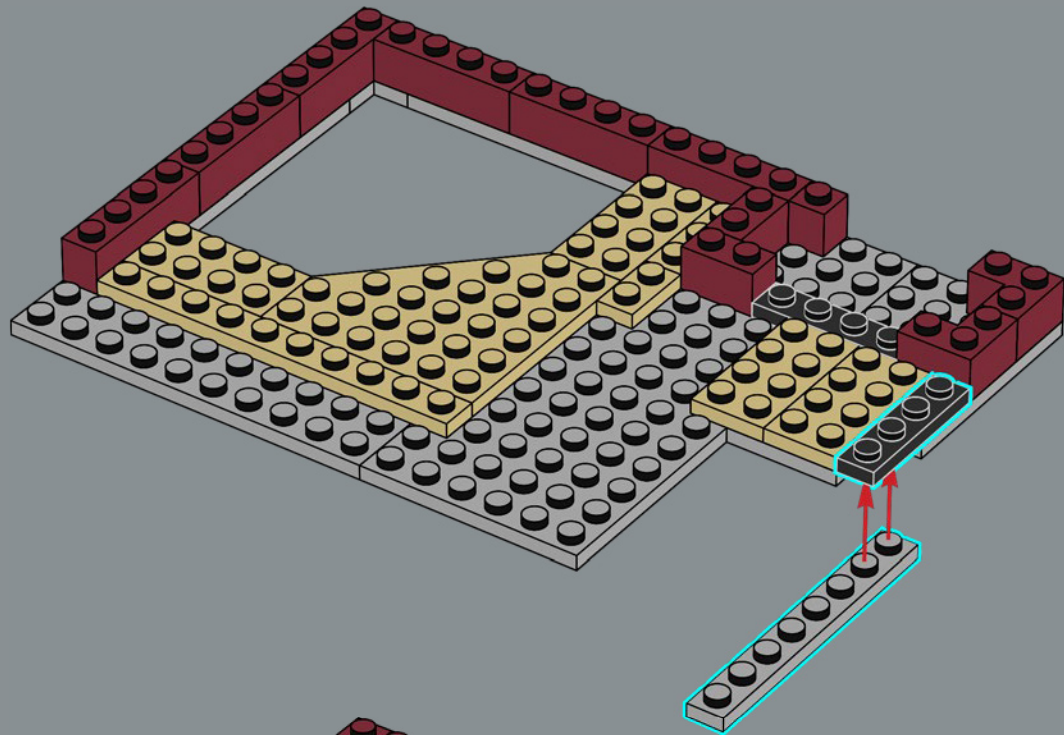

162

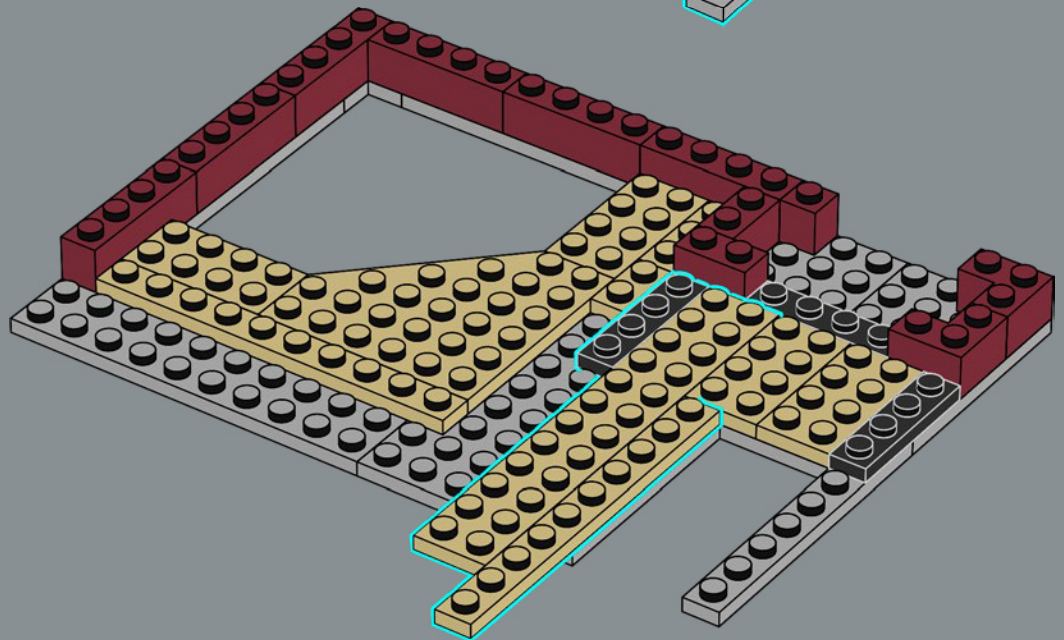

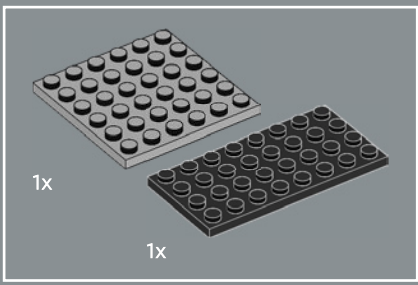

163

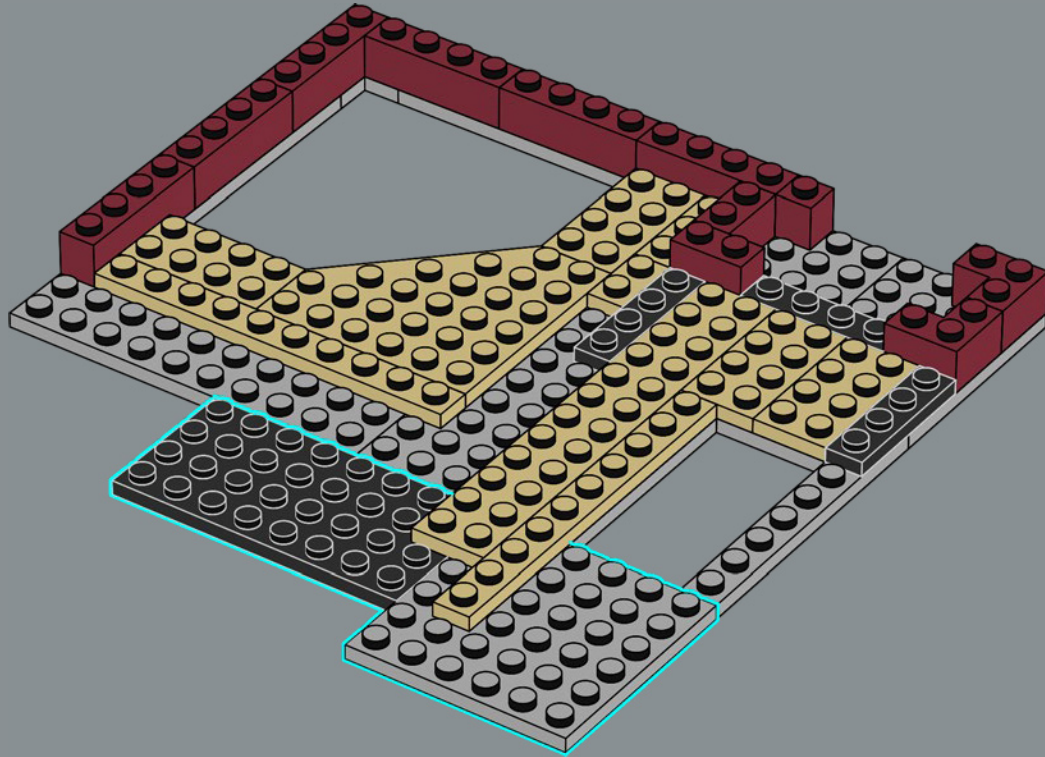

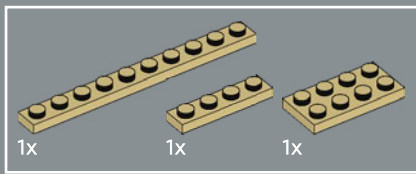

164

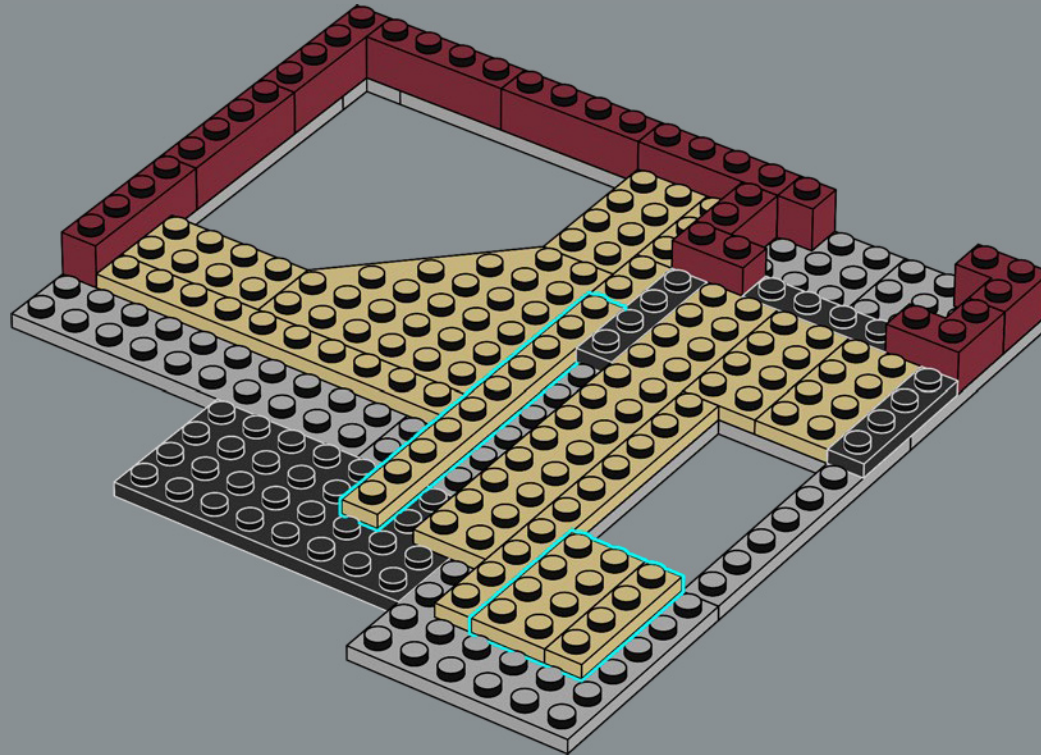

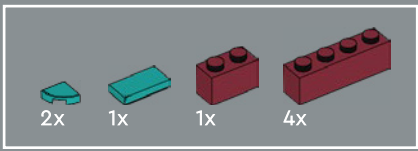

165

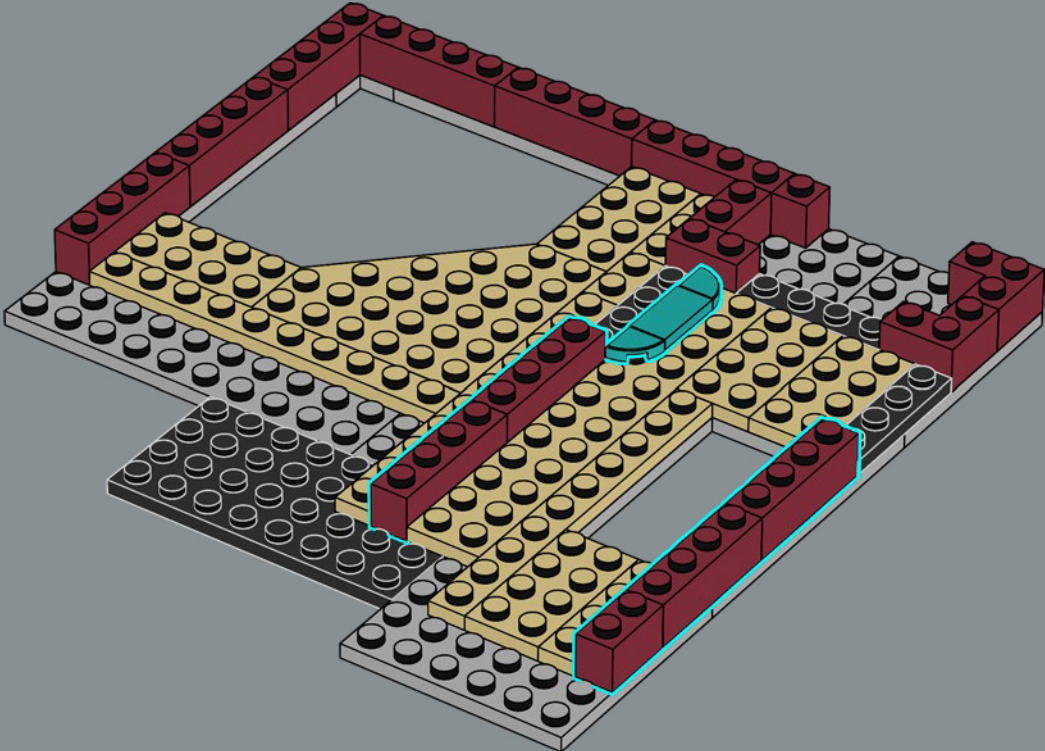

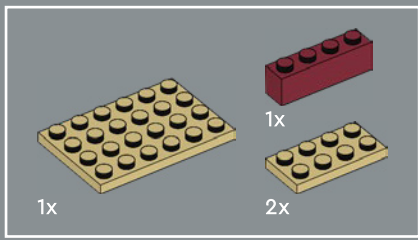

166

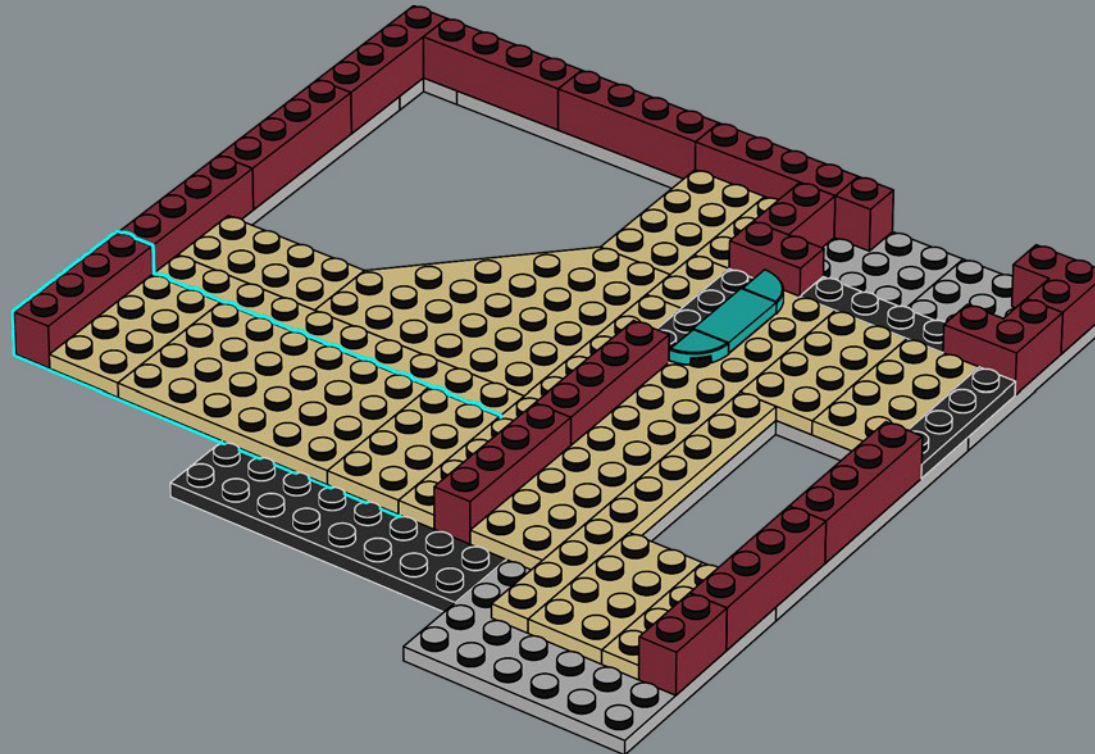

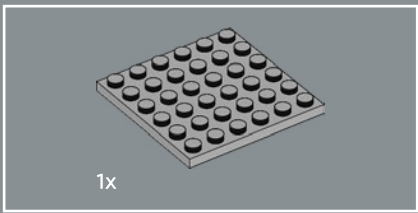

167

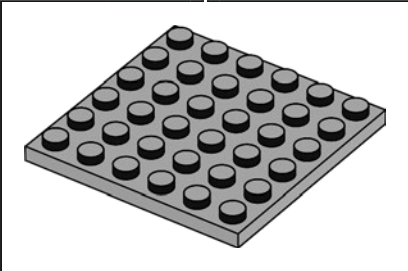
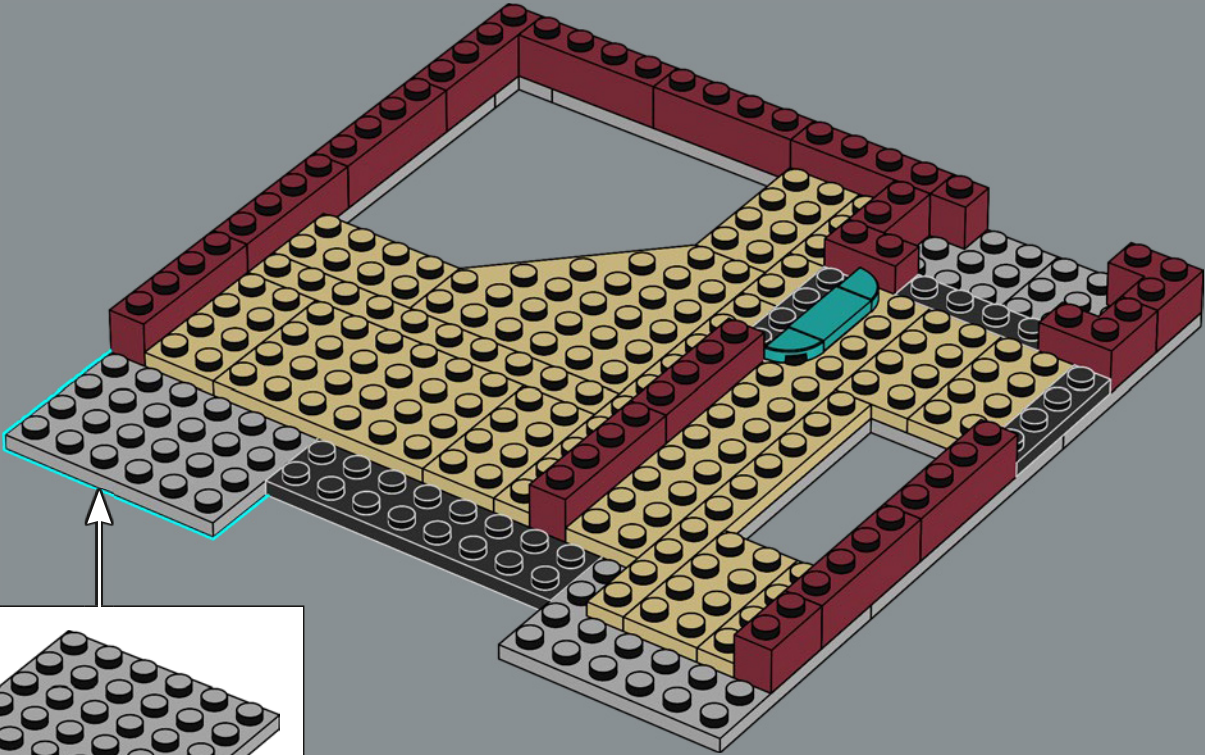

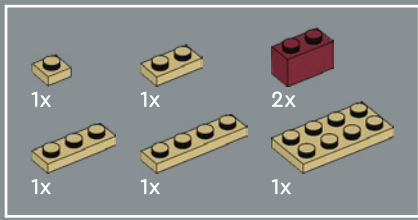

168

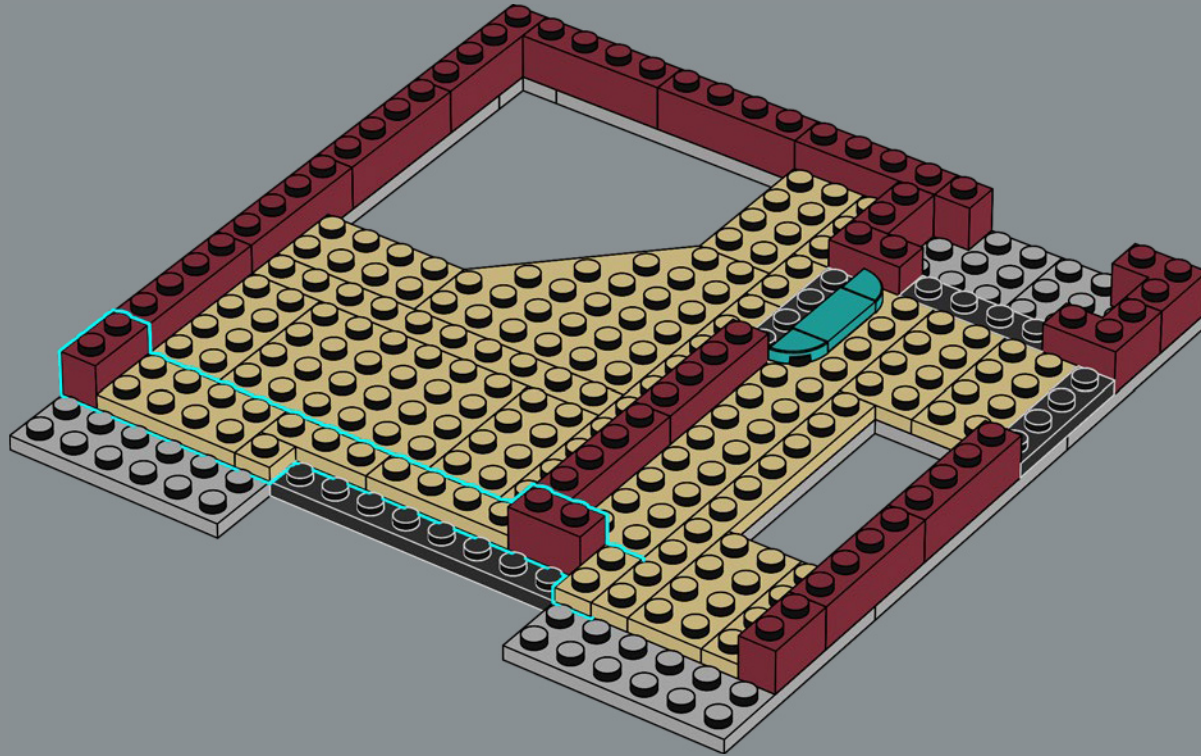

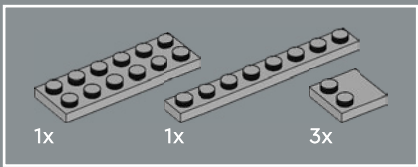

169

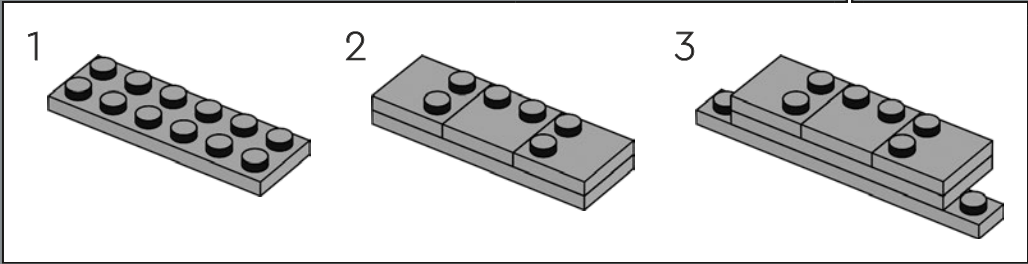
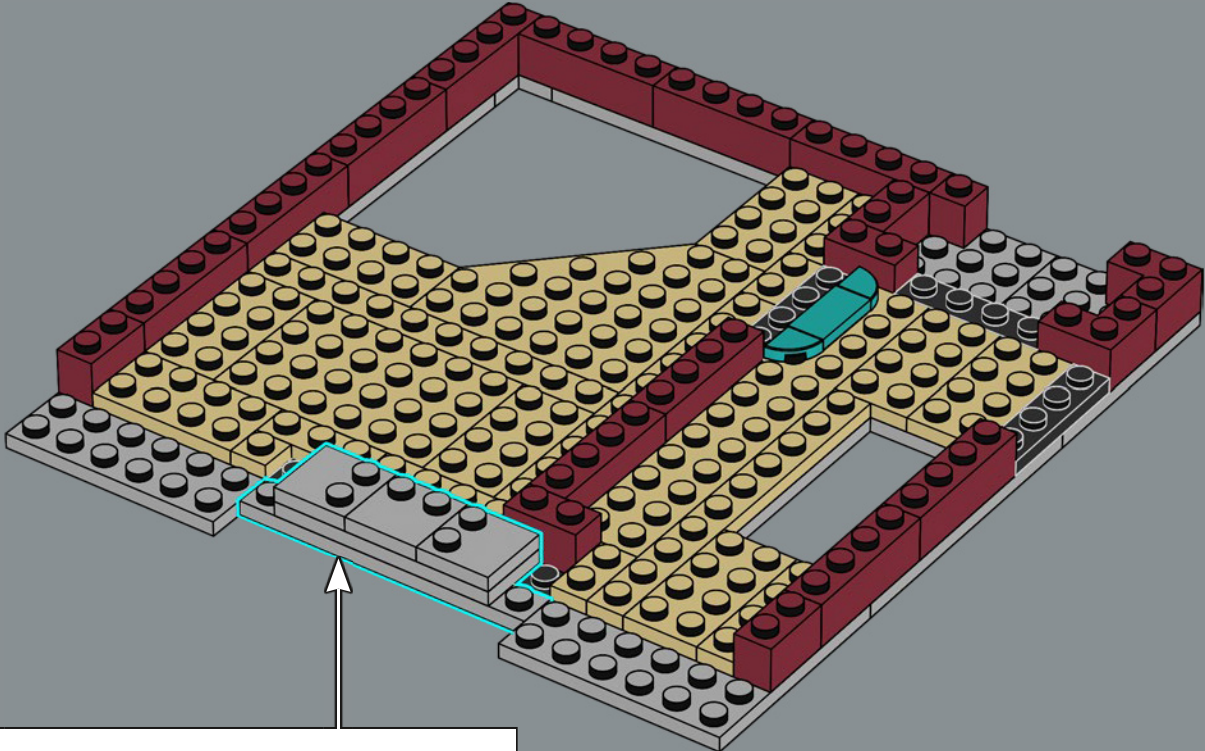

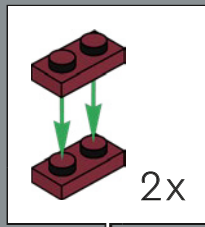
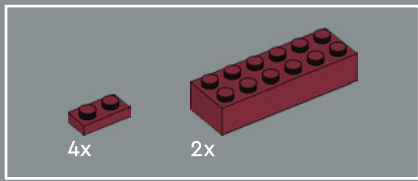

170

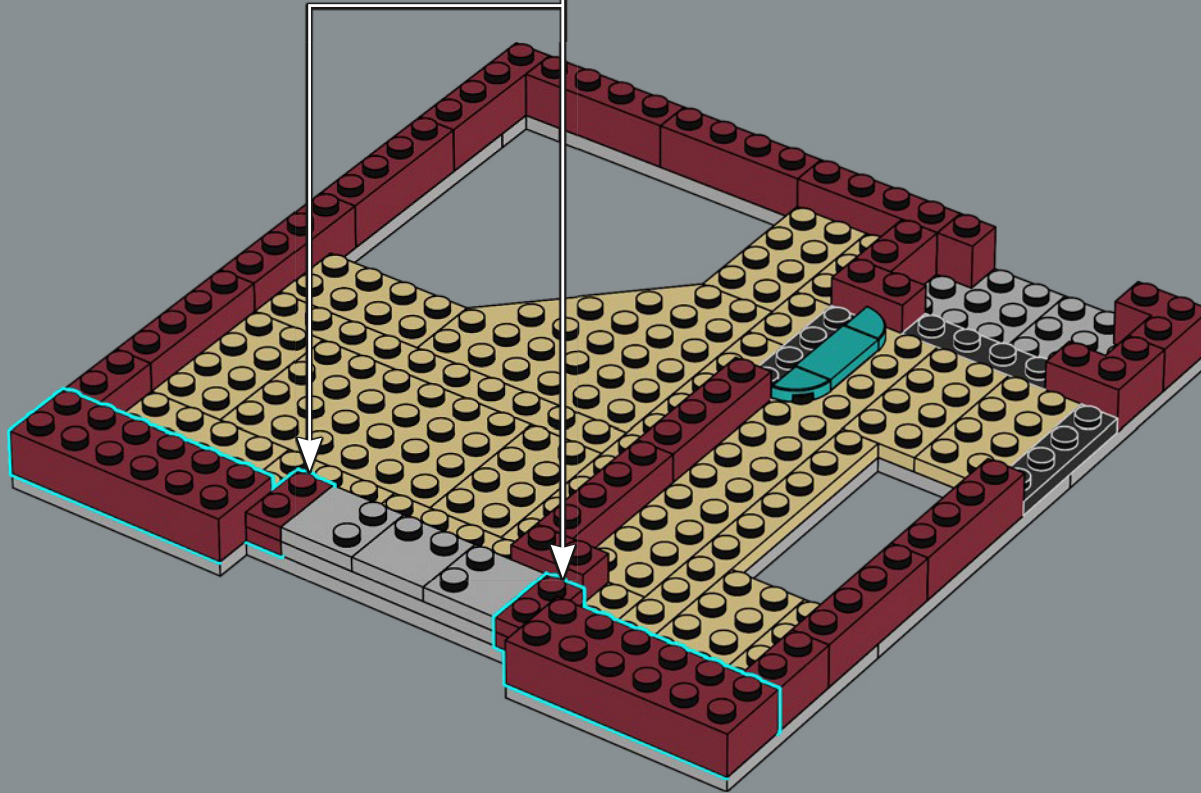

5x 4x

171

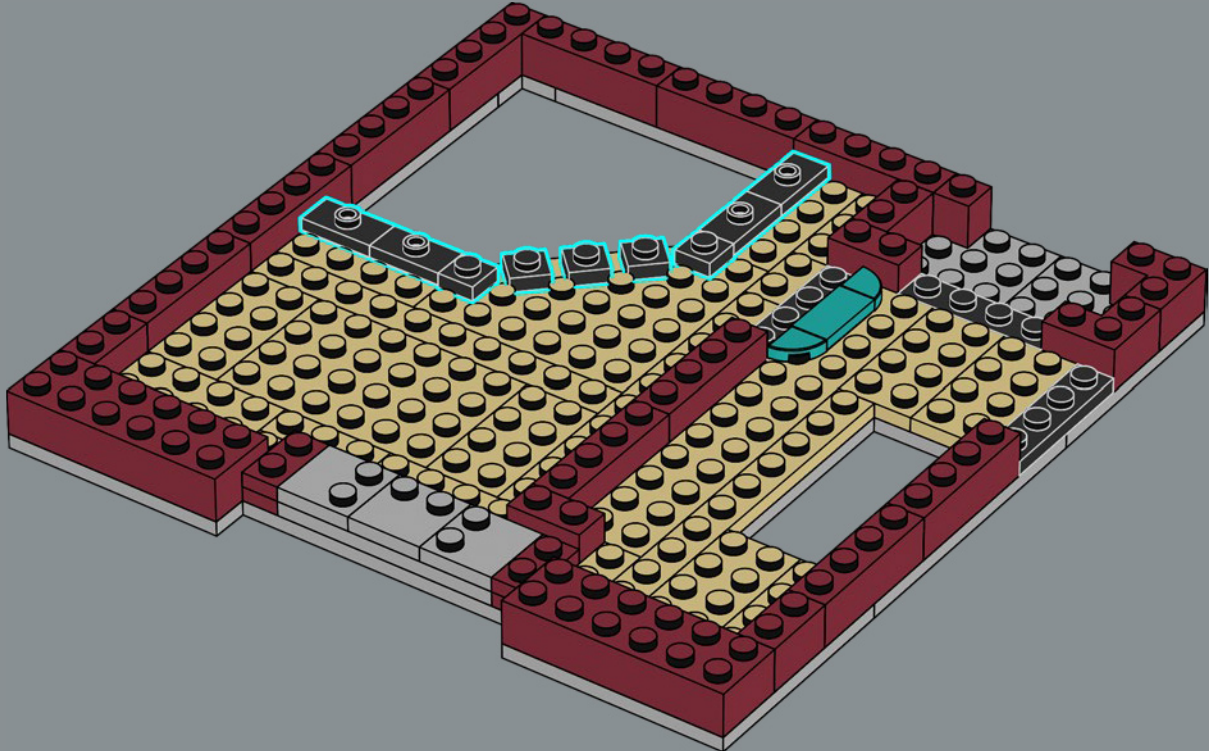

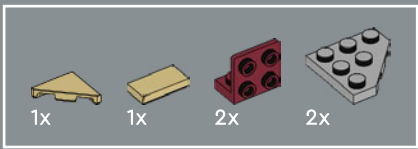

173

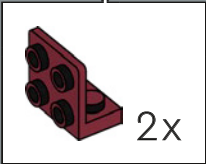
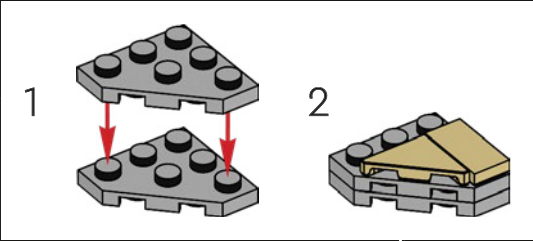
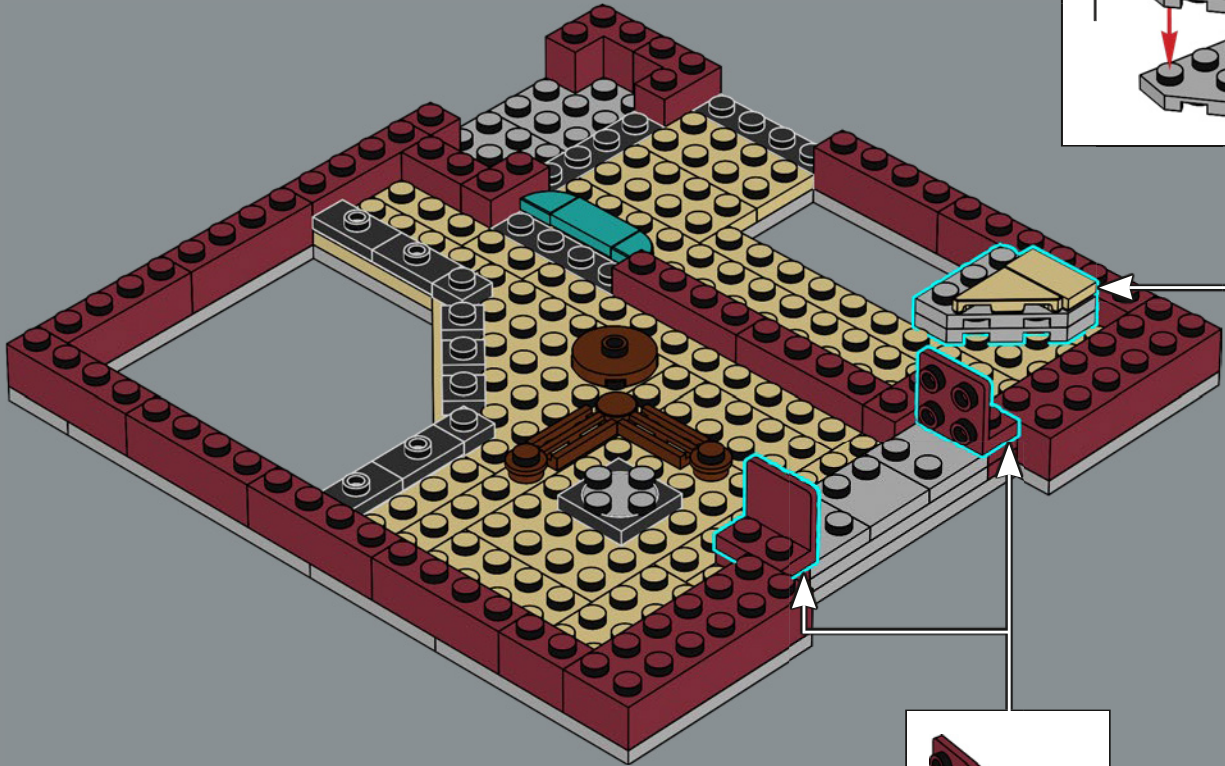

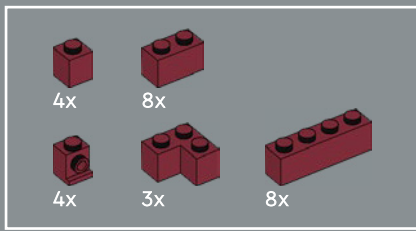

174

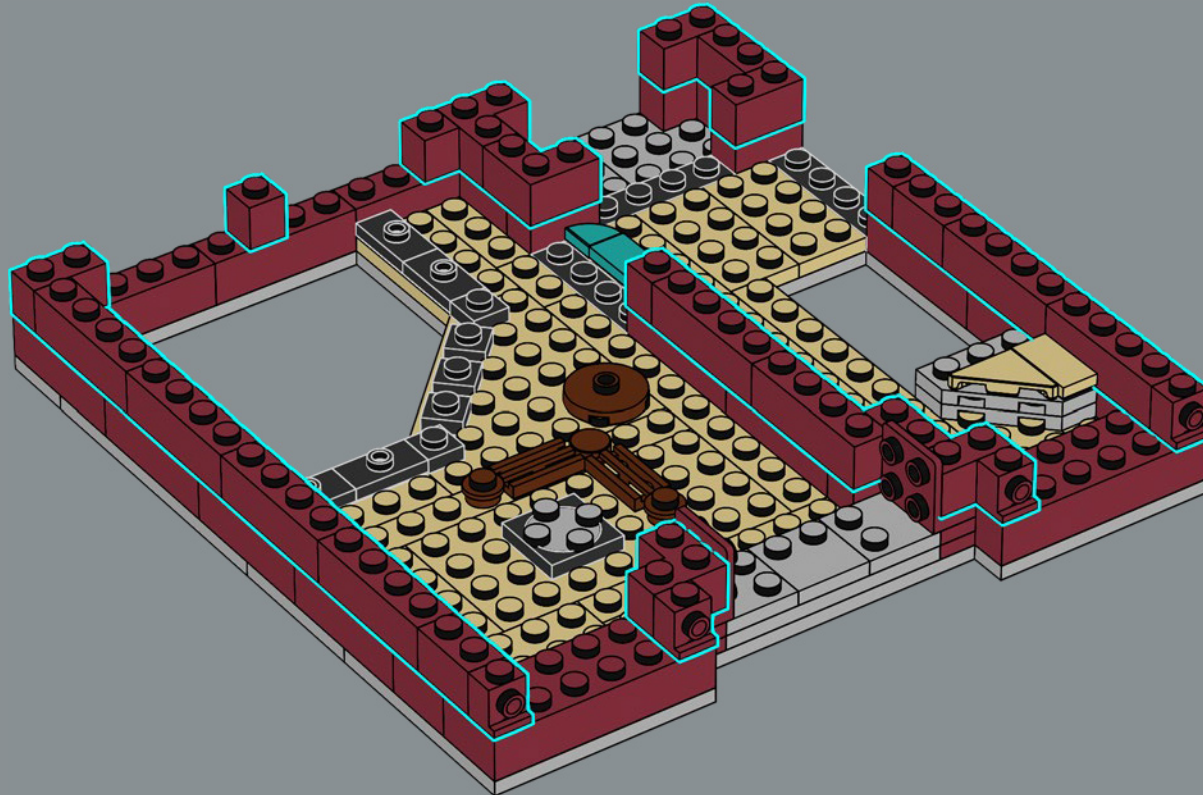

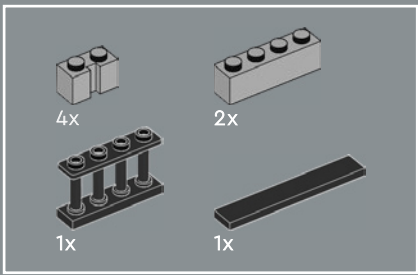

175

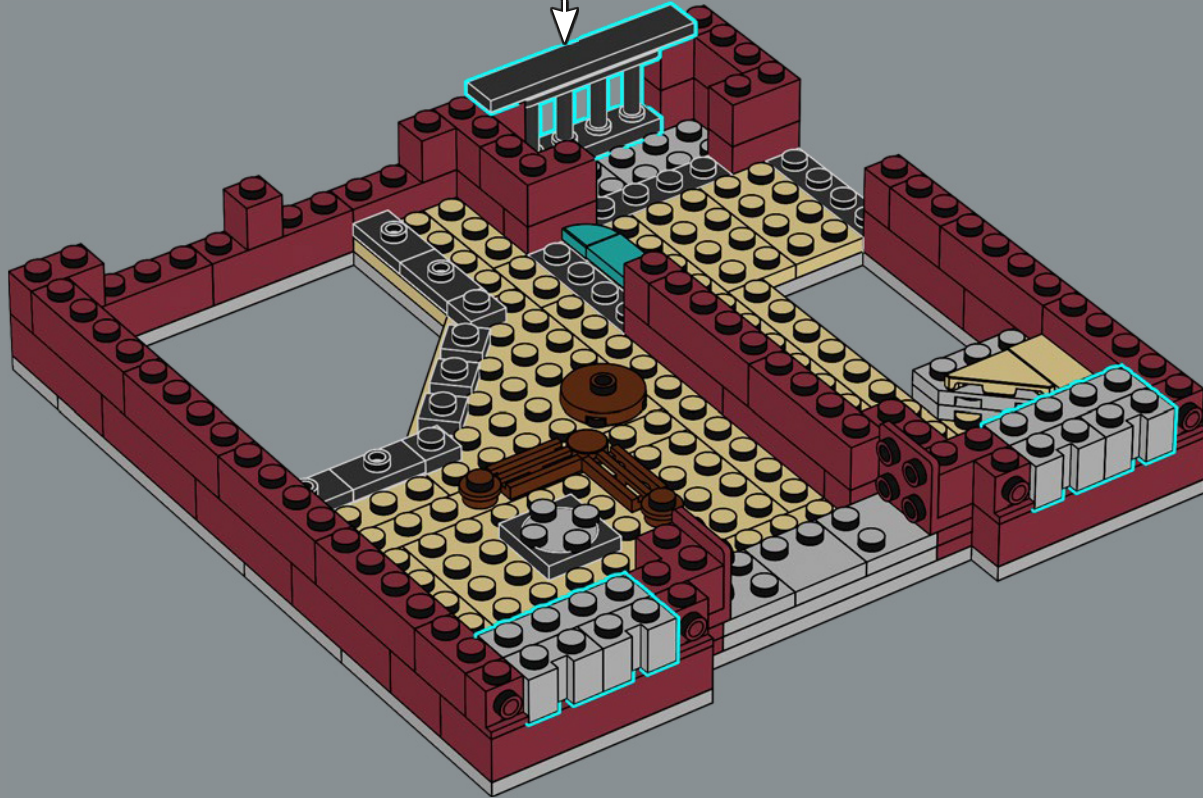
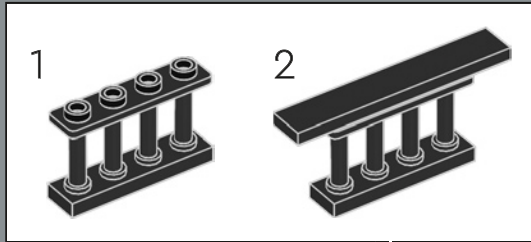

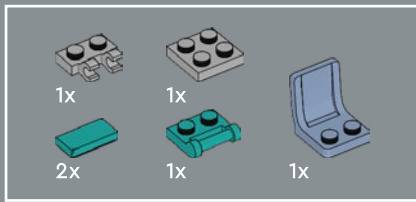

176

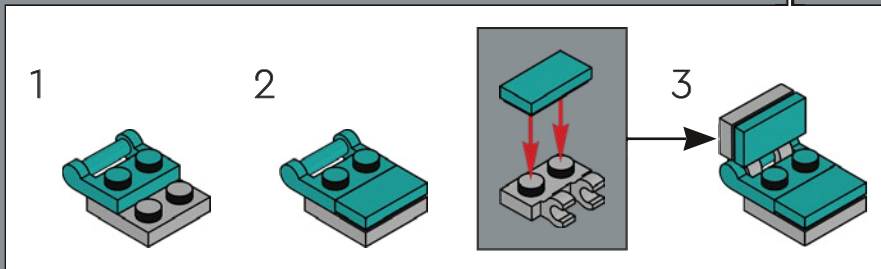
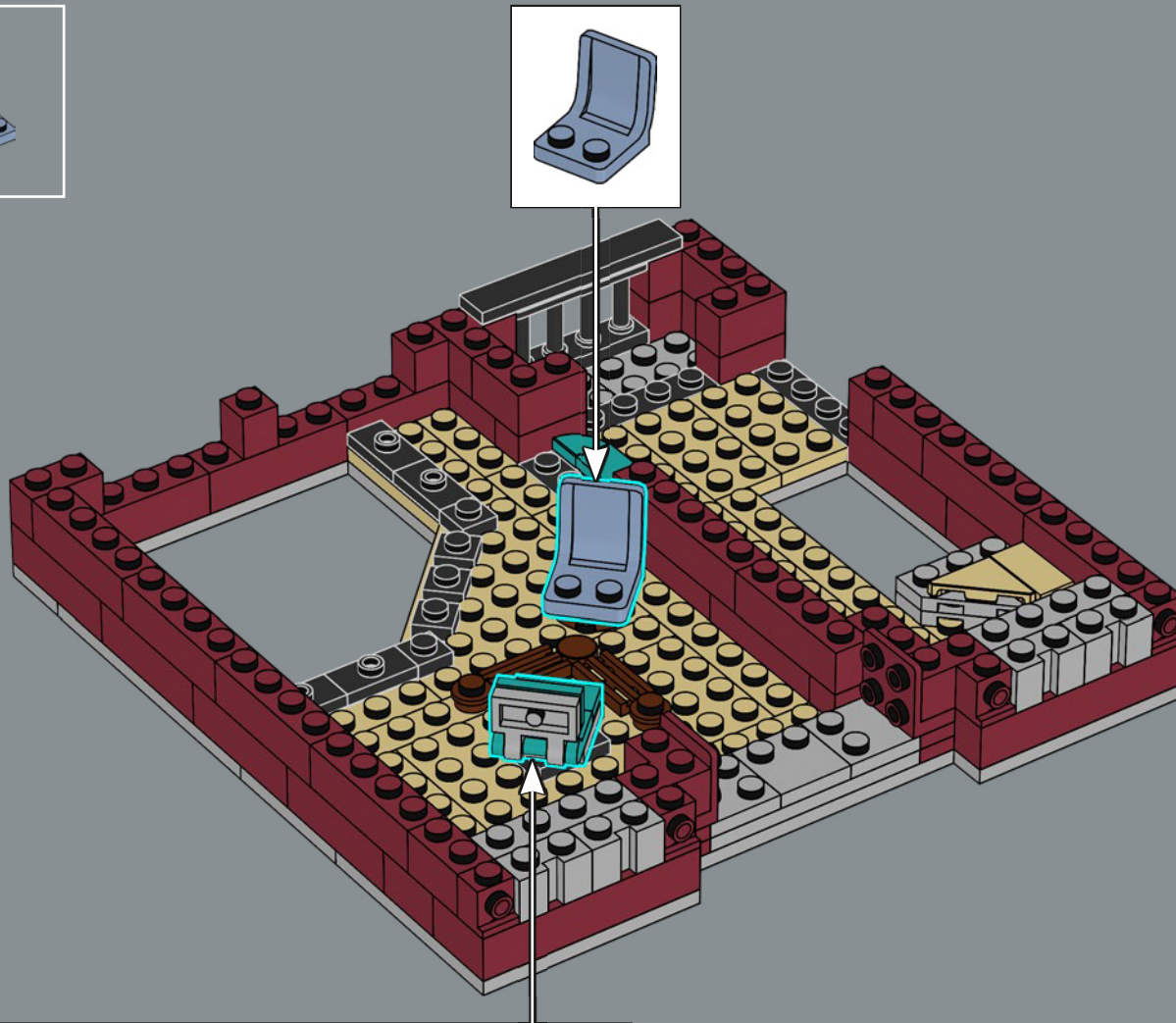



177

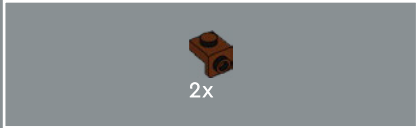
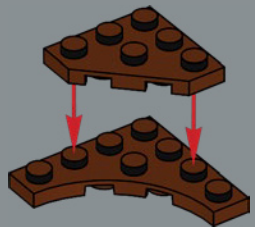

178

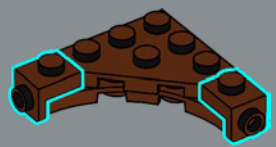

179

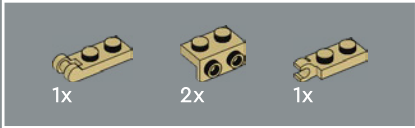
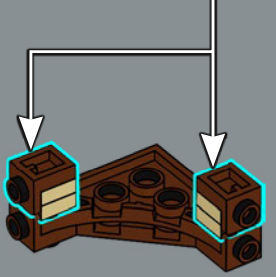
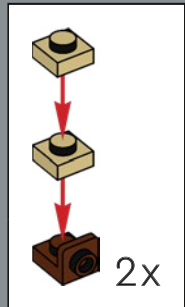

180

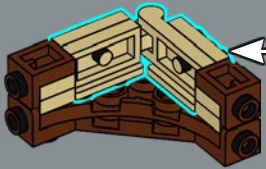
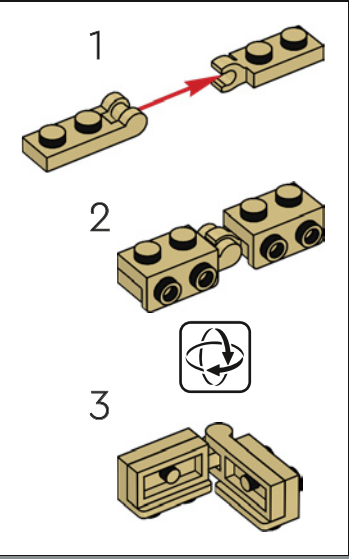

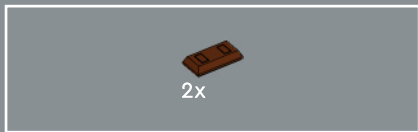

181

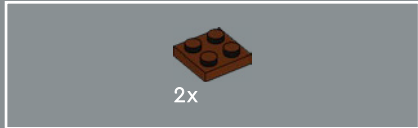
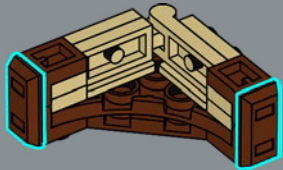

182

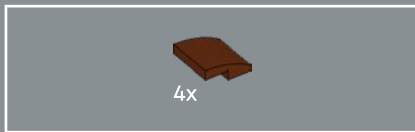
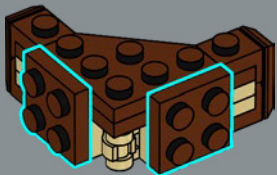

183

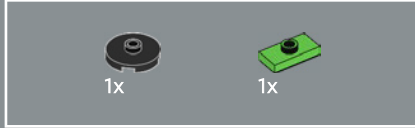
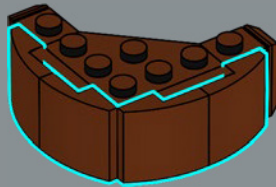

184

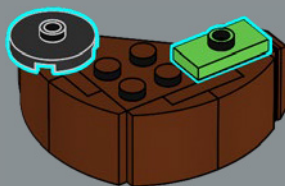

185



The club owner wanted something special for her office, so she ordered this unusual desk that is oriented to a 45-degree angle.

La propriétaire du club voulait une touche originale pour son bureau. Elle a donc commandé ce bureau inhabituel, orienté à un angle de 45 degrés.

La propietaria del club quería hacer que su oficina fuera muy especial, así que la equipó con un singular escritorio orientado a 45°.

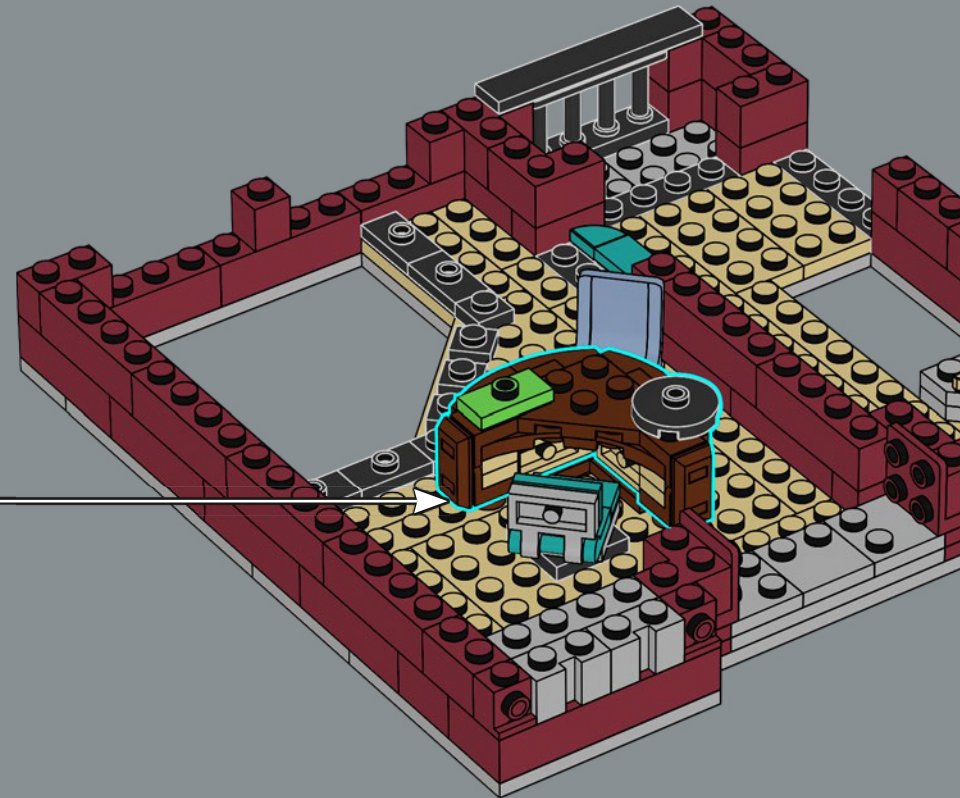

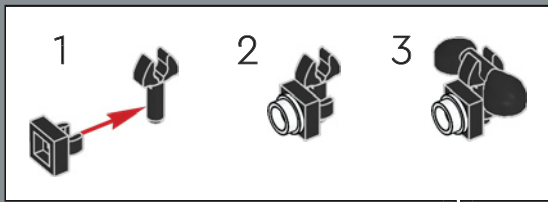

186

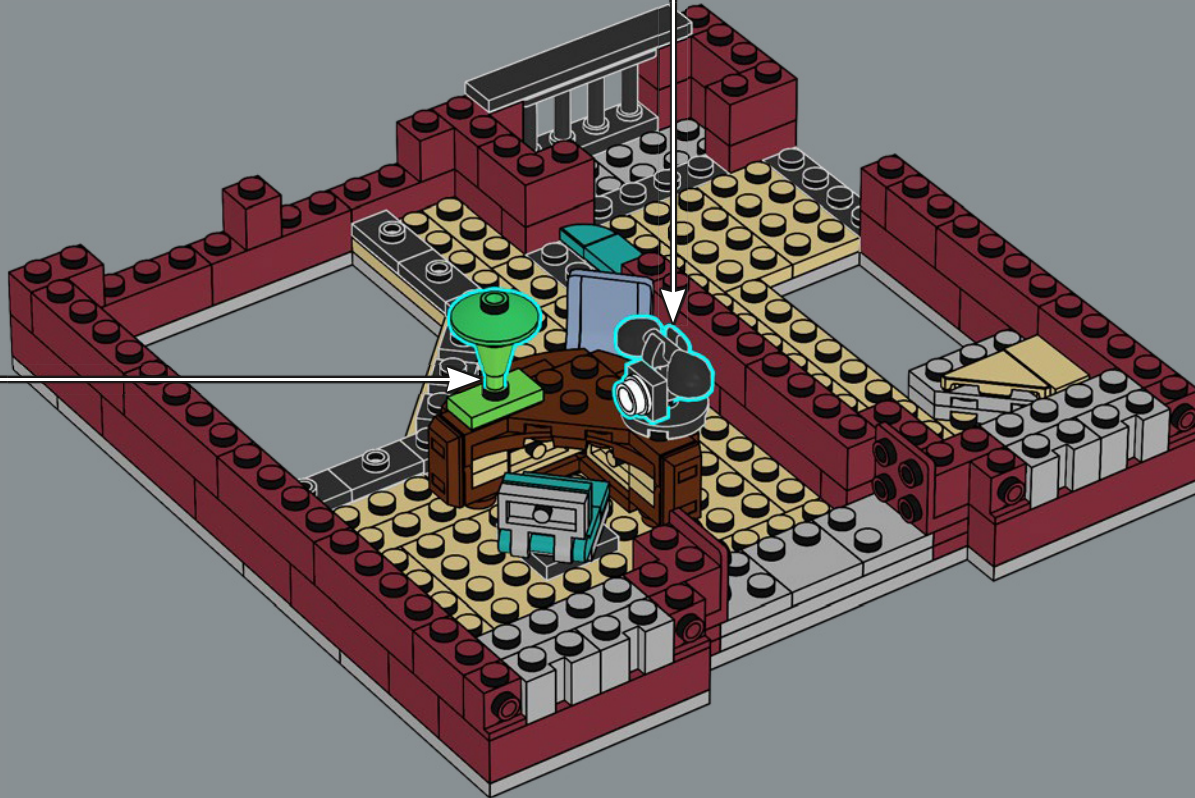
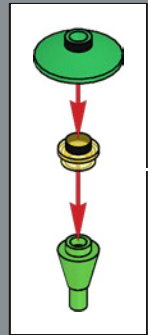



The club owner loves spotting up-and-coming artists and giving them a chance to shine on stage. She was one of the first to recognize the talent of the saxophone player from the LEGO® 10255 Assembly Square.

La propriétaire du club adore repérer les artistes prometteurs et leur donner une chance de briller sur scène. Elle a été l'une des premières à reconnaître le talent du saxophoniste de la Place de l'assemblée LEGO® 10255.

A la propietaria del club le encanta descubrir nuevos artistas y darles la oportunidad de brillar en el escenario. Ella se encuentra entre quienes más tempranamente reconocieron el talento del saxofonista de la Gran Plaza LEGO® (10255).

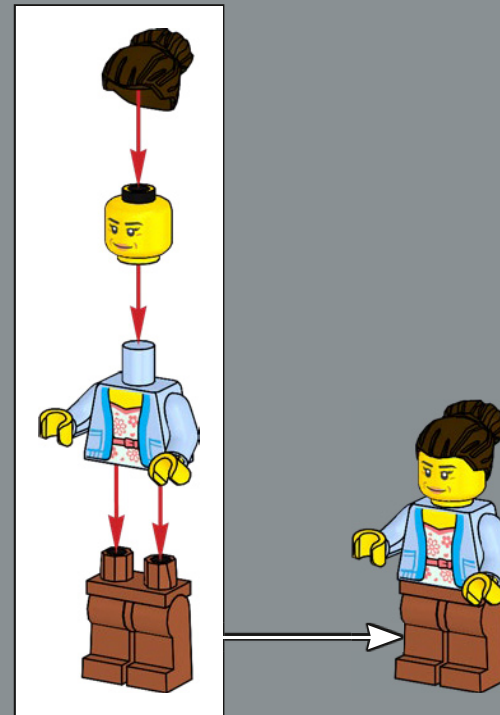



187

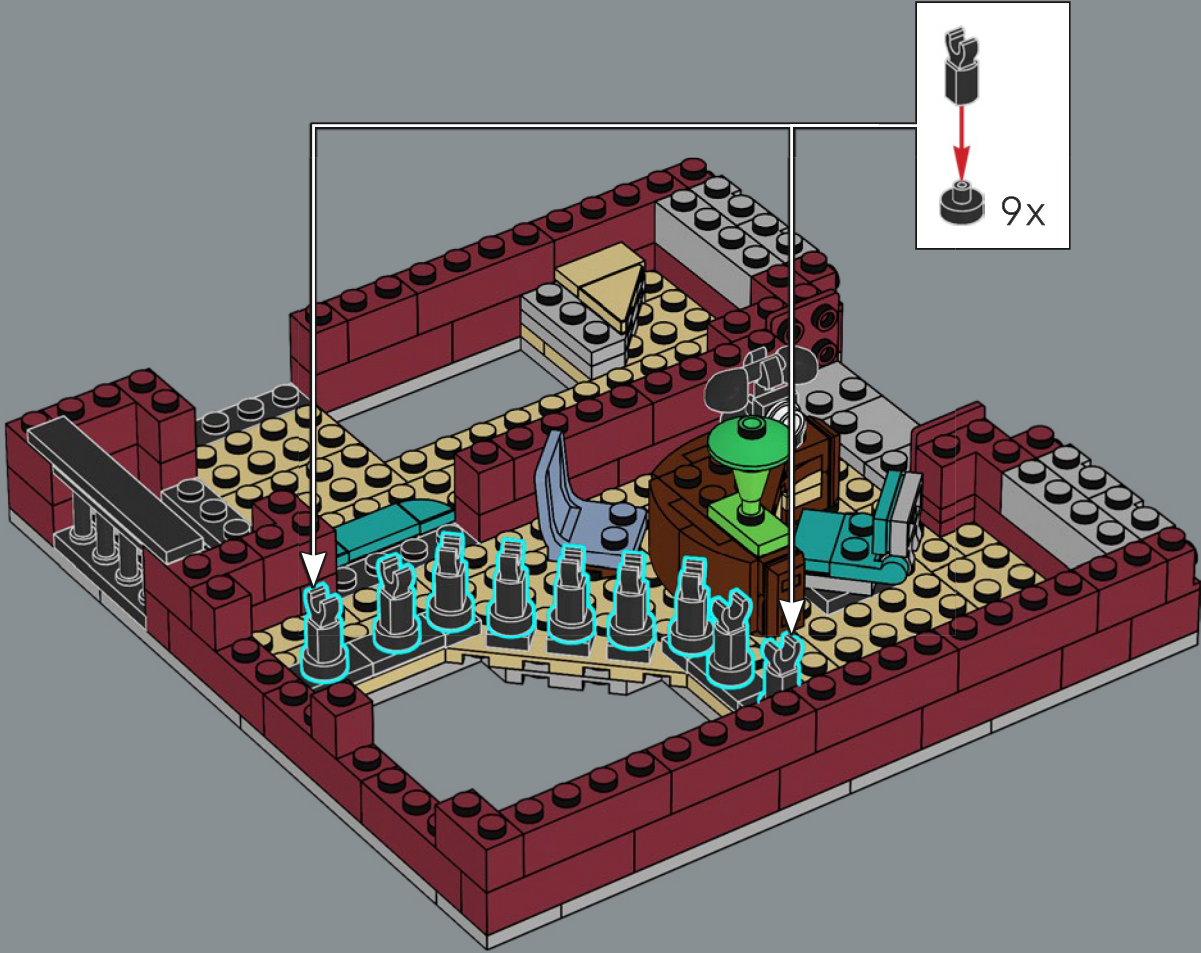

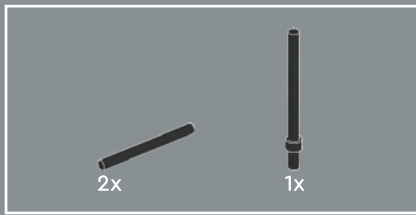

188

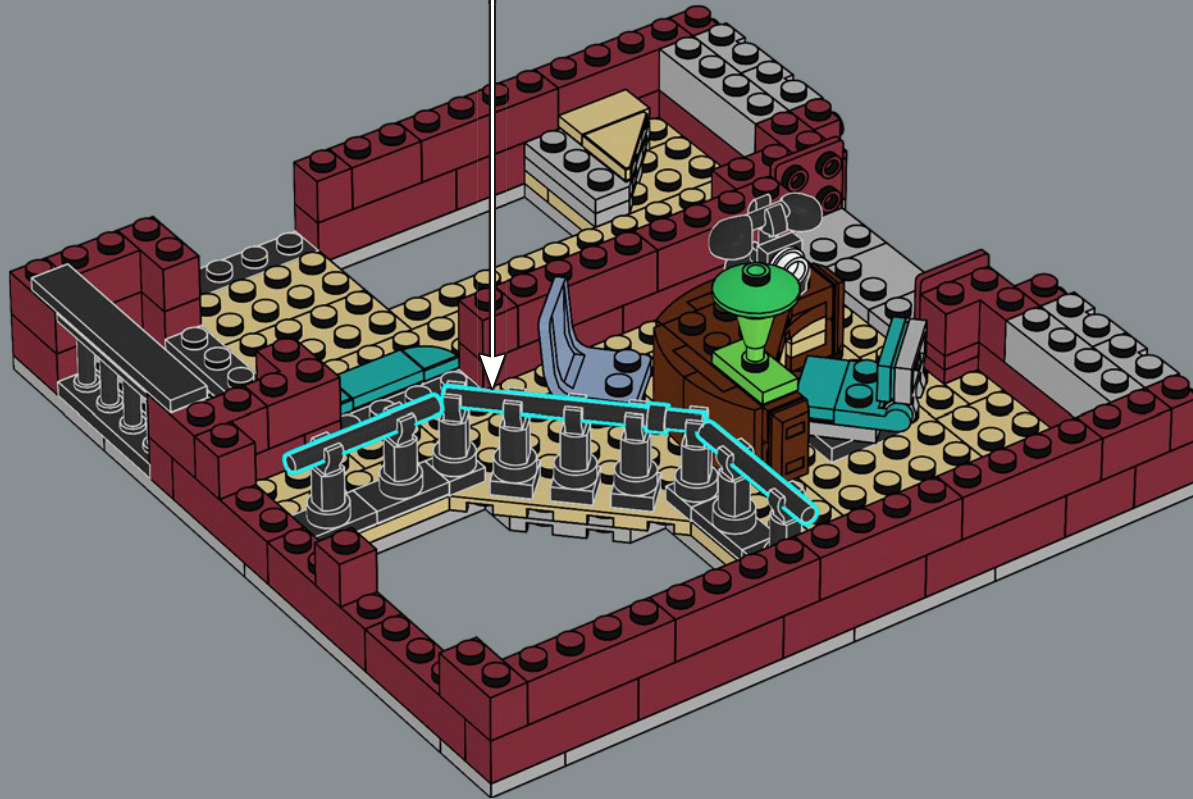

The manager has her own private balcony where she can listen in on the evening's performances.

La gérante dispose de son propre balcon privé où elle peut assister aux spectacles de la soirée.

La encargada tiene su propio balcón desde donde puede escuchar las actuaciones de cada noche.

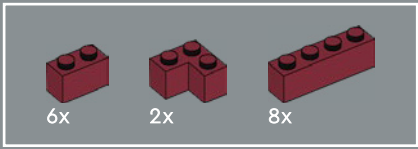

189

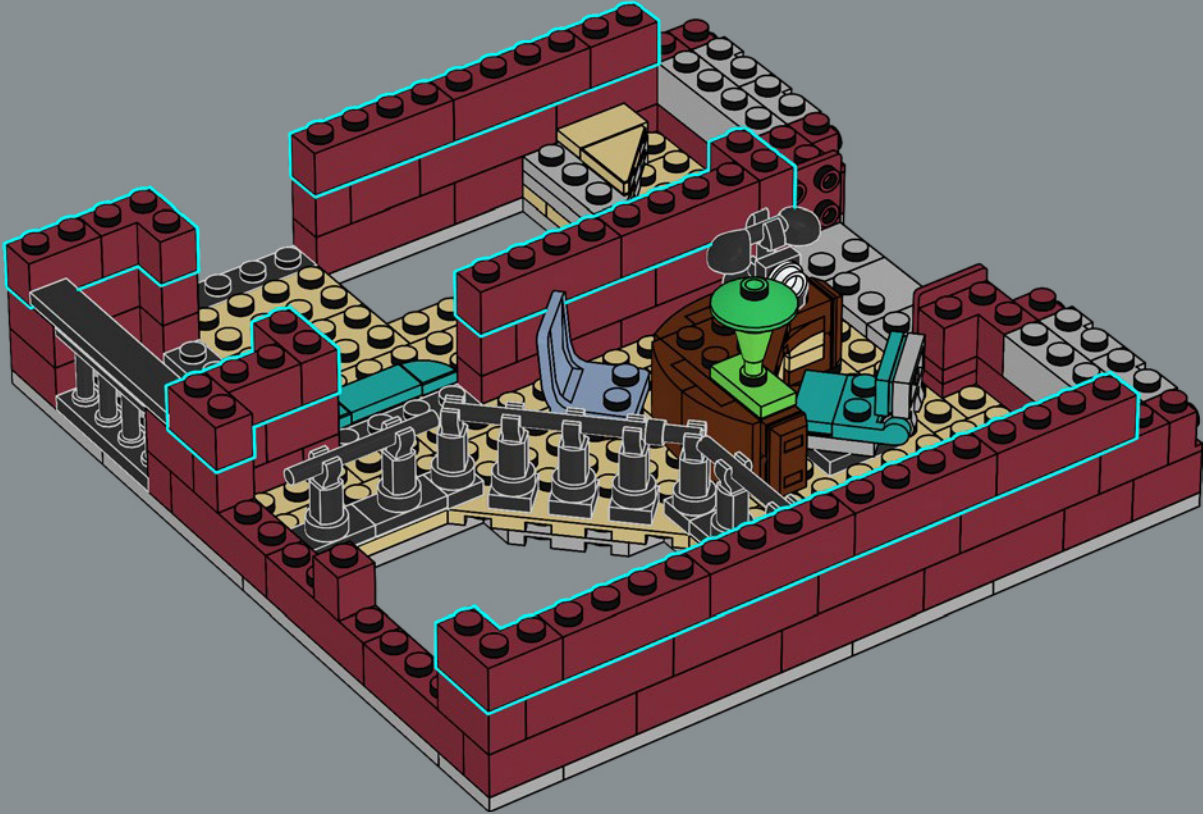

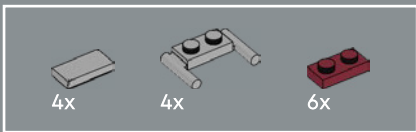

190

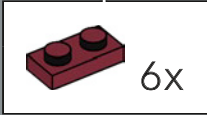
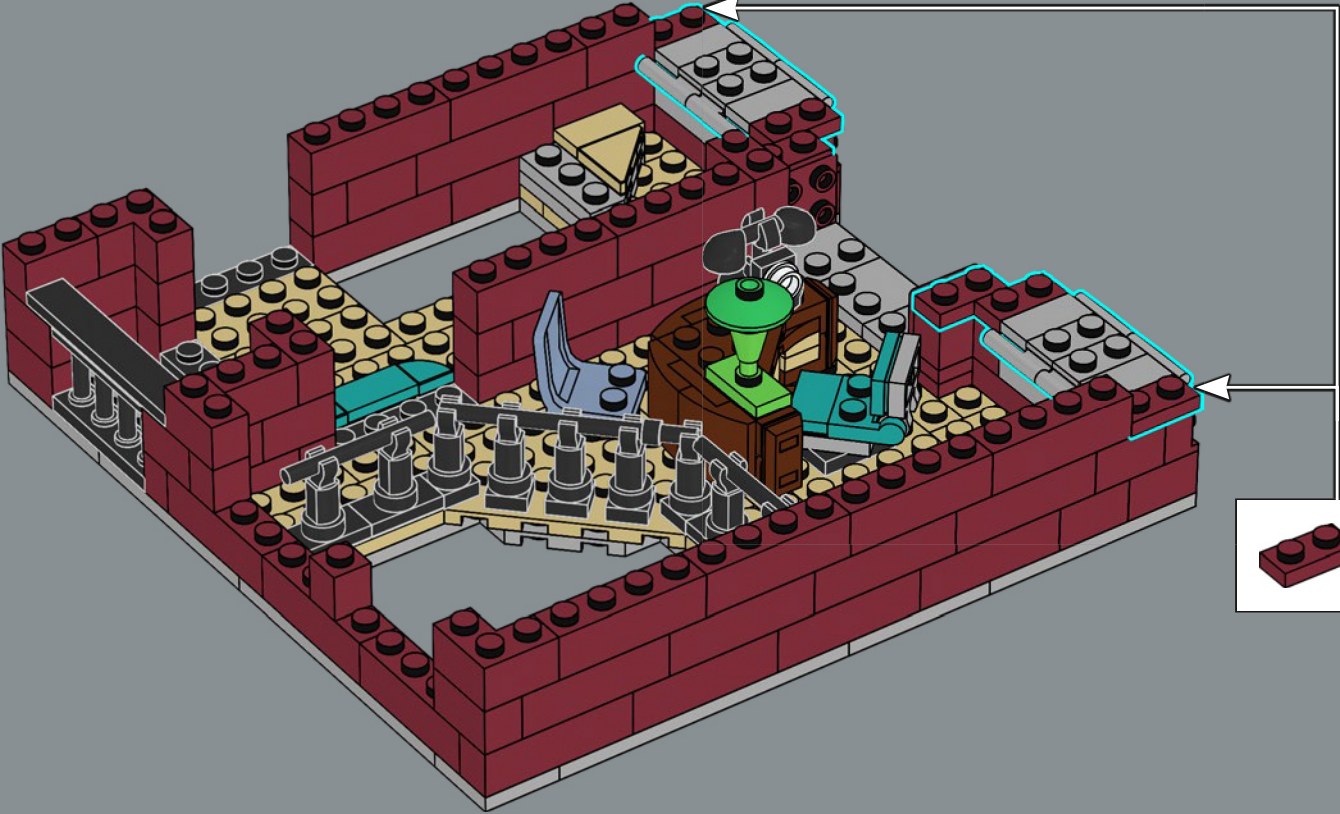

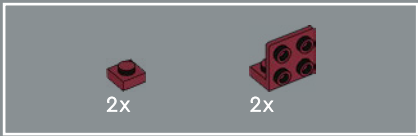

191

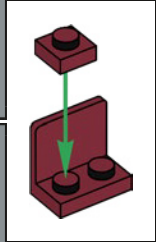
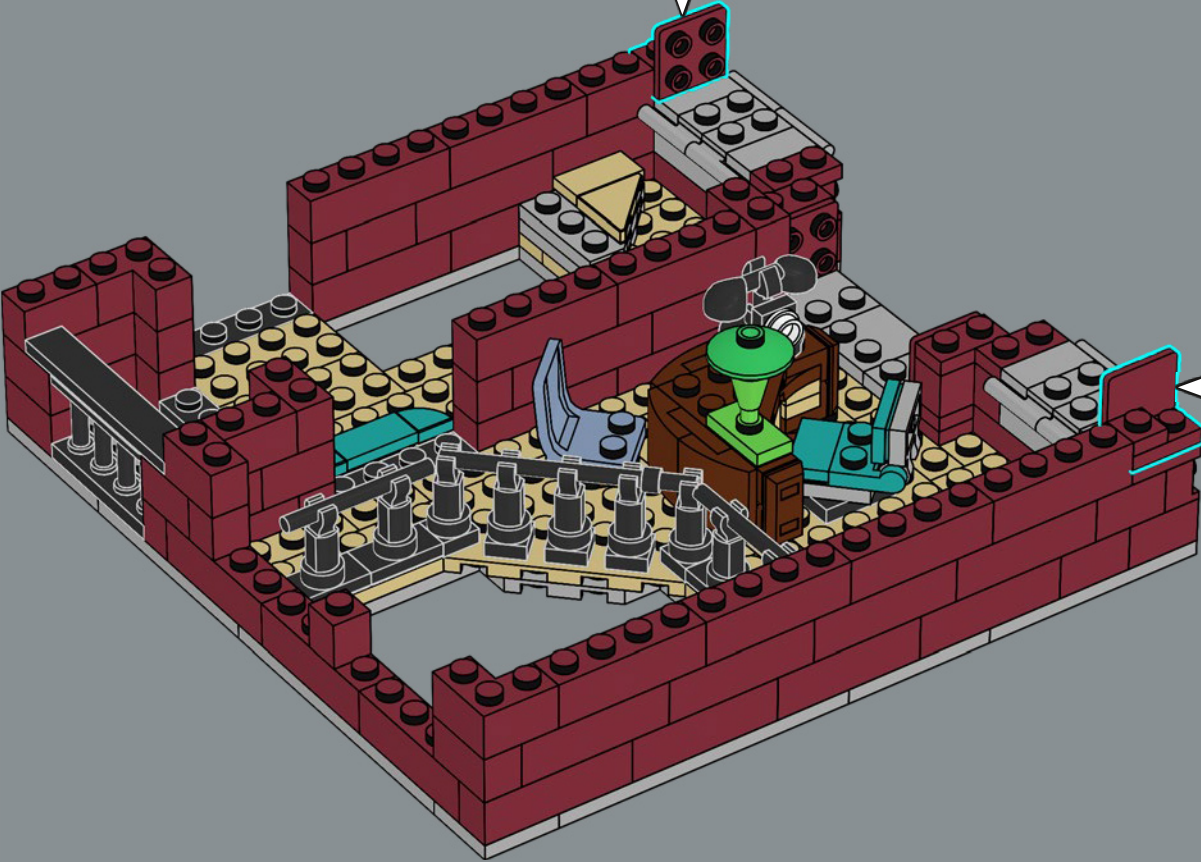
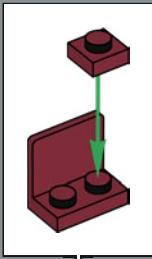



192

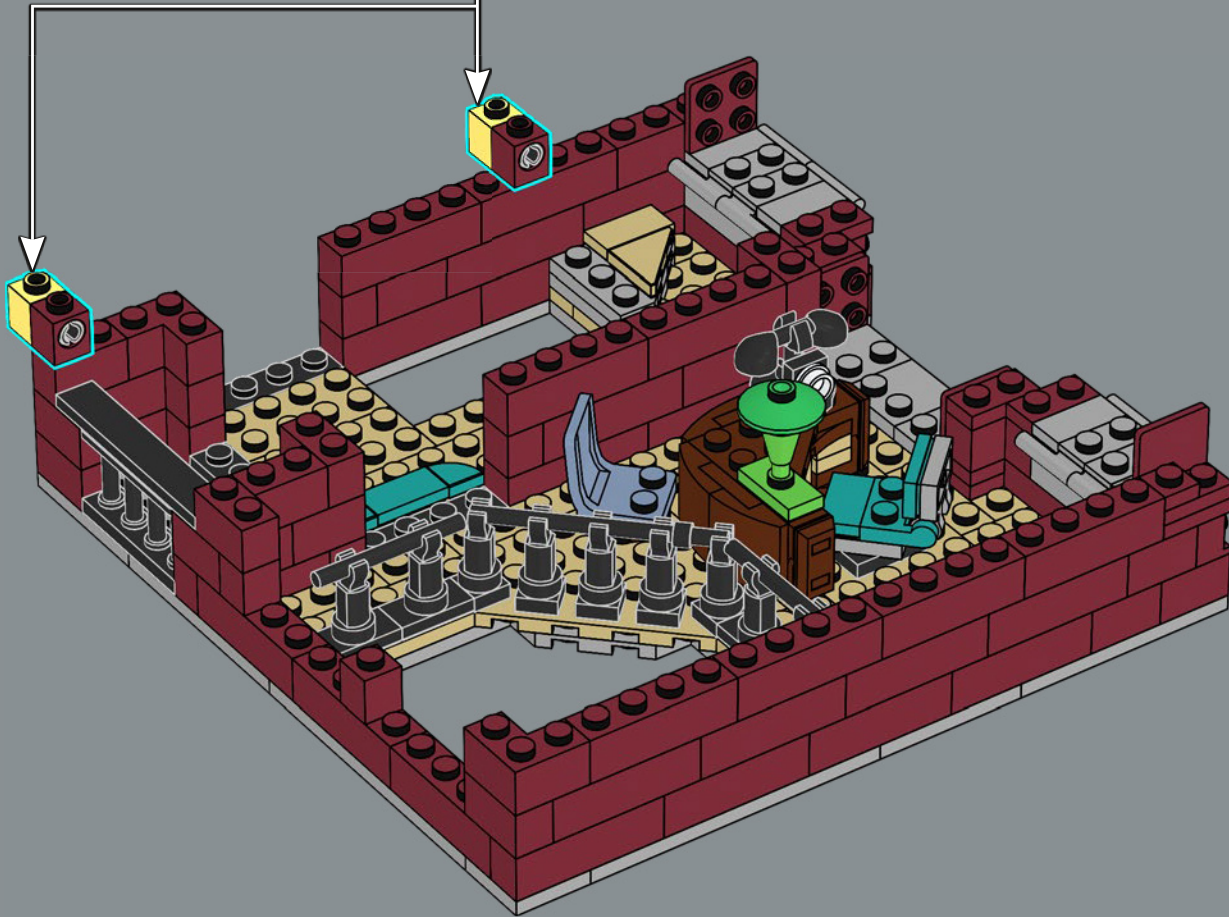
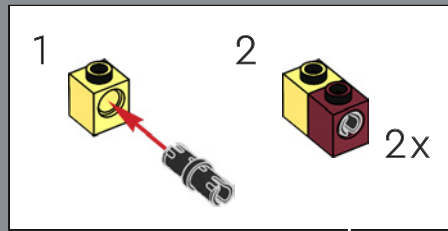

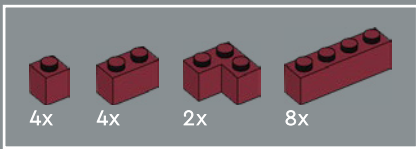

193

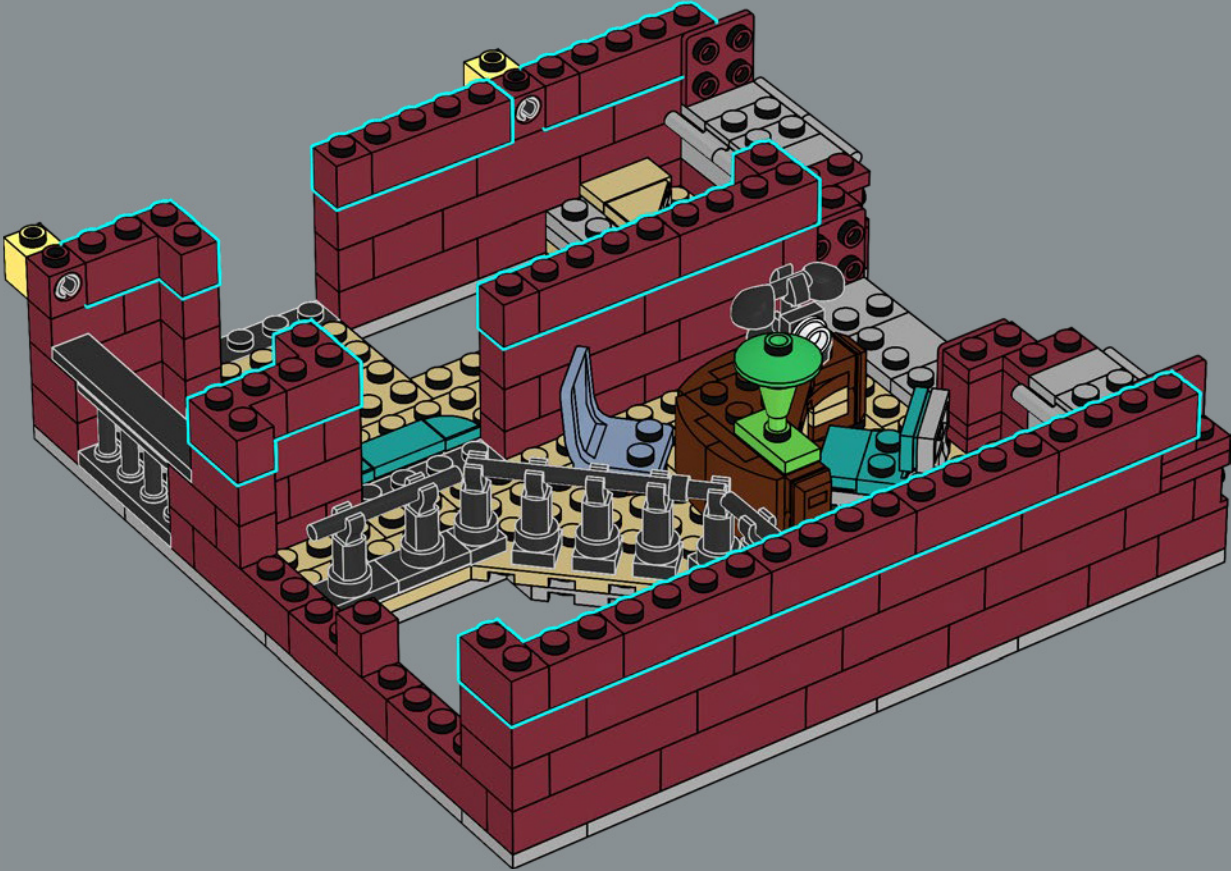

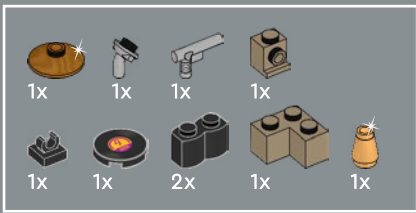

194

1

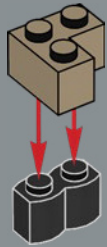

2

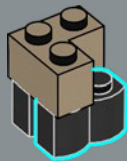

3

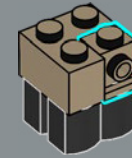

4



5

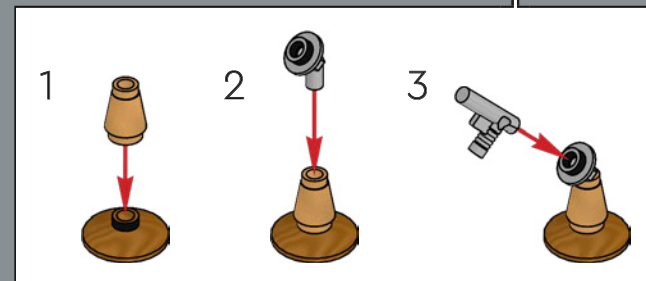



In addition to live music, the club owner loves listening to the latest hits on vinyl. Recently she listened to the chart-topping new album by the rock star from the LEGO® 10260 Downtown Diner.

En plus de la musique sur scène, la propriétaire du club adore écouter les derniers succès sur vinyle. Récemment, elle a écouté le nouvel album de la vedette du rock du Restaurant du centre-ville LEGO® 10260.

Además de la música en vivo, a la propietaria del club le encanta escuchar las últimas novedades en discos de vinilo. Hace poco escuchó el exitosísimo nuevo álbum de la estrella de rock del Restaurante del Centro LEGO® (10260).

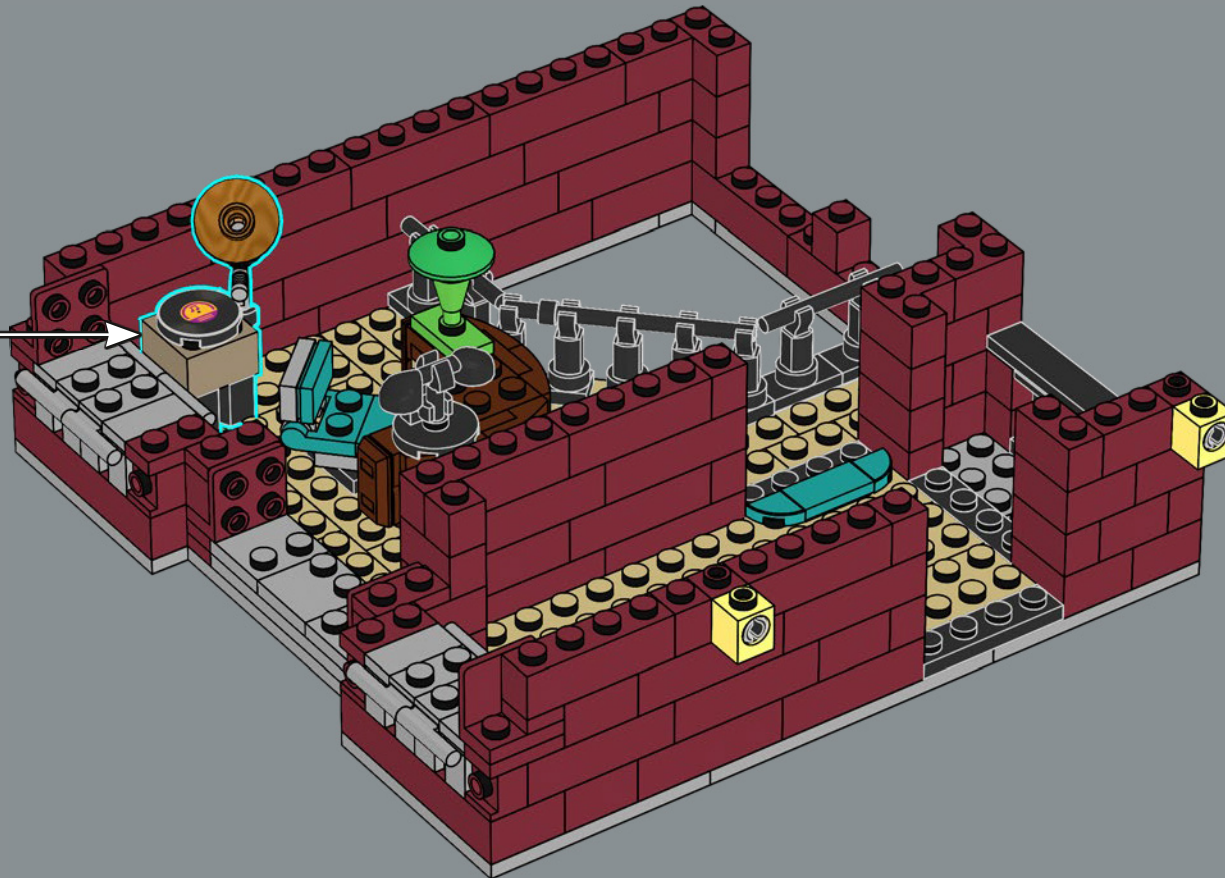

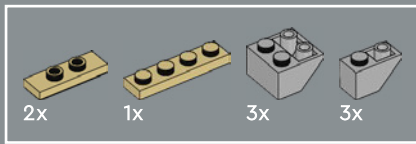

195

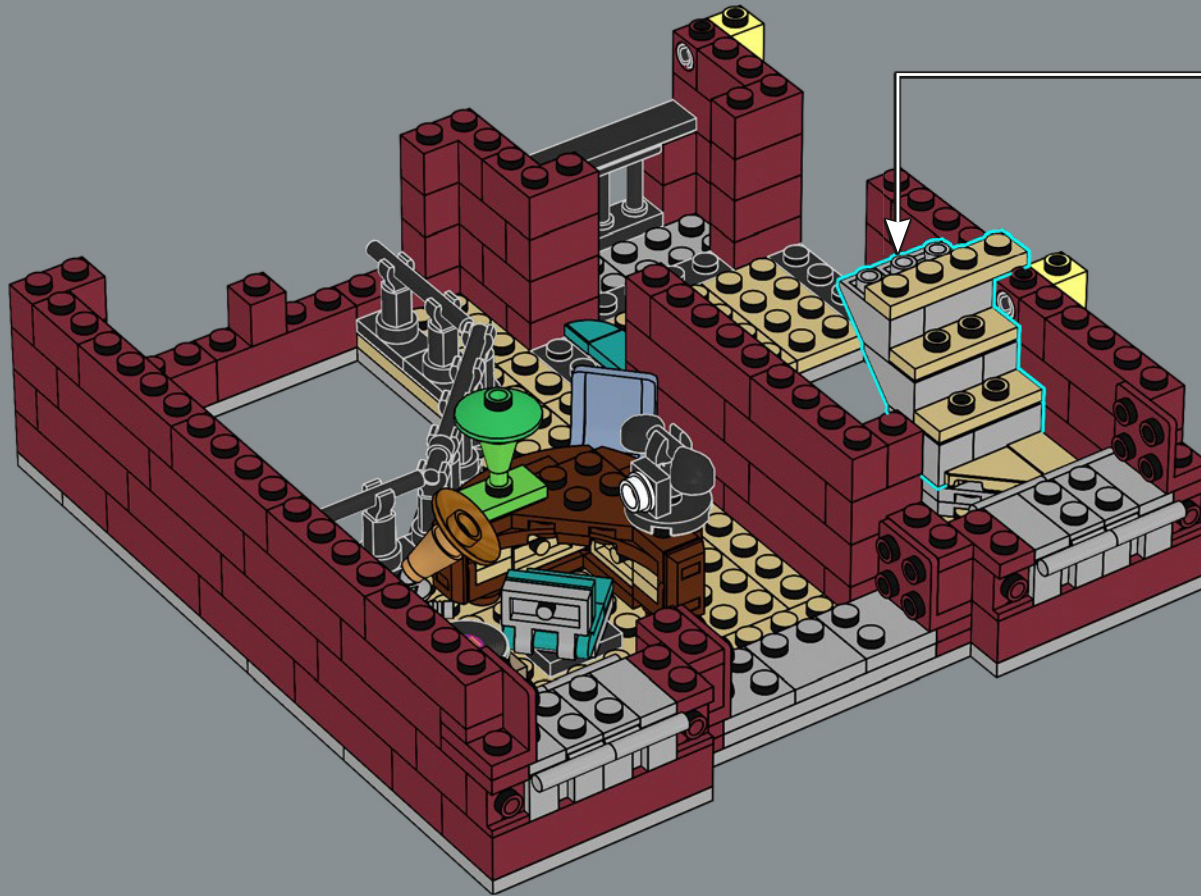
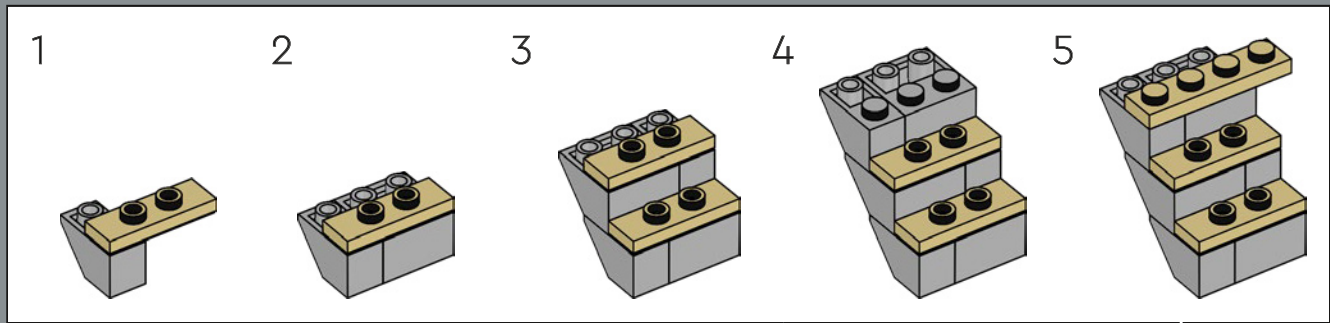



4x

196

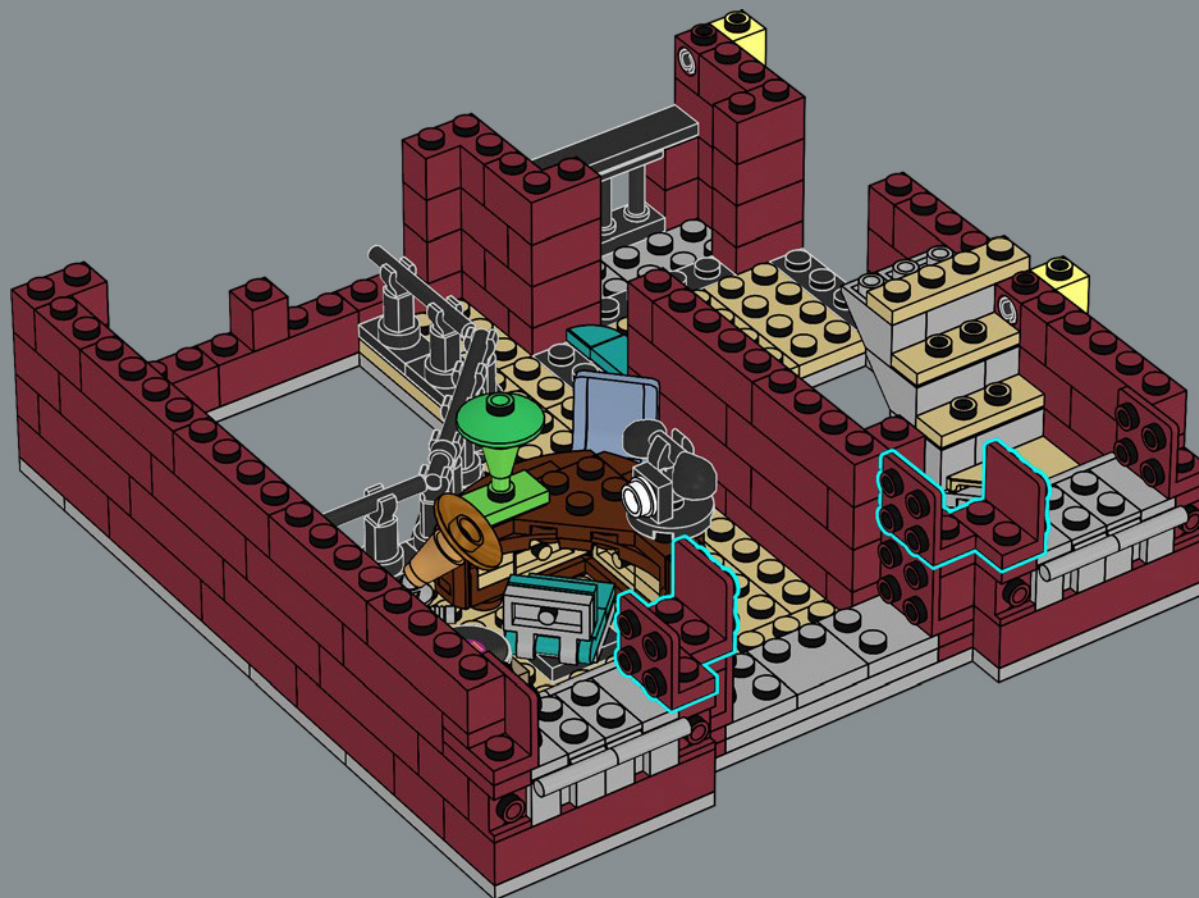

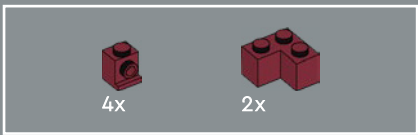

197

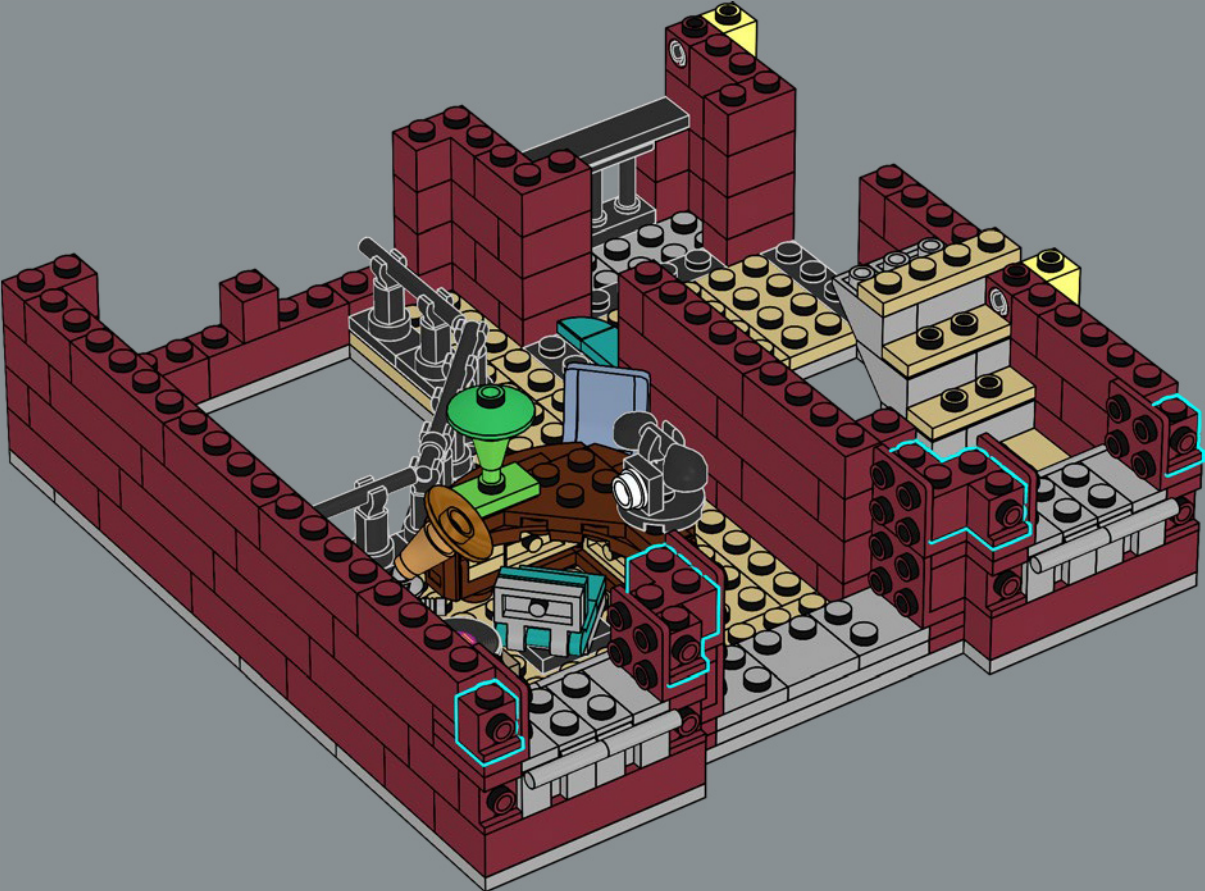

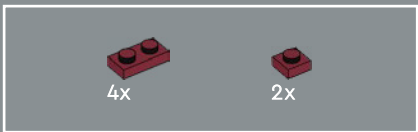

198

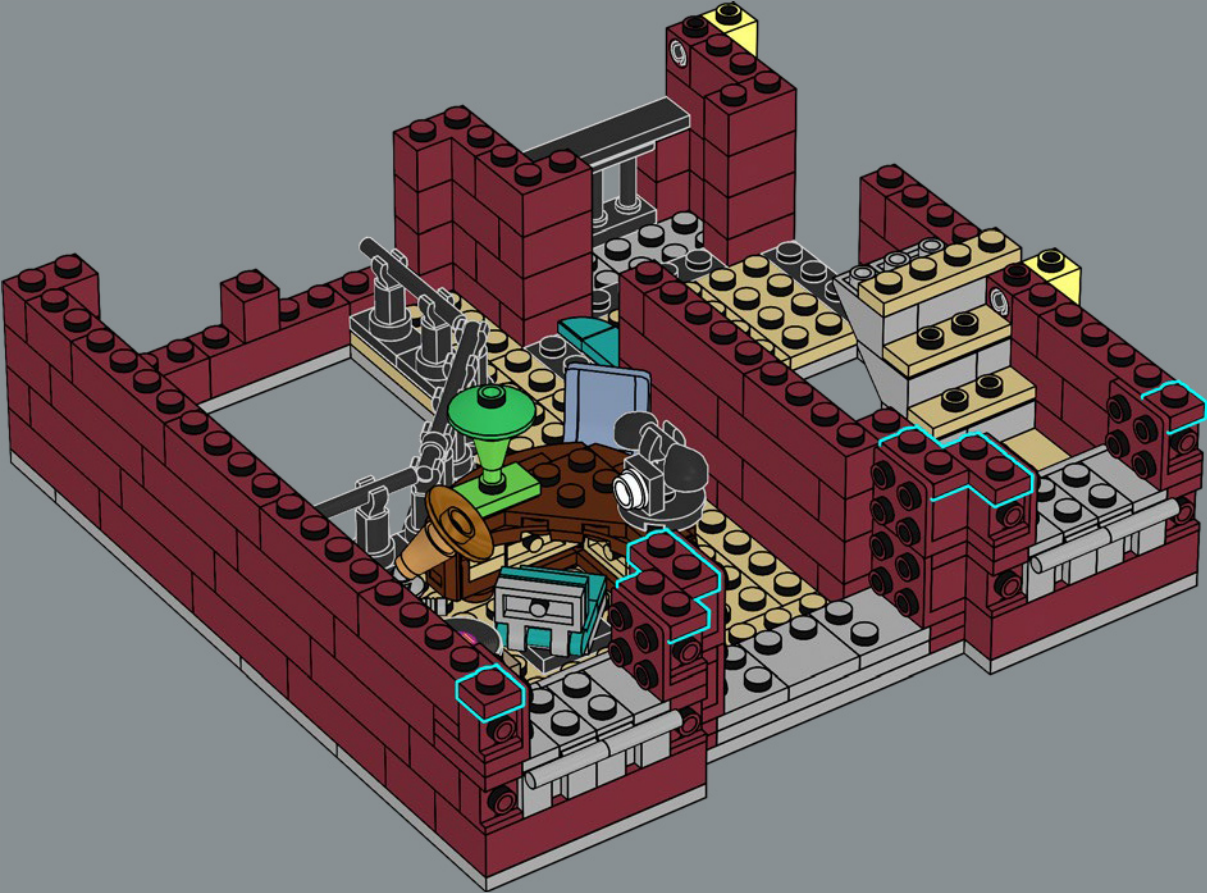

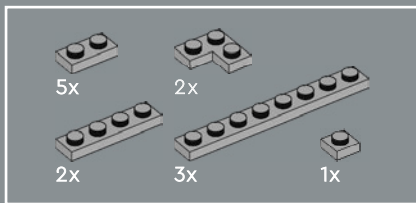

199

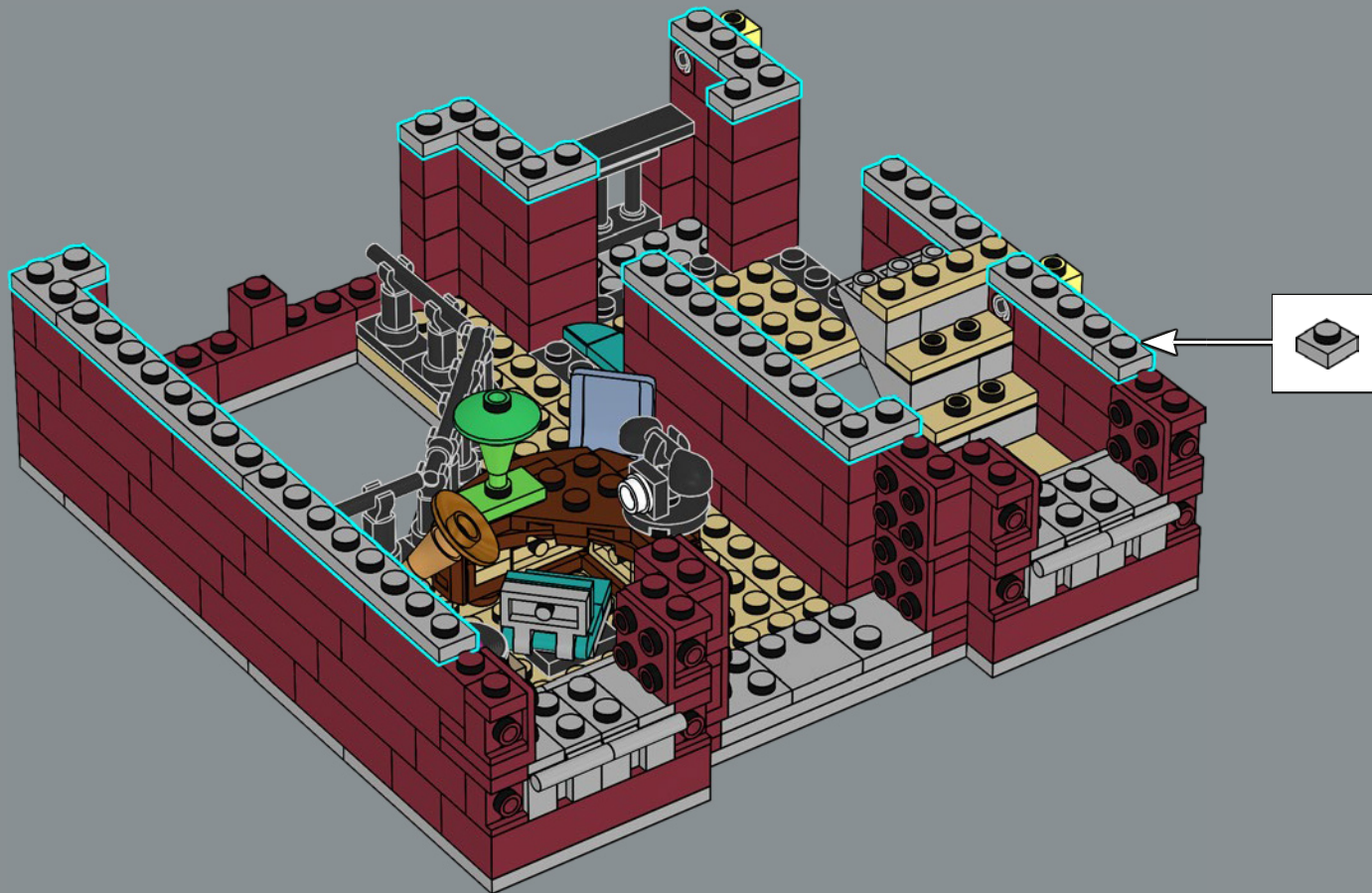



6x

200

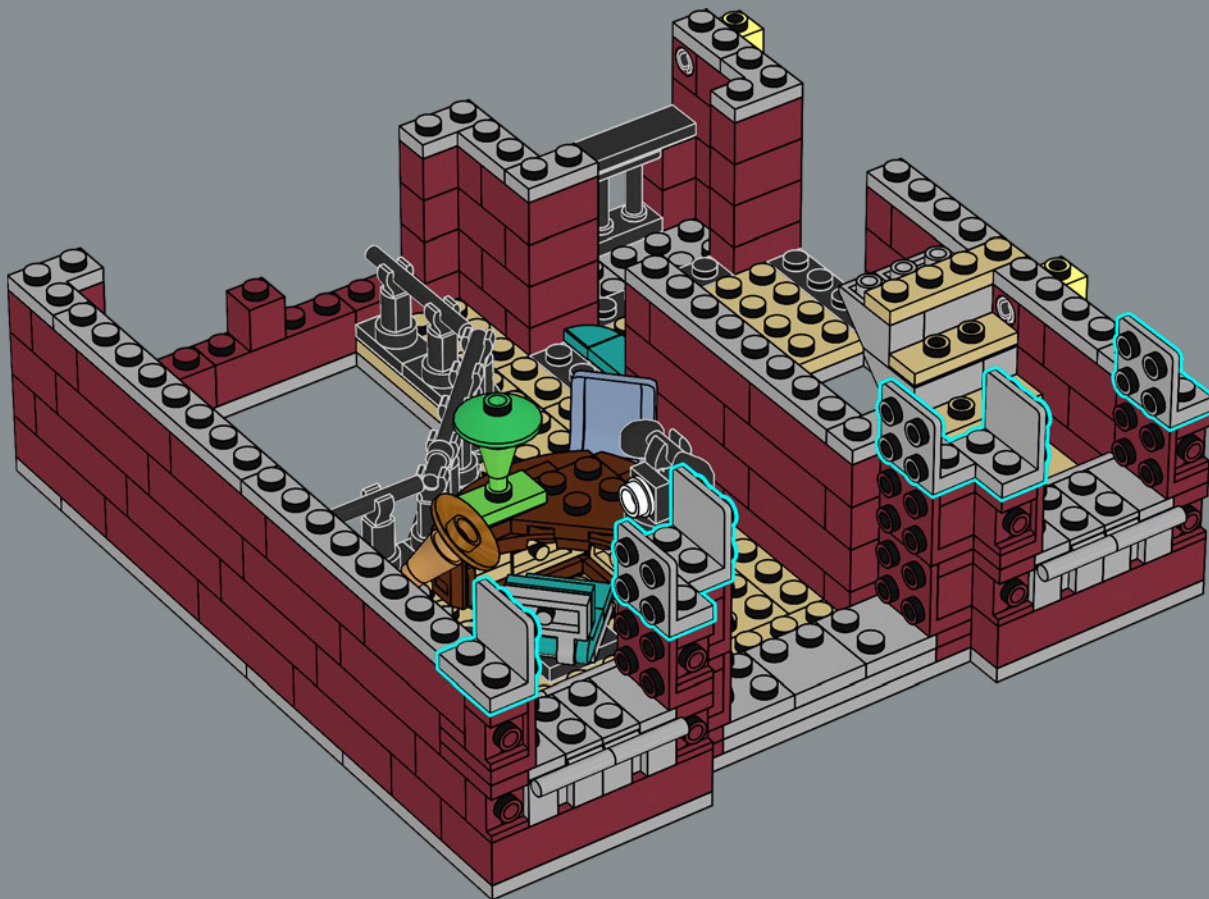

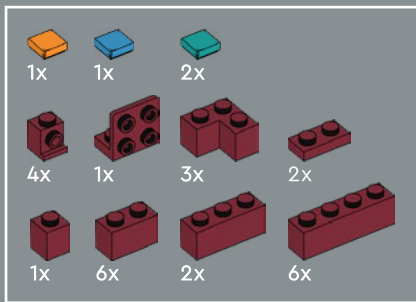

201

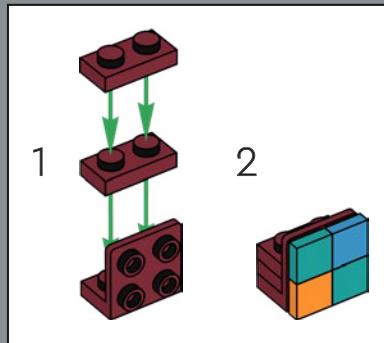

1 2

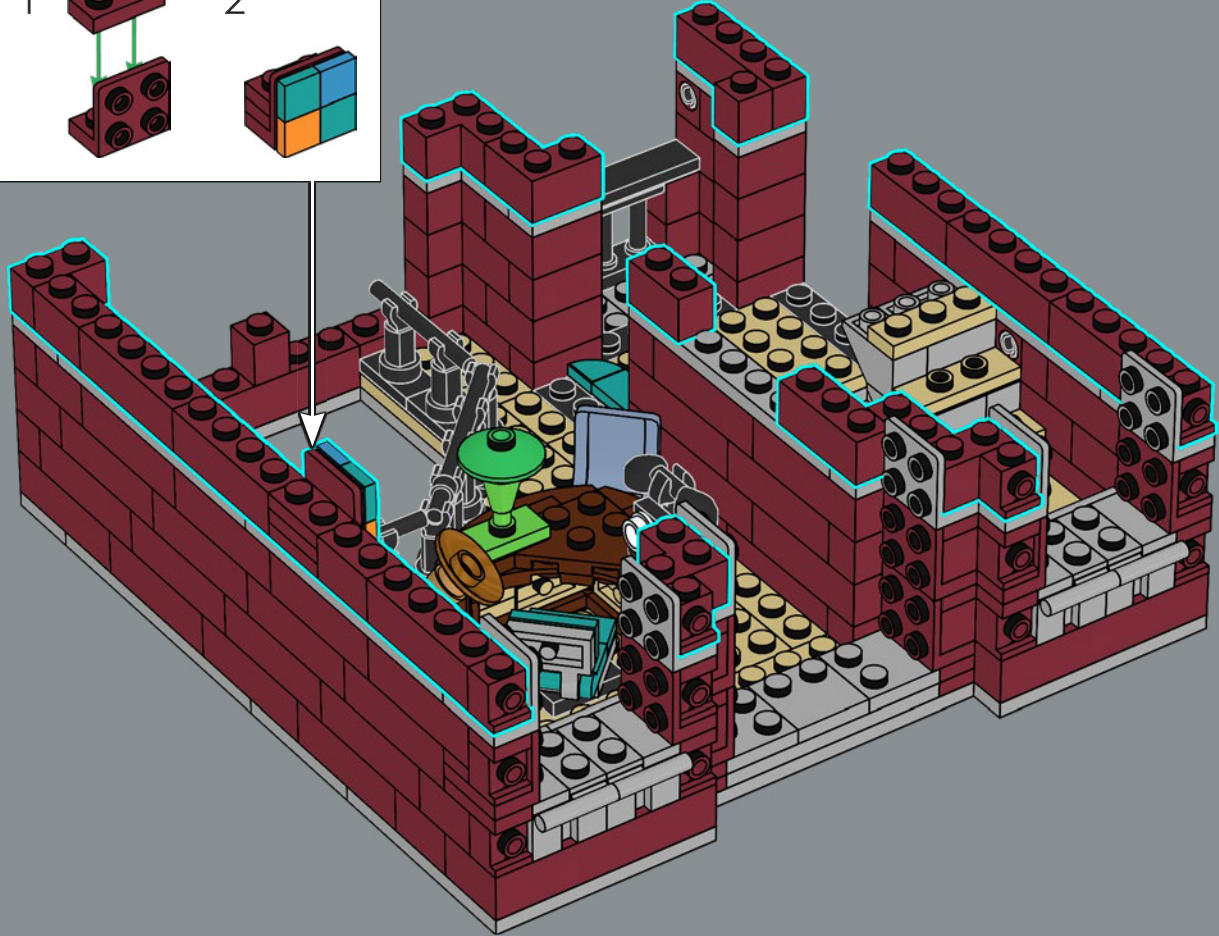

The wall art in the office is a small piece by the artist living in the loft above the LEGO® 10243 Parisian Restaurant.

L'art mural dans le bureau est une petite œuvre de l'artiste qui vit dans le loft au-dessus du Restaurant parisien LEGO® 10243.

El arte mural de la oficina es una pequeña creación del artista que vive en el ático del set LEGO® Restaurante Parisino (10243).



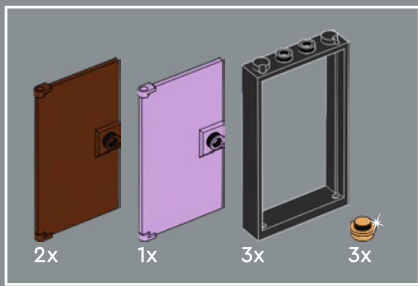

202

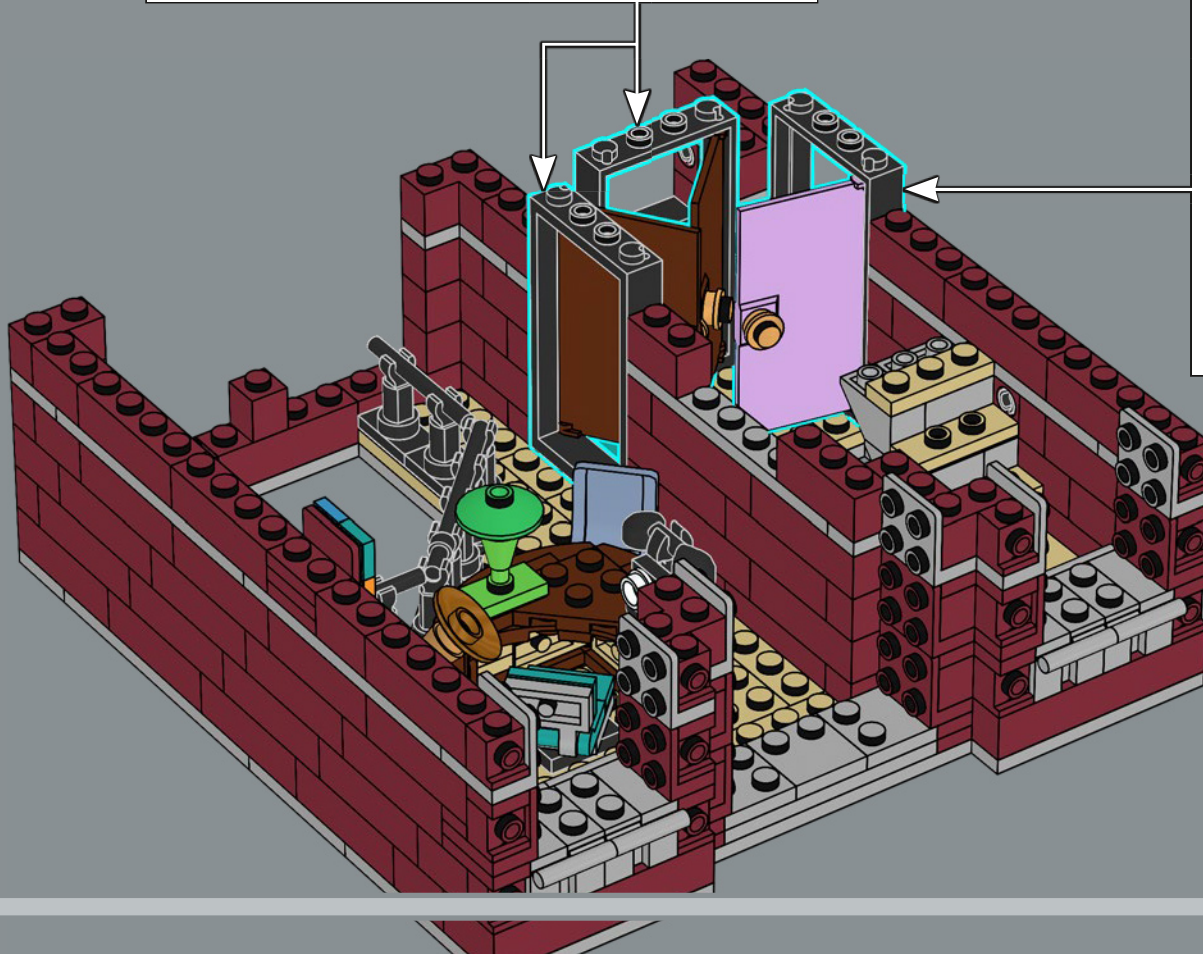
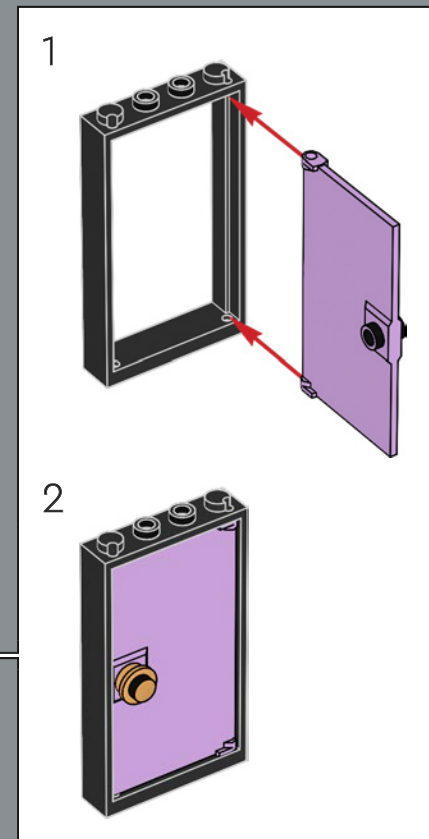
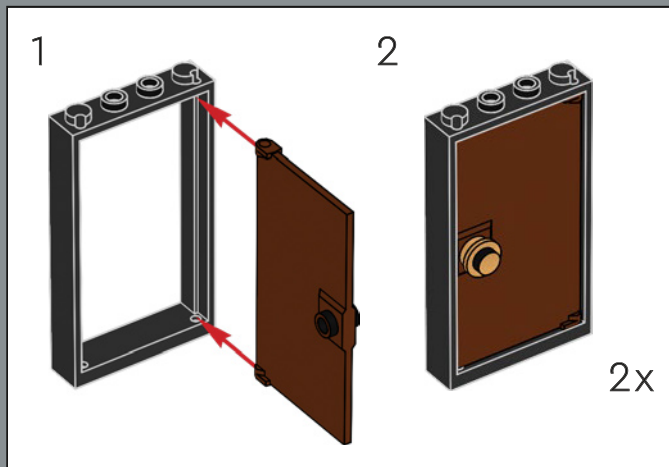

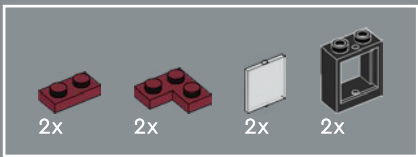

203

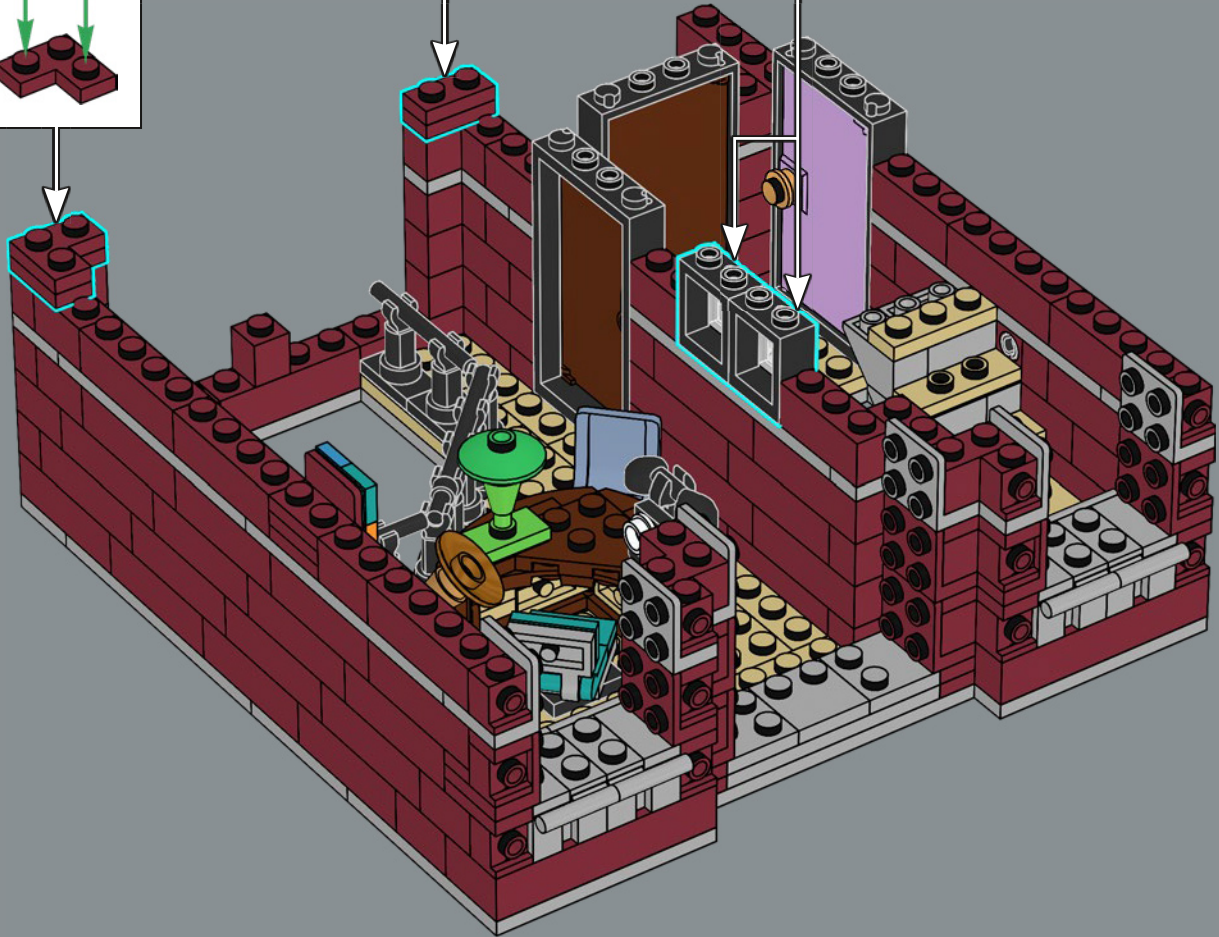
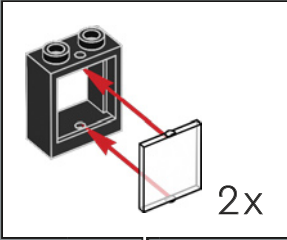
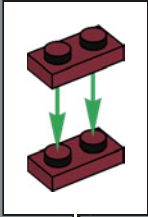
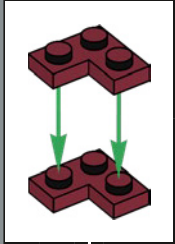

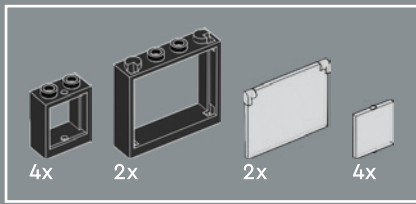

204

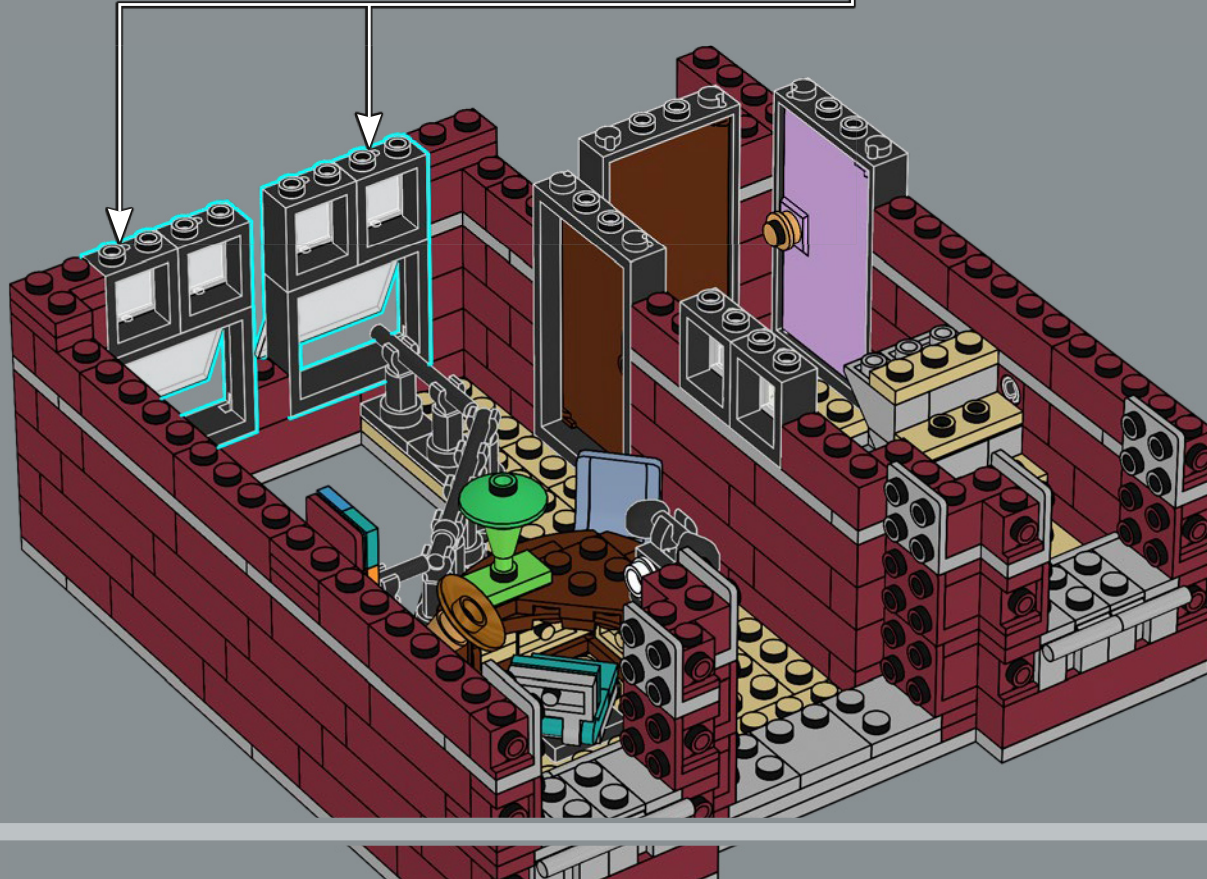
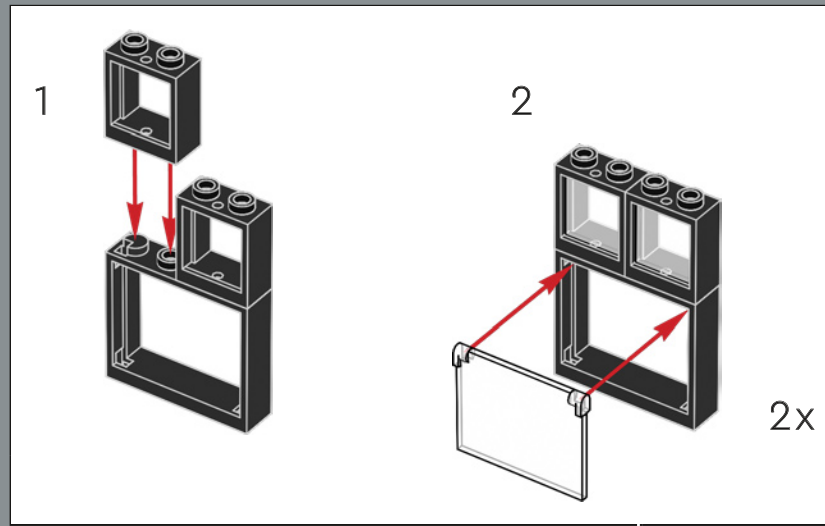



205

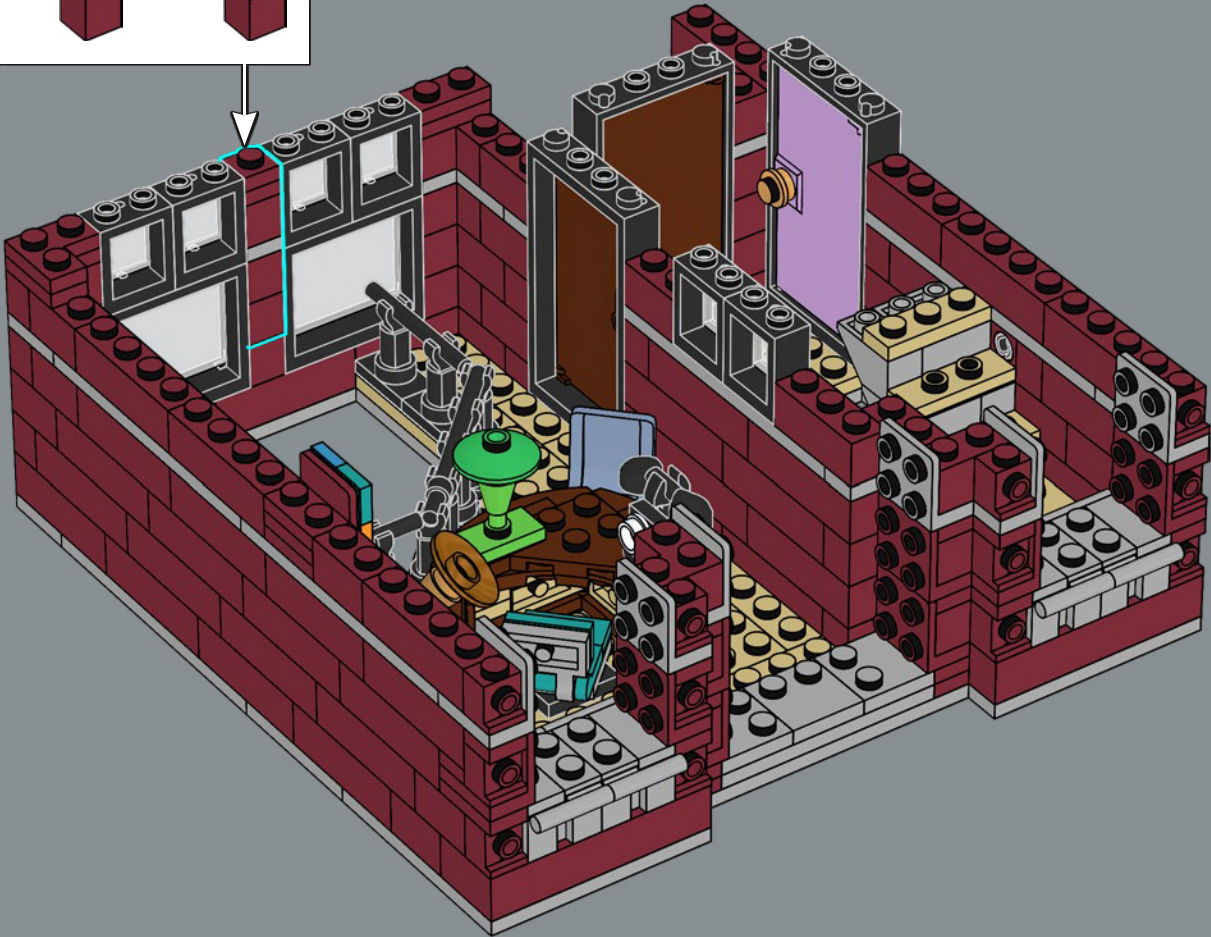
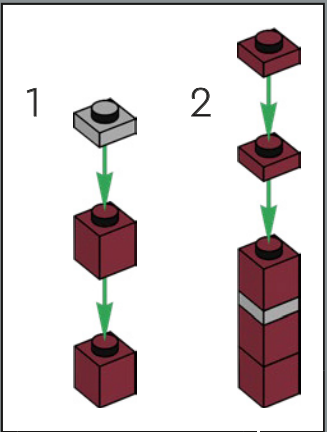

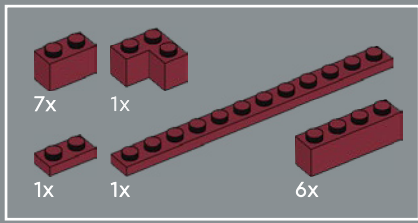

206

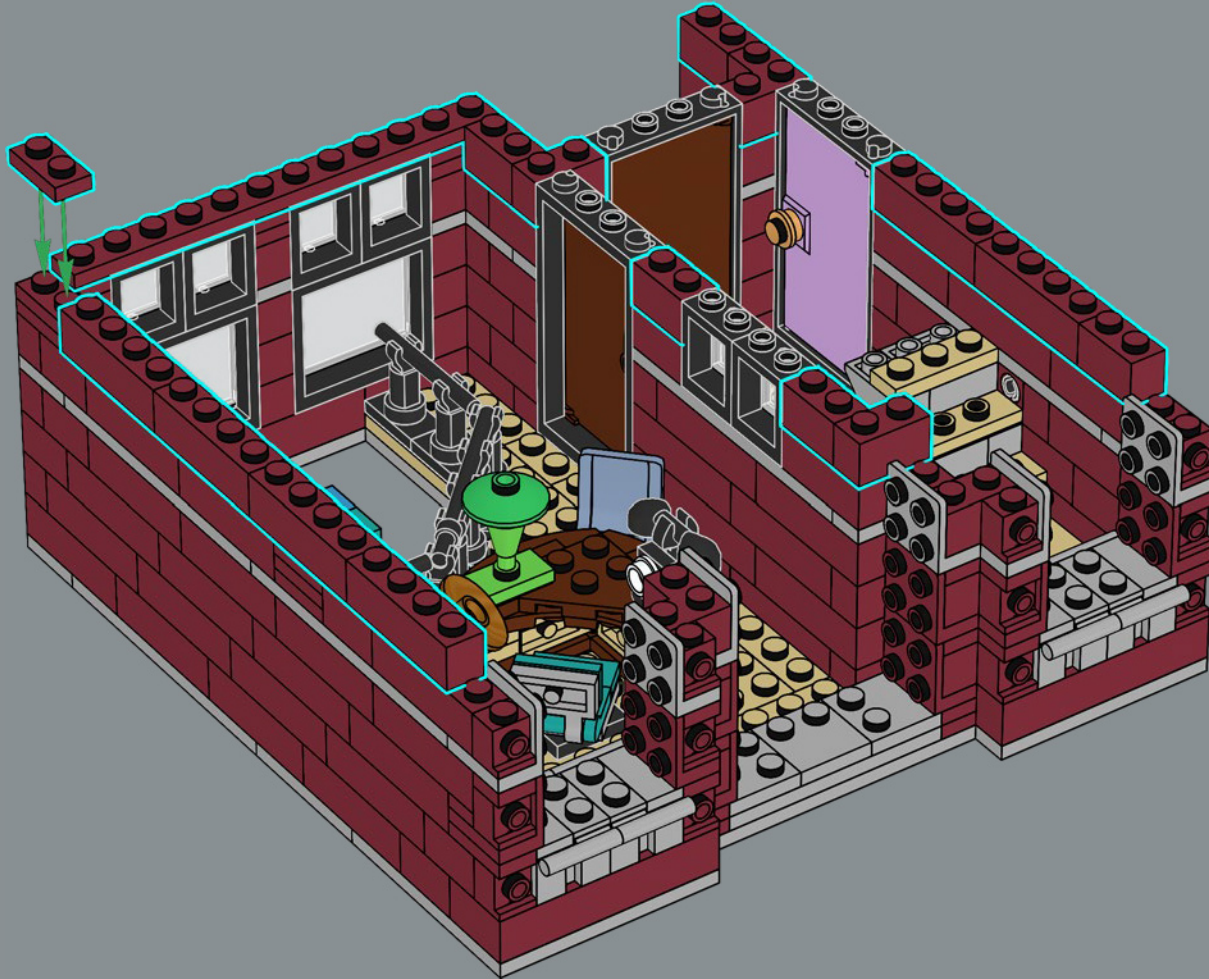

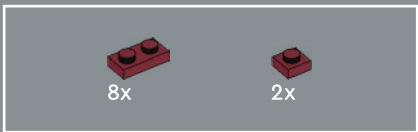

207

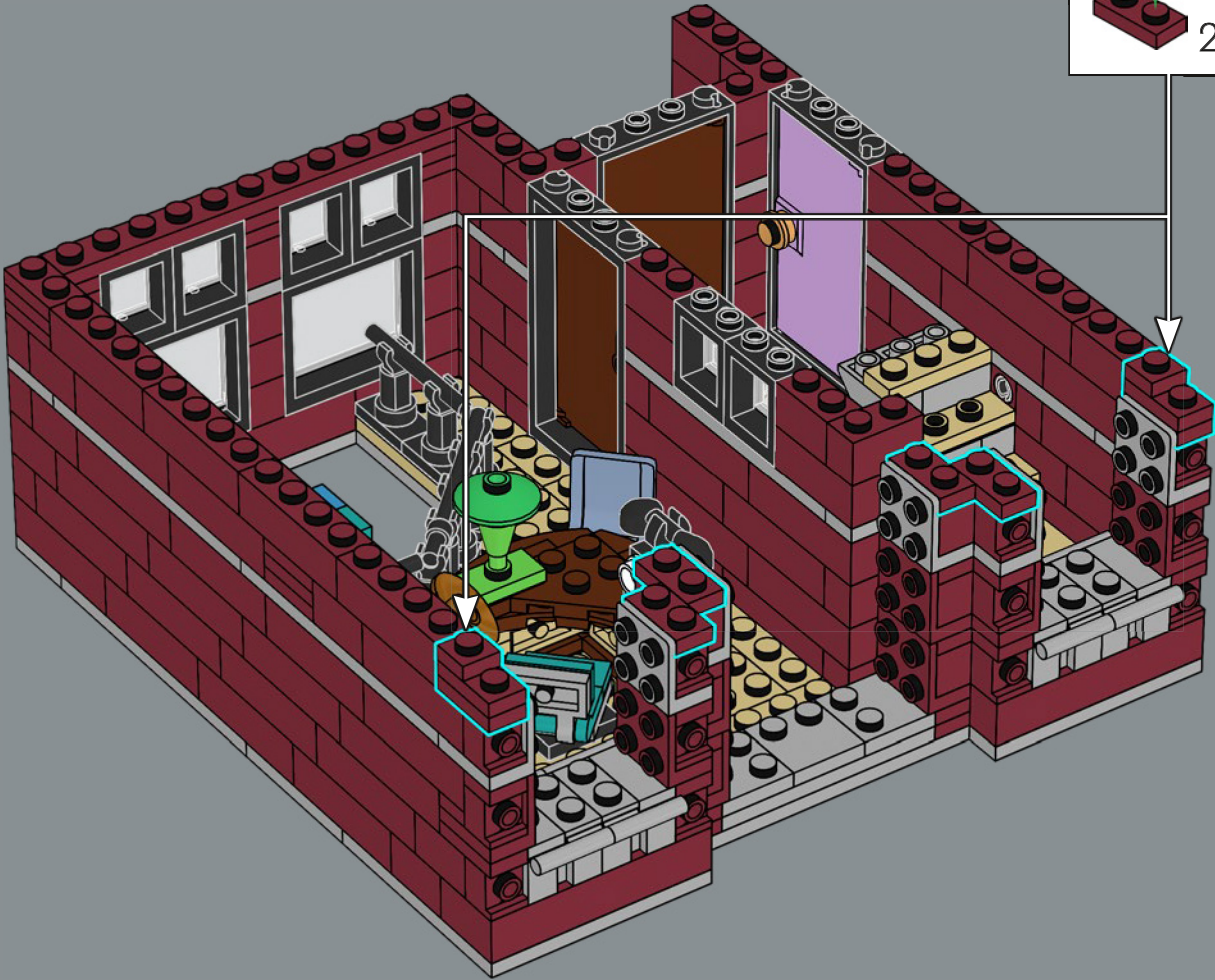
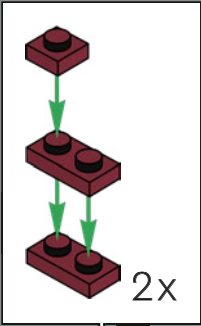

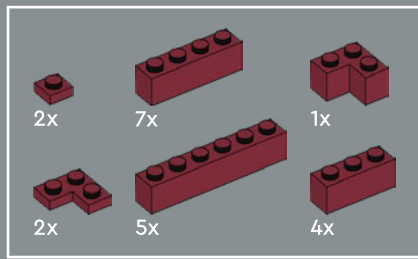

208

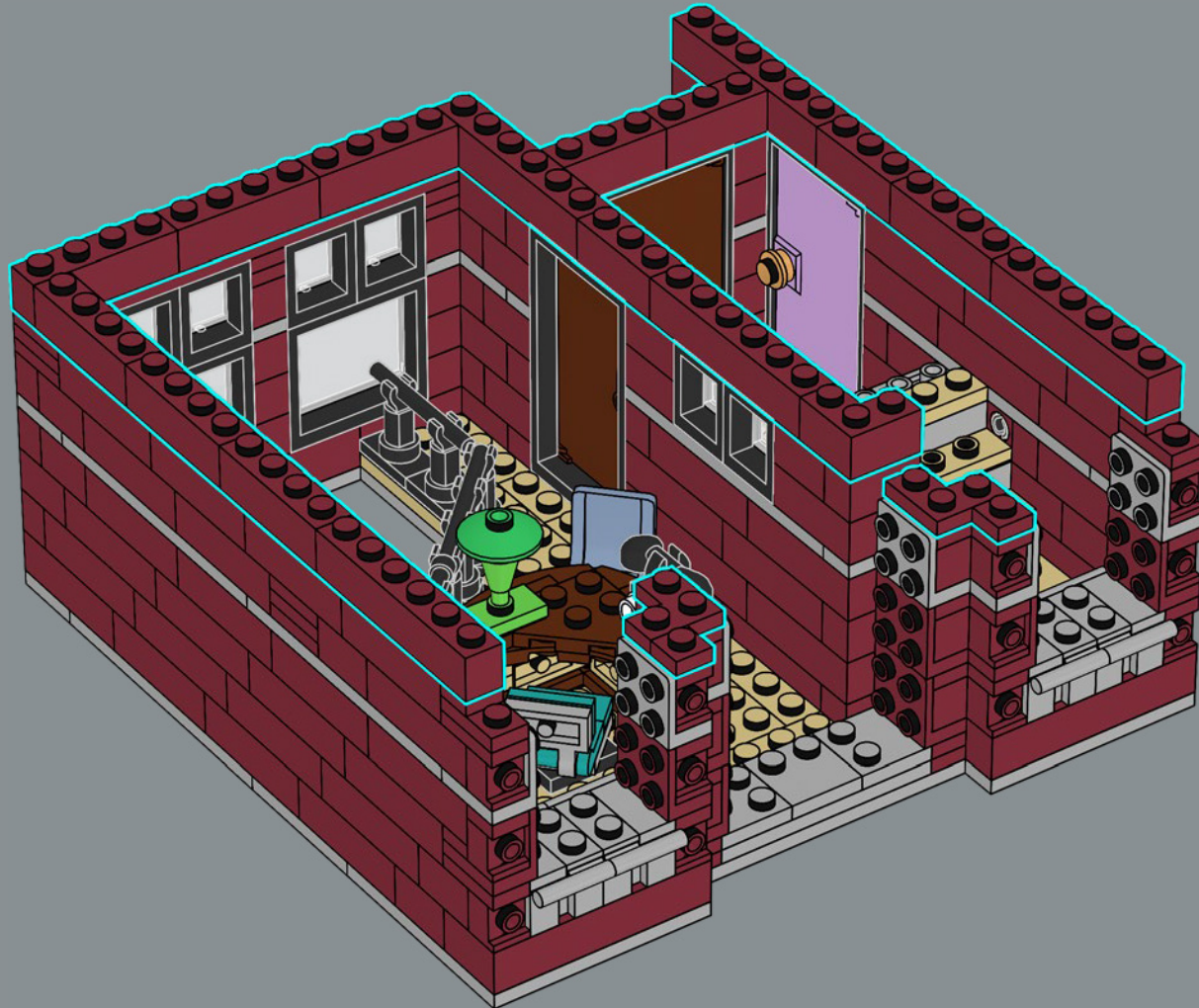



8x

209

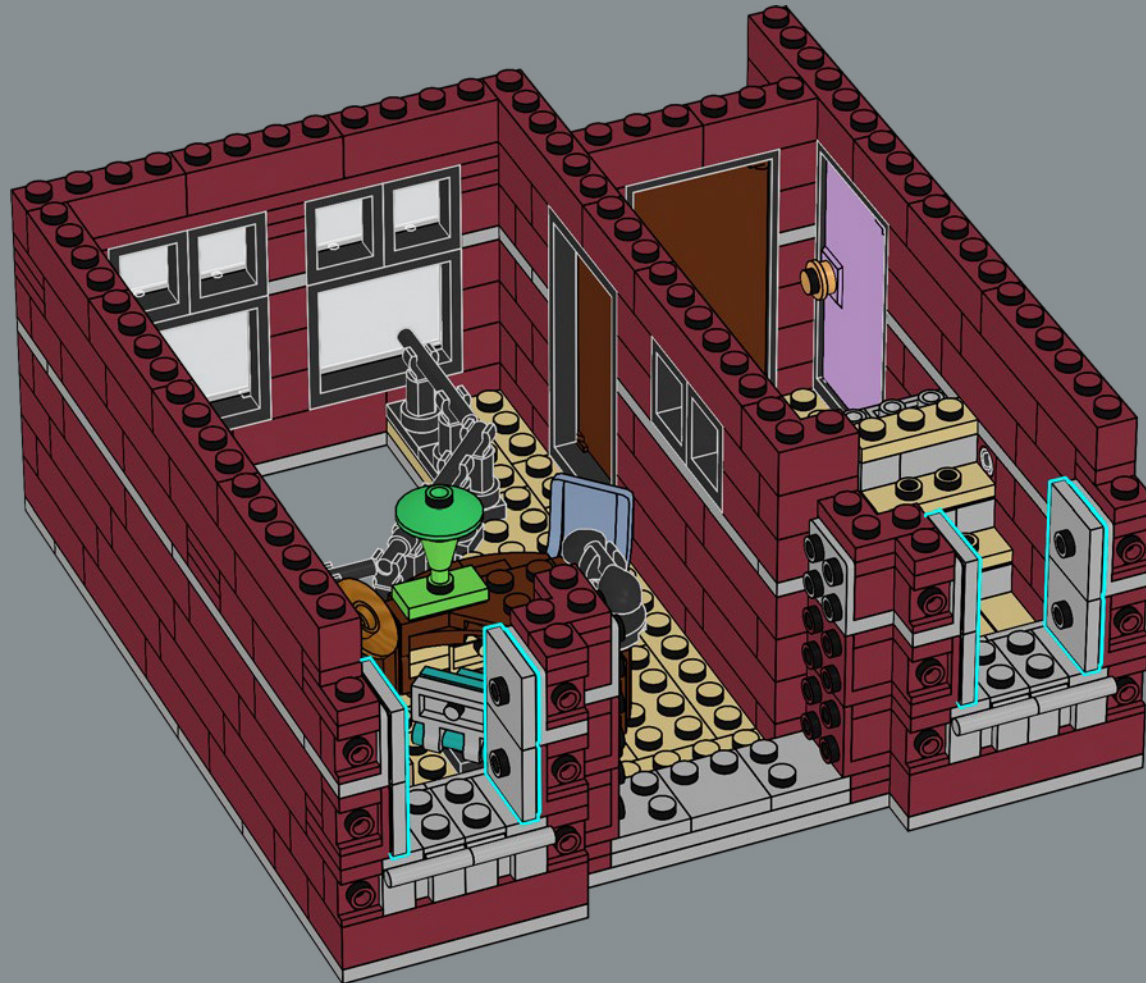

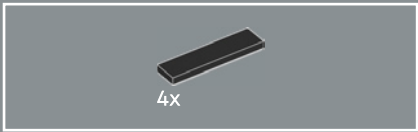

210

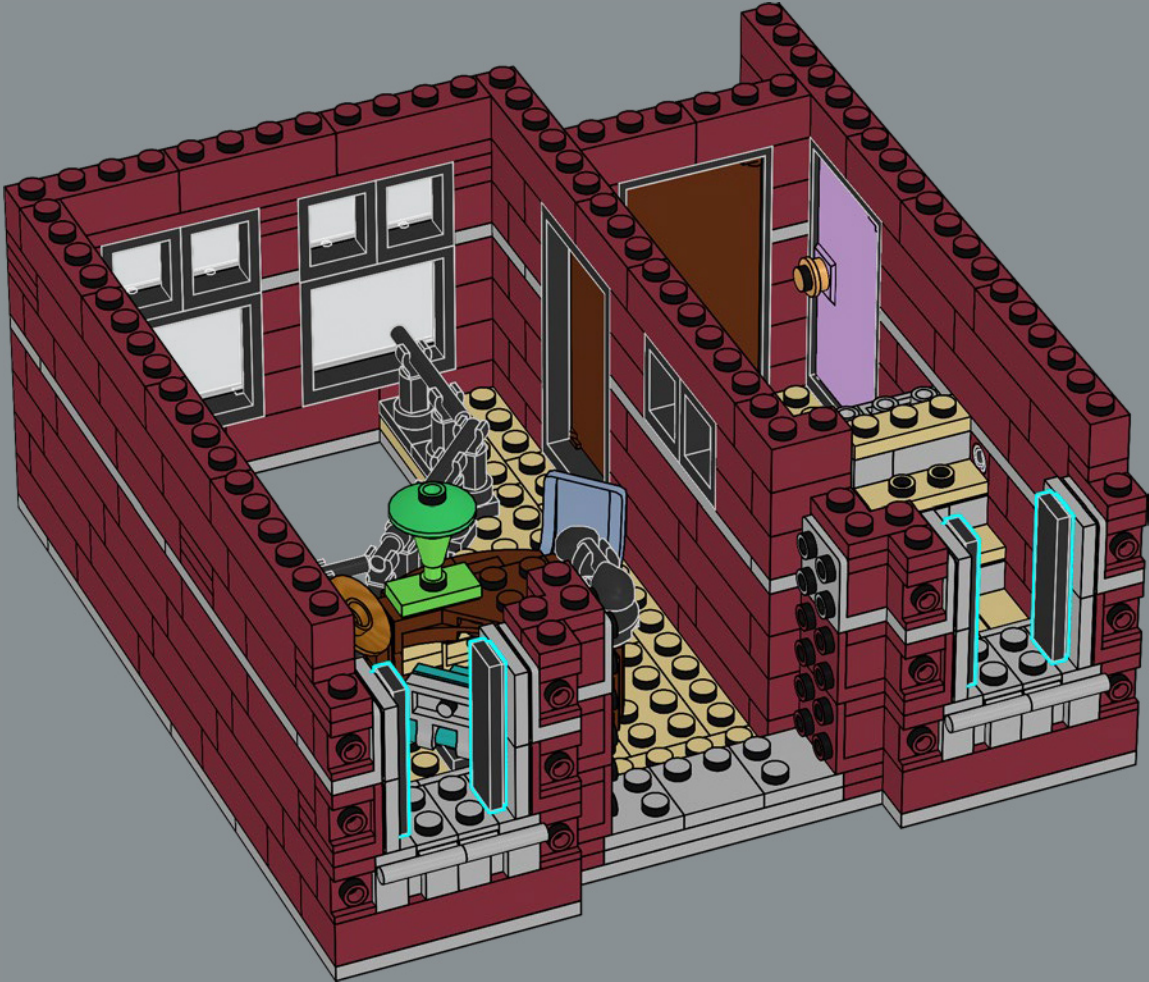

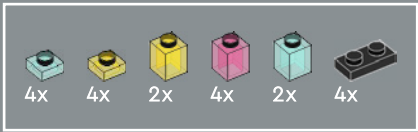

211

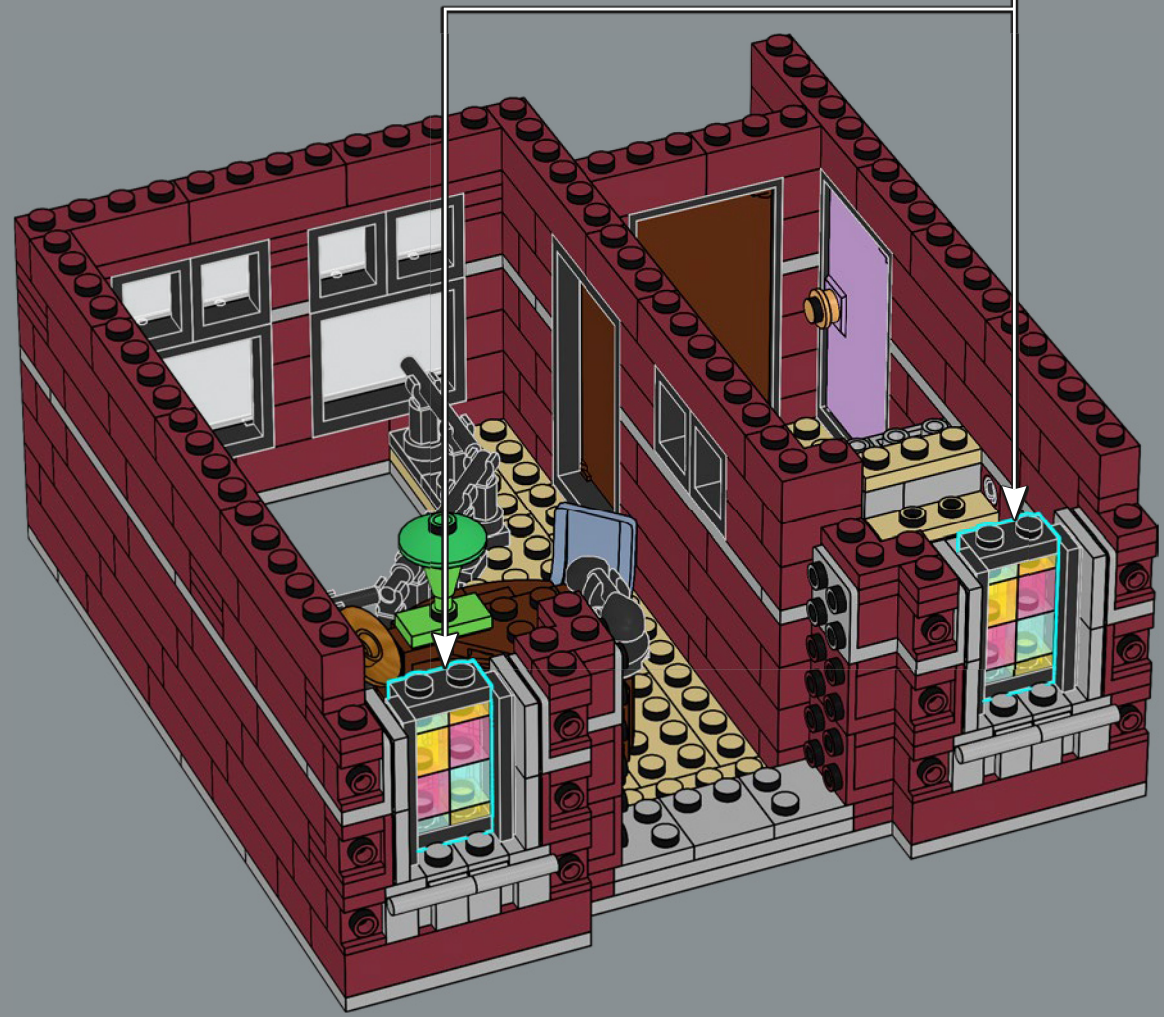
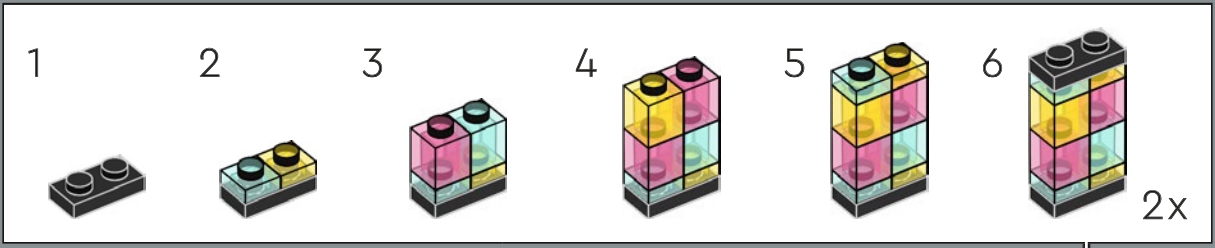

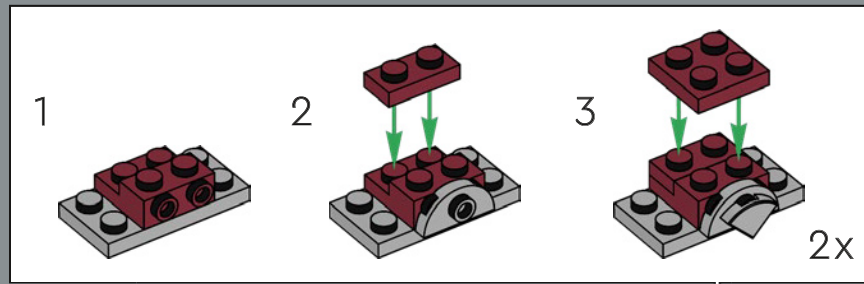
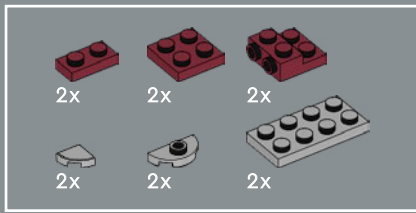

212

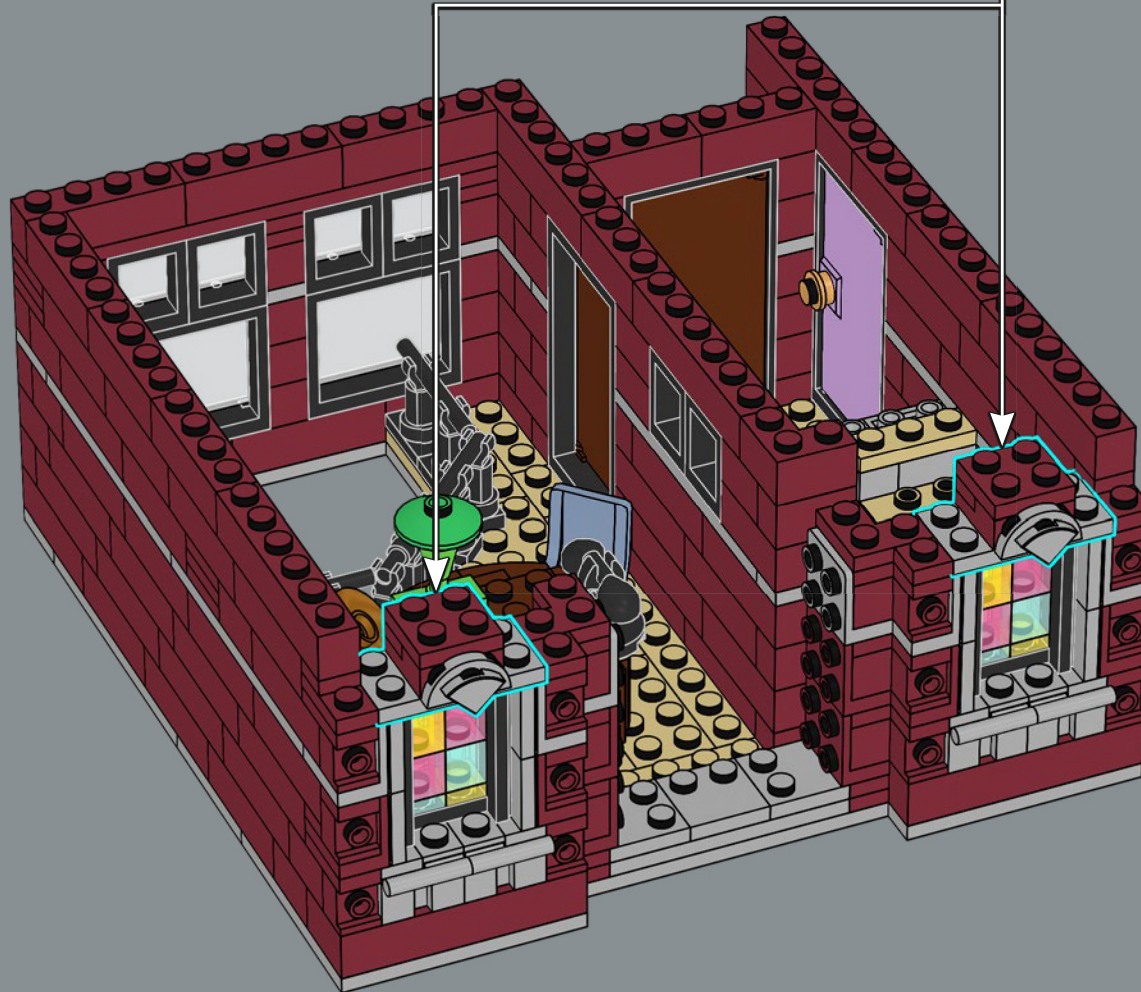

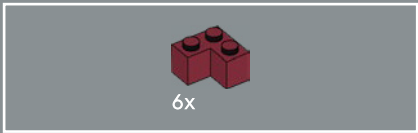

213

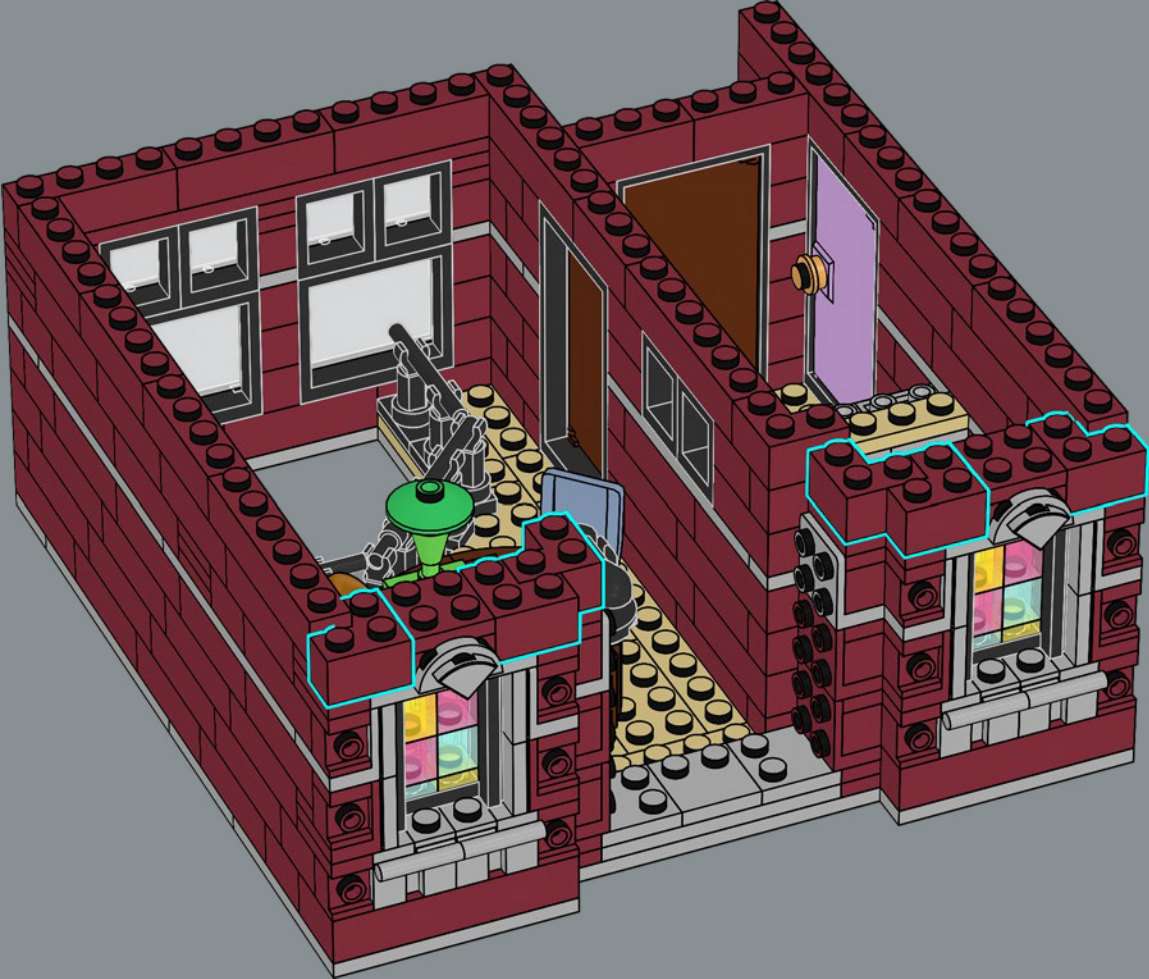

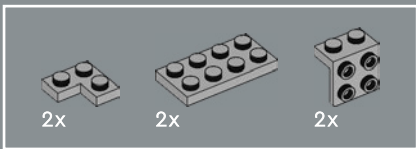

214

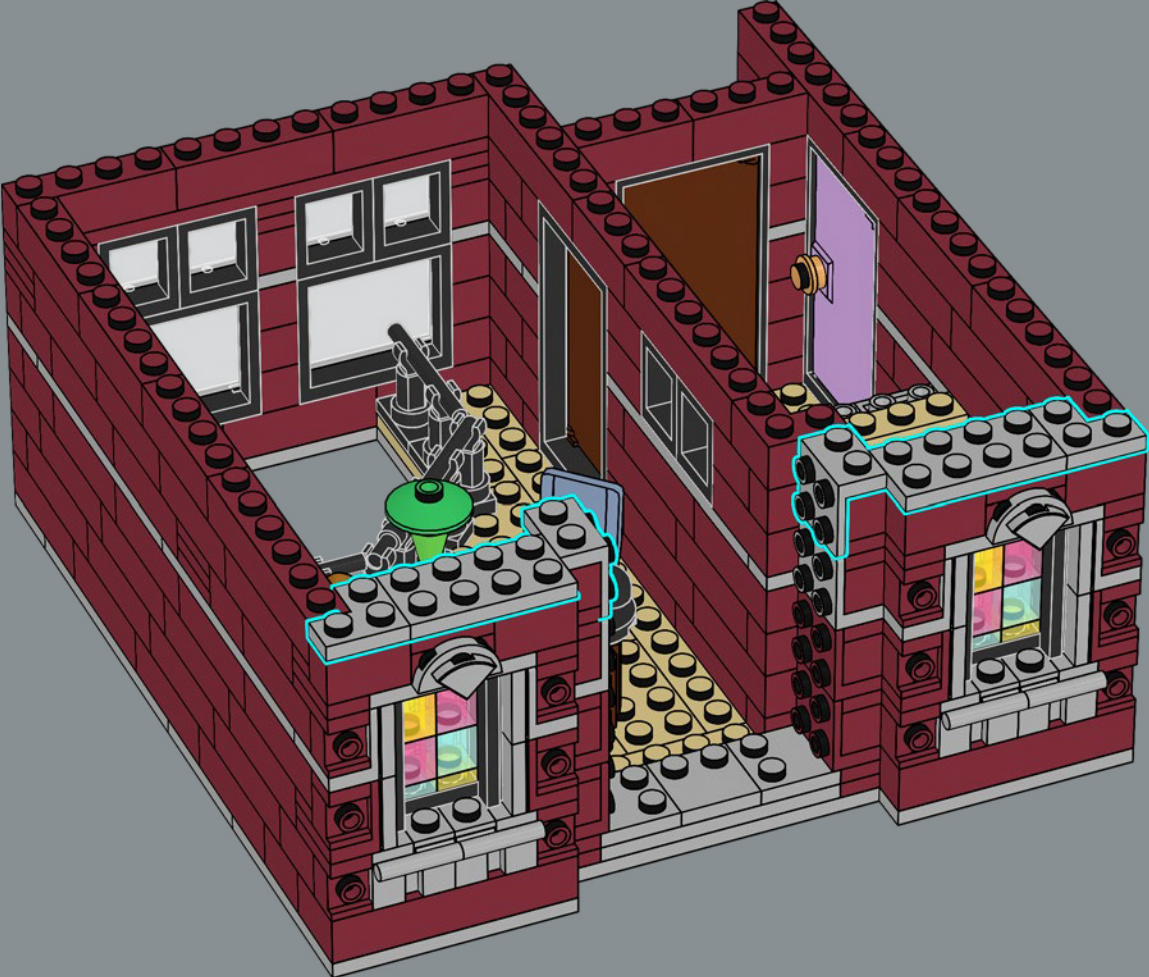

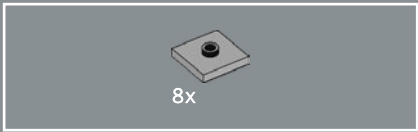

215

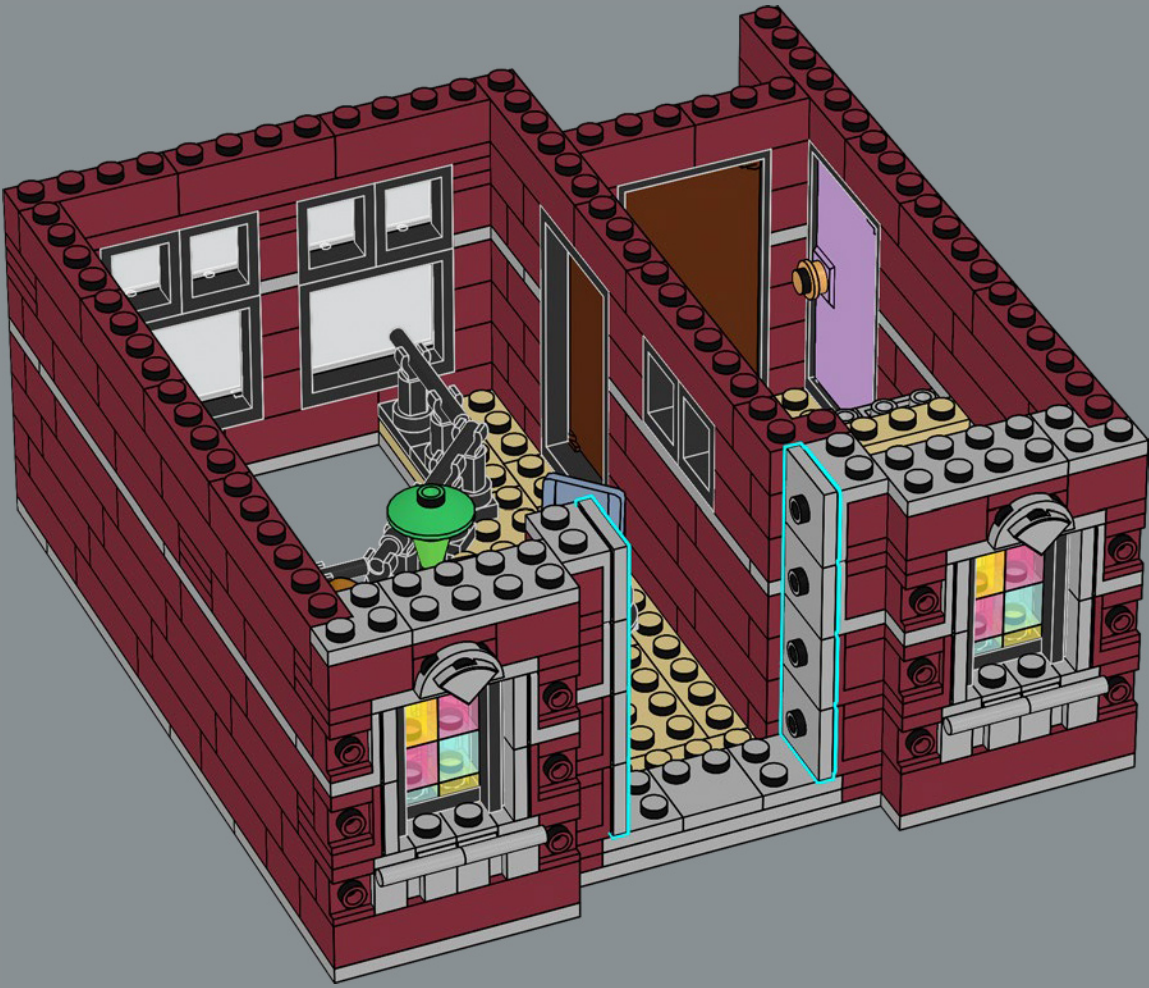

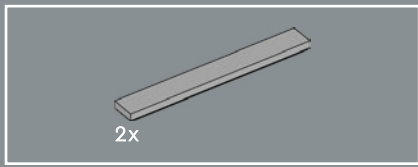

216

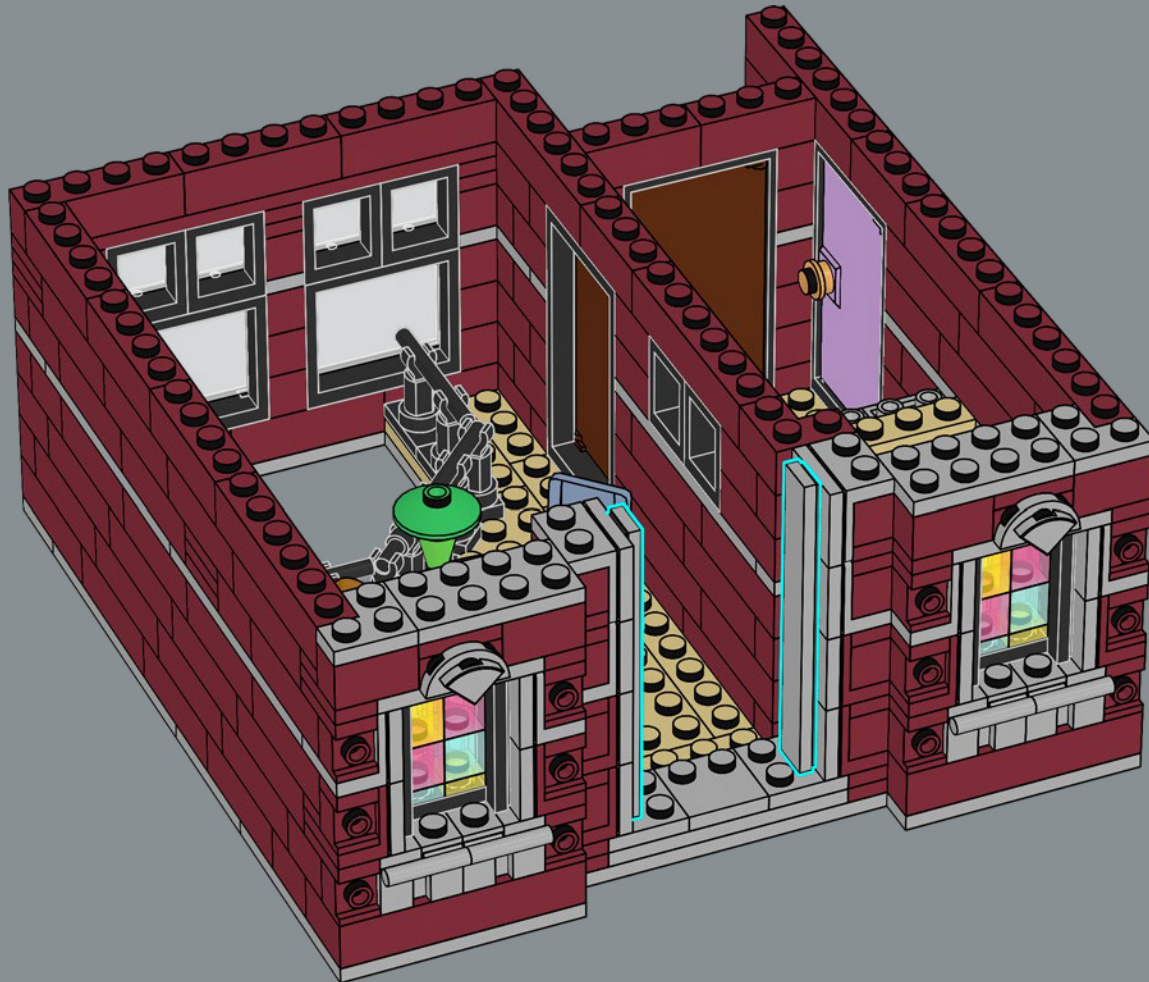

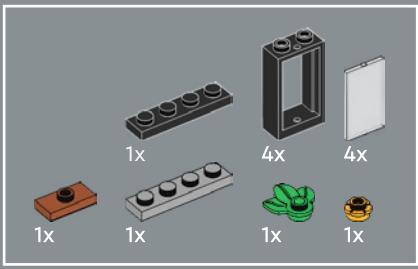

217

1

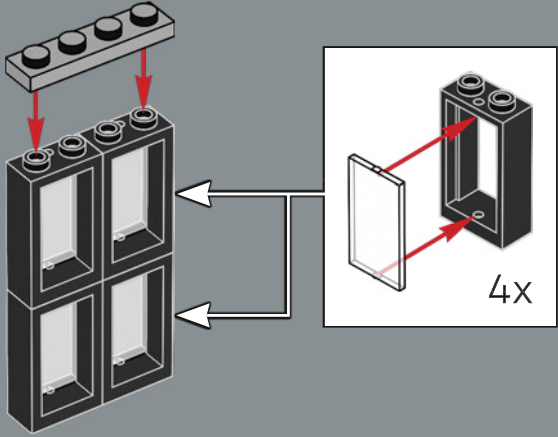

2

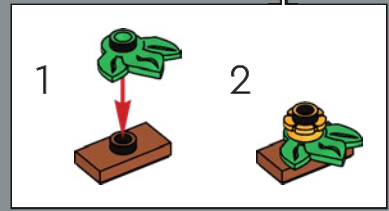
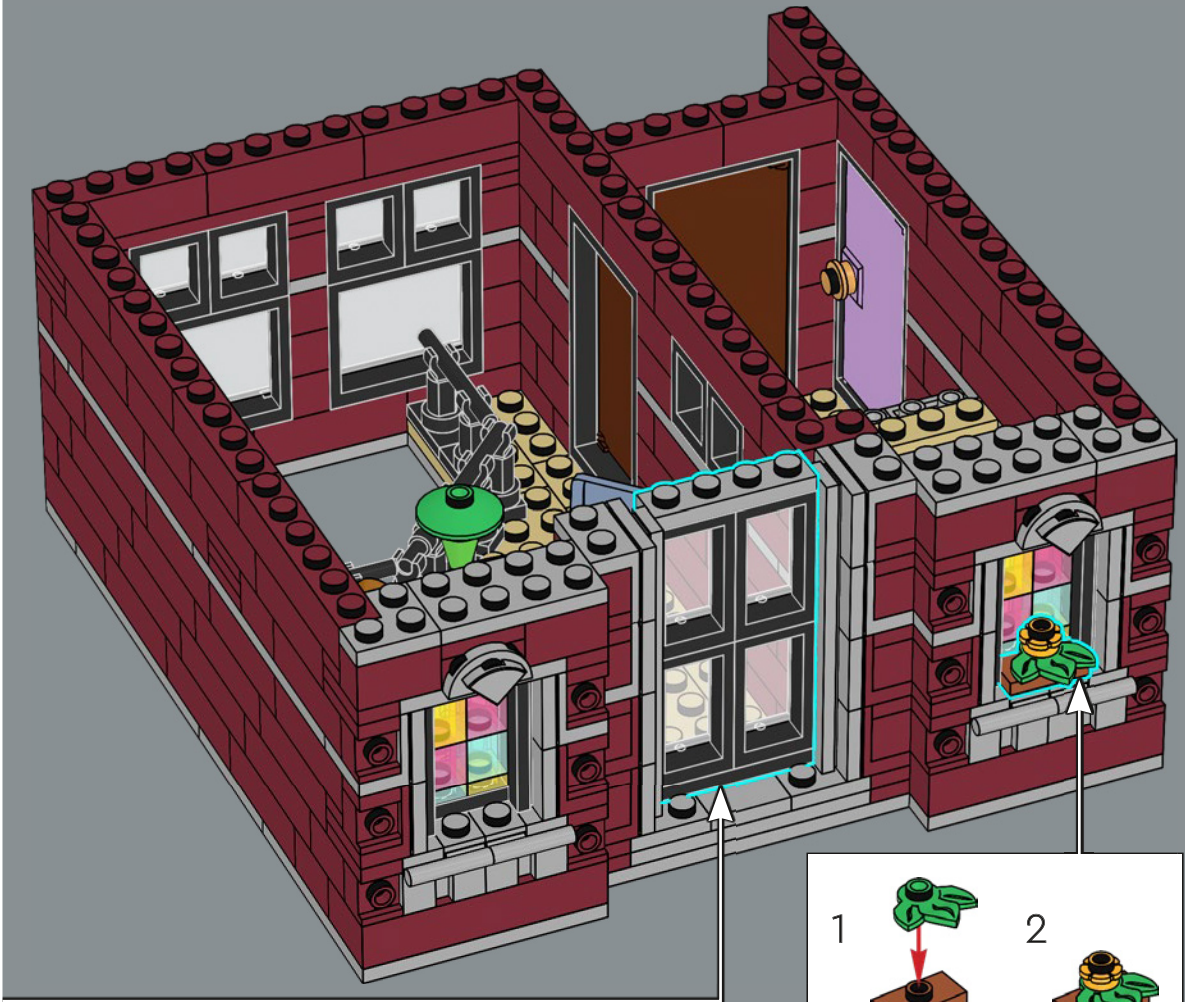
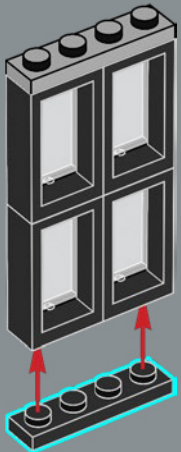

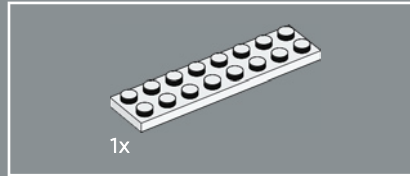
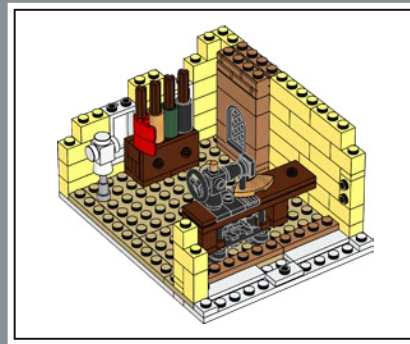

1x

218

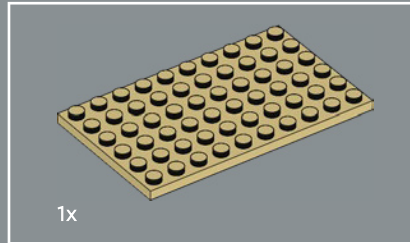

1x

219

Have you purchased a new outfit at the LEGO® 10211 Grand Emporium, but it just doesn't fit right? Visit the tailor, who will be happy to assist you.

Vous avez acheté une nouvelle tenue au Grand magasin LEGO® 10211, mais elle ne vous va pas bien ? Rendez visite au tailleur, qui se fera un plaisir de vous aider.

¿Compraste un nuevo atuendo en el Grand Emporium LEGO® (10211), pero no te quedó? Visita al sastre, que estará encantado de atenderte como lo mereces.

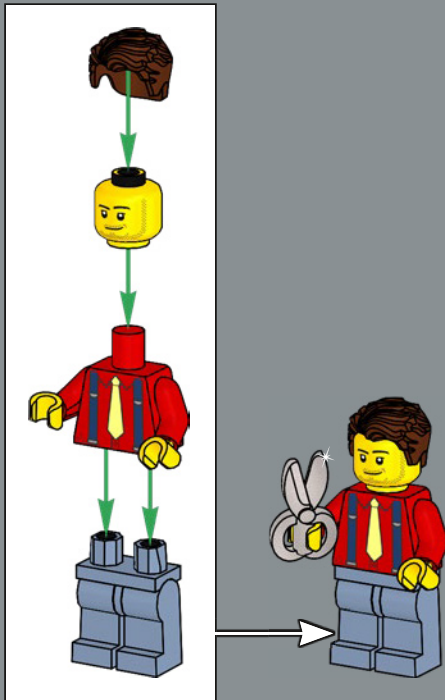
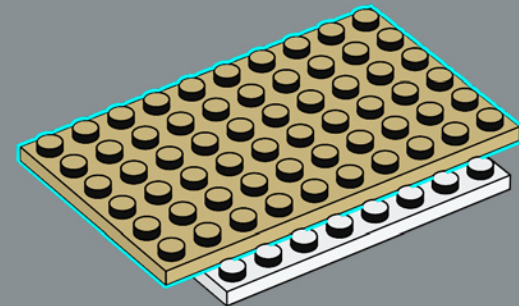
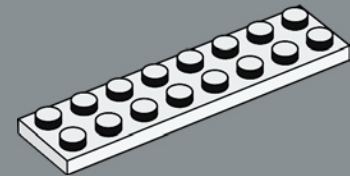

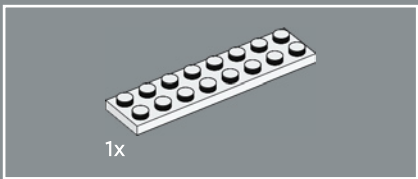

220

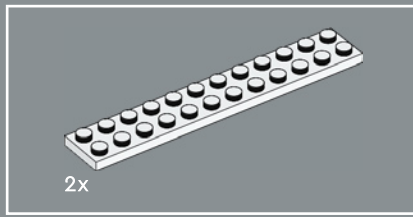
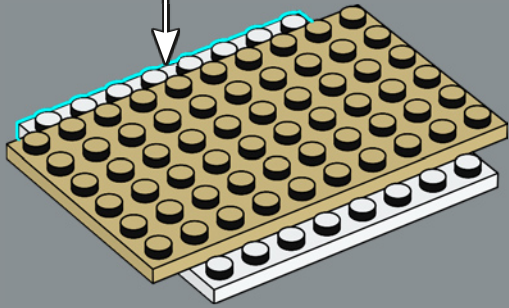
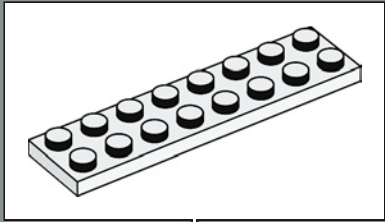

221

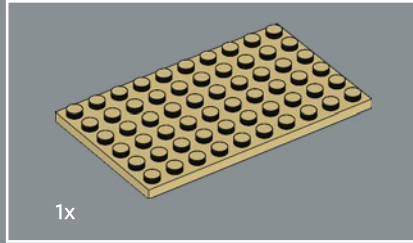
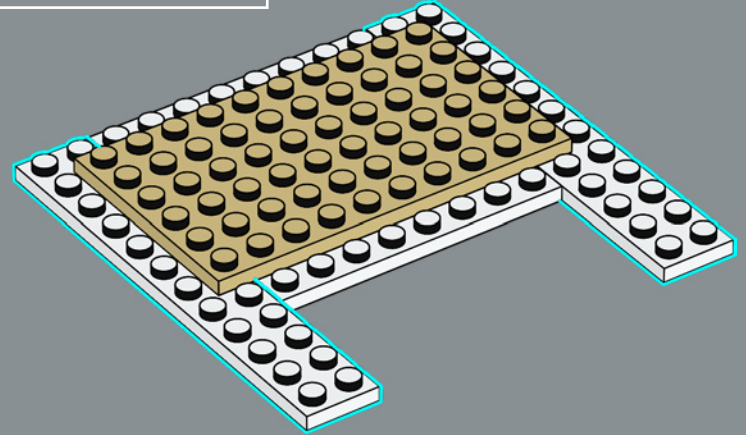

222

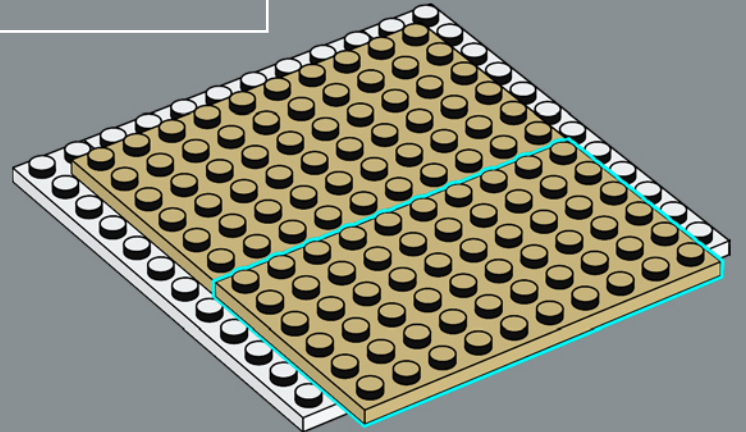

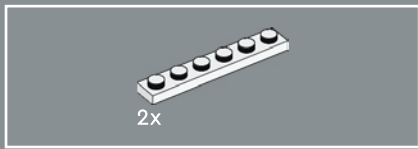

223

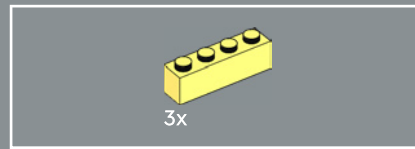
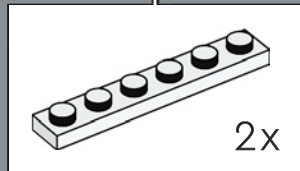
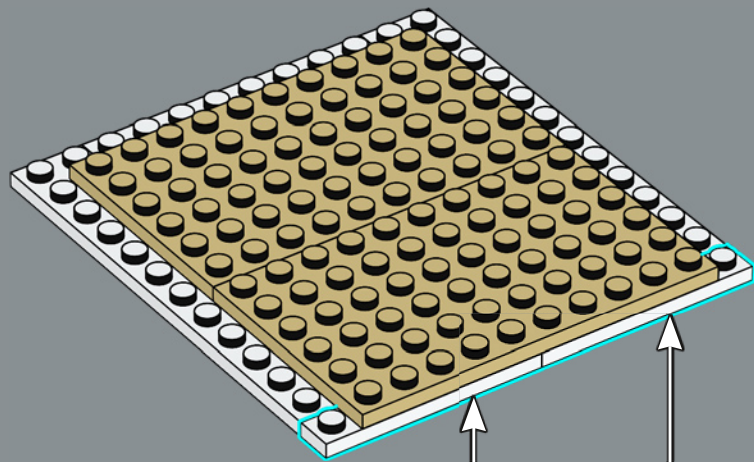

224

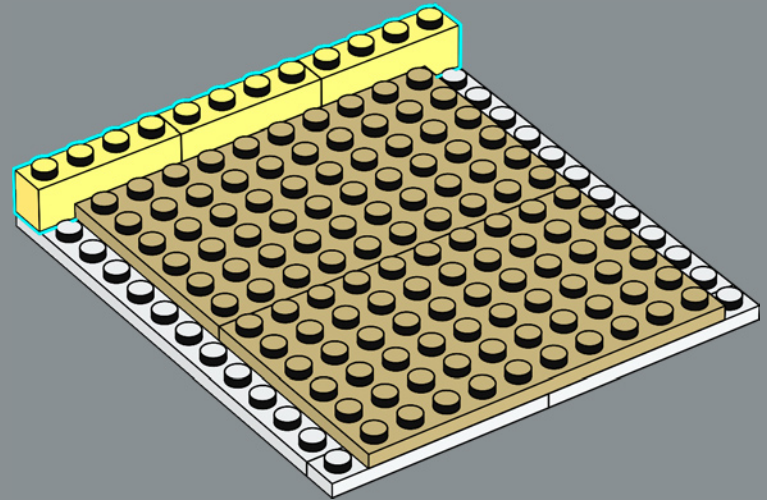

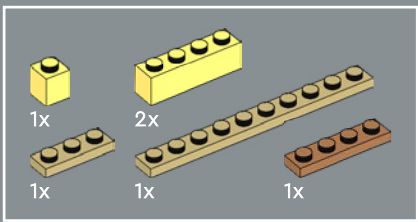

225

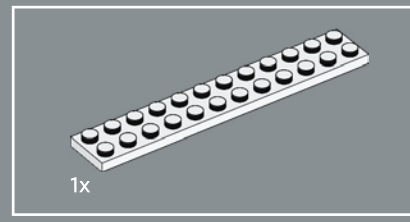
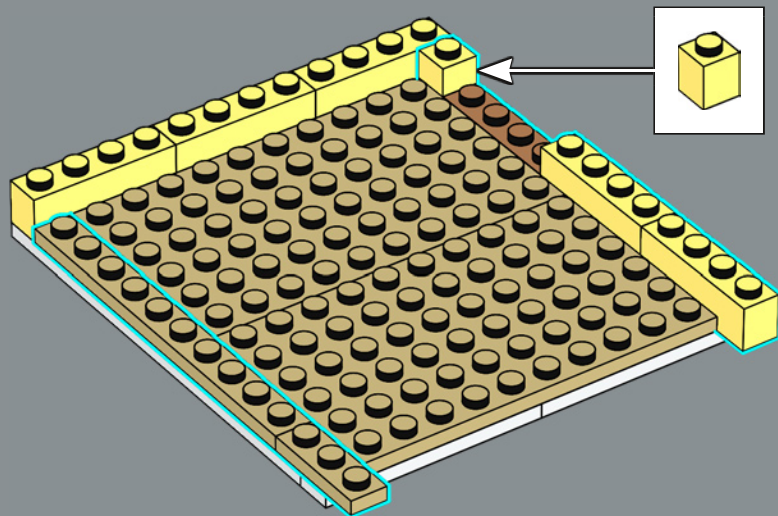

226

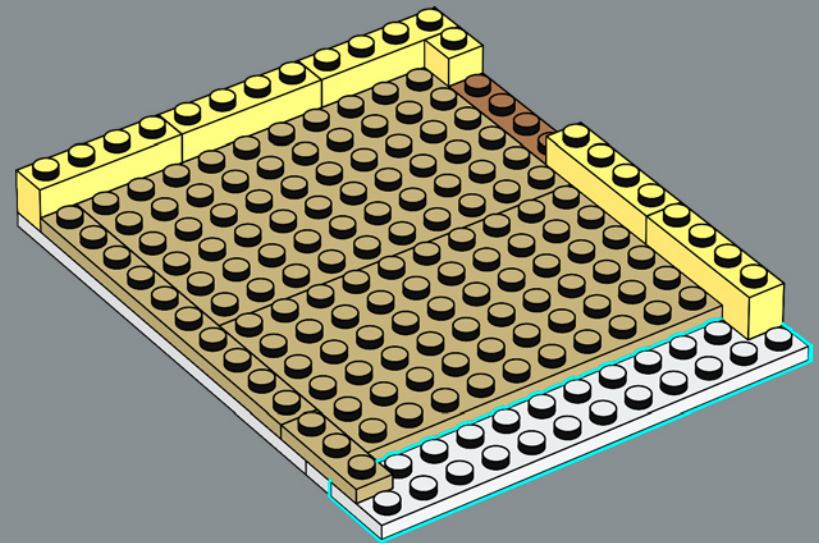

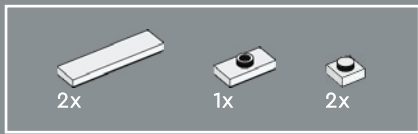

227

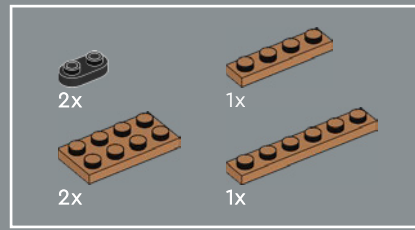
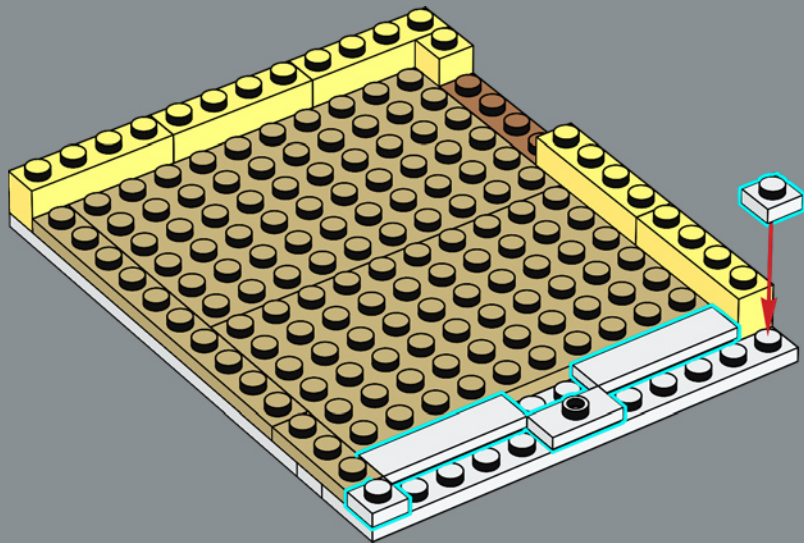

228

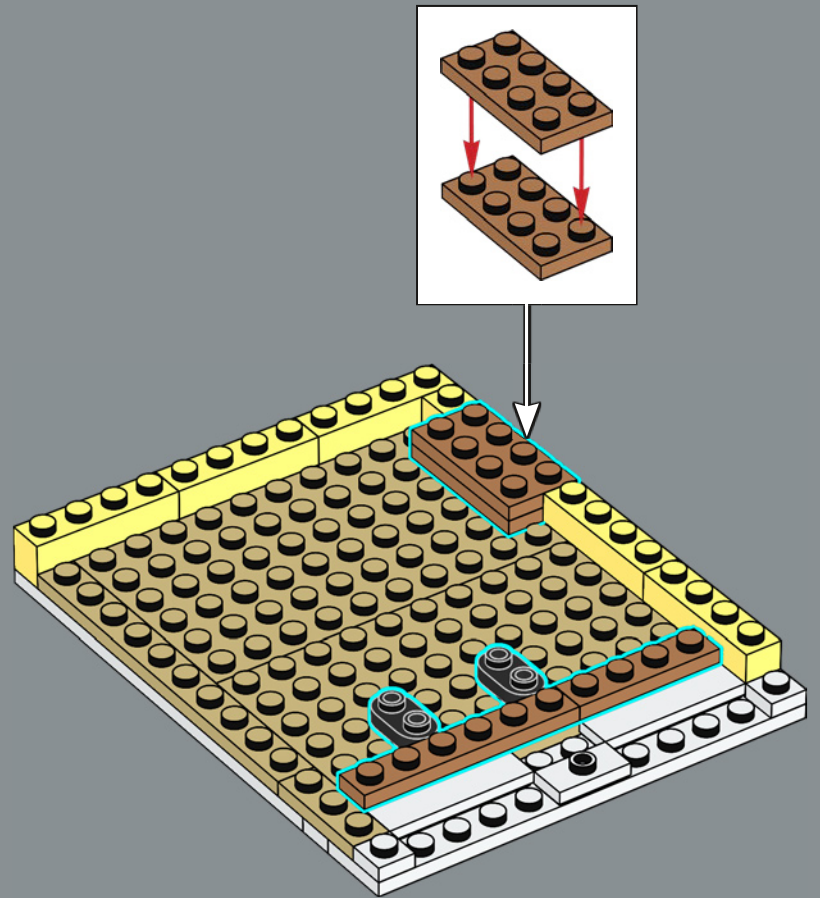

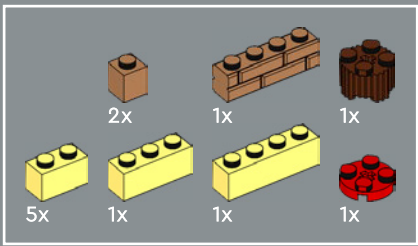

229

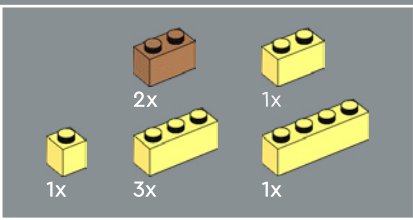
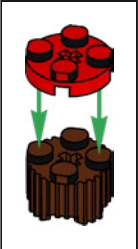

230

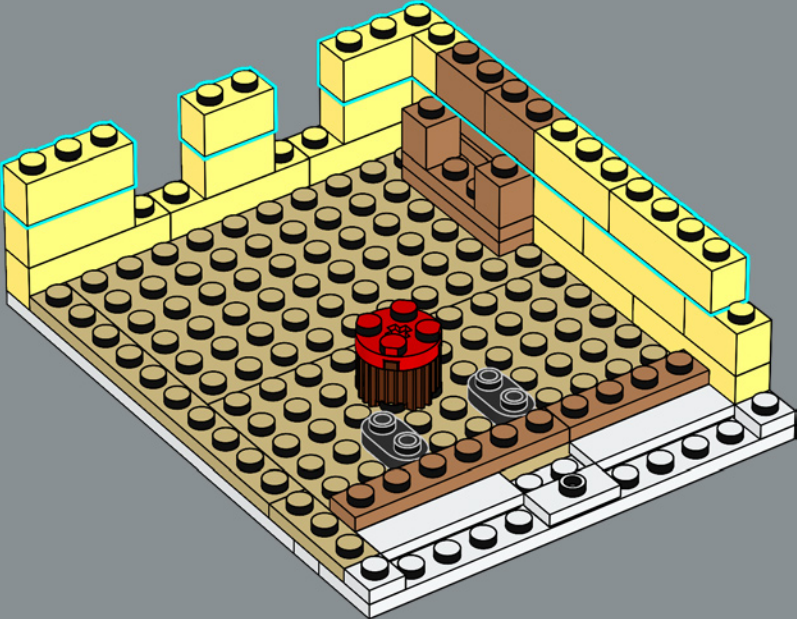



231

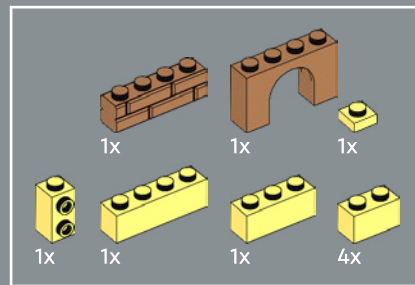
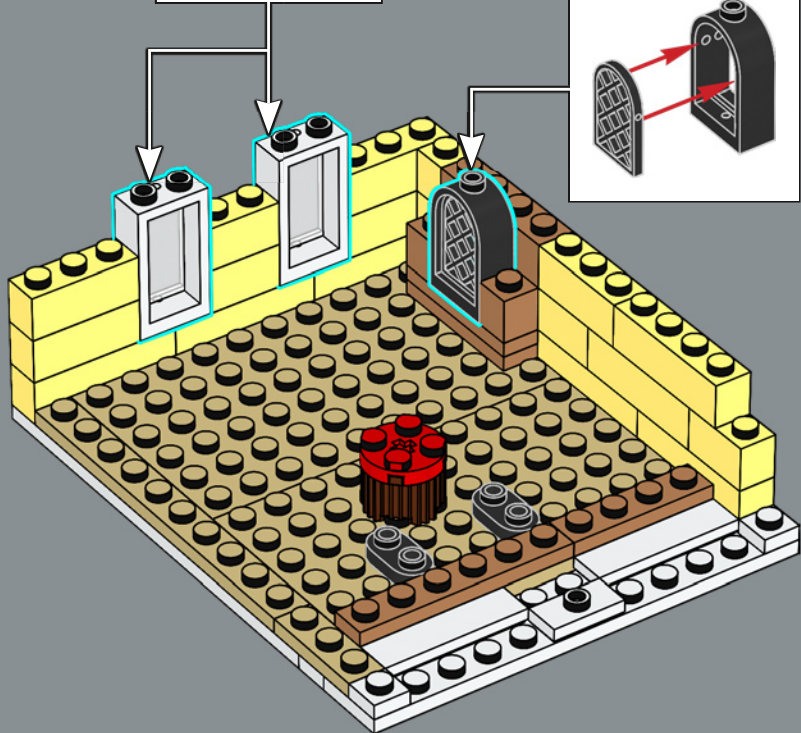
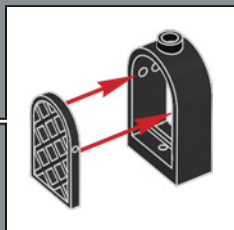
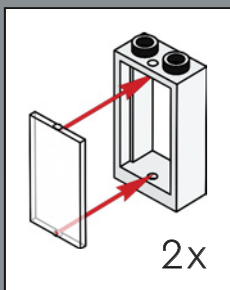

232

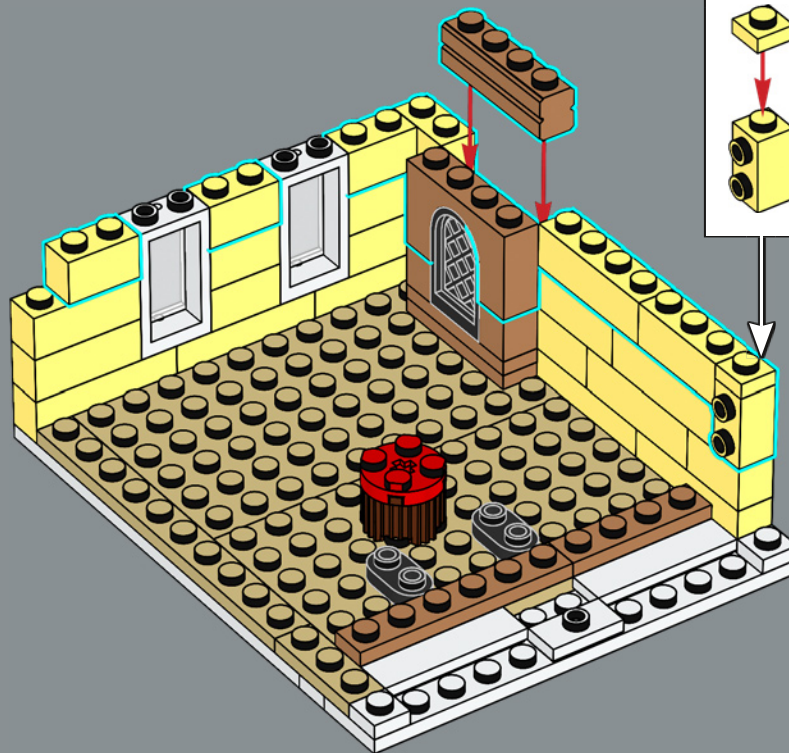
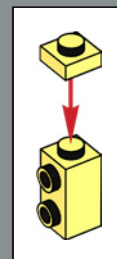

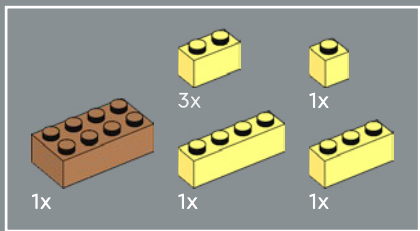

233

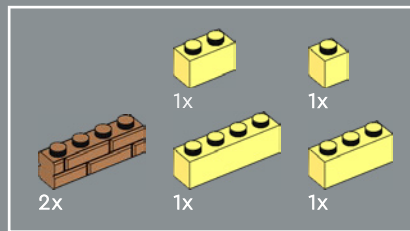
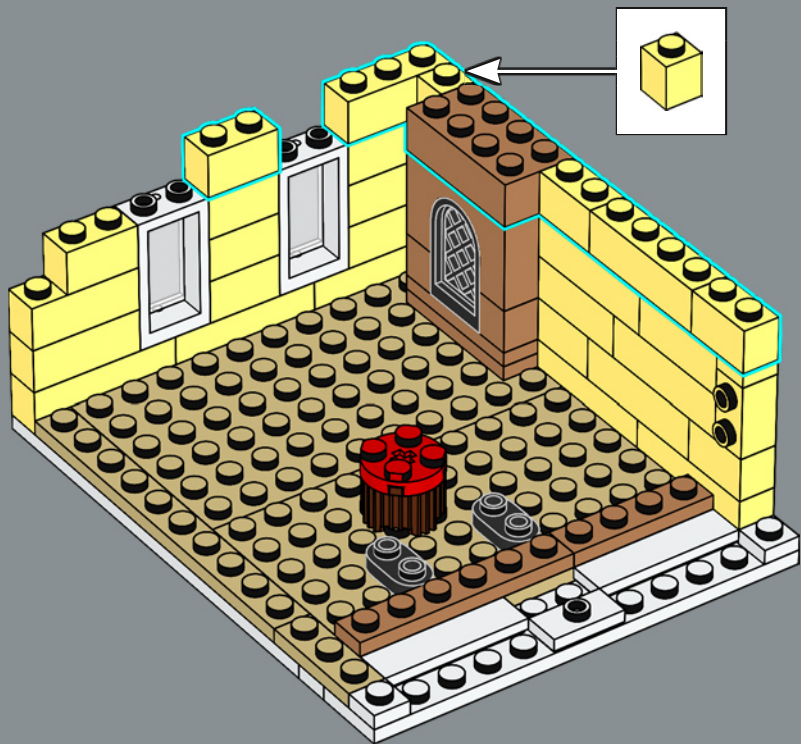

234

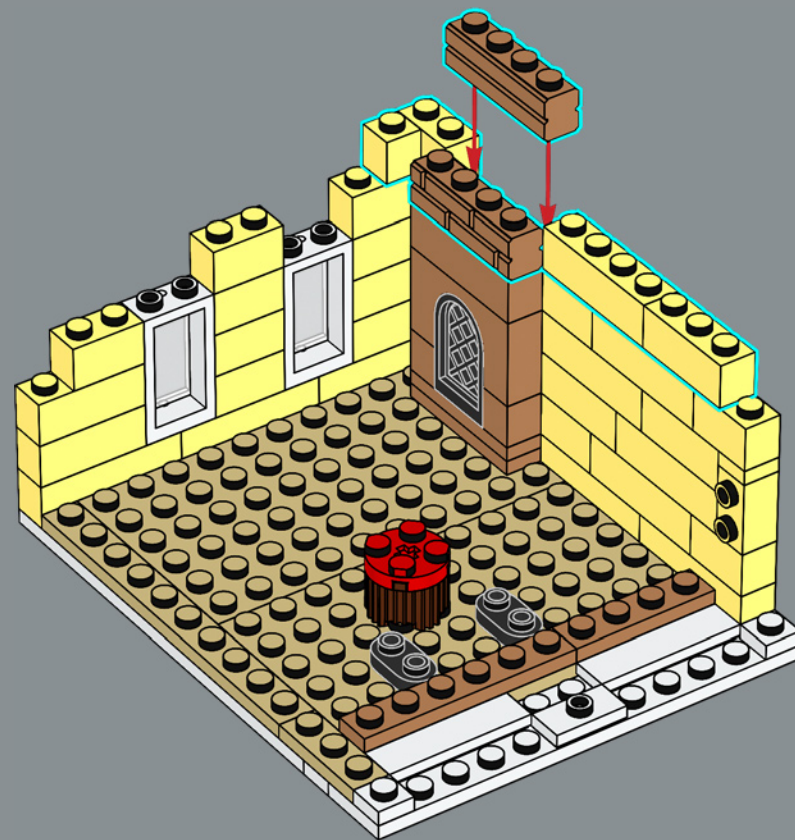

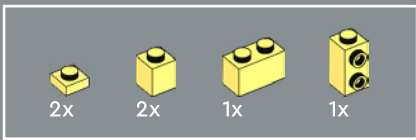

235

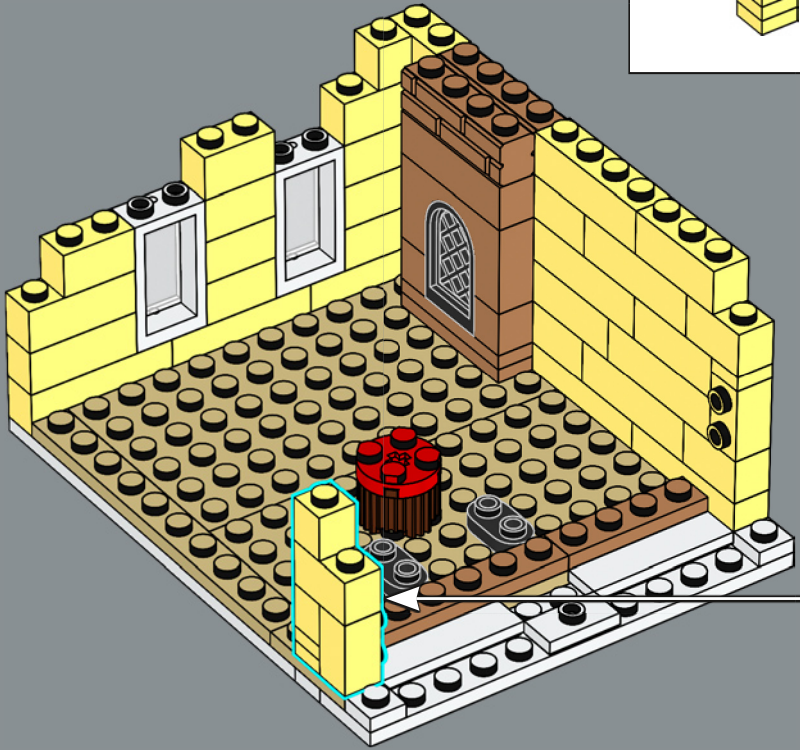
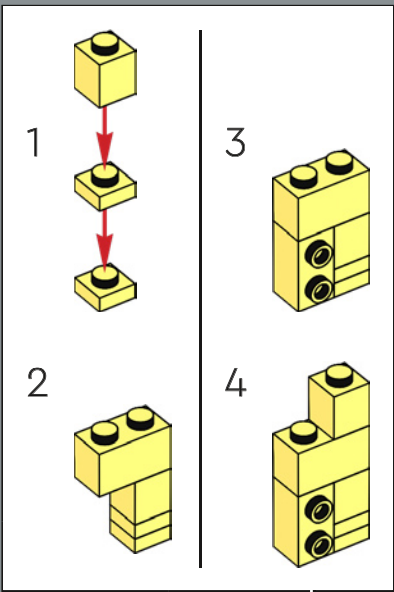

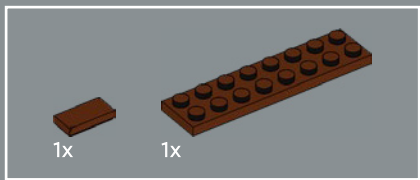

236

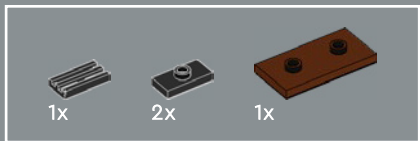
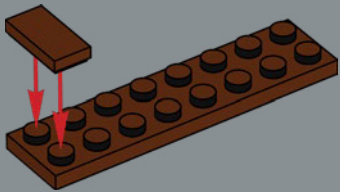

237

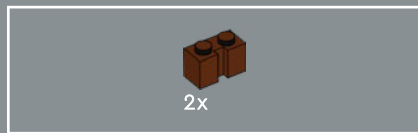
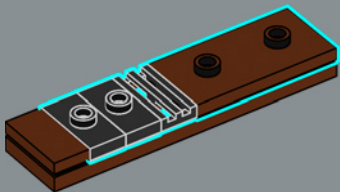

238

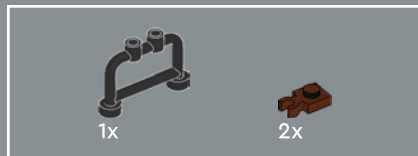
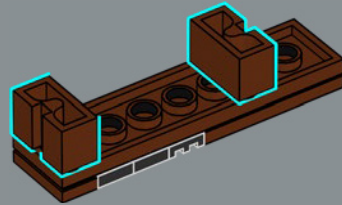

239

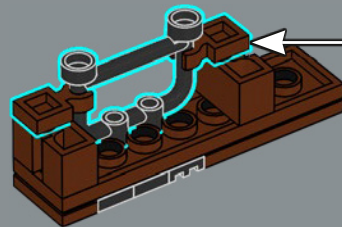
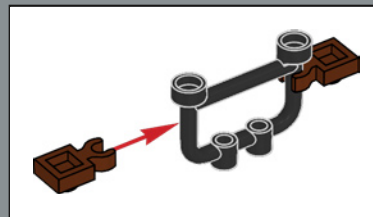

240

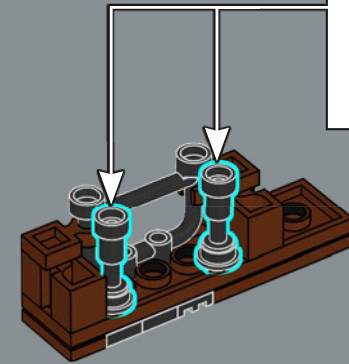
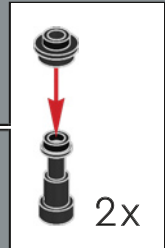

241

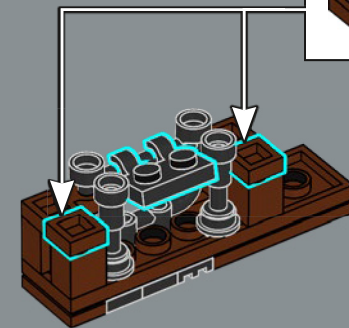



242

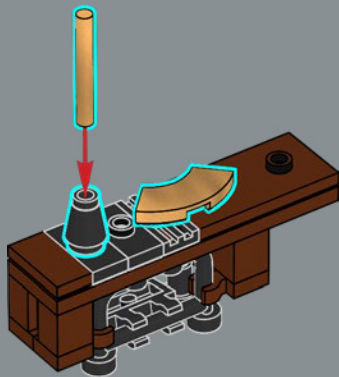

243

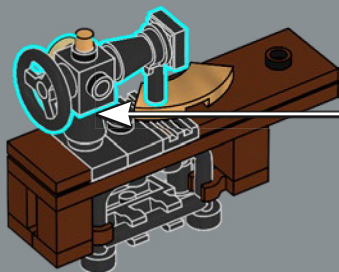
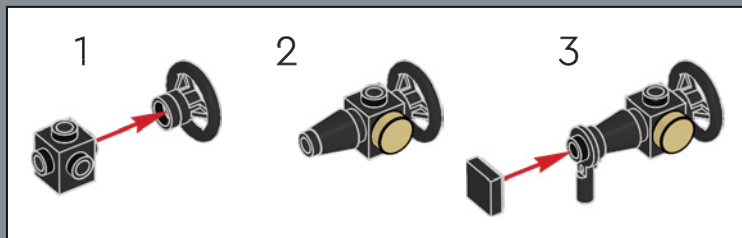

The tailor has just finished the singer's gown; golden thread and fabric are still left on the sewing machine!

Le tailleur vient de terminer la robe de la chanteuse; il reste encore du fil doré et du tissu sur la machine à coudre !

Este profesional acaba de terminar el vestido de la cantante; ¡todavía hay hilo y tela dorados encima de su máquina de coser!

244

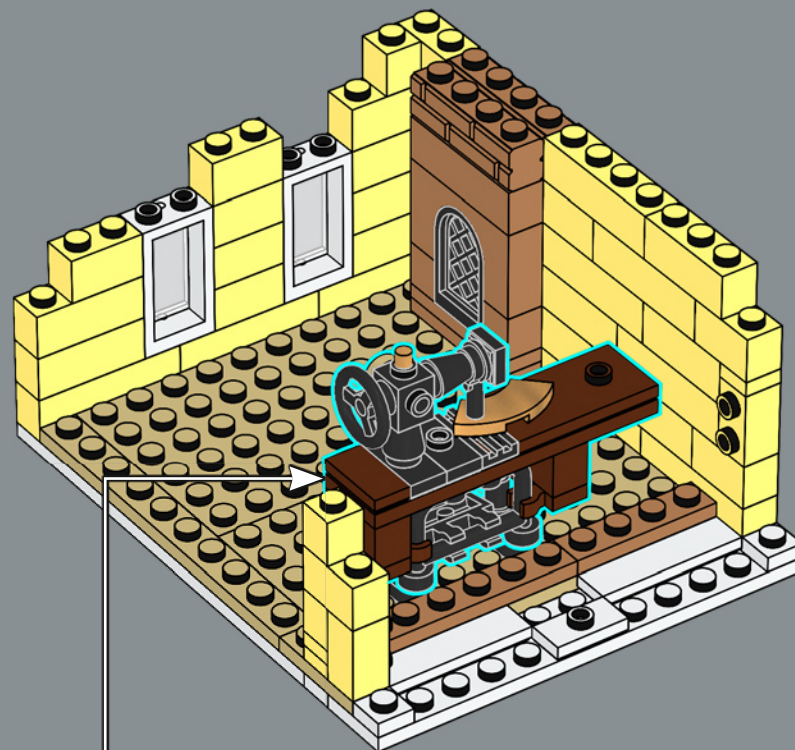

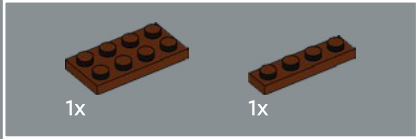

245

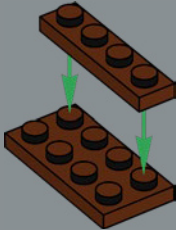

246

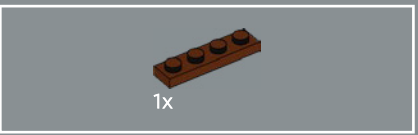
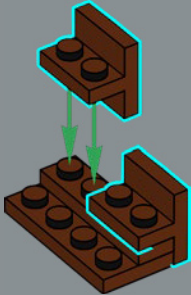

247

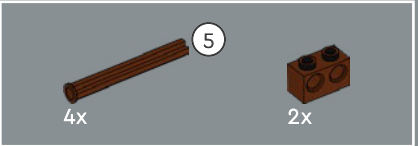
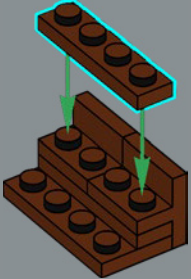

248

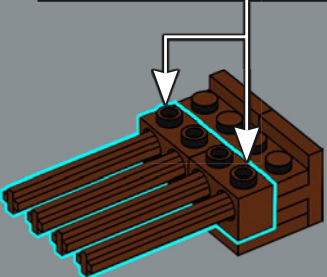
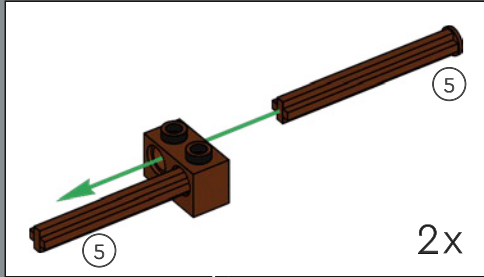

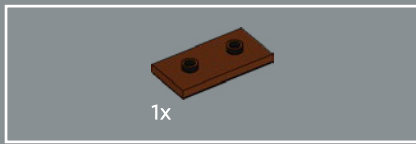

1x

249

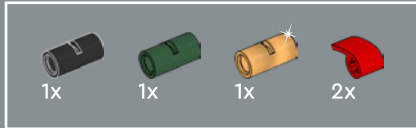
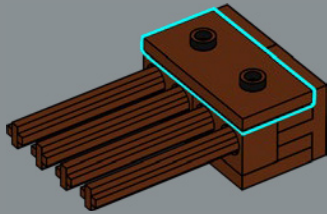

1x

1x

1x

2x

250

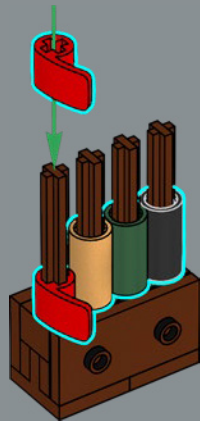

The elements making up the red cloth first appeared as elements in LEGO® Technic™ sets.

Les éléments composant le tissu rouge sont apparus pour la première fois dans les ensembles LEGO® Technic™.

Los elementos que componen el tejido rojo aparecieron por primera vez en sets LEGO® Technic™.

251

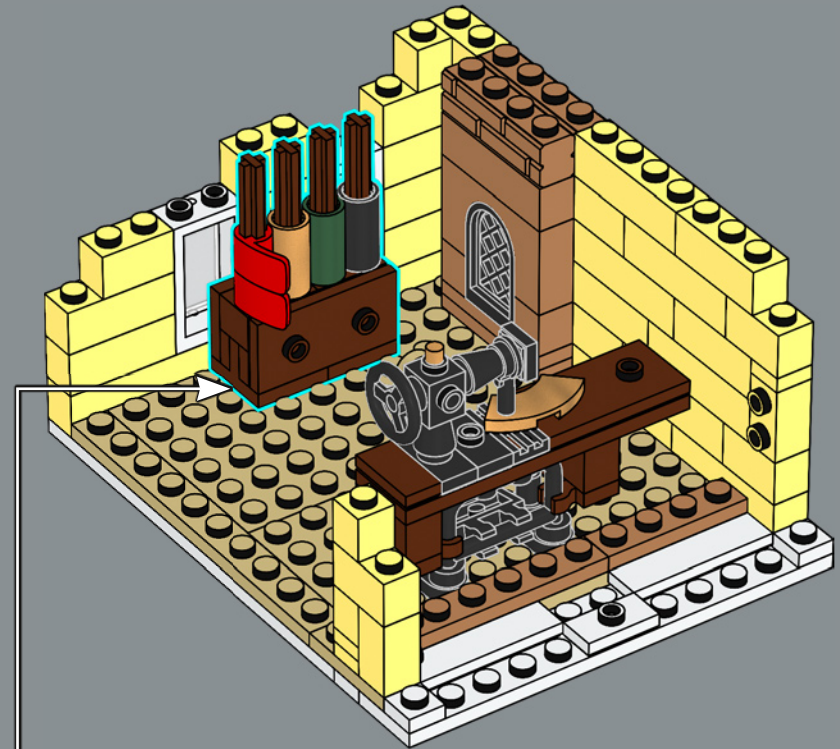

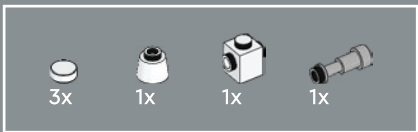

252

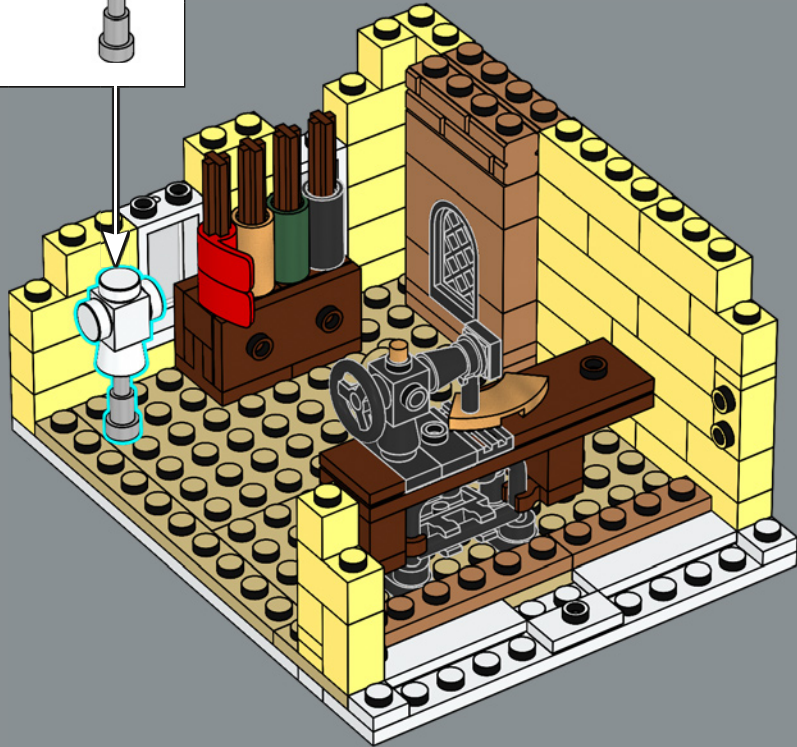
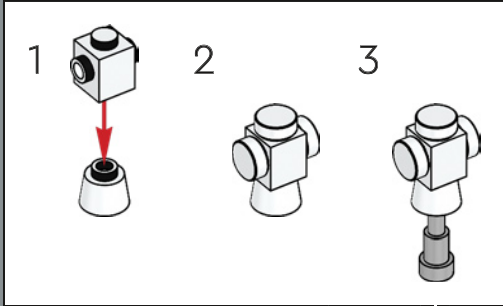

253

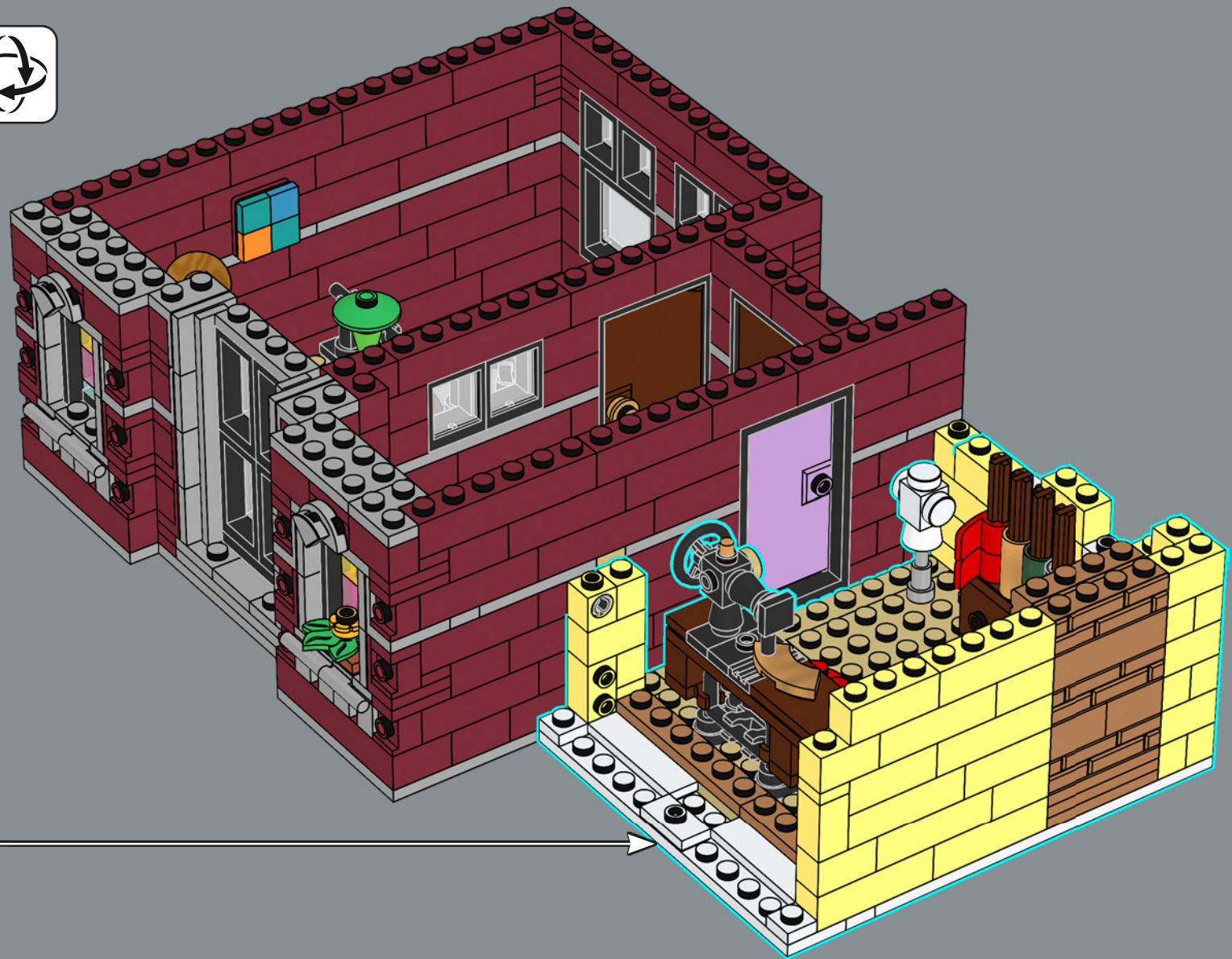

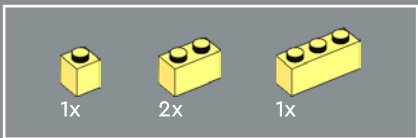

254

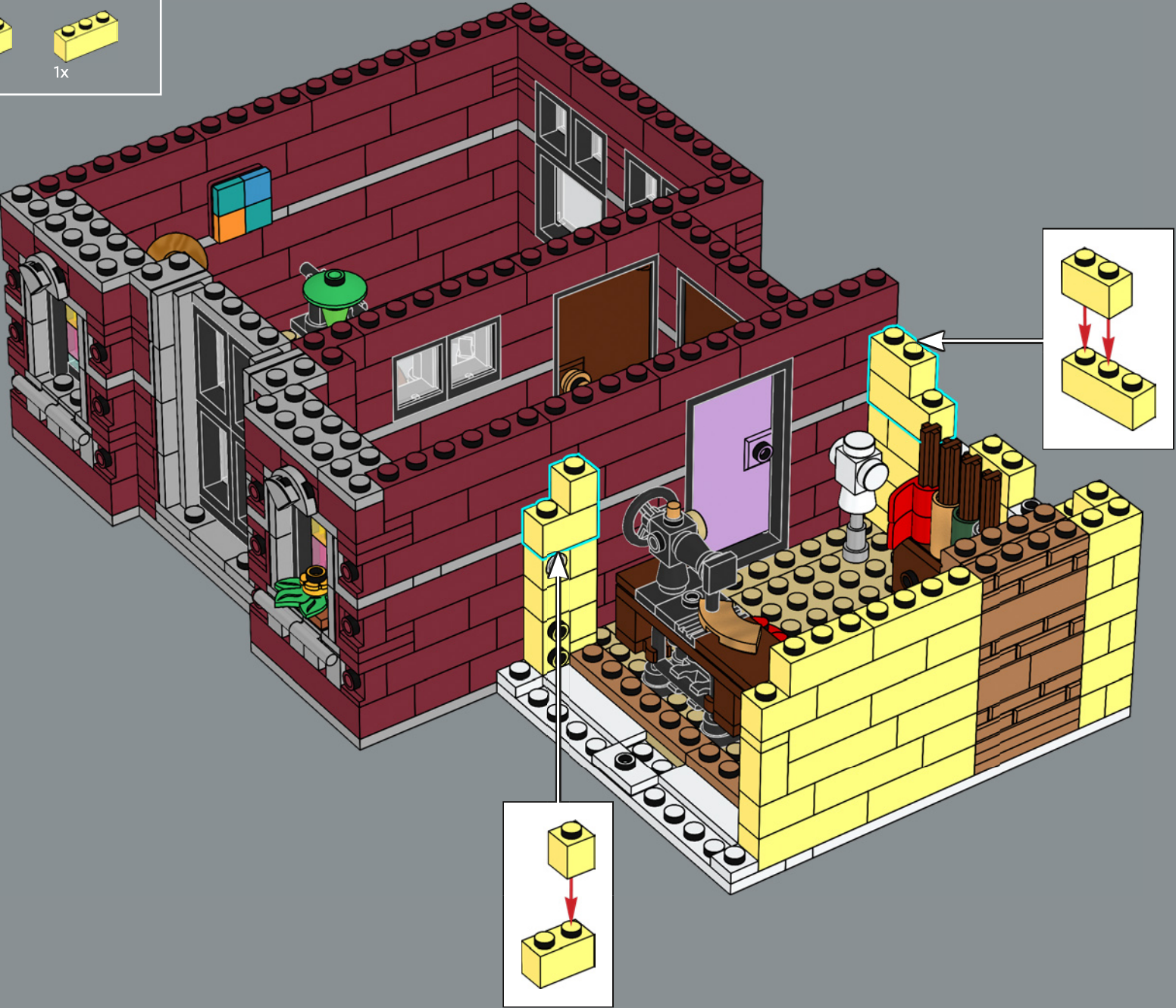

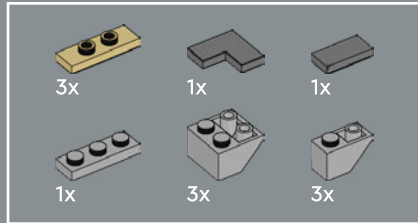

255

1

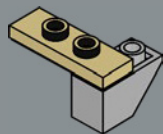

2

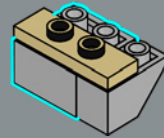

3

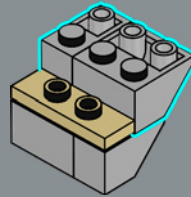

4

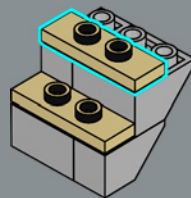

5

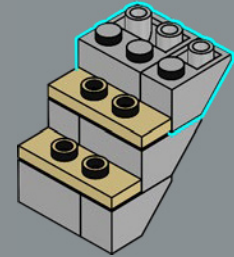

6

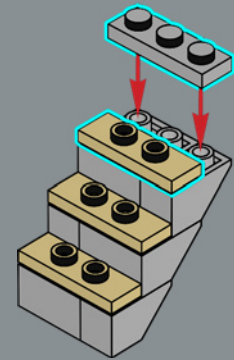

7

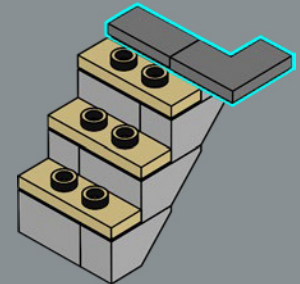





12x

256

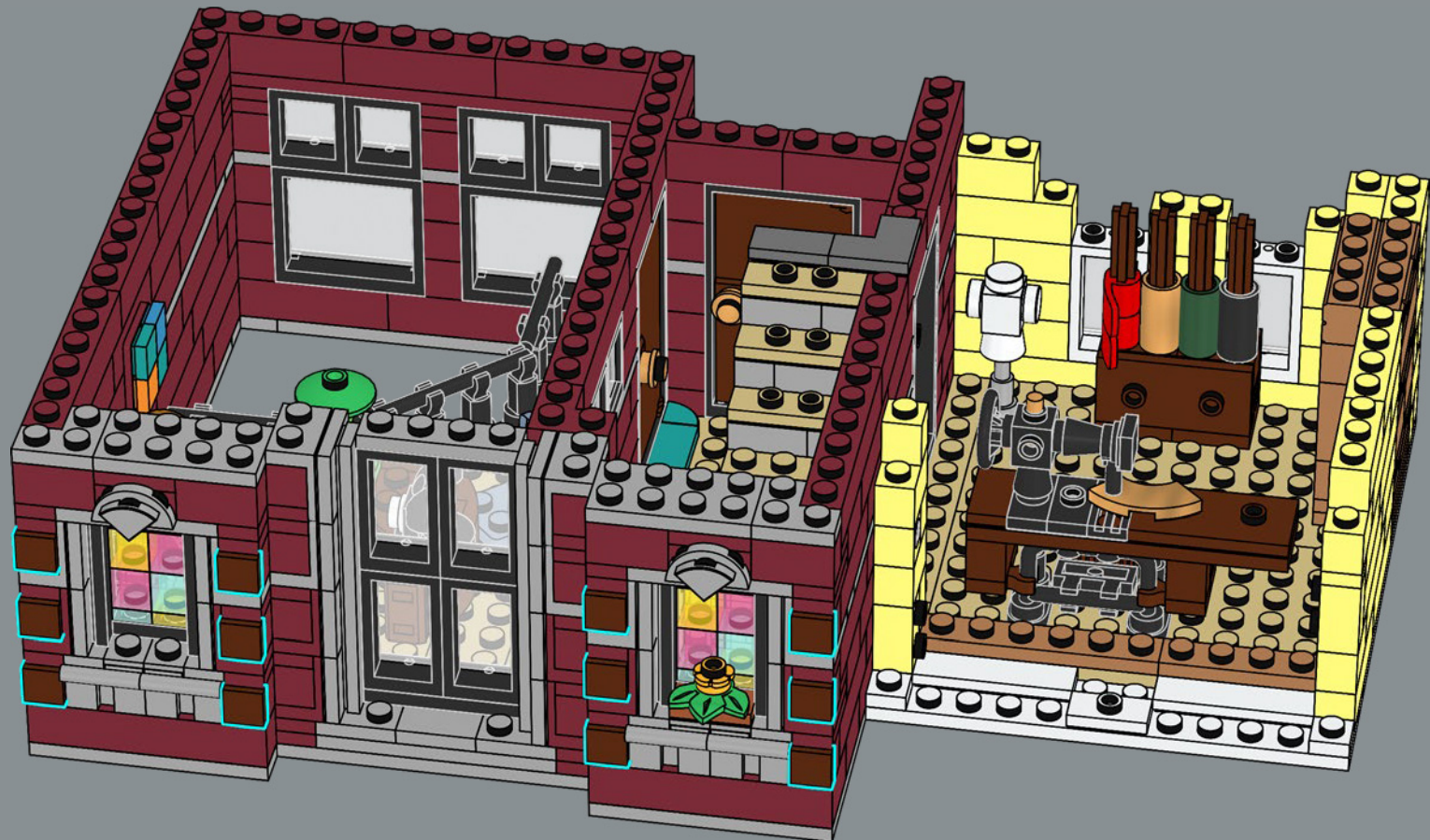

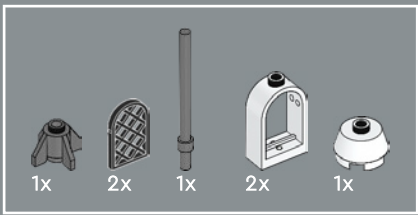

257

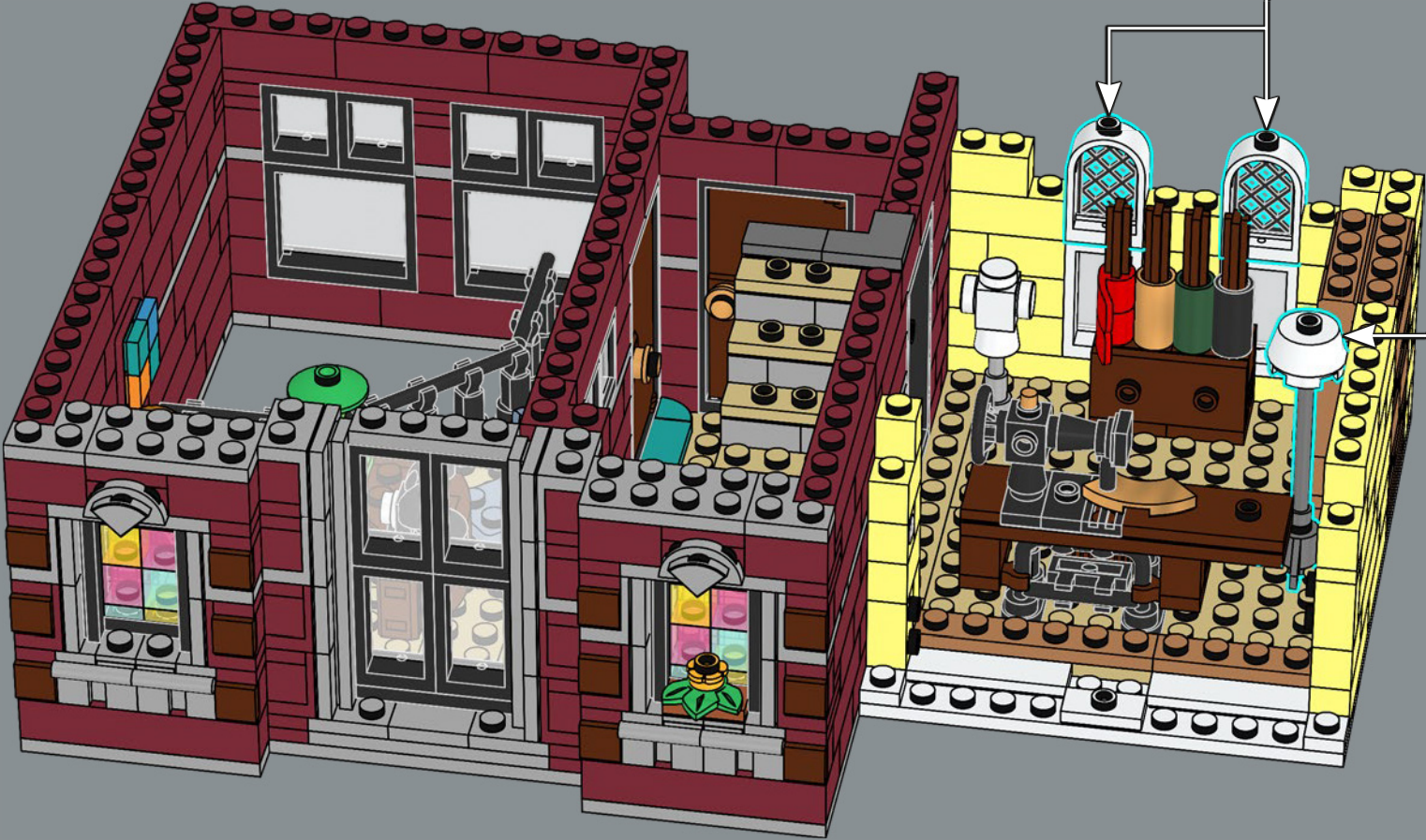
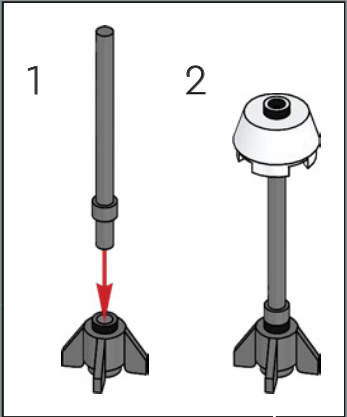
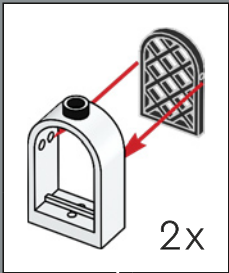

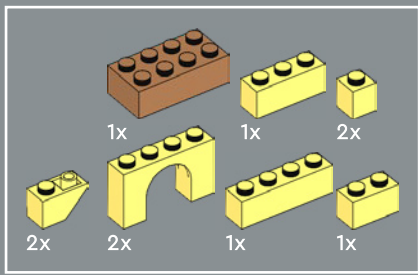

258

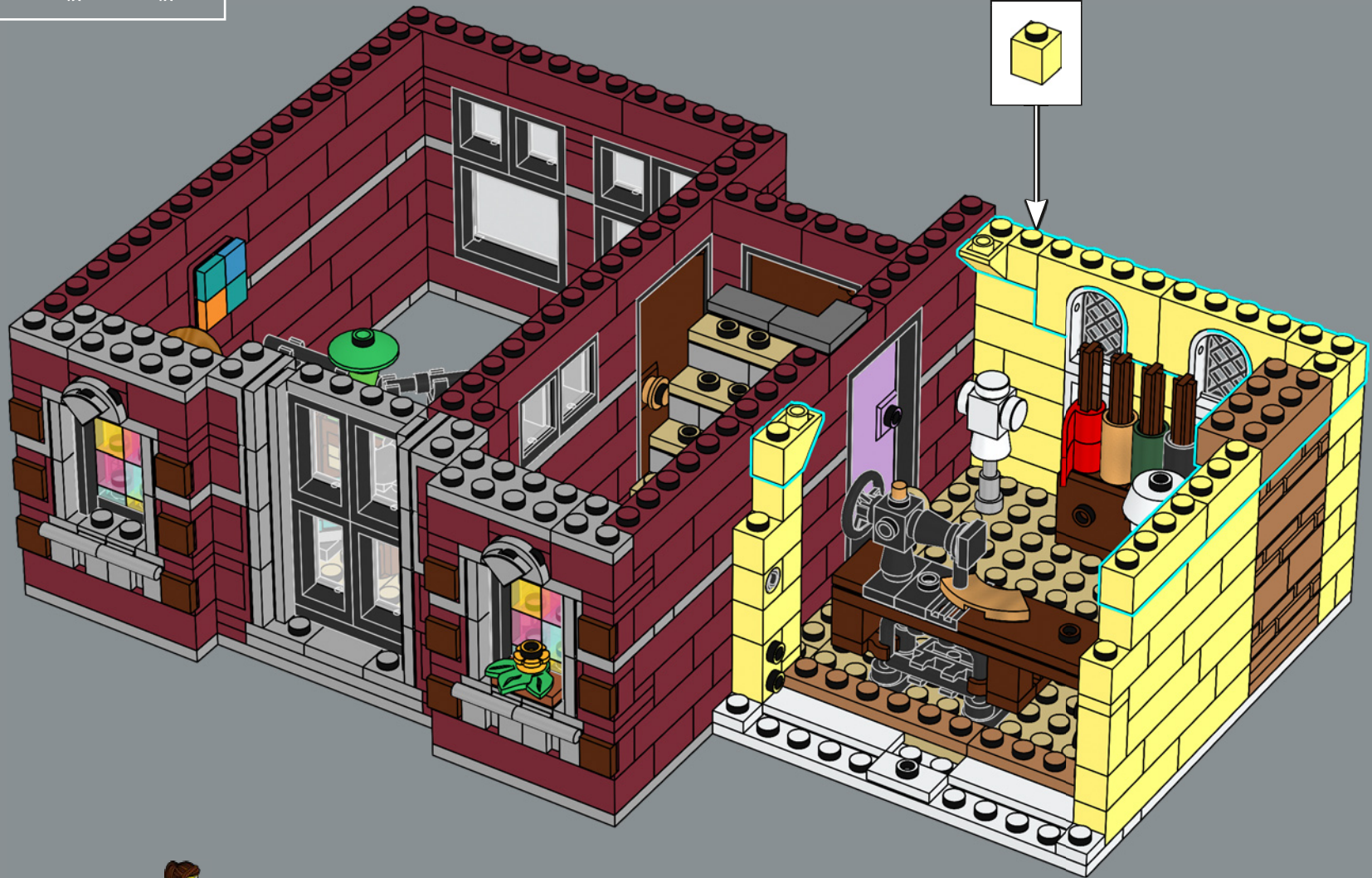



259

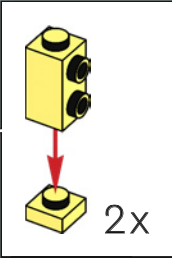
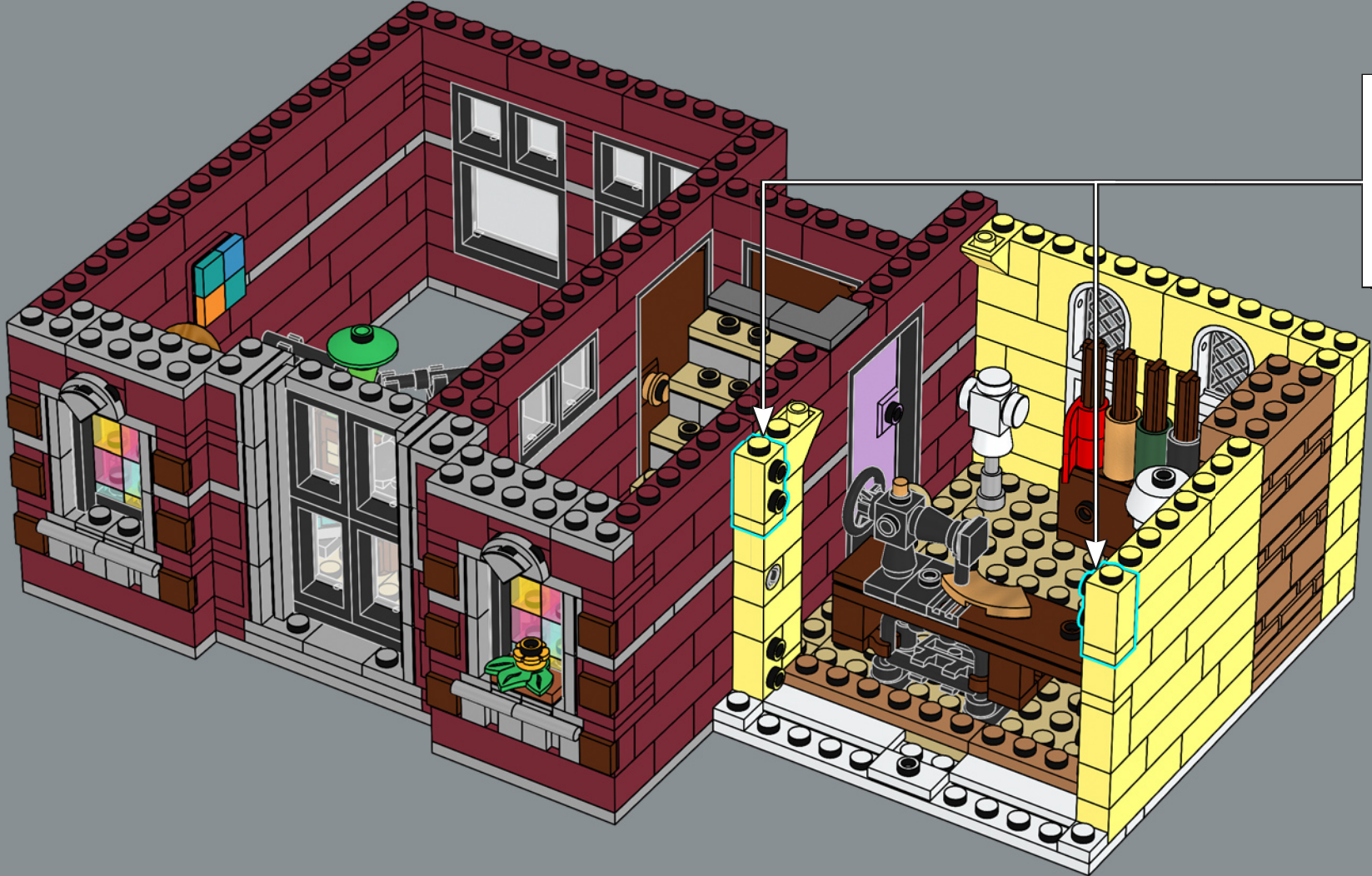

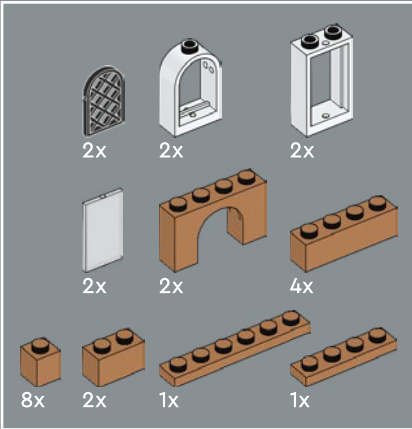
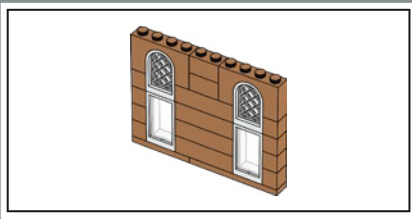

260

1

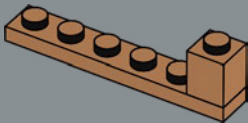

2

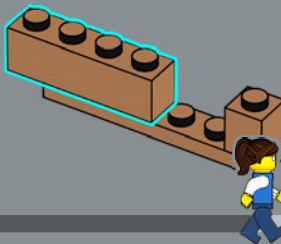

3

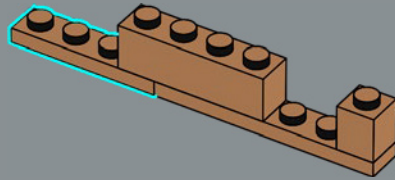

4

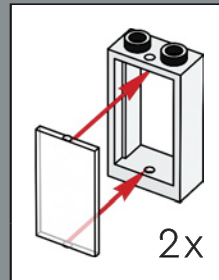
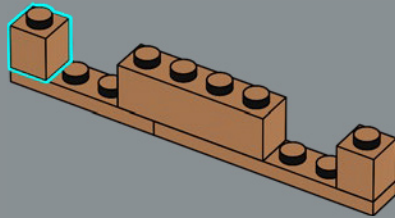

5

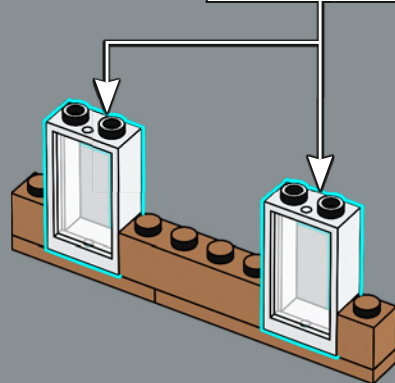

6

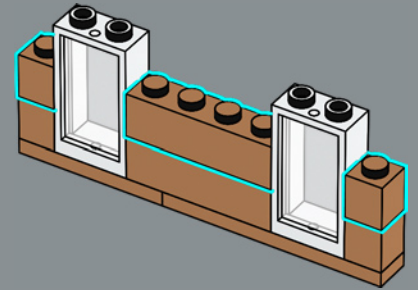

7

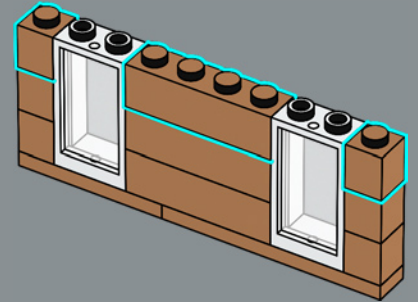

8

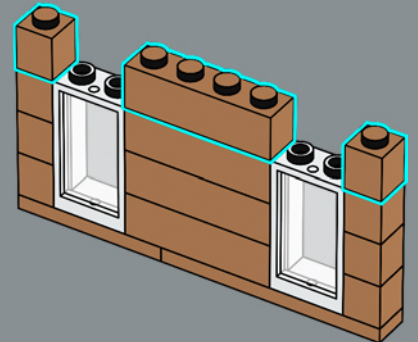

9

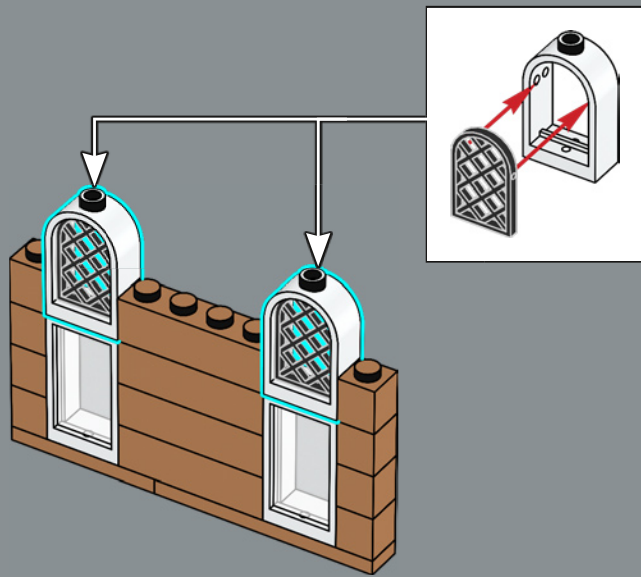

10

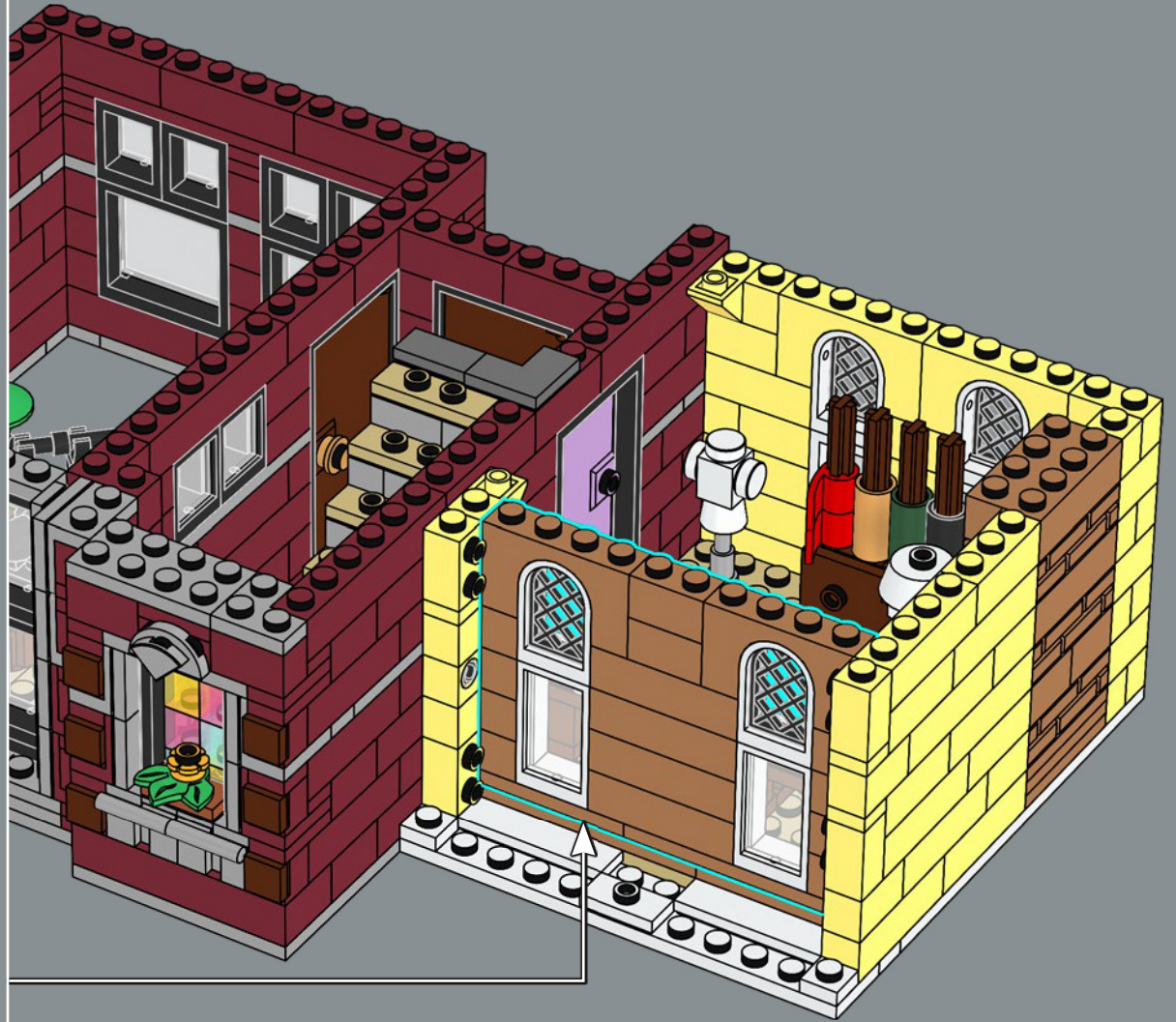
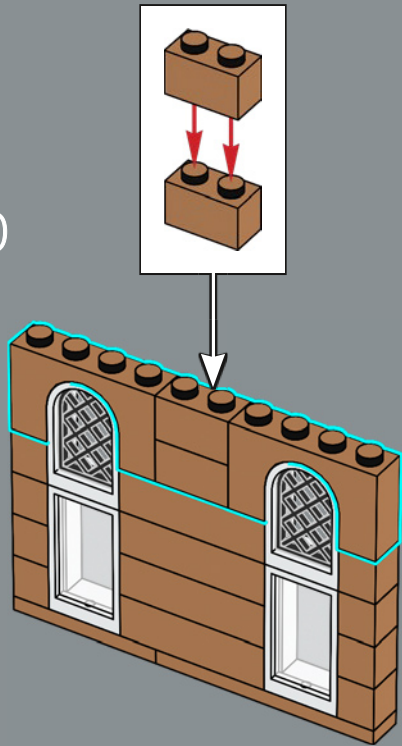

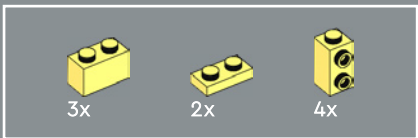

261

1

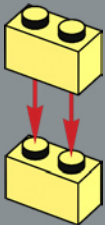

2

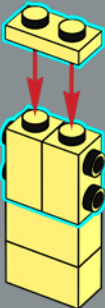

3

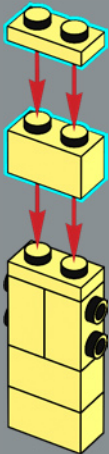

4

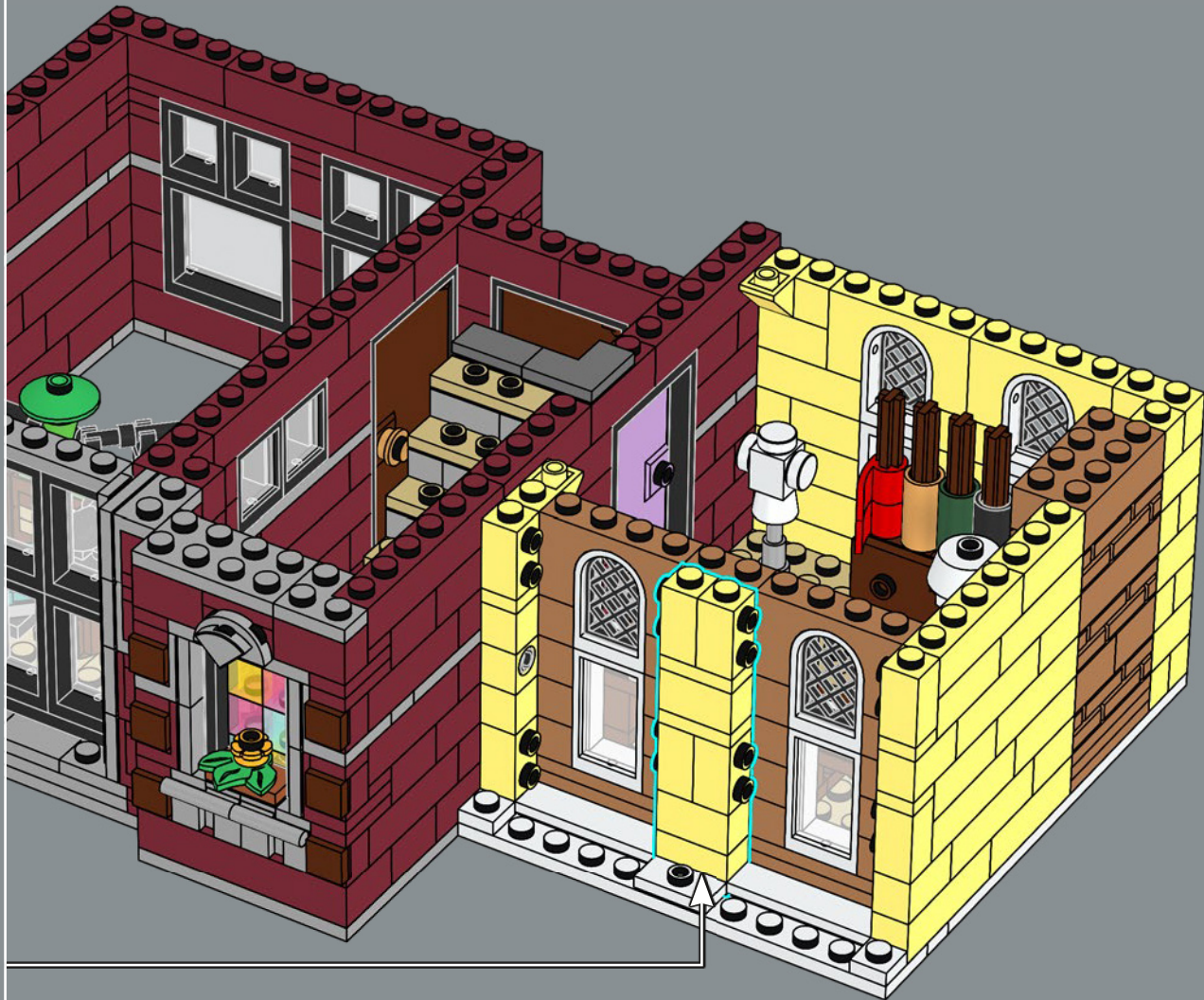
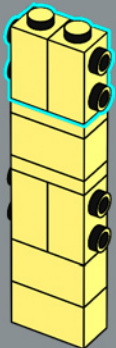

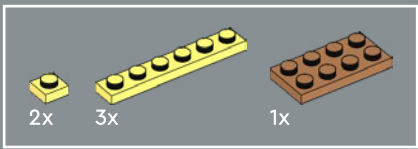

262



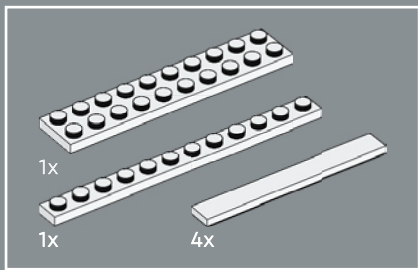

263

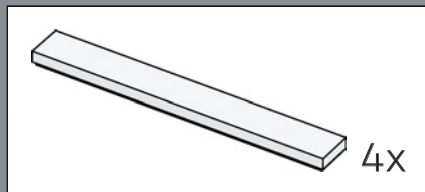

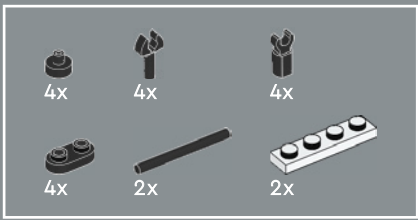

264

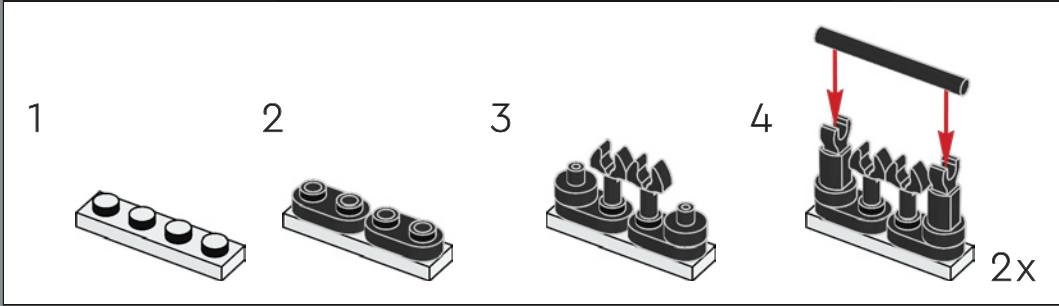
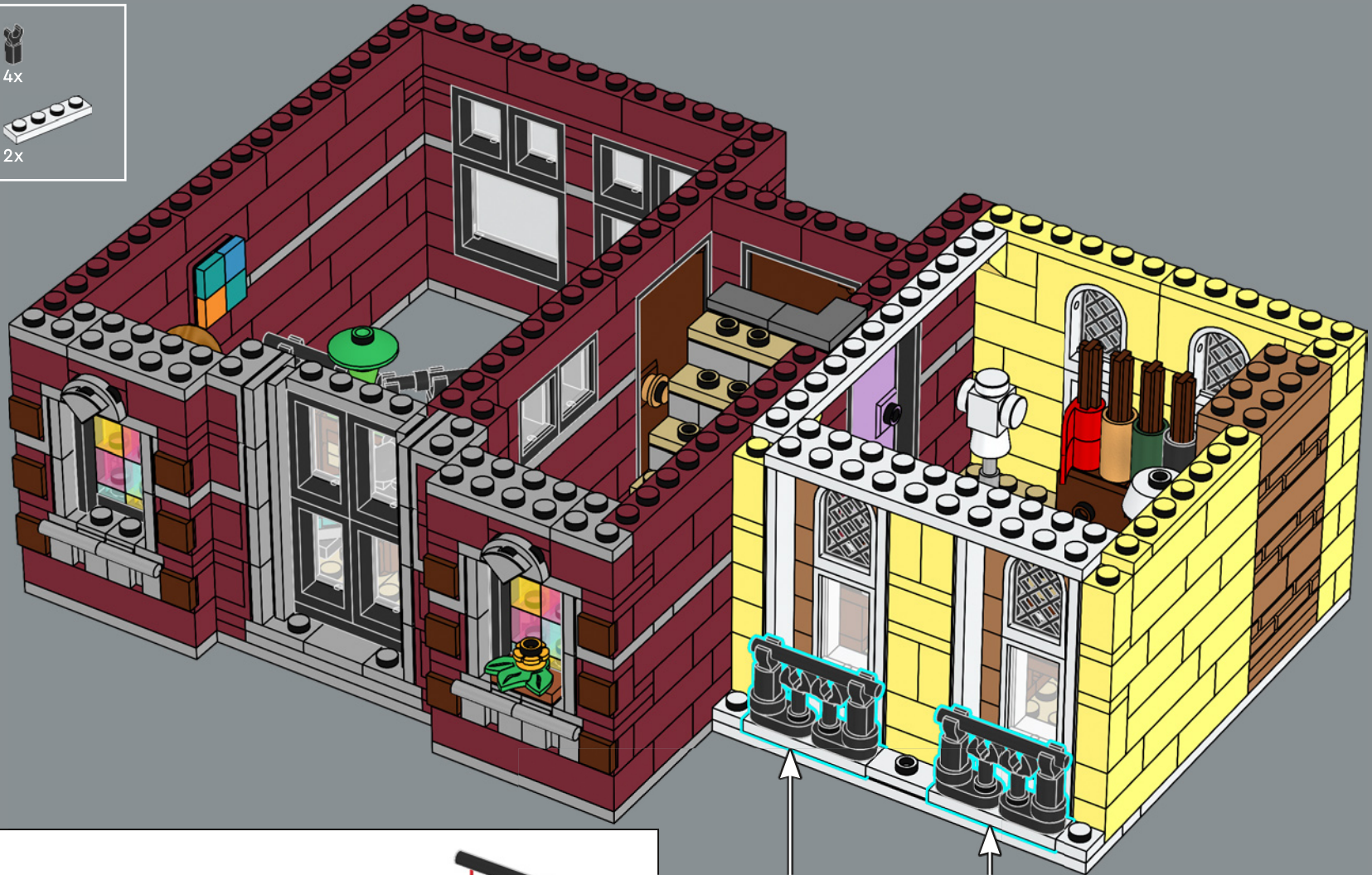

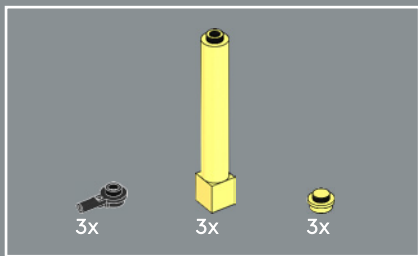

265

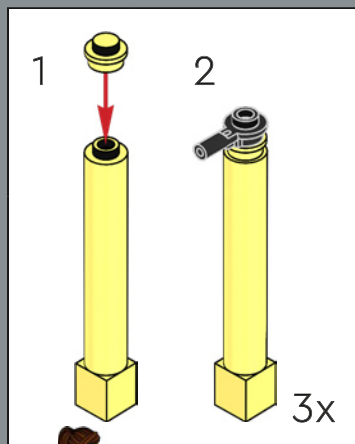
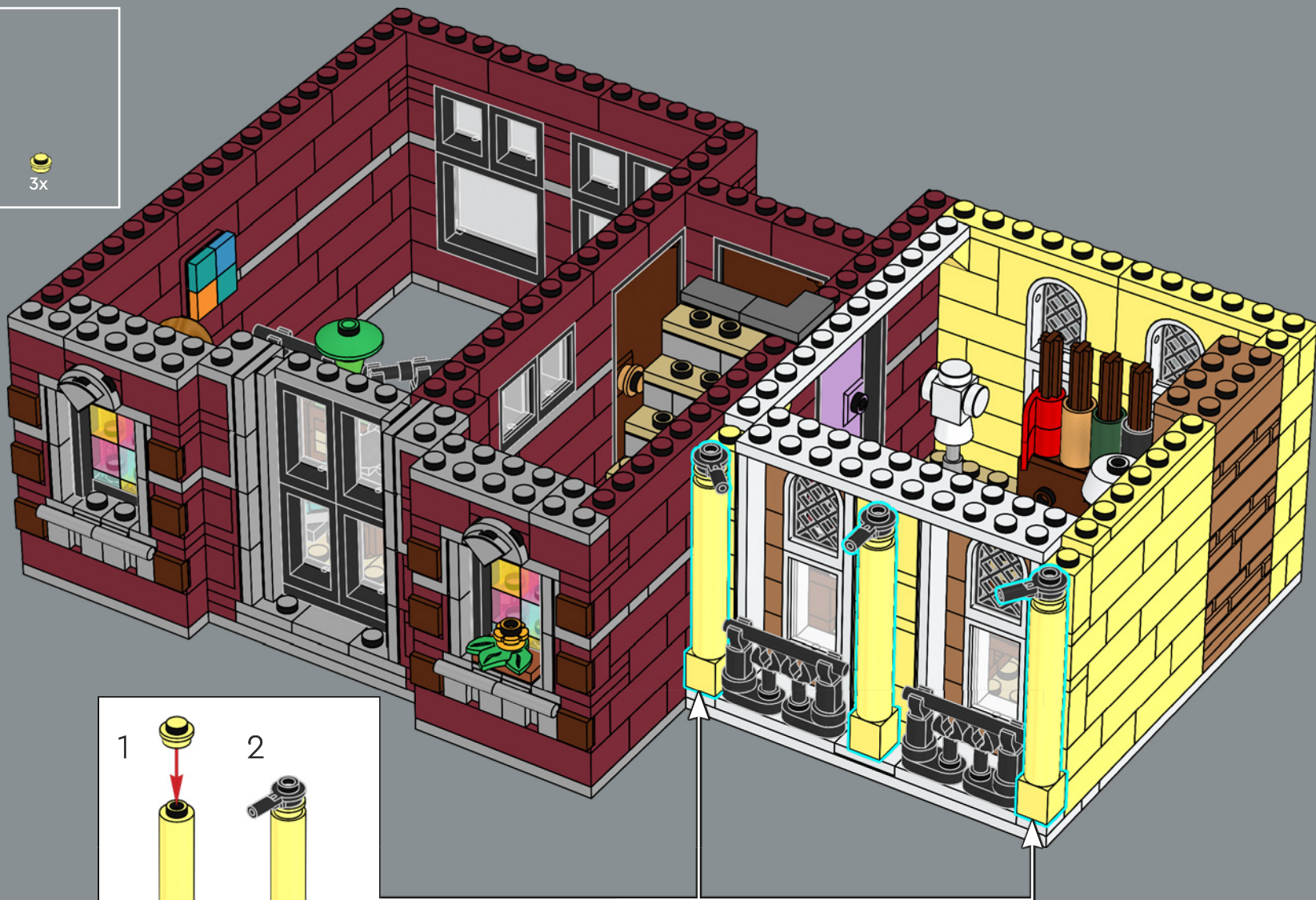



3x

266

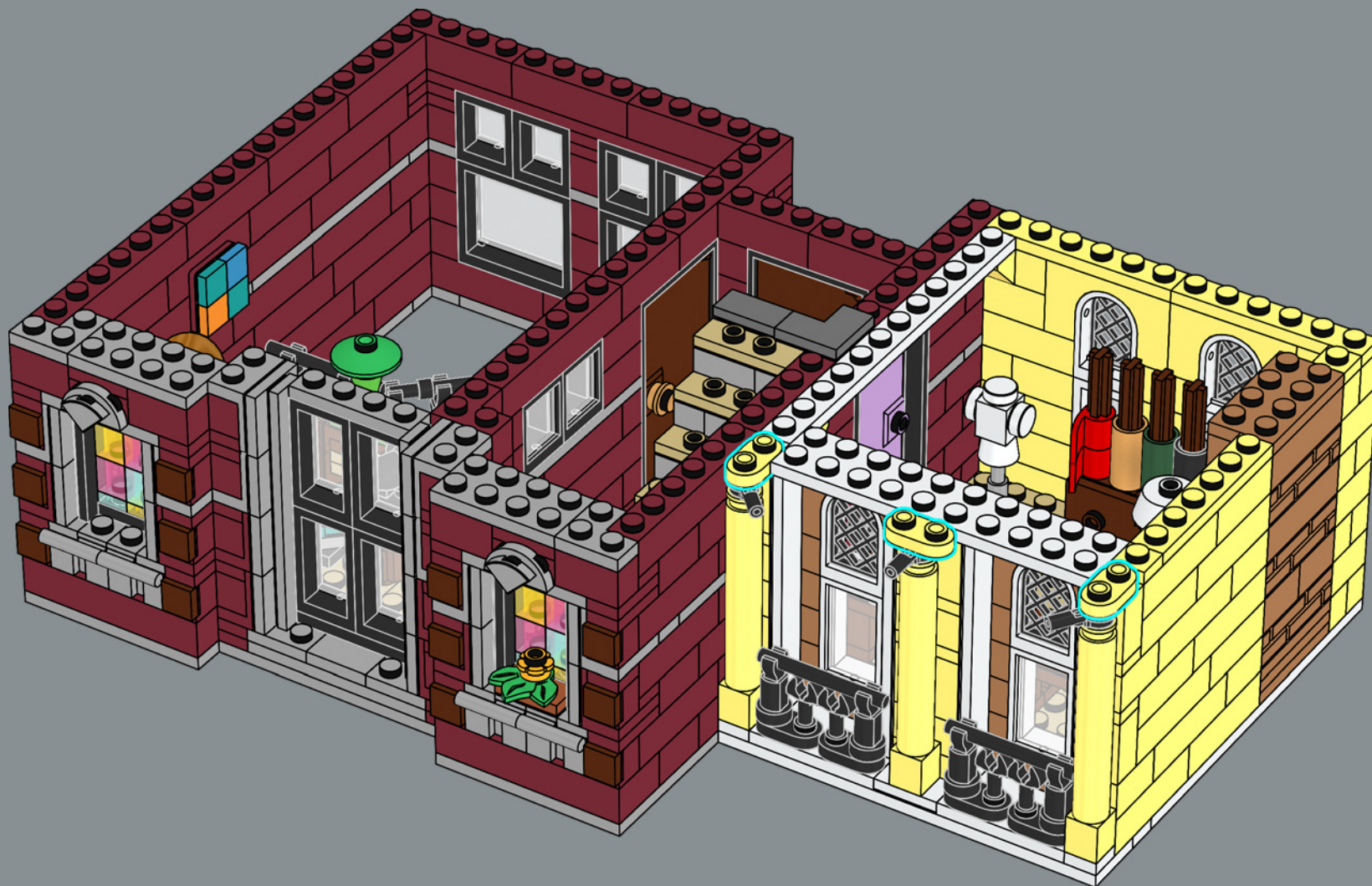

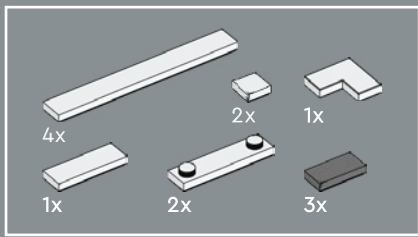

267

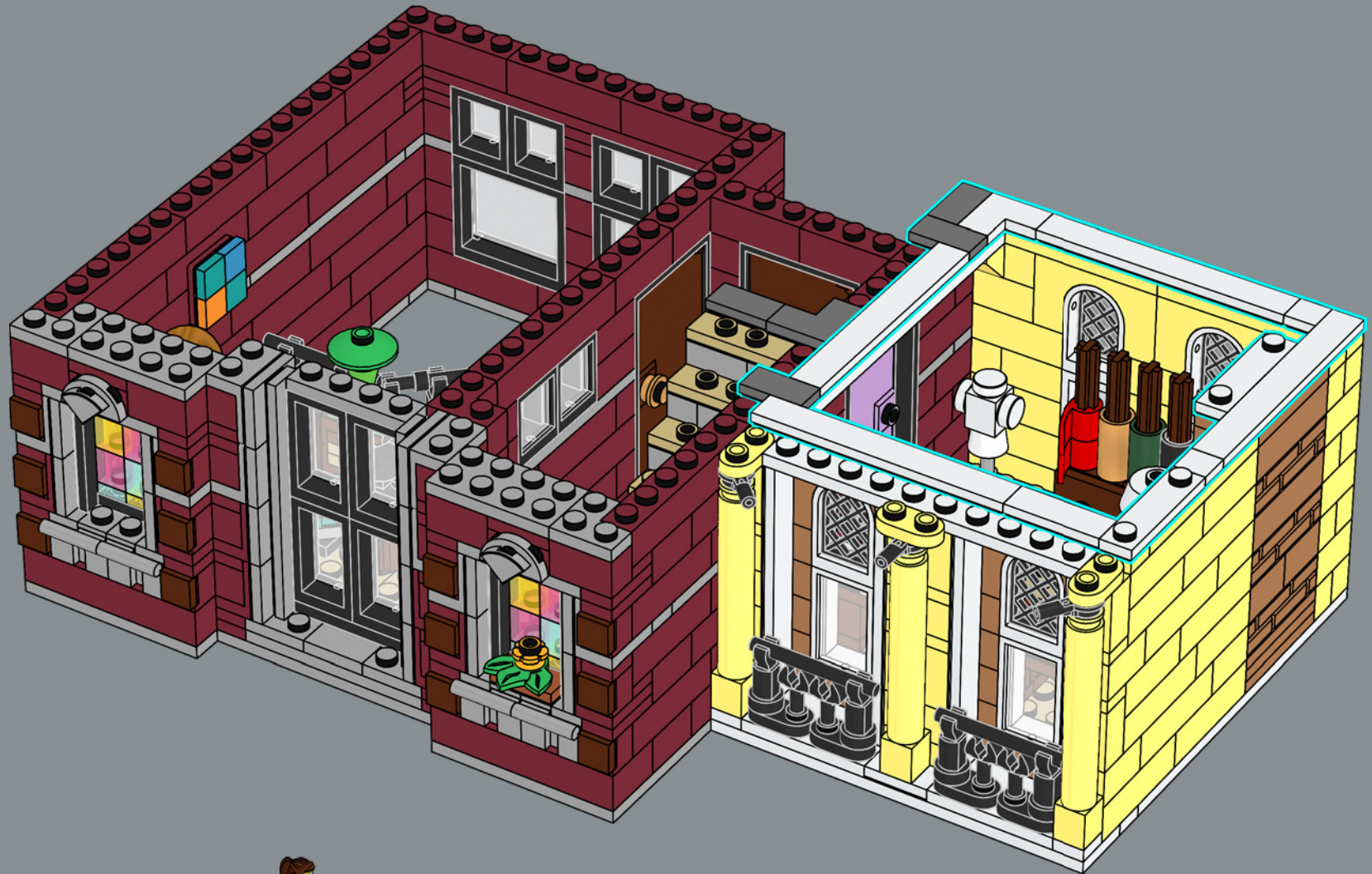

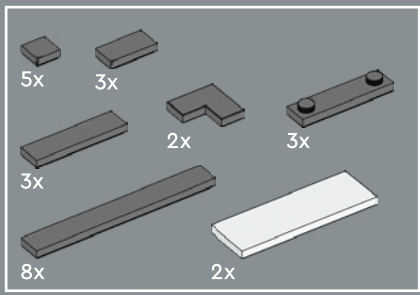

268

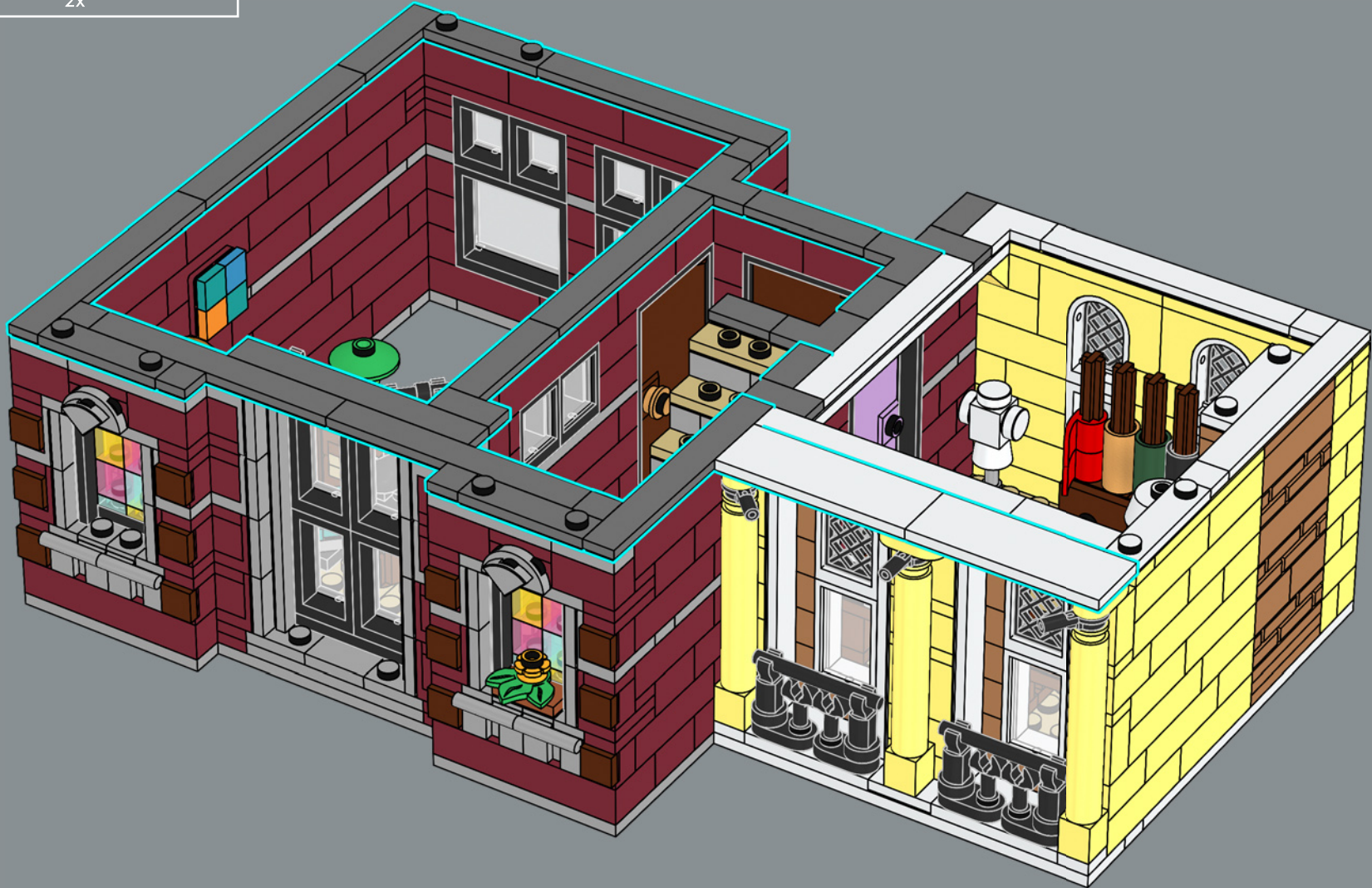



269

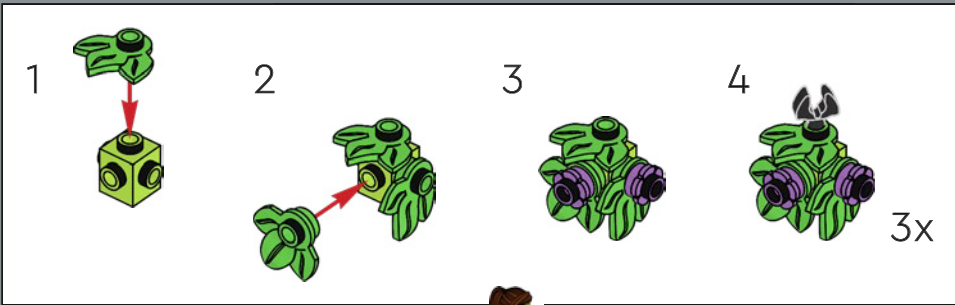

Lavender hanging flowers, a lavender sign, lavender doors... if you need to visit the tailor, just follow the lavender!

Des fleurs suspendues couleur lavande, une enseigne couleur lavande, des portes couleur lavande... si vous devez visiter le tailleur, suivez la couleur lavande !

Flores de lavanda colgantes, un letrero y puertas del color lavanda... Si necesitas visitar al sastre, ¡solo tienes que seguir este elegante tono!

270





The singer is nearly ready for tonight's show. She has picked up her dress from the tailor, had a bite to eat at the Pizzeria, checked in with the manager and now she is warming up in the dressing room.

La chanteuse est presque prête pour le spectacle de ce soir. Elle est passée prendre sa robe chez le tailleur, a mangé un peu à la pizzeria, s'est enregistrée auprès de la gérante et se prépare maintenant dans la loge.

La cantante está casi lista para el espectáculo de esta noche. Ya recogió su vestido en la sastrería, comió algo en la pizzería, fue a conversar con la encargada y ahora está terminando de prepararse en el vestidor.

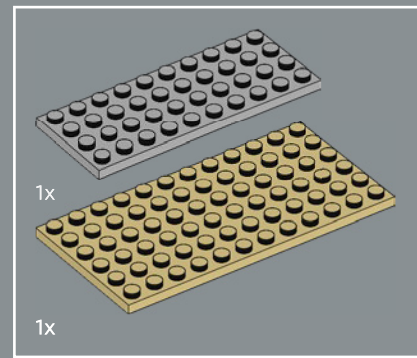
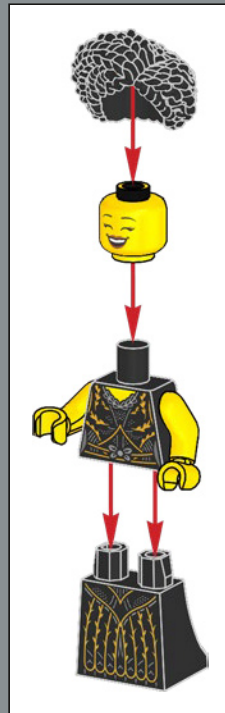
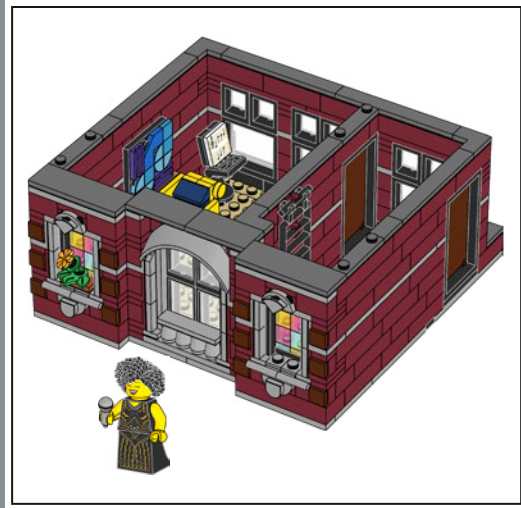

271

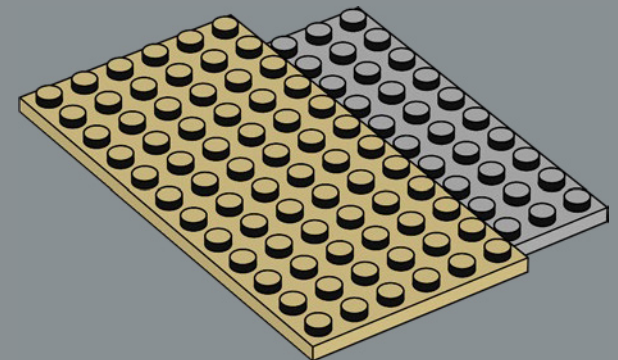

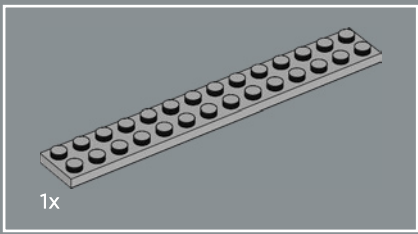

272

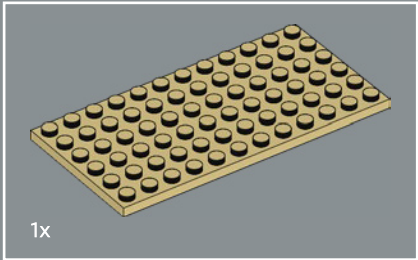
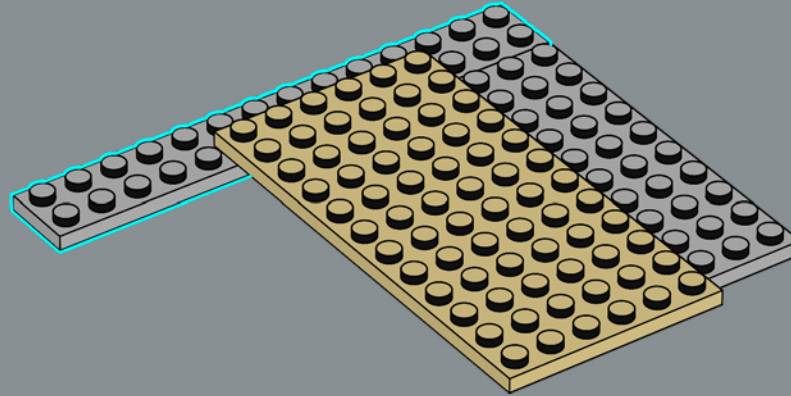

273

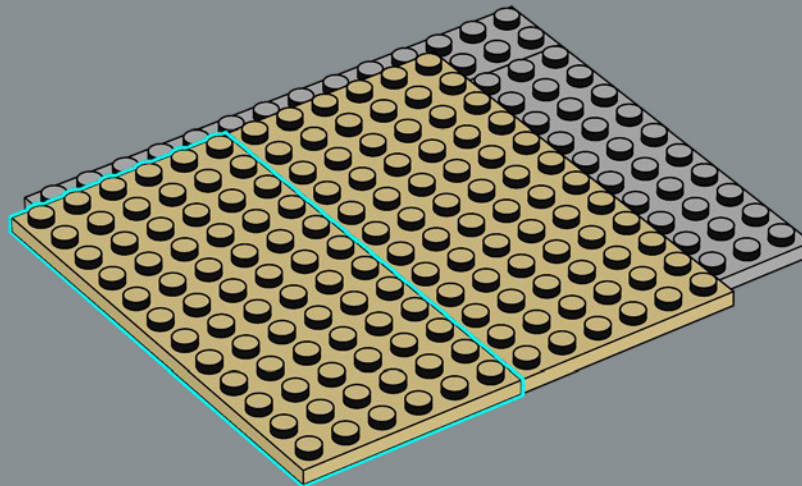

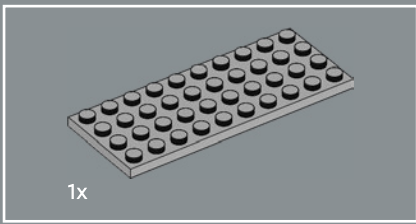

274

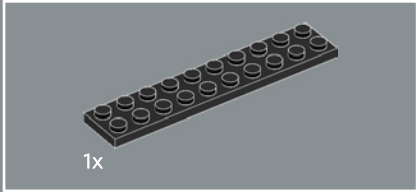
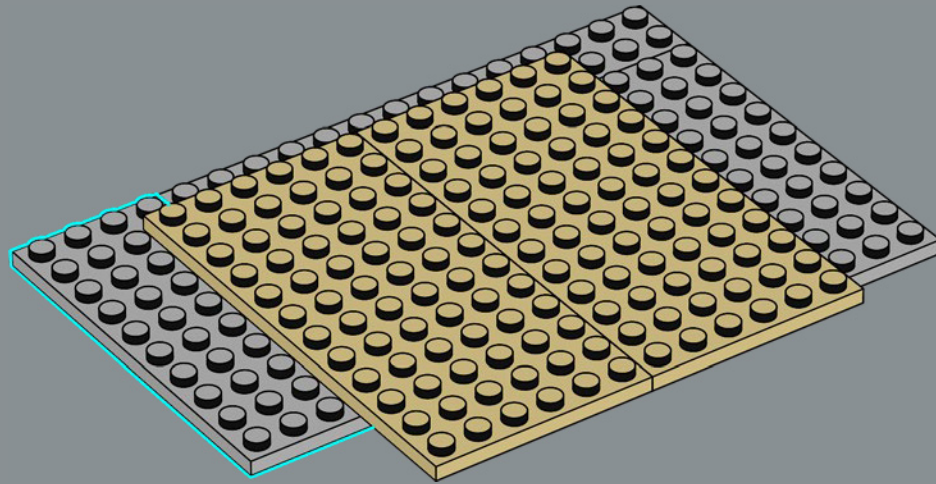

275

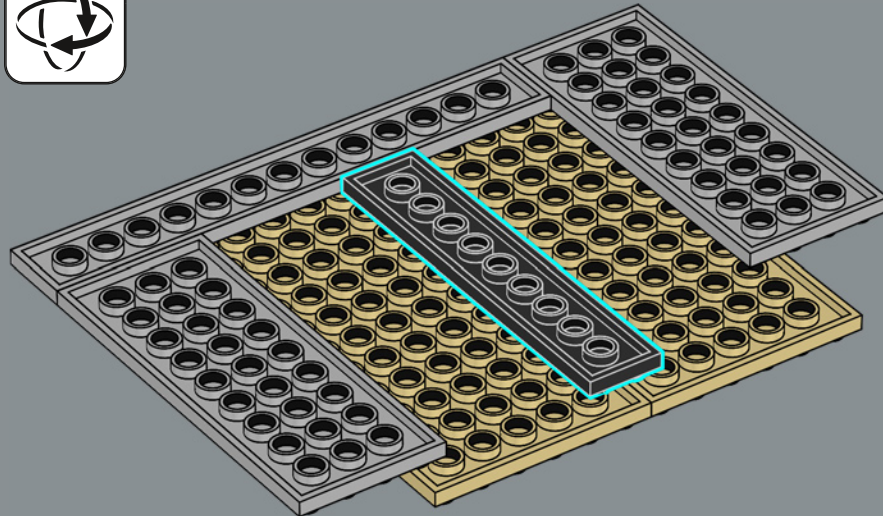

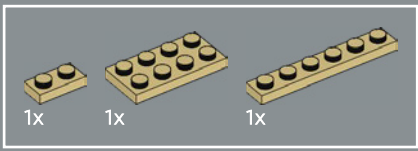

276

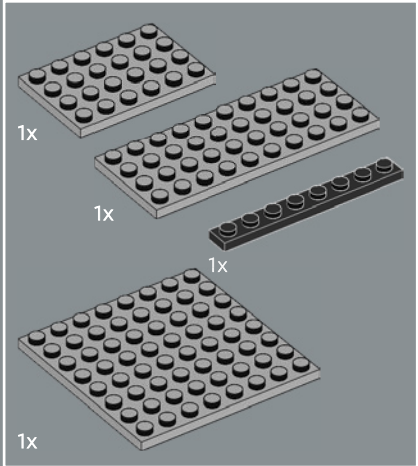
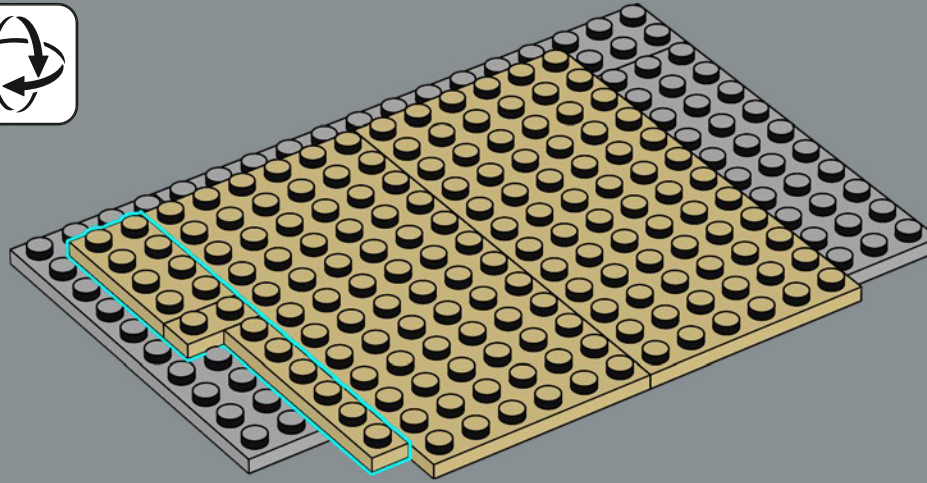

277

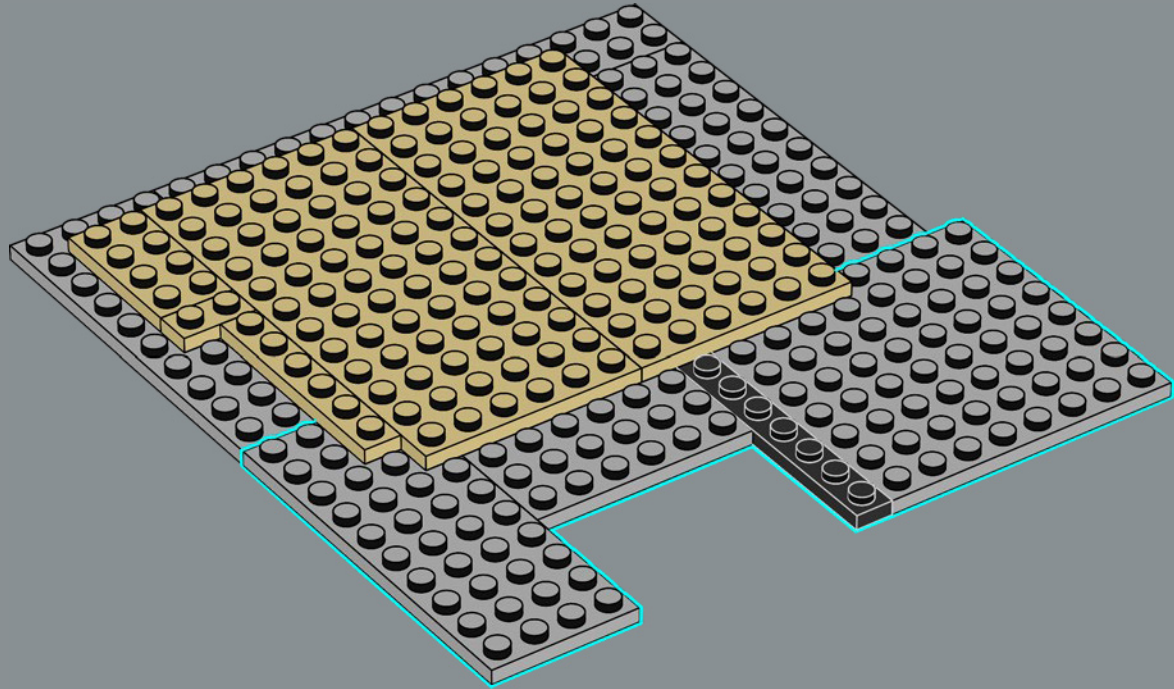

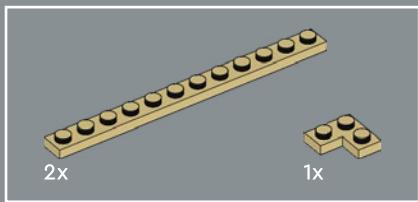

278

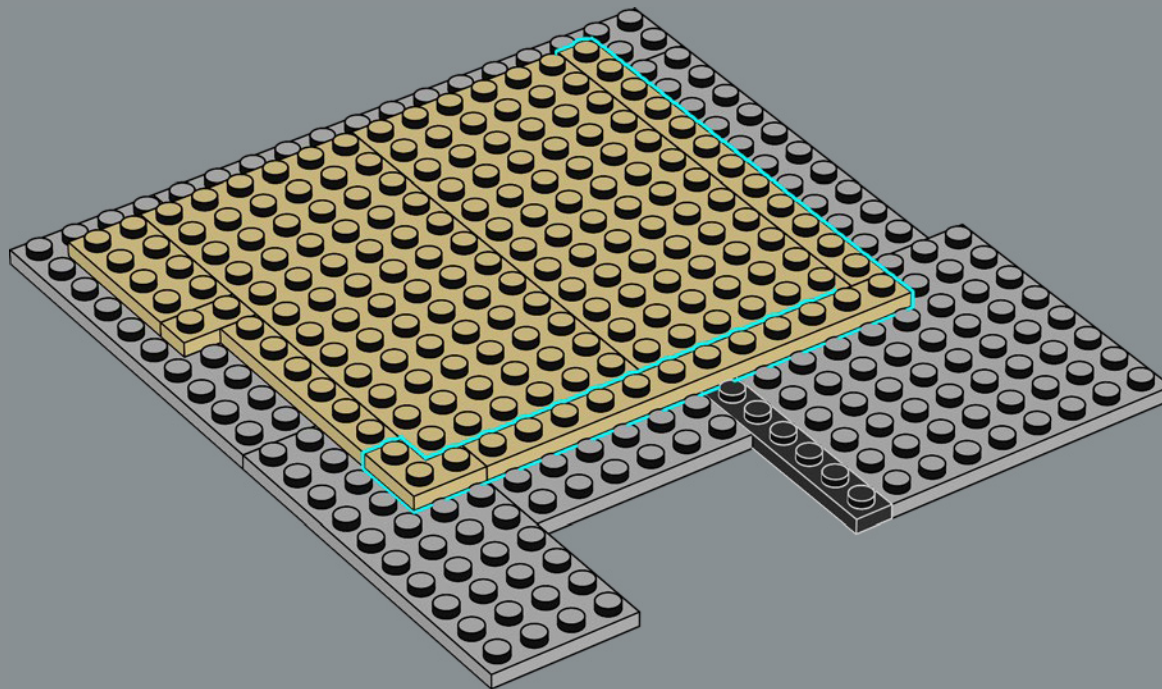

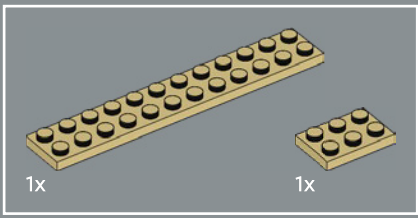

279

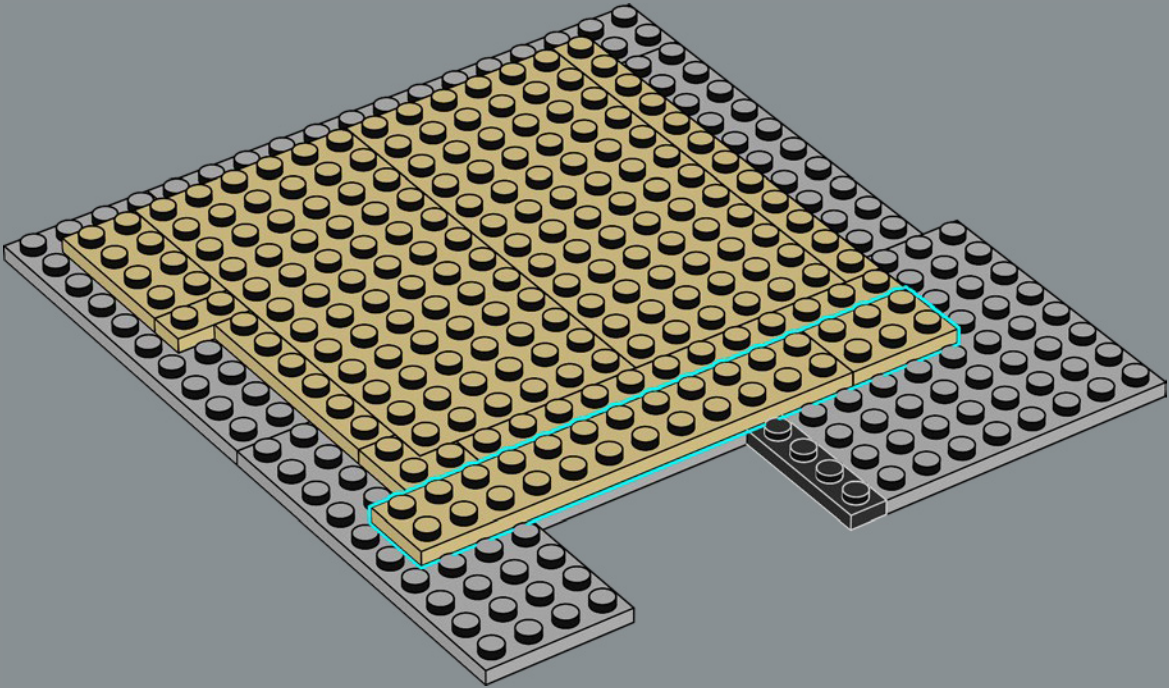

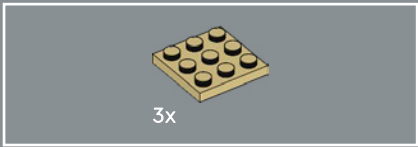

280

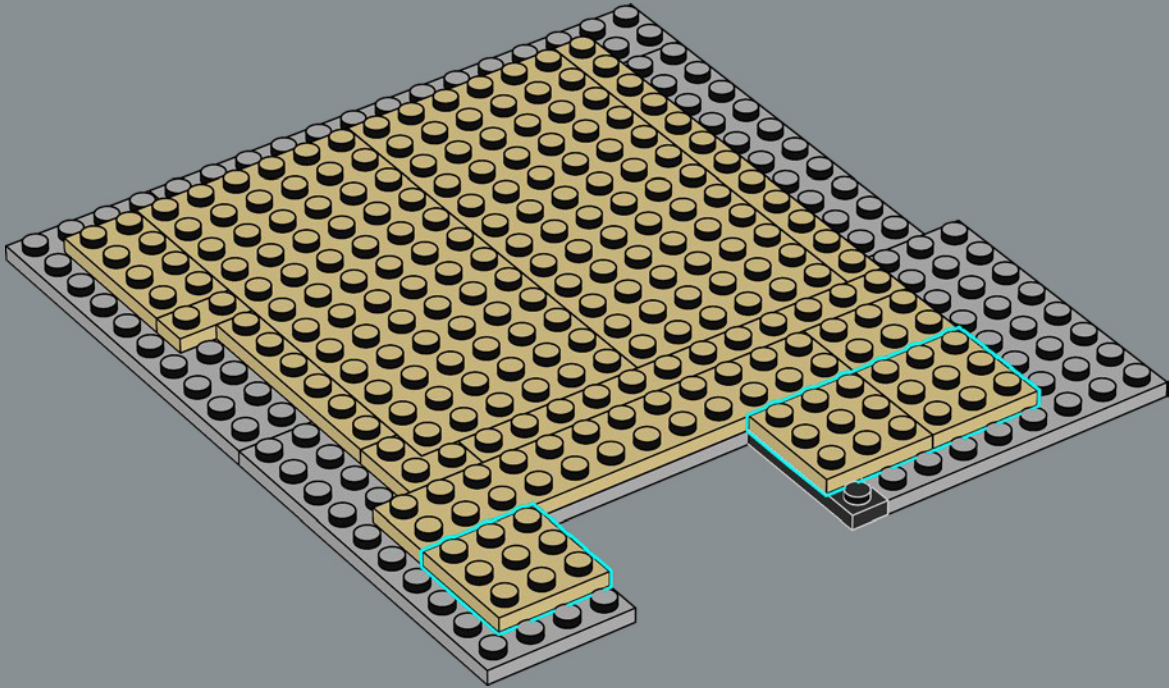

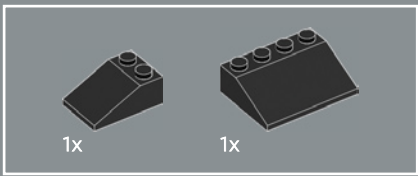

281

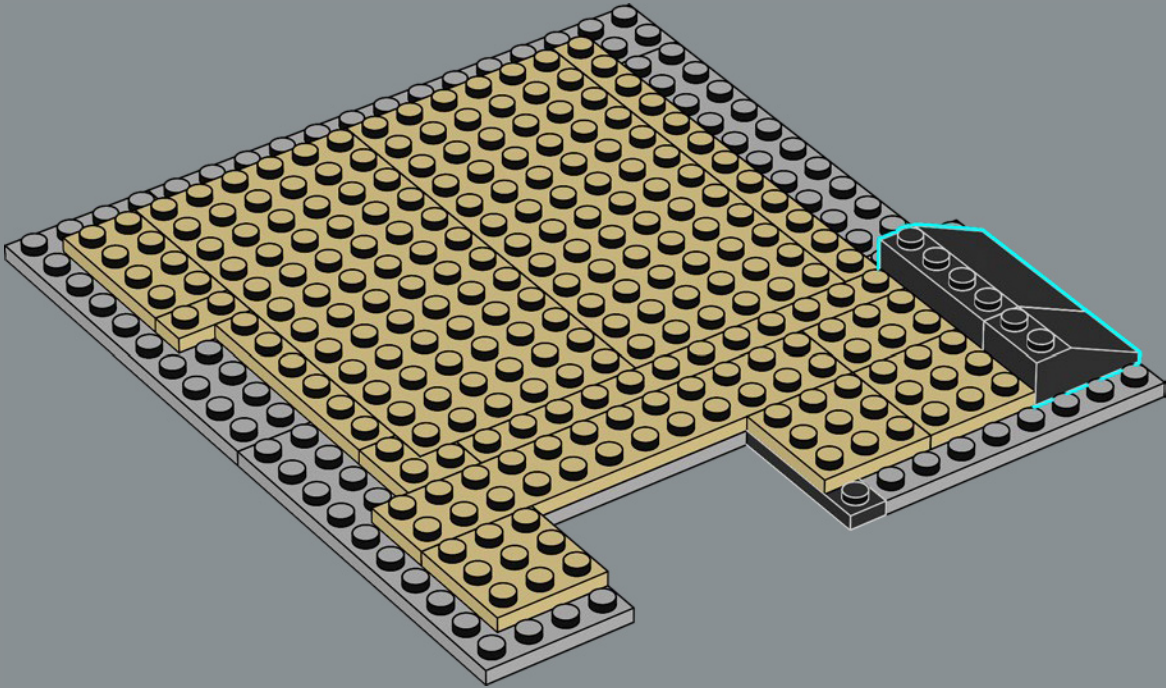

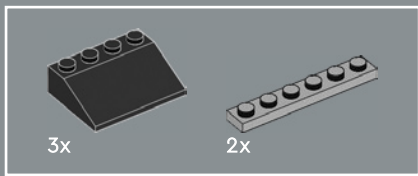

282

1

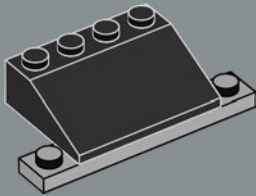

2

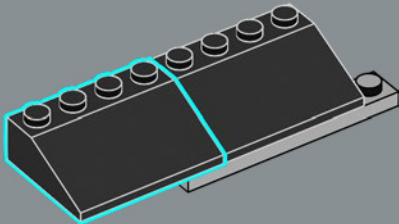

3

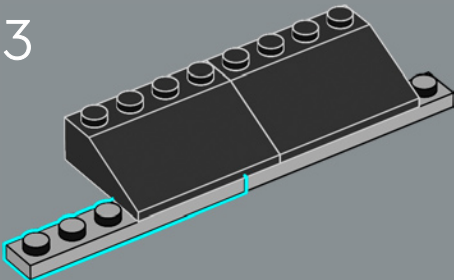

4

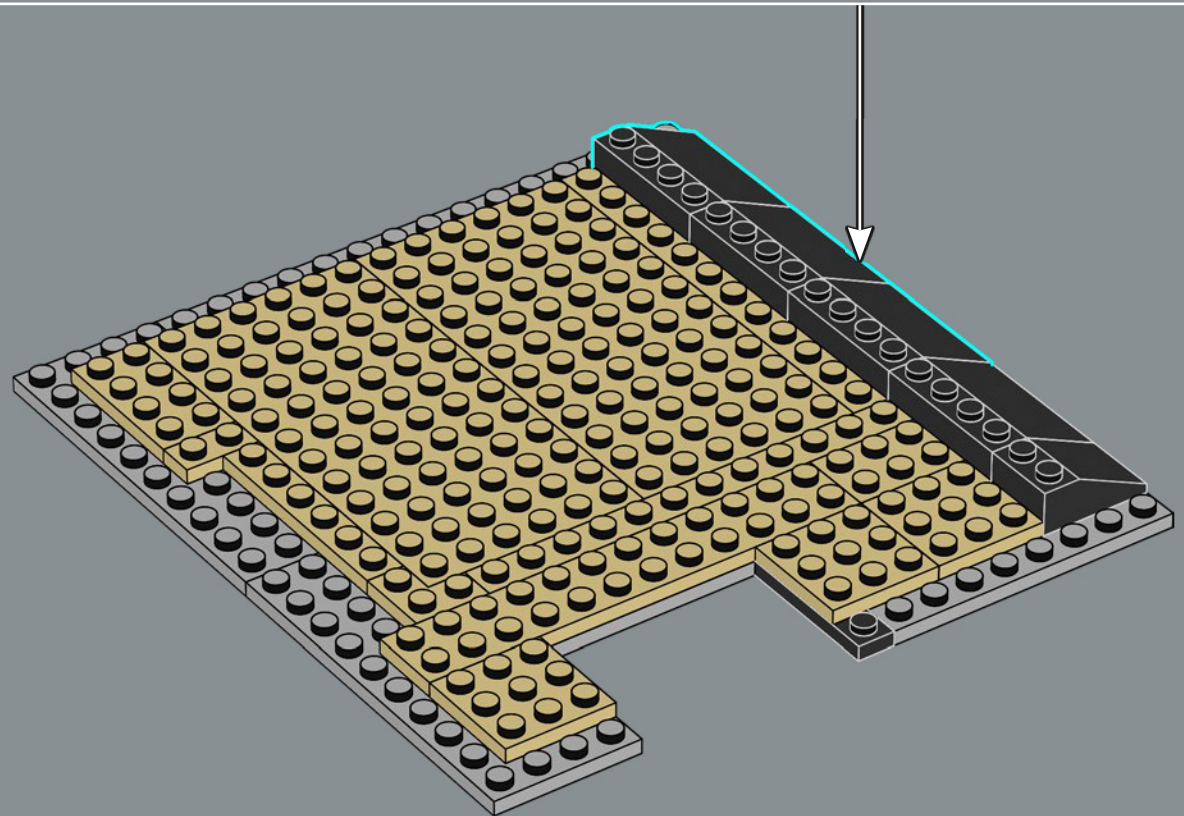
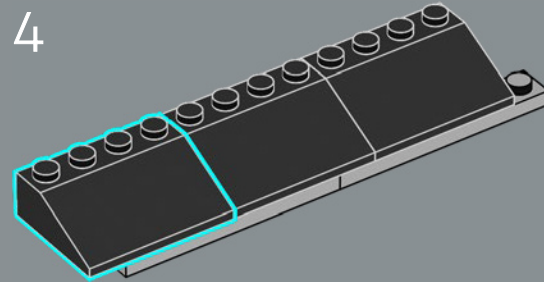

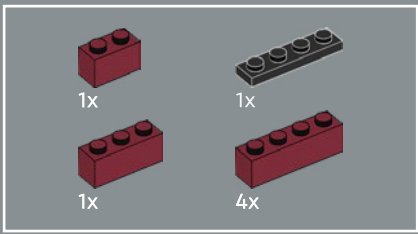

283

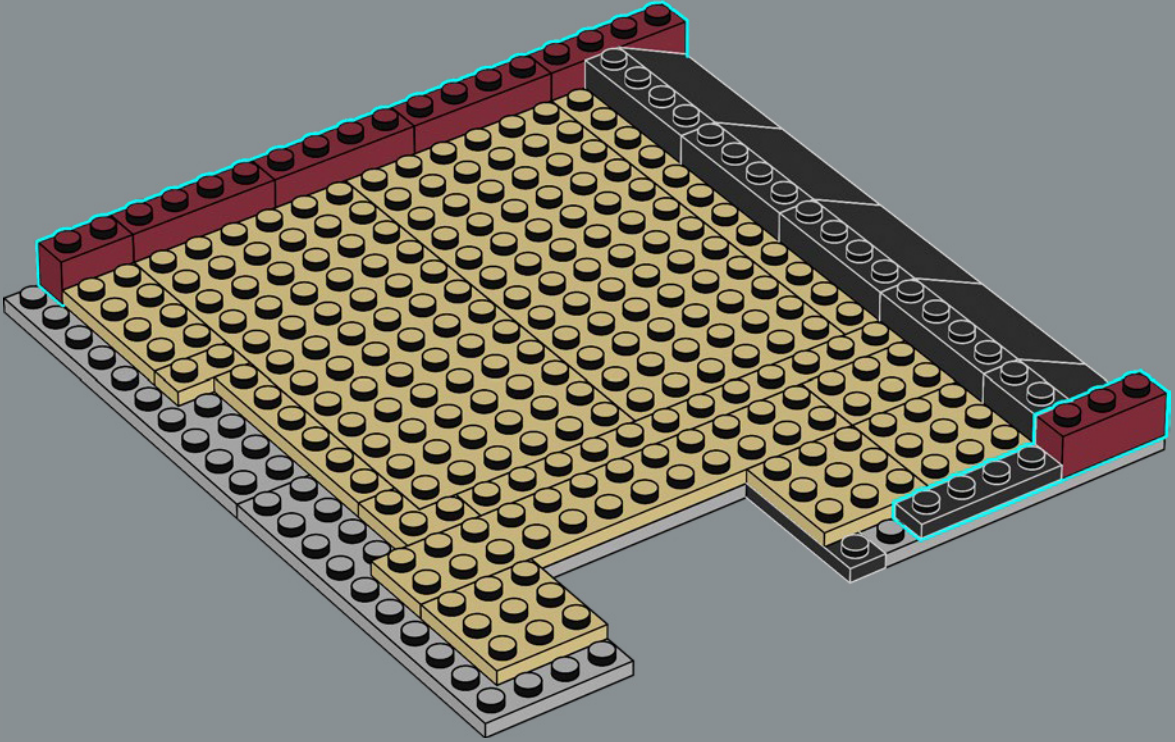

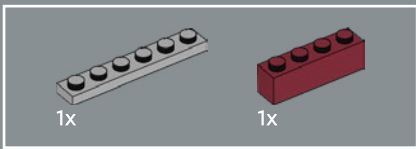

284

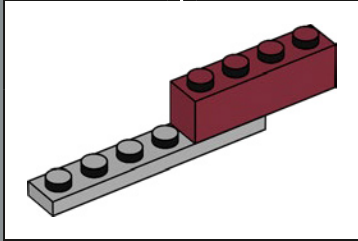
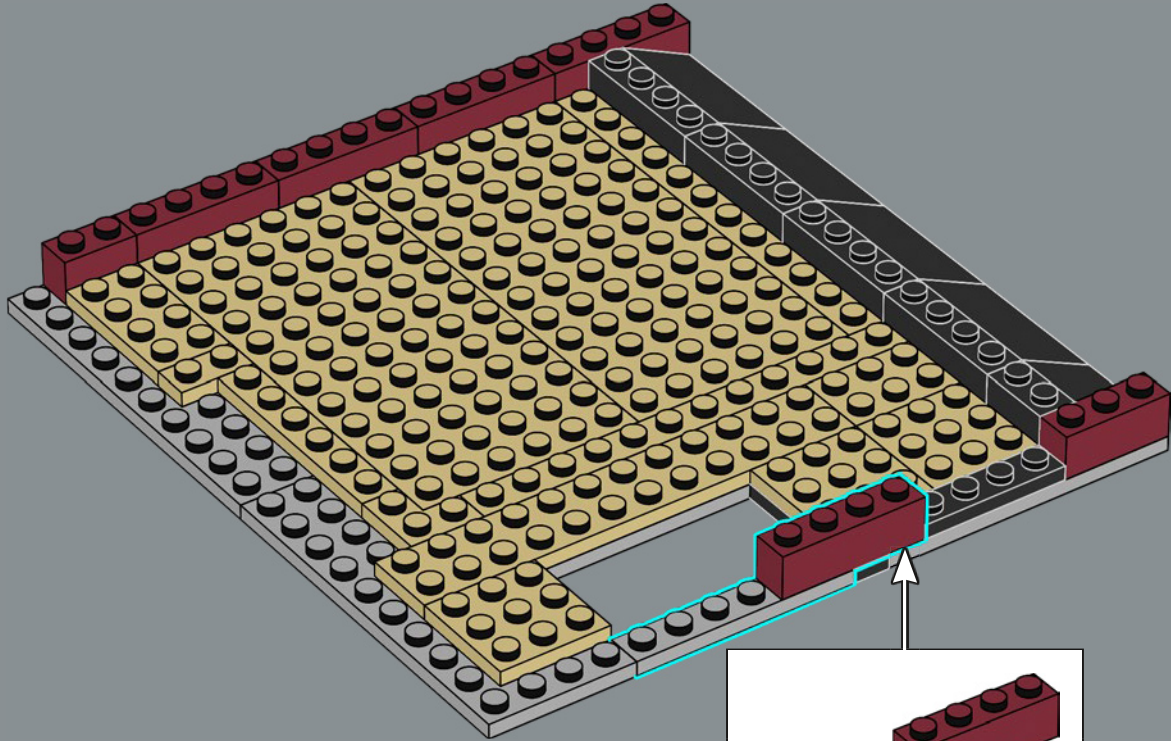

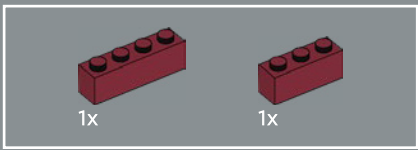

285

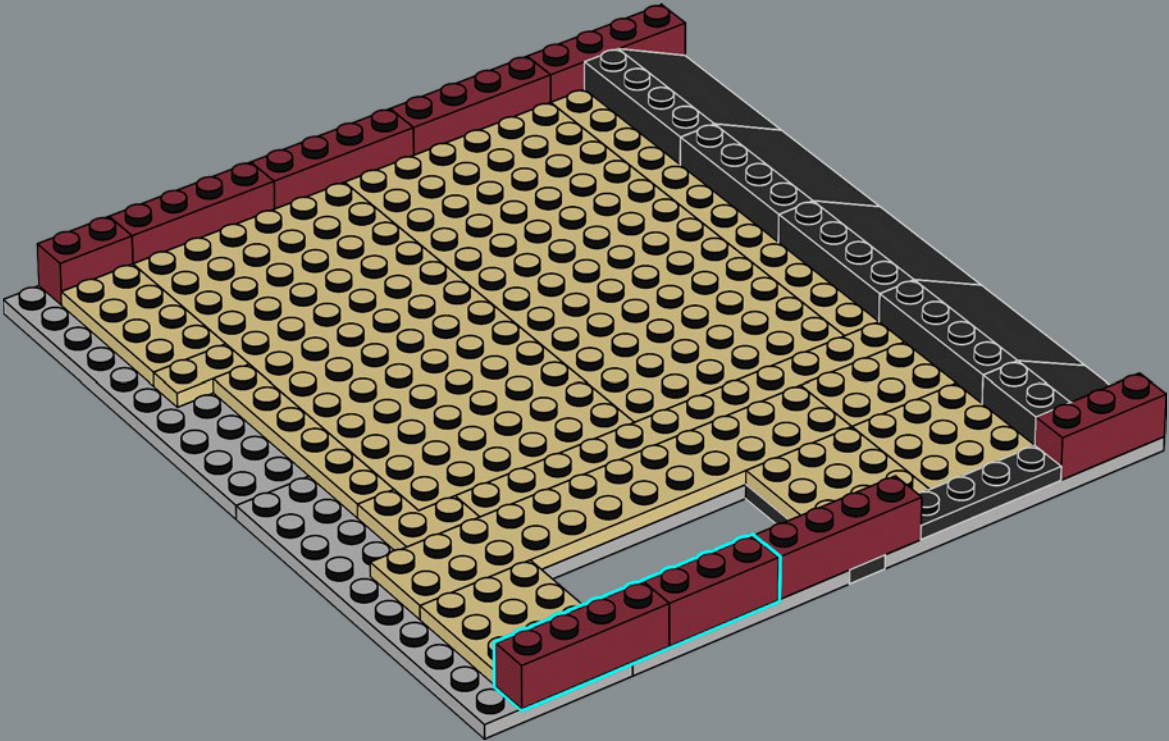

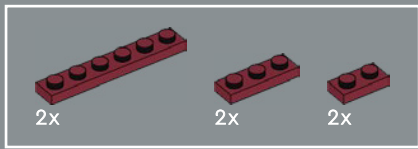

286

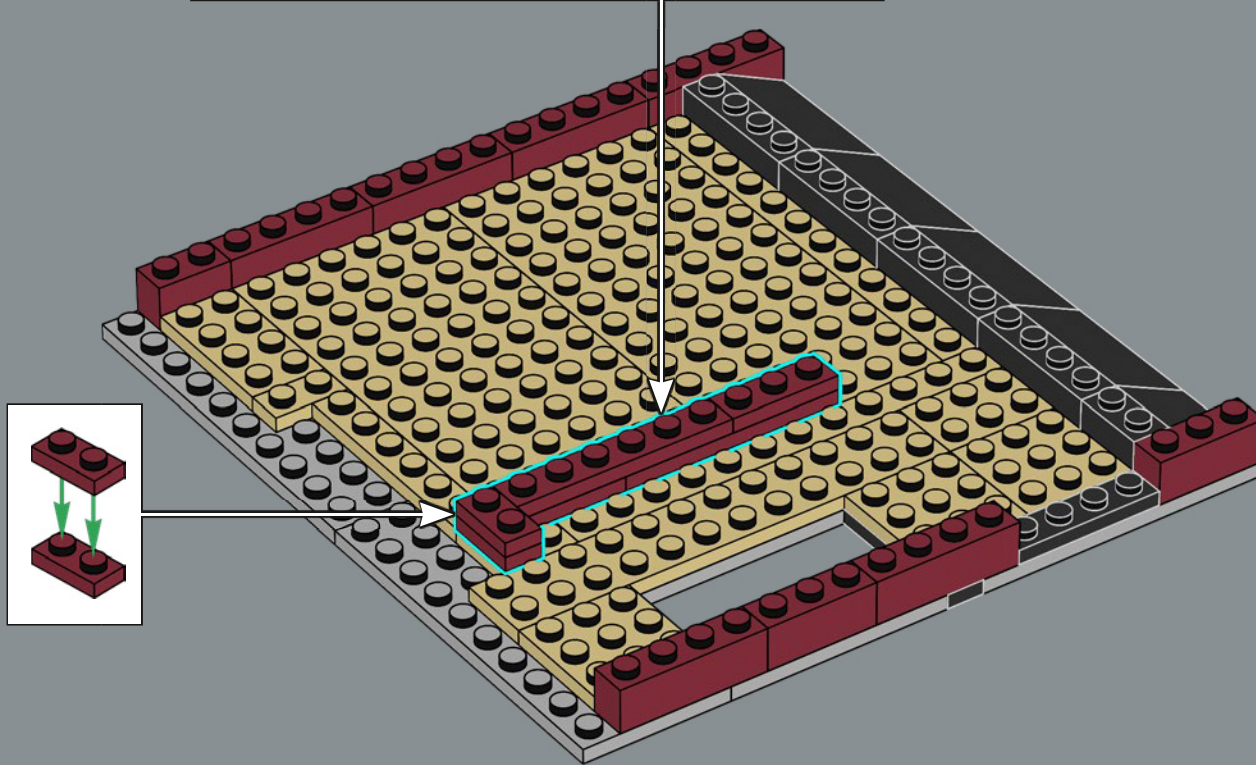
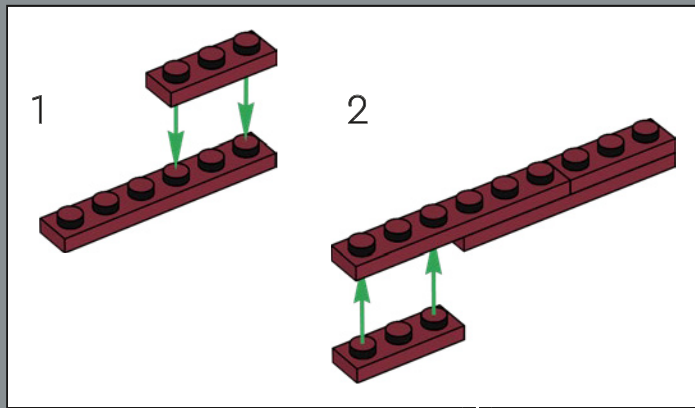

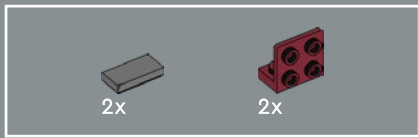

288

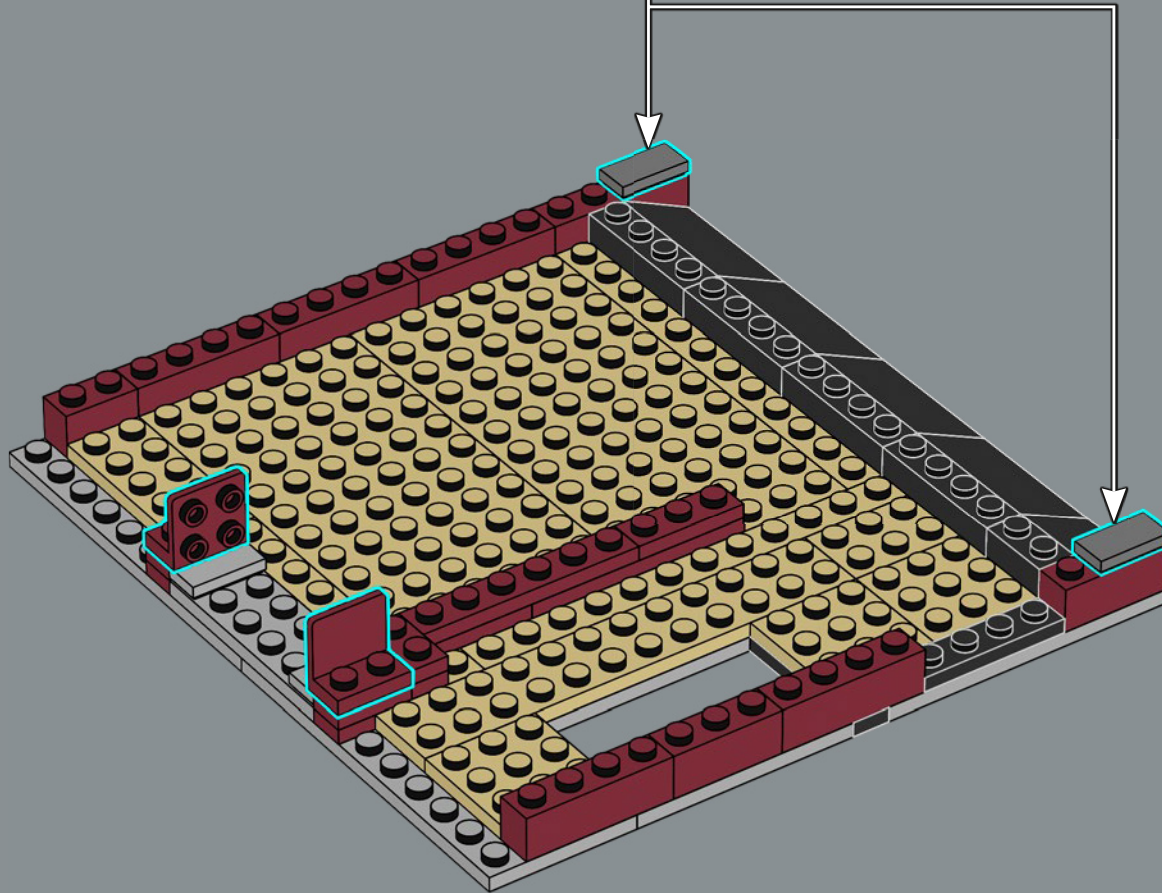
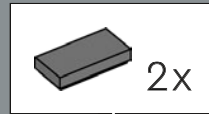

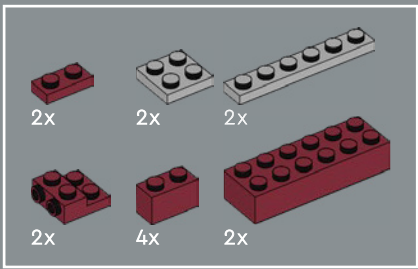

289

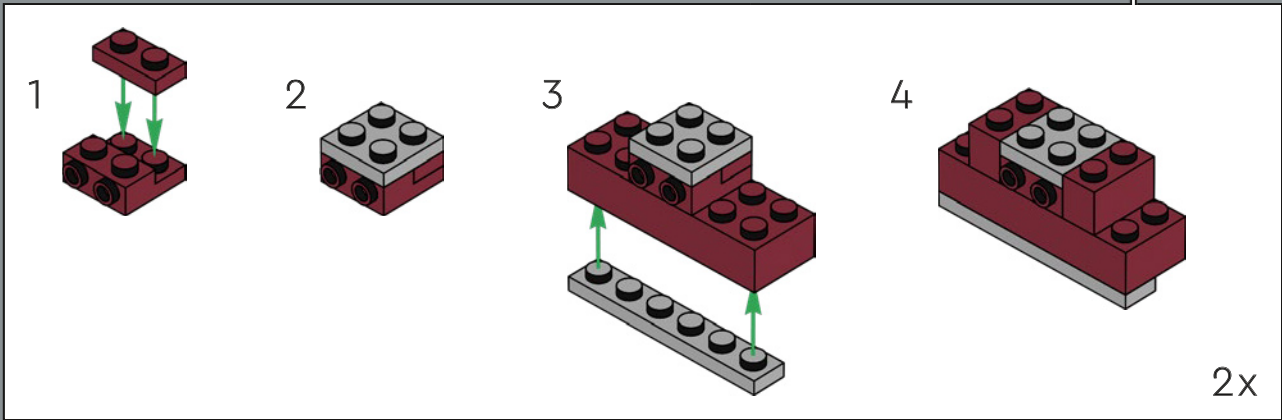
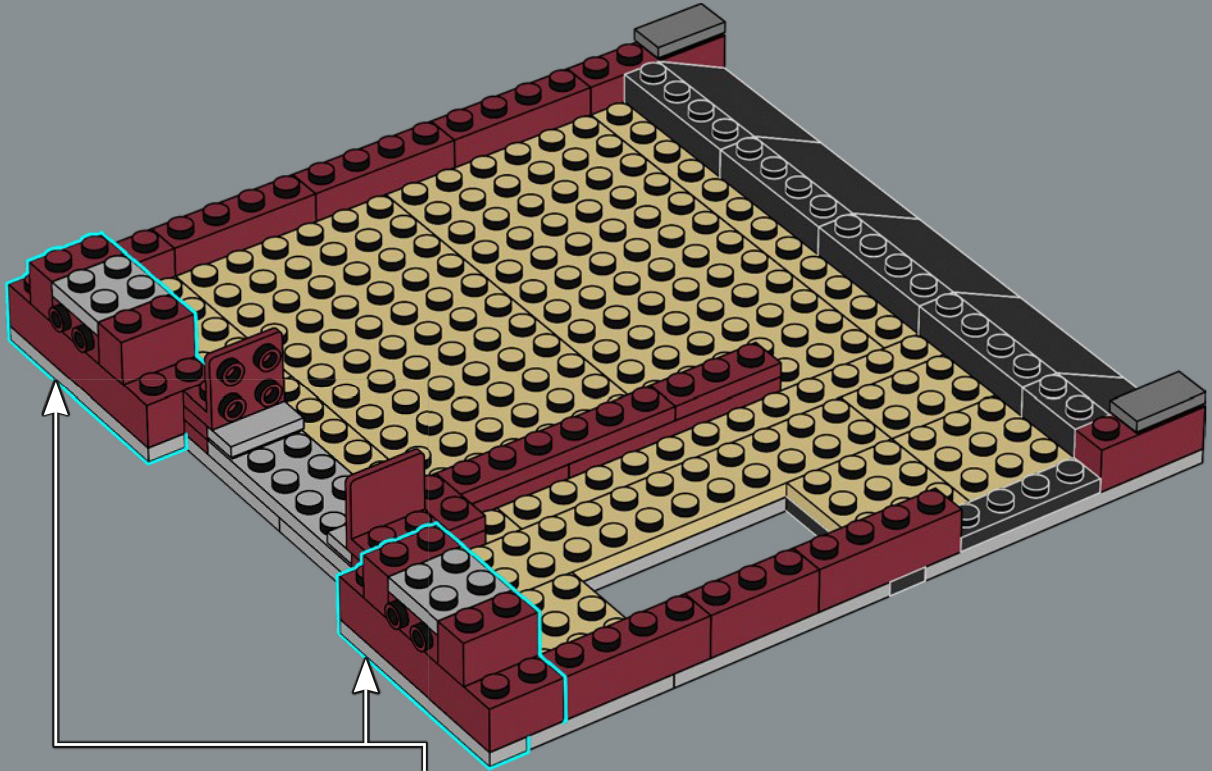

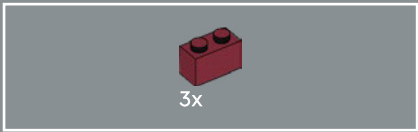

290

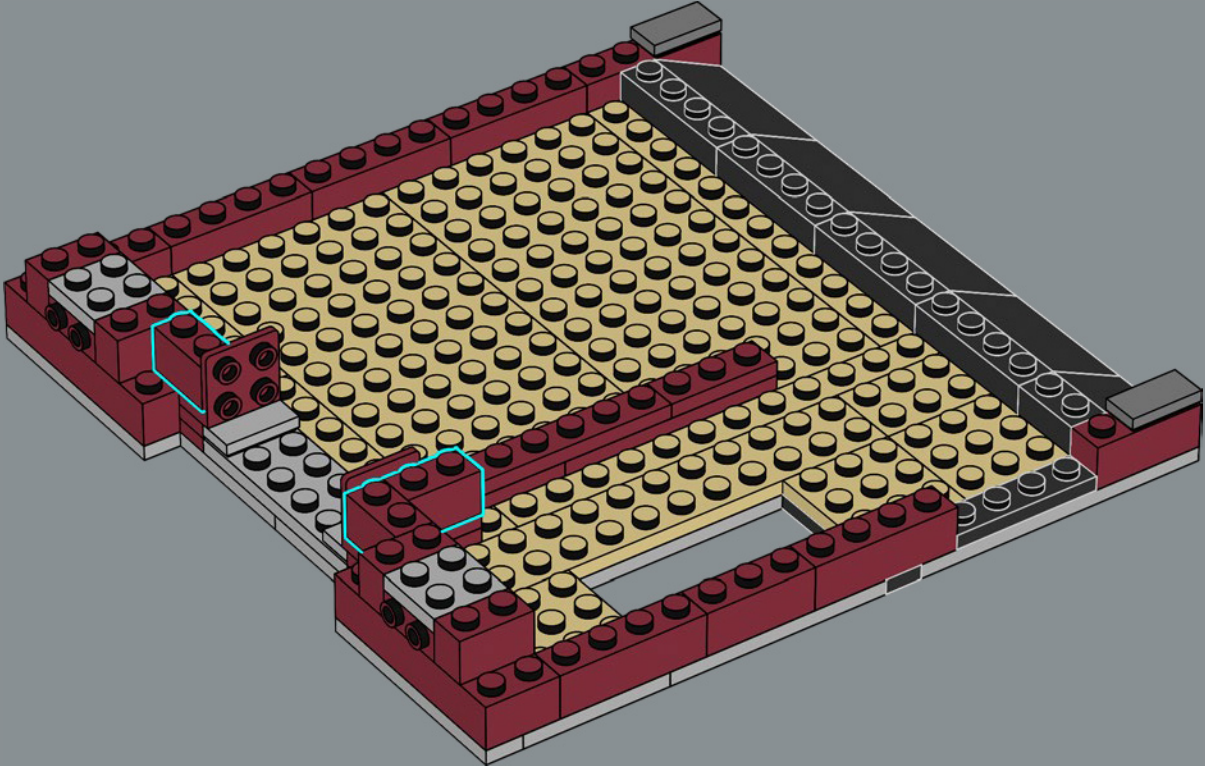

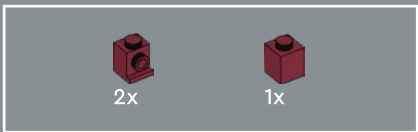

291

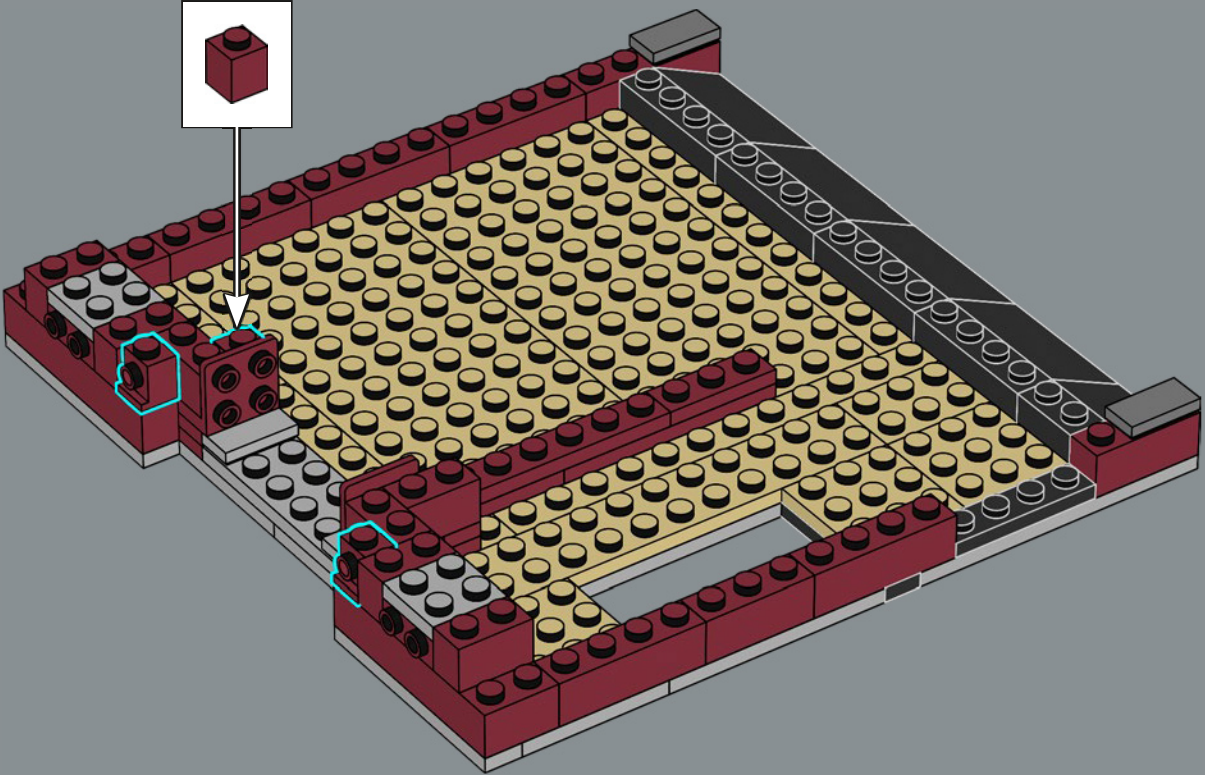



292

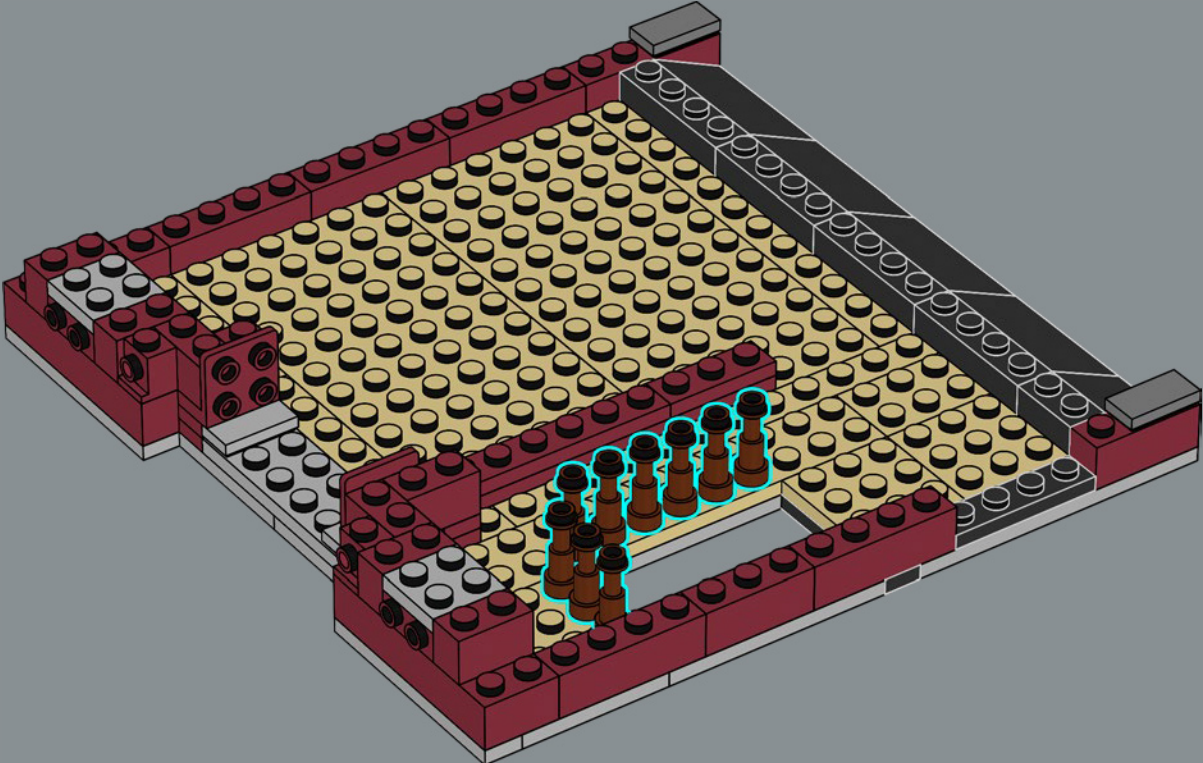



293

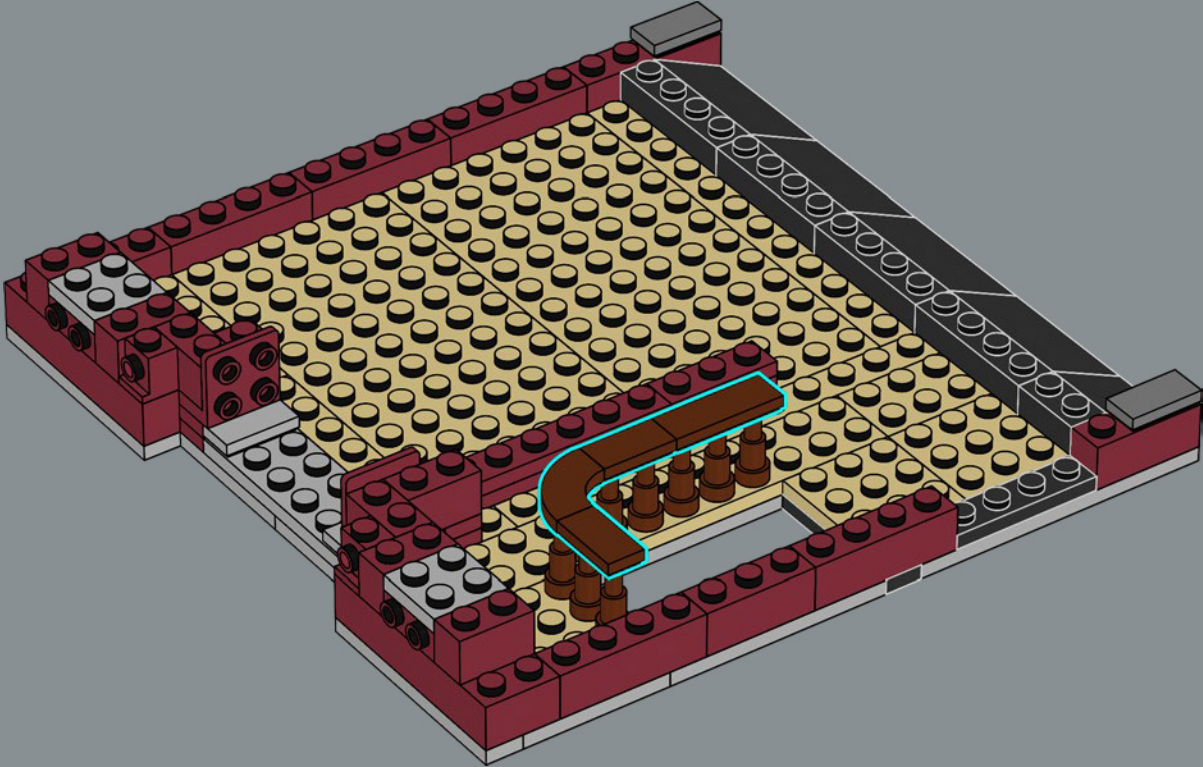

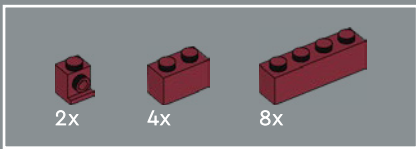

294

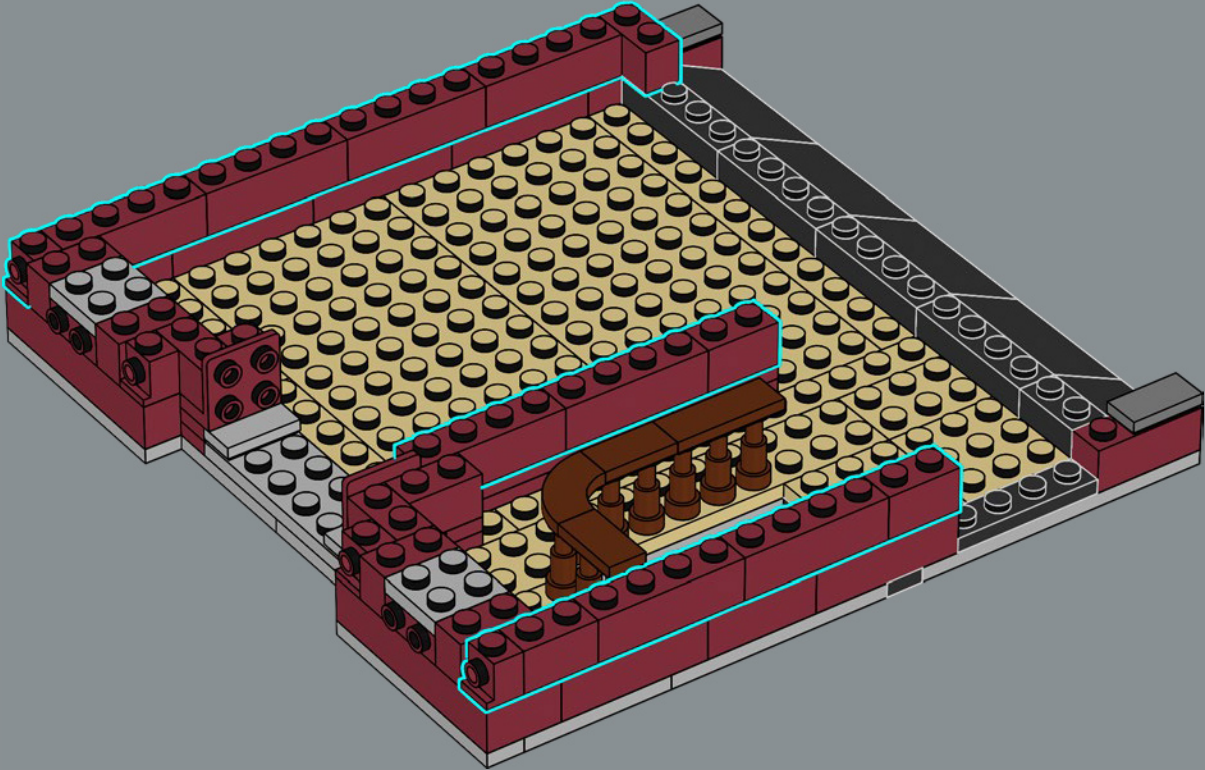

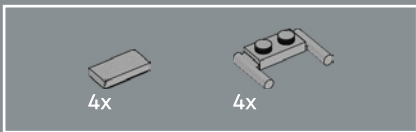

295

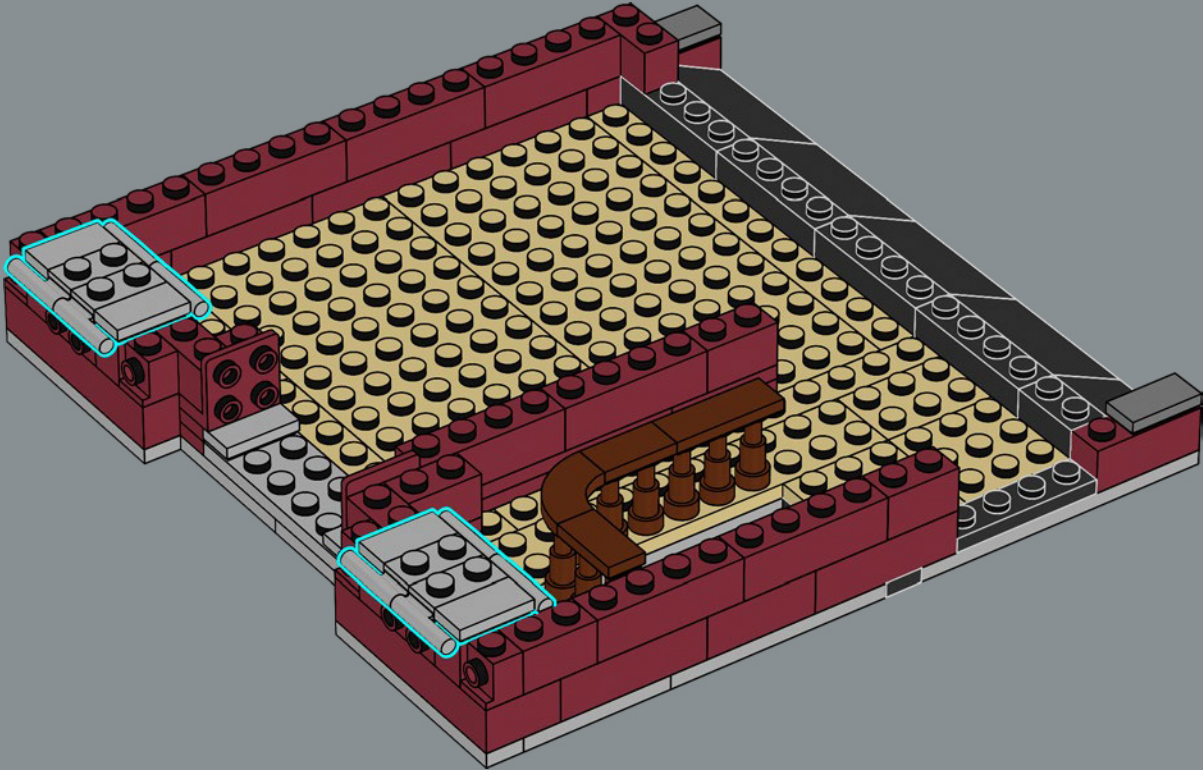

The element used to make the windowsills (1x2 plate with handles) has been in the LEGO® System since 1978!

L'élément utilisé pour fabriquer les rebords de fenêtres (la plaque 1x2 avec poignées) fait partie du système LEGO® depuis 1978 !

¡Los elementos utilizados para las cornisas de las ventanas (placas 1x2 con asas) forman parte de la línea LEGO® System desde 1978!

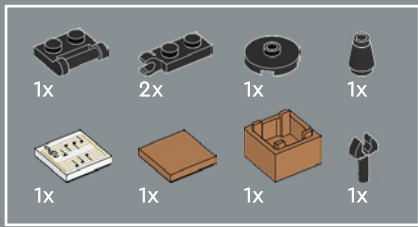

296

1



2



3

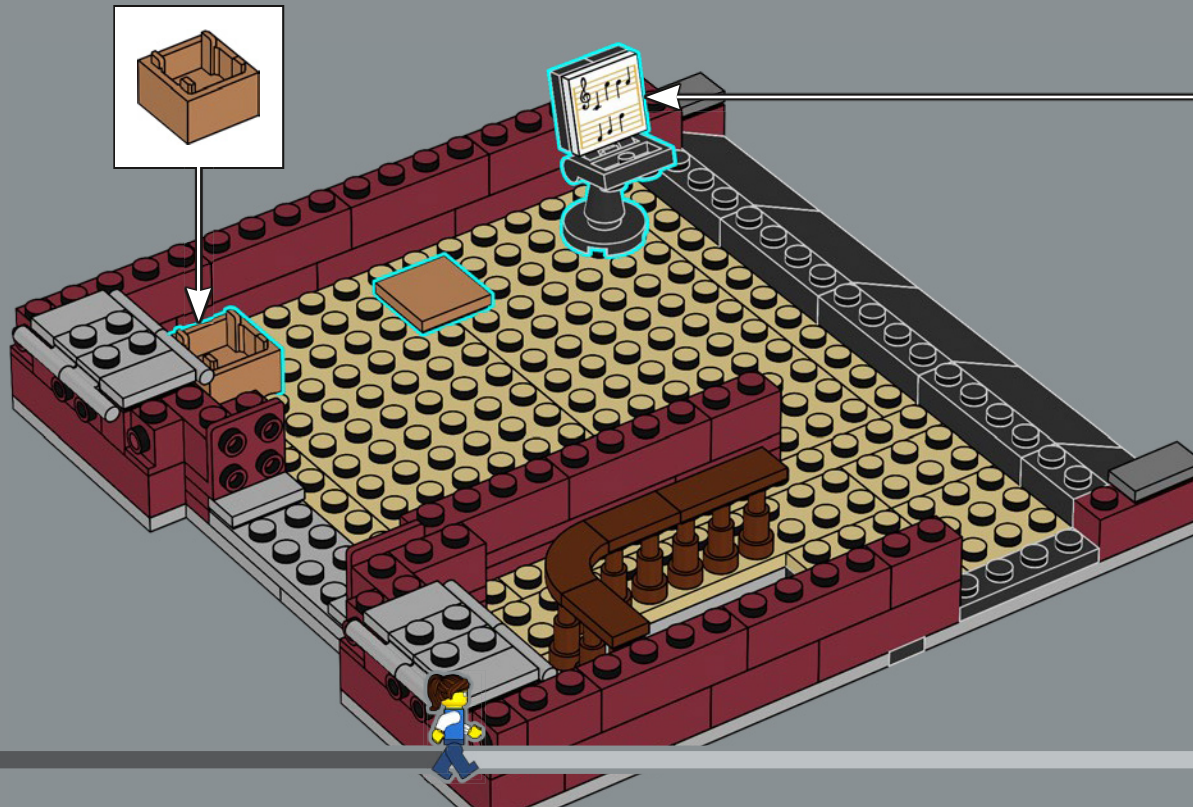

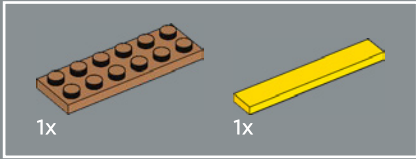
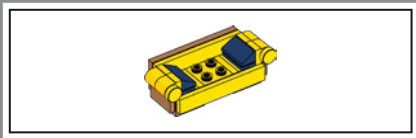

297

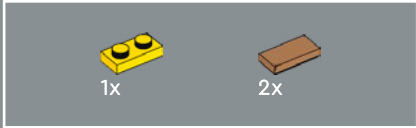
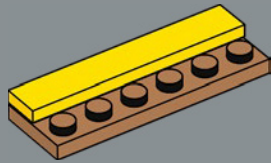

298

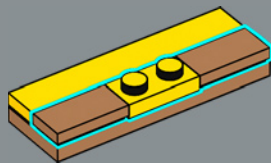

299

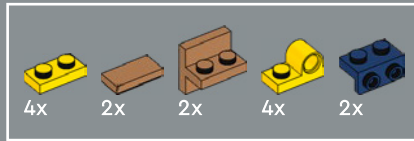
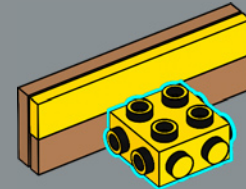

300

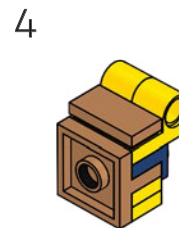
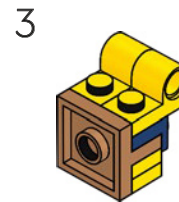
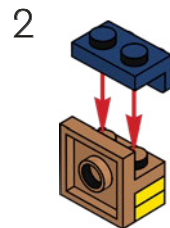
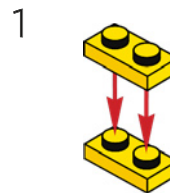

2x

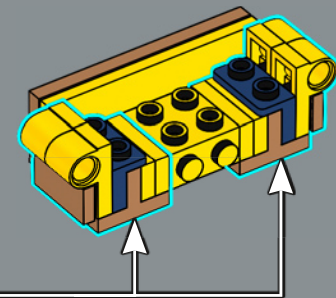

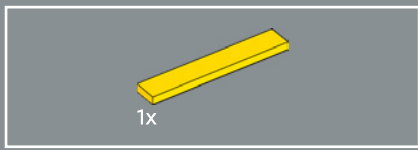

301

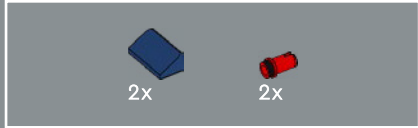
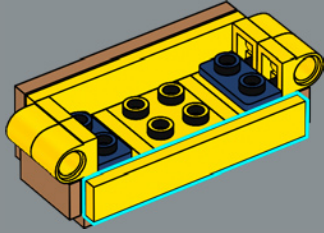

302

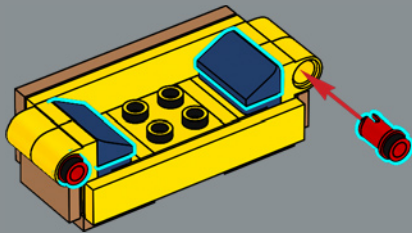

303

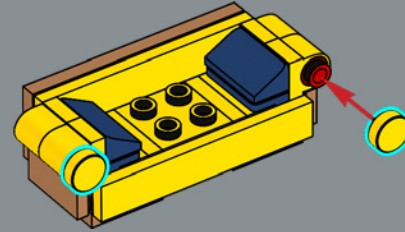

304

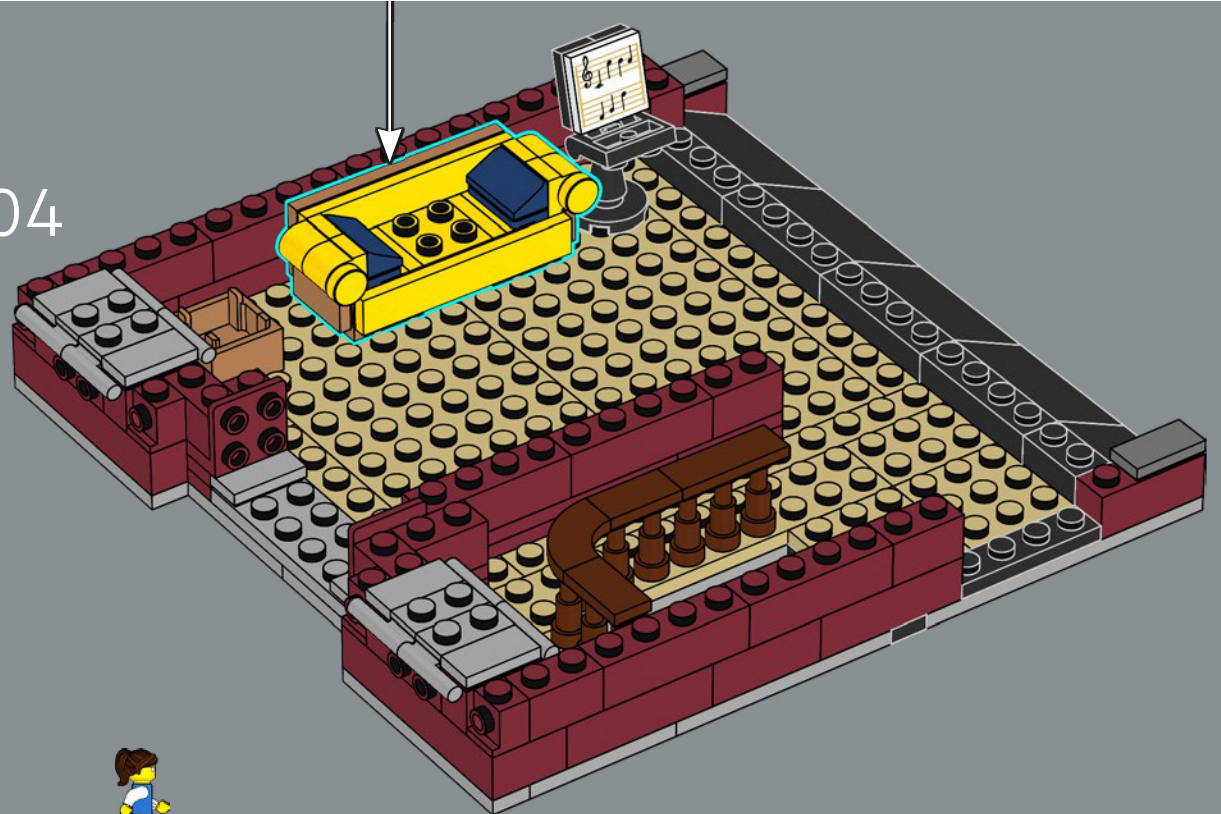



305

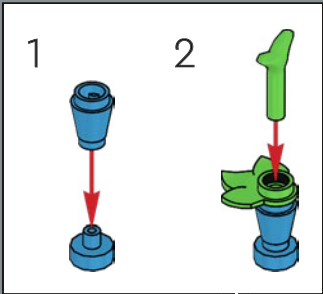

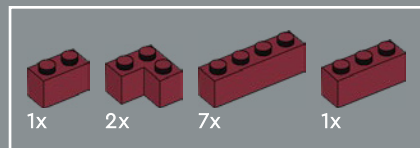

306

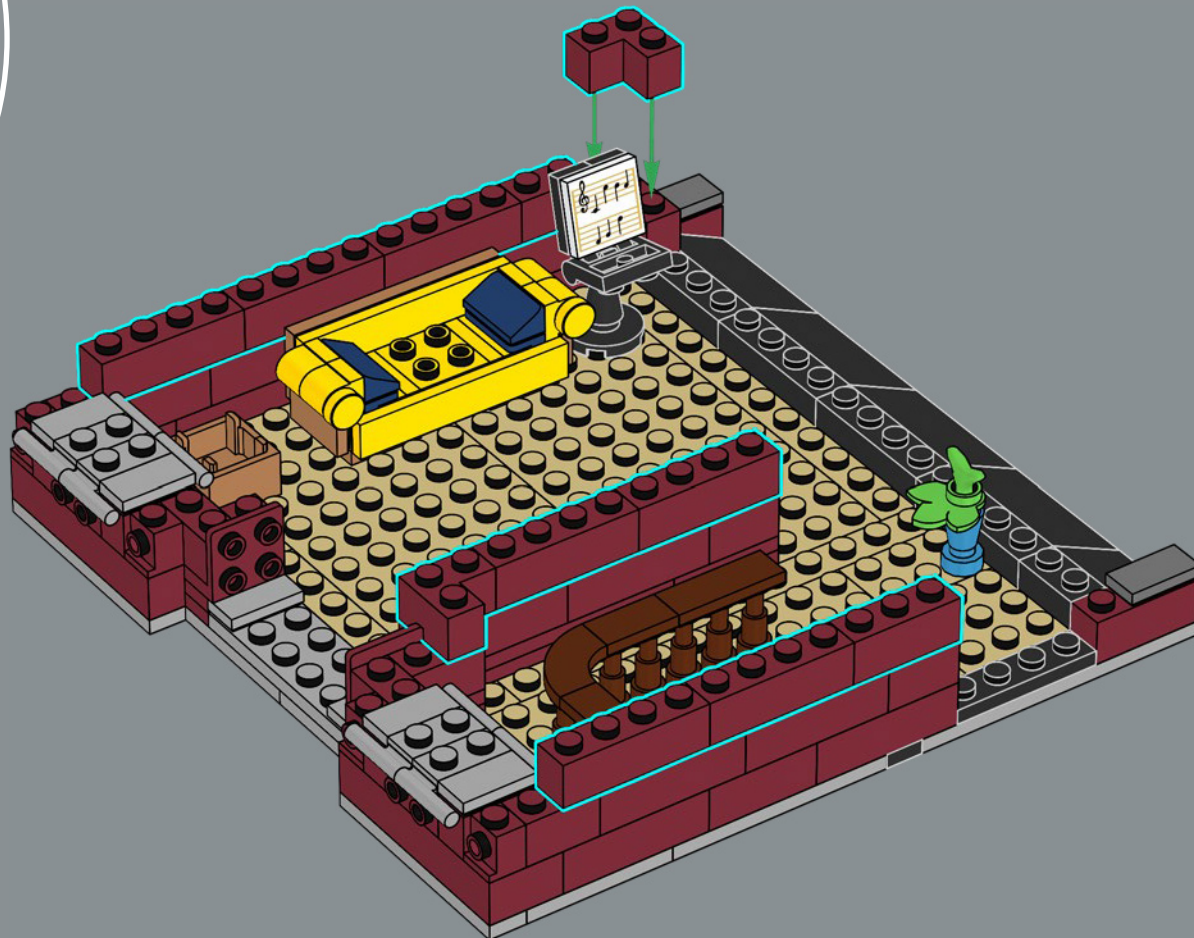

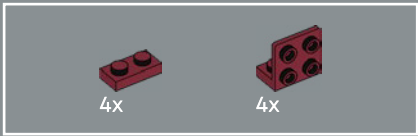

307

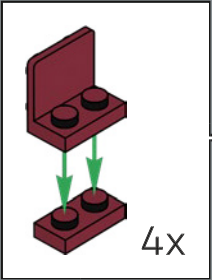

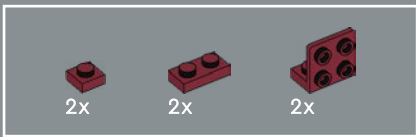

308

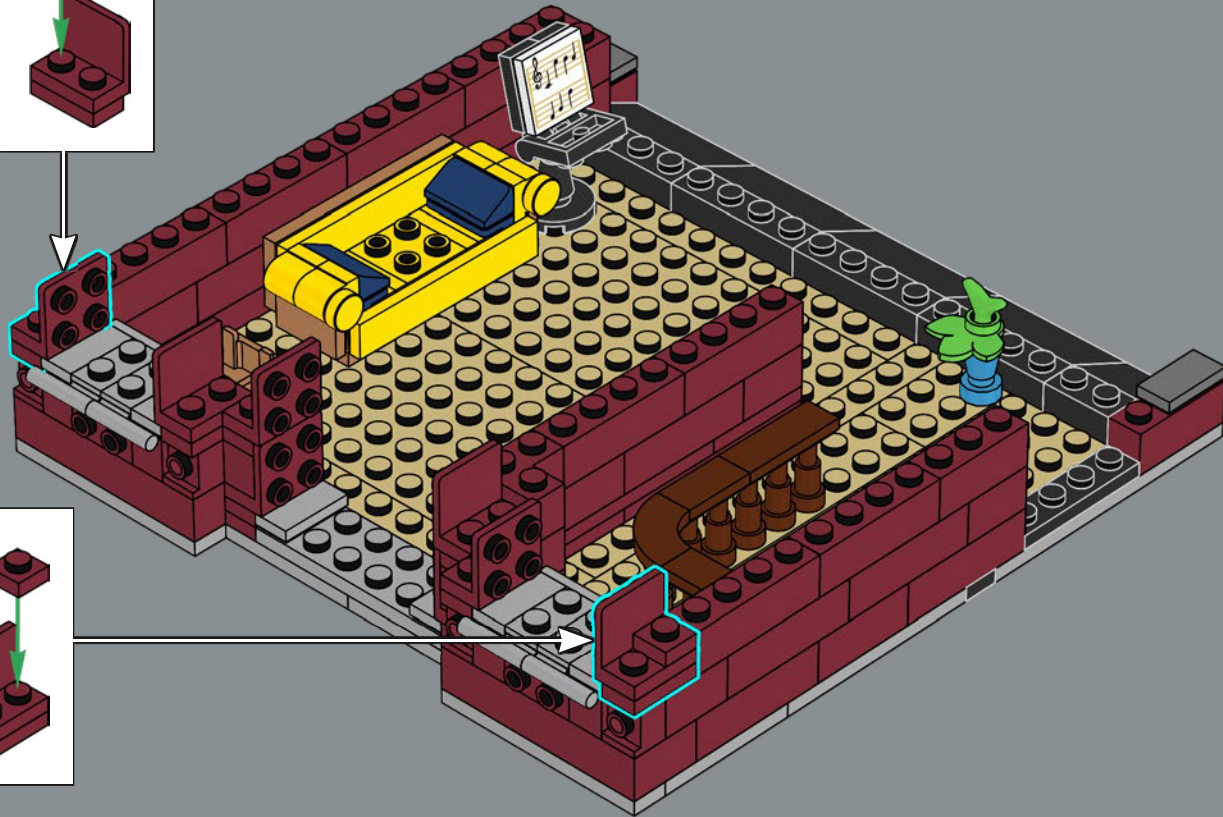
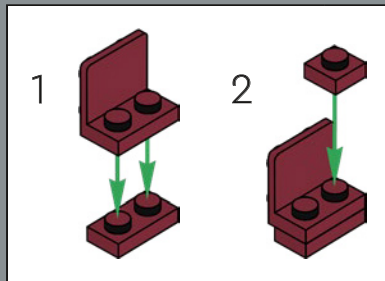
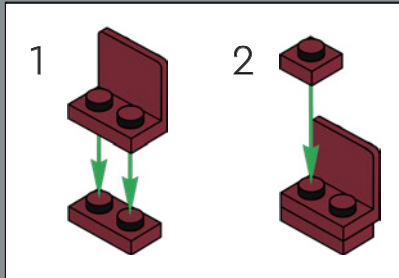

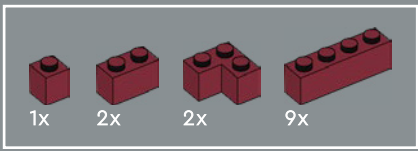

309

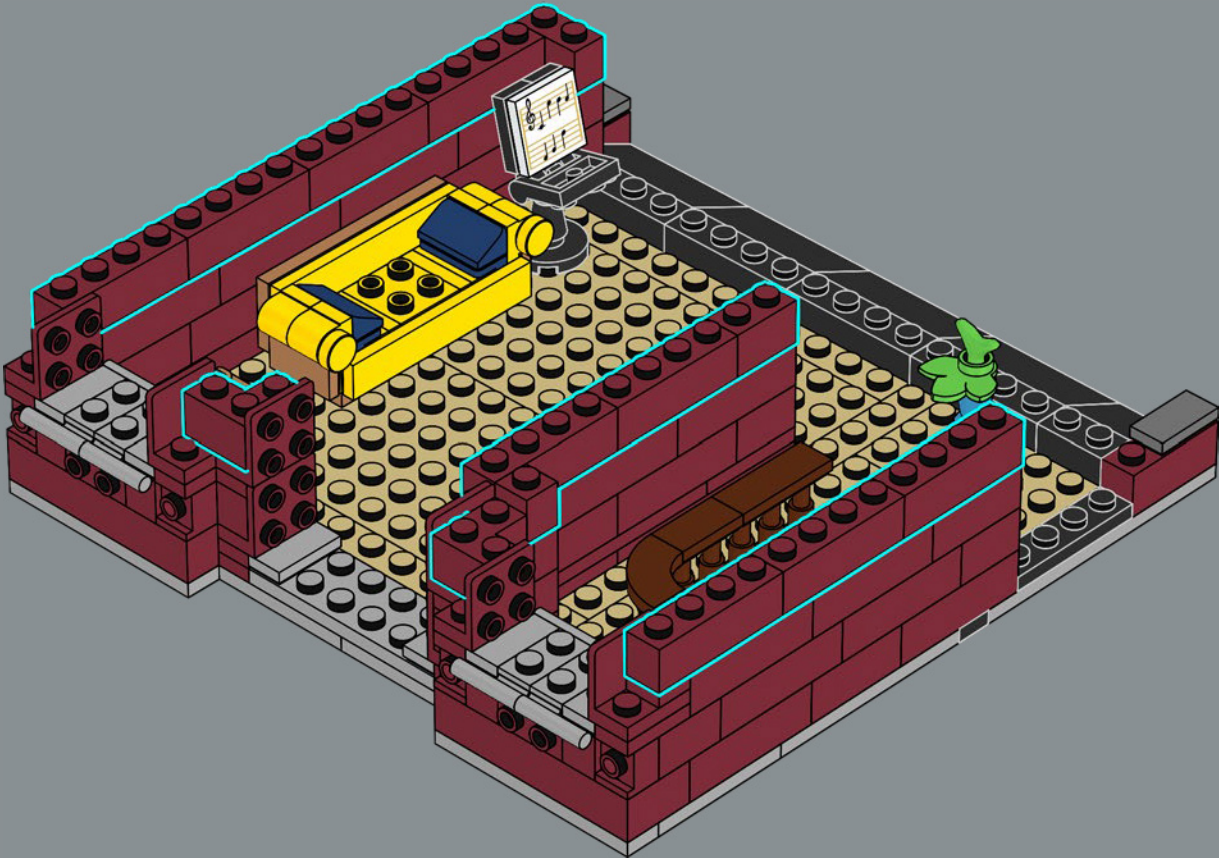



4x

310

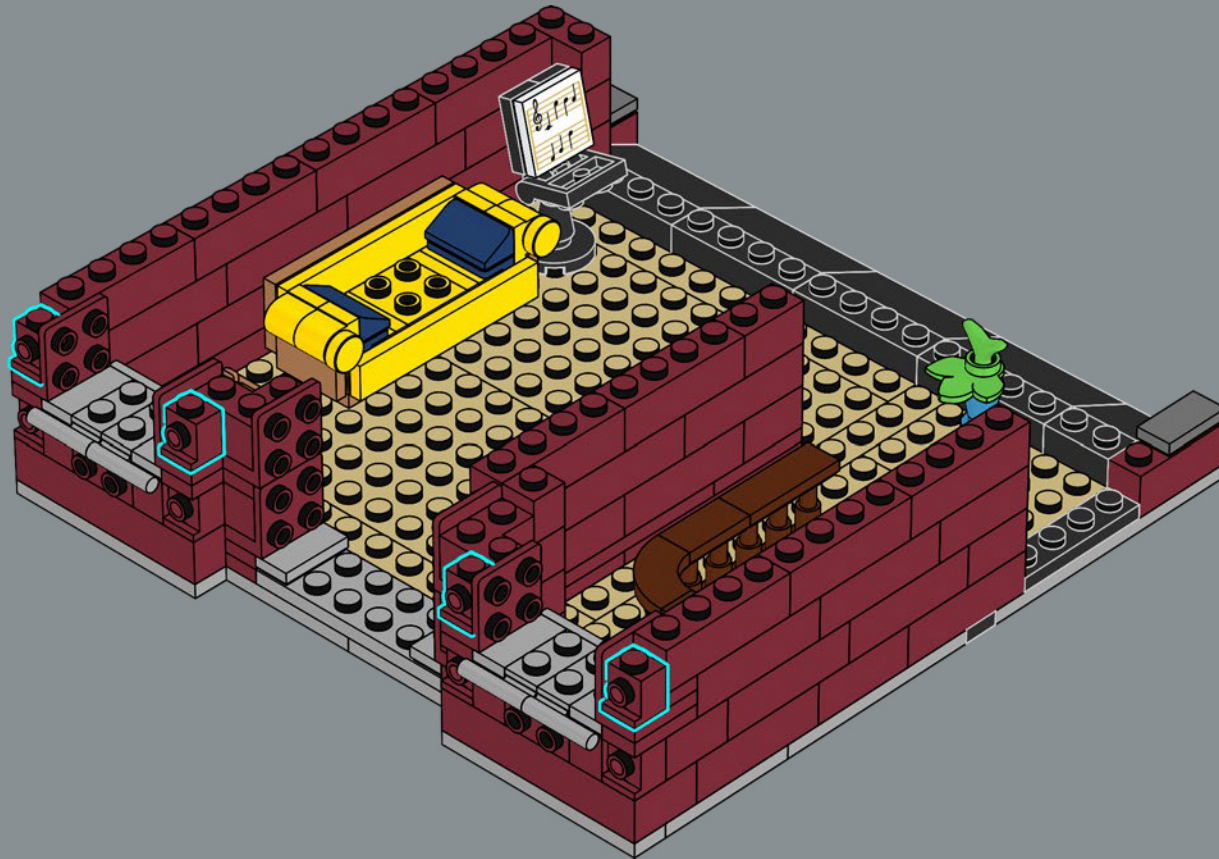

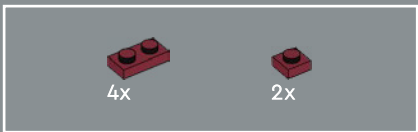

311

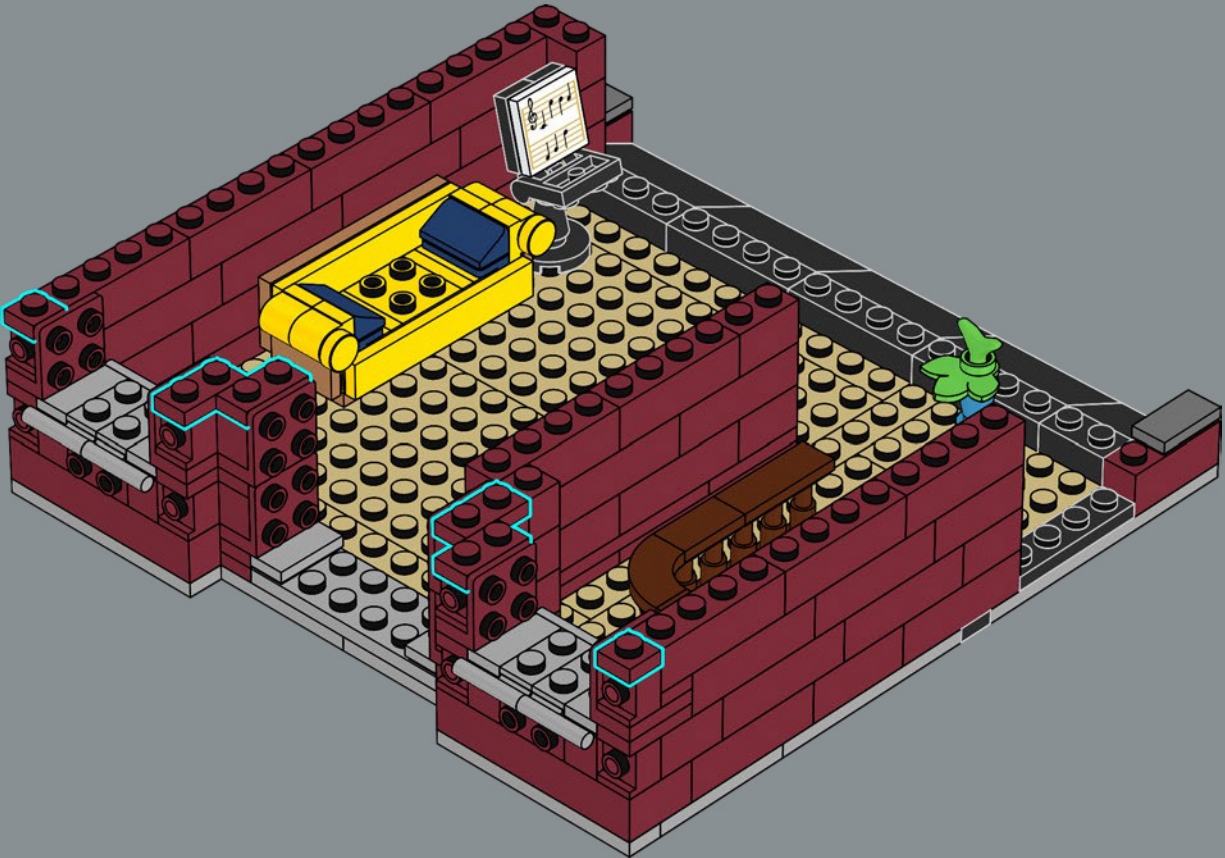

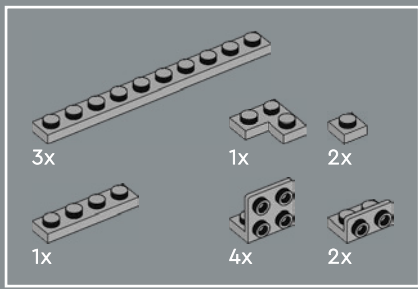

312

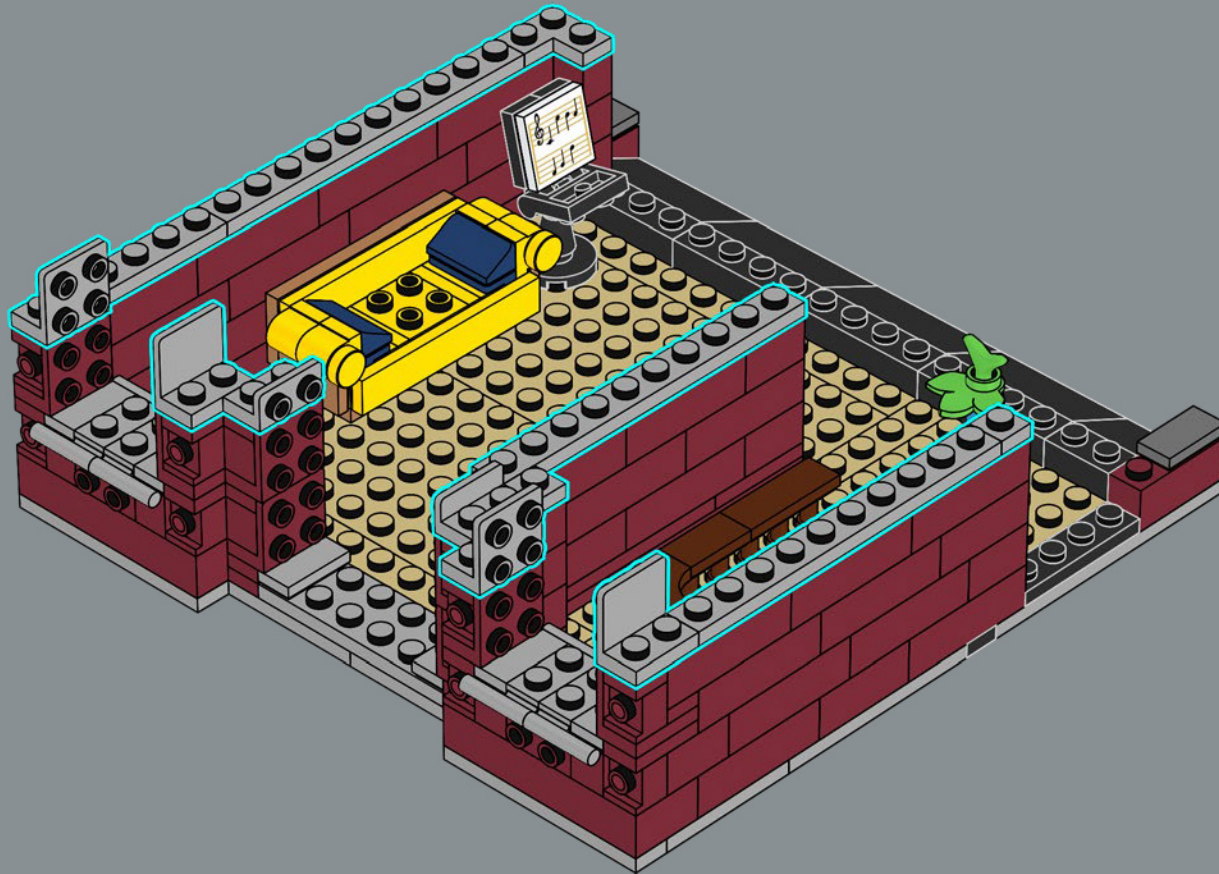

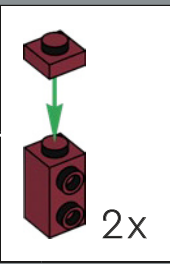
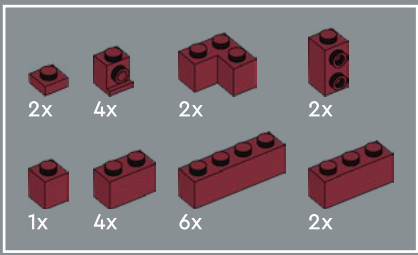

313

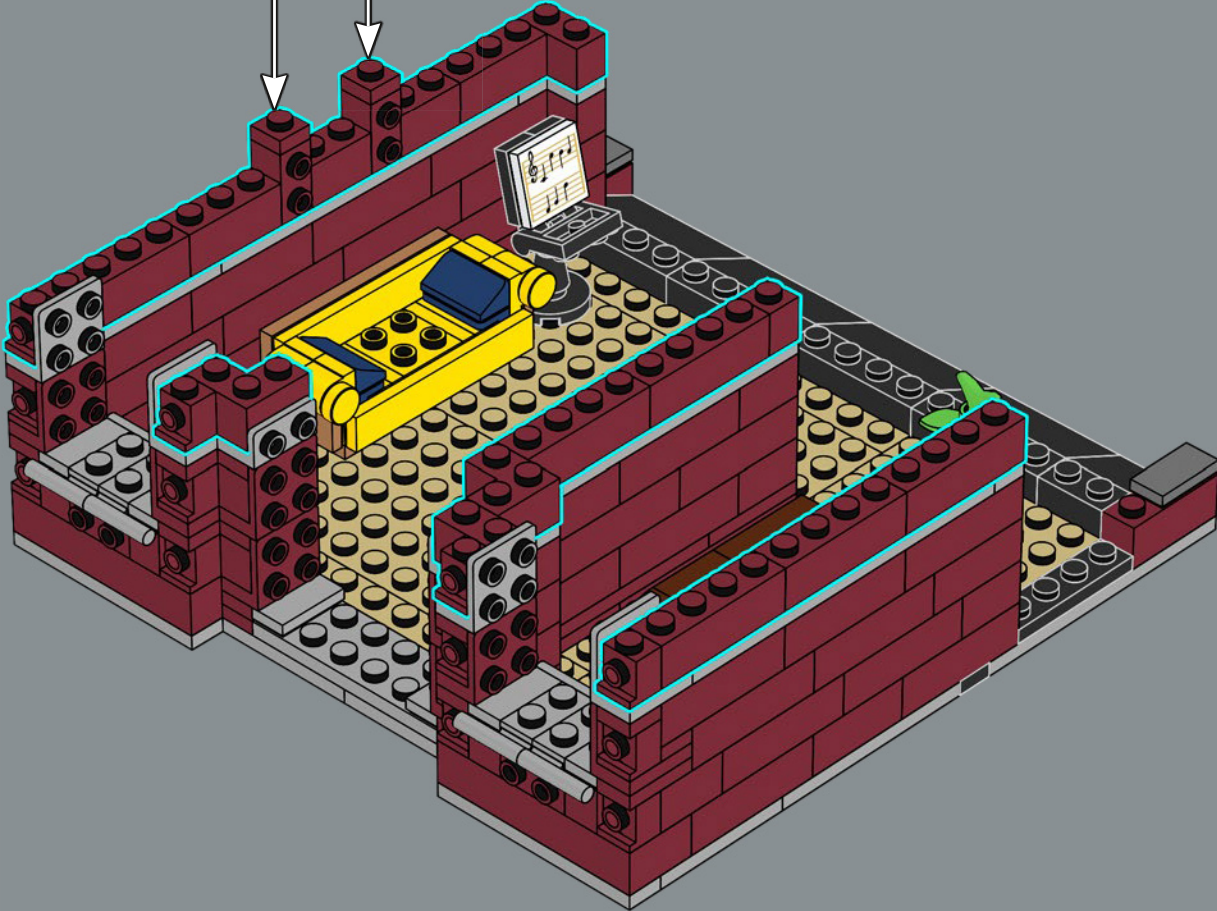

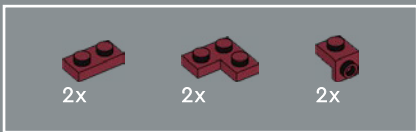

314

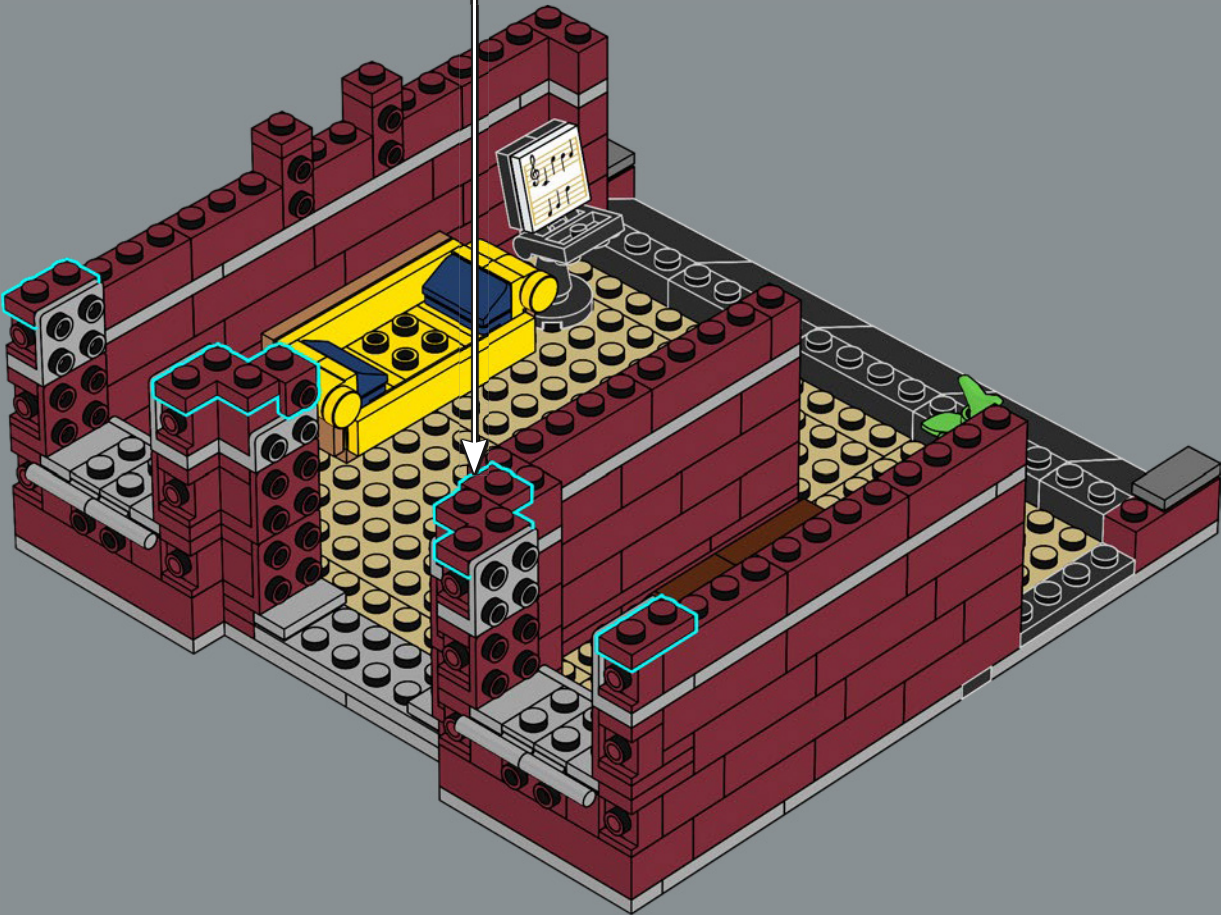

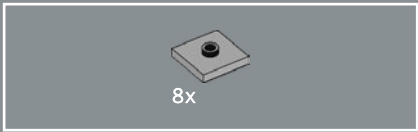

315

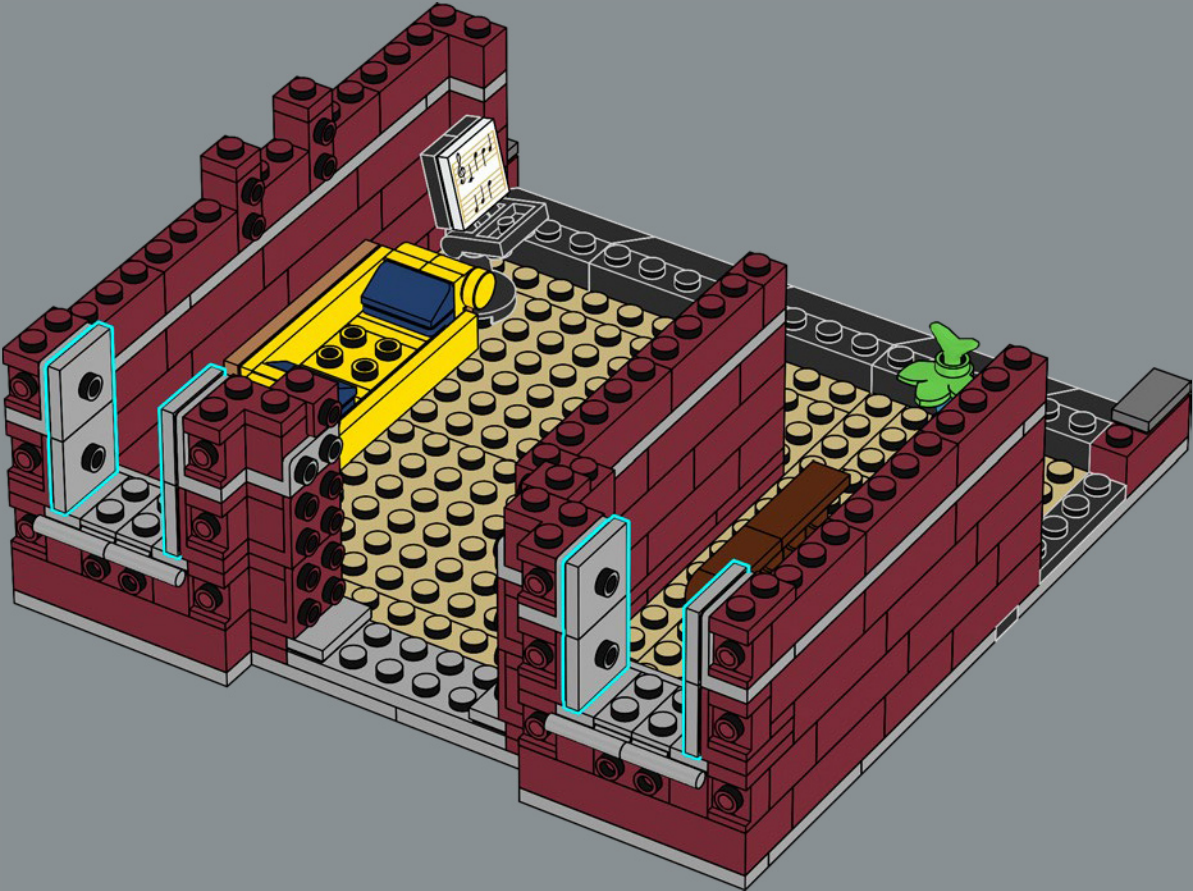

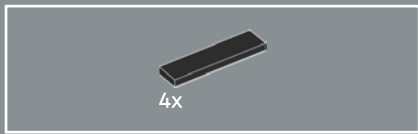

316

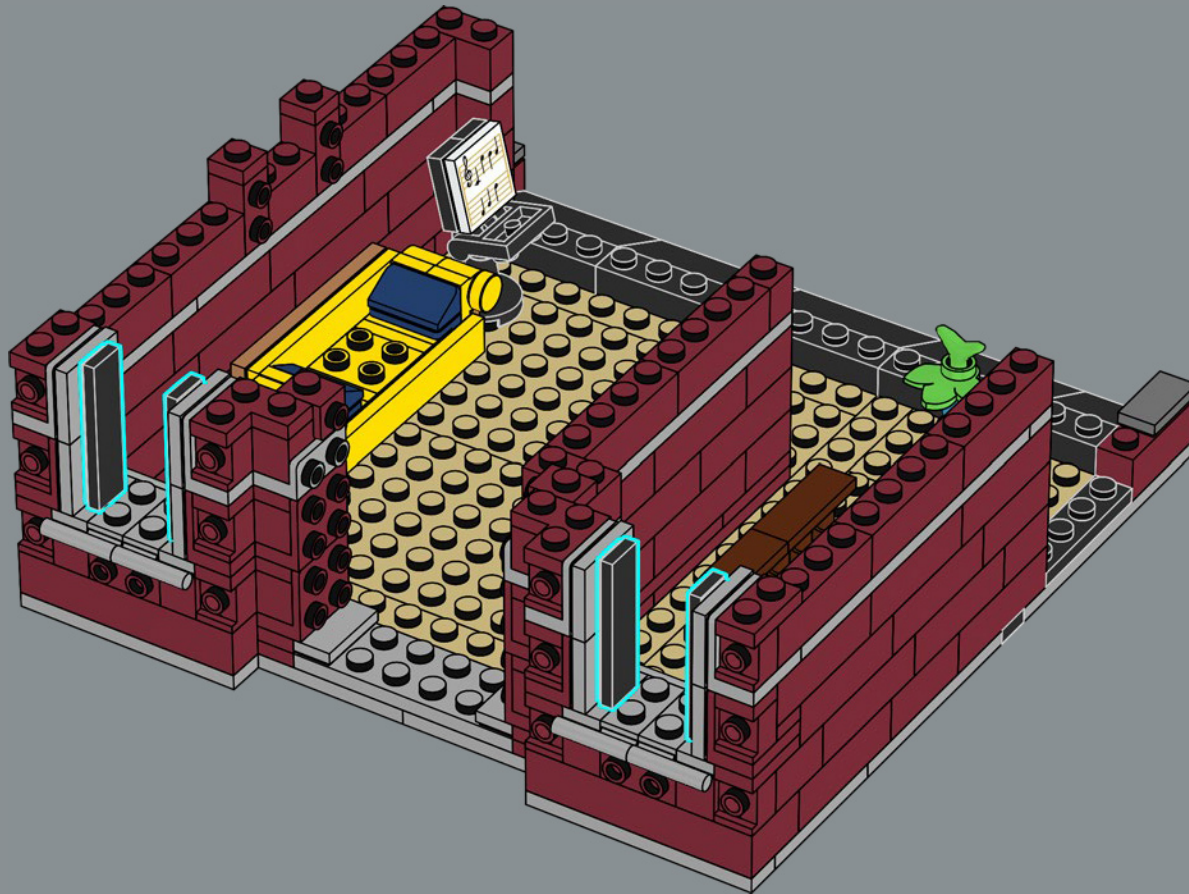



317

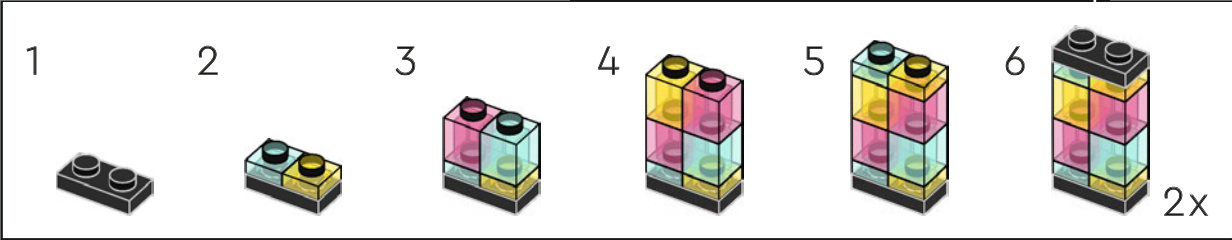
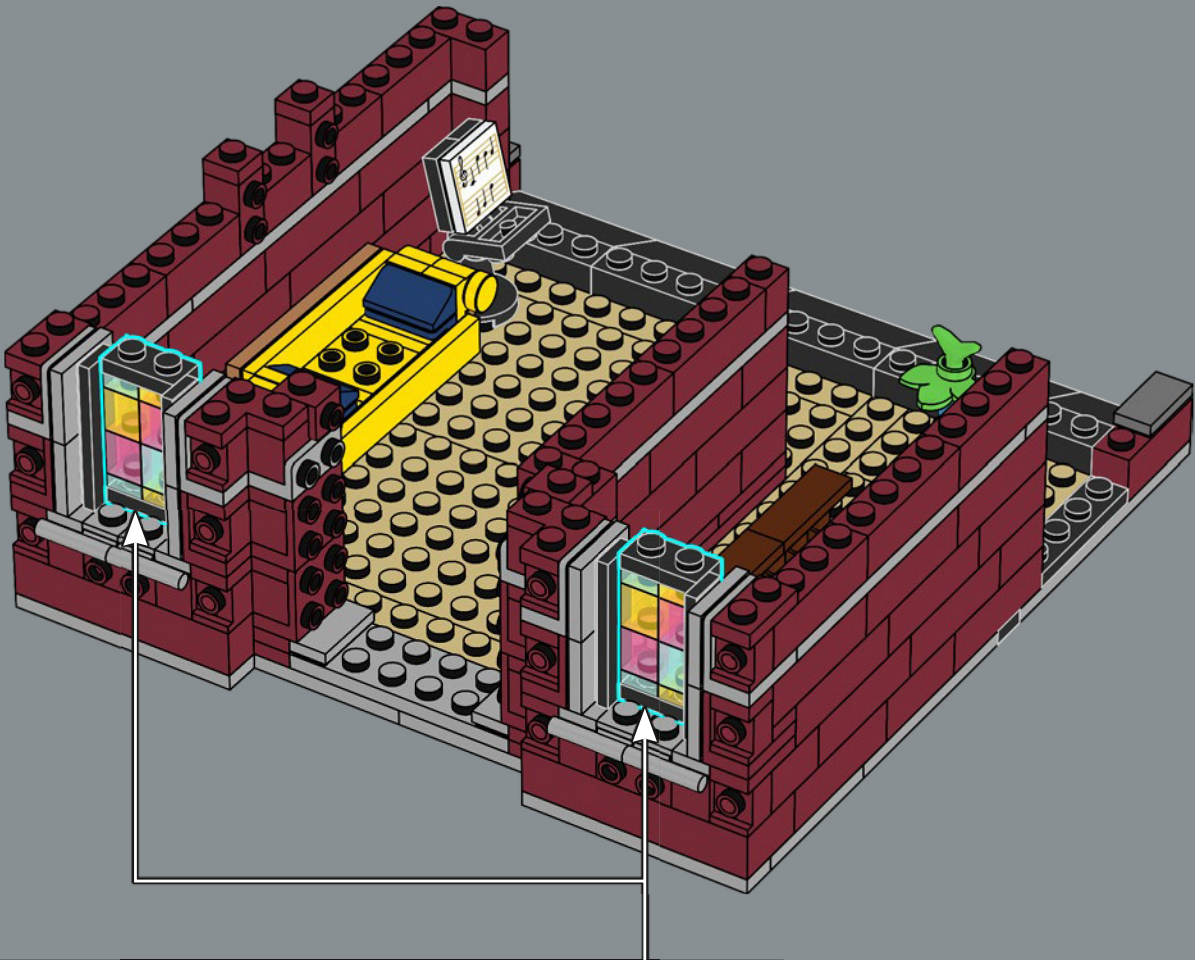

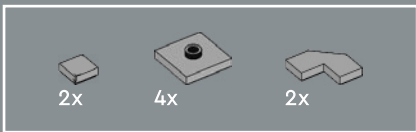

318

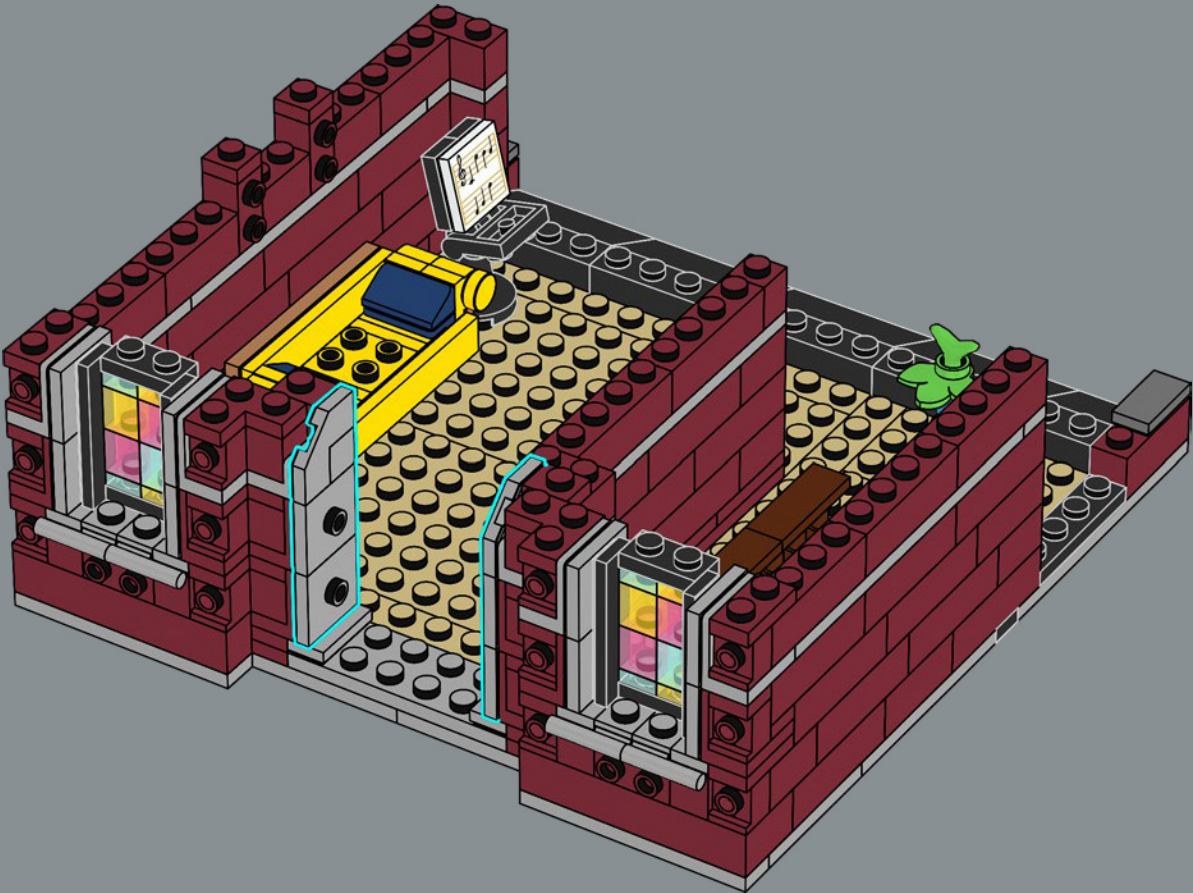

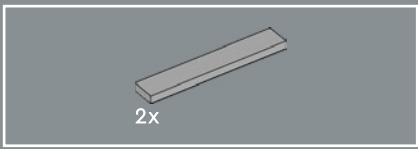

319

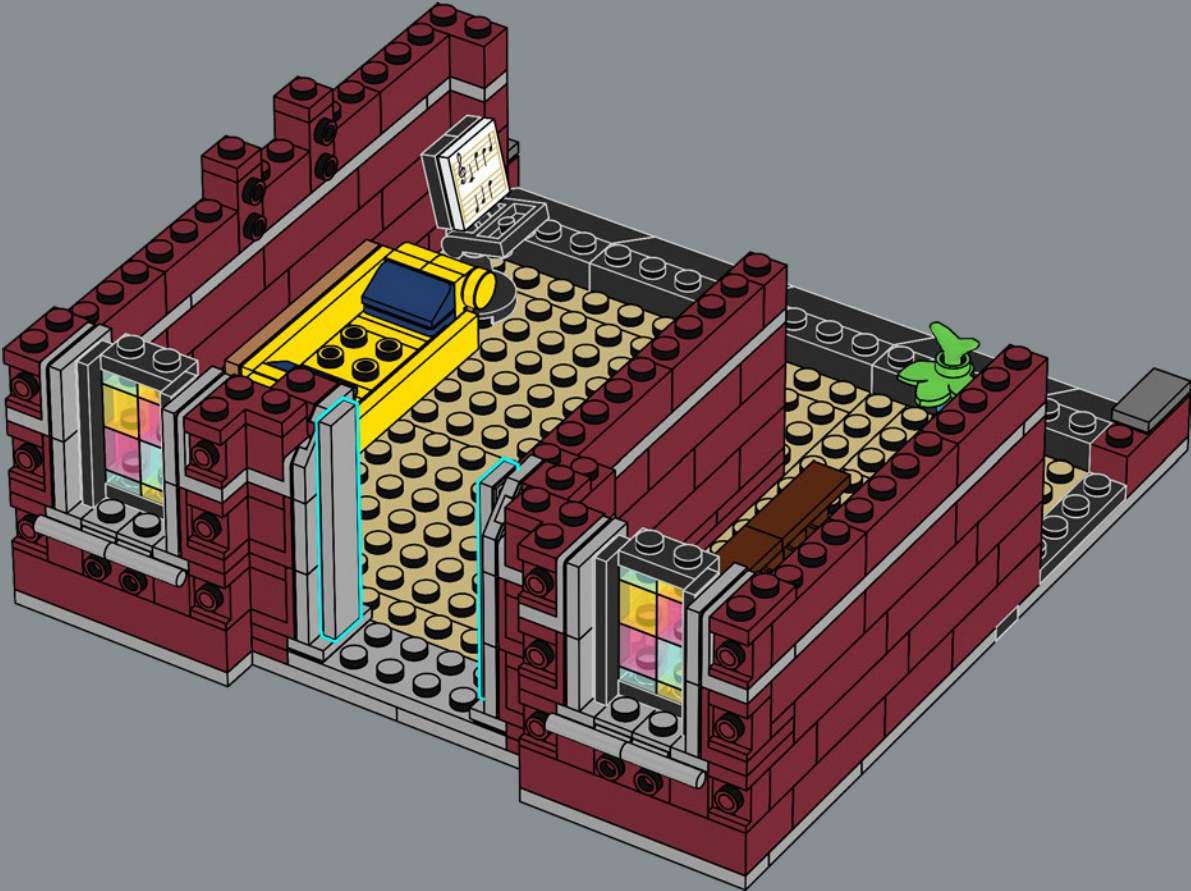

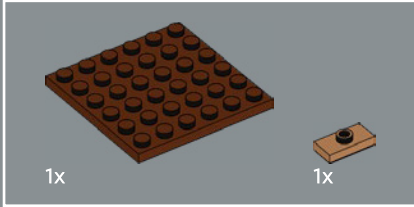
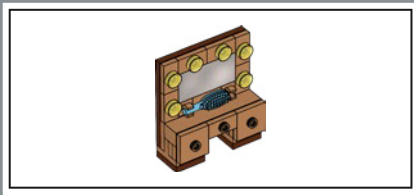

320

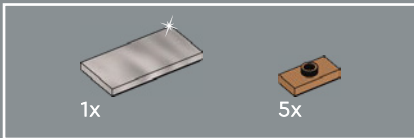
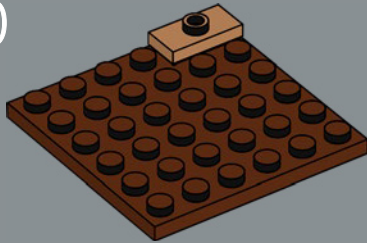

321

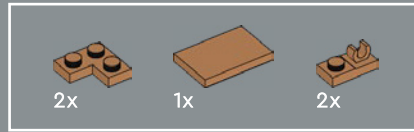
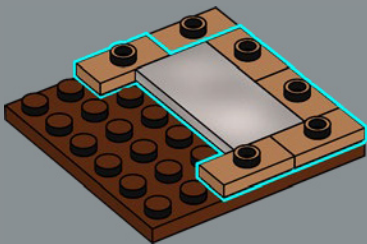

322

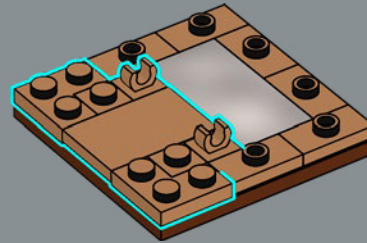

323

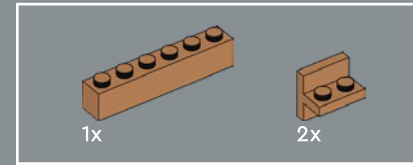
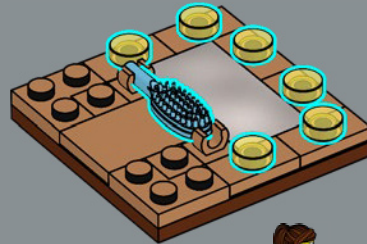

324

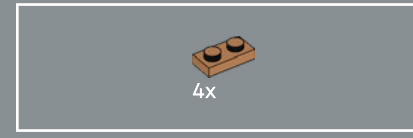
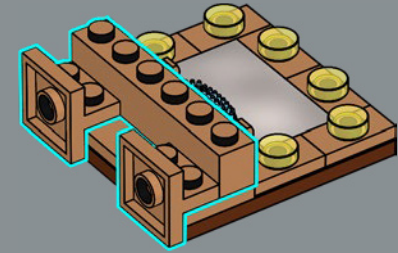

325

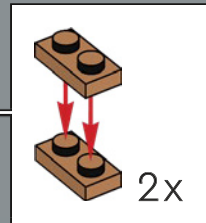
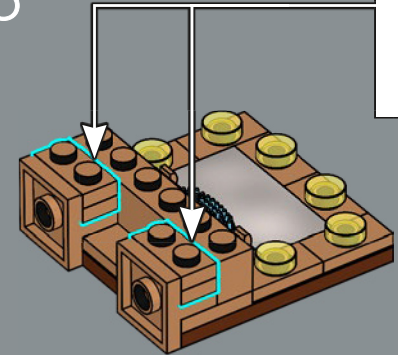

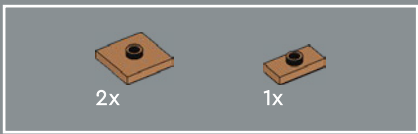

326

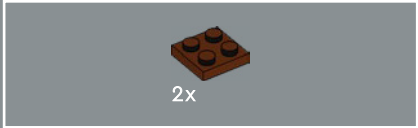
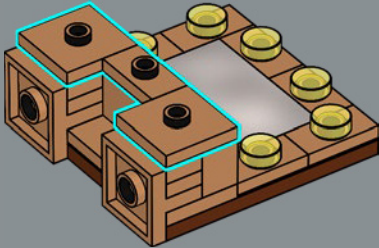

327

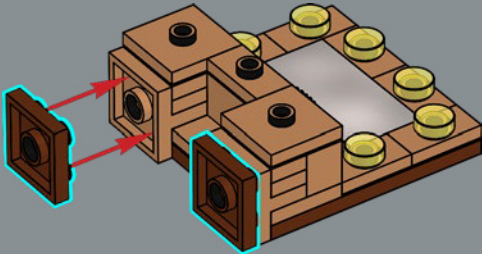

328

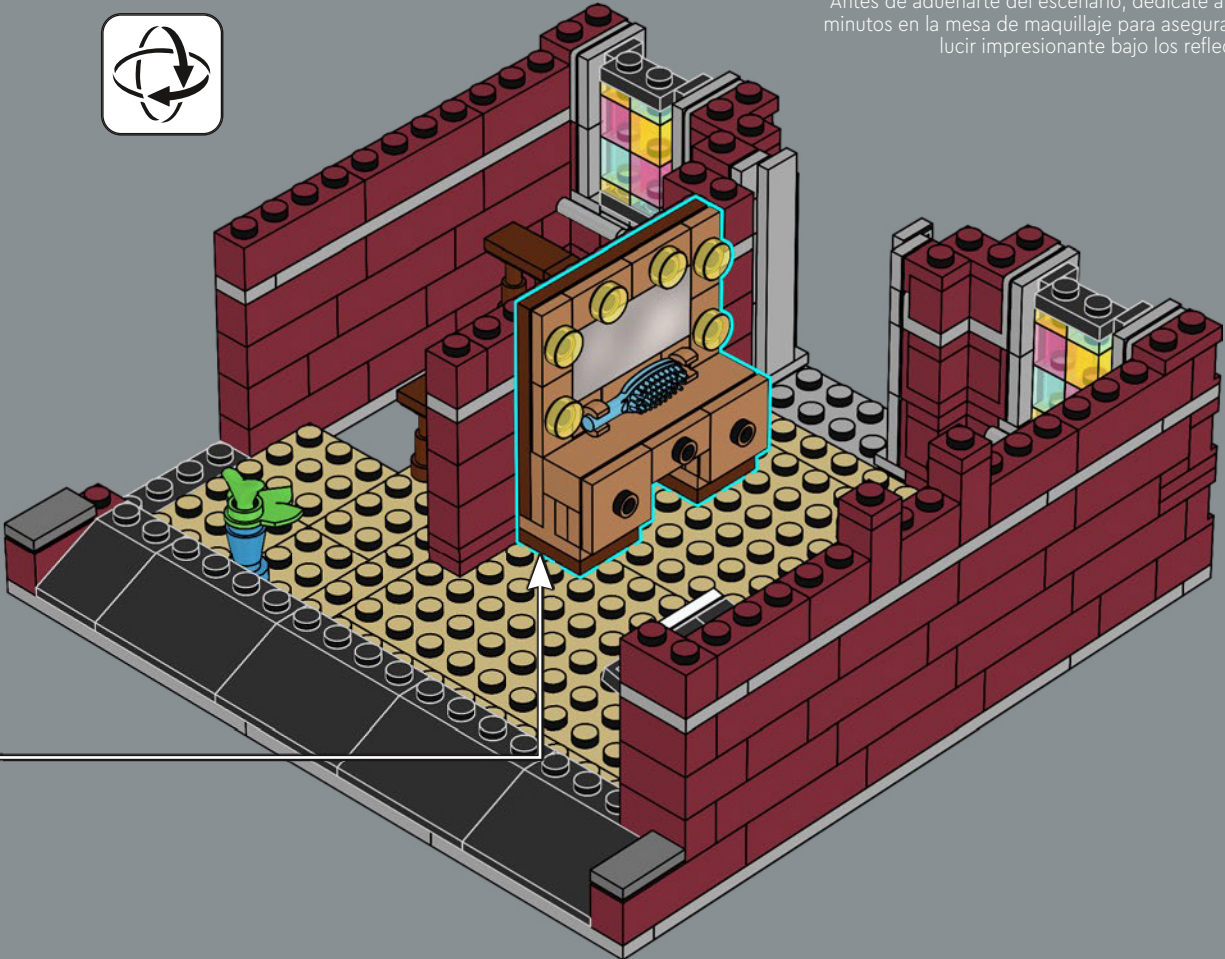

Before you take the stage, take a few minutes at the makeup table to be sure you will look your best under the bright lights.

Avant de monter sur scène, prenez quelques minutes à la station de maquillage pour vous assurer que vous serez à votre avantage sous les lumières vives.

Antes de adueñarte del escenario, dedícate algunos minutos en la mesa de maquillaje para asegurarte de lucir impresionante bajo los reflectores.

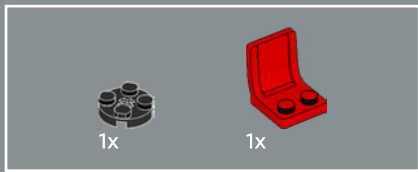

329

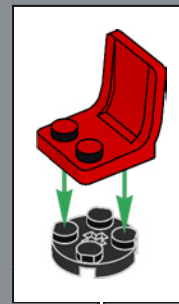

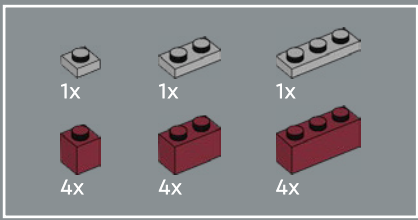

330

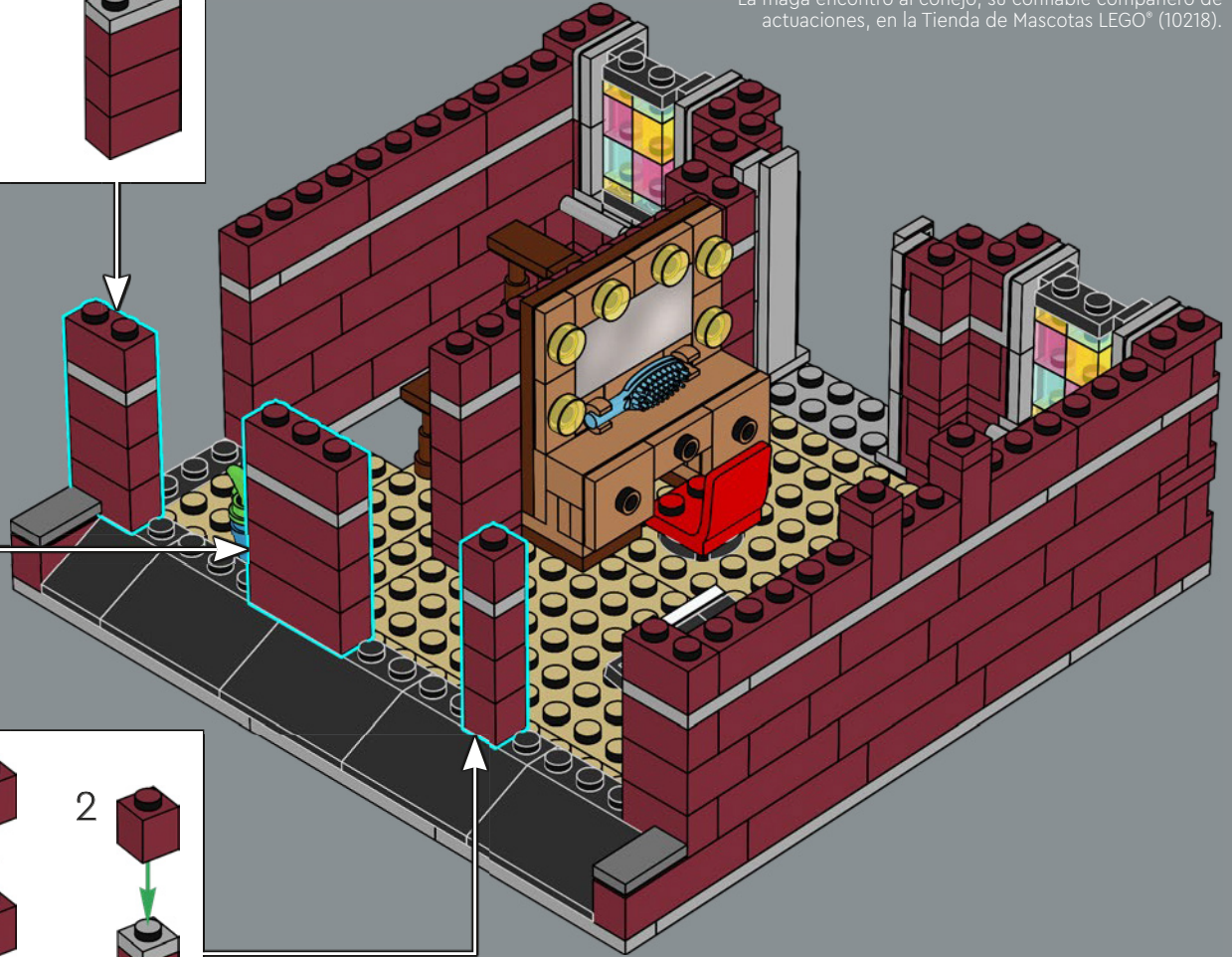
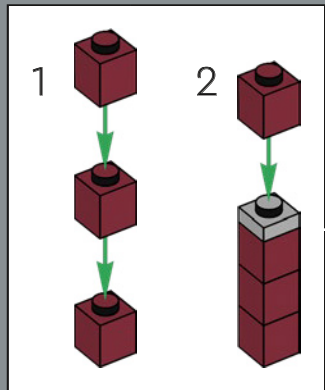
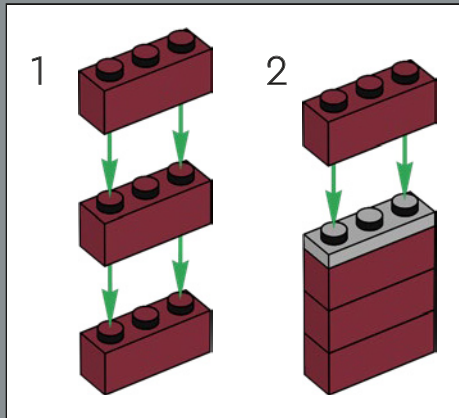
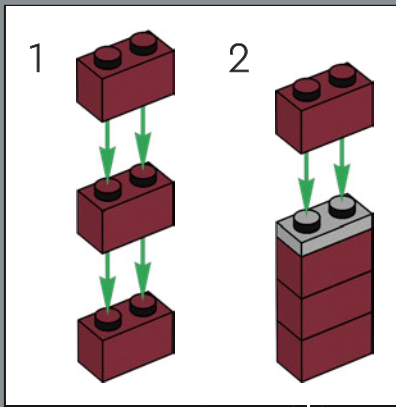

The magician found her trusty magical sidekick the rabbit at the LEGO® 10218 Pet Shop.

La magicienne a trouvé son fidèle compagnon magique, le lapin, à l'Animalerie LEGO® 10218.

La maga encontró al conejo, su confiable compañero de actuaciones, en la Tienda de Mascotas LEGO® (10218).

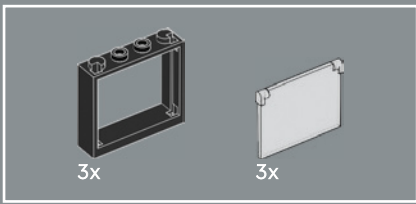

331

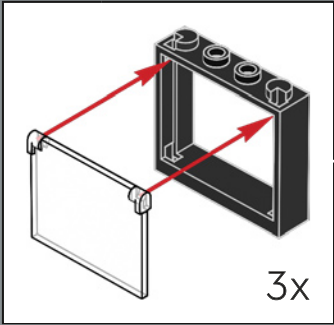
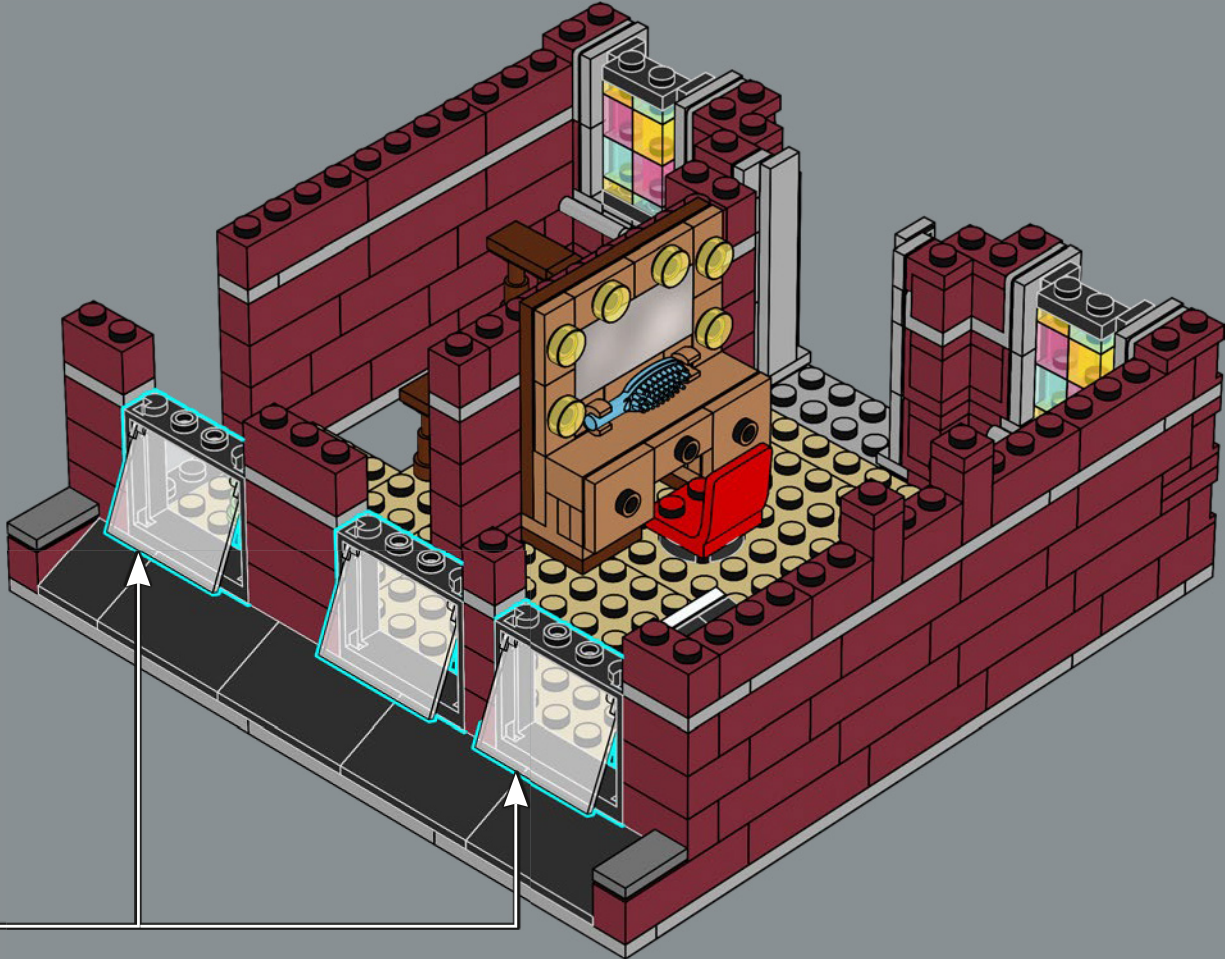

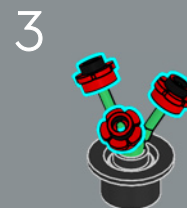
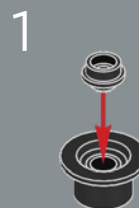
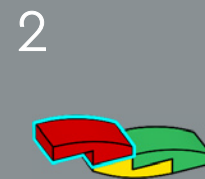
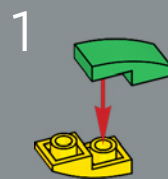
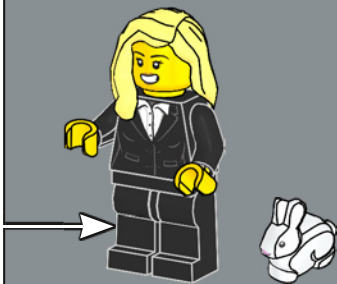
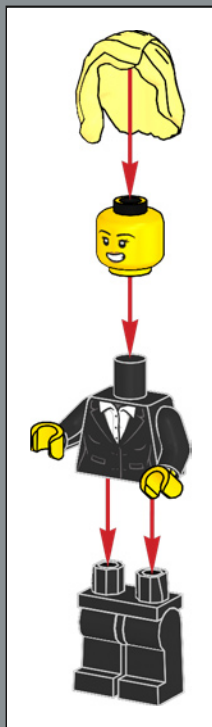

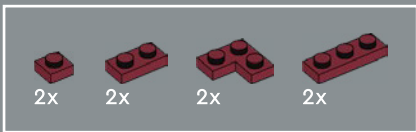

332



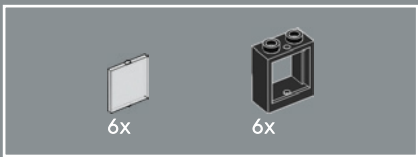

333

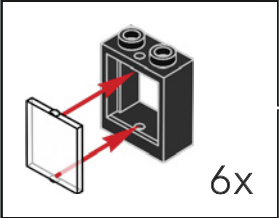

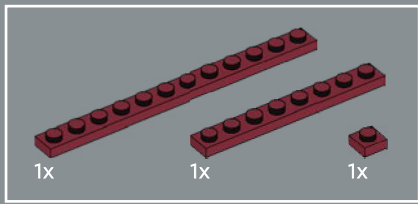

334



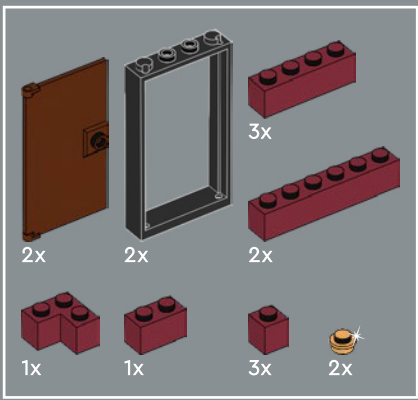

335

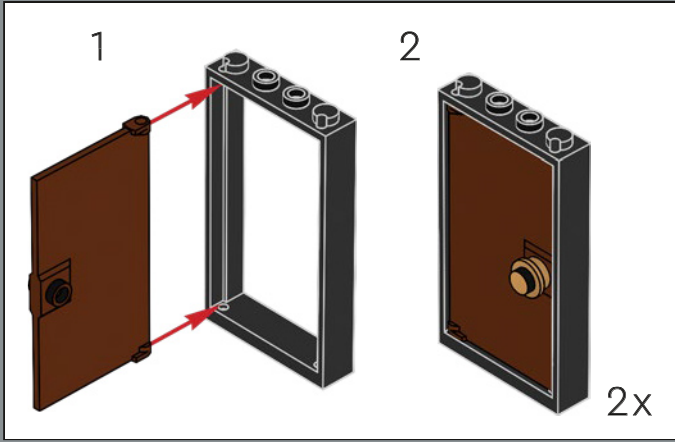

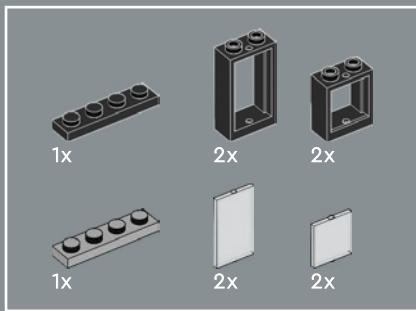

336

1

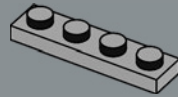

2

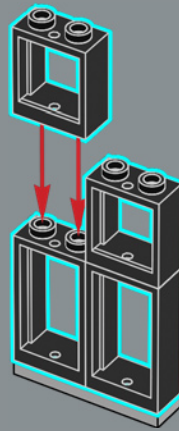

3

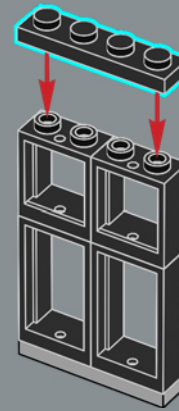

4

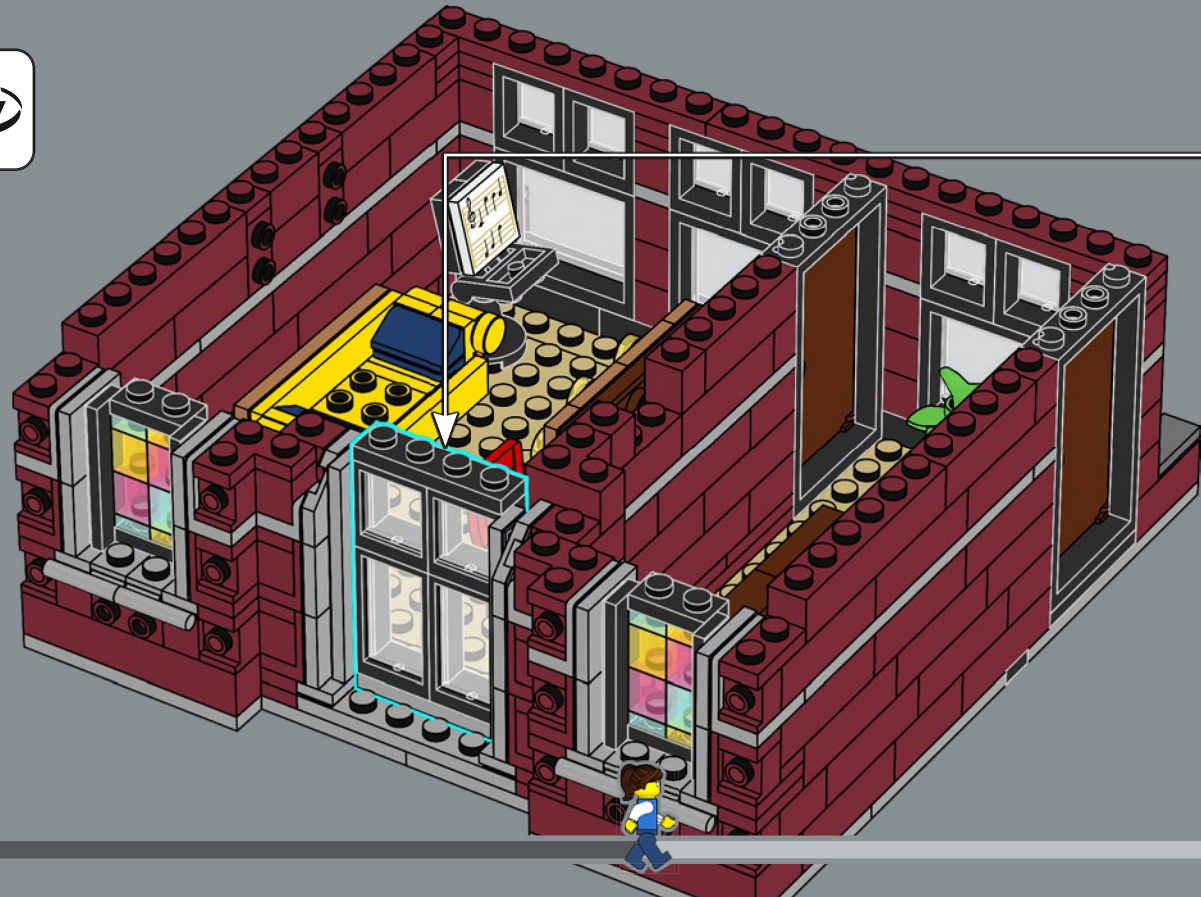
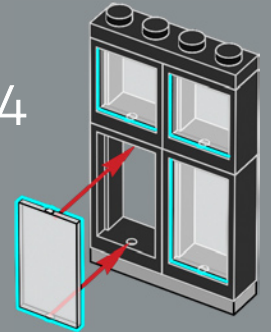

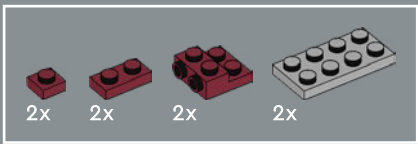

337

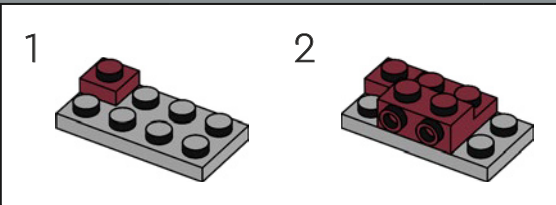
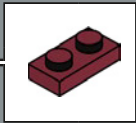
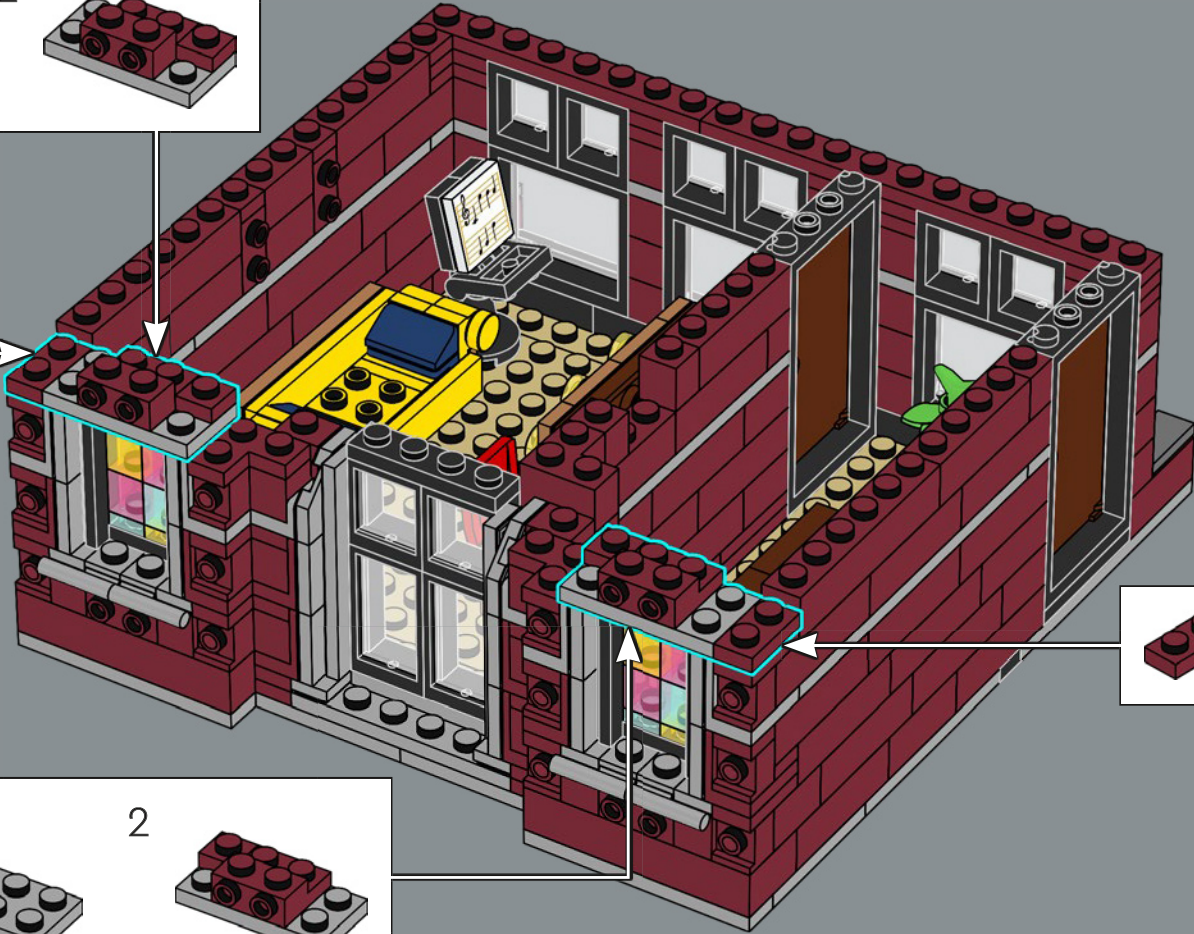
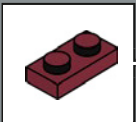
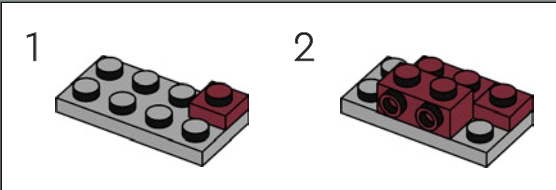

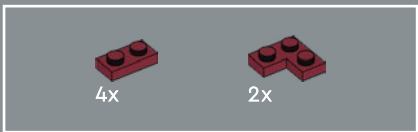

338

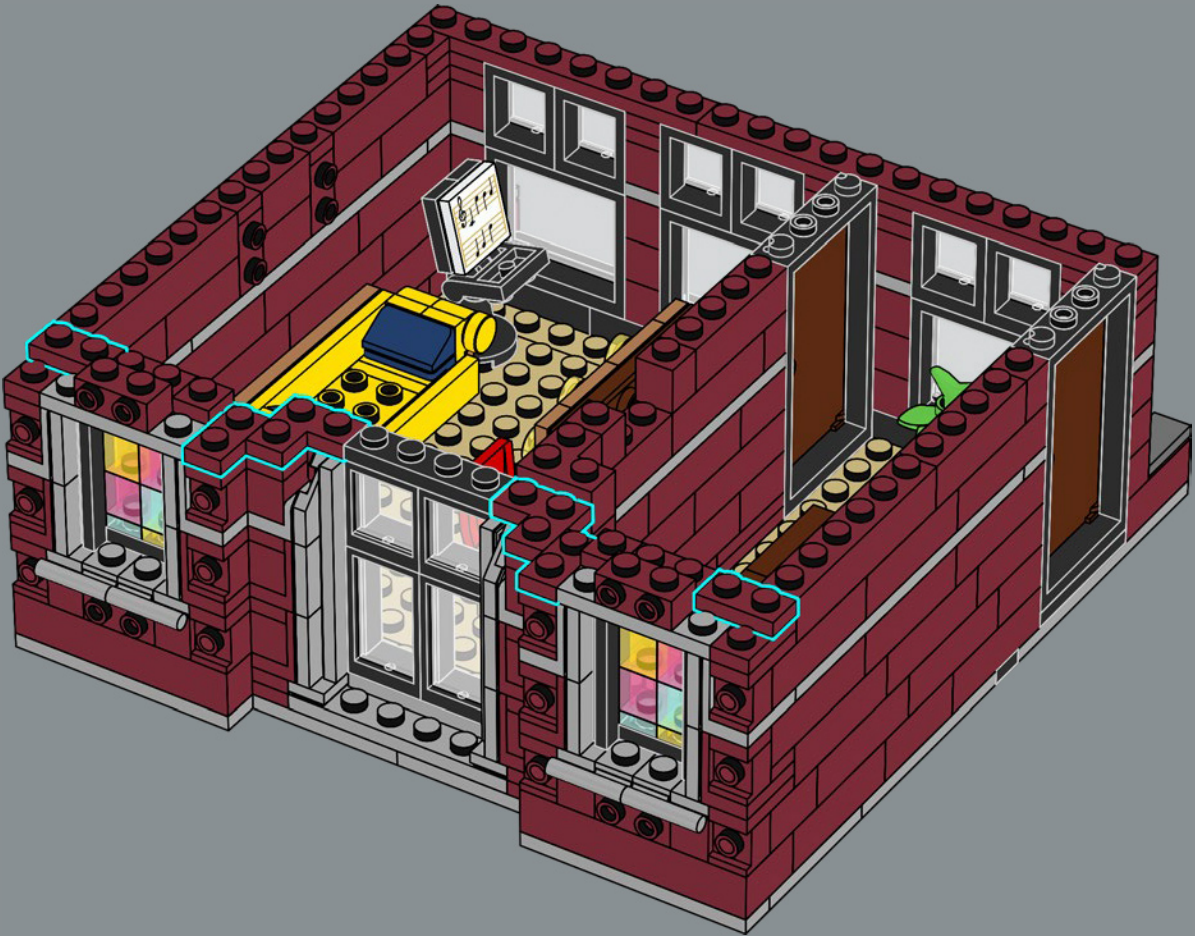

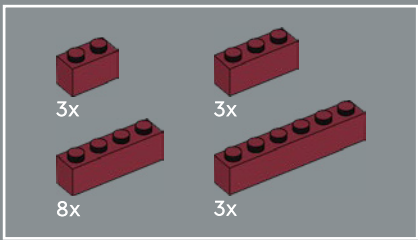

339

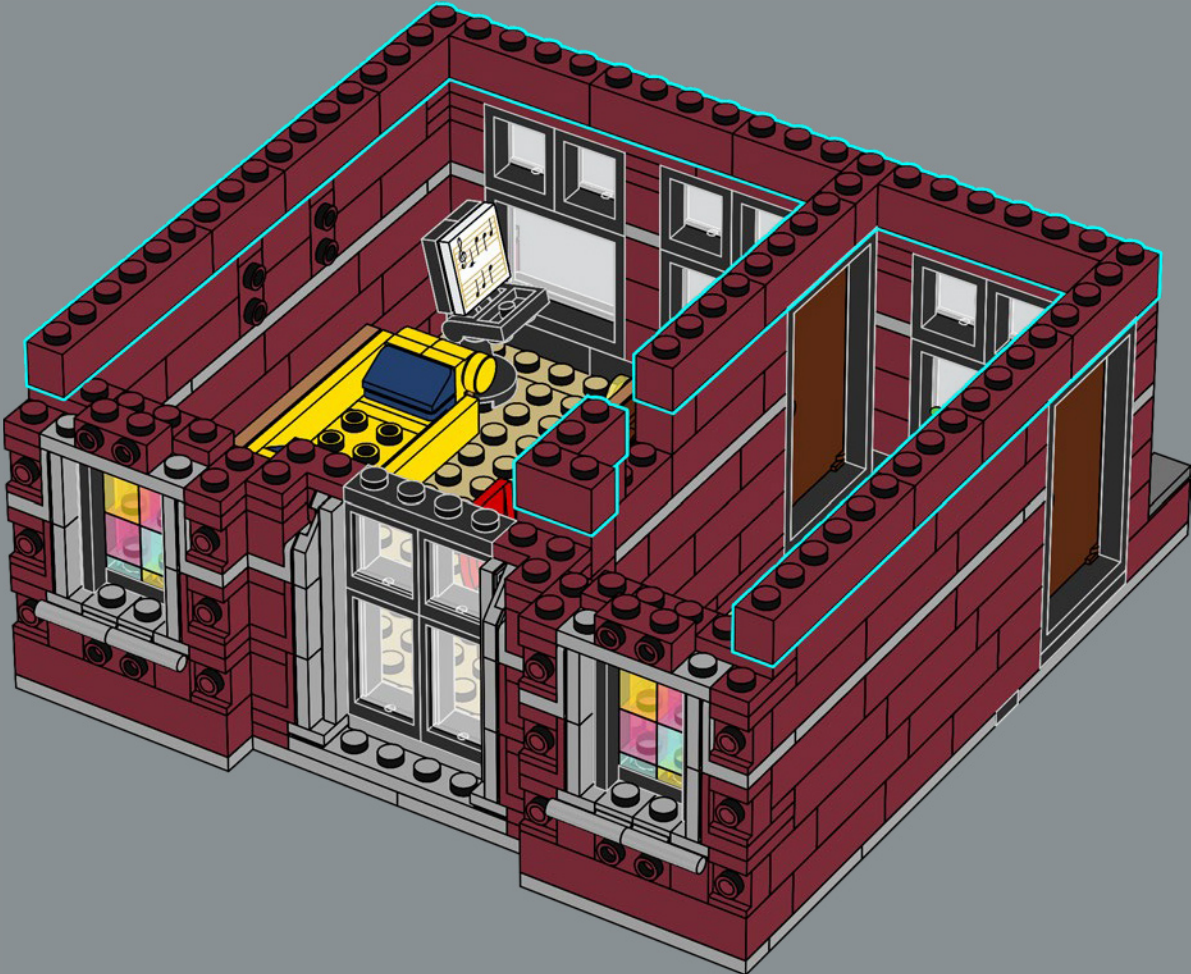

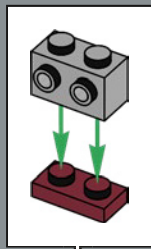
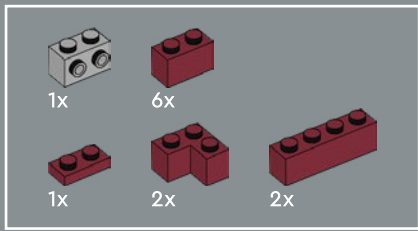

340

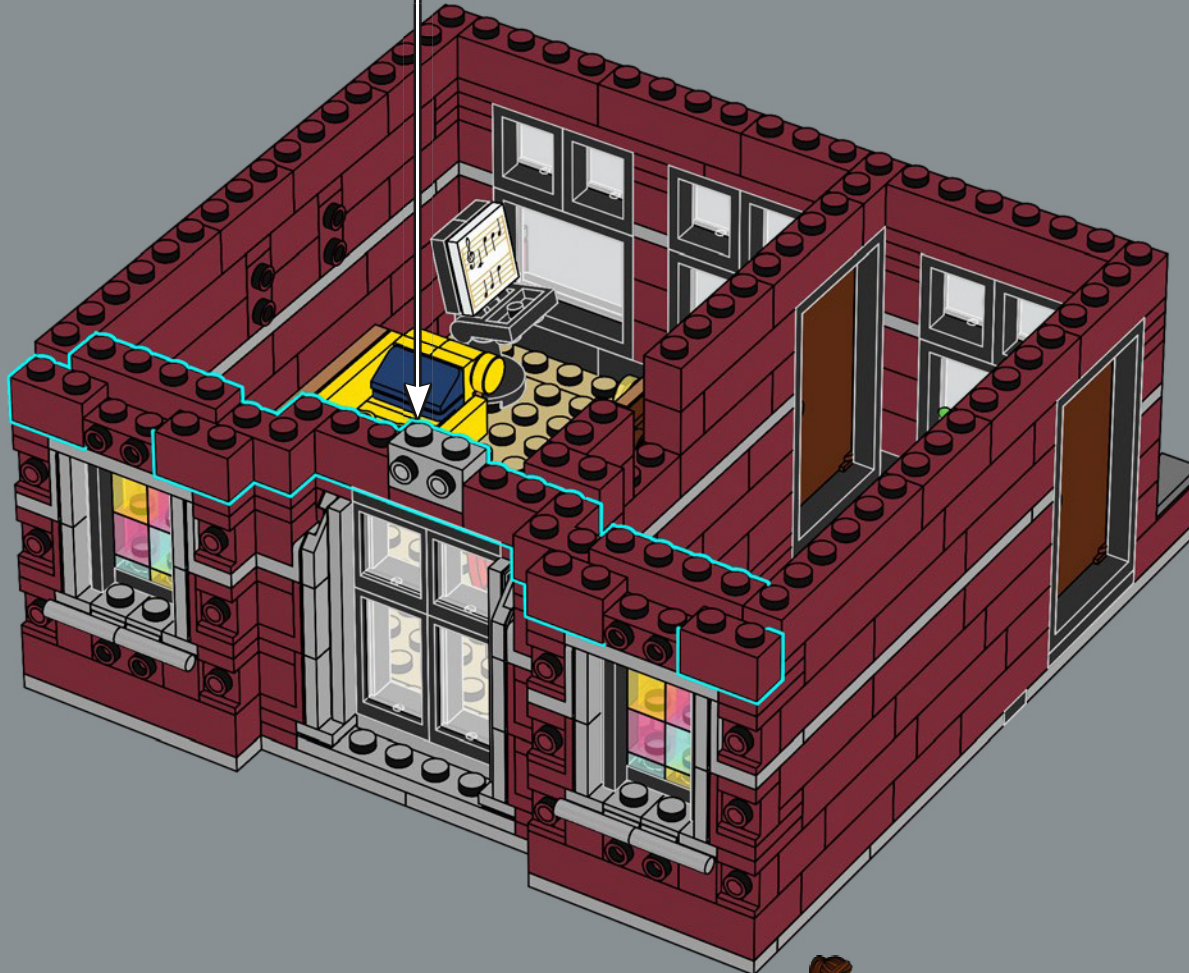

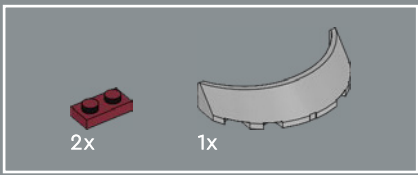

341

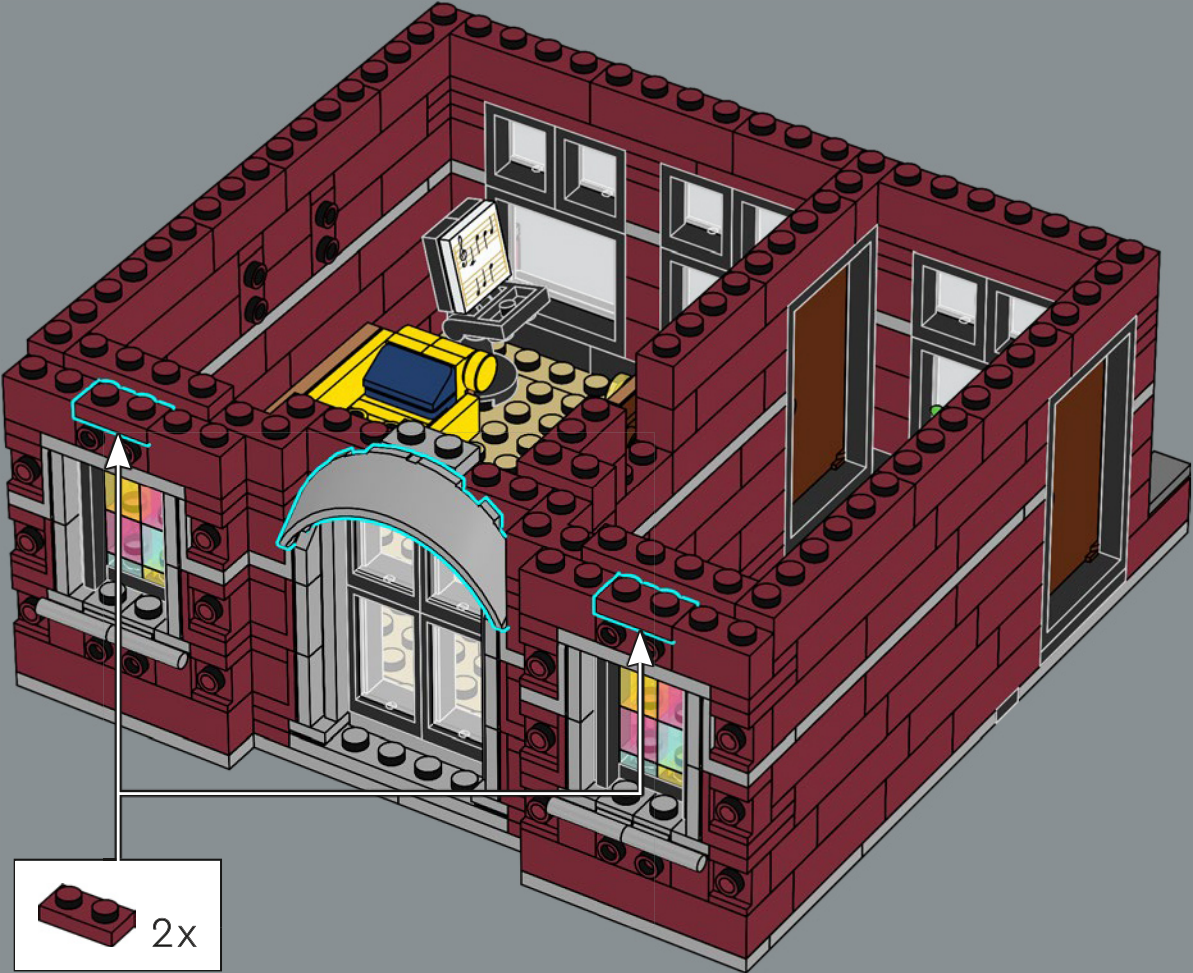

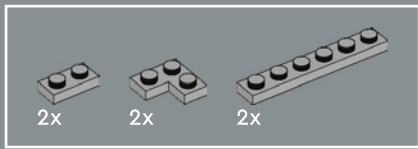

342

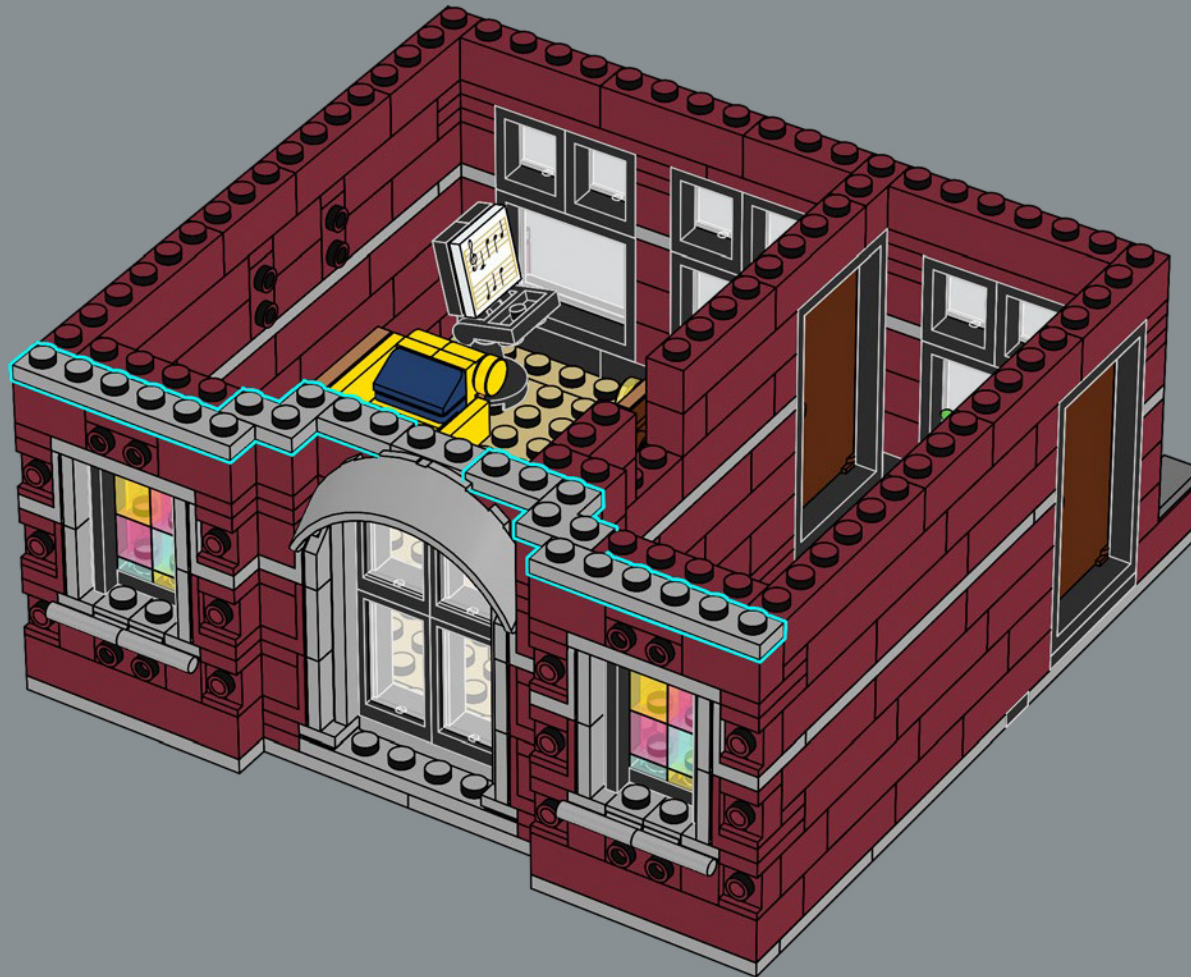

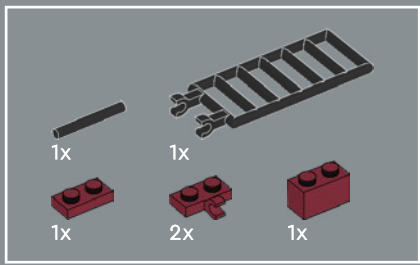

343

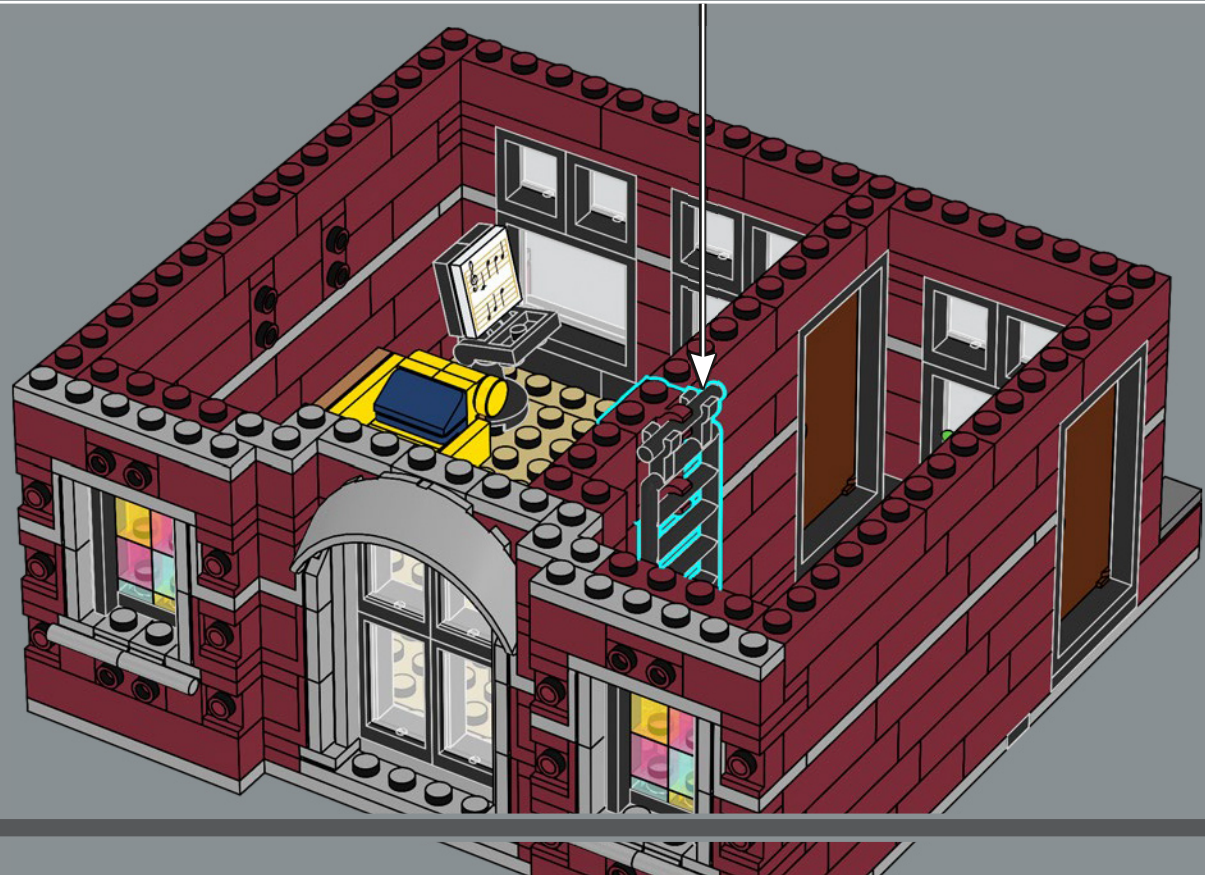
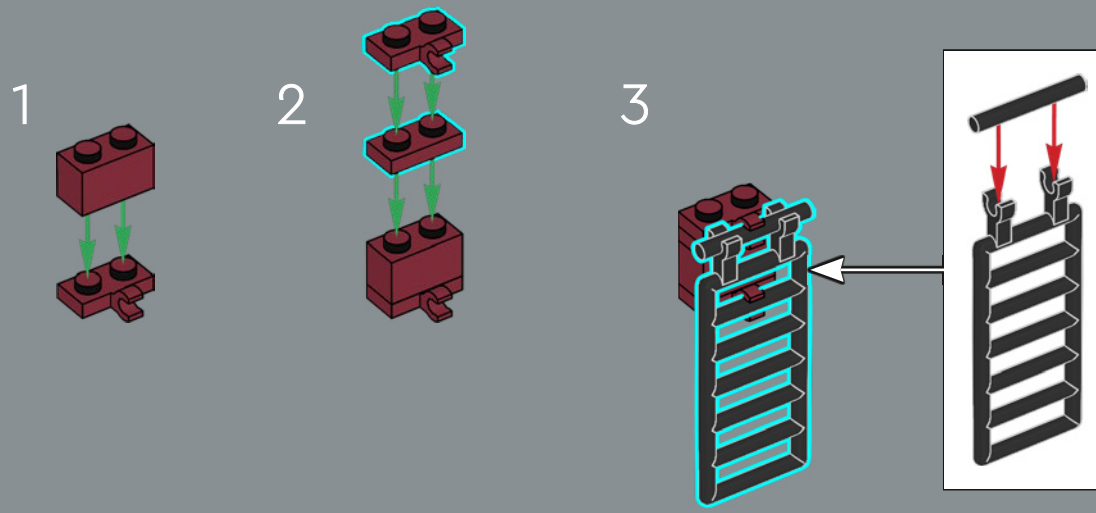

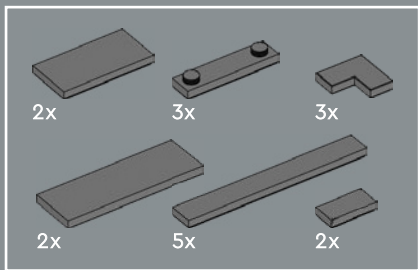

344

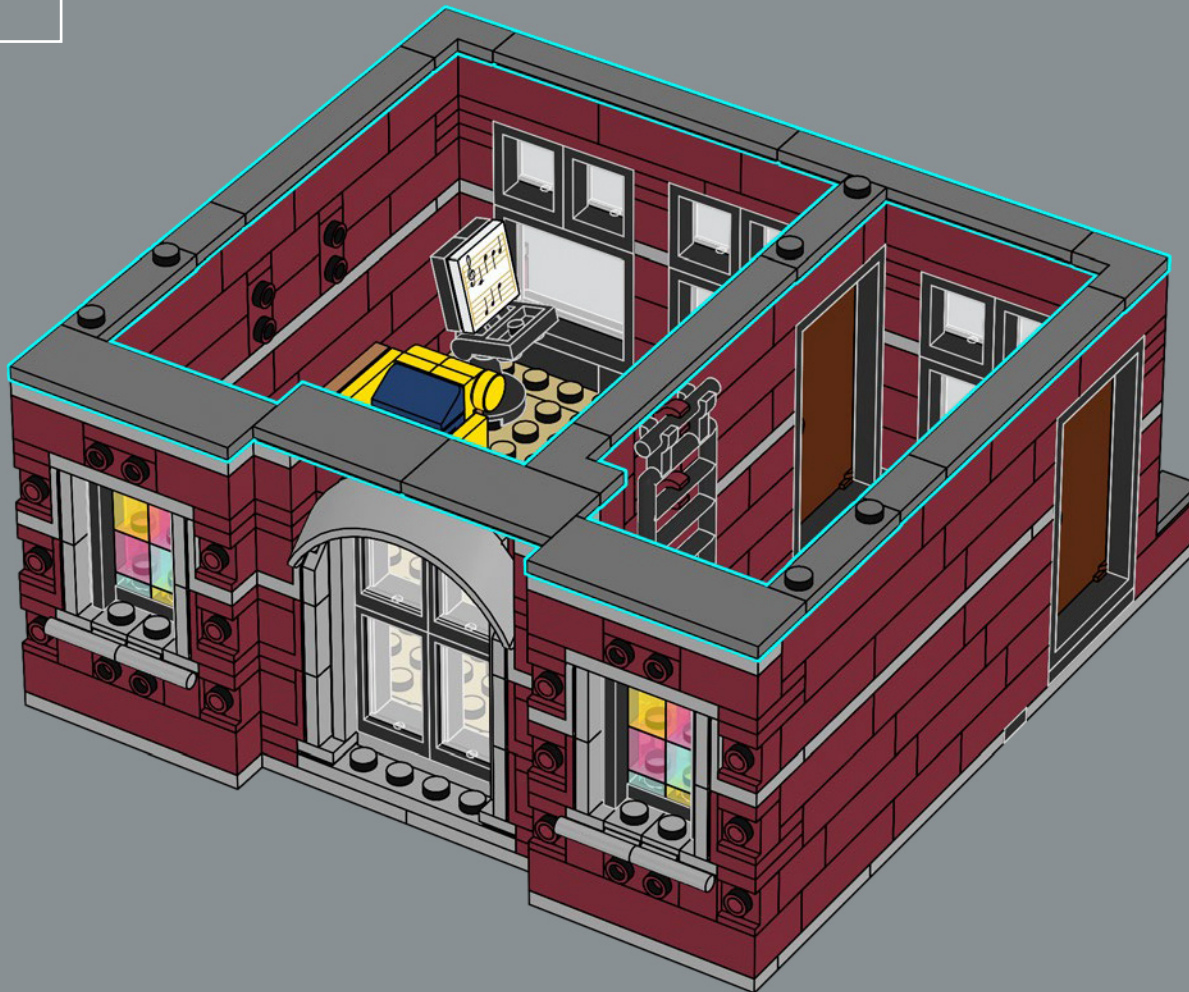

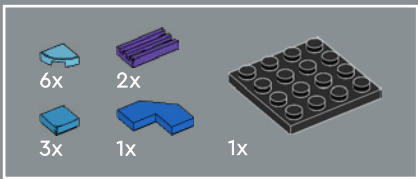

345

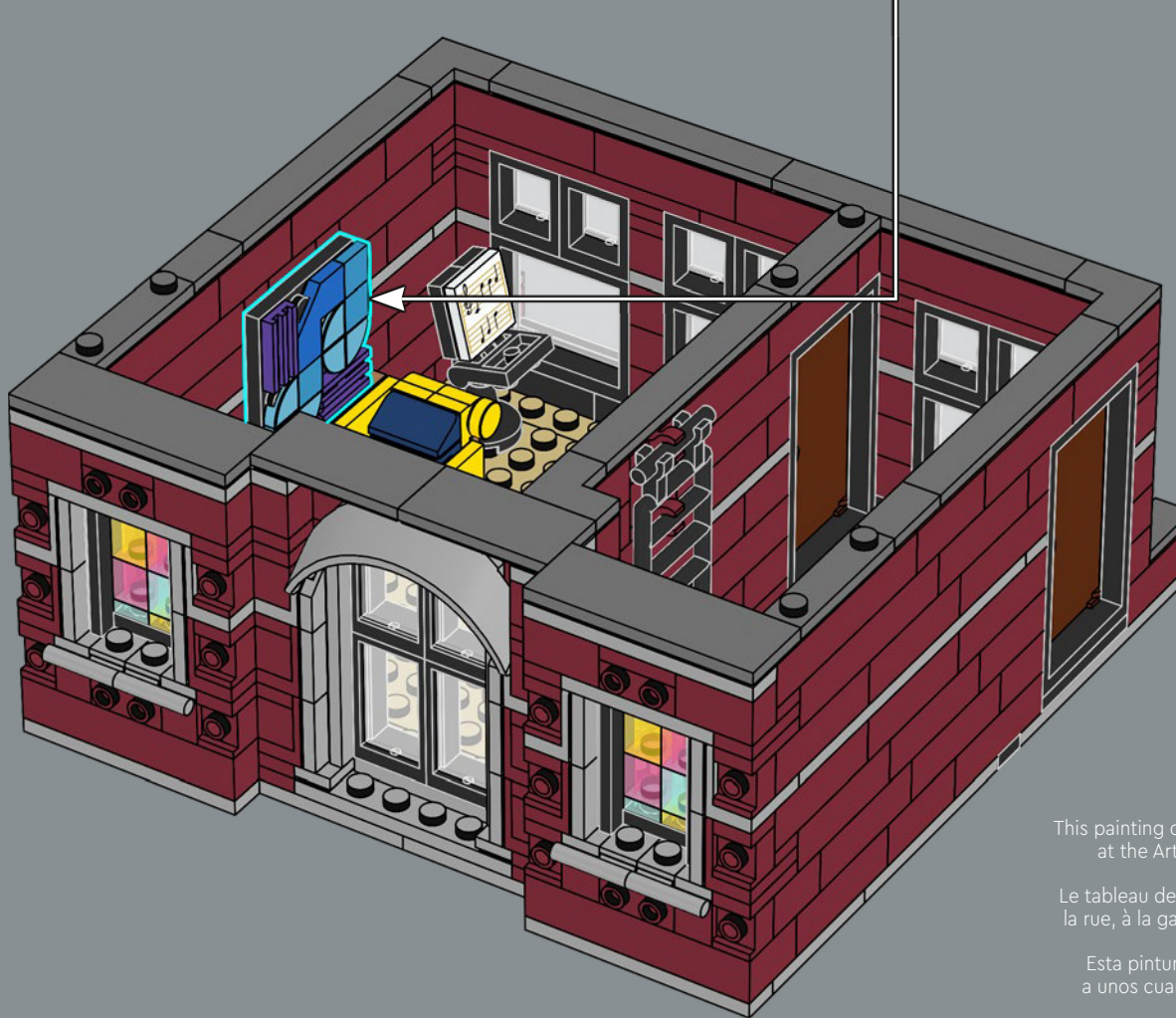
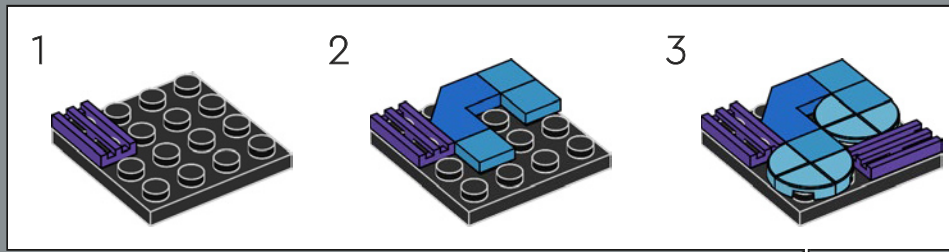

This painting of 'The Blues' was sold just down the street, at the Art Gallery in the LEGO® 10297 Boutique Hotel.

Le tableau de « The Blues » a été acheté juste au bout de la rue, à la galerie d'art de L'hôtel-boutique LEGO® 10297.

Esta pintura, titulada *La nostalgia*, acaba de venderse a unos cuantos pasos de aquí, en la galería de arte del Hotel Boutique LEGO® (10297).

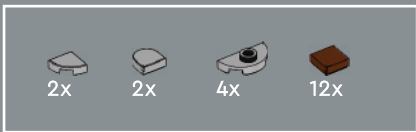

346

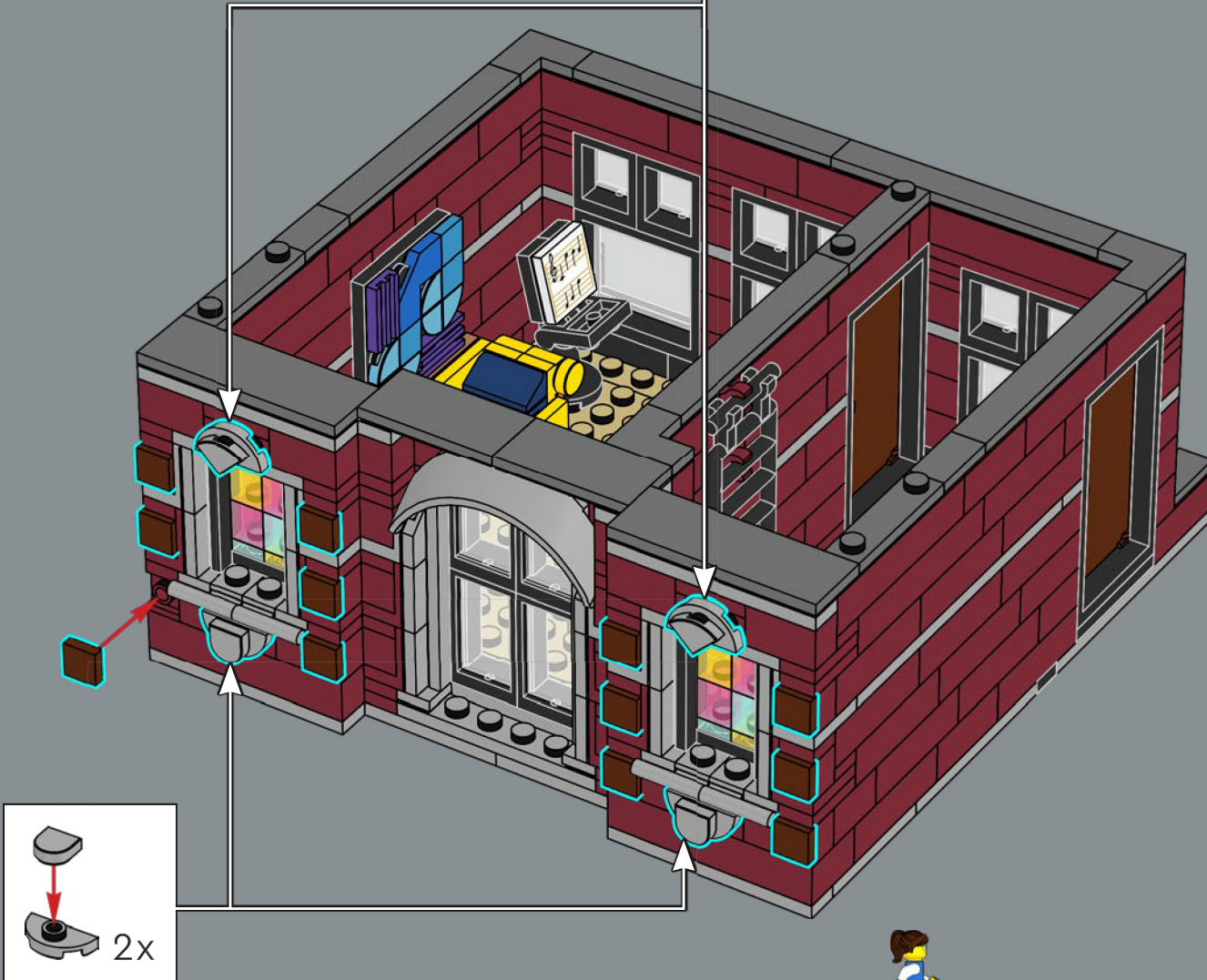
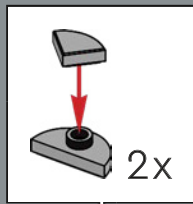

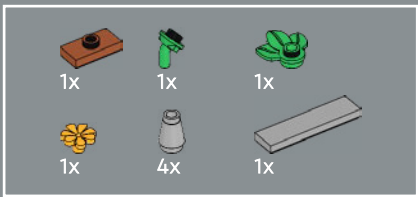

347

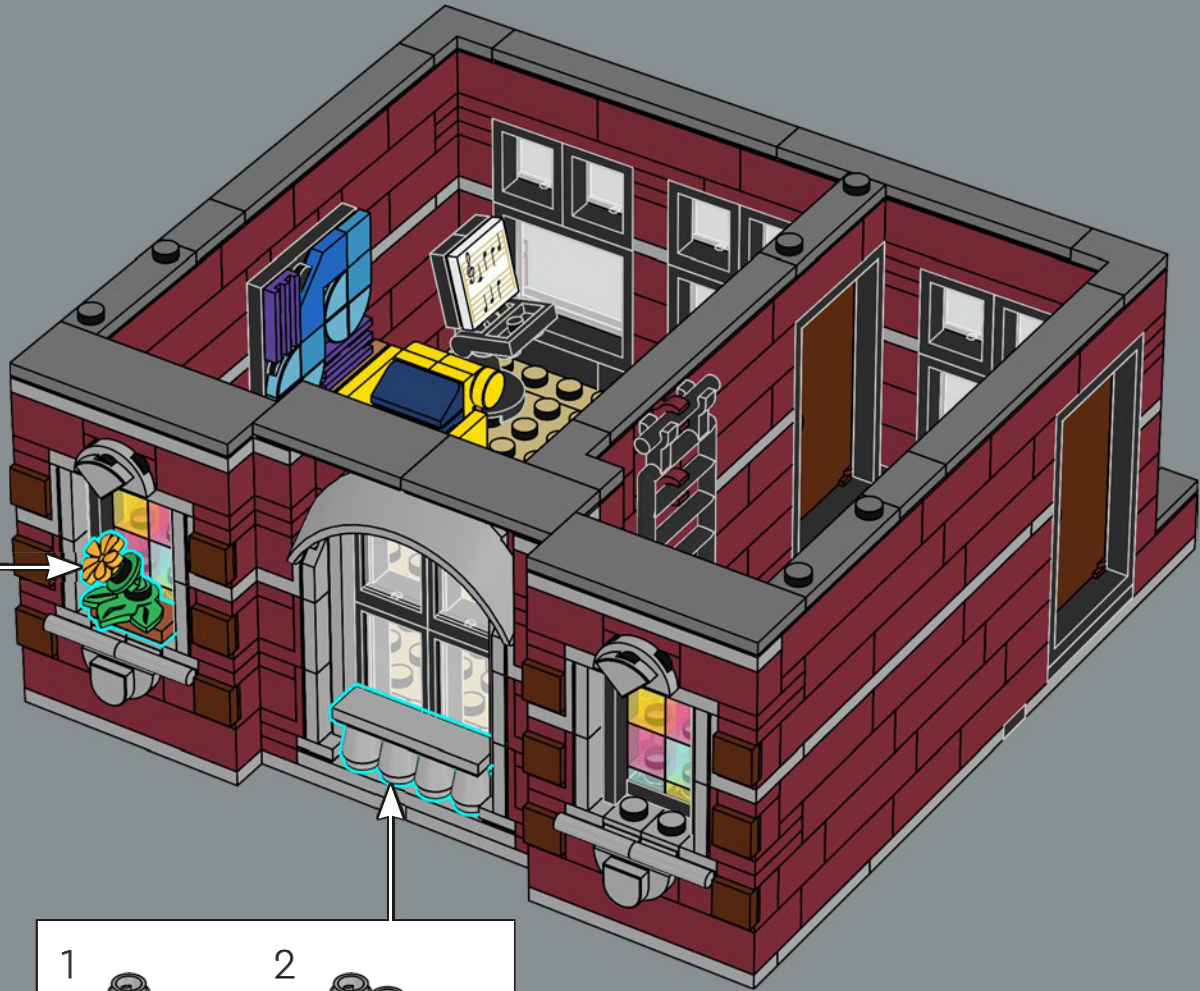
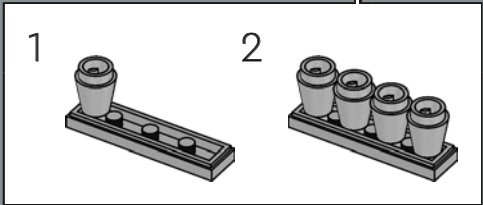
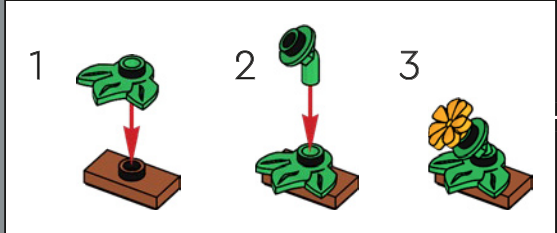

348



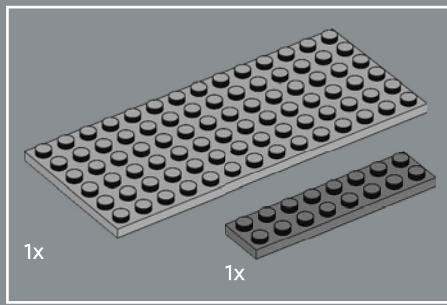

349

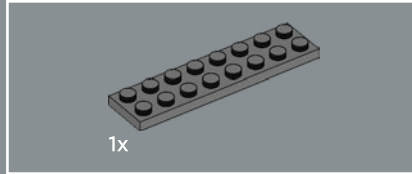
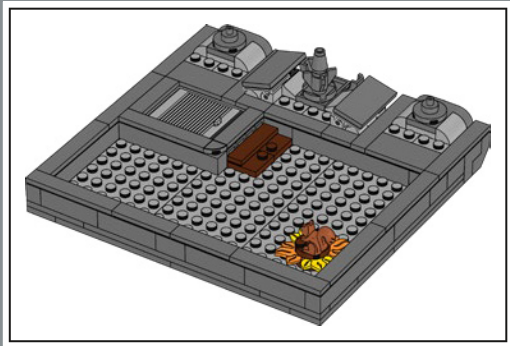
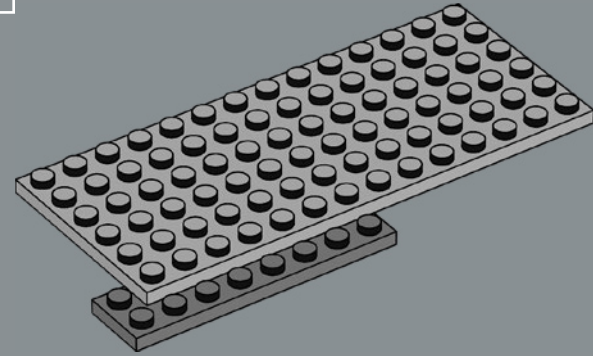

350

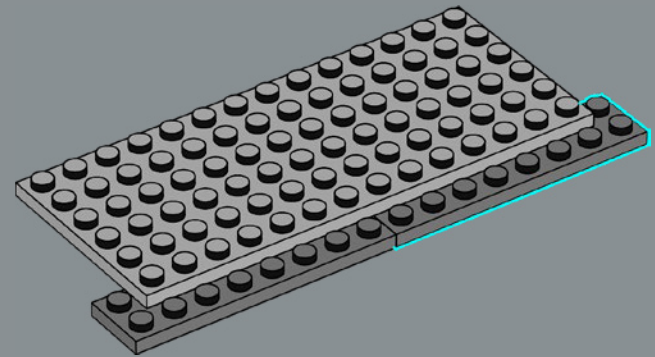

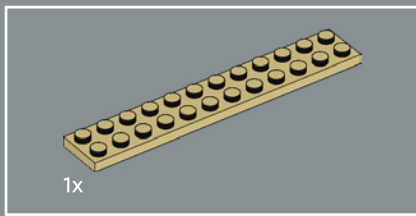

351

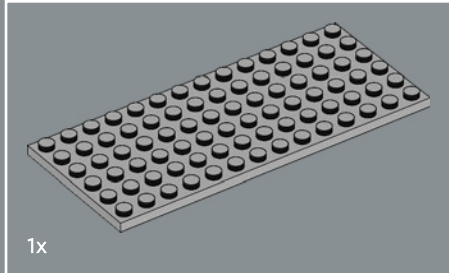
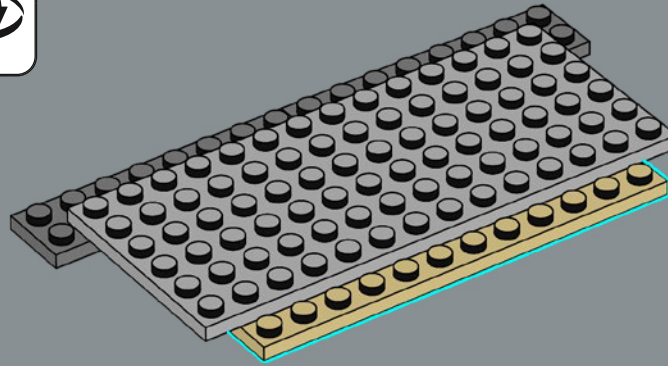

352

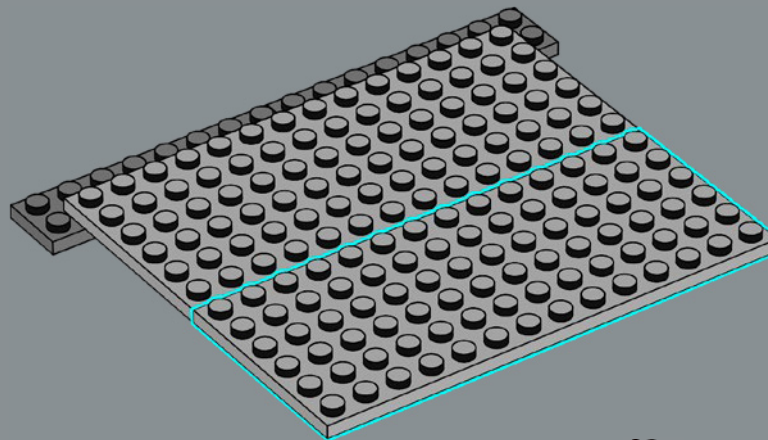

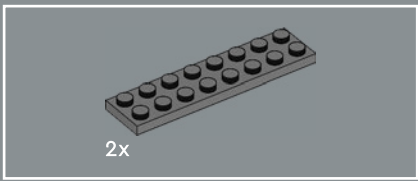

353

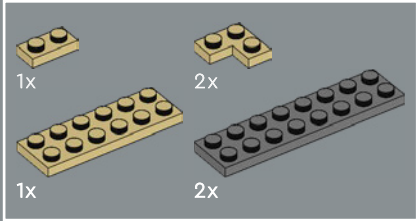
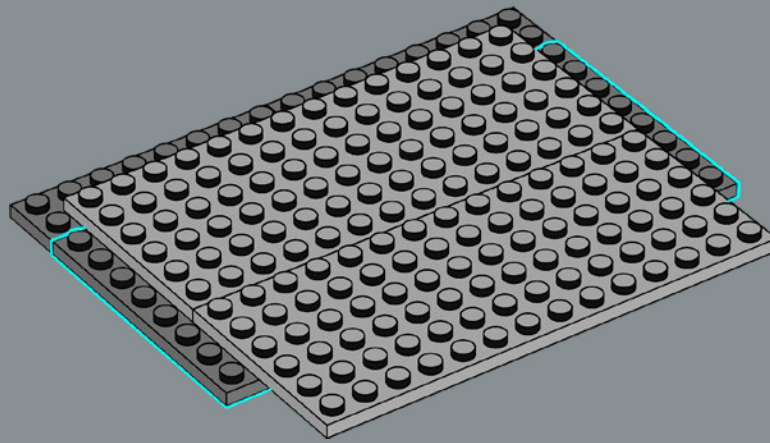

354

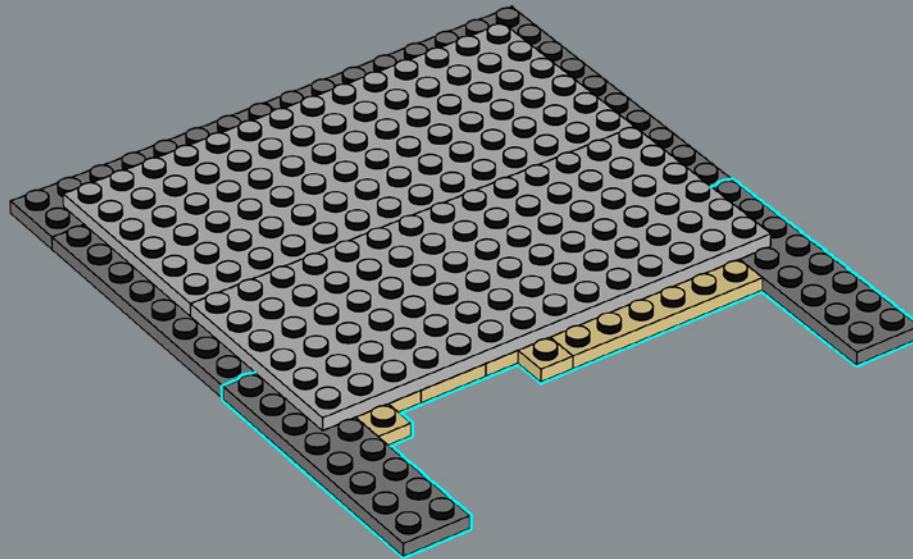

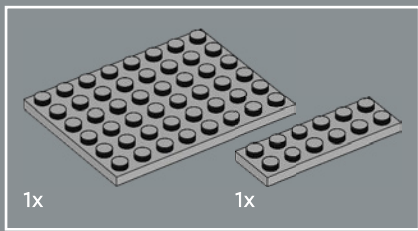

355

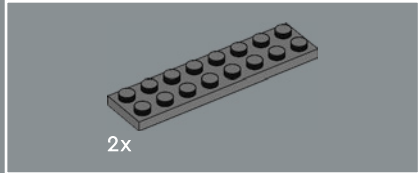
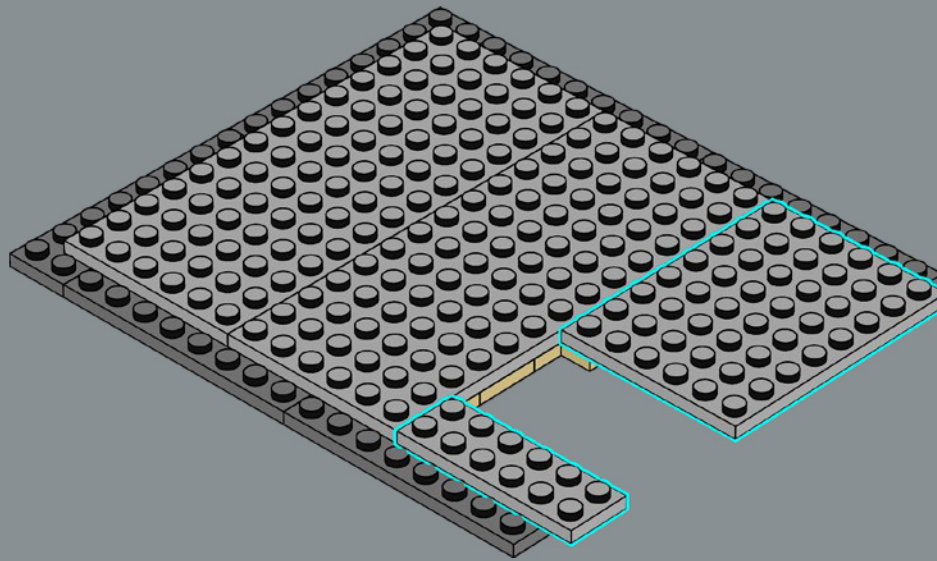

356

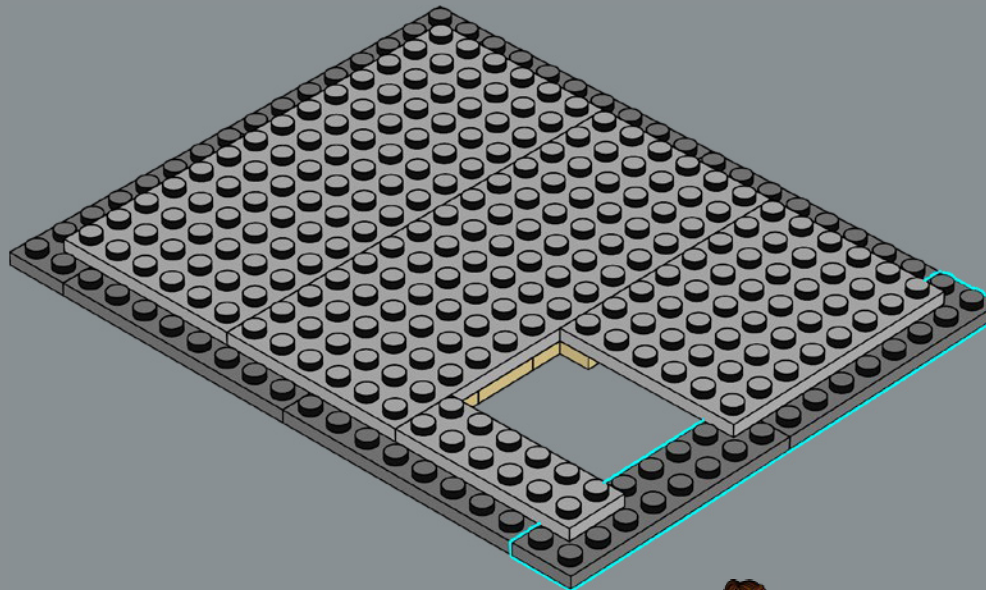

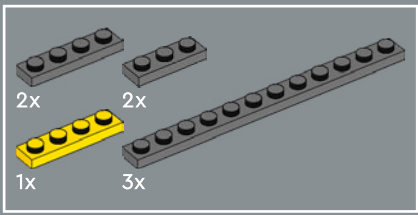

357

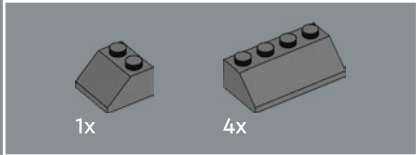
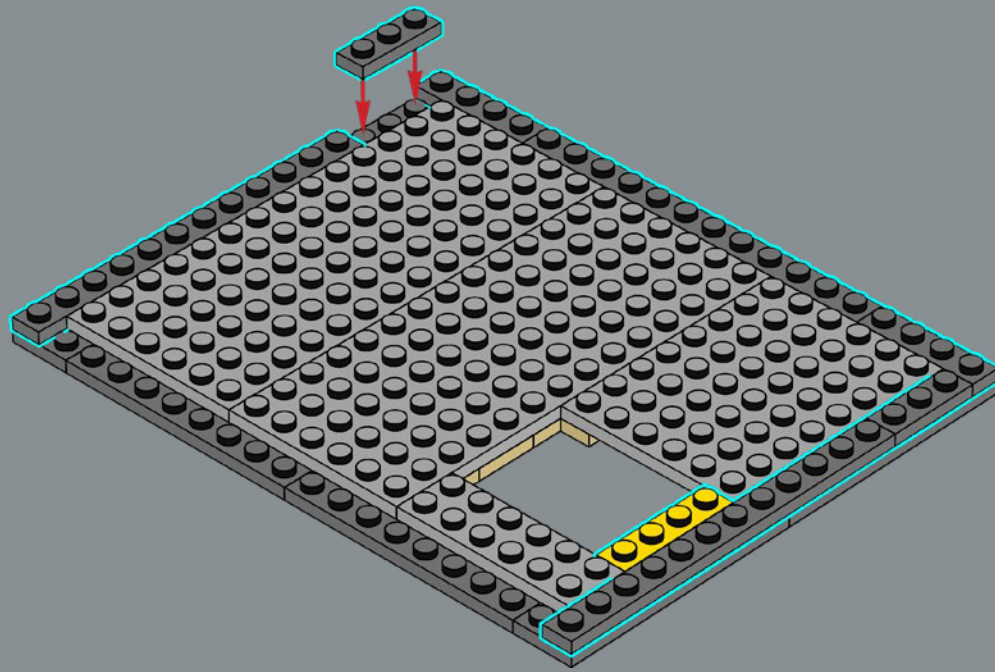

358

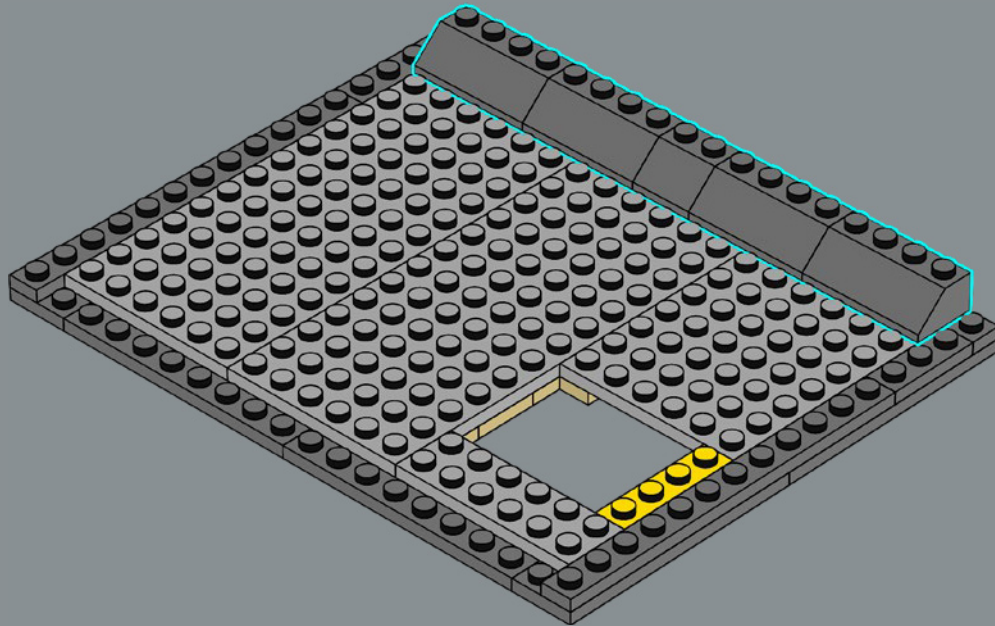

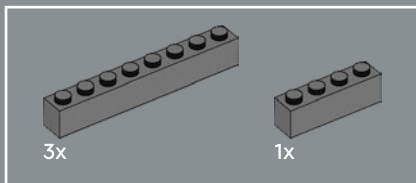

359

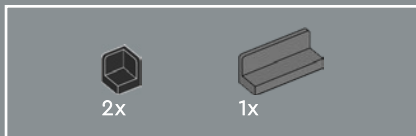
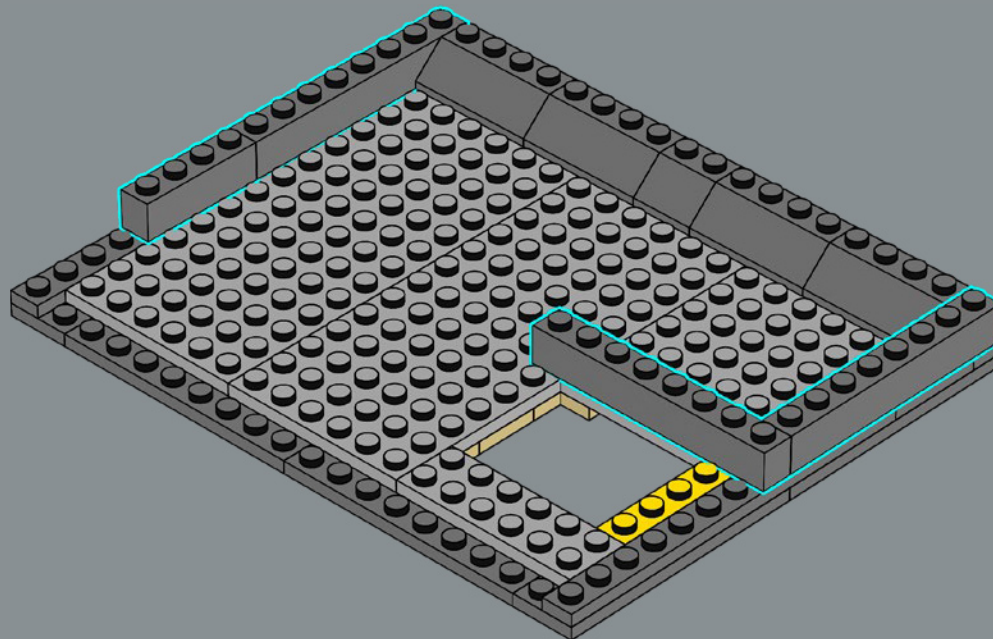

360

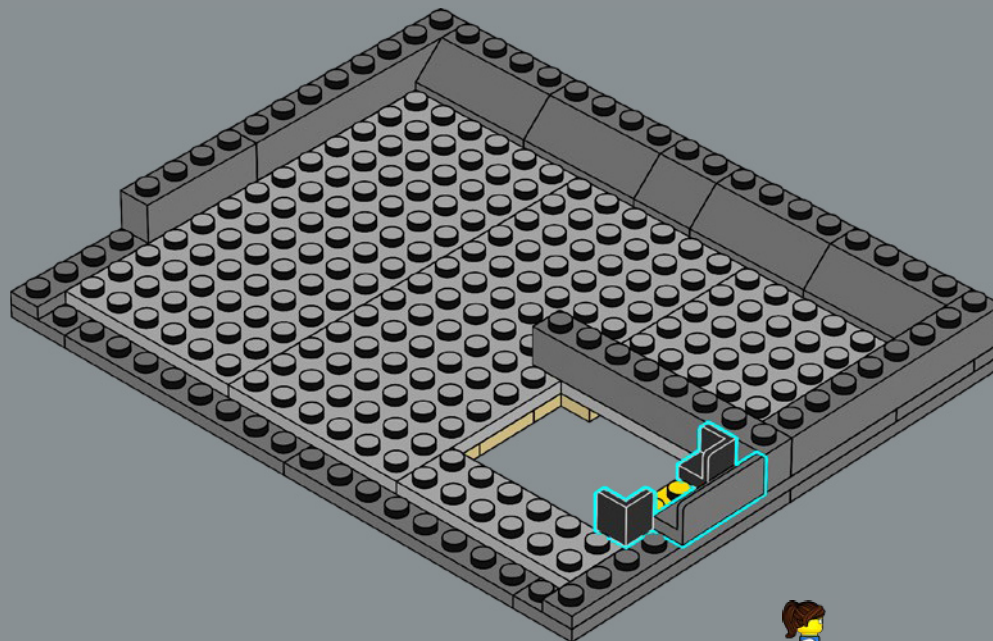

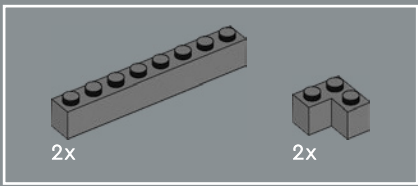

361

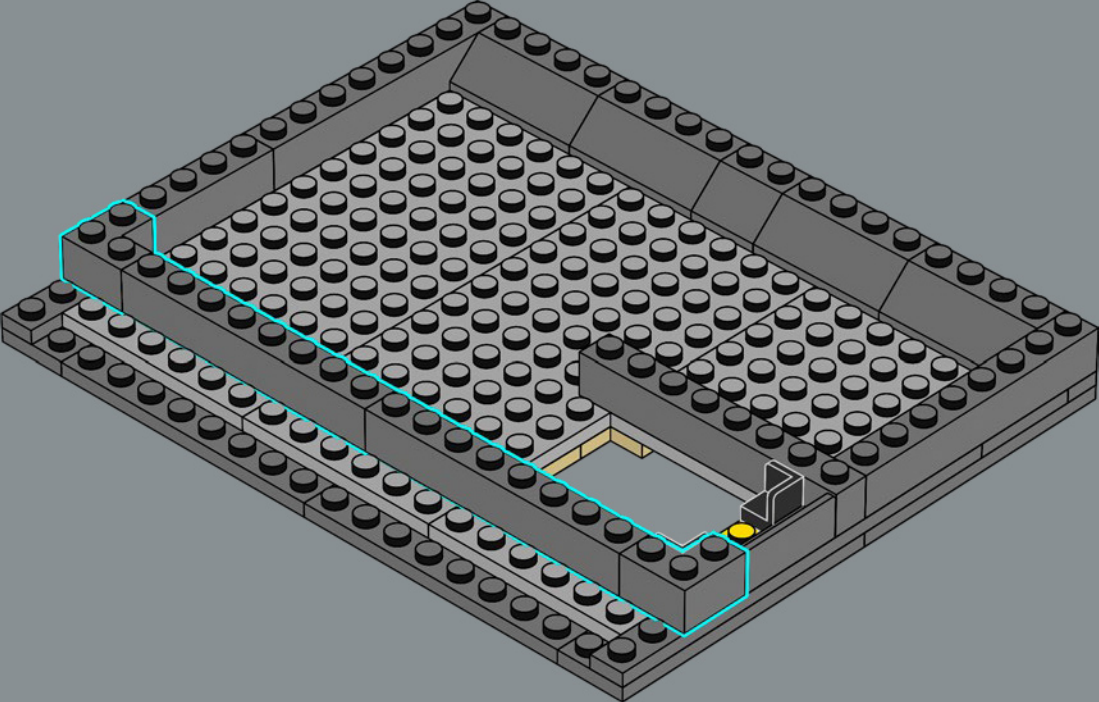

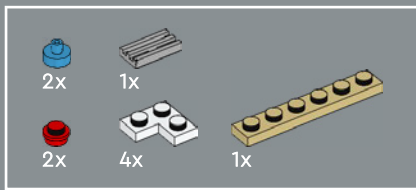

362

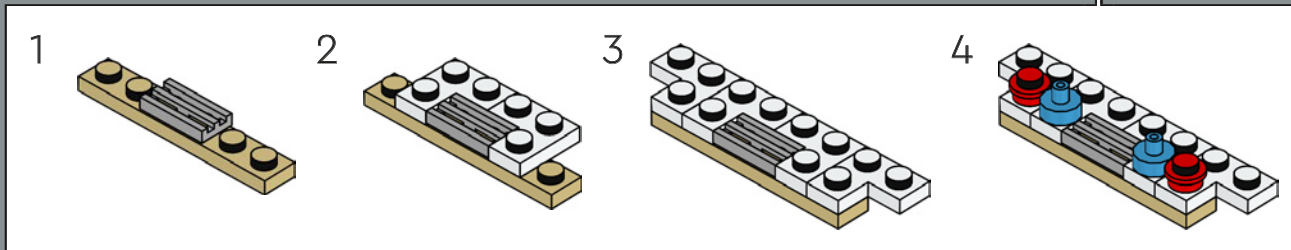
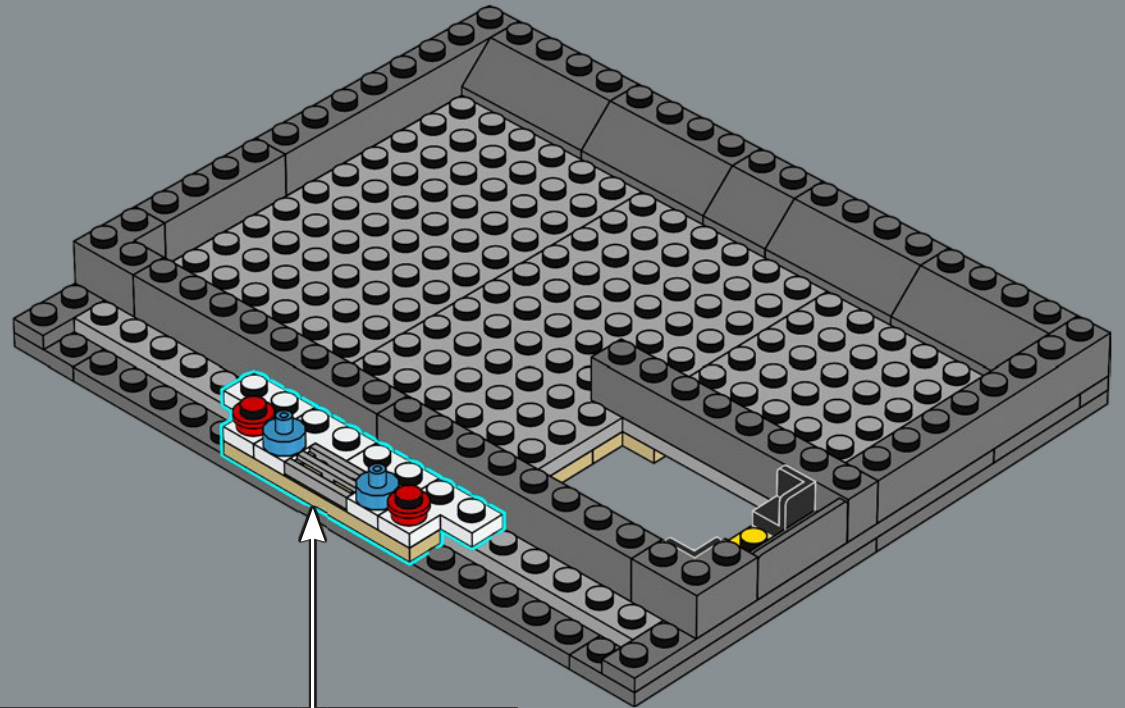

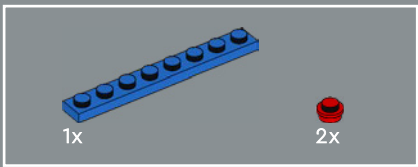

363

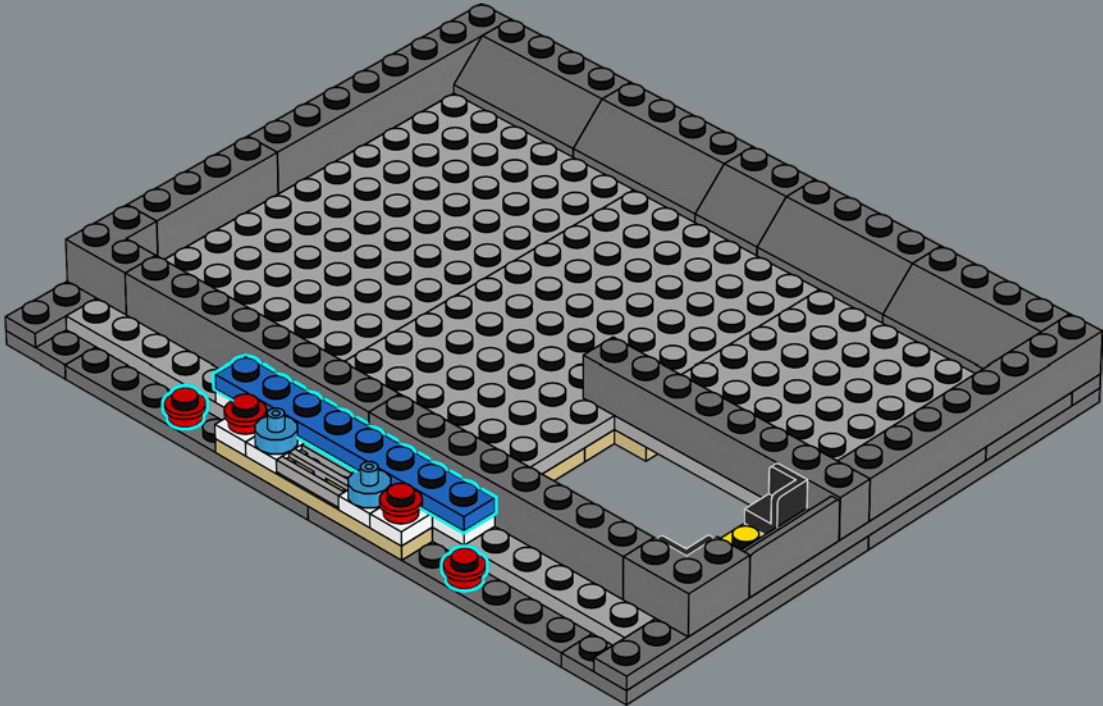

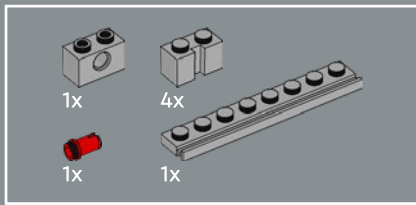

364

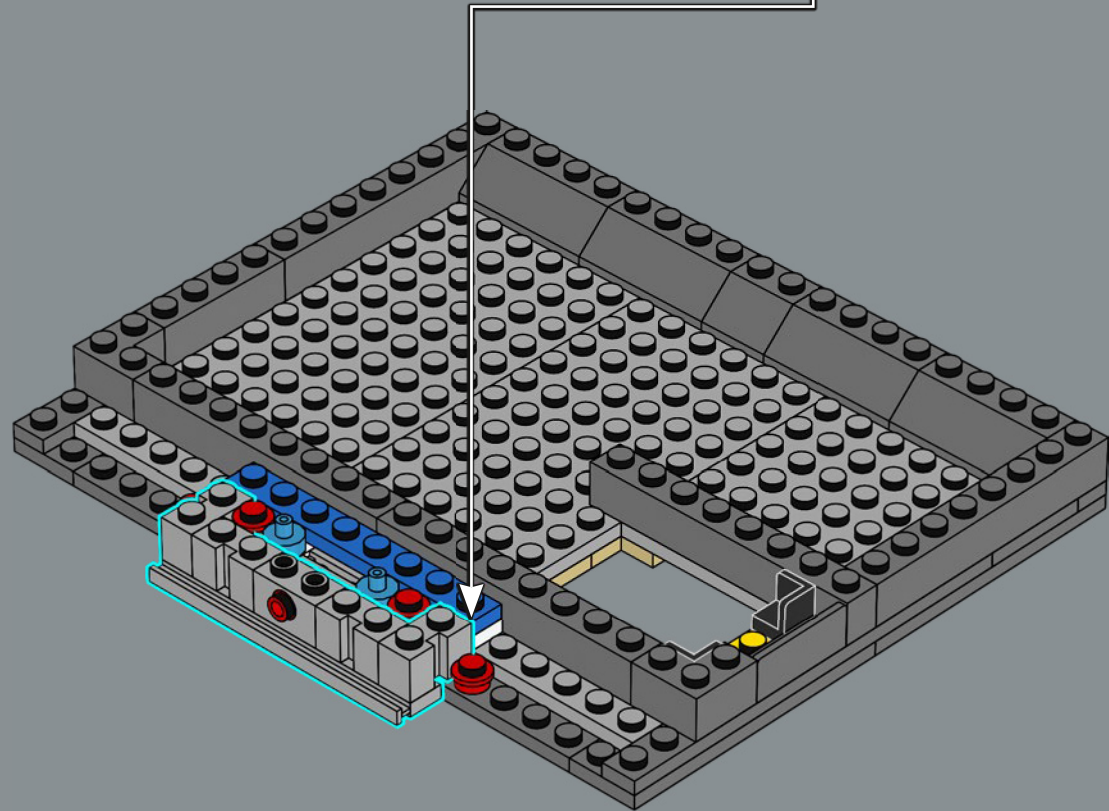
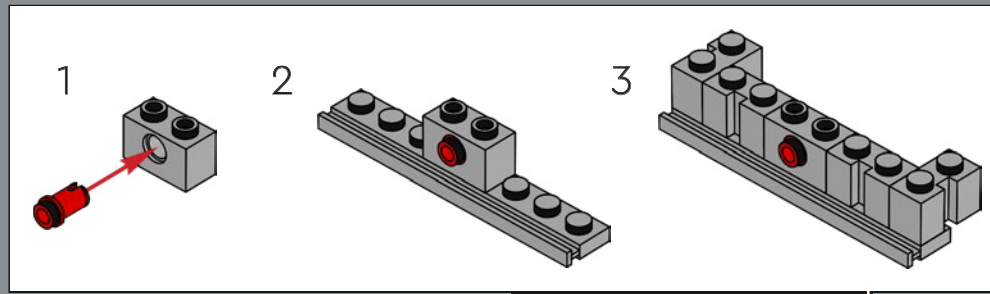

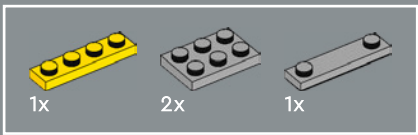

365

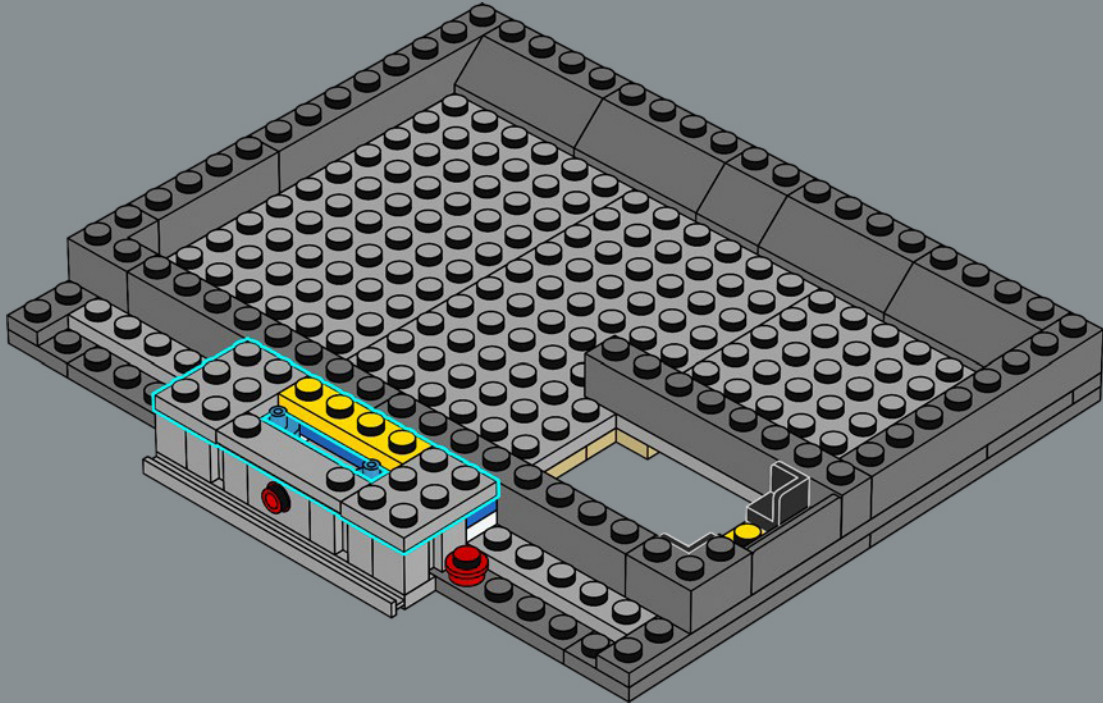

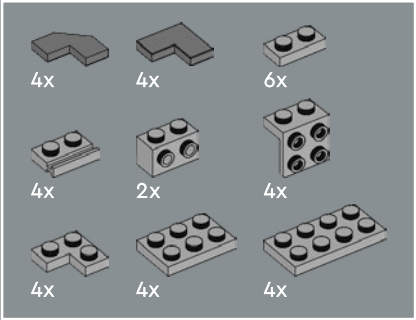
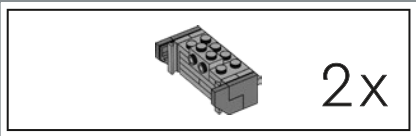

366

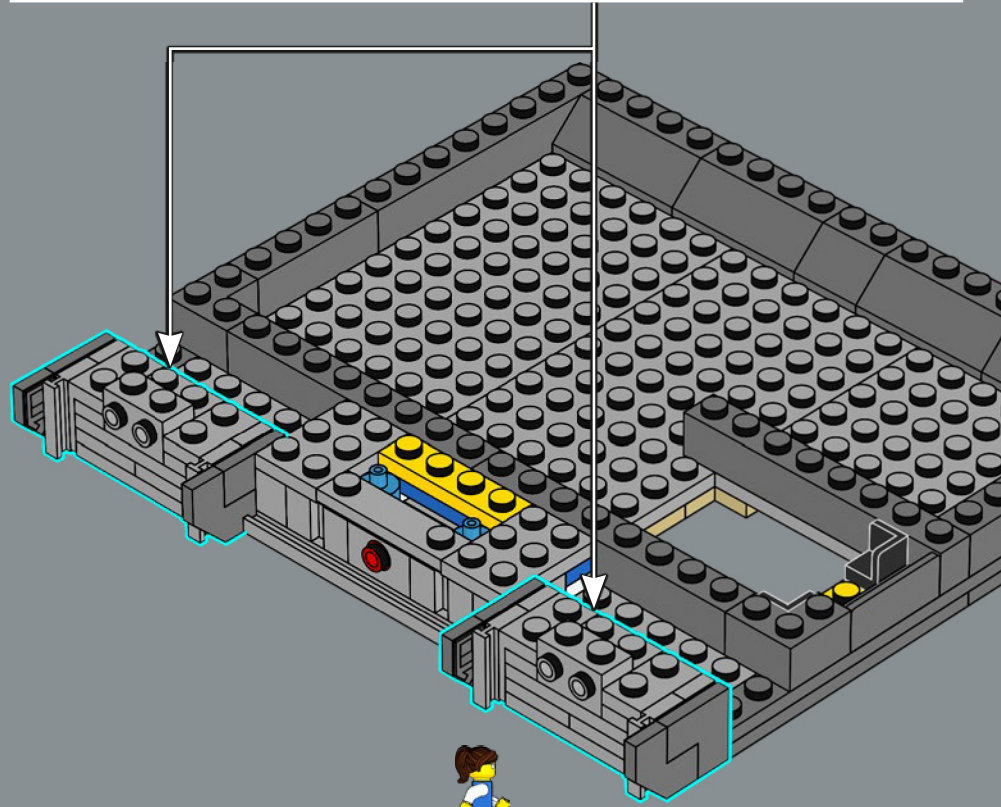
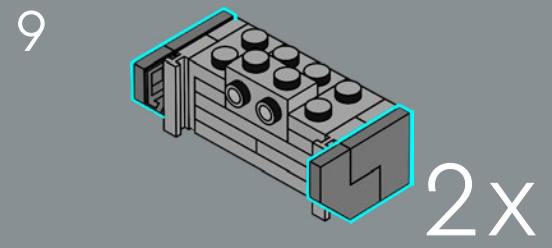
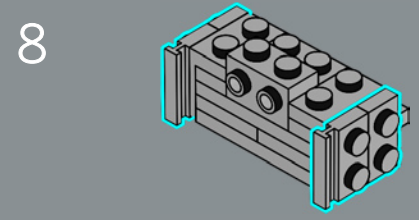
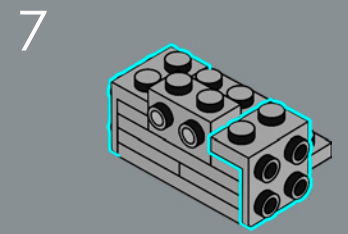
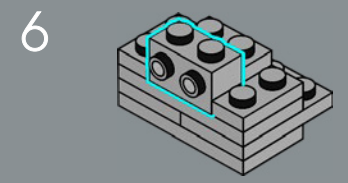
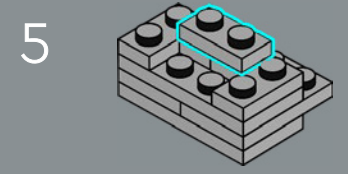
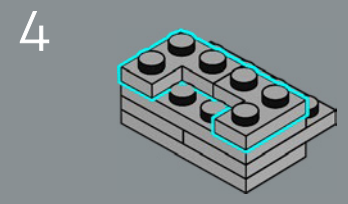
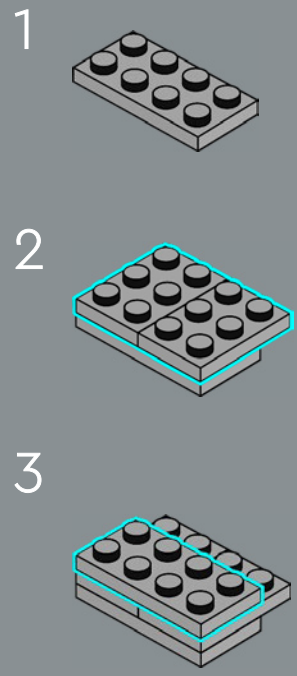

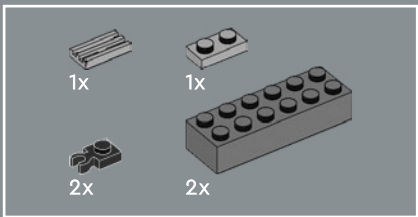

367

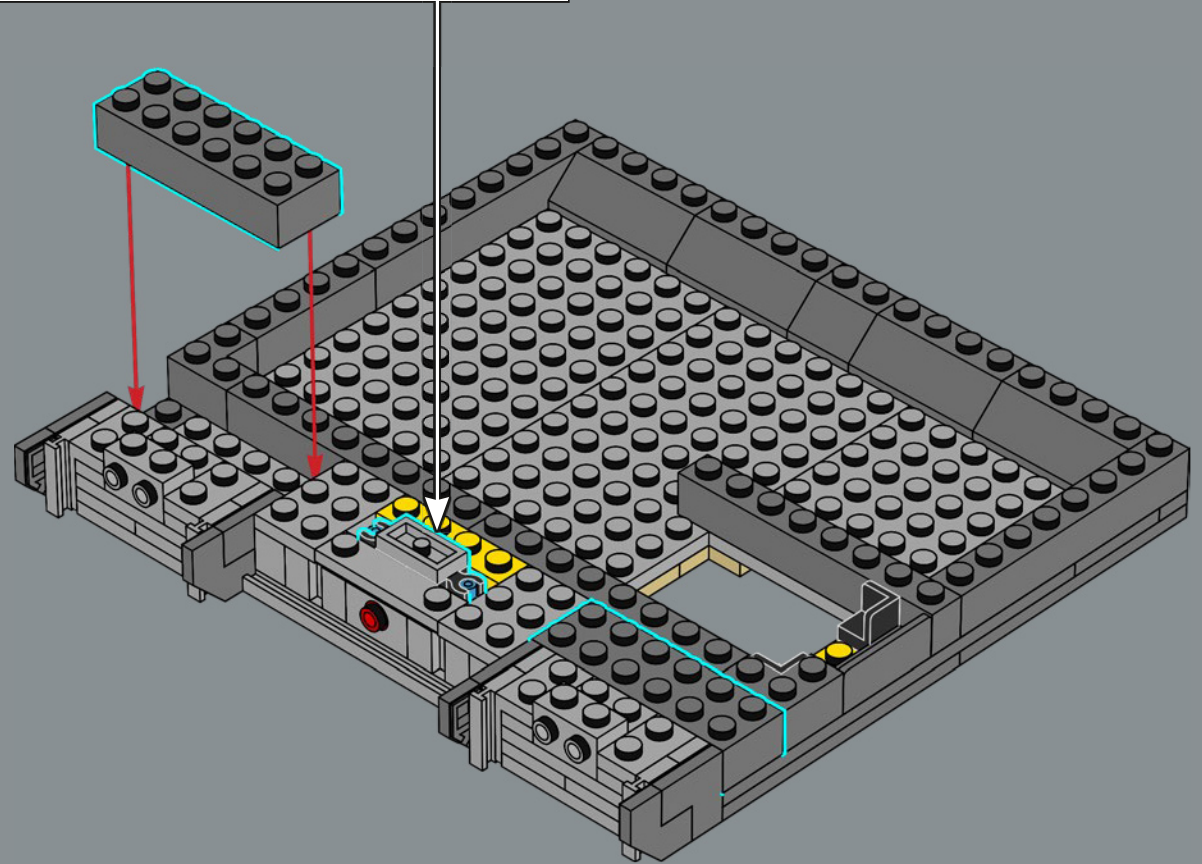
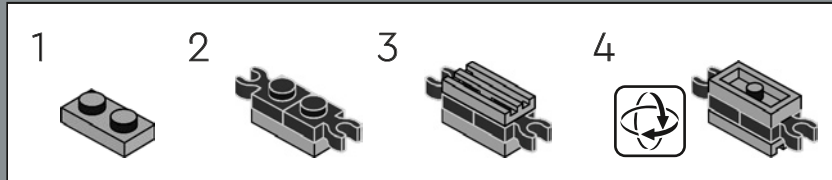

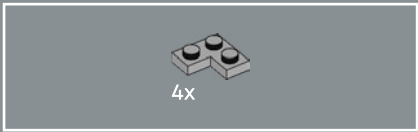

368

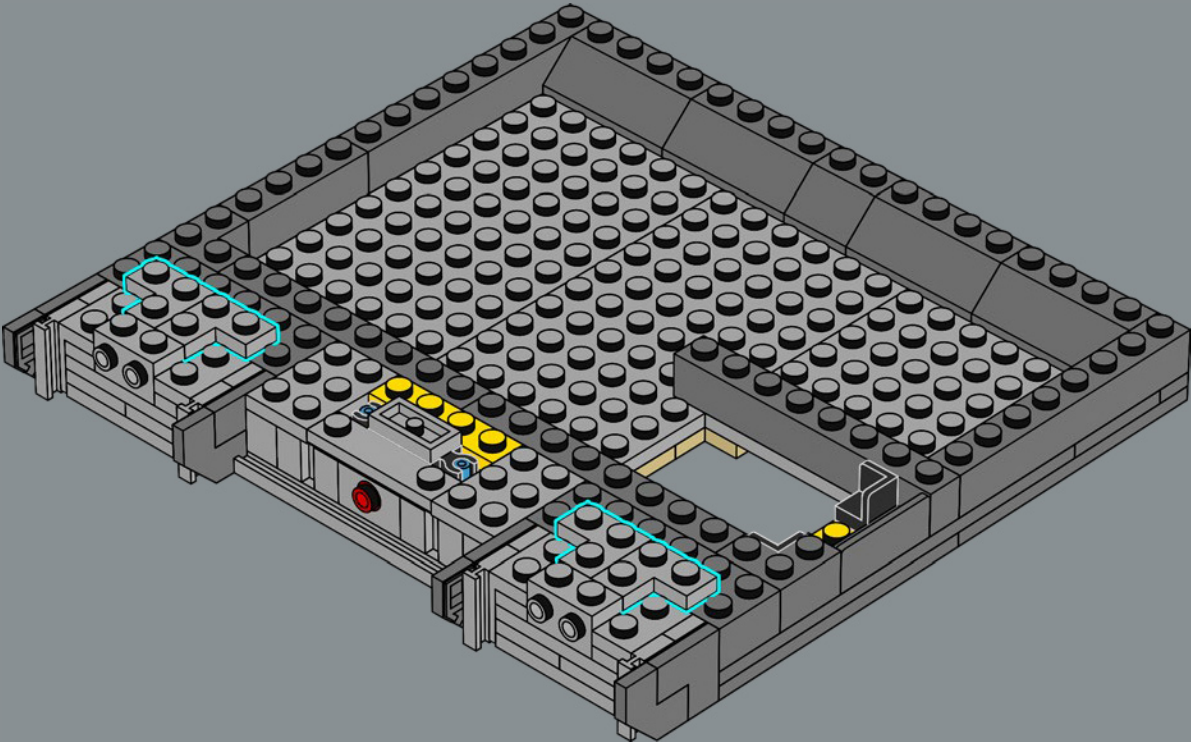

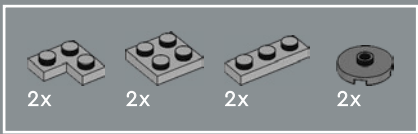

369

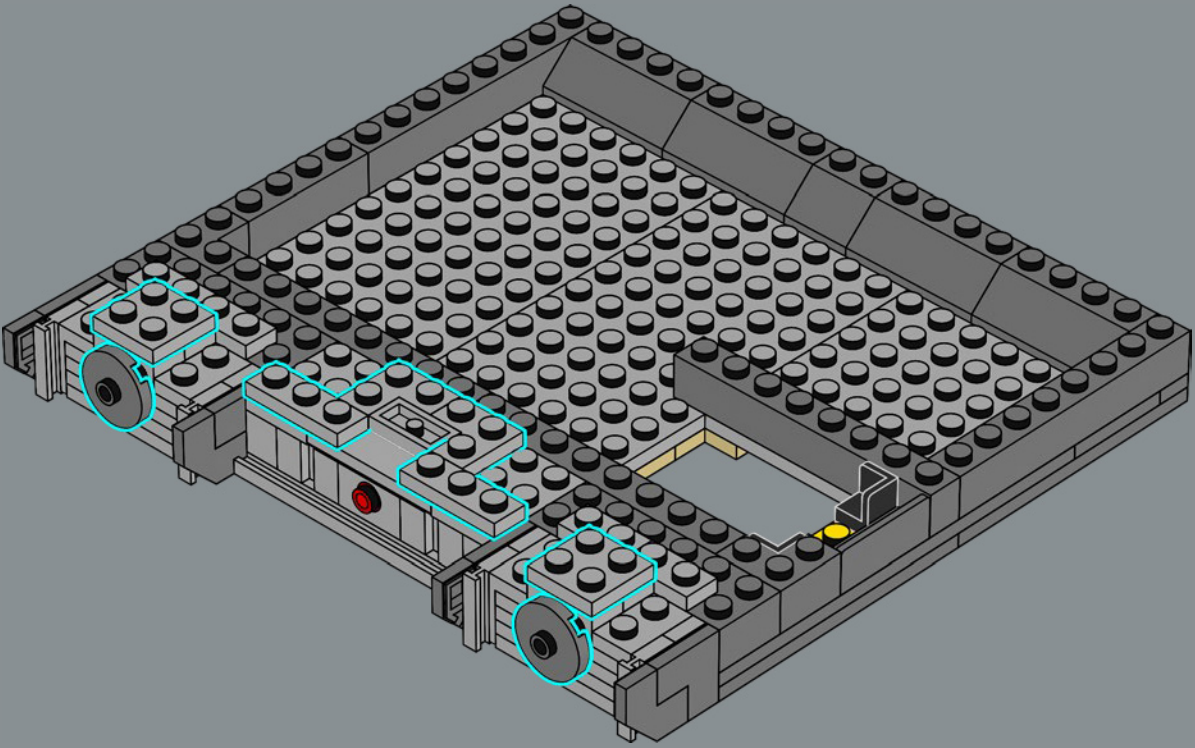



370

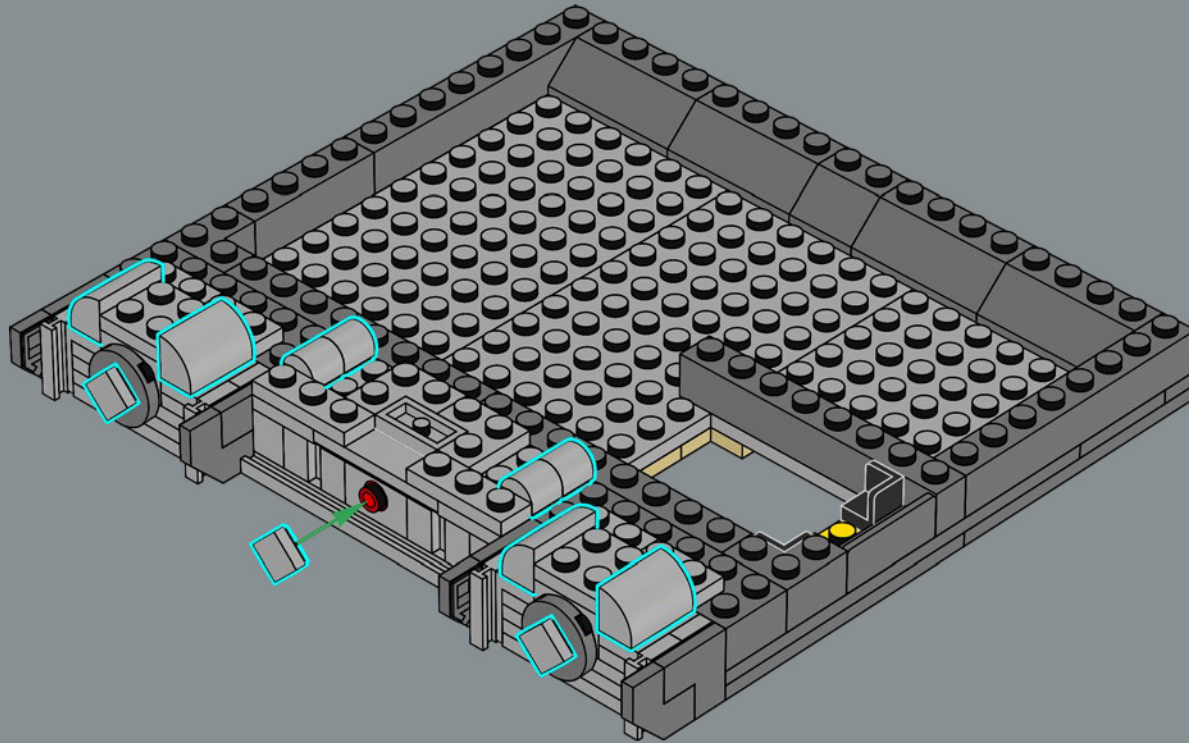

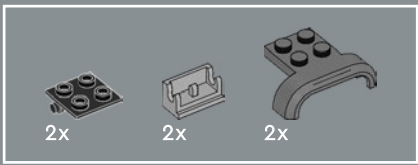

371

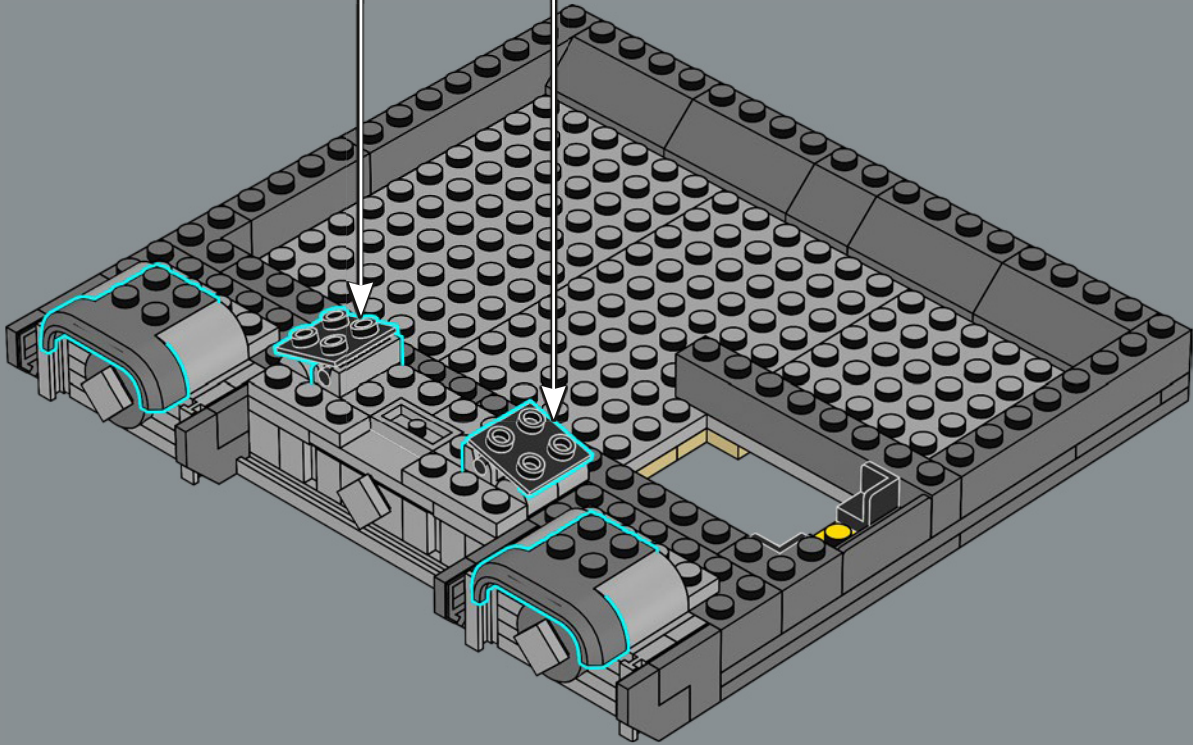
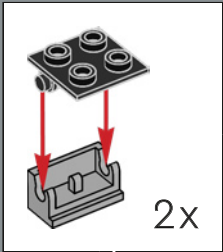

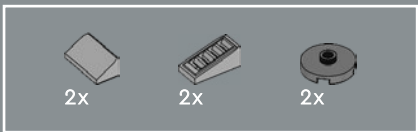

372

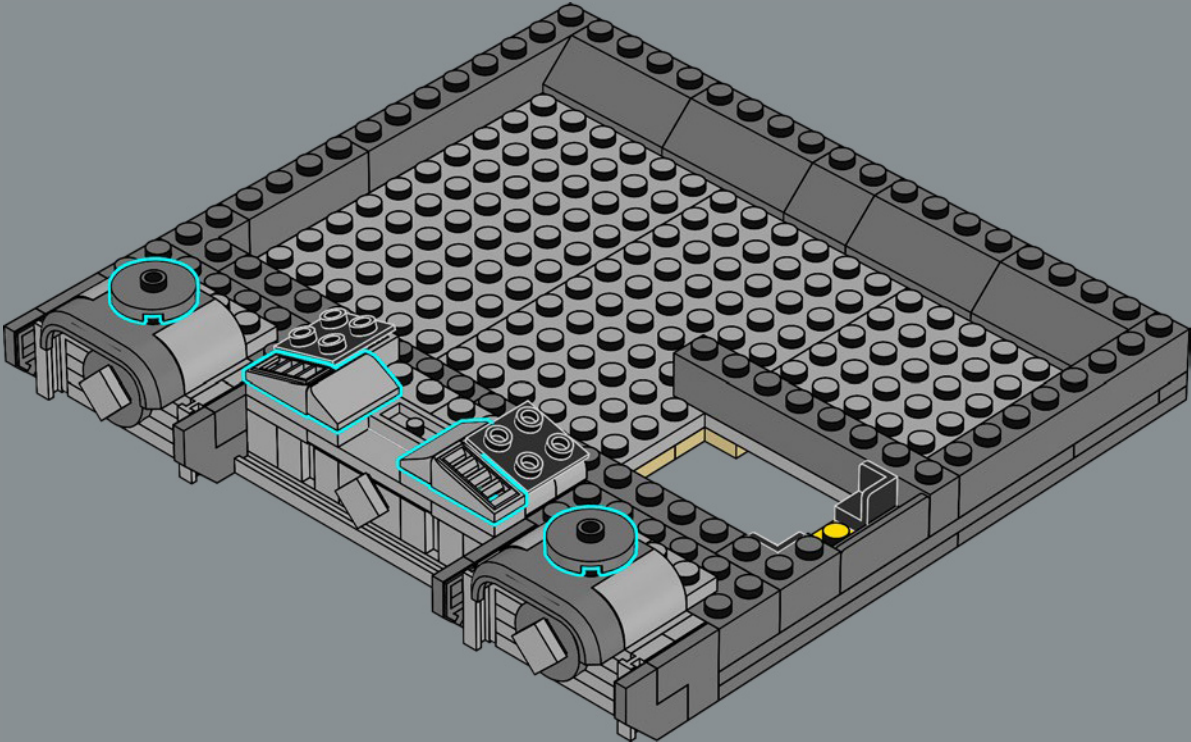

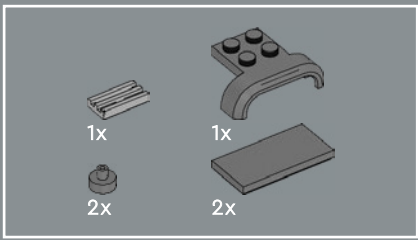

373

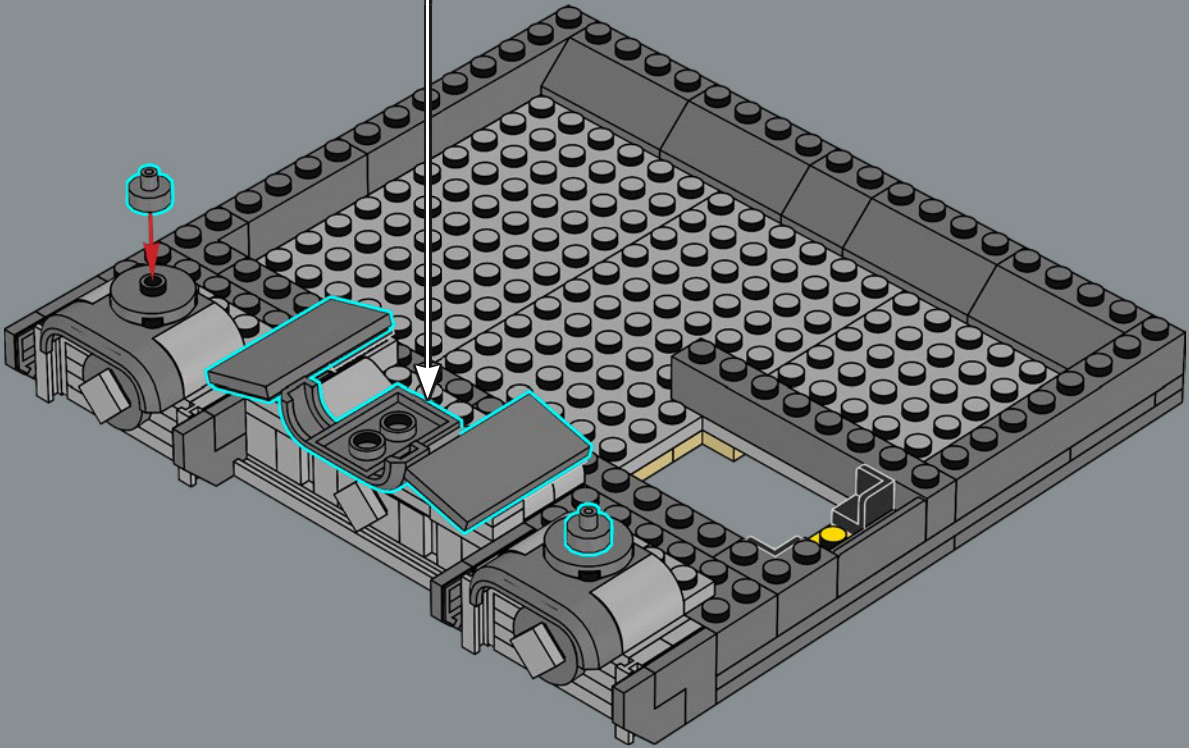
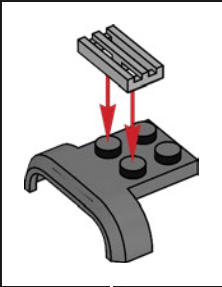



374

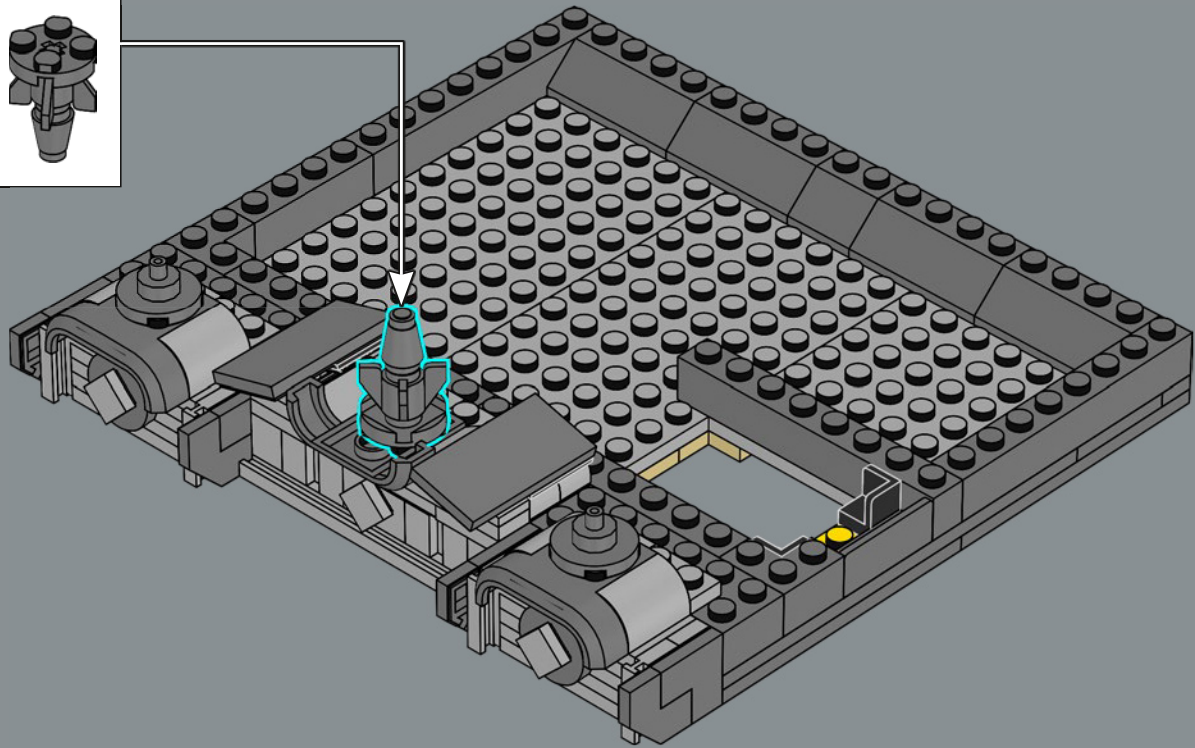
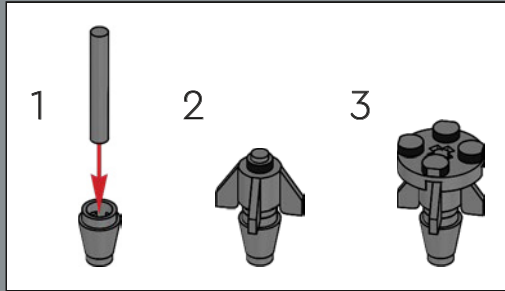

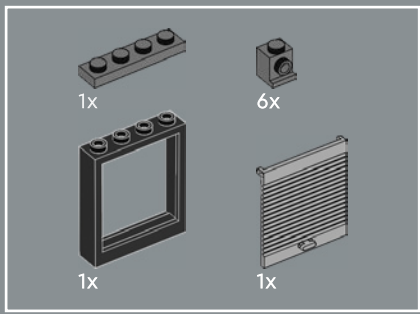

375

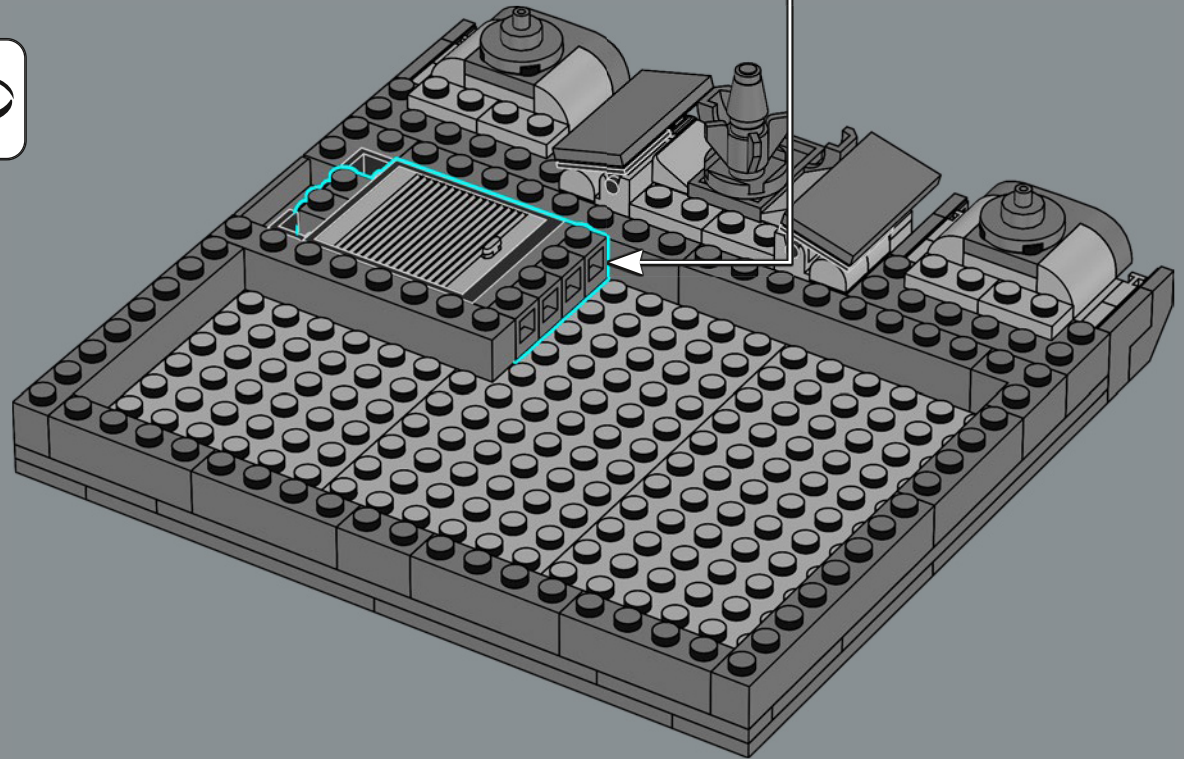
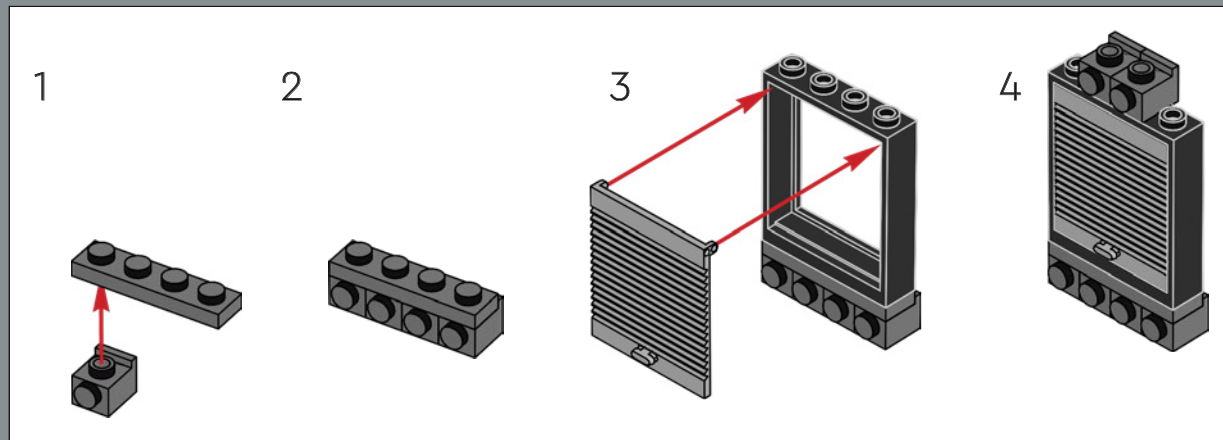

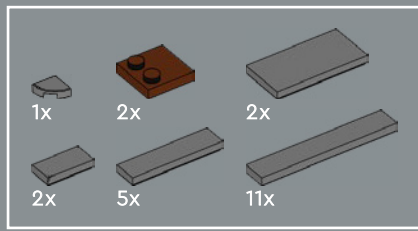

376

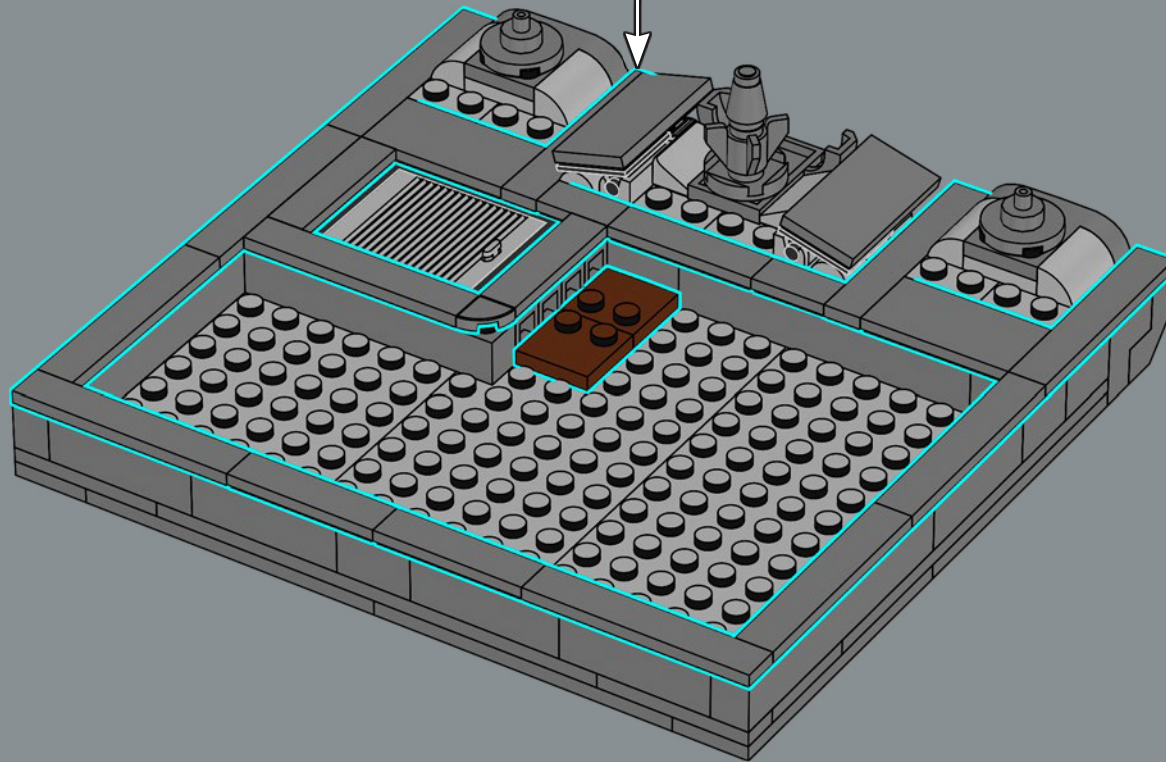
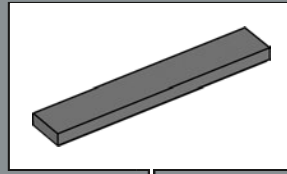

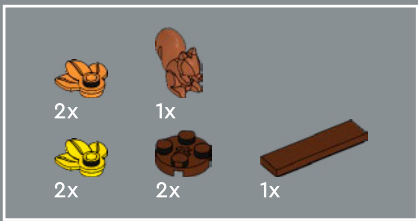

377

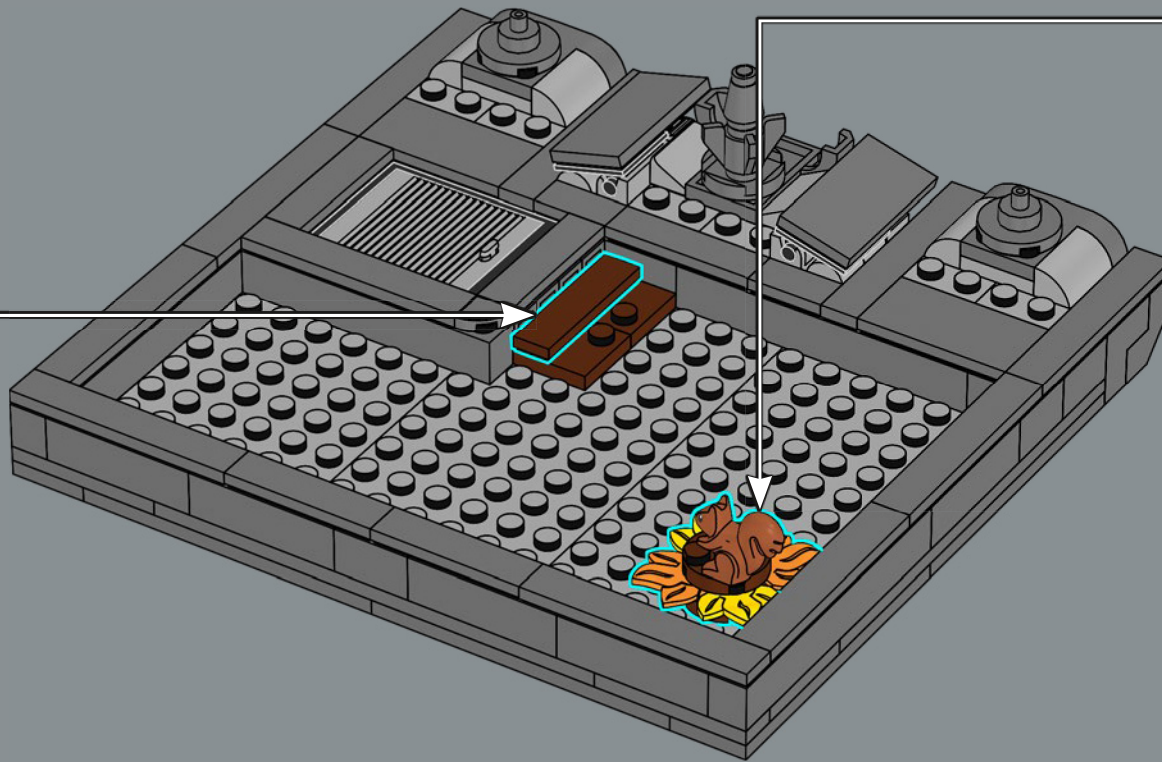
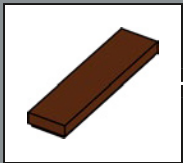
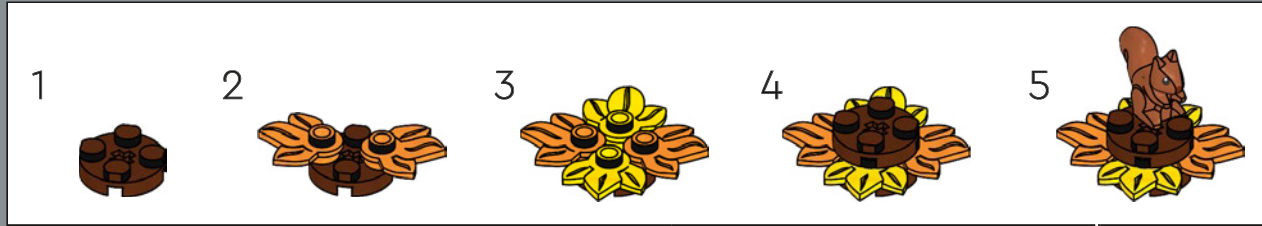



378



Watch out for the mischievous squirrel! If you stop for a slice of pizza, you might just find it disappears from your hands and ends up on the roof!

Attention à l'écureuil espiègle ! Si vous faites une pause pour manger une pointe de pizza, il est possible qu'elle se volatilise et finisse sur le toit !

¡No pierdas de vista a la traviesa ardilla! Si te detienes a comer una deliciosa rebanada de pizza, ¡podrías verla desaparecer en tus manos y terminar en la azotea!



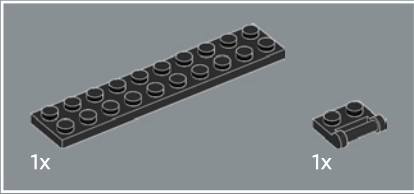

379

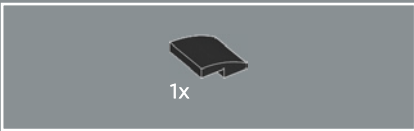
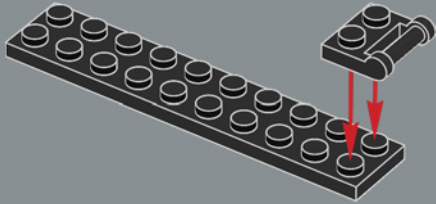

380

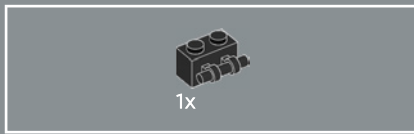
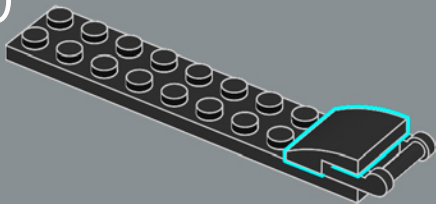

381

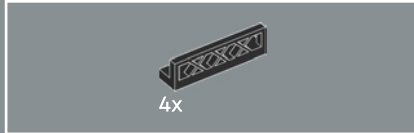
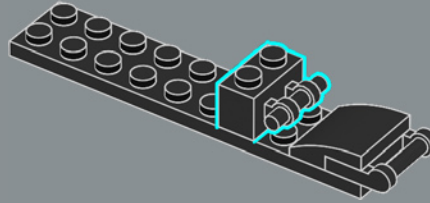

382

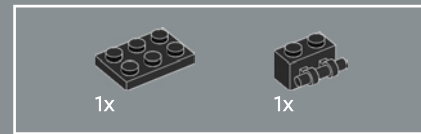
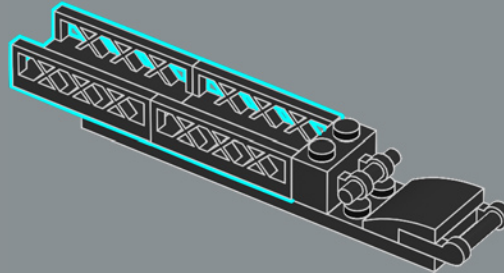

383

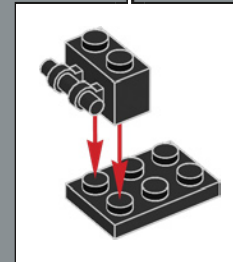
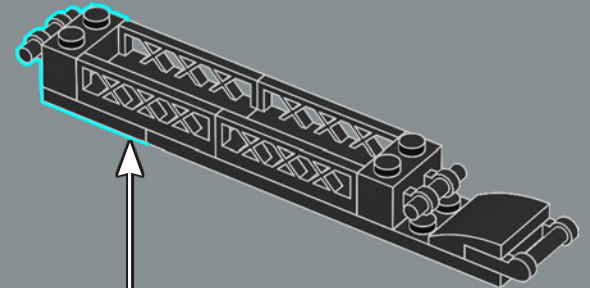

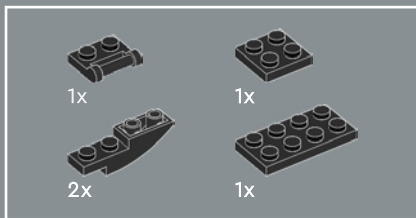

384

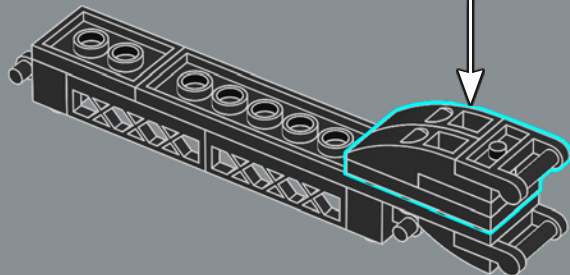
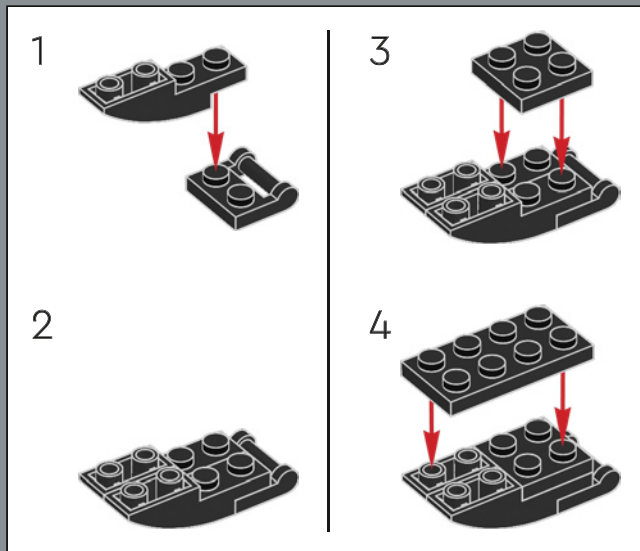

385

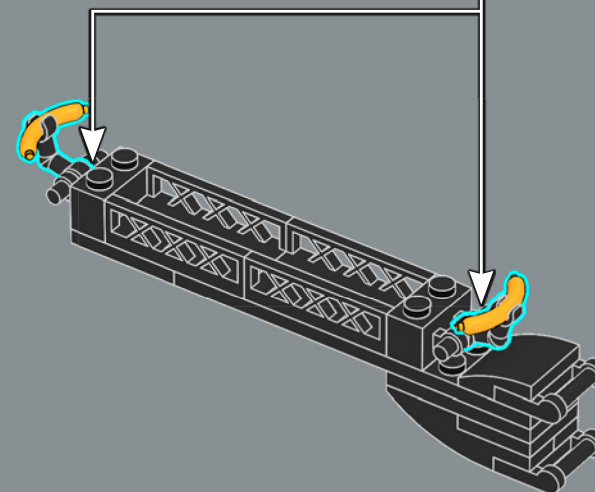
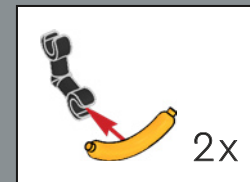

The LEGO® sausage has proven to be an incredibly useful element. It has appeared in 9 colors in dozens of LEGO sets.

La saucisse LEGO® s'est avérée être un élément incroyablement utile. Elle est apparue en 9 couleurs dans des dizaines d'ensembles LEGO.

La salchicha LEGO® ha demostrado ser un elemento increíblemente útil. Ha aparecido en 9 colores en decenas de sets LEGO.



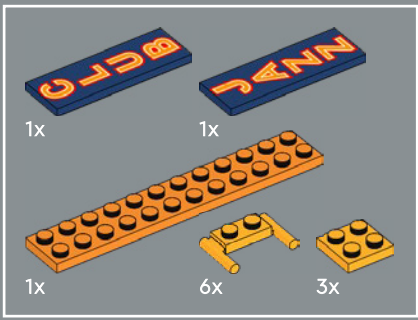

386

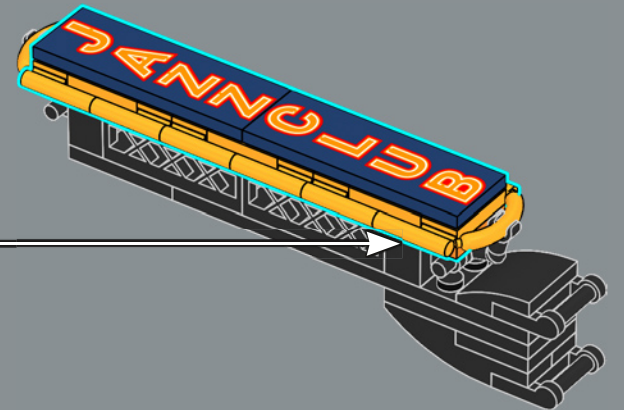
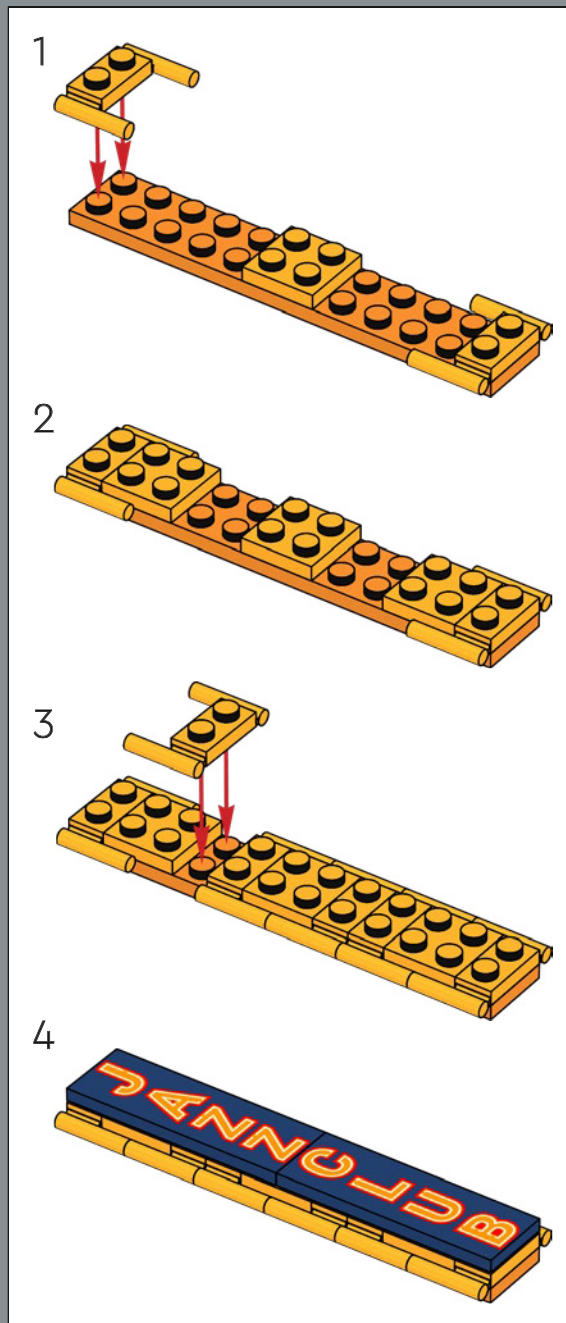

387

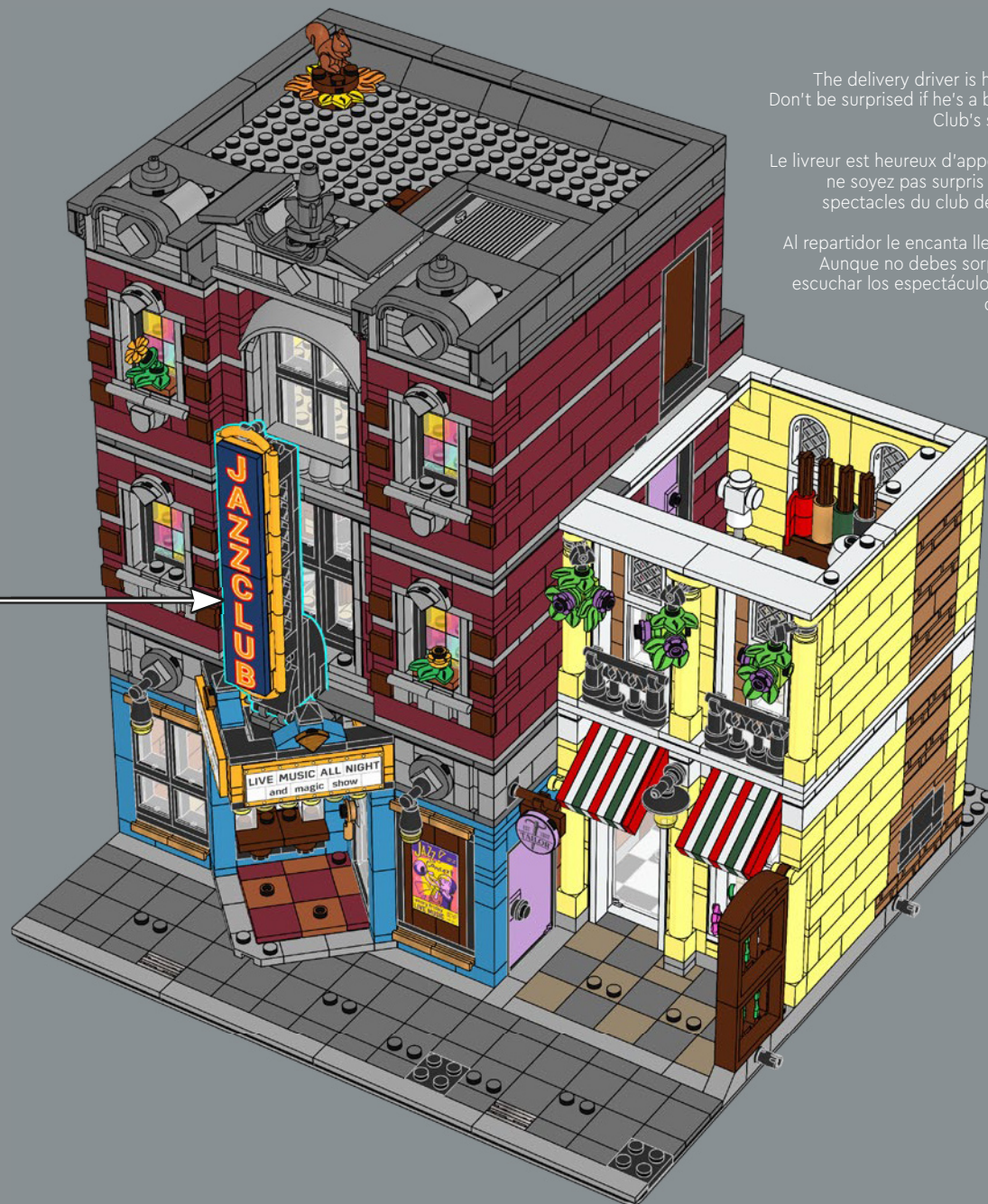

The delivery driver is happy to bring pizza anywhere around town. Don't be surprised if he's a bit late, though. He loves to listen to the Jazz Club's shows, and it can be hard to drag him away.

Le livreur est heureux d'apporter des pizzas partout en ville. Cependant, ne soyez pas surpris s'il est un peu en retard. Il adore écouter les spectacles du club de jazz, et il peut être difficile de l'en éloigner.

Al repartidor le encanta llevar pizzas a todos los rincones de la ciudad. Aunque no debes sorprenderte si llega un poco tarde. Le encanta escuchar los espectáculos del Club de Jazz, y puede resultar un poco complicado hacer que se aleje de este lugar.



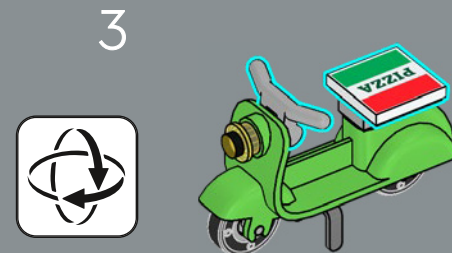
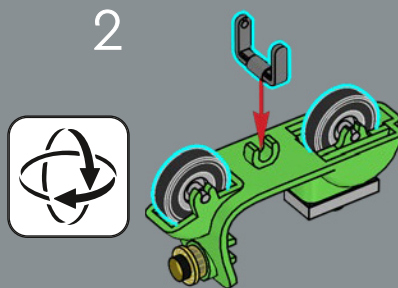
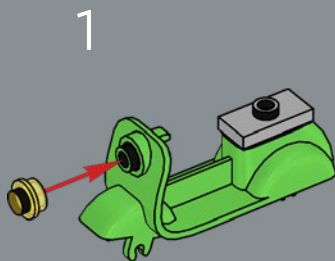
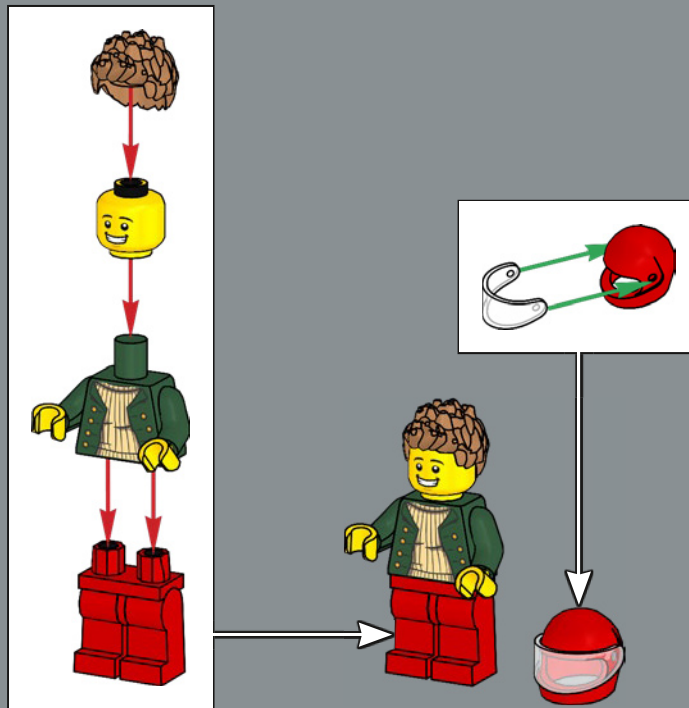

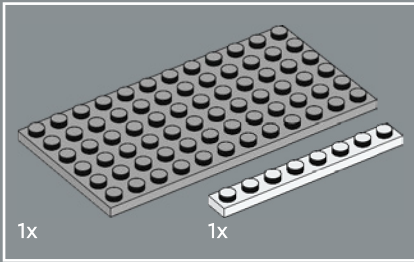
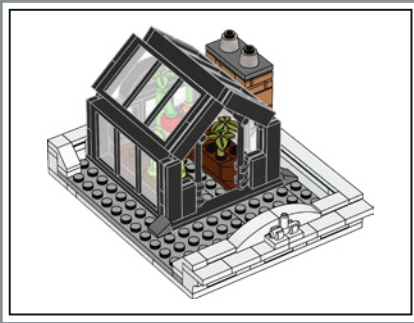

388

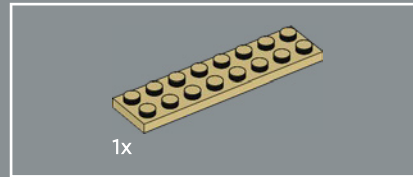
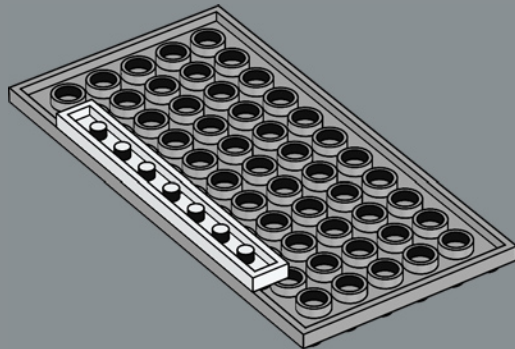

389

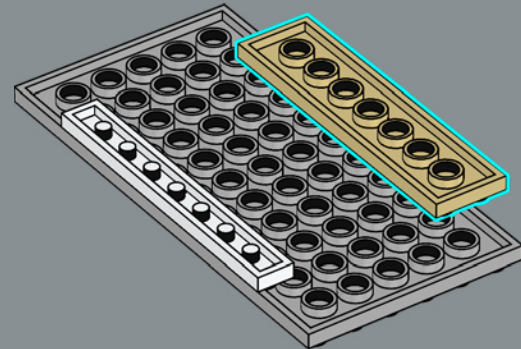

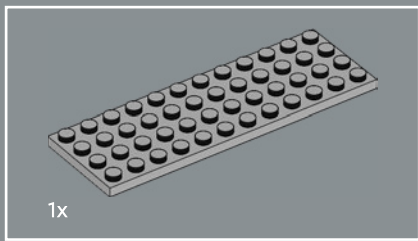

390

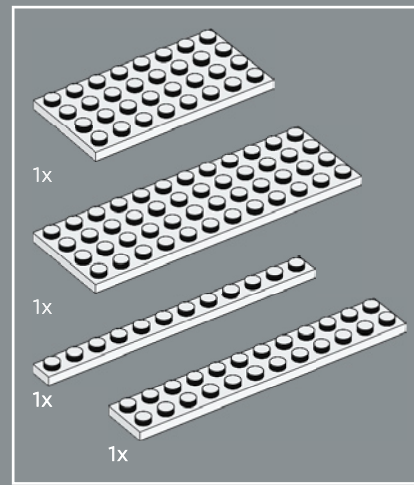
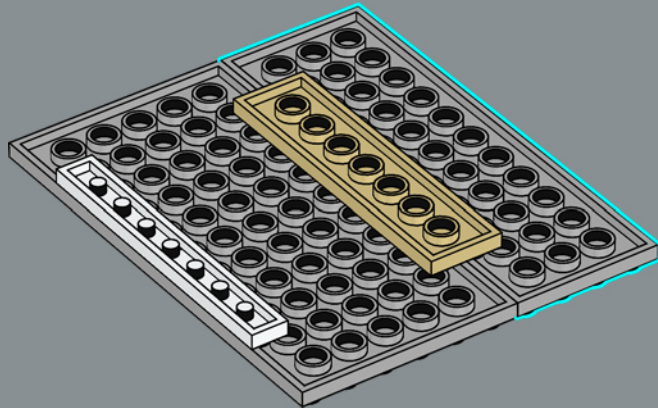

391

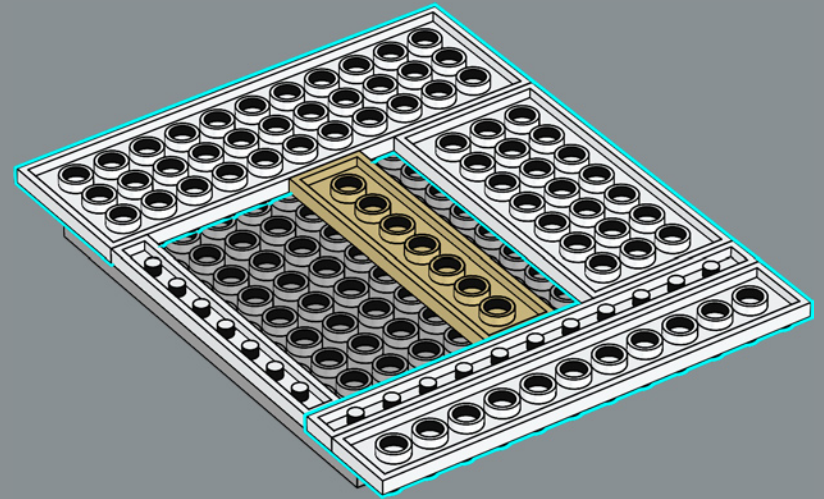

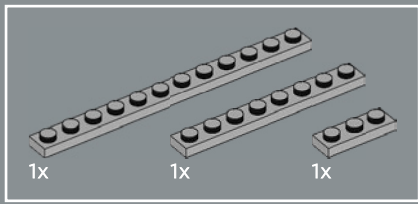

392

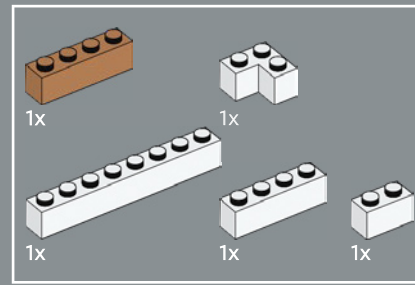
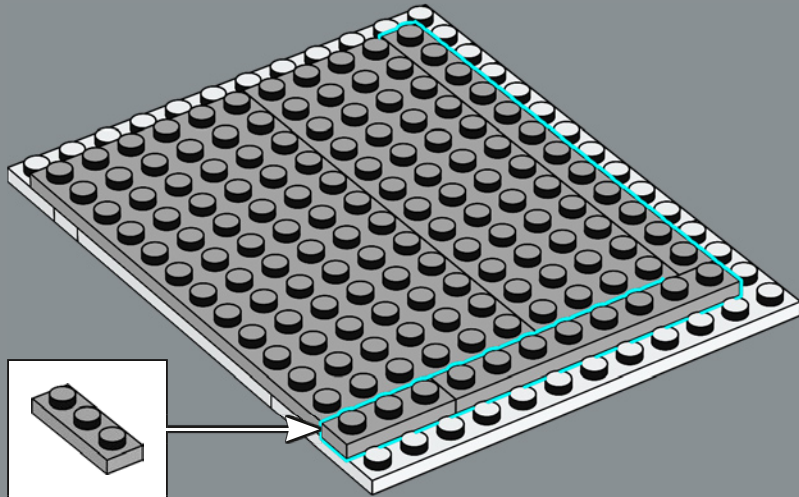

393

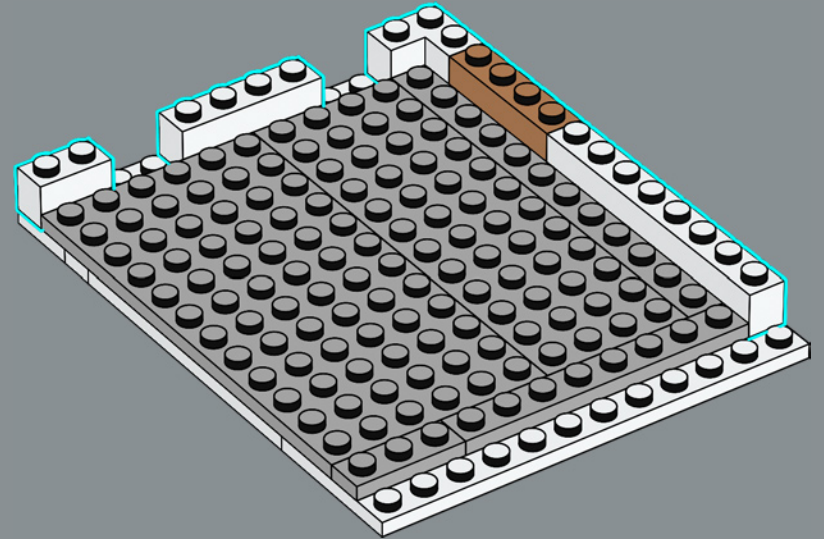



3x

394

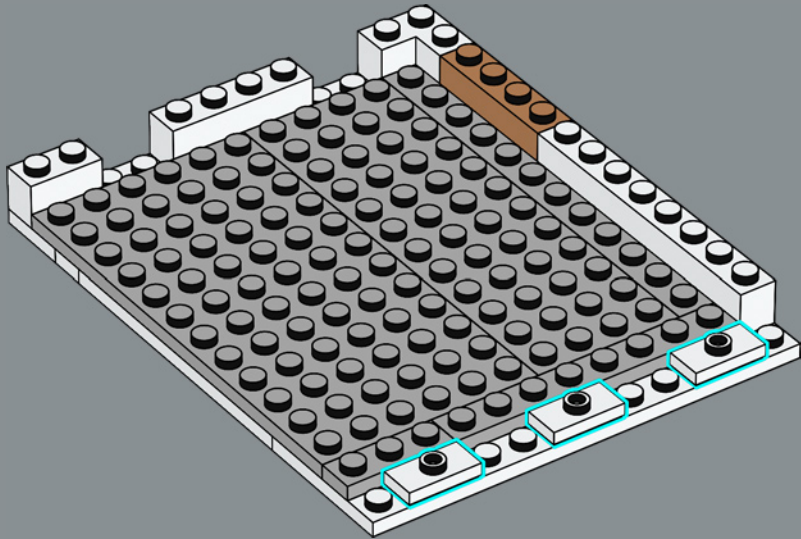

1x



1x

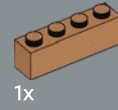

1x

395

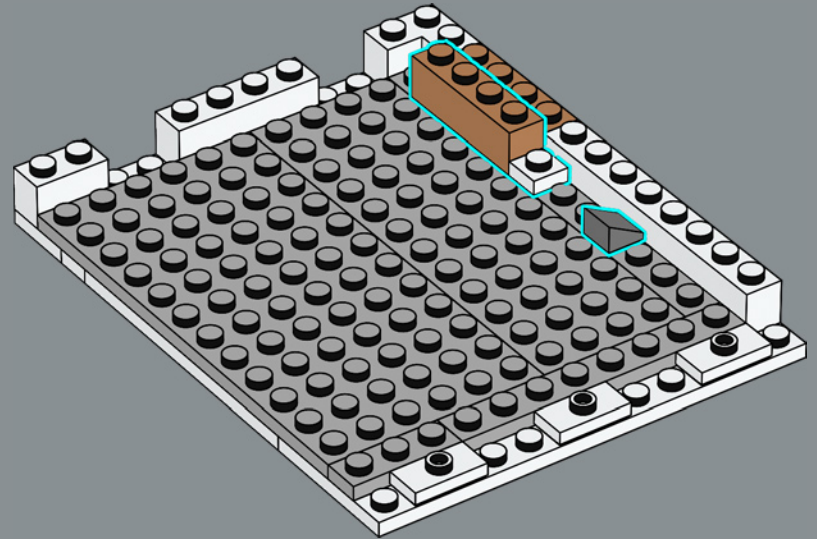

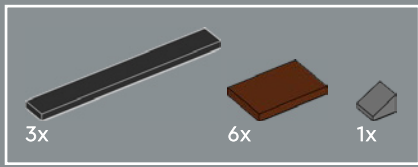

396

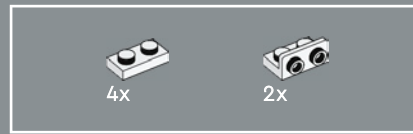
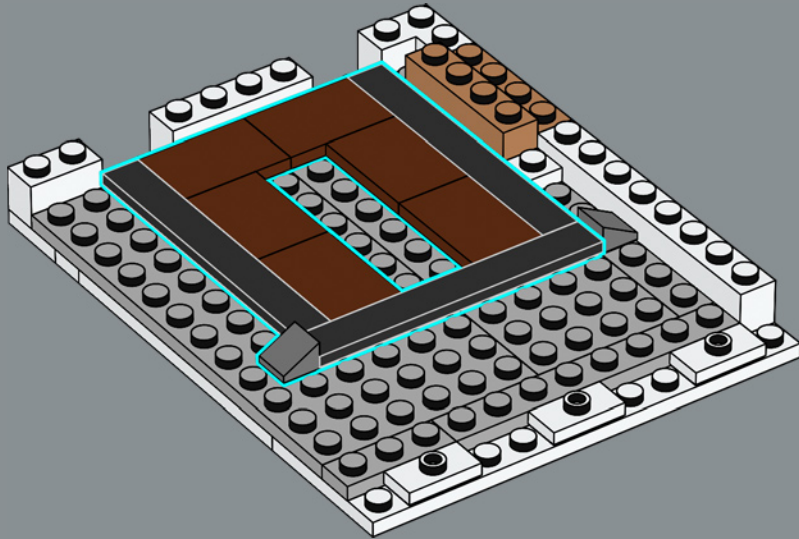

397

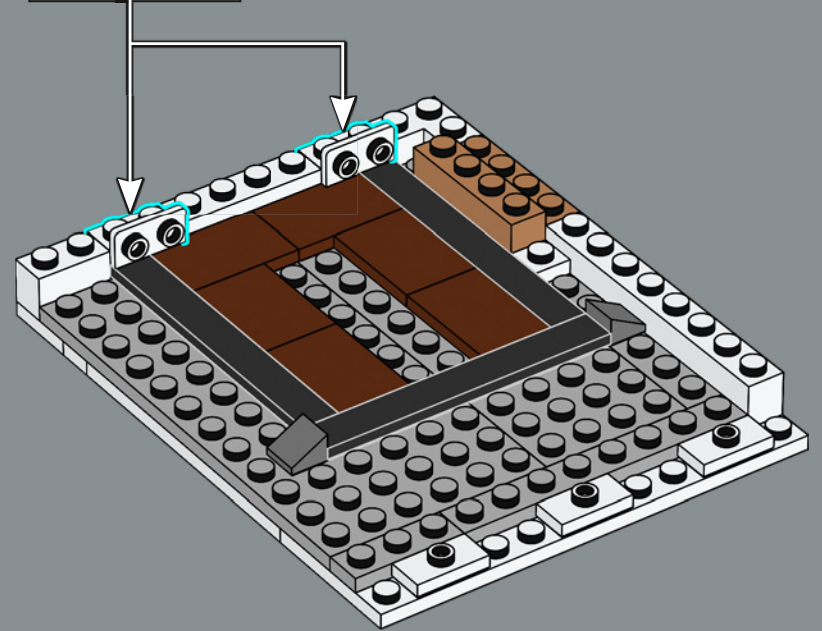
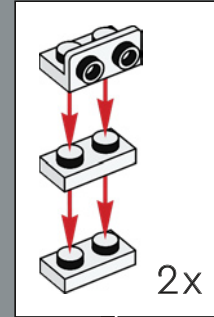

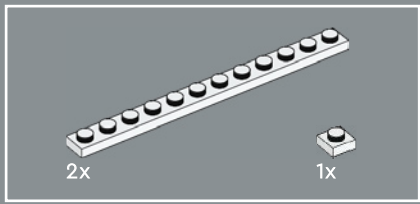

398

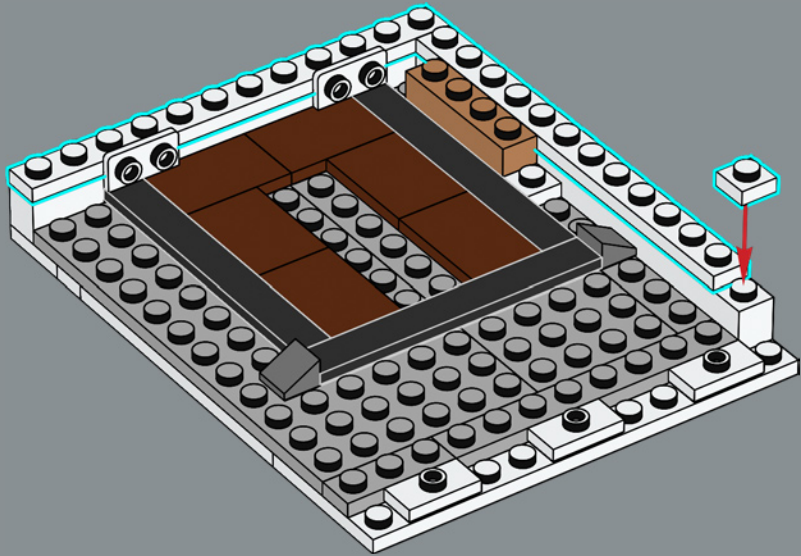

399

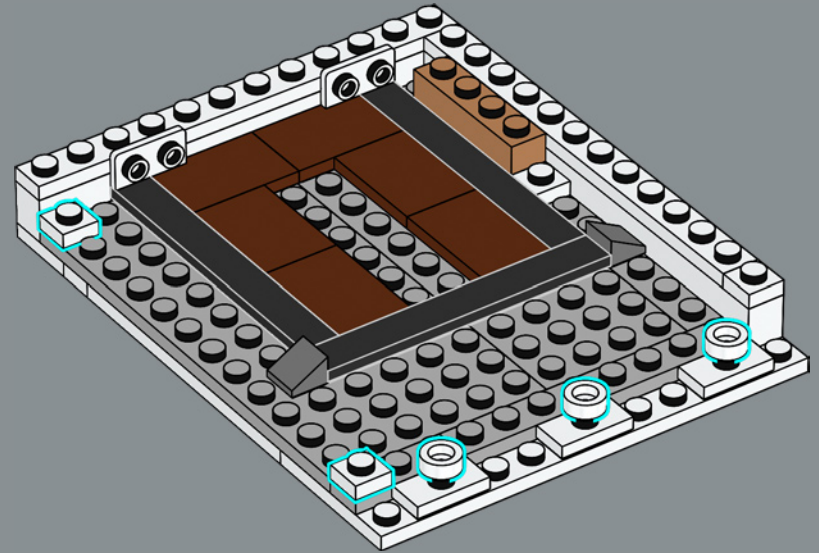



400

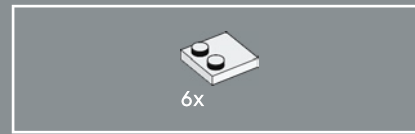
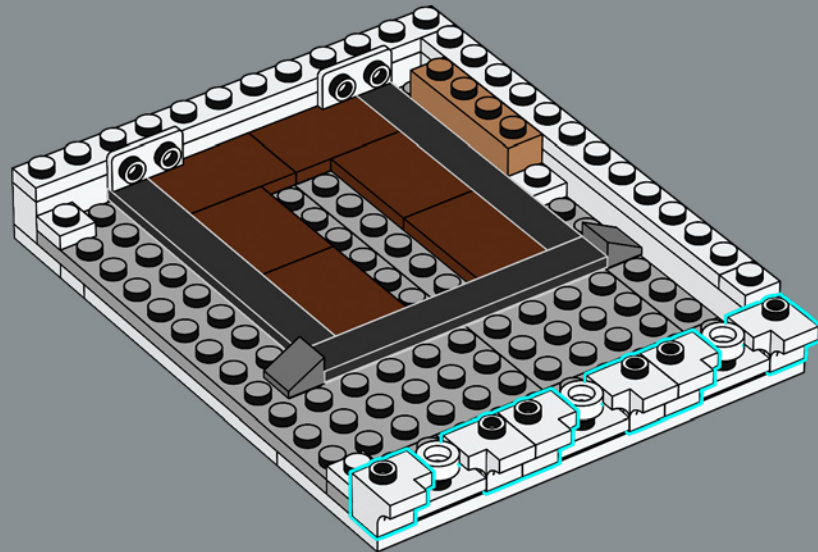

401

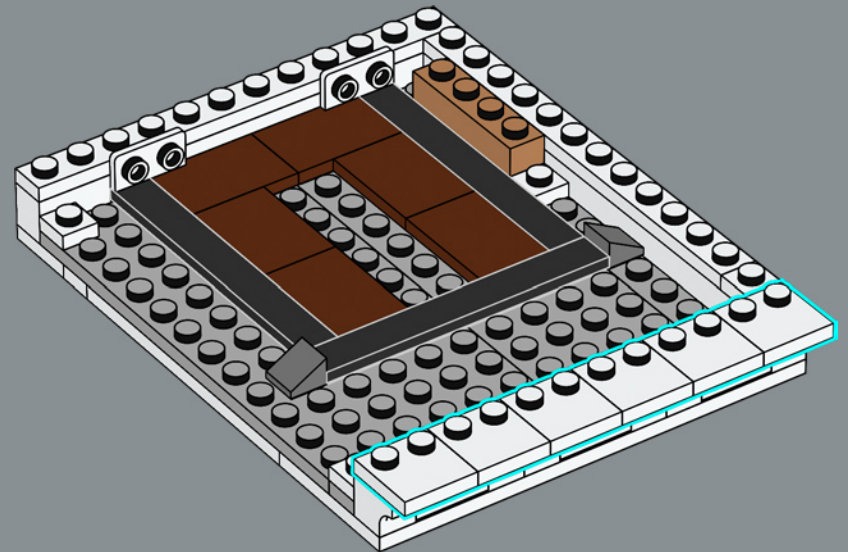

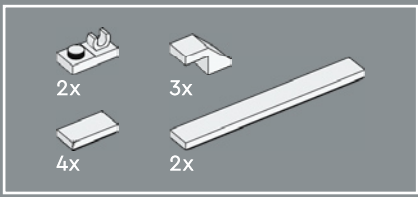

402

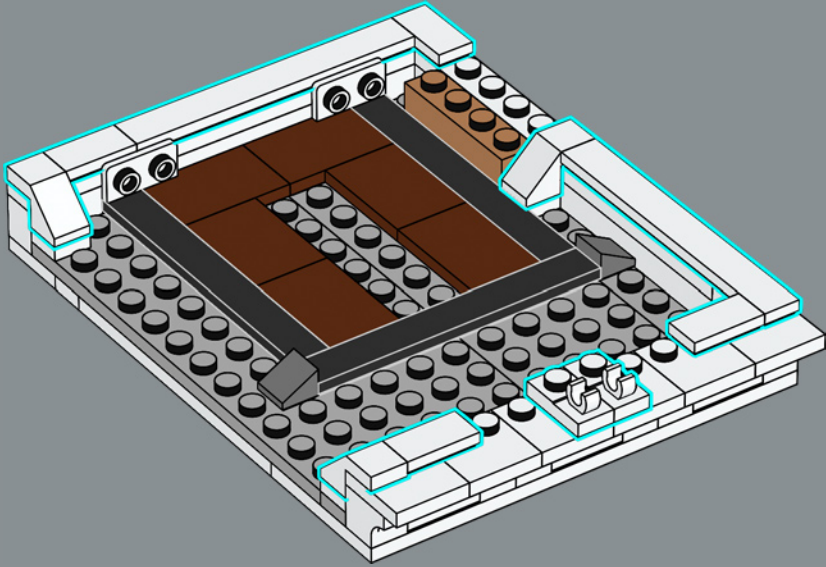

403

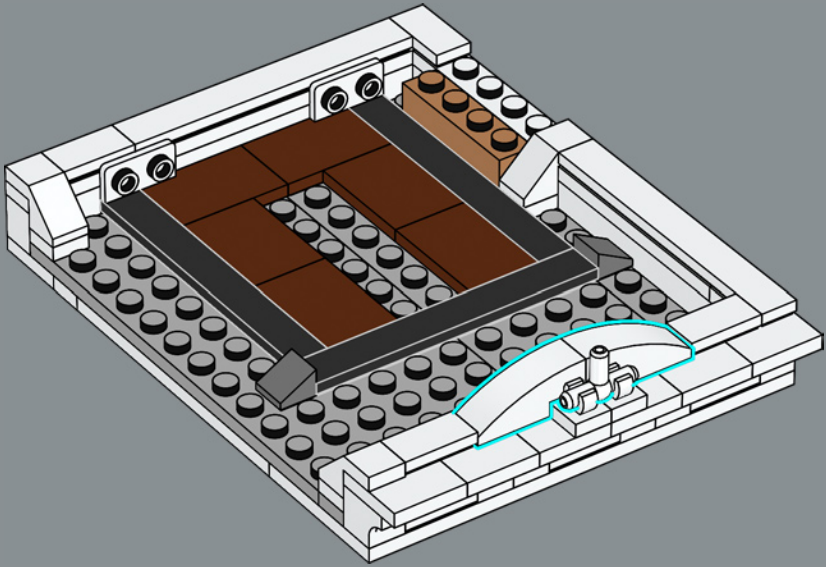

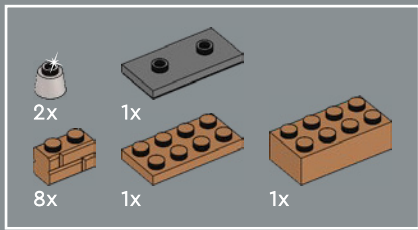

404

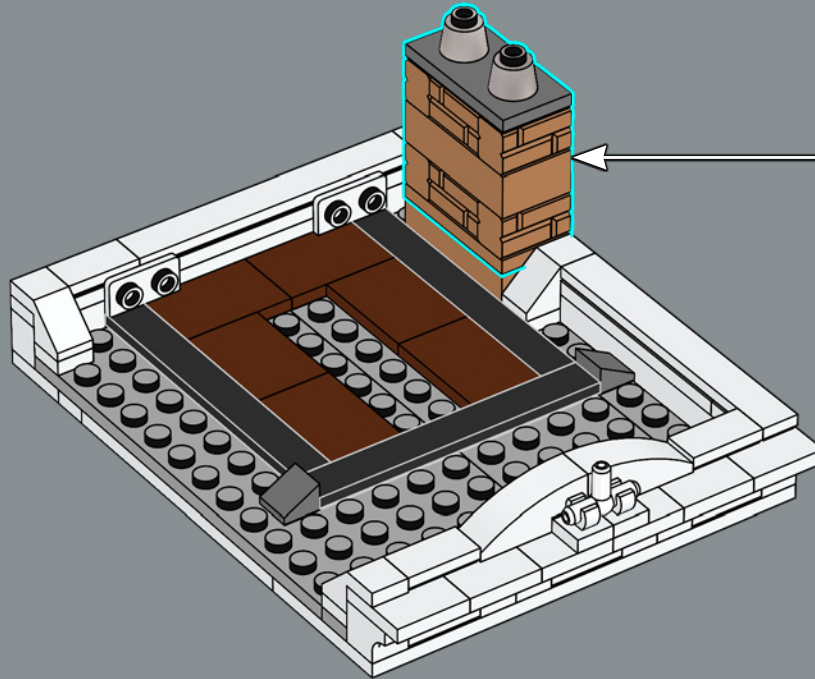
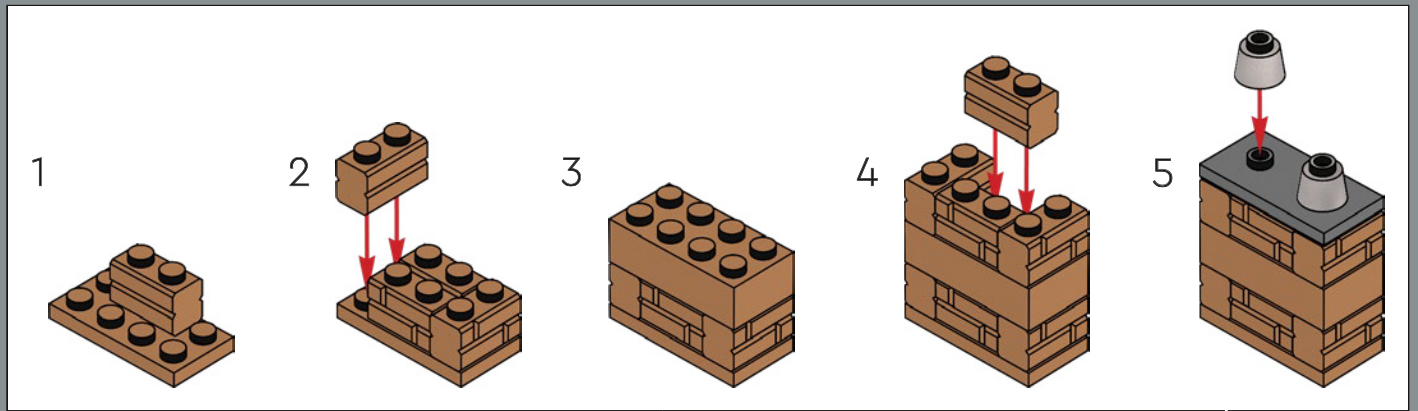

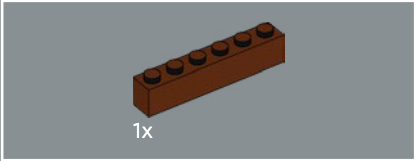

405

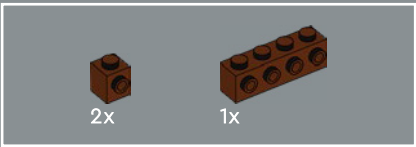
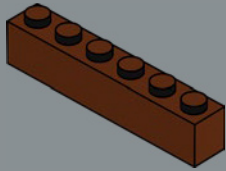

406

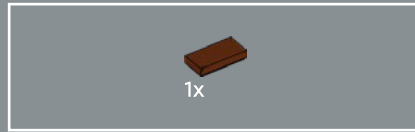
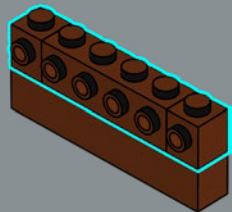

407

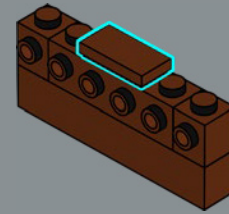

408

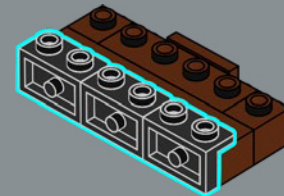

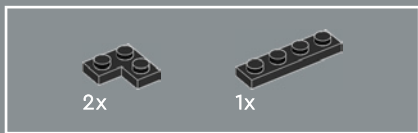

409

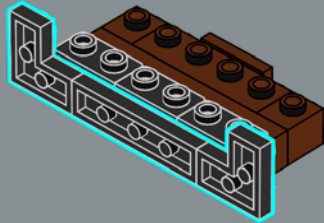

410

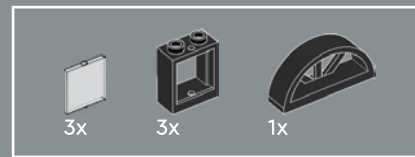
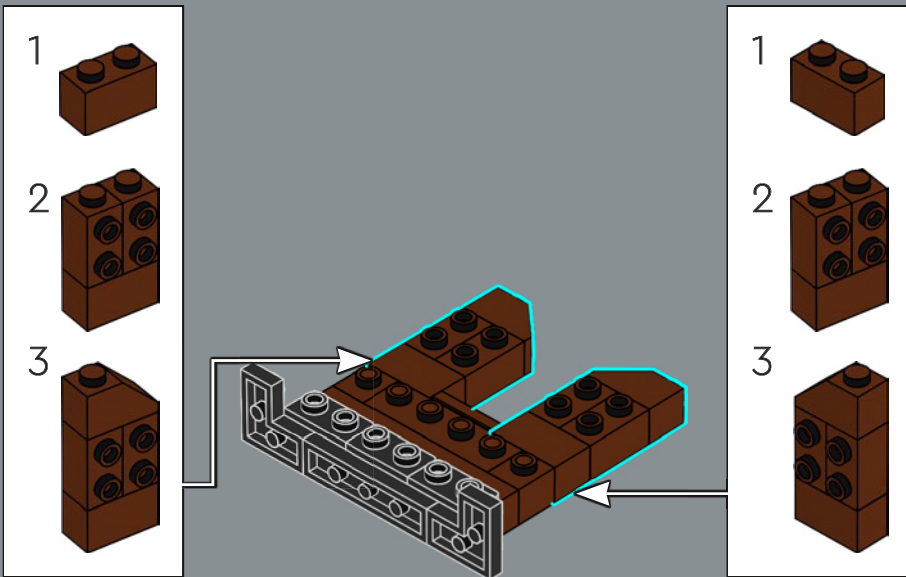

411

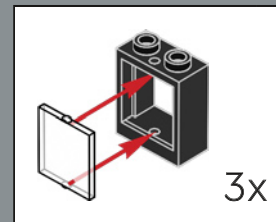
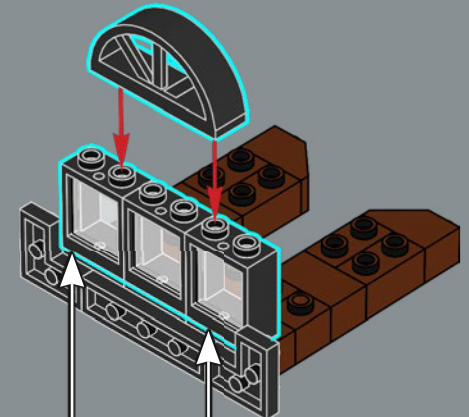

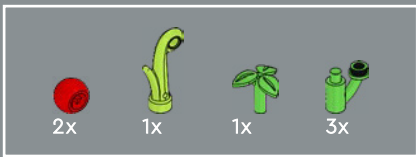

412

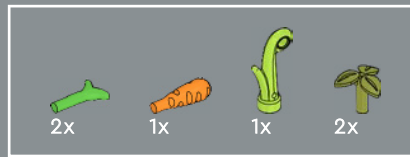
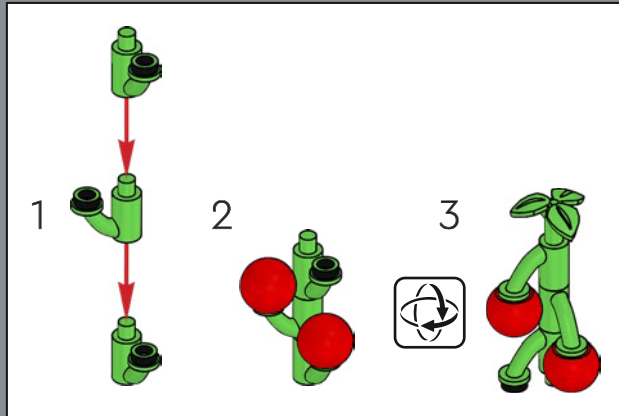

413



The pizza chef grows his own tomatoes and several herbs for his pizzas.
The carrot, however, is reserved for the magician's rabbit.

Le pizzaiolo cultive ses propres tomates et plusieurs herbes pour ses pizzas. La carotte, toutefois, est réservée au lapin de la magicienne.

El pizzero cultiva sus propios tomates y algunas hierbas para sus pizzas. La zanahoria, no obstante, está reservada para el conejo de la maga.

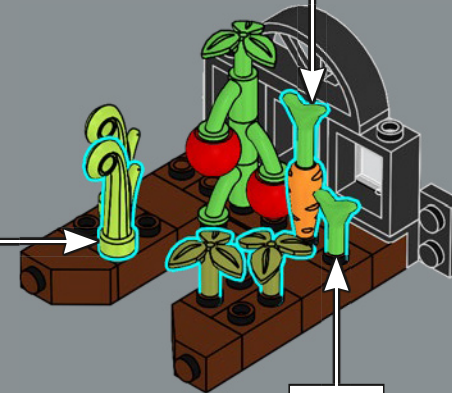
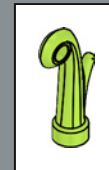
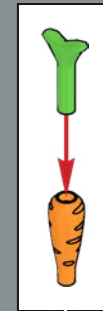

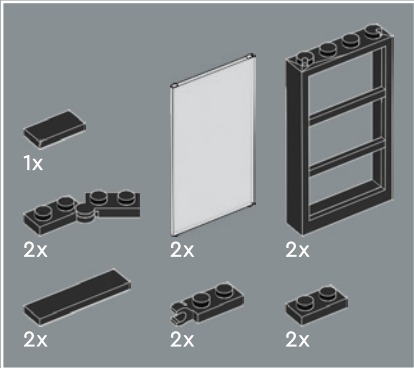
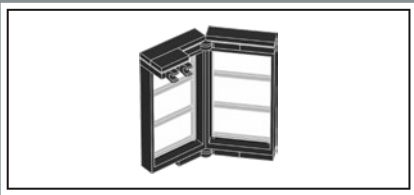

414

1



2

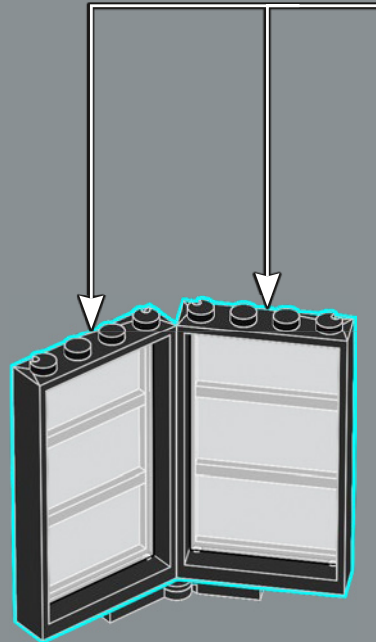

3

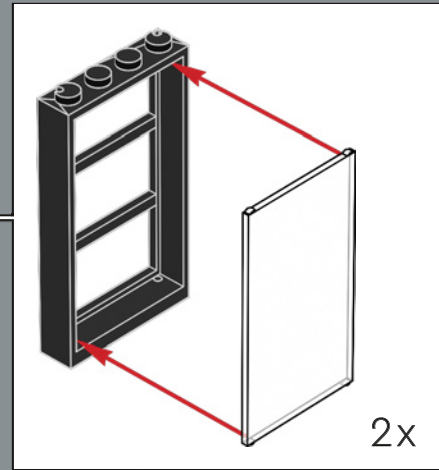
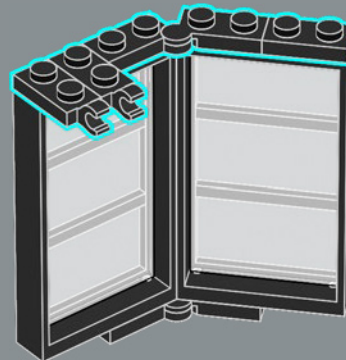

2x



4

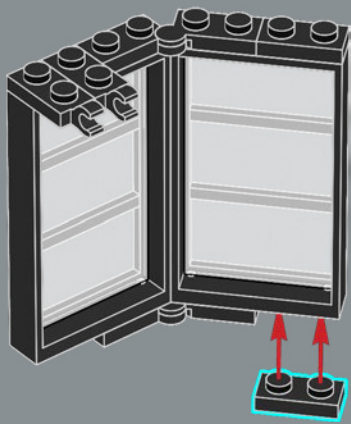

5

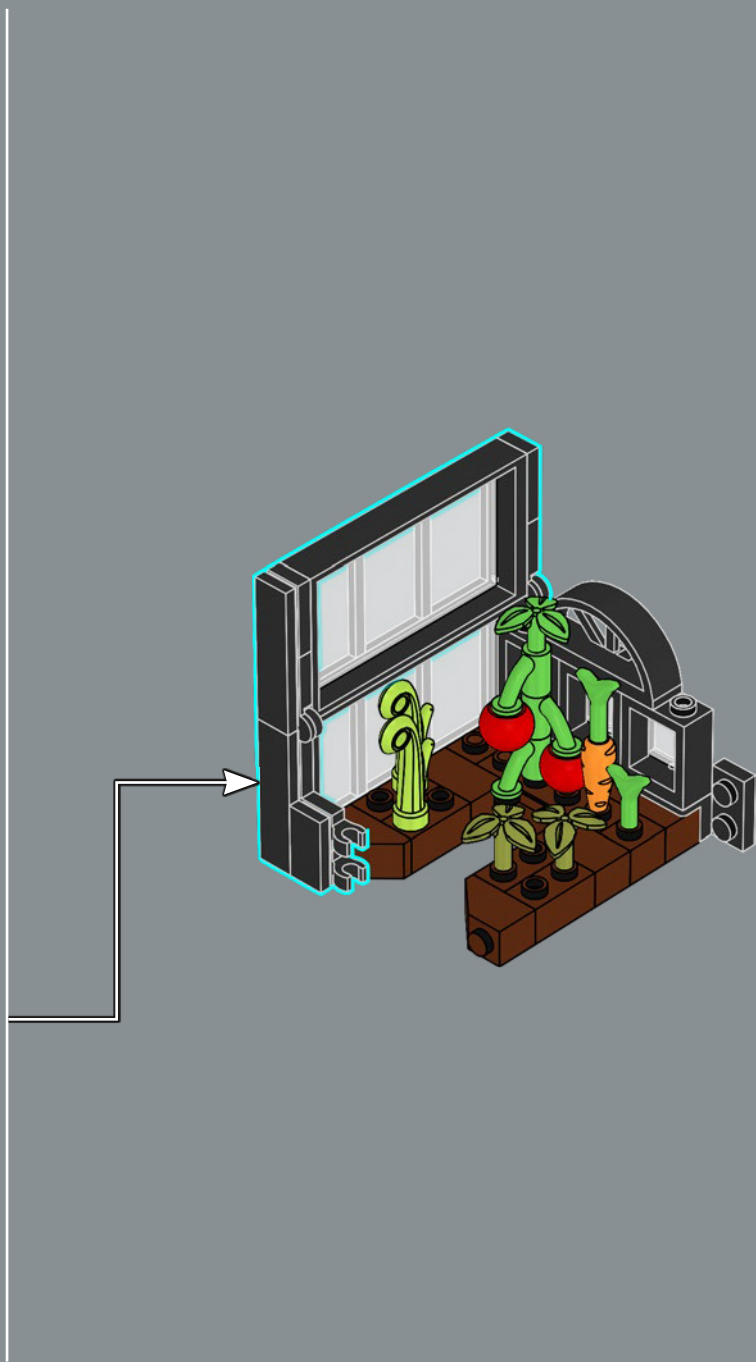
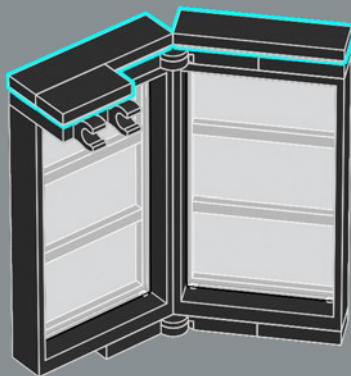

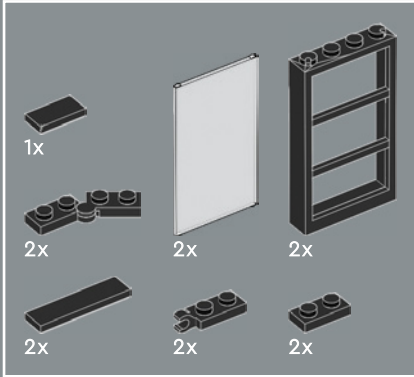
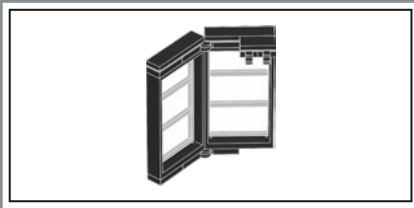

1



2

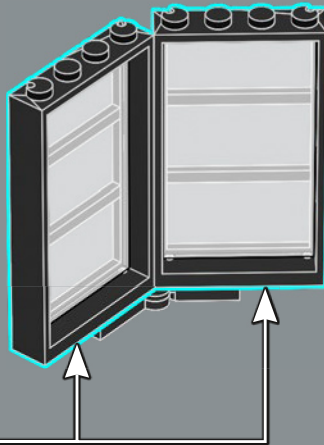

415

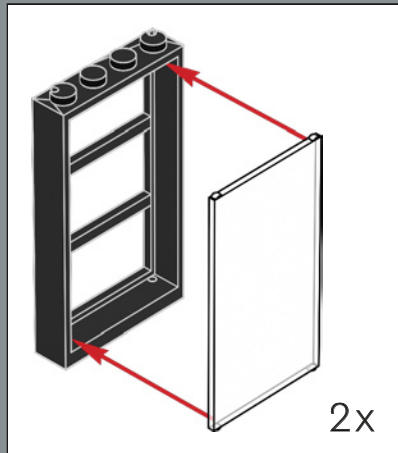

3

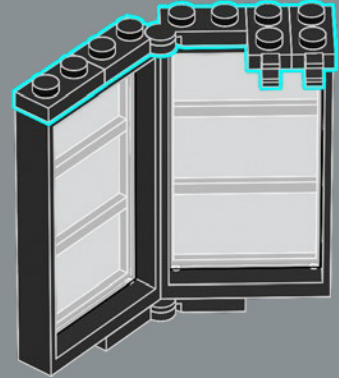

4

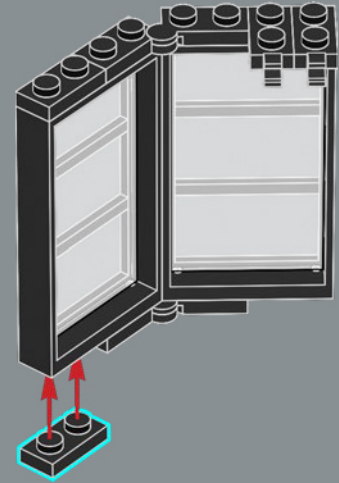

5

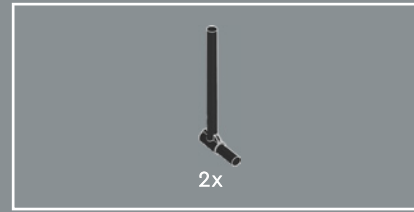

416

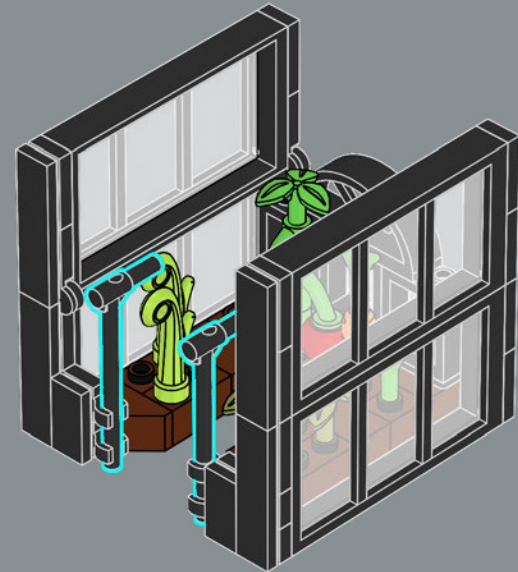
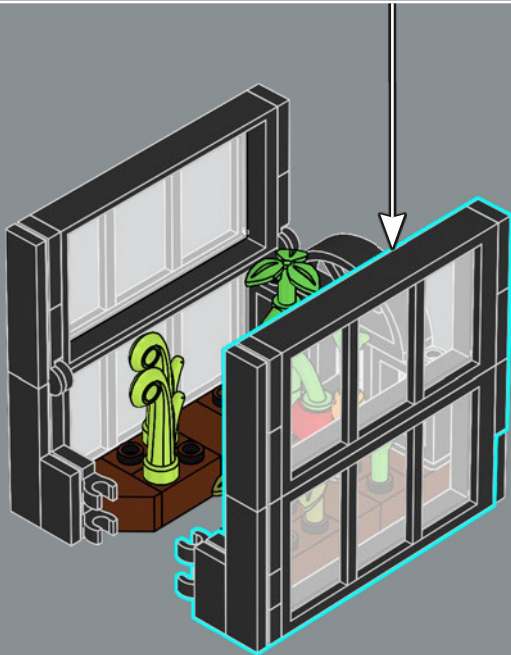

417



418

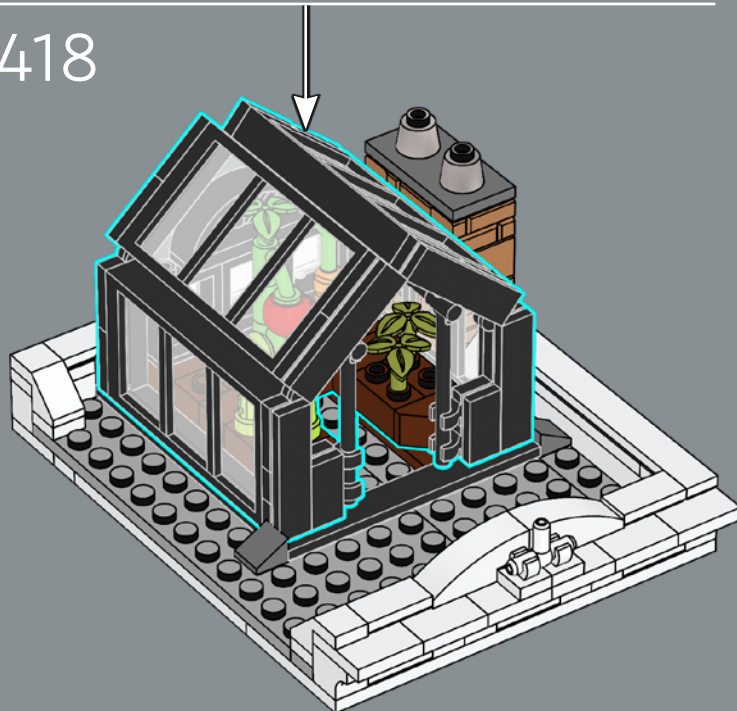

419

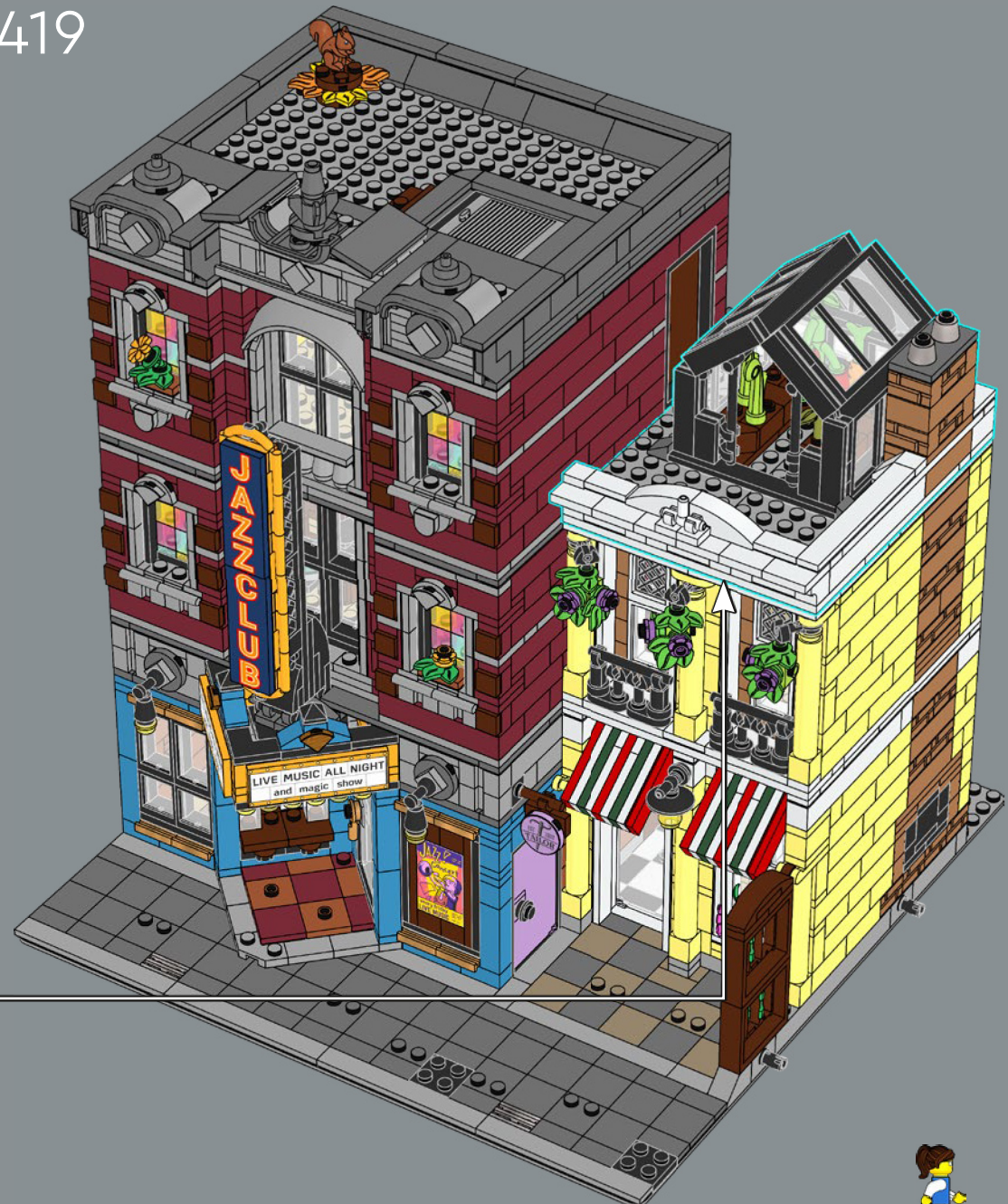



420

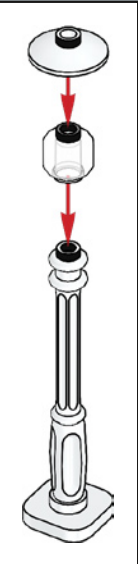
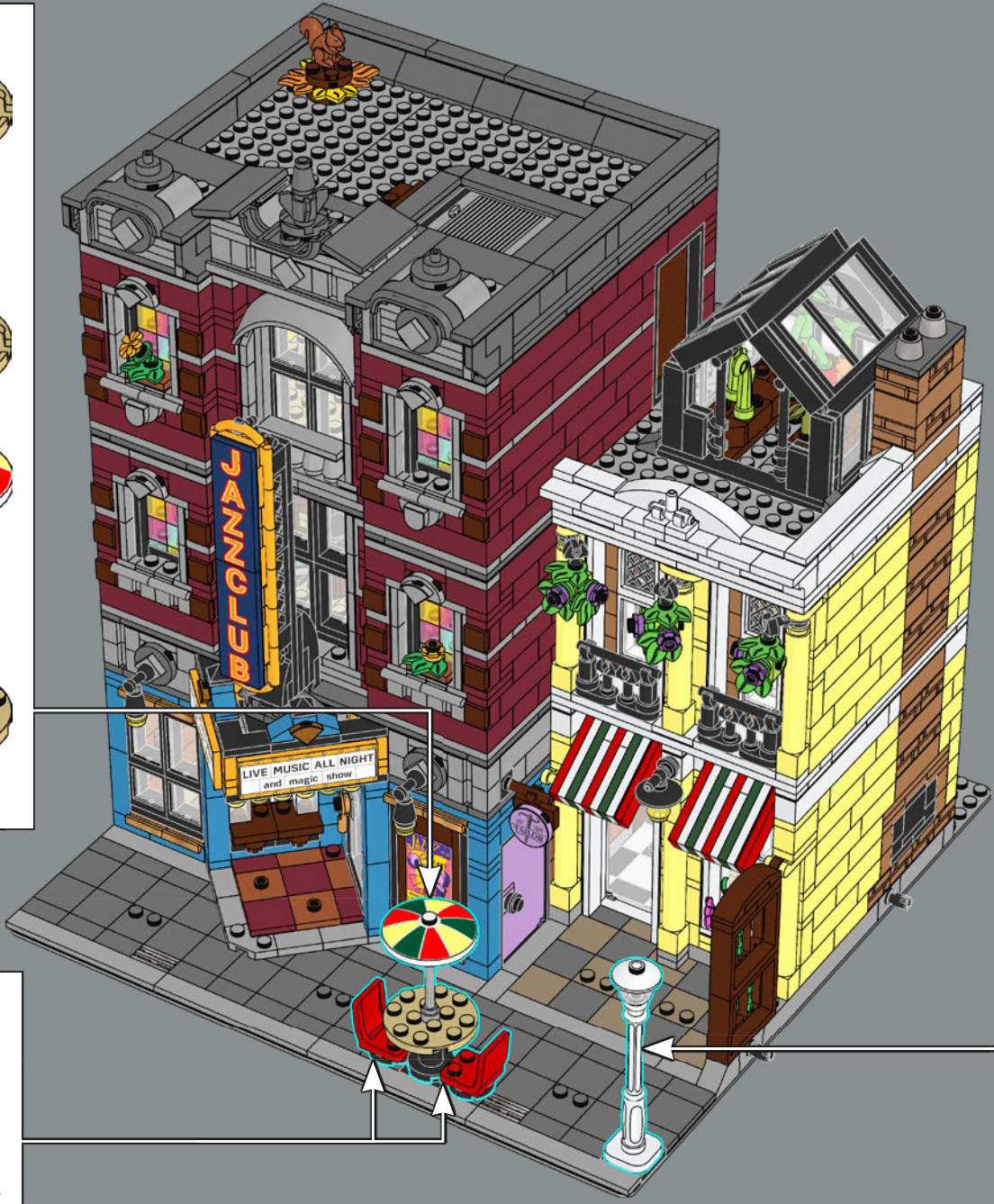
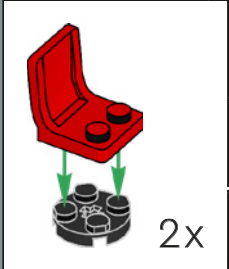
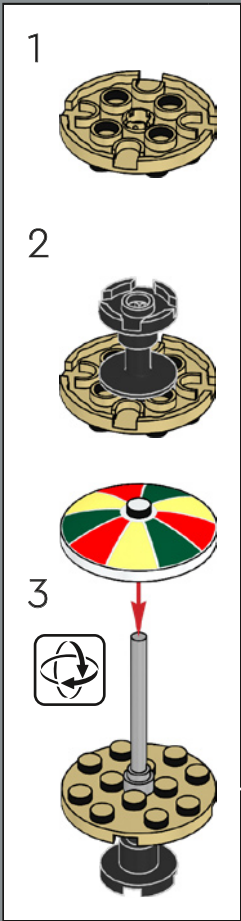



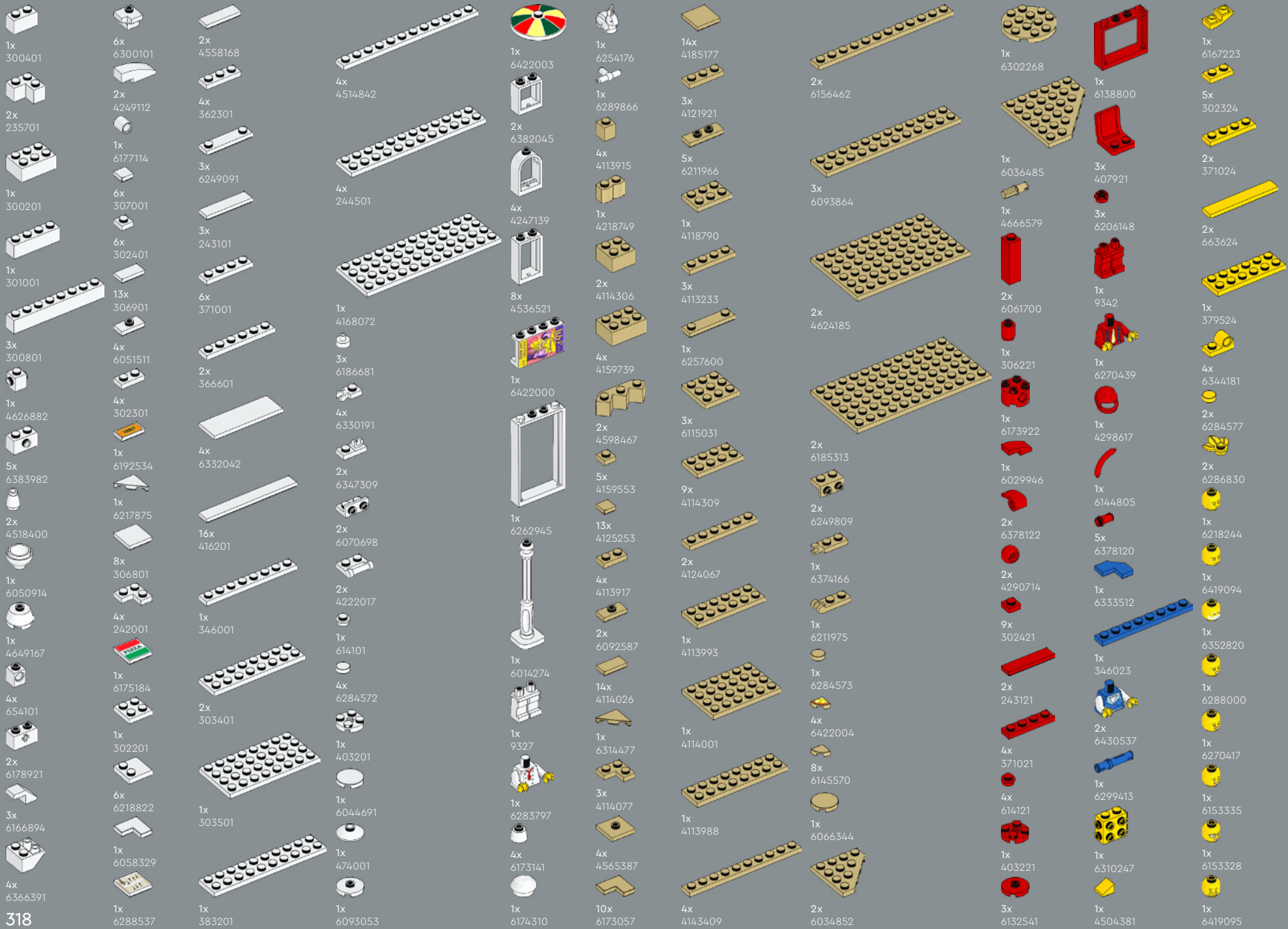

2x 300526	2x 6039869	12x 371026	1x 4514845	1x 474026	4x 6271169	1x 6431021	4x 6279875	1x 6206150
4x 4644456	9x 302426	13x 243126	13x 6186675	2x 6195325	4x 6271169	1x 6430624	1x 6173119	3x 6388070
2x 4558954	1x 307026	2x 302026	2x 6335388	2x 4106347	2x 459926	1x 6430843	2x 414580	1x 6235080
1x 473326	2x 241226	2x 6350415	4x 6196548	5x 6173105	1x 408326	1x 6430843	2x 4124096	10x 6182261
2x 6330197	19x 302326	4x 663626	2x 6330189	1x 6408578	1x 408326	1x 6356860	1x 368026	1x 6331087
2x 4253815	10x 306926	3x 366626	4x 6157554	1x 6408578	1x 6066113	1x 6343688	4x 6416444	3x 4119479
2x 4288212	6x 6092585	1x 4243819	3x 6313116	19x 6382697	4x 4187209	1x 4105175	2x 4517986	1x 6430413
8x 4529236	2x 6214807	3x 416226	2x 6000650	8x 4536522	1x 602026	2x 6326681	1x 6104209	13x 6254484
1x 4558957	4x 6166859	3x 346026	5x 6020193	6x 6336989	1x 602026	2x 4538456	1x 306228	11x 6253417
2x 6312449	7x 242026	2x 346026	1x 6310268	3x 4225201	6x 4530589	1x 6151289	1x 6047426	1x 6212081
1x 329826	3x 302226	1x 395826	6x 6336989	4x 6168646	1x 6177083	1x 6170808	2x 6347288	14x 6263221
1x 4529155	2x 6192346	1x 303526	3x 6336989	4x 614126	1x 6177083	1x 6057397	1x 6229130	43x 6223040
4x 329726	7x 306826	1x 303526	3x 4225201	3x 614126	2x 4623113	1x 6396403	1x 6269971	18x 6000743
1x 6275732	10x 6133722	1x 303526	4x 6168646	6x 6210270	1x 6093525	1x 6106280	1x 6382575	1x 6361813
1x 6053077	2x 362326	3x 383226	6x 6210270	9x 403226	4x 6116604	13x 6315887	2x 6285598	8x 6186012
	4x 4558170		9x 403226	1x 6431014	1x 9339	9x 6278152	1x 6314378	
	3x 302126		1x 6431014					

- 3x 4570877
- 2x 4614158
- 2x 6092602
- 2x 6315197
- 4x 6248949
- 1x 6313129
- 1x J5 6172566
- 1x 6384077
- 2x 6220959
- 1x 6251294
- 16x 6252258
- 21x 6254552
- 4x 6256058
- 6x 6253734
- 32
- 1x 6283590
- 4x 6277483
- 2x 6238674
- 8x 6252045
- 6x 6274740
- 19x 6240216
- 1x 6171728
- 1x 4267425
- 2x 6213782
- 3x 6213779
- 1x 6210775
- 2x 6240467
- 8x 6240553
- 3x 6174006
- 2x 6188696
- 1x 6306726
- 1x 4558595
- 2x 6253884
- 1x 6103249
- 1x 6240515
- 6313826
- 1x 6310830
- 1x 6001822
- 1x 6273590
- 9x 6055172
- 4x 4496699
- 1x 6092591
- 5x 4507045
- 2x 6396392
- 17x 6175927
- 1x 6270031
- 1x 6031821
- 2x 6216905
- 1x 6422001
- 1x 6422002
- 2x 6350417
- 2x 4162916
- 103x 6052777
- 10x 4541528
- 4x 6089268
- 2x 6311108
- 24x 4539092
- 1x 4539099
- 2x 6267414
- 2x 6173168
- 2x 6042953
- 24x 4539114
- 2x 4539090
- 61x 4539097
- 10x 4585751
- 2x 4585479
- 23x 4541376
- 70x 4539102
- 31x 4541379
- 18x 6264025
- 2x 4539105
- 4x 4539076
- 2x 4583299
- 2x 4539062
- 3x 4541507
- 2x 6253142
- 4x 6384234
- 2x 6359683
- 2x 6313126
- 17x 6335330
- 6x 6359716
- 3x 6003033
- 8x 6020073
- 2x 6422005
- 6x 6331205
- 1x 6209681
- 1x 6212994
- 2x 6430410
- 2x 6245265
- 4x 6061685
- 2x 6186542
- 4x 6073040
- 4x 6099714
- 4x 6020923
- 1x 6409778
- 1x 6349342
- 2x 4211199
- 4x 6146858
- 1x 4658005
- 24x 4211288
- 3x 4221744
- 2x 4211150
- 2x 4224243
- 4x 4211151
- 4x 4216695
- 4x 6196221
- 1x 6100769
- 6x 6311441
- 1x 6257604
- 3x 4211190
- 1x 4211194
- 2x 6307618
- 1x 4211186
- 1x 4211204
- 2x 4221590
- 1x 4211211
- 1x 4217848
- 2x 6186673
- 2x 6401027
- 2x 6238874
- 1x 6313124
- 2x 6290983
- 1x 6338135
- 3x 4216581
- 1x 6284586
- 2x 4211159
- 4x 6102360
- 1x 6342958
- 1x 6075207
- 1x 6228841
- 1x 6428805
- 1x 6267760
- 1x 6093515
- 1x 6422007
- 6x 6248918
- 2x 6271128
- 2x 4595889
- 6x 4211206
- 12x 6310449
- 4x 6159763
- 1x 4609635
- 2x 6261744
- 3x 4211242
- 2x 4211149
- 1x 4211193
- 4x 6201911
- 3x 6062574
- 3x 6103004
- 1x 6153594
- 1x 6036503
- 2x 6151461

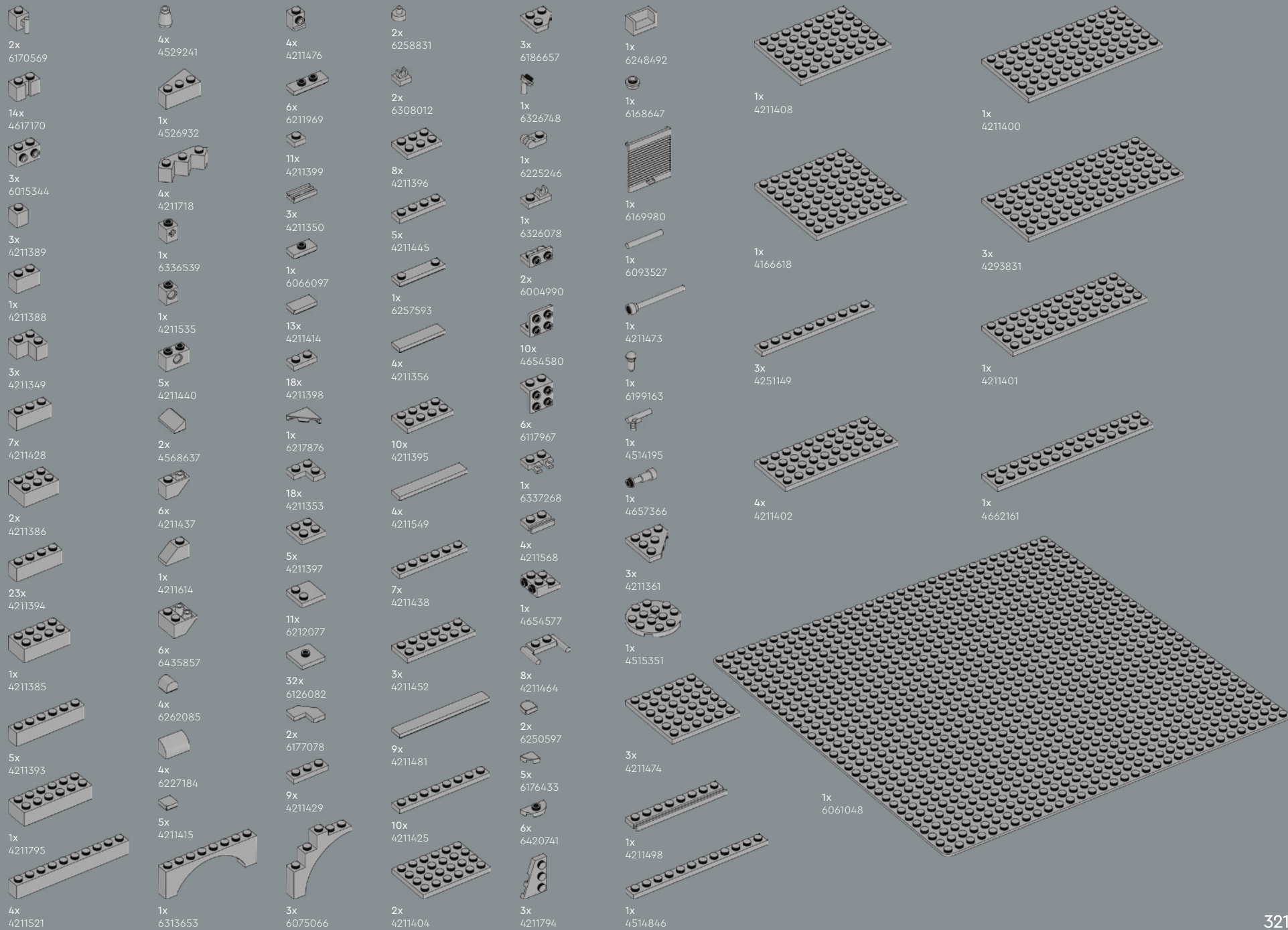



YOU COULD WIN



YOU COULD WIN

Your feedback will help shape the future development of this product series.

Visit:

DU KÖNNTEST GEWINNEN

Dein Feedback trägt zur Weiterentwicklung dieser Produktreihe bei.

Geh auf:

VOUS POURRIEZ GAGNER

Vos commentaires nous aideront à concevoir les futurs produits de cette gamme.

Visitez :

POTRESTI VINCERE TU

La tua opinione ci aiuterà a migliorare la creazione futura di questa linea di prodotti.

Visita:

PUEDES GANAR

Tu opinión contribuirá al futuro de esta serie de productos.

Visita:

轻松获奖

您的反馈将有助于我们在今后改进本产品系列。

请访问:

LEGO.com/productfeedback

You also have the chance to win a LEGO® set.

Terms and conditions apply.*

Außerdem hast du die Chance, ein LEGO® Set zu gewinnen.

Es gelten die Teilnahmebedingungen.*

Vous pourriez également gagner un ensemble LEGO®.

Des conditions s'appliquent.*

Hai anche la possibilità di vincere un set LEGO®.

Termini e condizioni sono applicabili.*

También tienes la oportunidad de ganar un set LEGO®.

Aplican términos y condiciones.*

您还有机会赢取乐高®套装。

条款和条件适用。*

*[LEGO.com/productfeedback-terms](https://www.lego.com/productfeedback-terms)

