

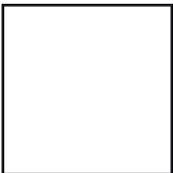

Booklet available in English on
Heft in deutscher Sprache erhältlich auf
Livret disponible en français sur
Libretto disponibile in italiano su
Folleto en español disponible en
如需中文版手册, 请访问





FR

**DONNEZ
OU
RECYCLEZ**



ASSOCIATION
OU



MAGASIN
OU



DÉCHÈTERIE

Adresses sur quefairedemesdechets.fr



LEGO.com/sustainable-packaging



ANDERSON WARD GRUBB
Designer of the 10312 Jazz Club

WELCOME

Get ready for a great night out with live music, entertainment and delicious food! Inspired by classic architecture and infused with our favourite music from the golden age of jazz, this hot new music venue is a fresh addition to the LEGO® Modular Building series. Whether this is your first modular set, or you have been building your LEGO street from the beginning, you are always invited to build to your own tune.



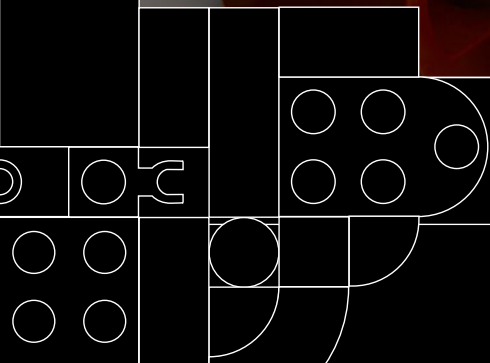

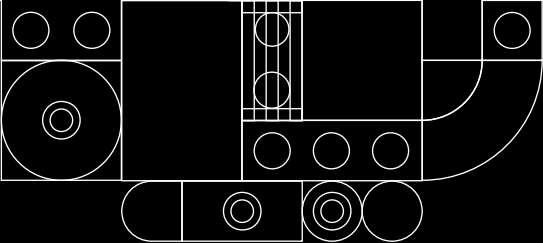

They say that in jazz, the notes that you don't play are just as important as the ones you do! Whether you're playing music notes or playing with LEGO® bricks, just play your own way!



LET THE MUSIC PLAY

Music can act as a virtual time machine that instantly takes you back to magical memories and moments in time or invites your imagination to travel to destinations you always dreamed of visiting. Play your favourite album on your vintage record player, jive into the LEGO® Icons Jazz Club and feel the thrilling atmosphere of this vibrant, mid-century magic and music melting pot full of creative, passionate performers, chefs and guests. Watch the show from the manager's office, grow produce for the kitchen in the rooftop greenhouse, feel the jitters in the dressing room, order a late-night snack, or enjoy a meal in the sidewalk café on a sizzling summer evening. No ticket or reservation required; your imagination grants you VIP access.



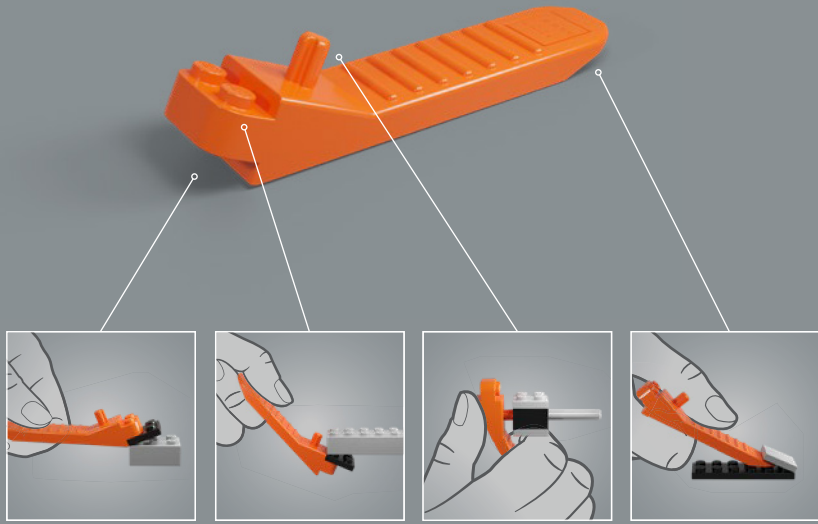
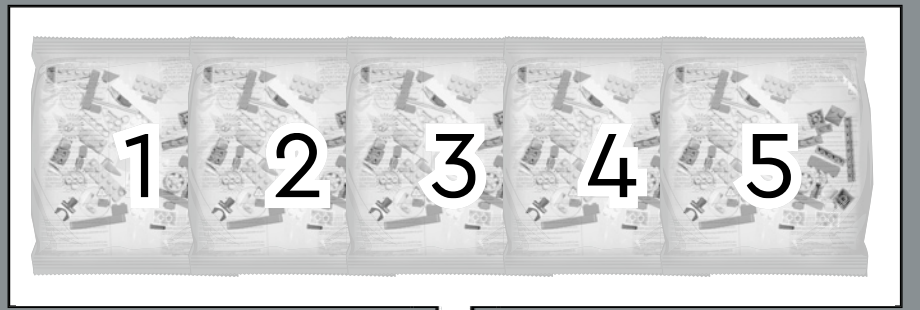

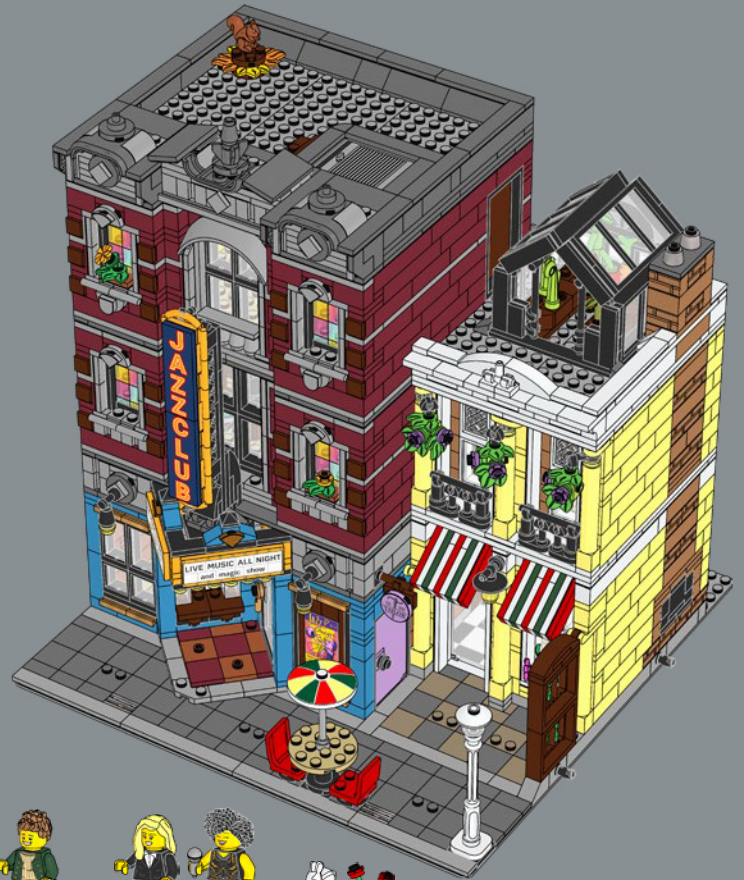
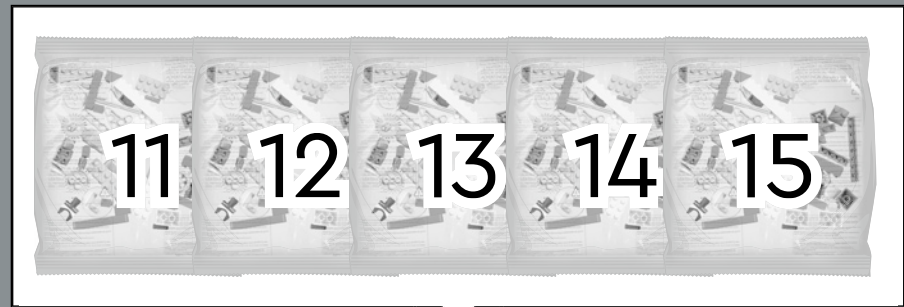
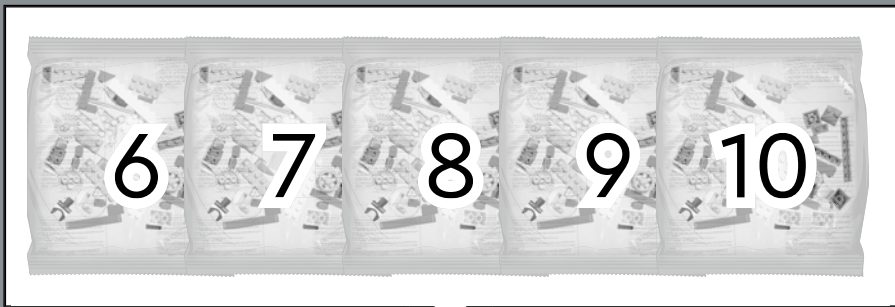

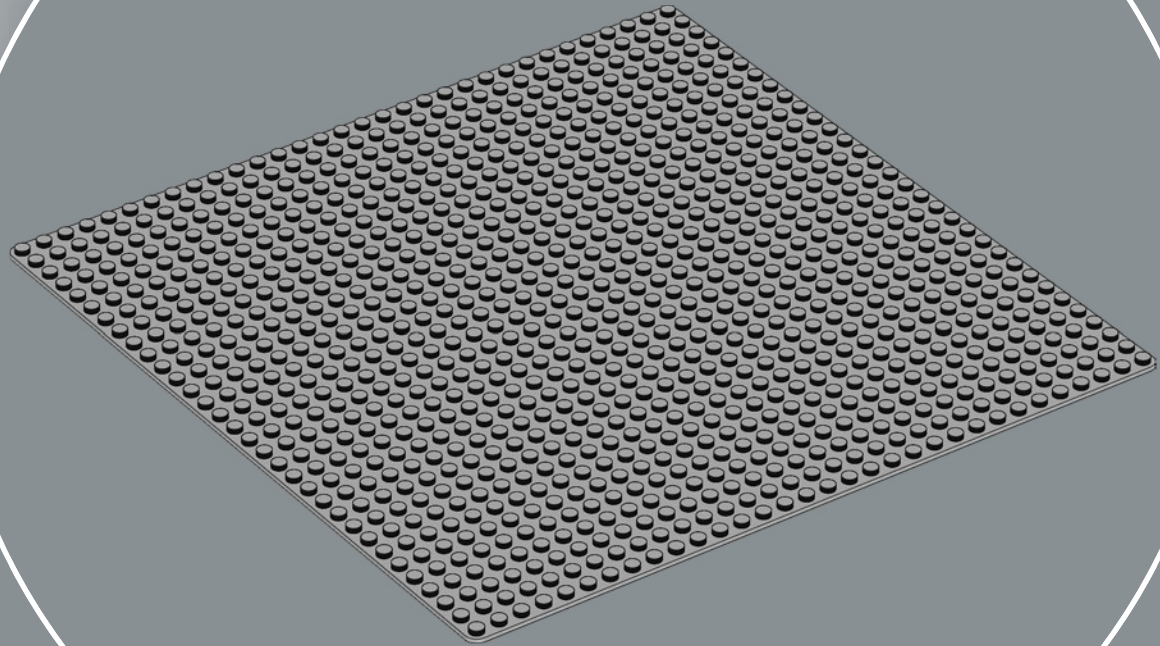
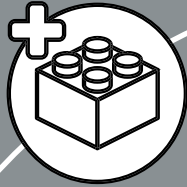

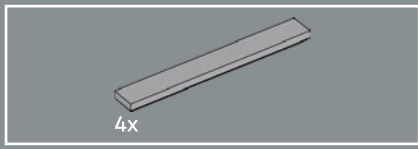

1

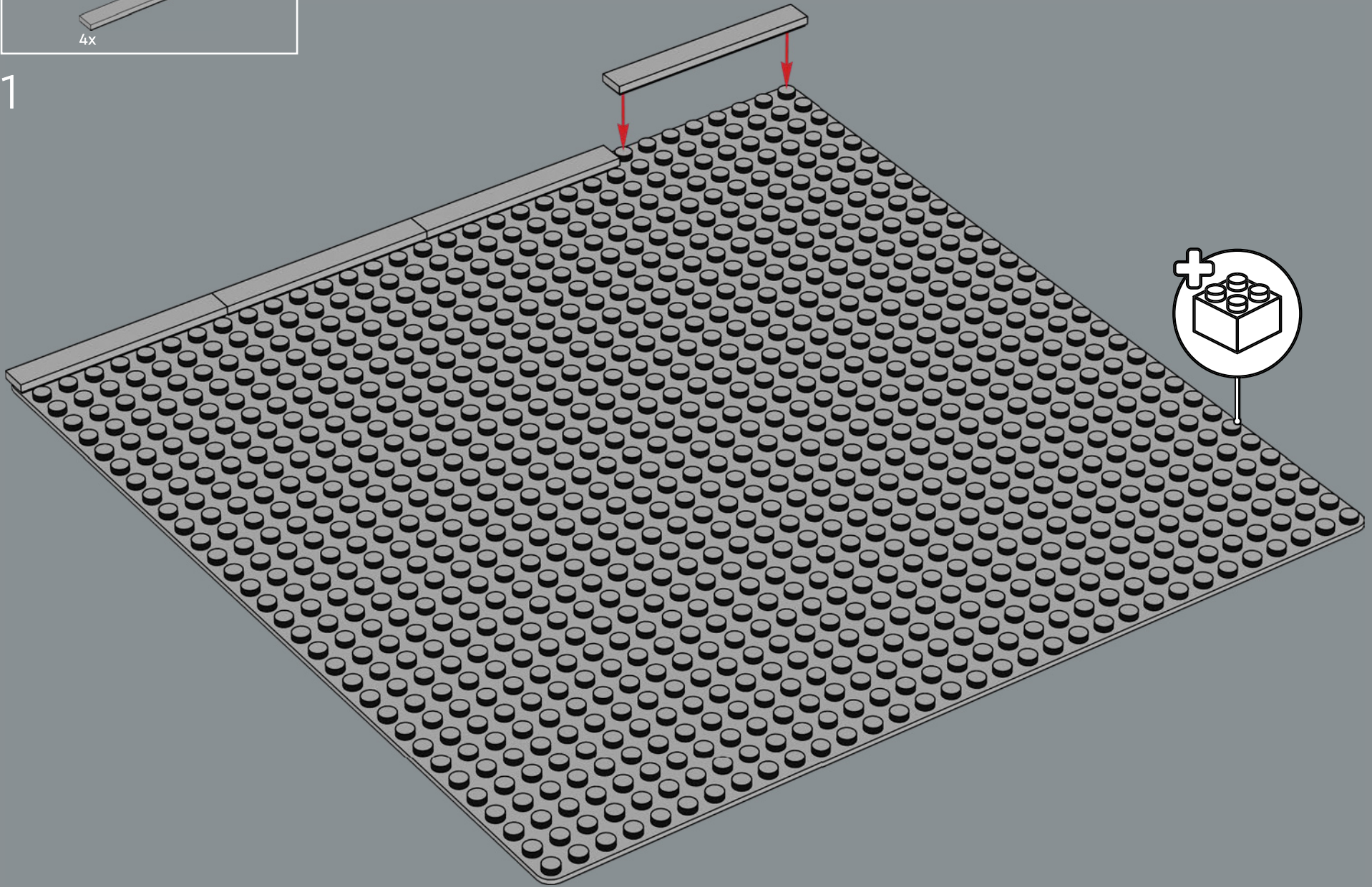

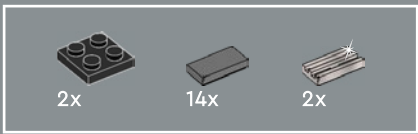

2

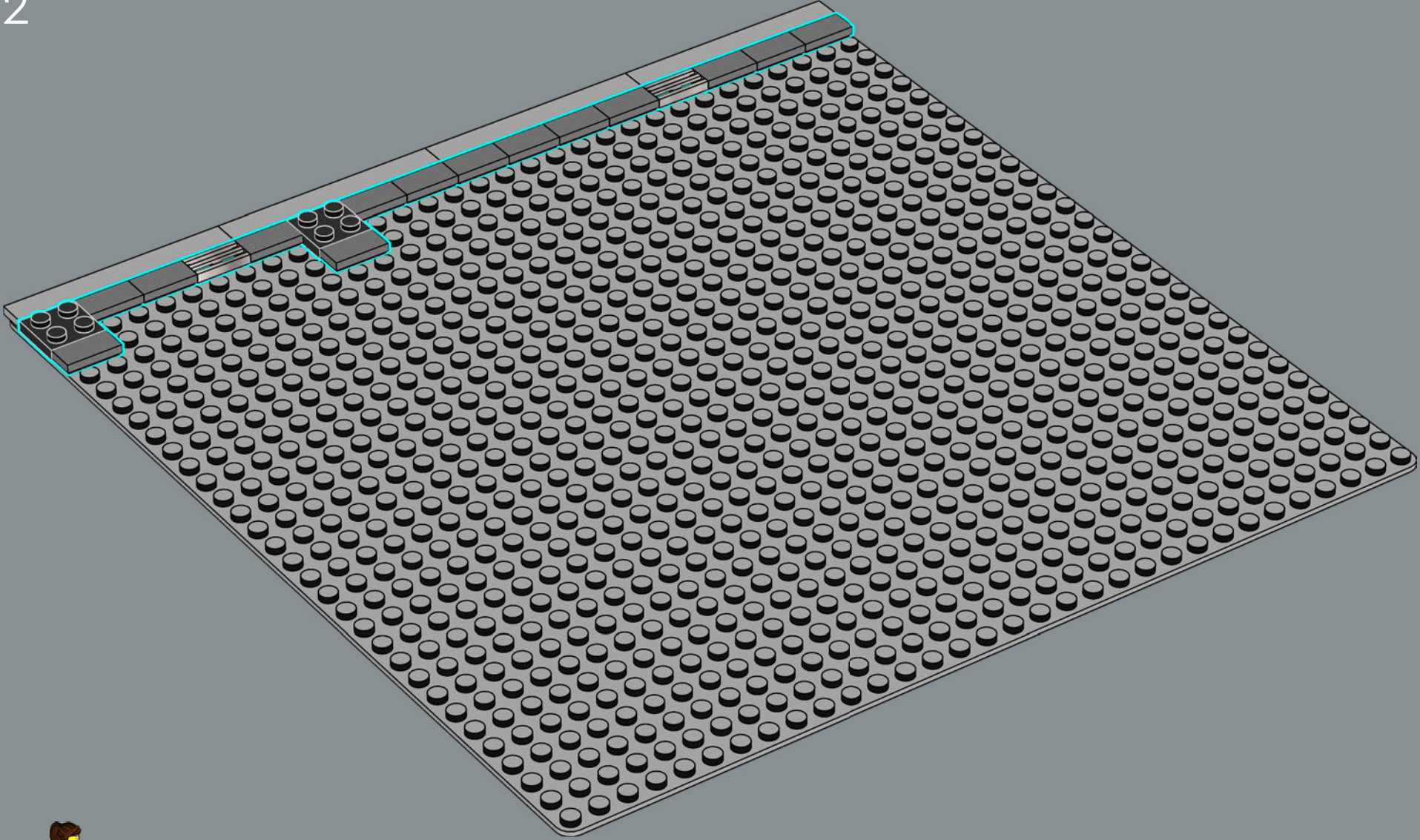

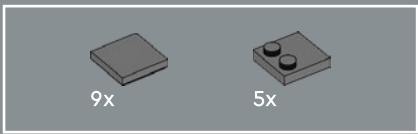

3

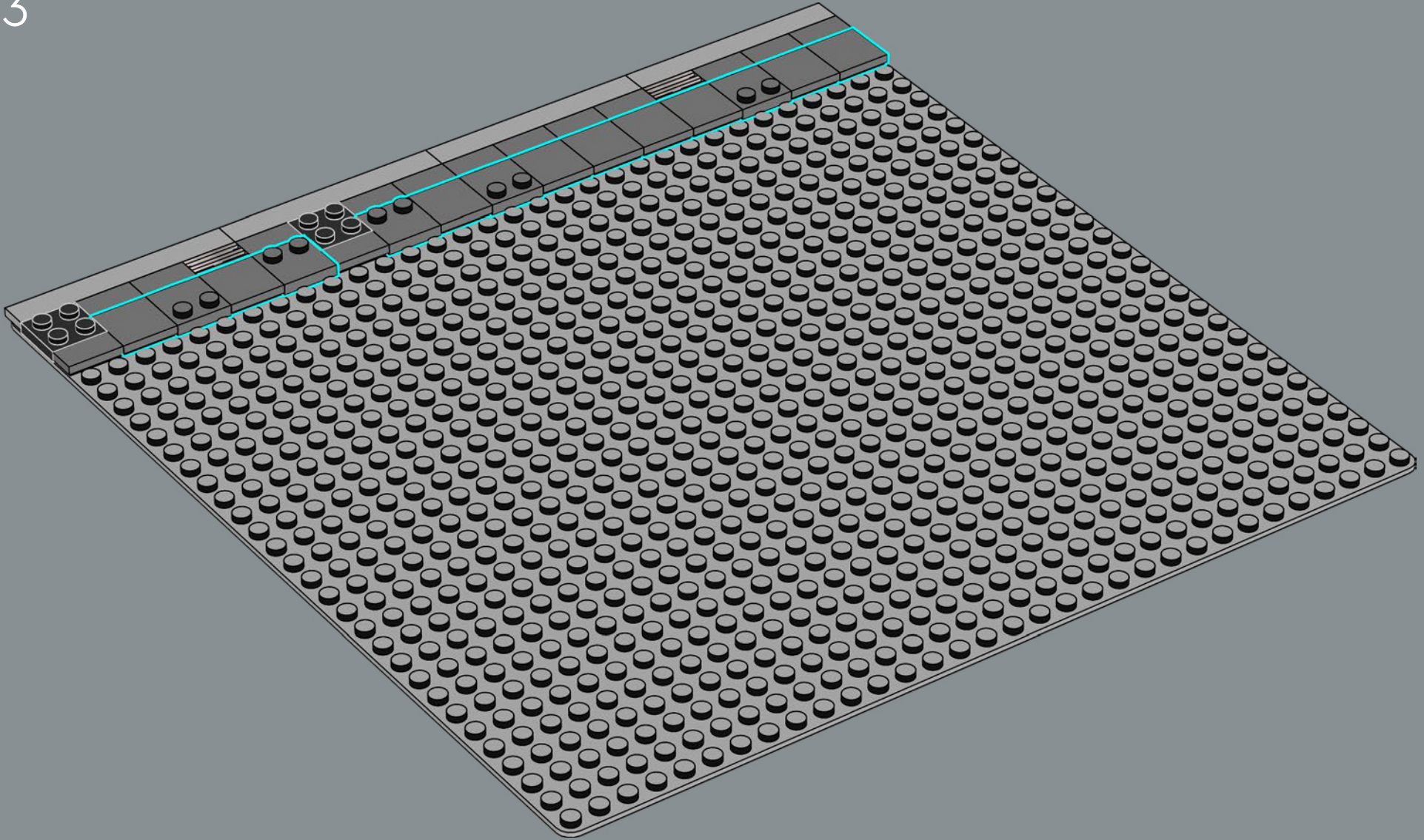

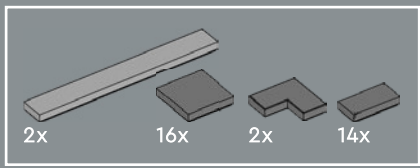

4

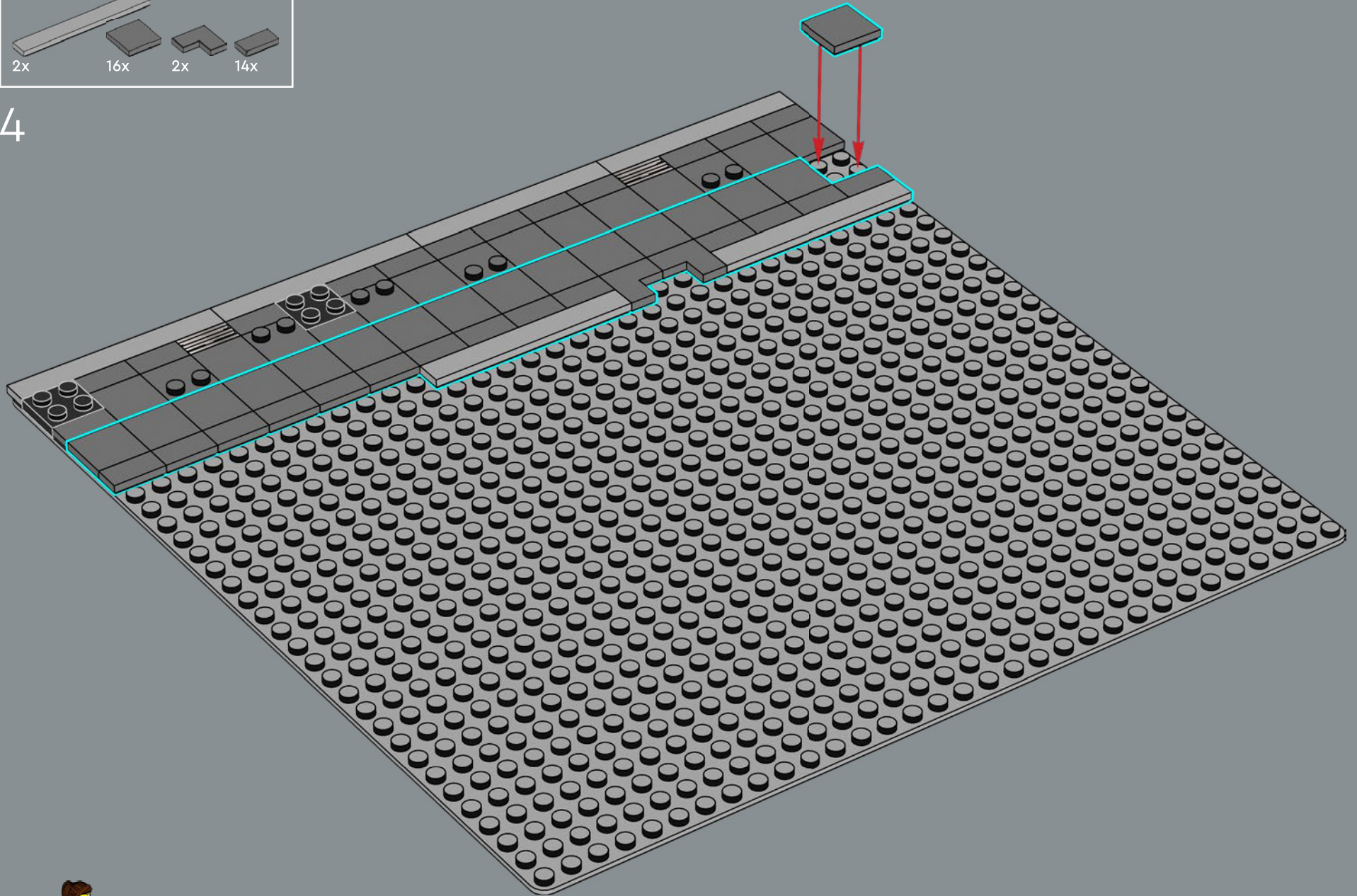

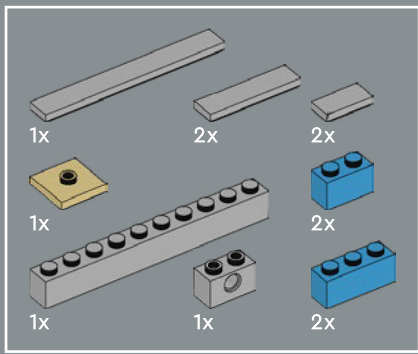

5

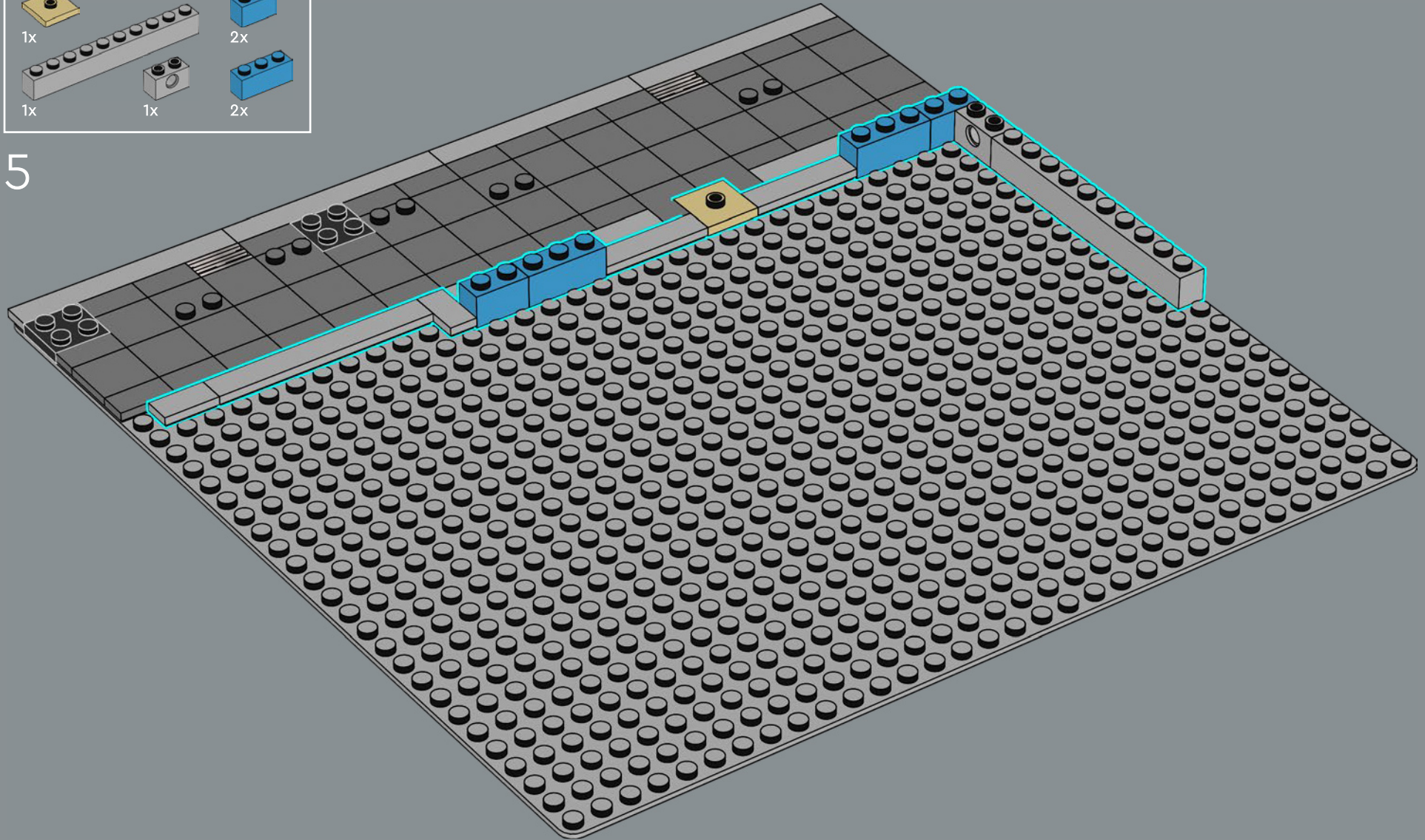

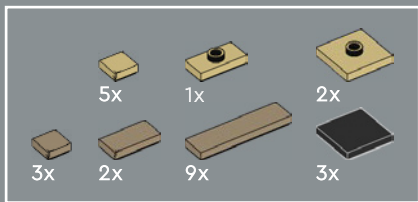

6

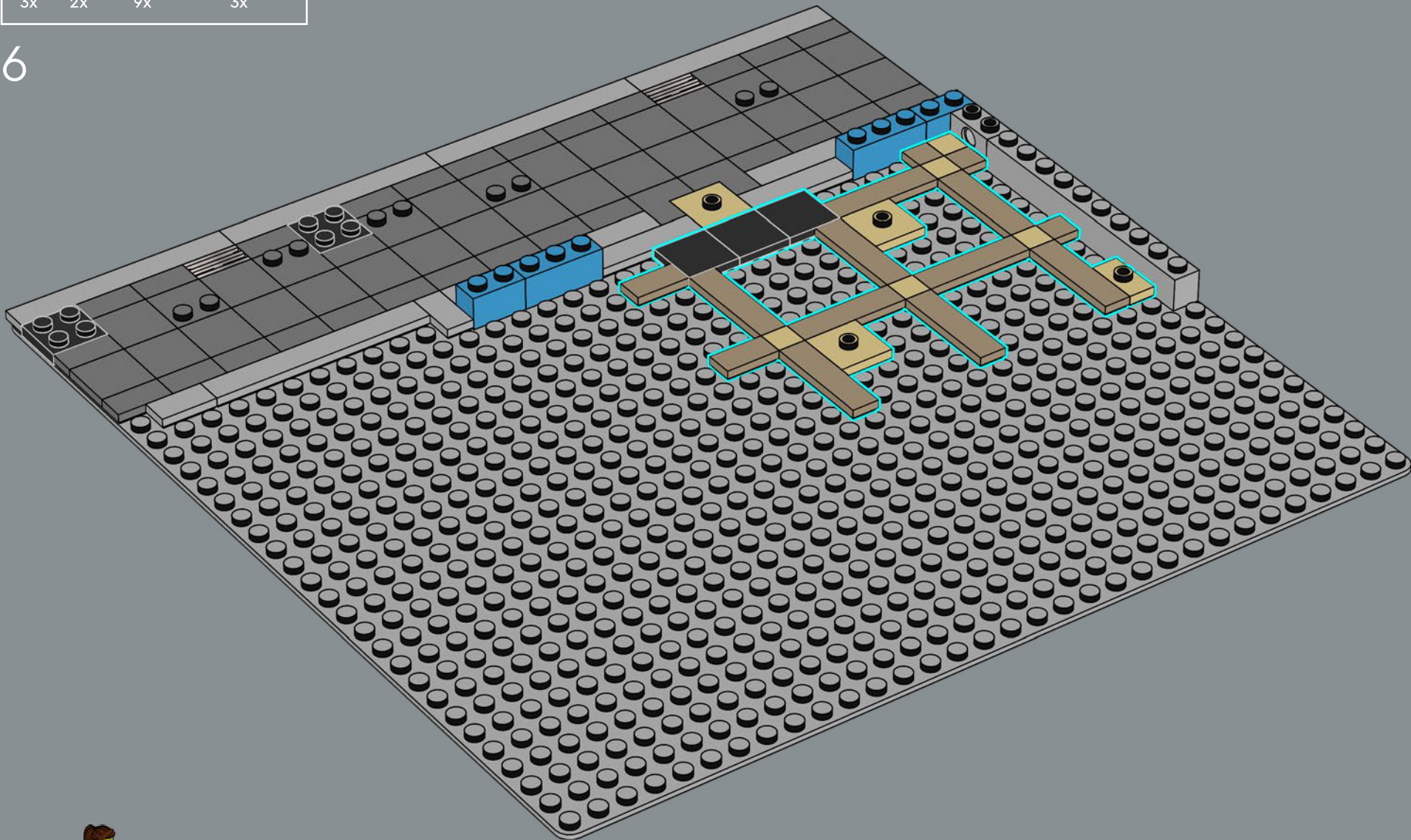

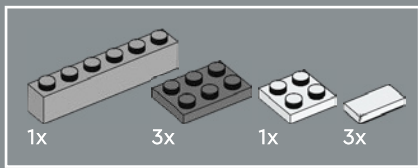

7

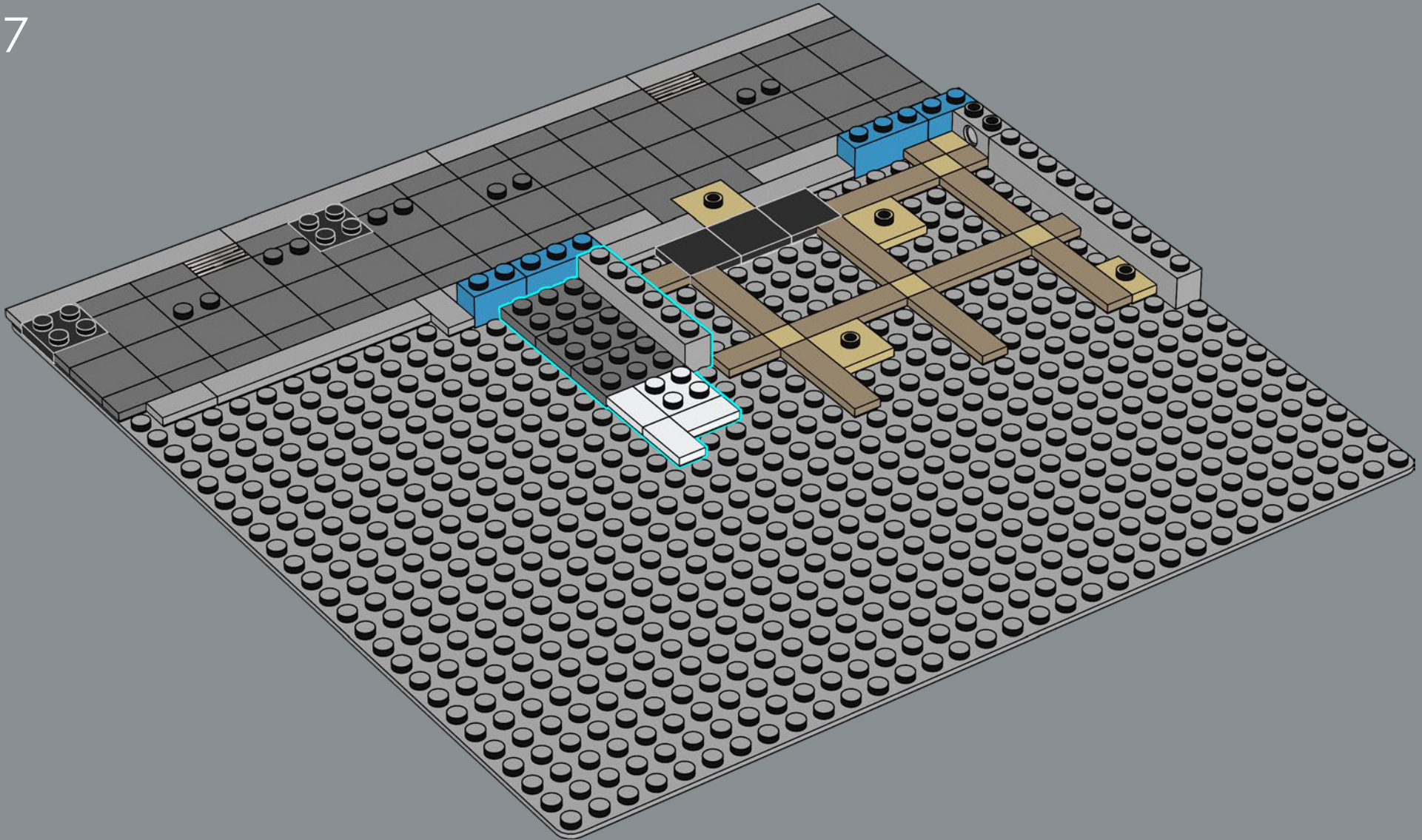

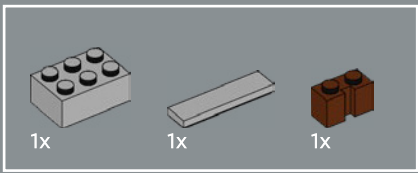

8

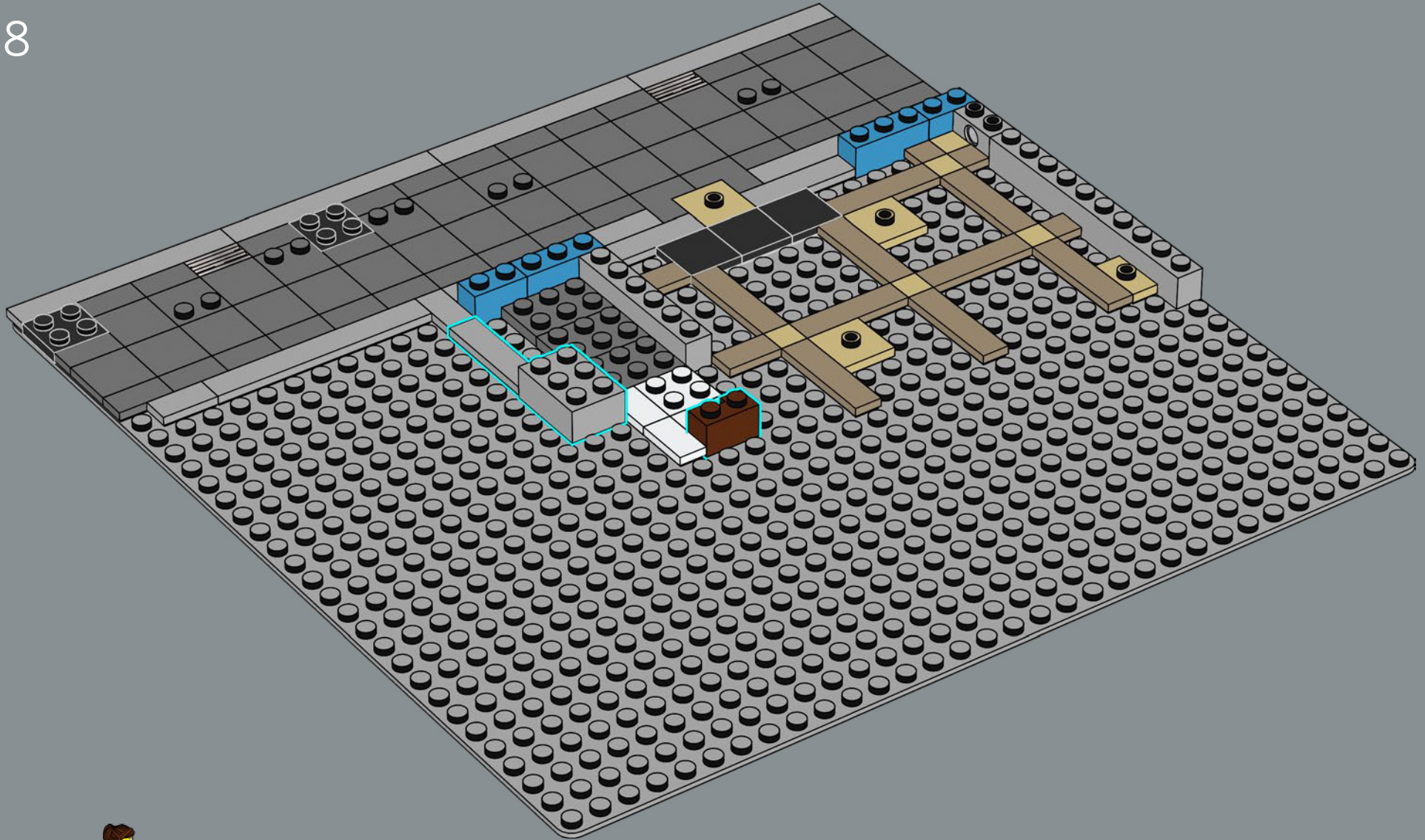

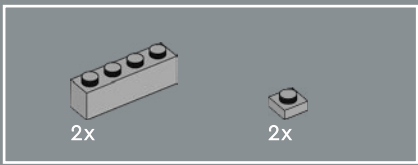

10

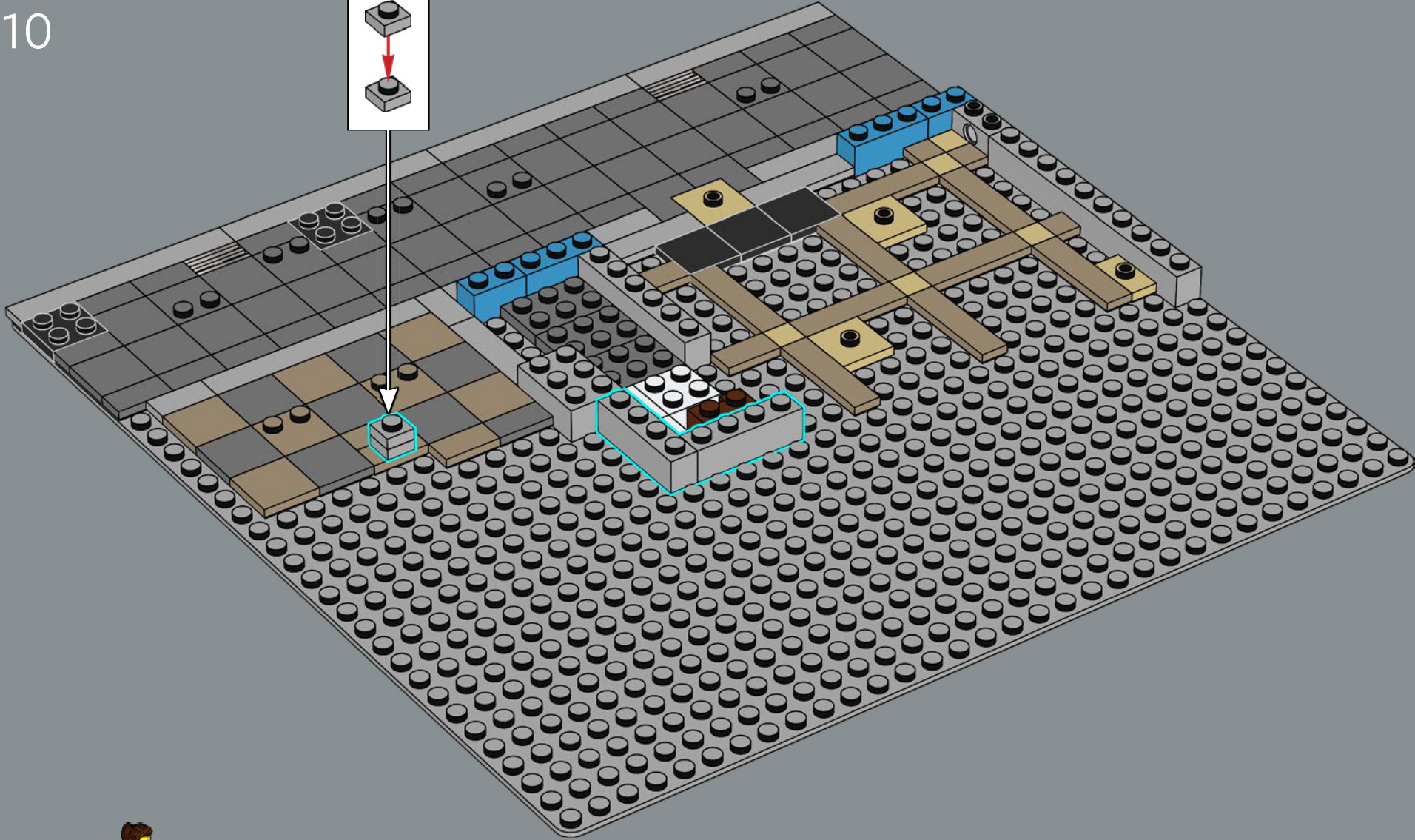
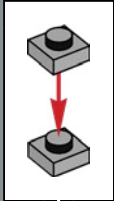

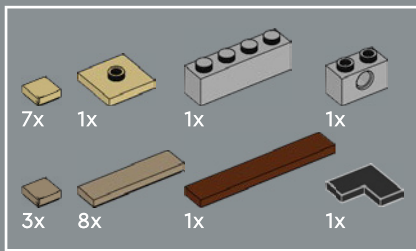

11

The placement of these elements creates a line angled at 45 degrees to the overall LEGO® grid. You'll find builds and elements oriented at 45 degrees used as a motif throughout the Jazz Club.

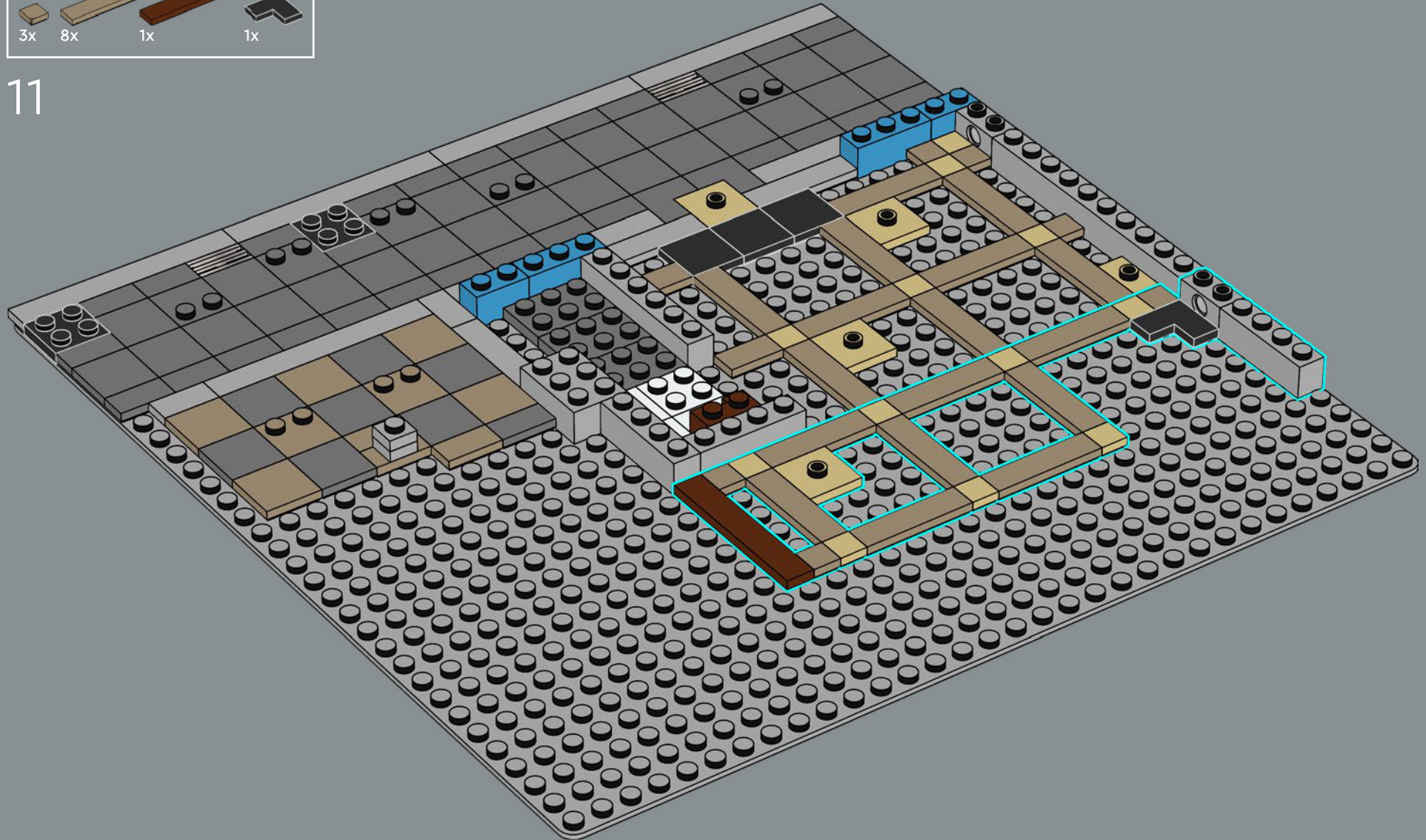

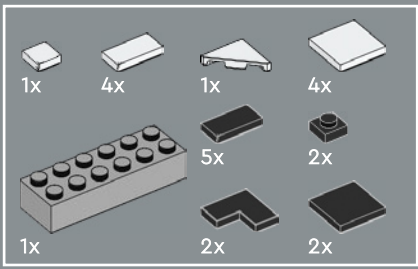

12

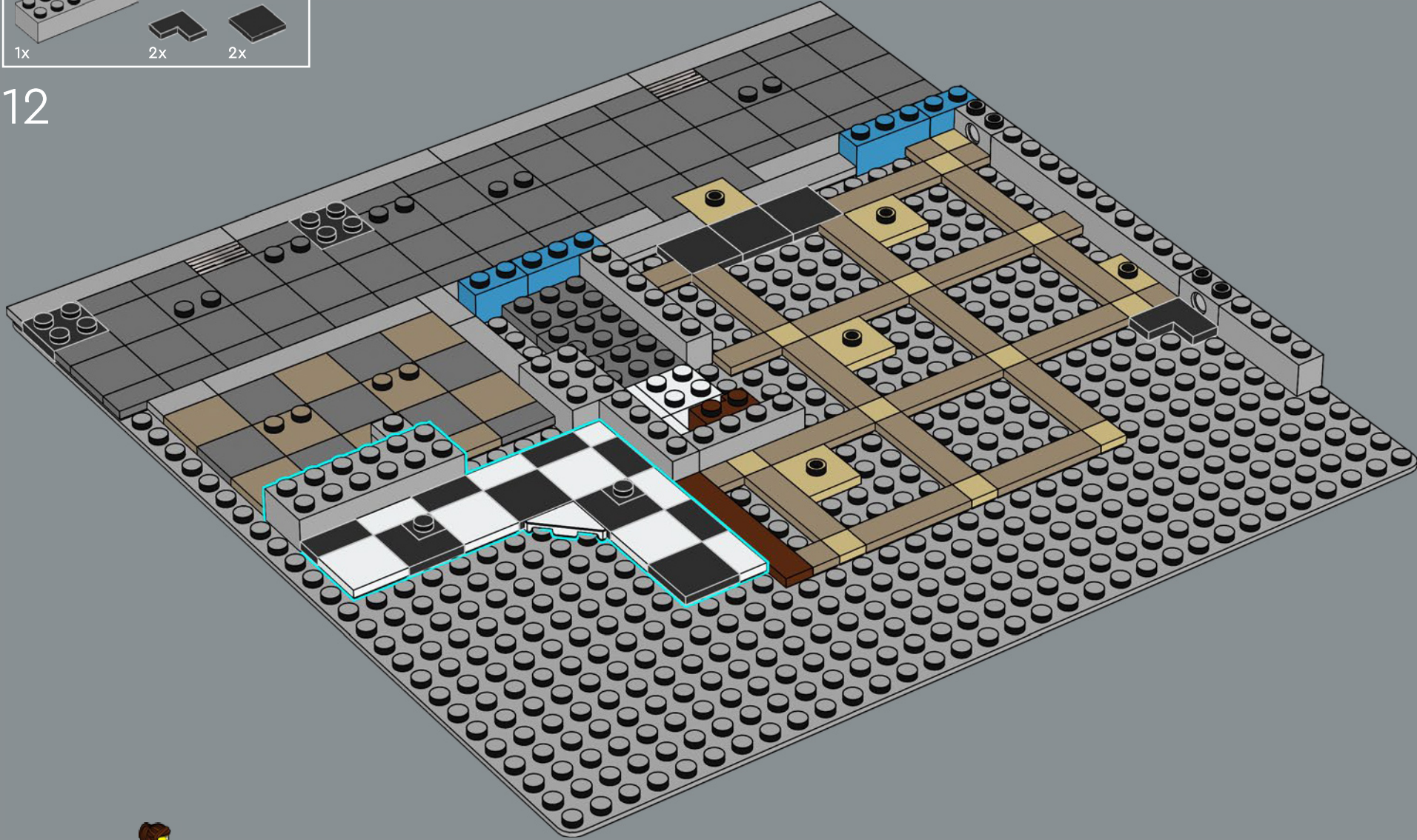

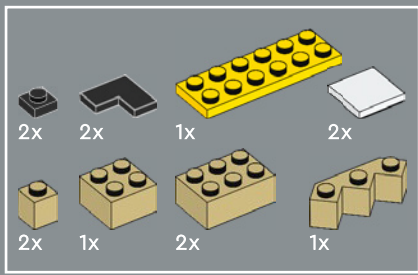

13

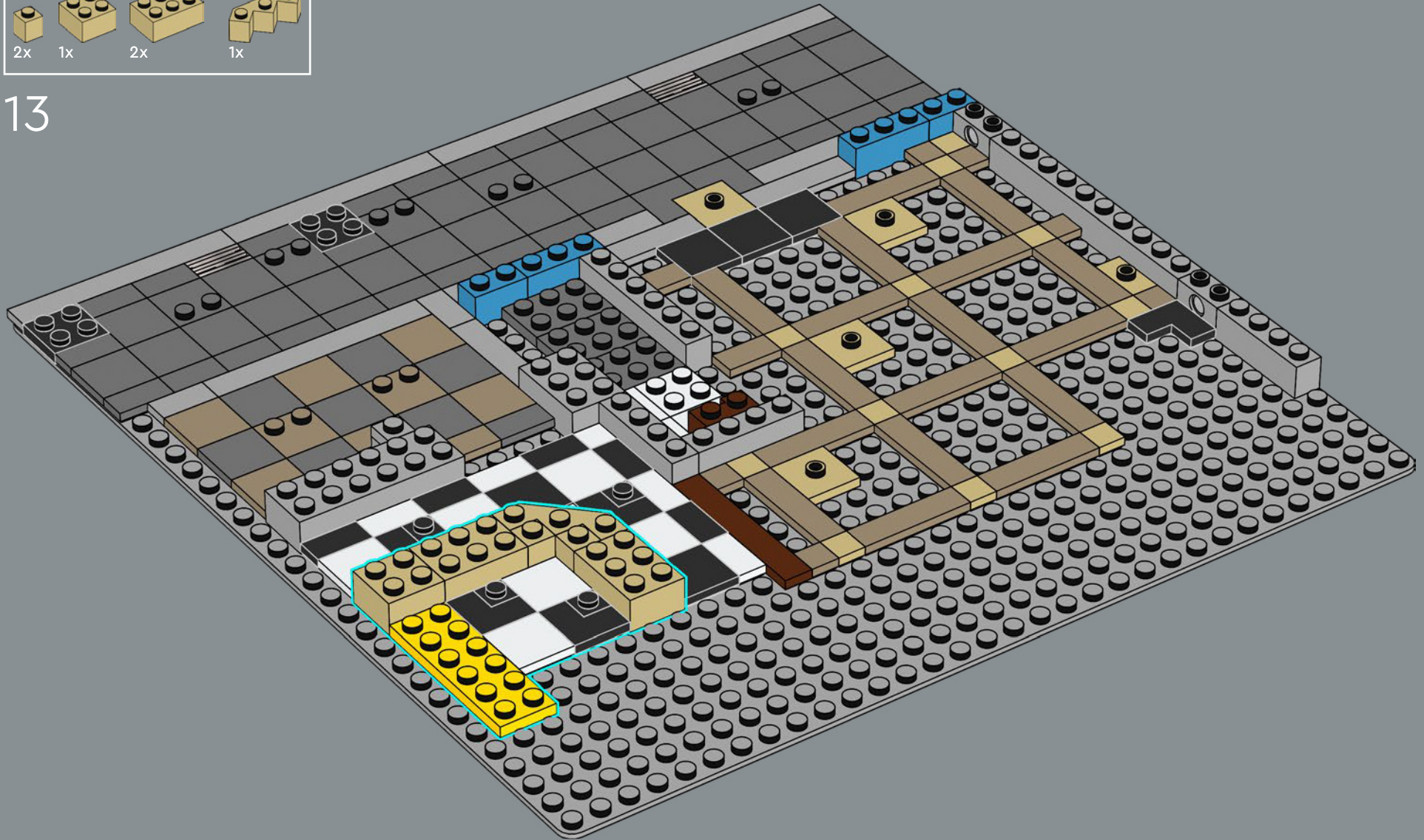

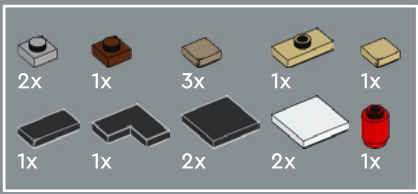

14

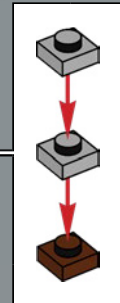
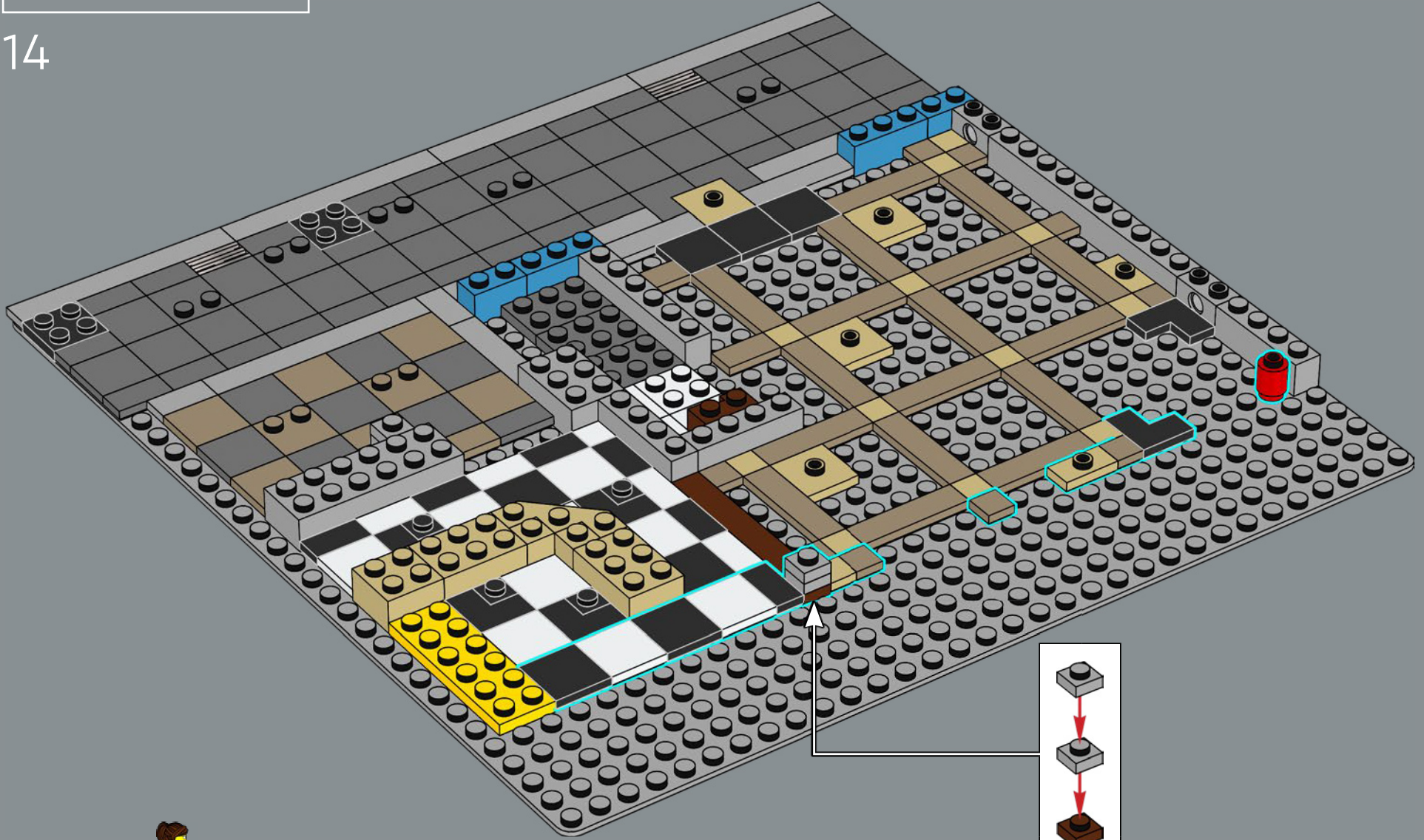

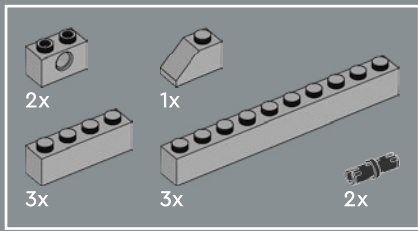

15

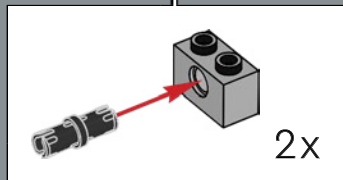
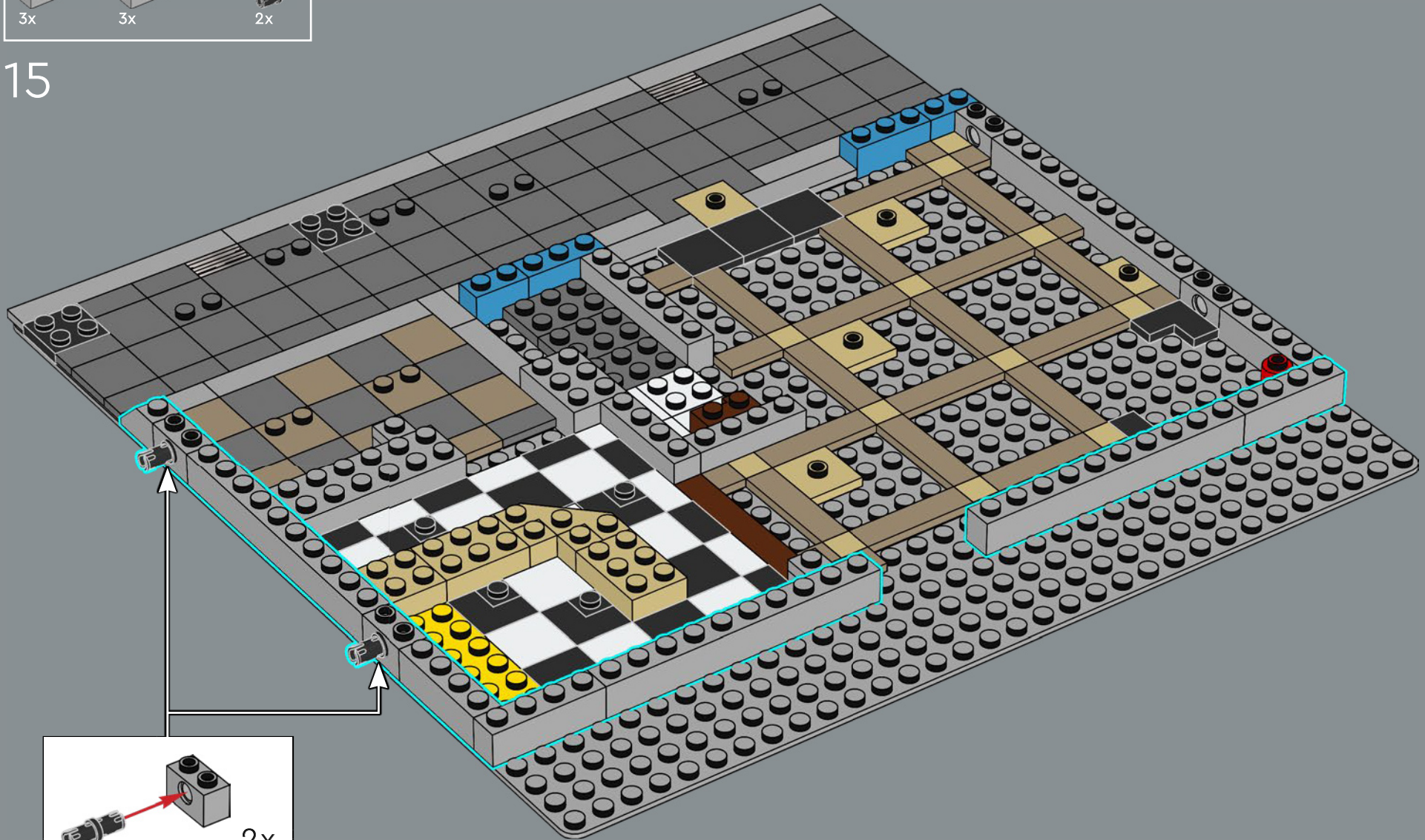

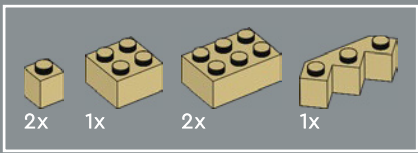

16

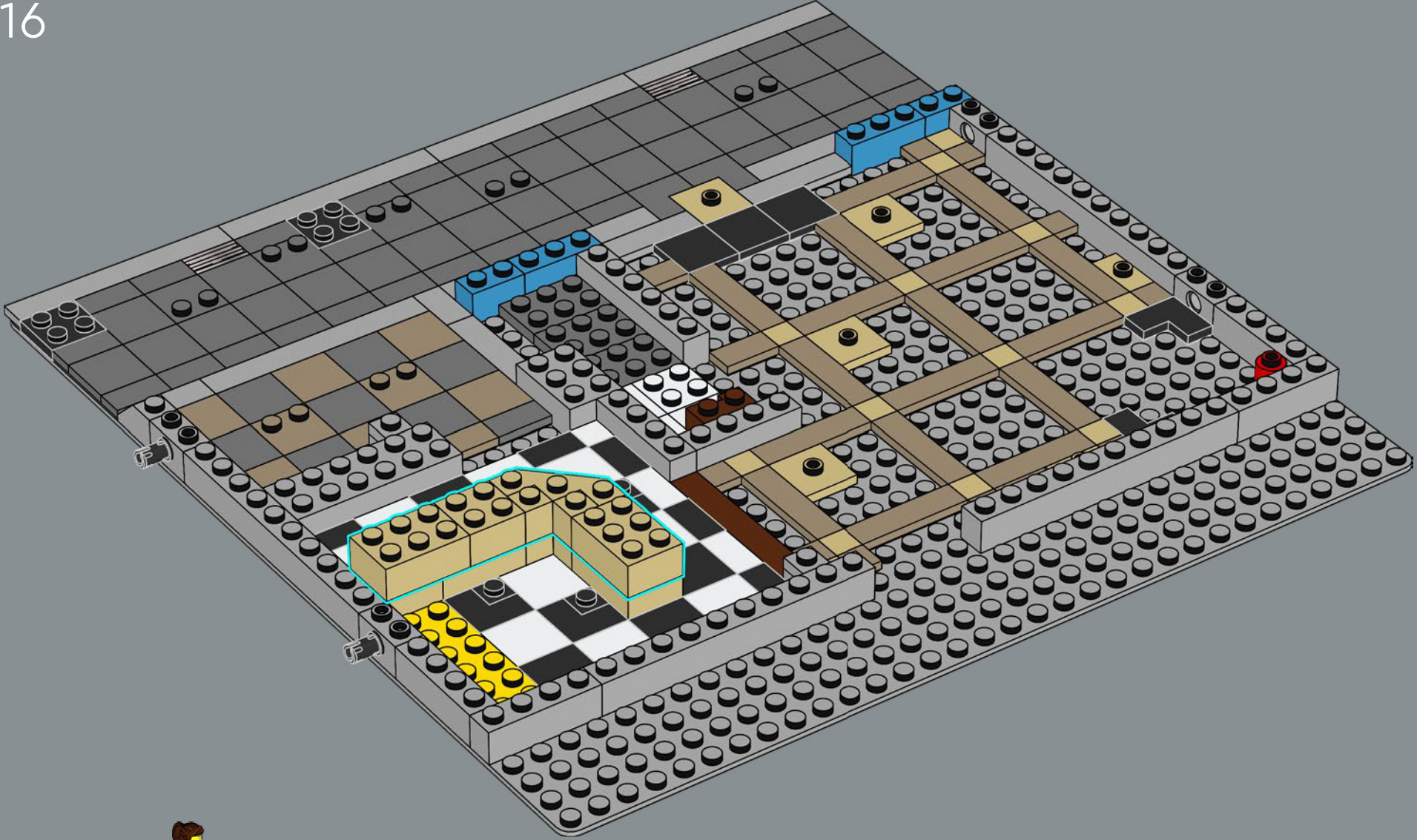



The drummer is excited to try out the new drum kit for sale at the music shop located in the LEGO® 10255 Assembly Square.

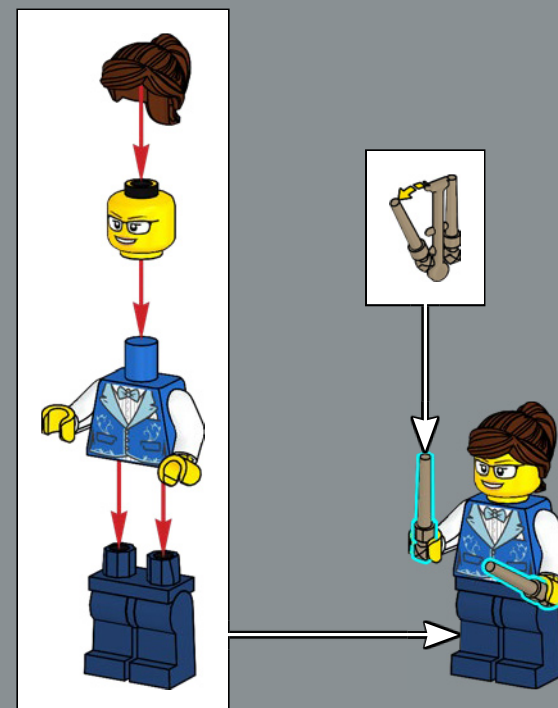

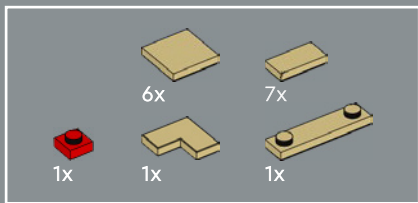

17

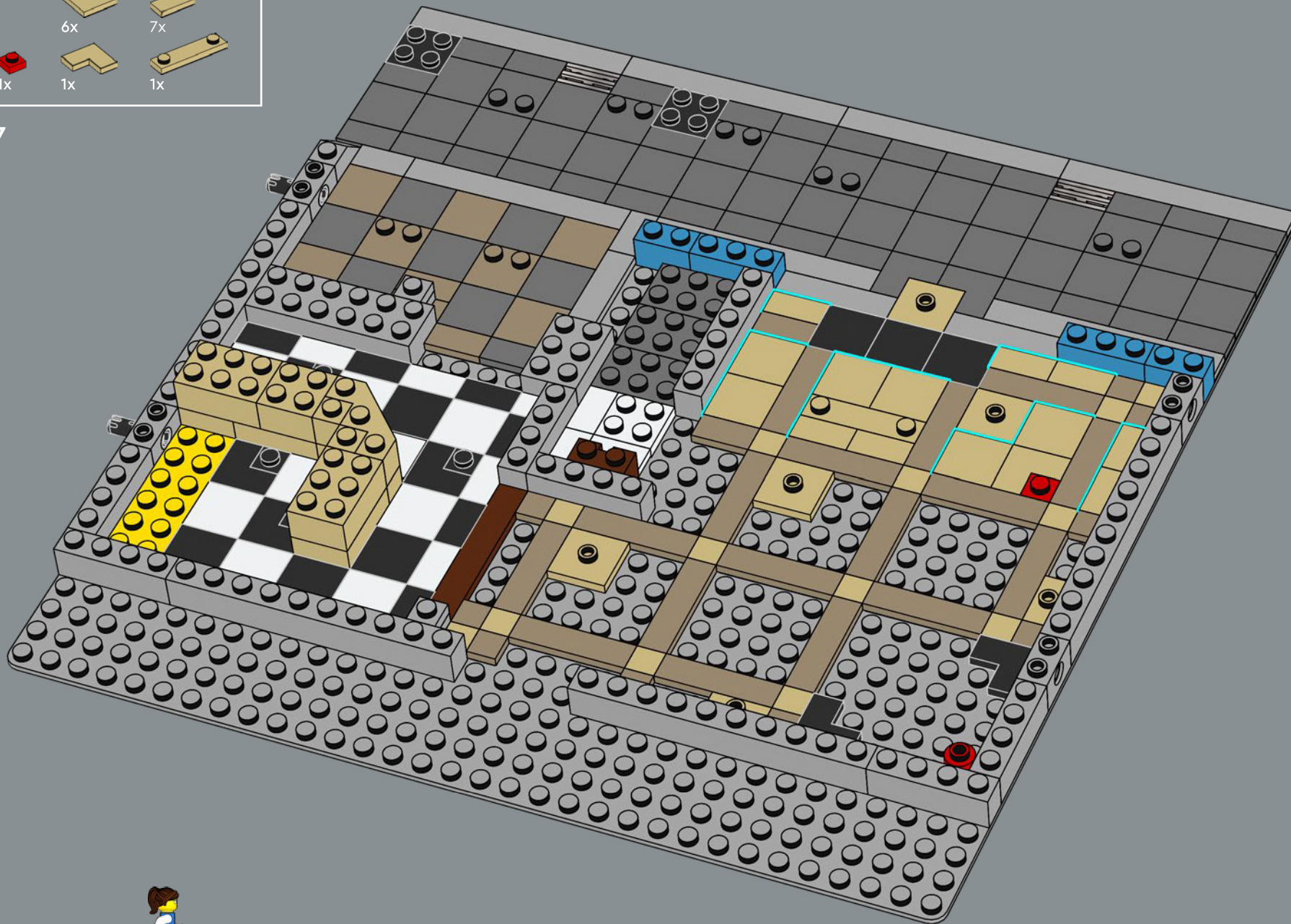

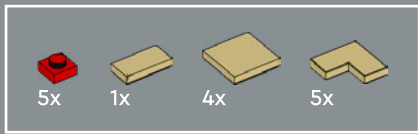

18

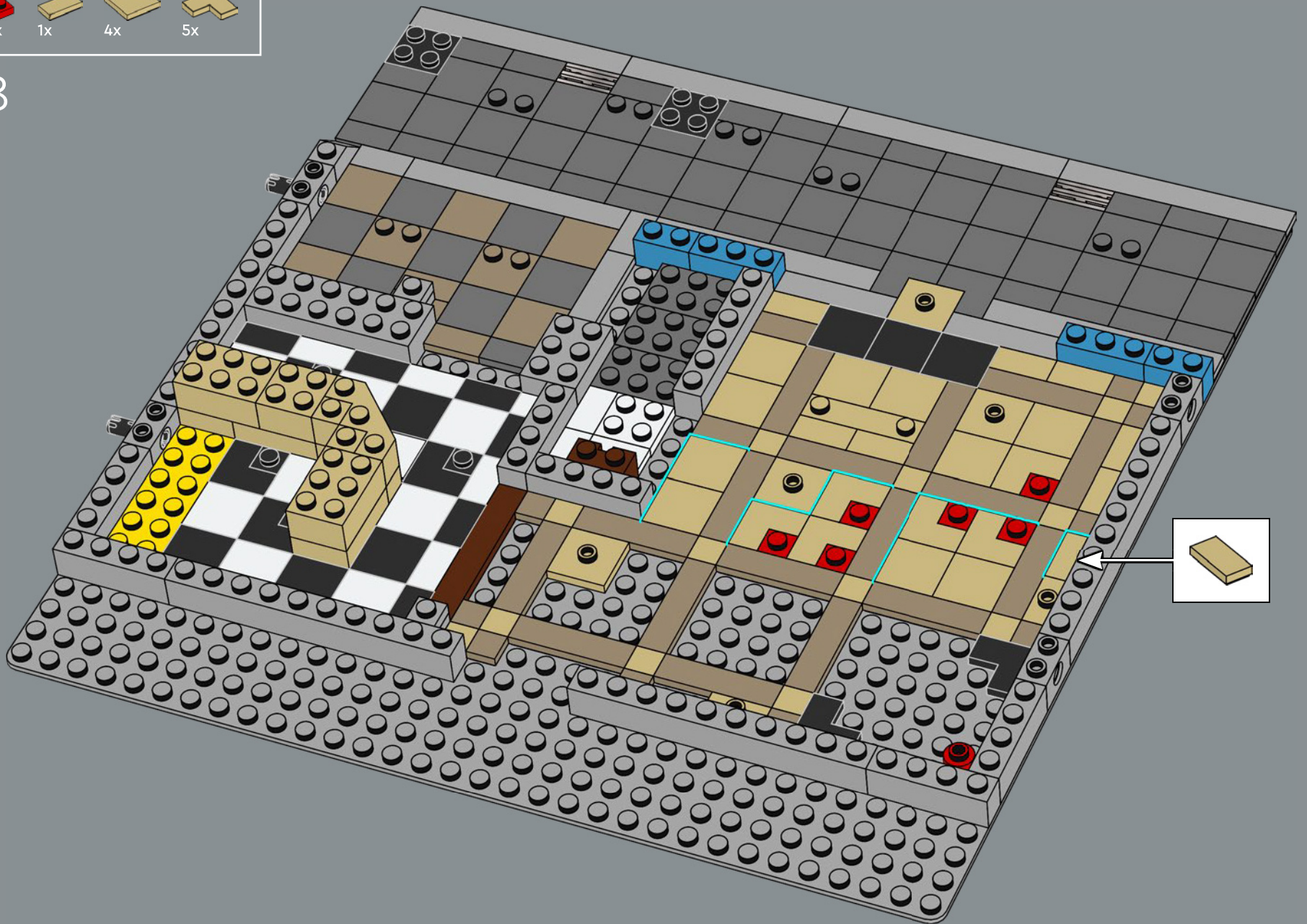

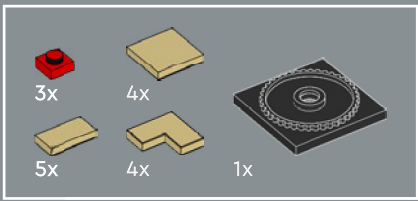

19

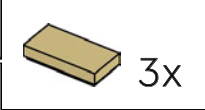
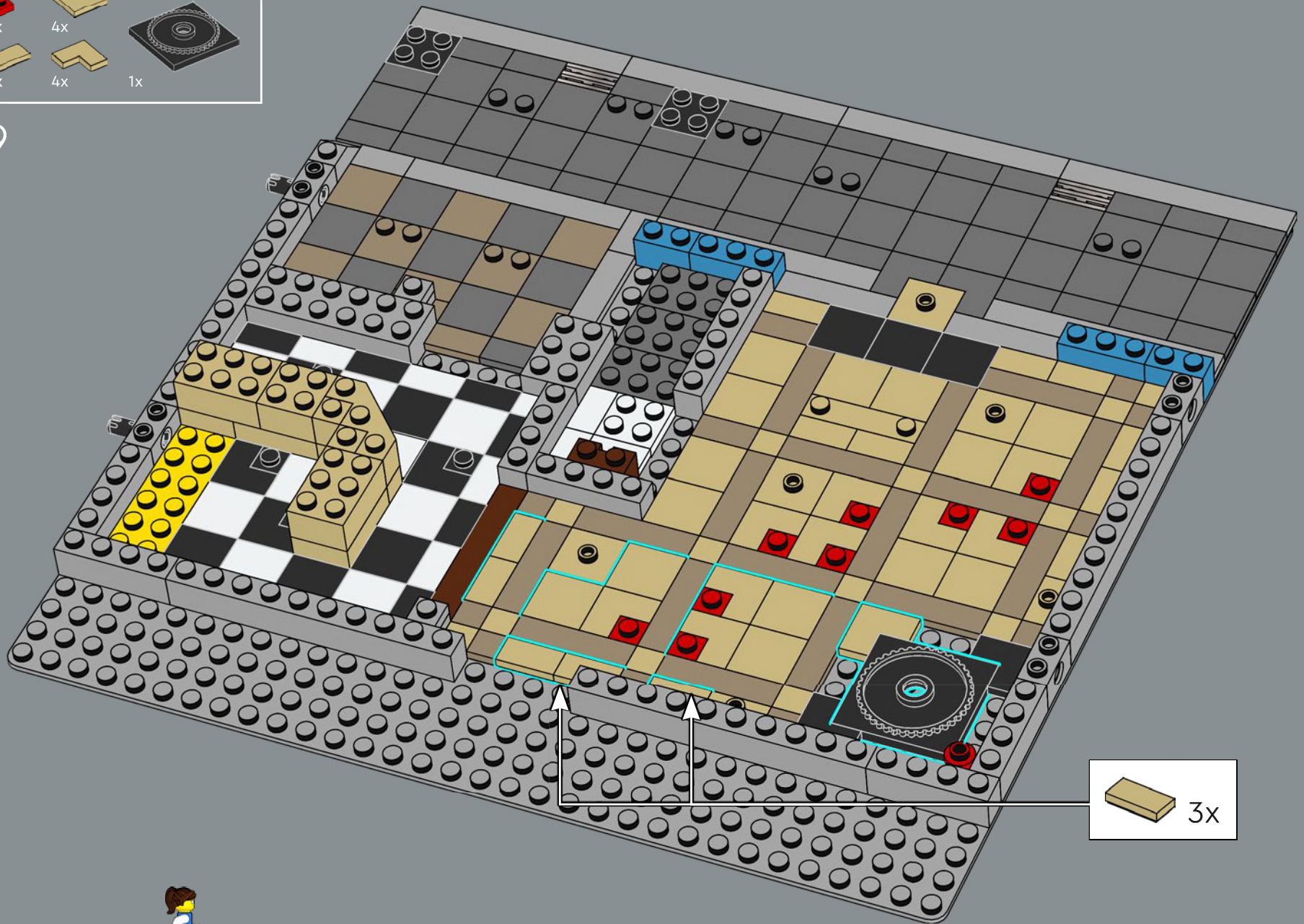

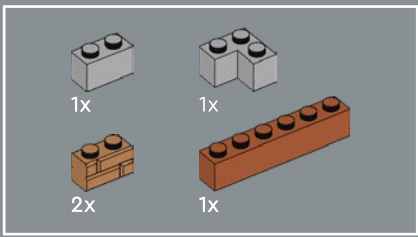

21

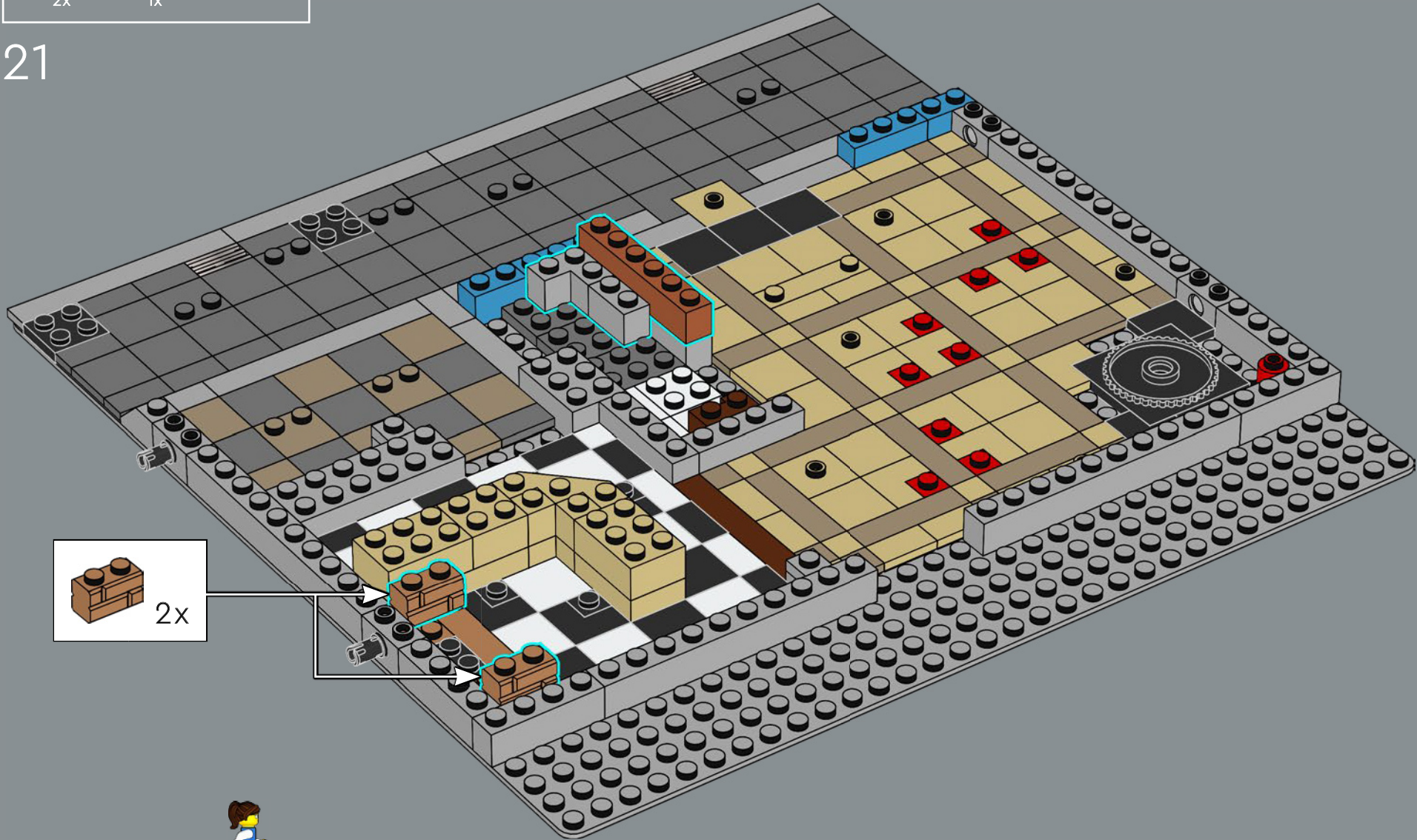

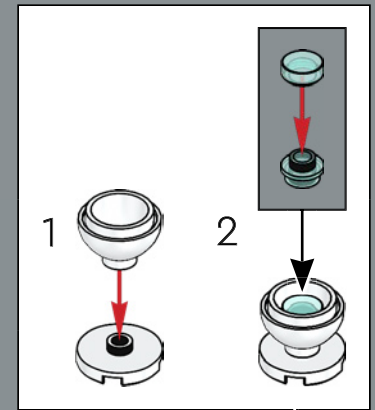
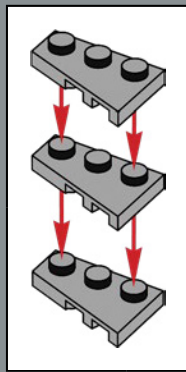
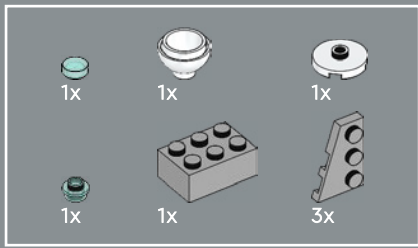

22

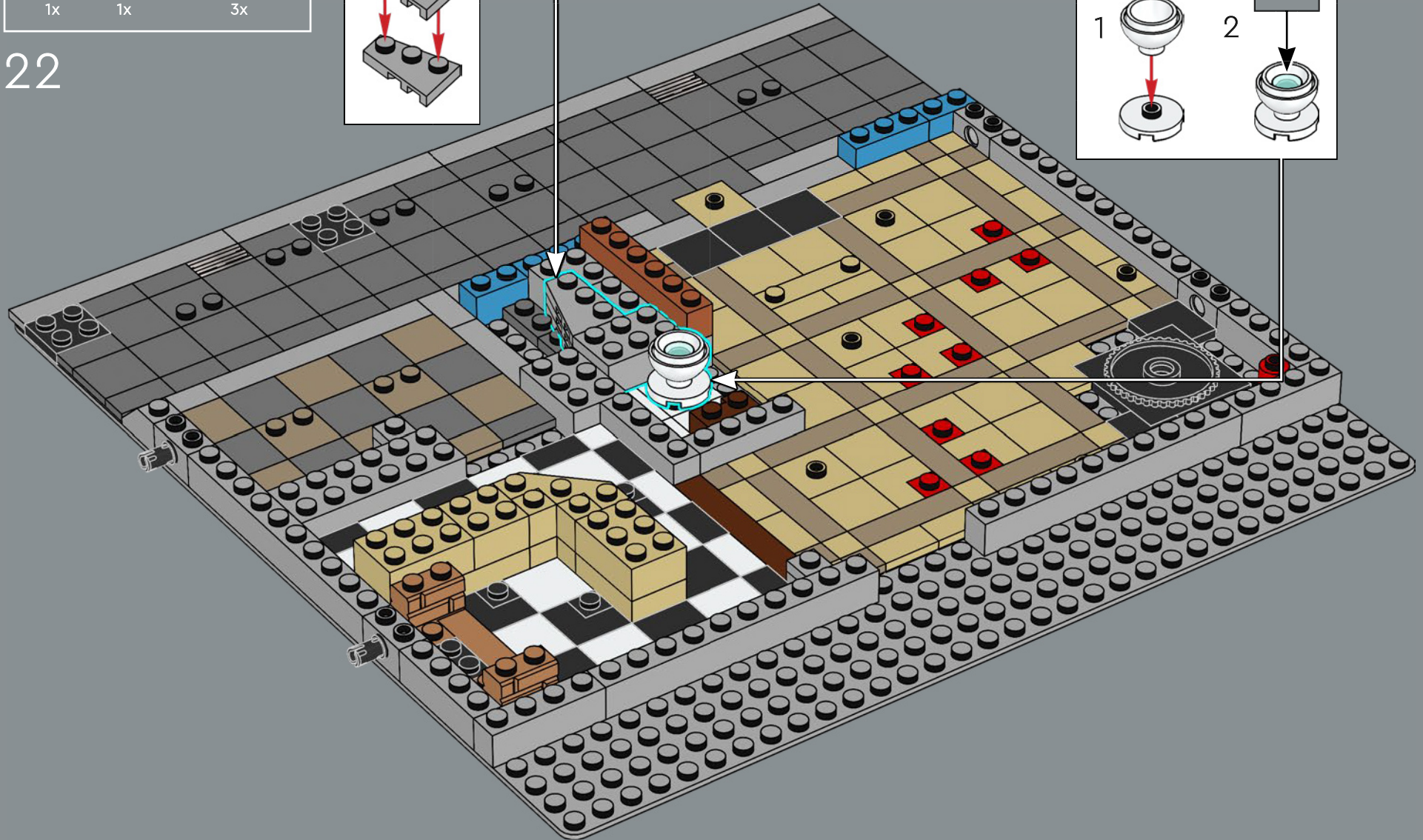

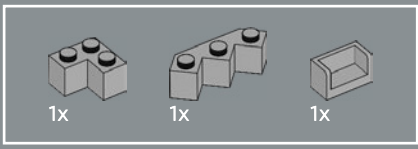

23

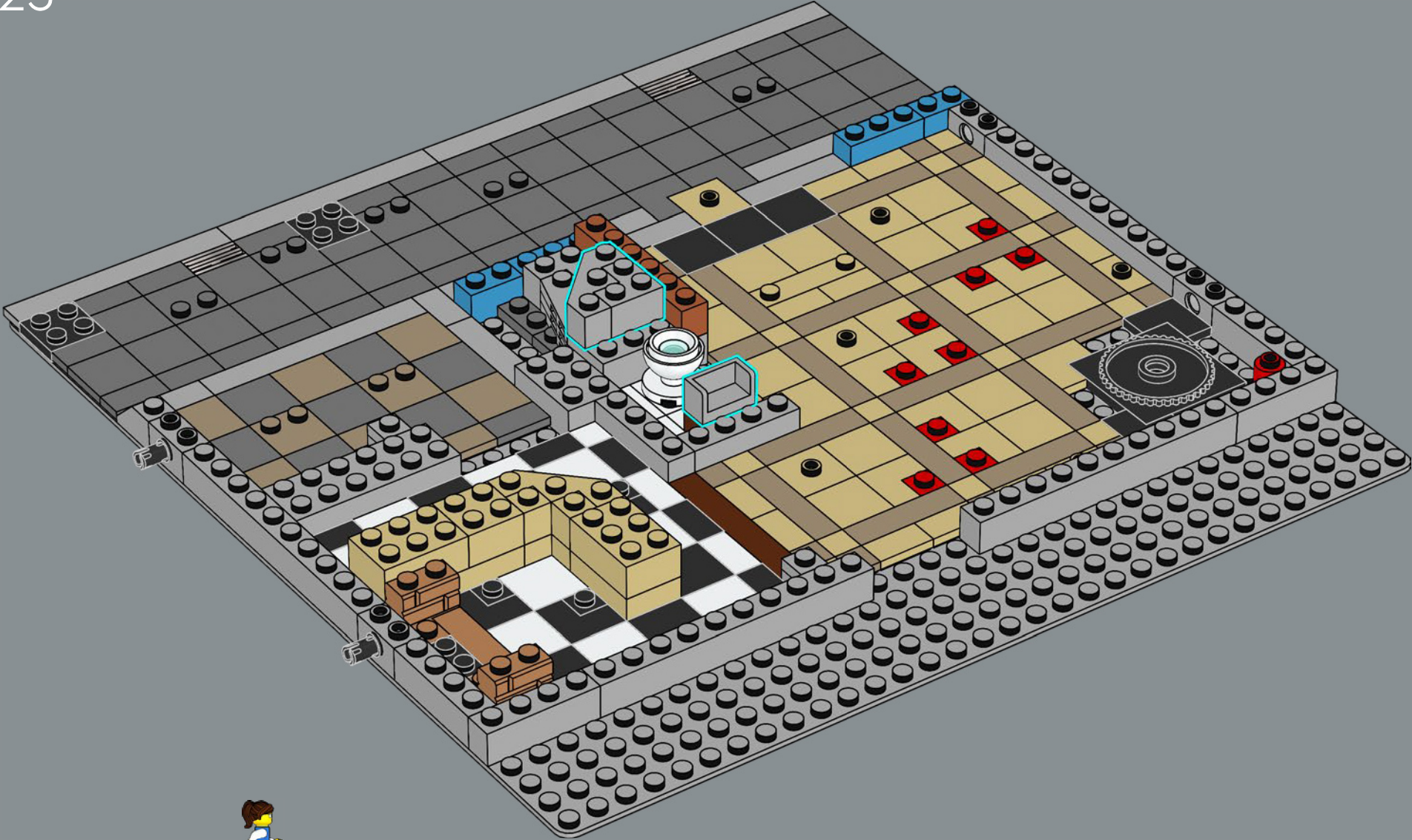

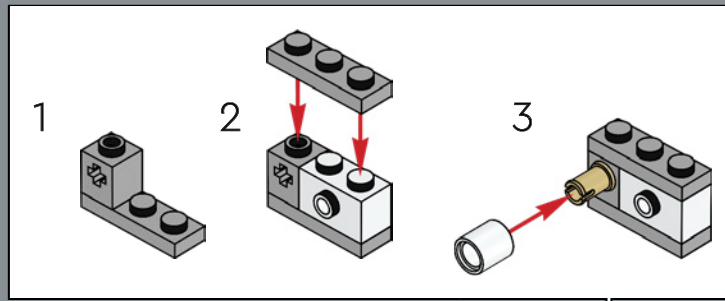
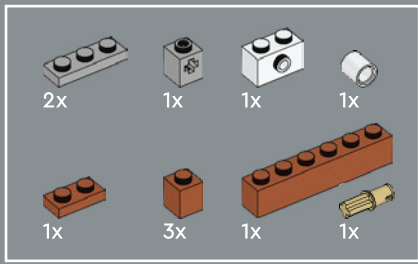

24

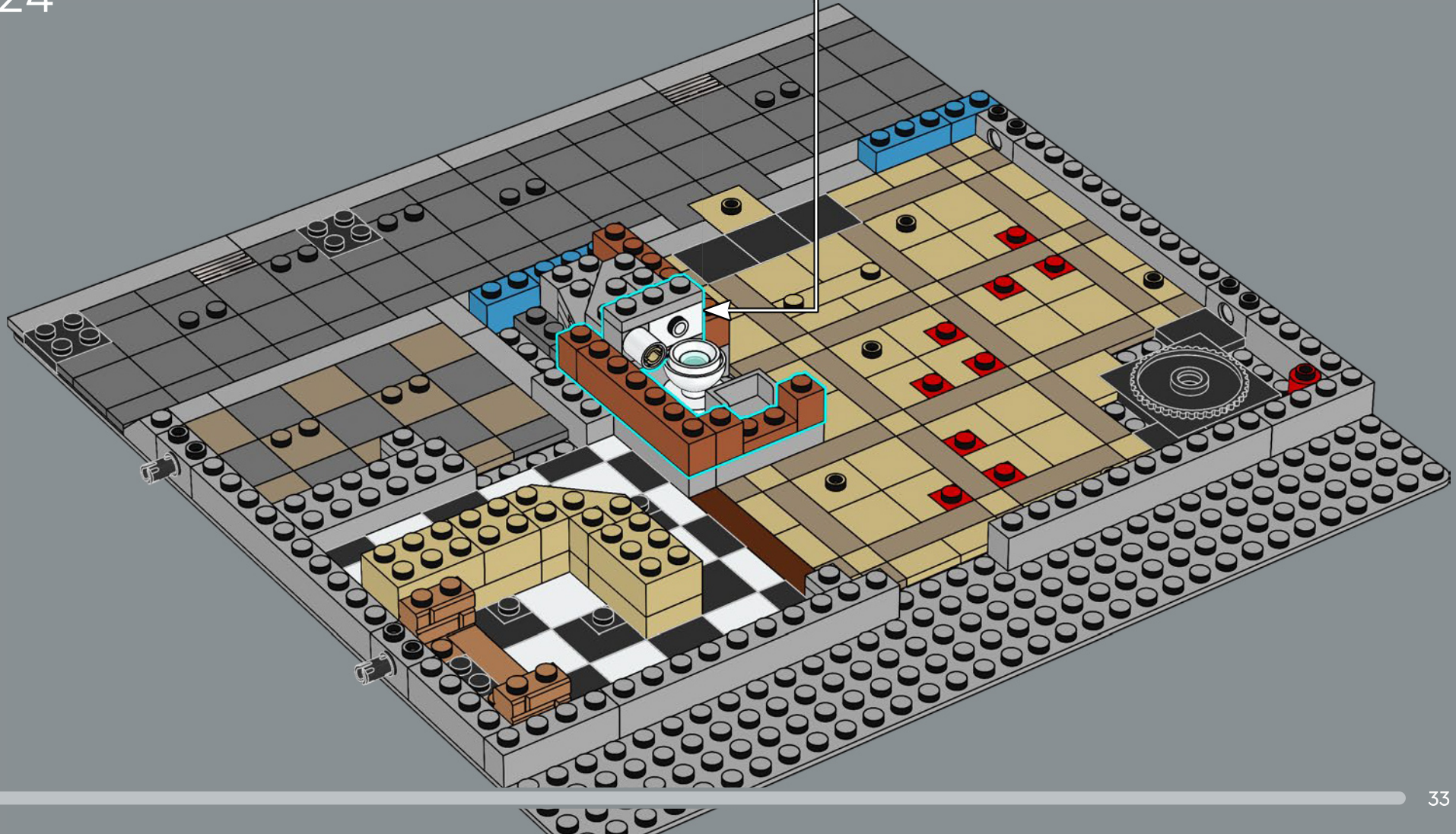

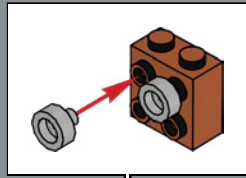
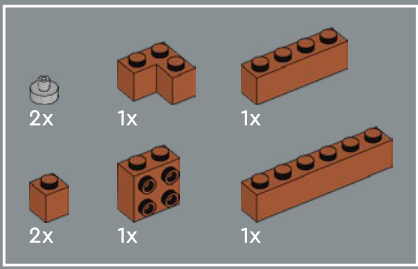

25

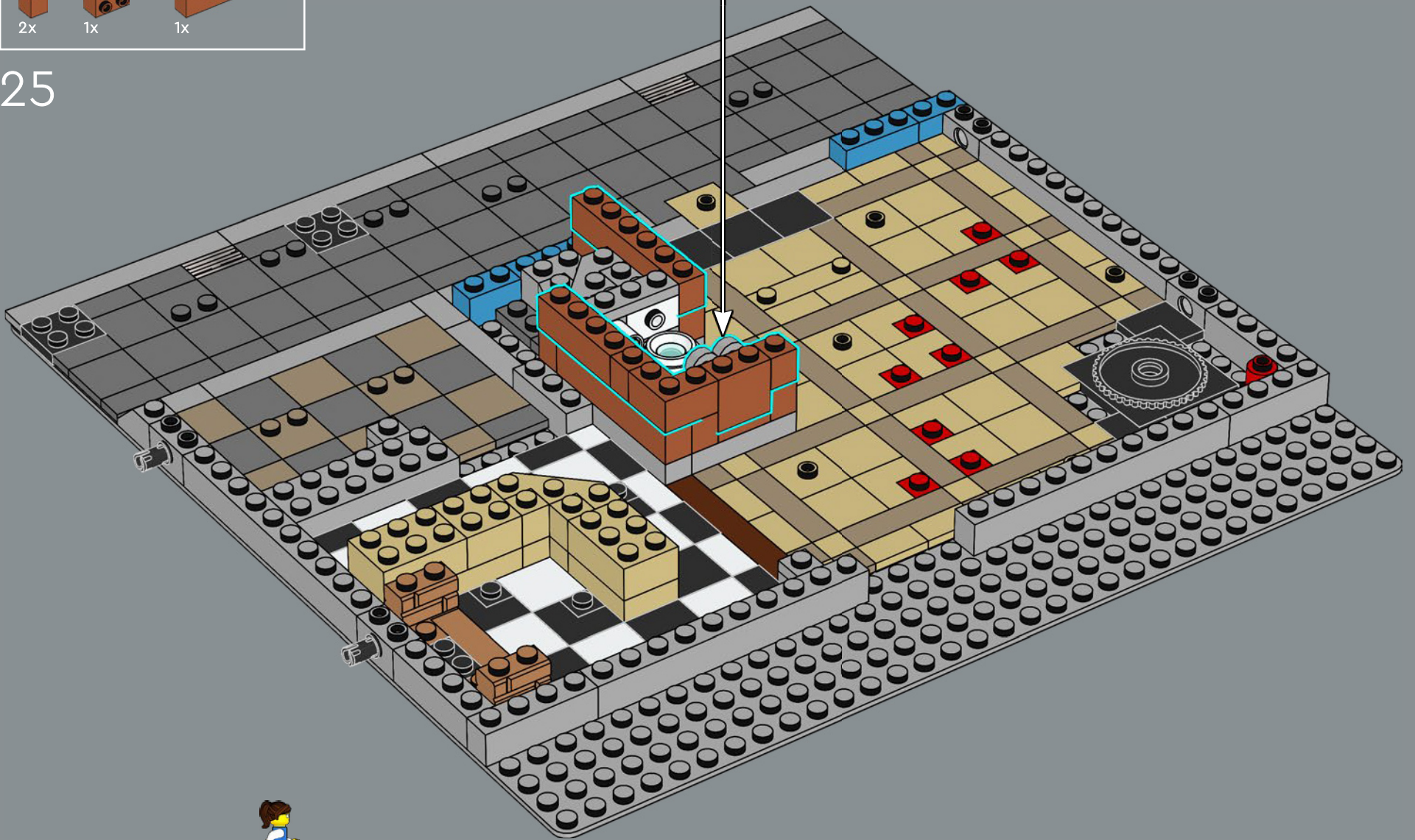

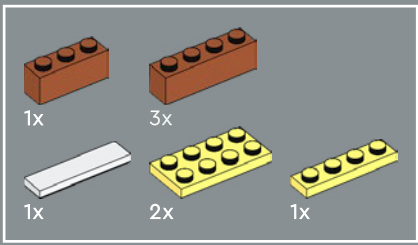

27

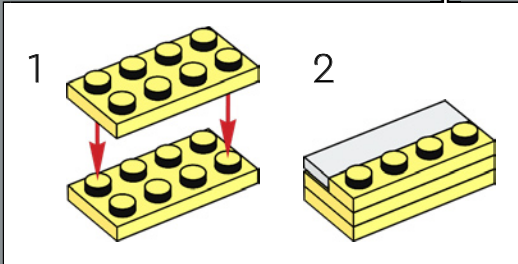
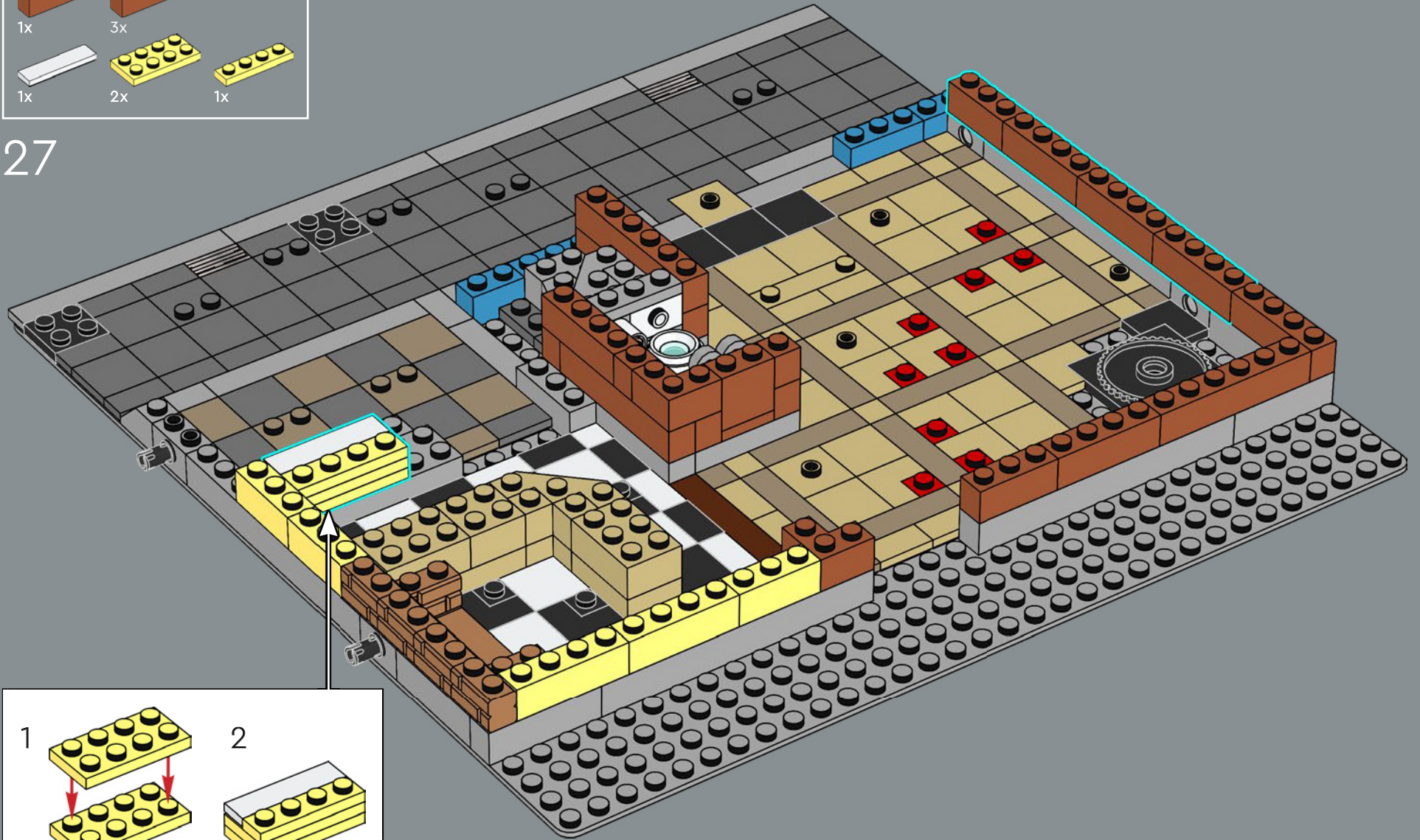

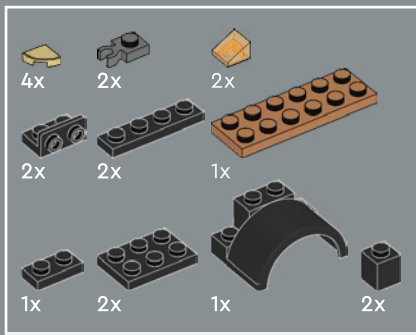

28

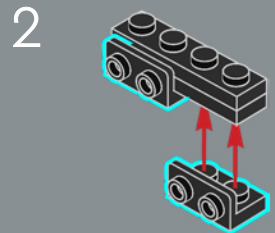
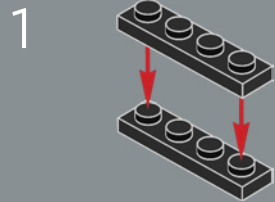

3

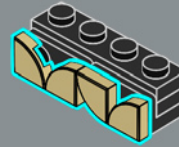

4

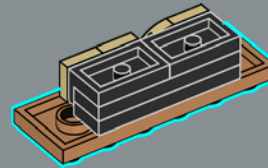

5

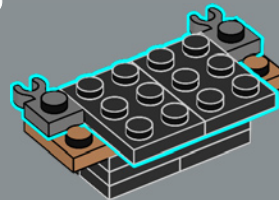

6

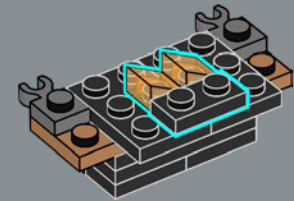

7

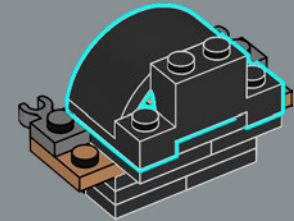

8

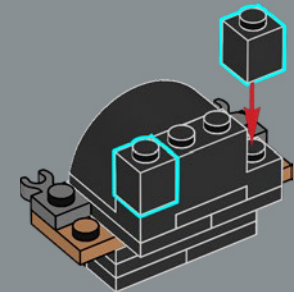

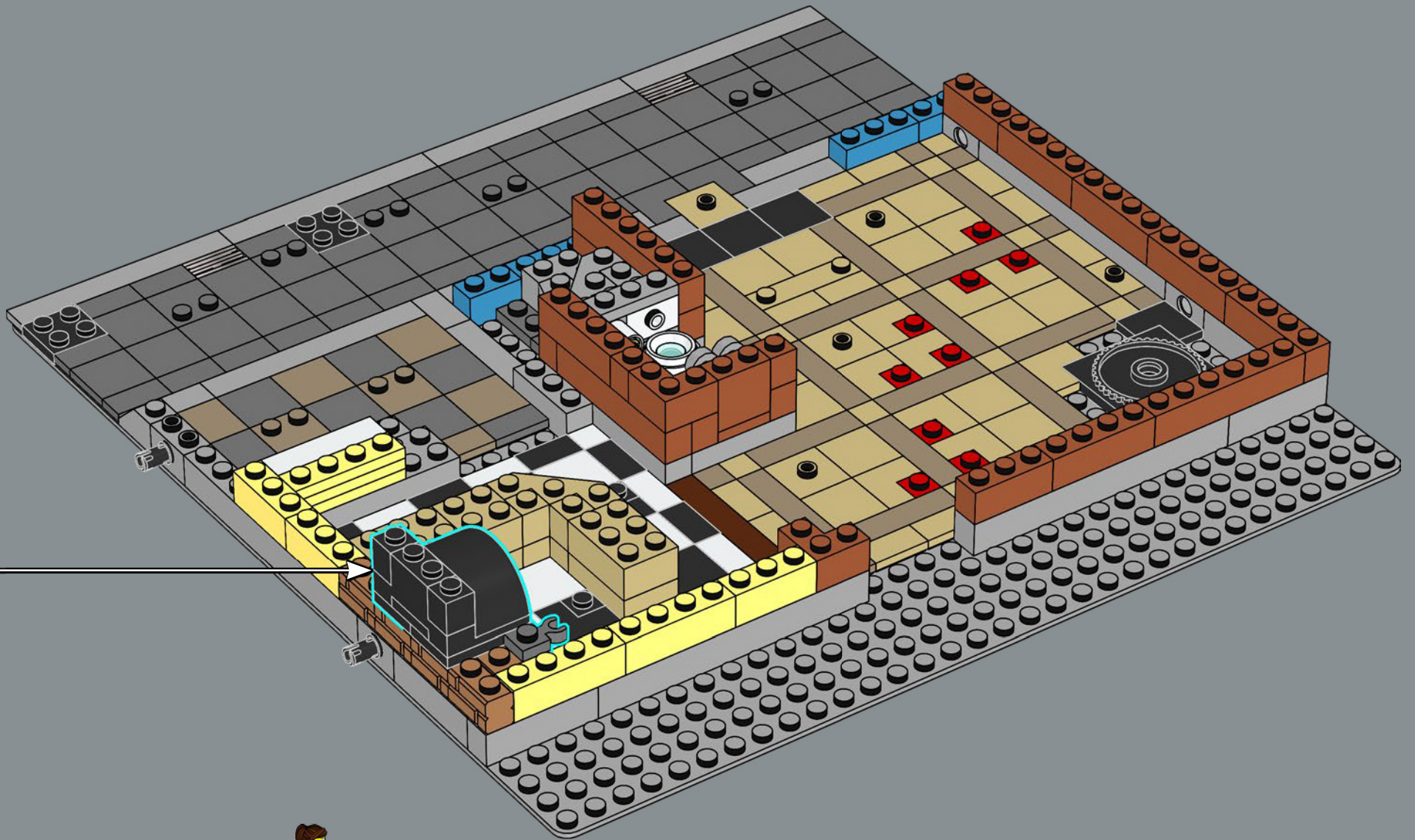

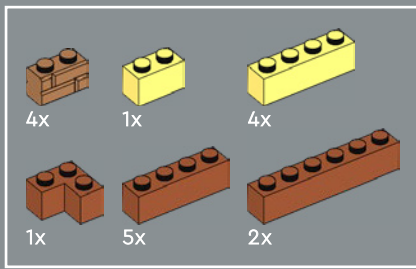

29

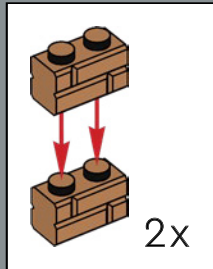
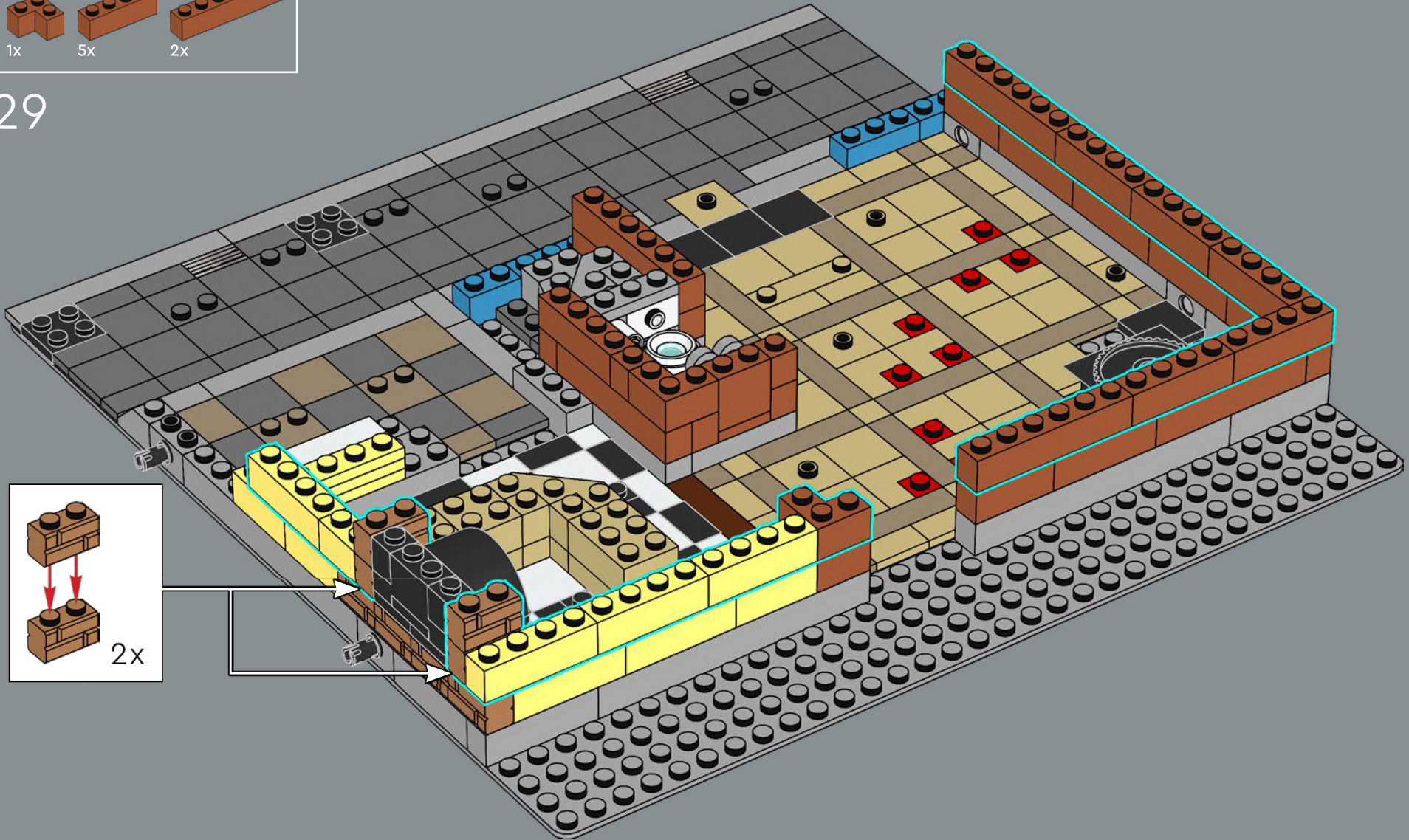

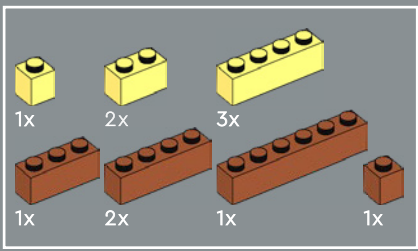

30

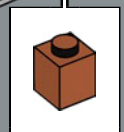
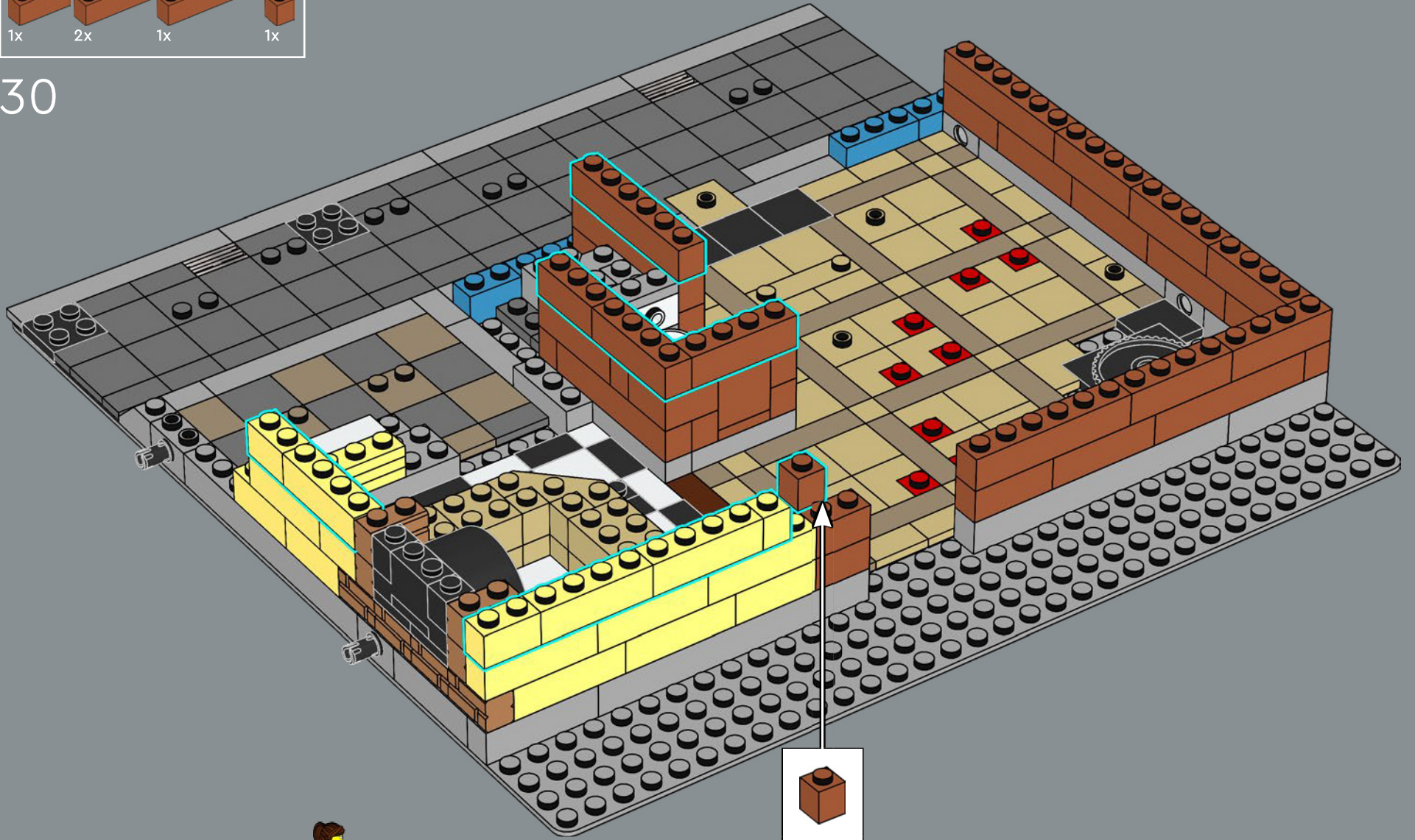

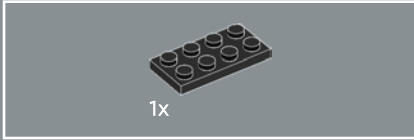

31

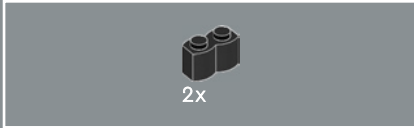
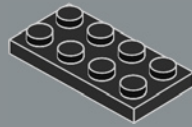

32

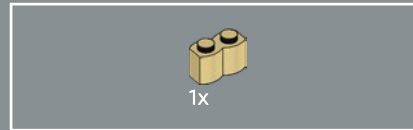
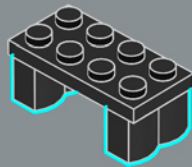

33

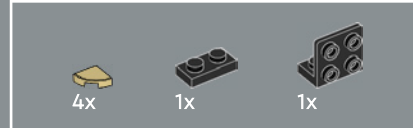
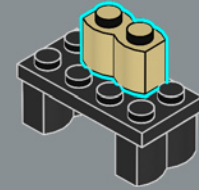

34

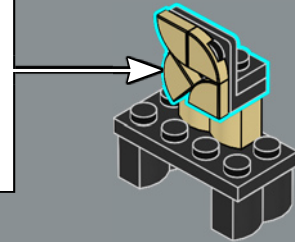
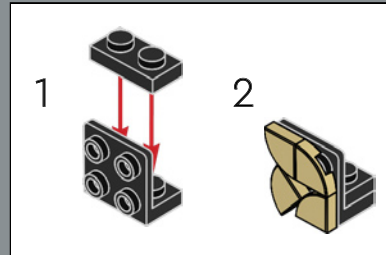

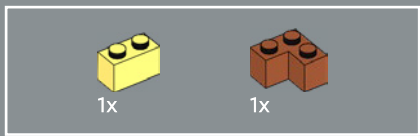

35

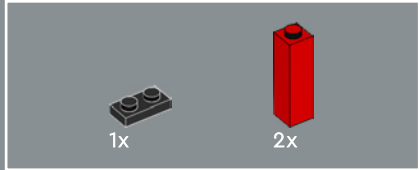
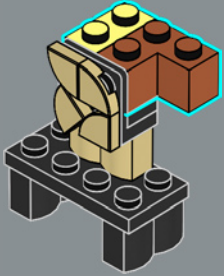

36

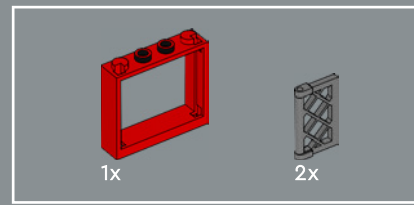
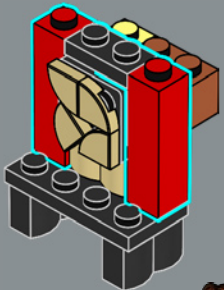

37

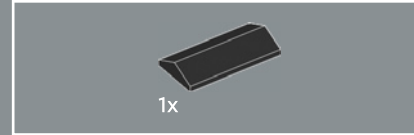
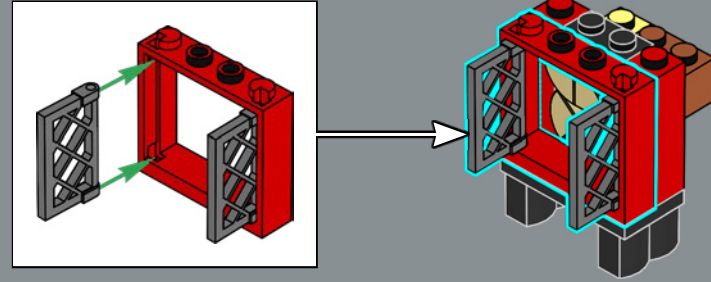

38

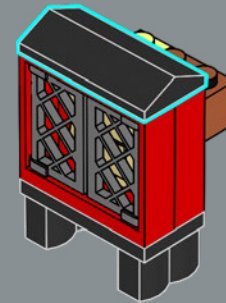



The wood-fired pizza oven is heated up and ready to use. You can find extra wood behind the building.

39

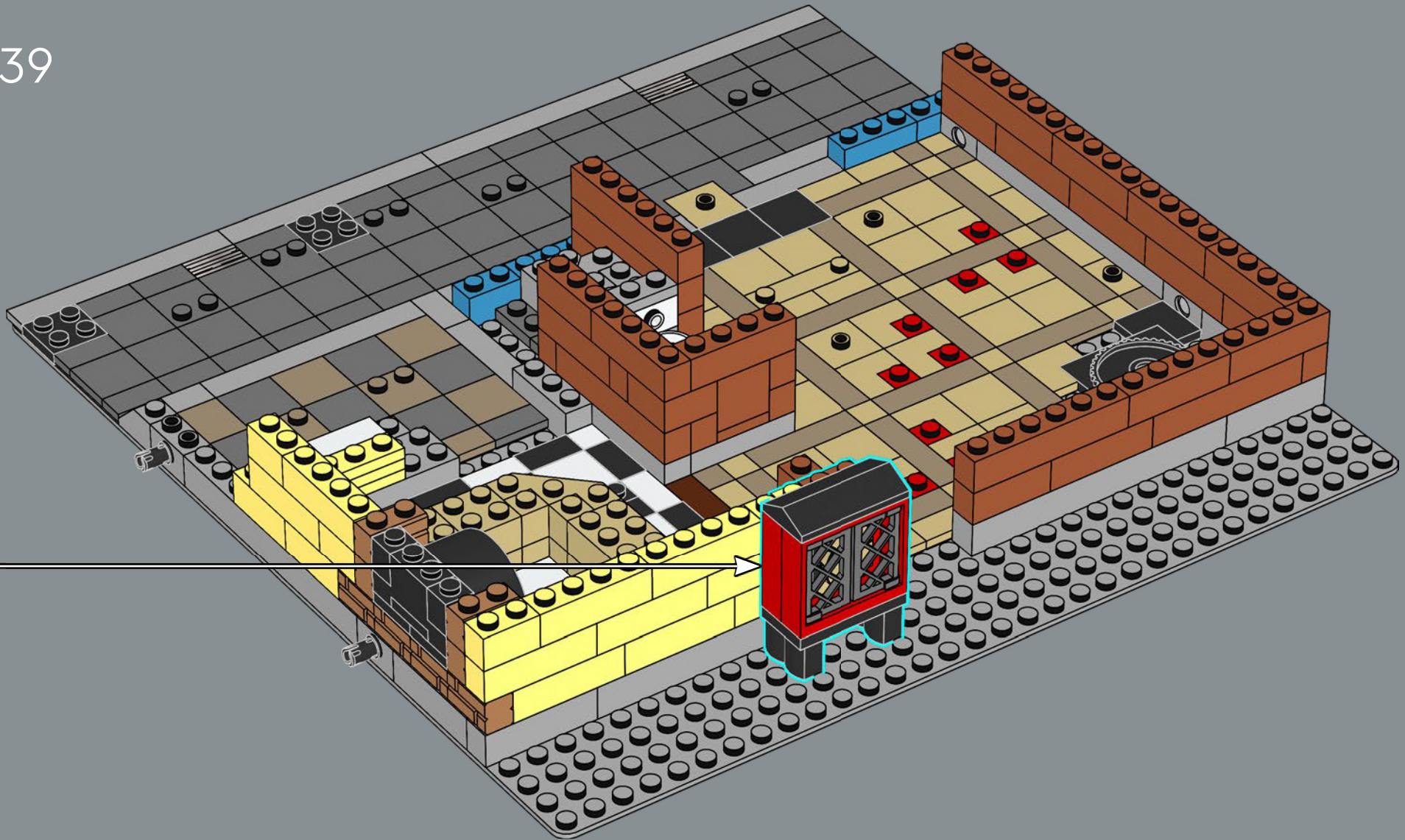

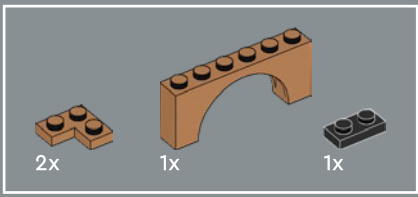

40

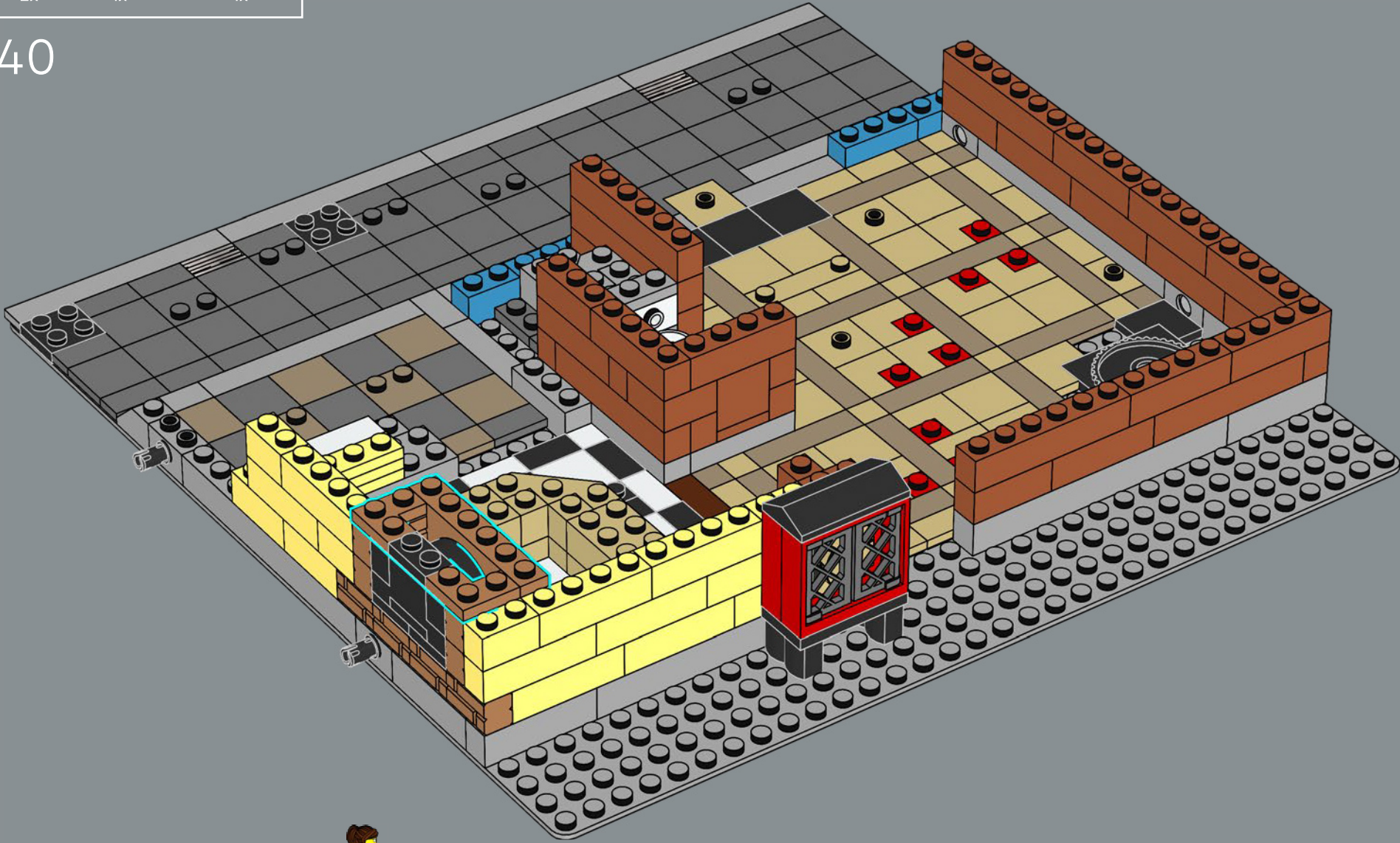

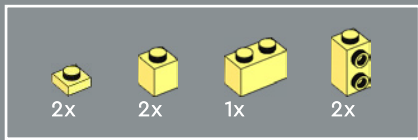

41

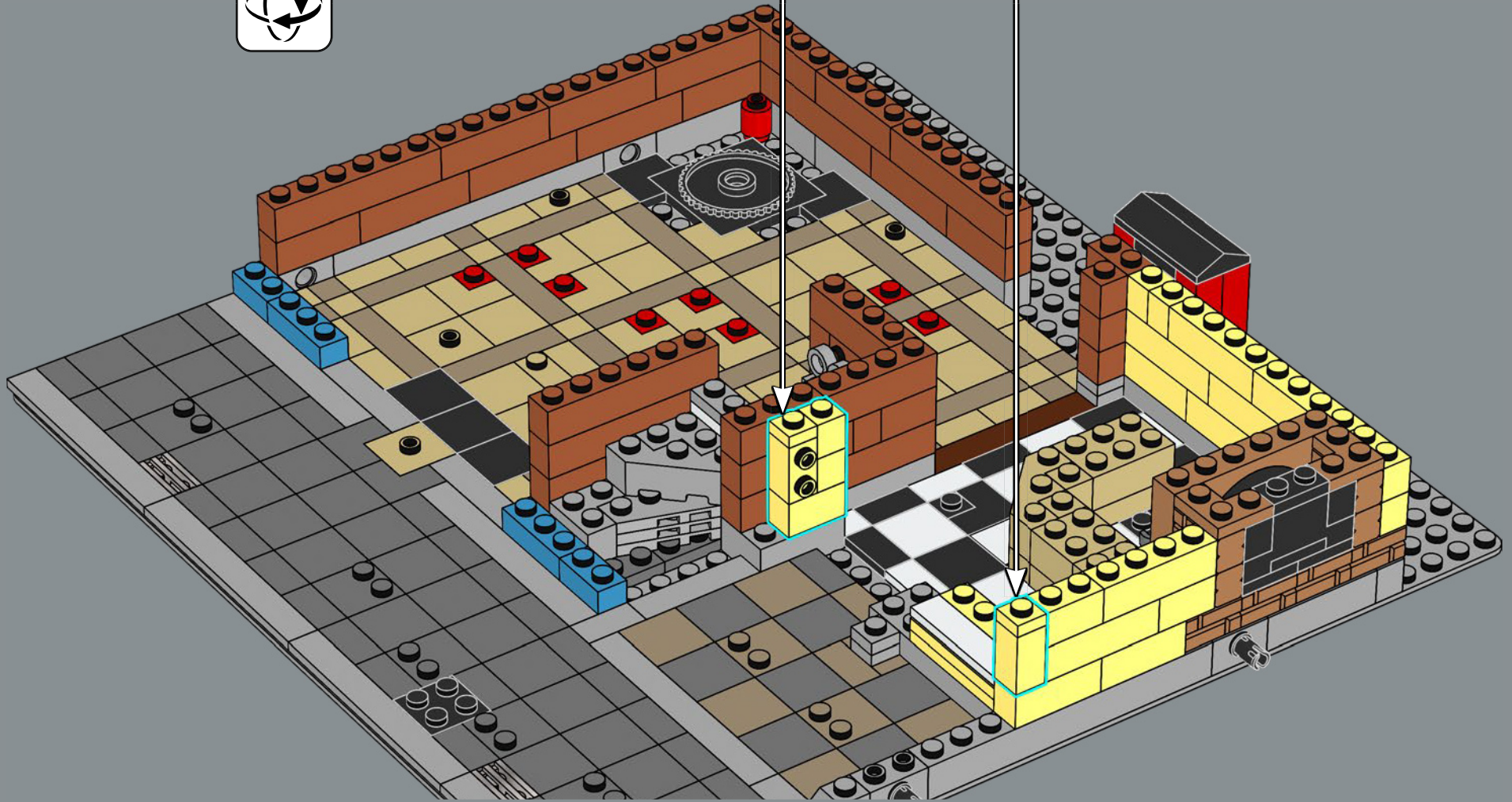
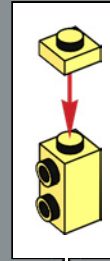
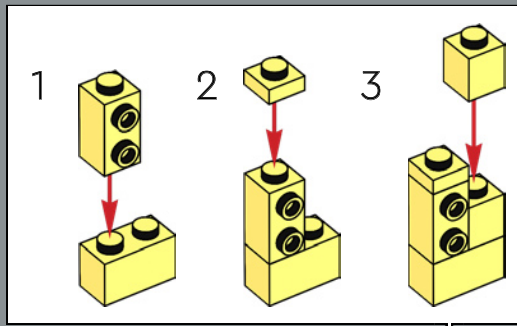

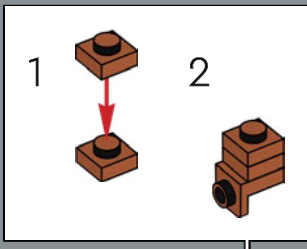
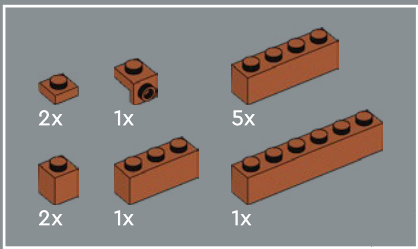

42

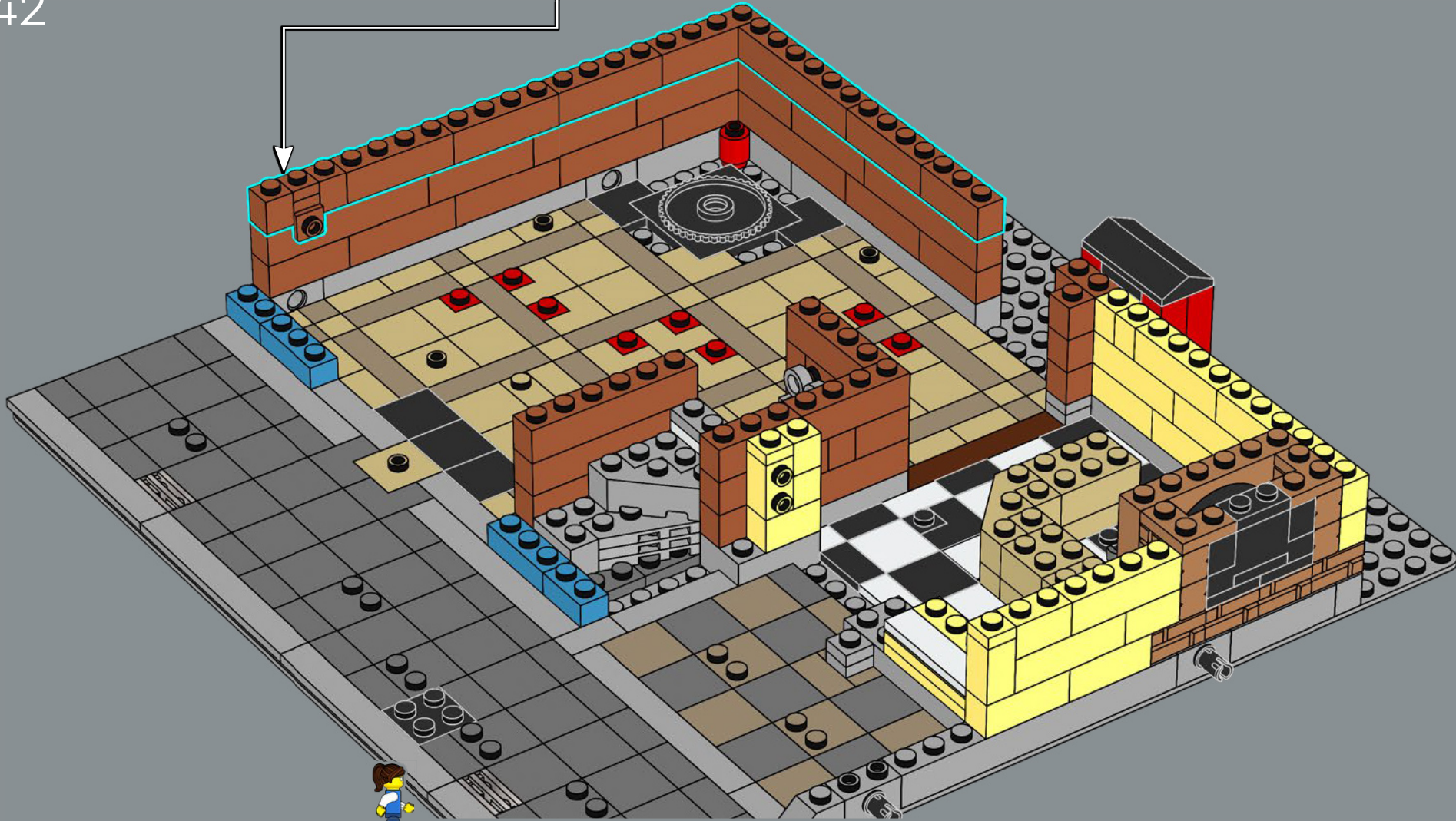

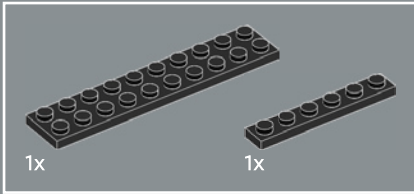
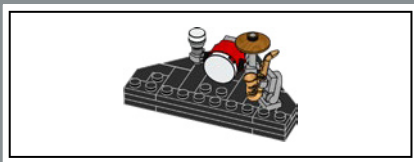

43

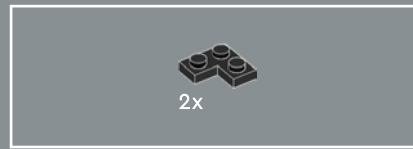
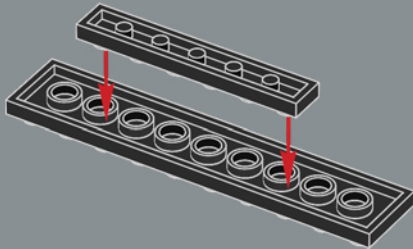

44

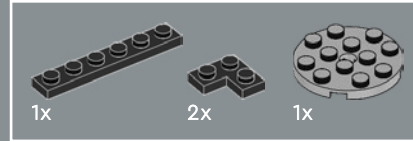
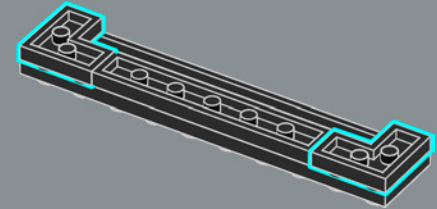

45

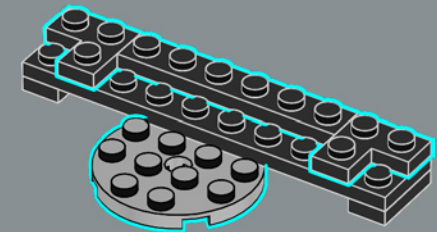



46

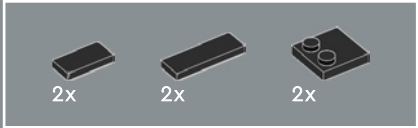
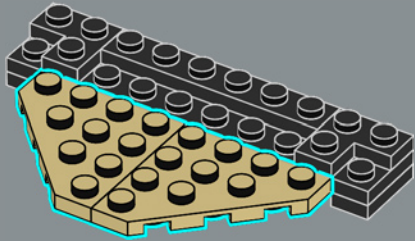

47

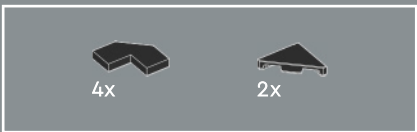
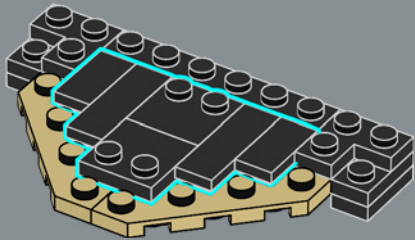

48

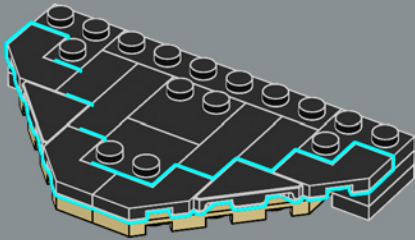

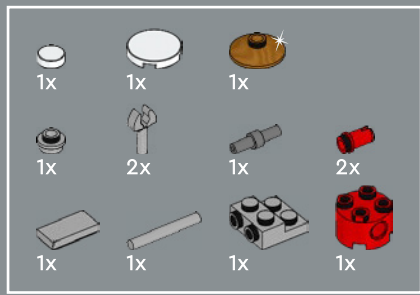

49

1

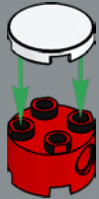

2

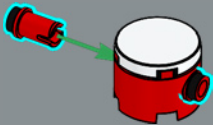

3

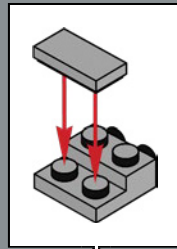

4

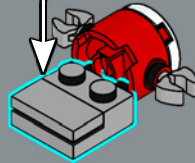

5

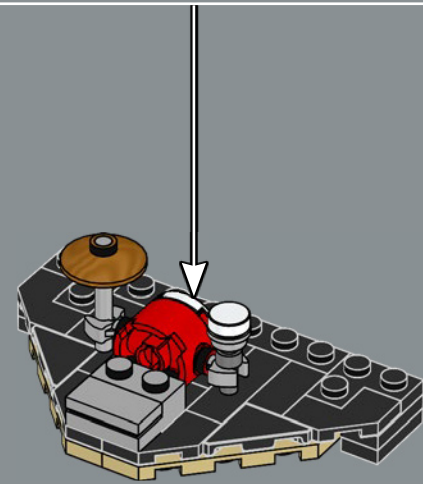
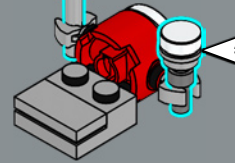
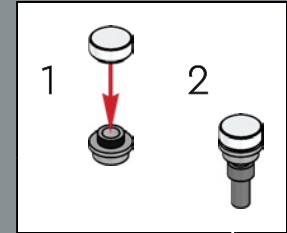
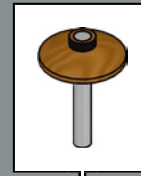



Can't you just hear the 'boom-cht' sound of the bass drum and snare, and the 'tss-t-t-tss' of the cymbal?

50

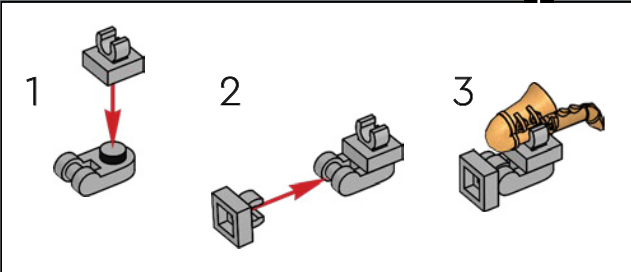
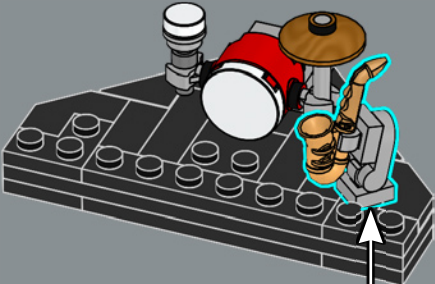

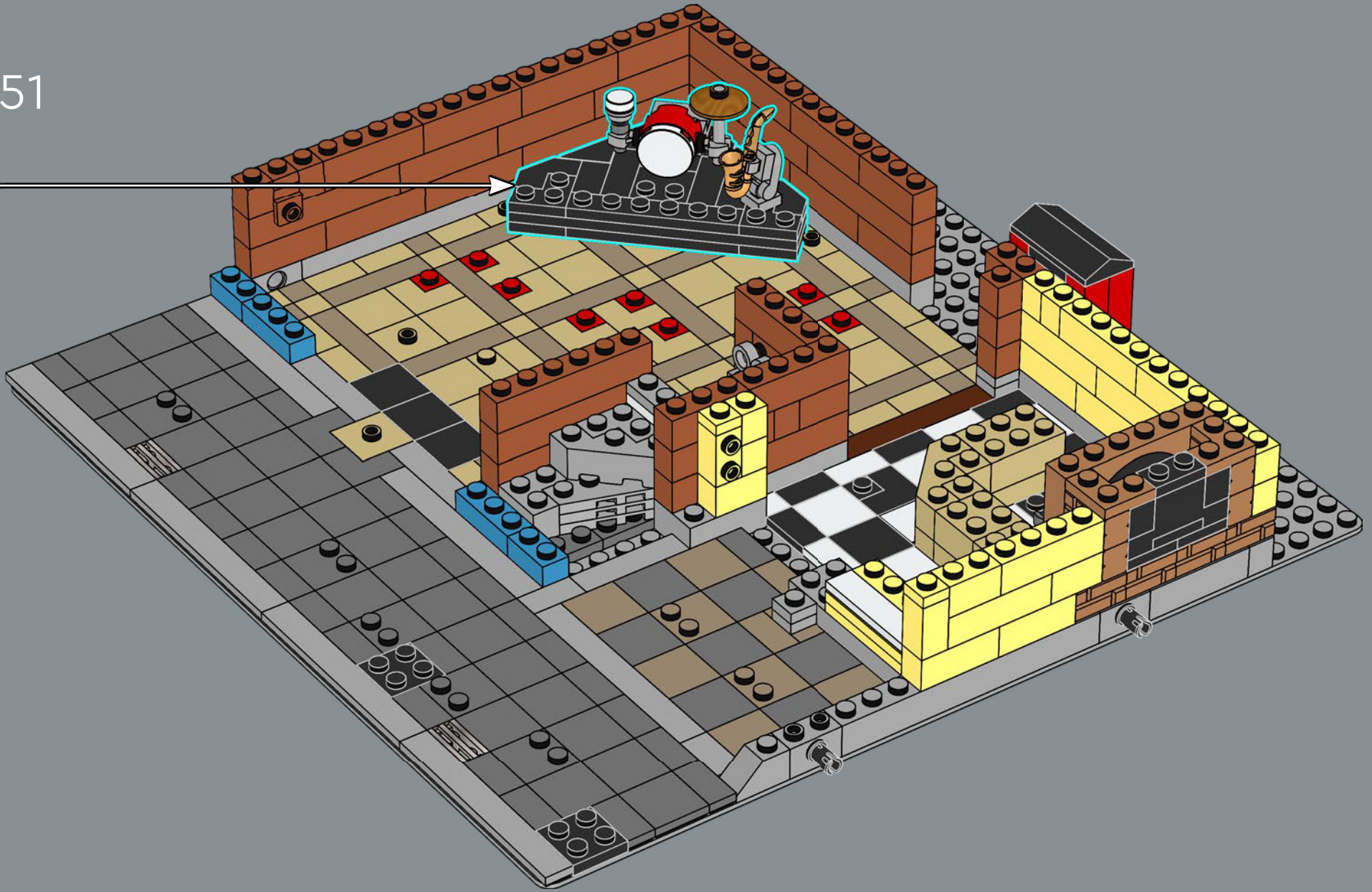



The pizza chef grows some of his own ingredients in the rooftop greenhouse. Others he purchases fresh at the LEGO® 10185 Green Grocer.

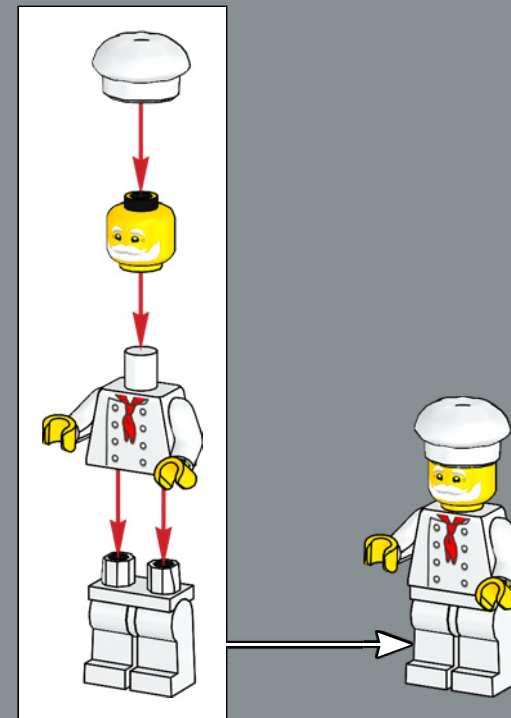

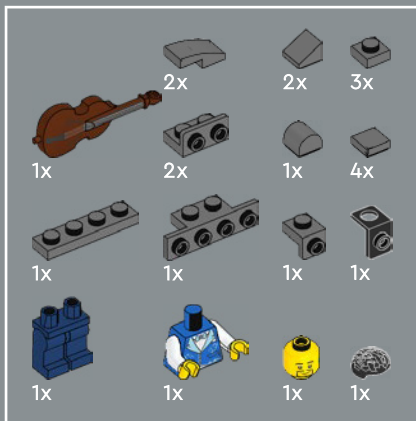

Tonight, the bass player plays his debut performance. He's been practising very hard when he's not working at the LEGO® 10232 Palace Cinema.

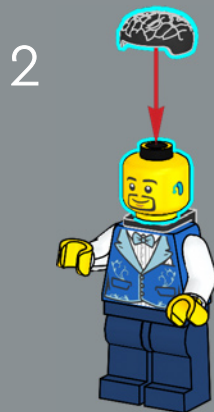
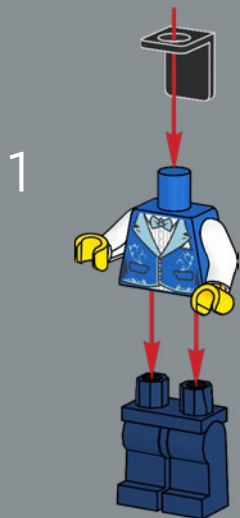
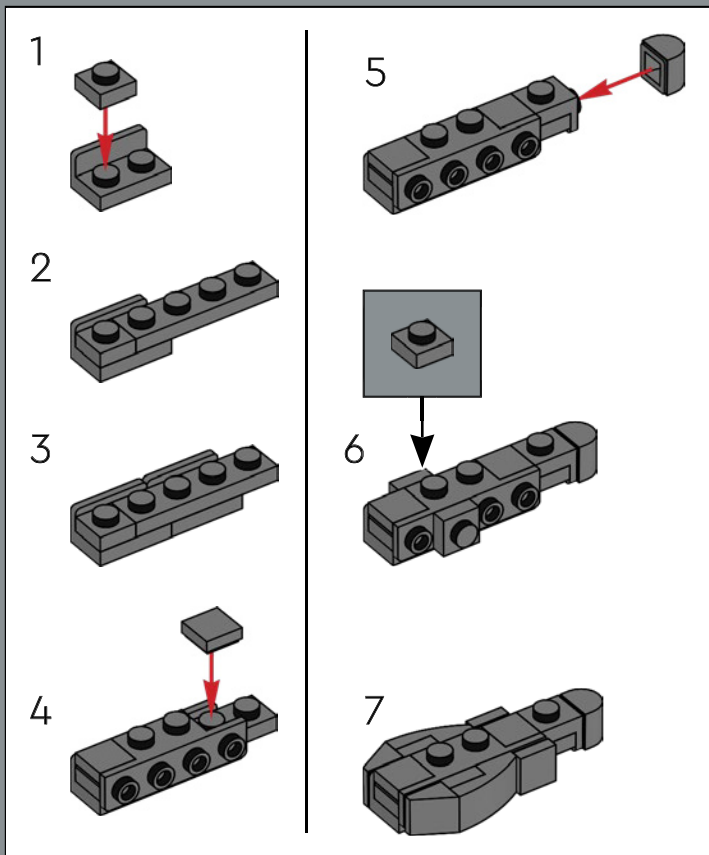



52

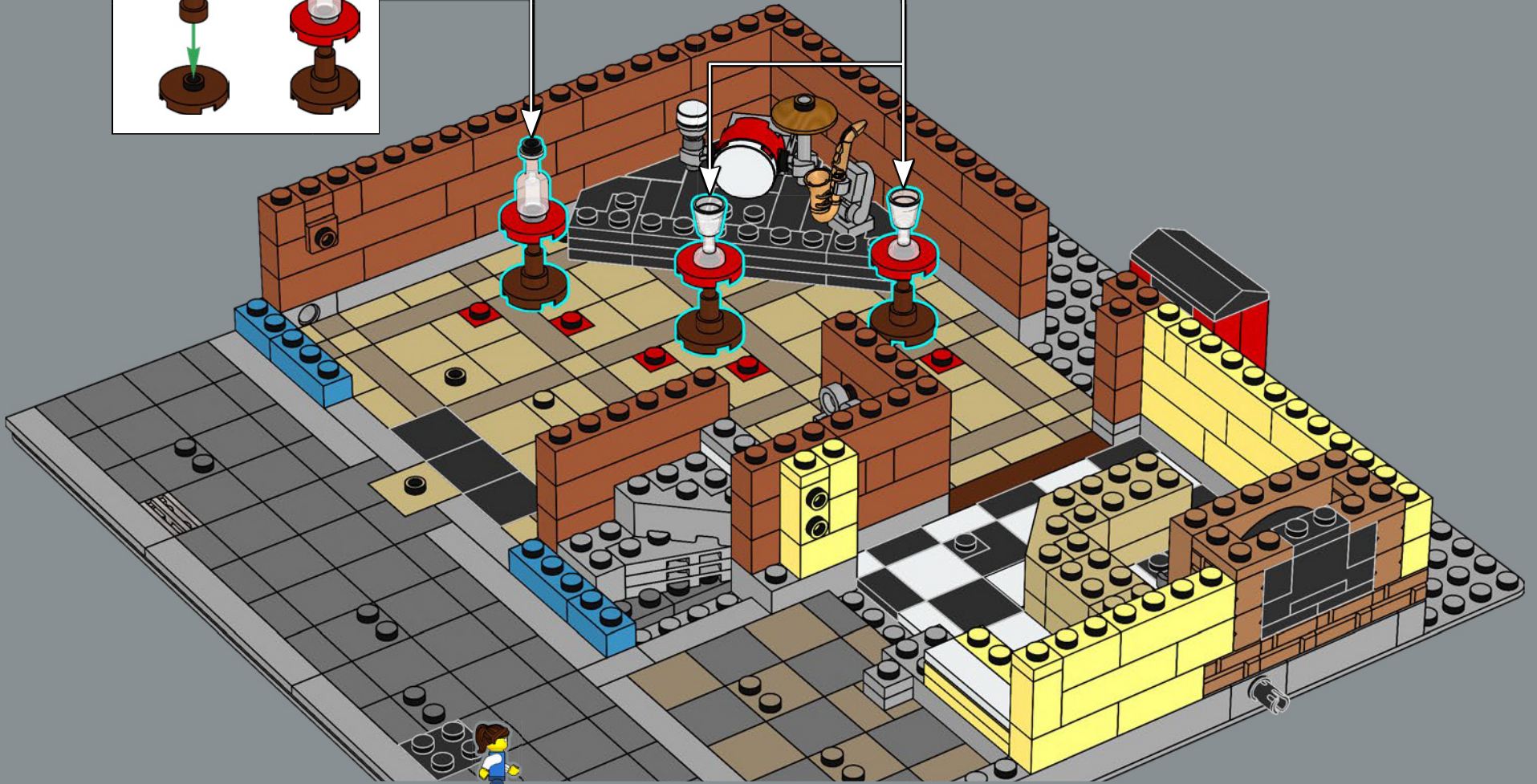
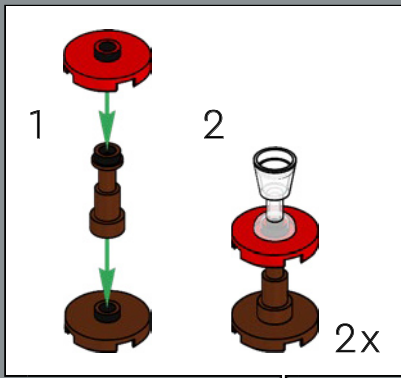
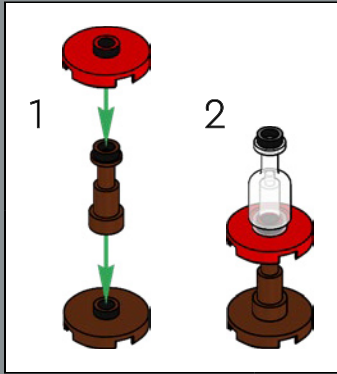



53

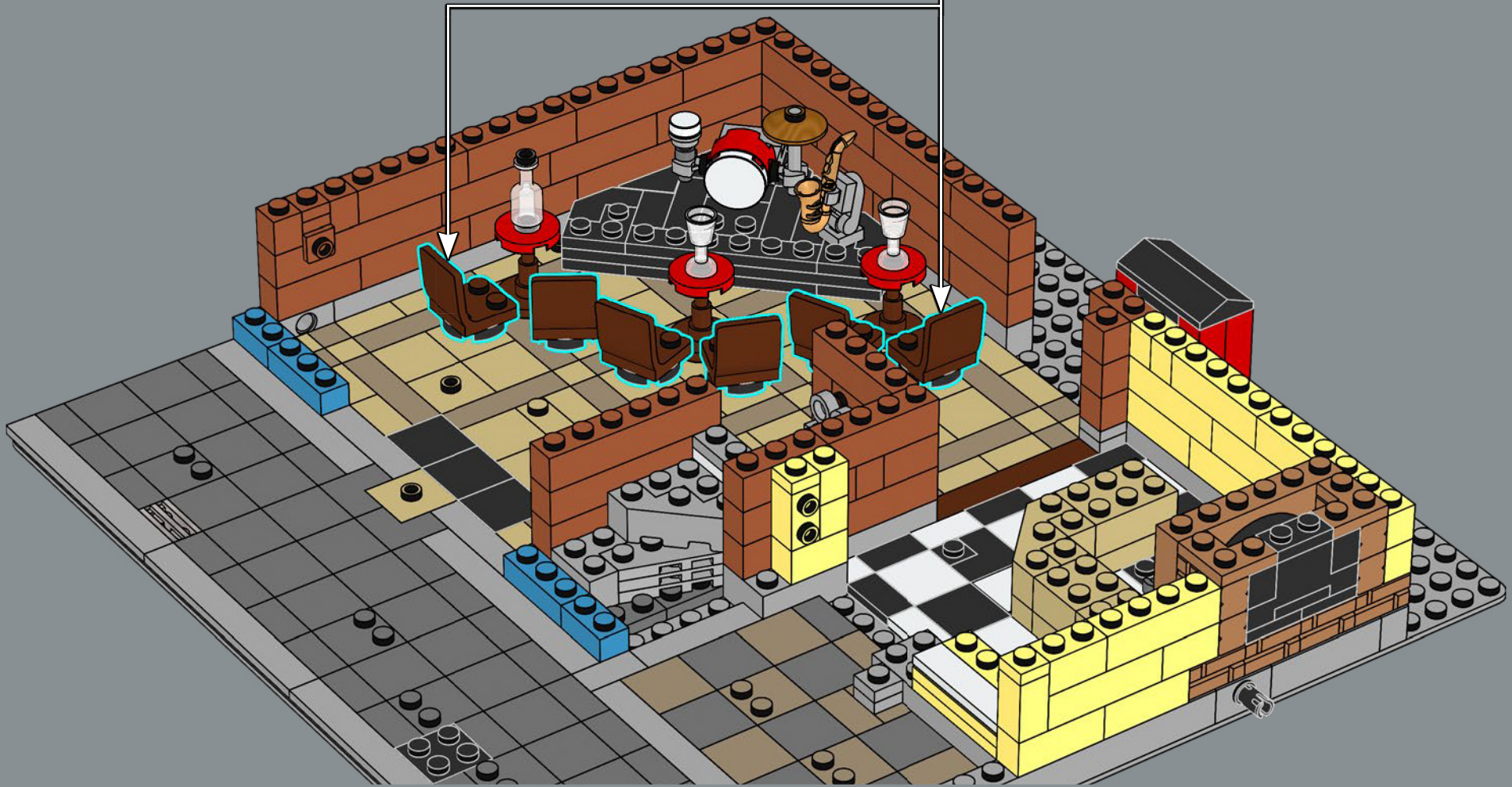
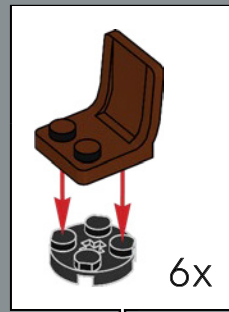

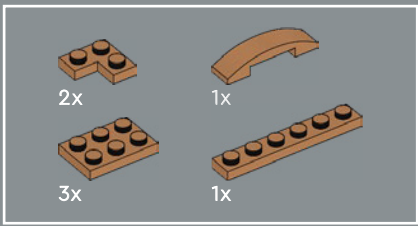

54

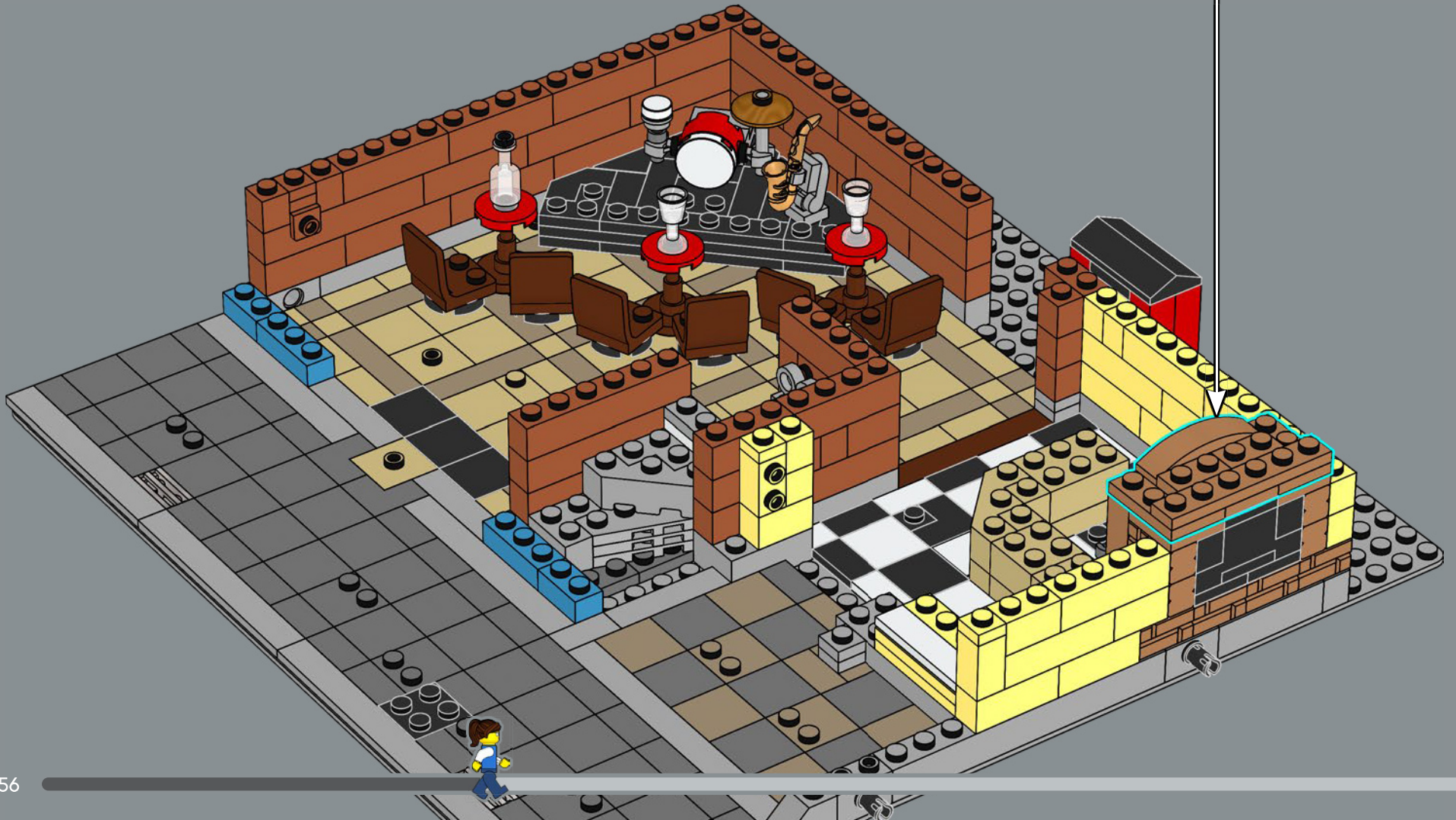
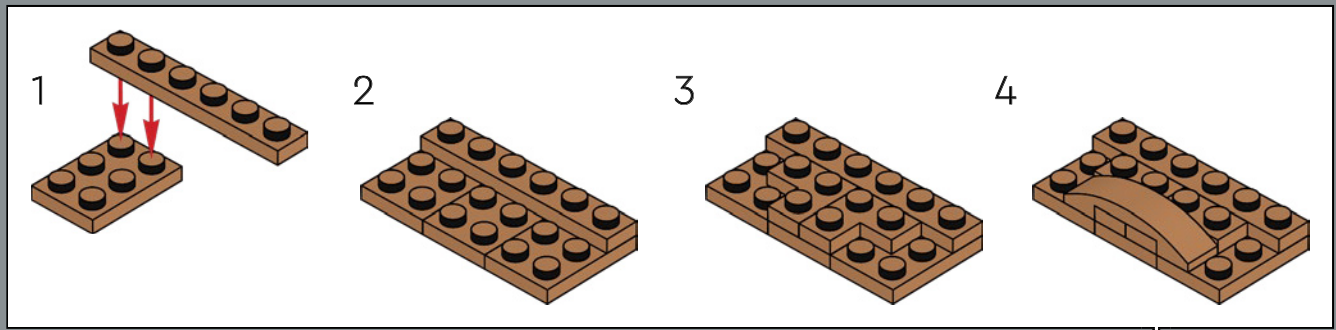

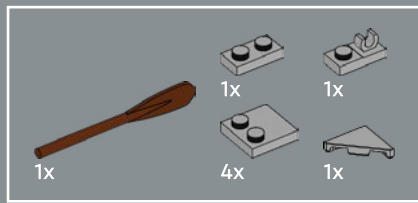

55

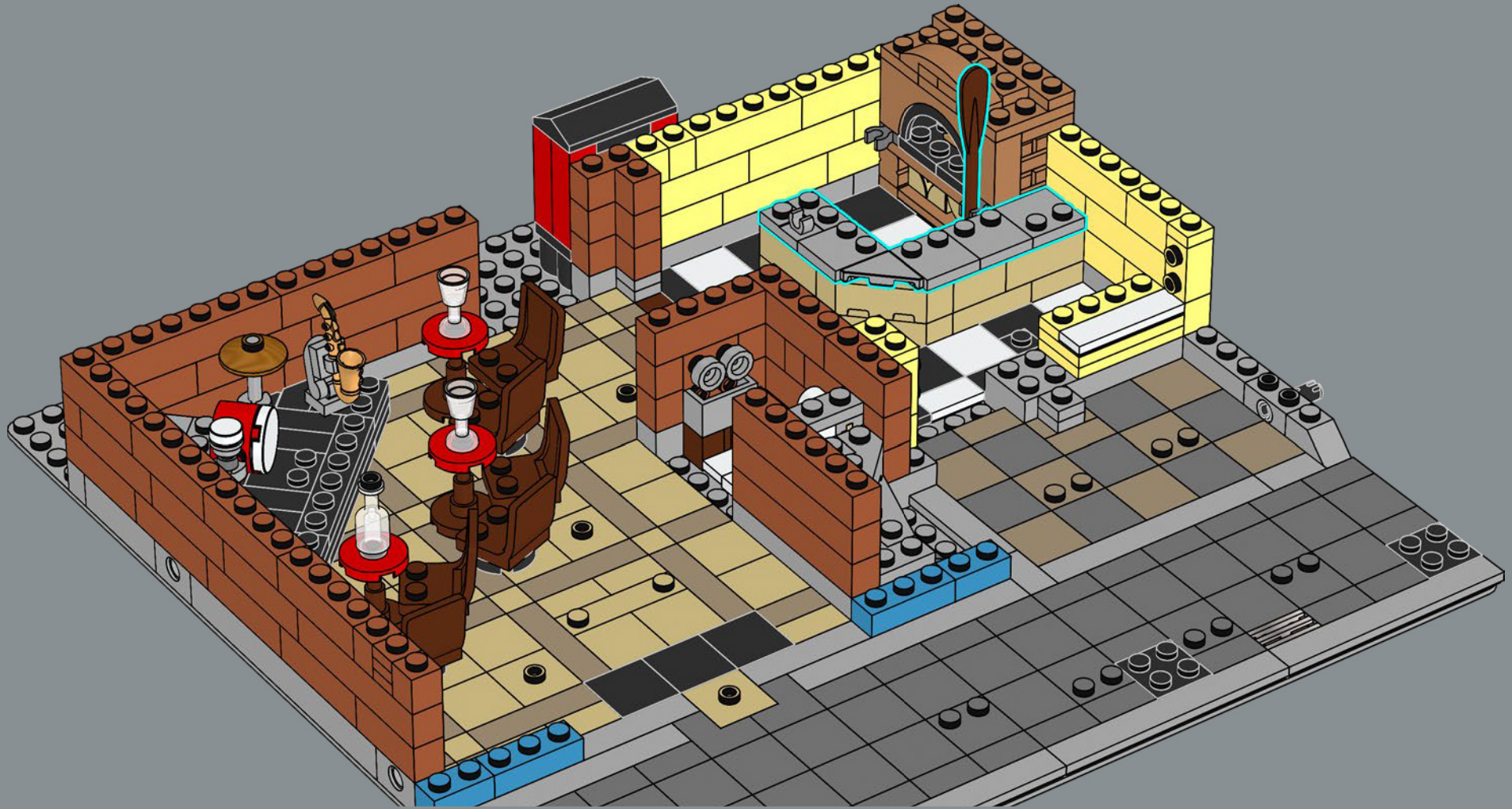

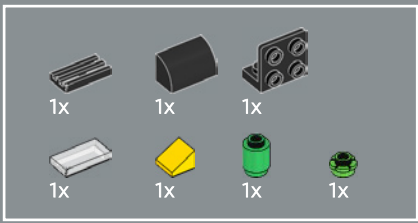

56

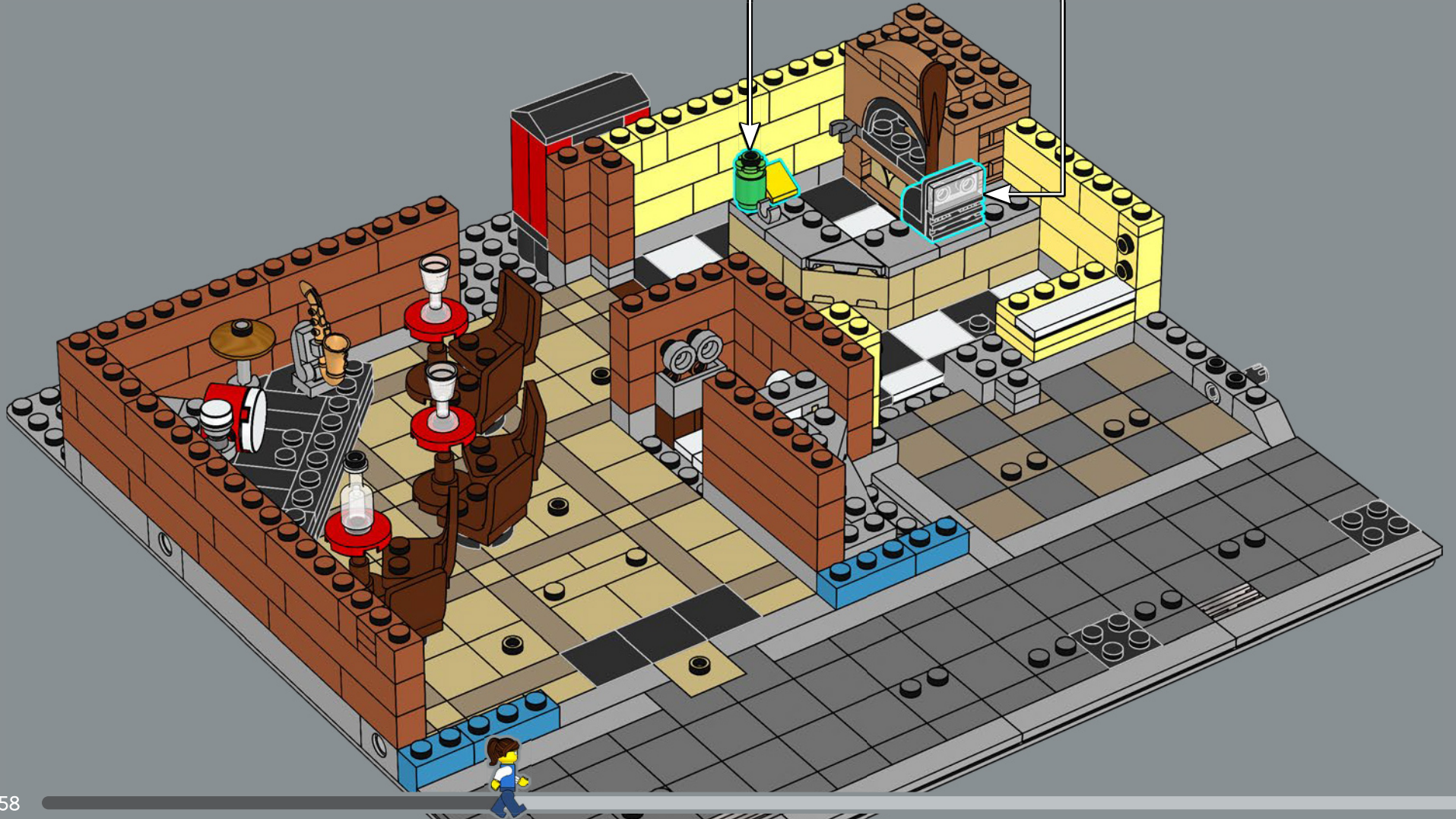
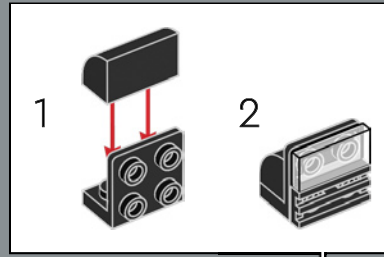
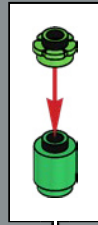

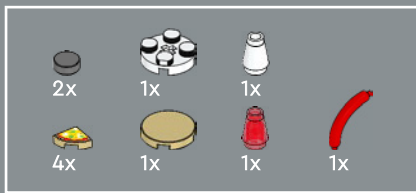

57



One delicious margherita pizza coming right up!
Customers can enjoy the whole pie or buy it by the slice.

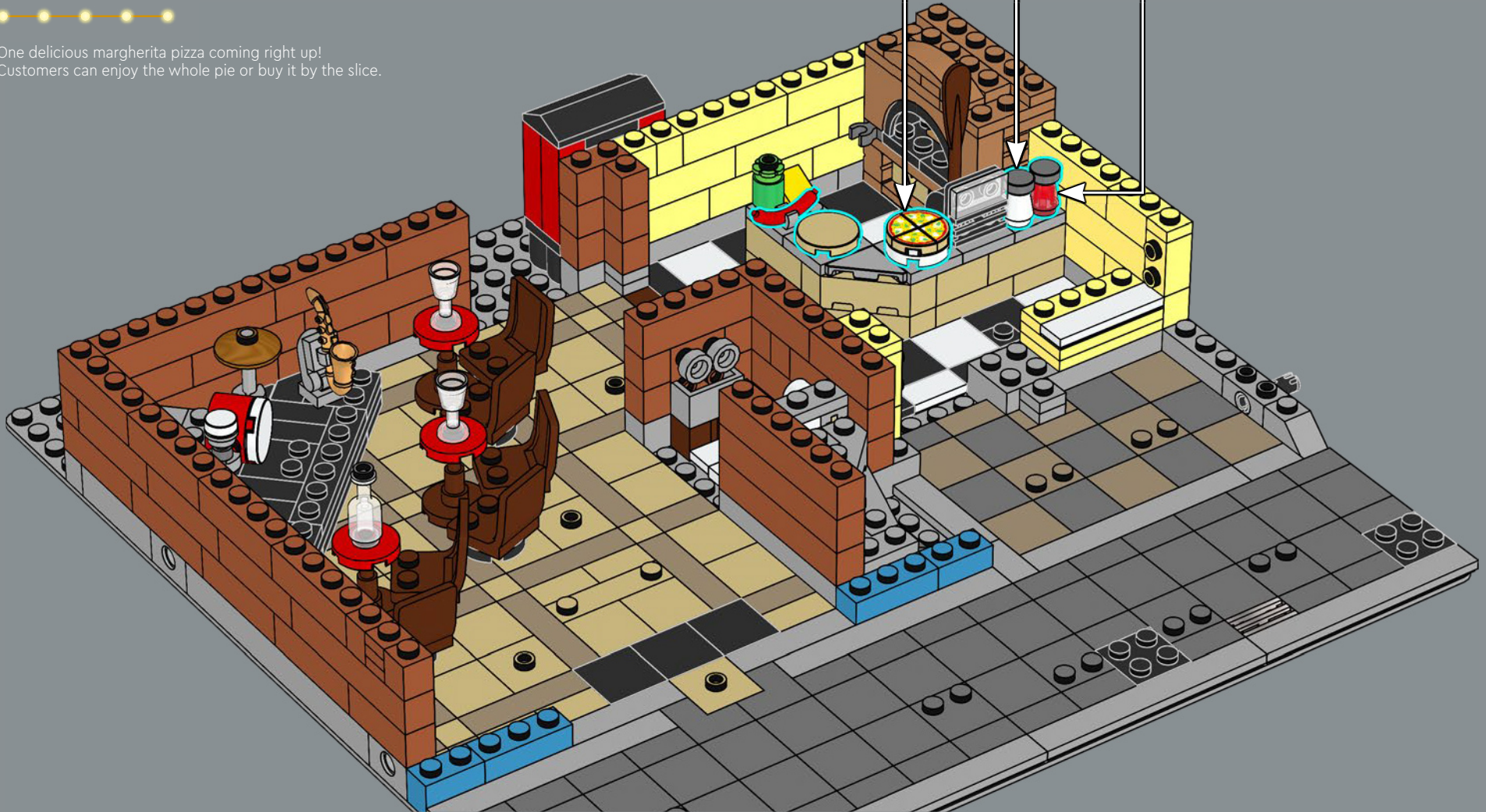

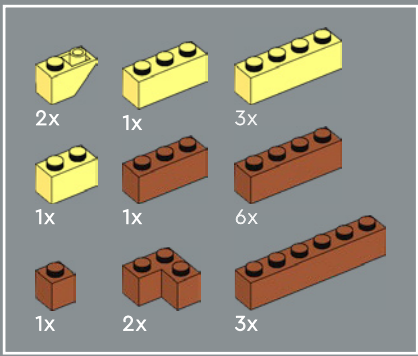

58

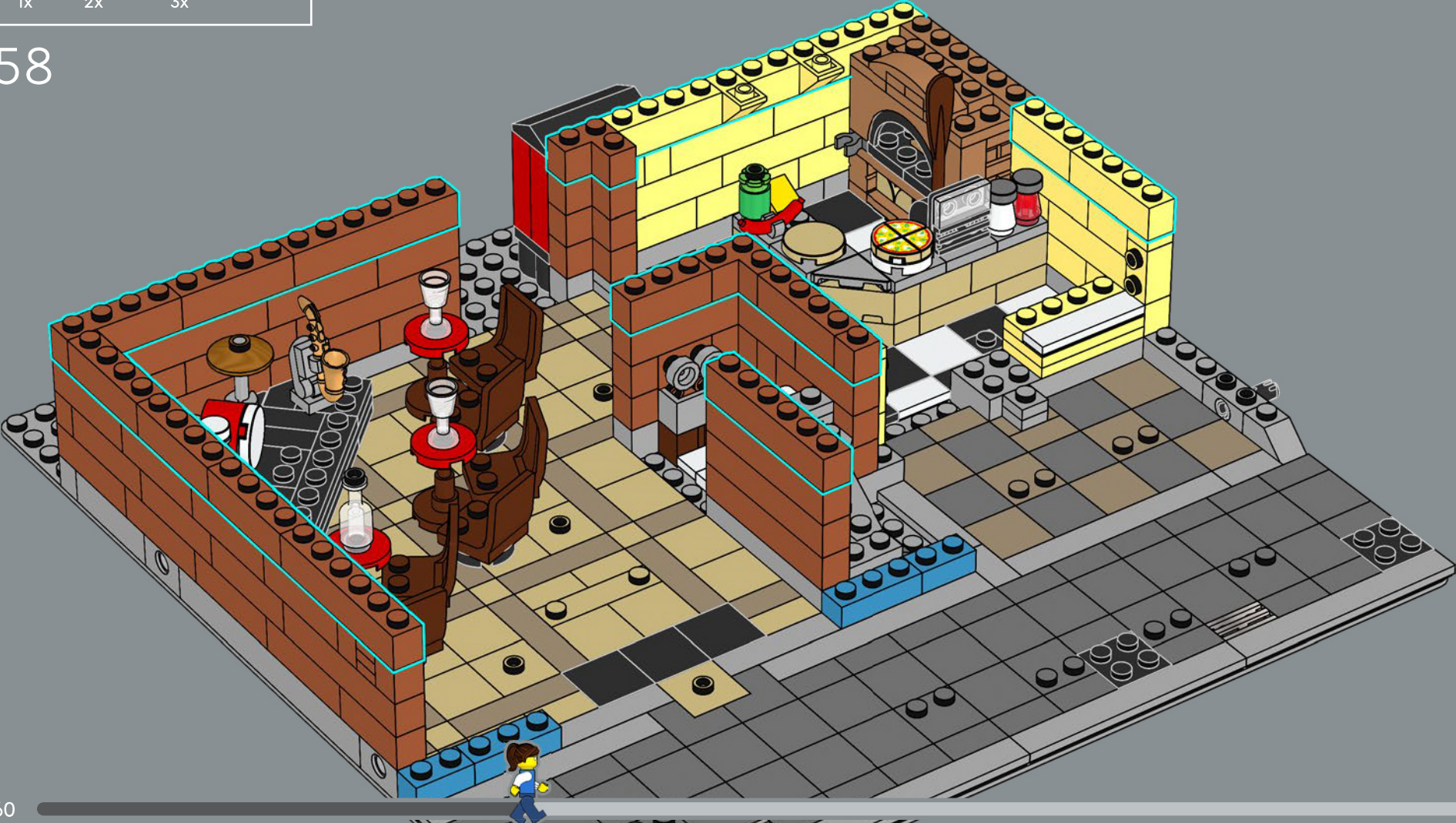

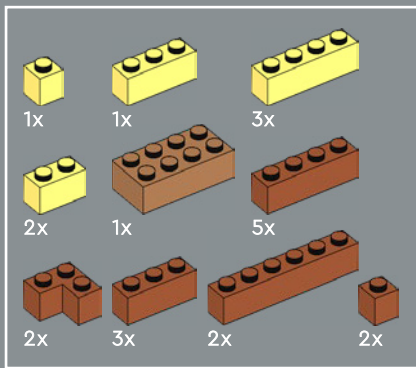

59

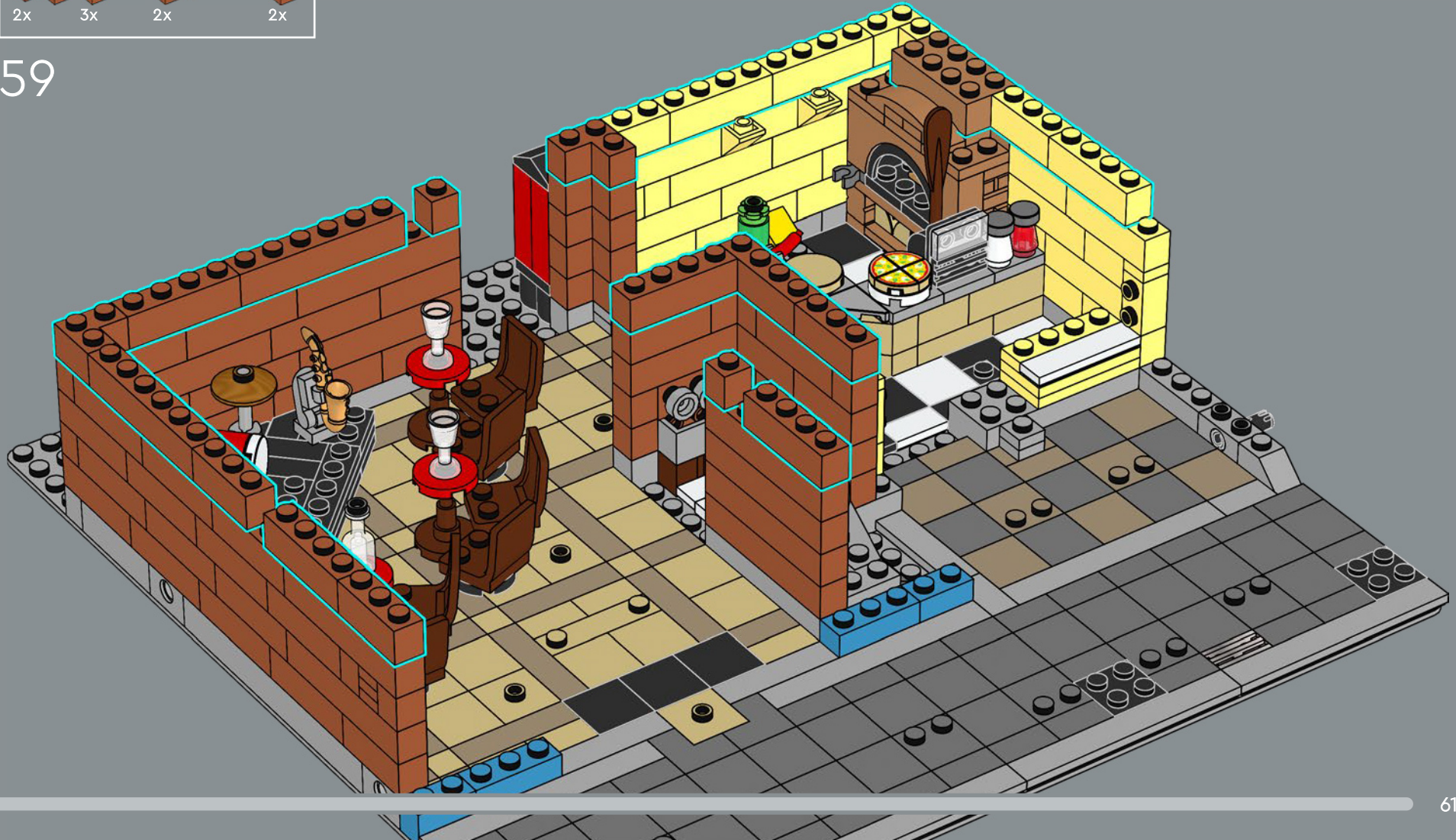

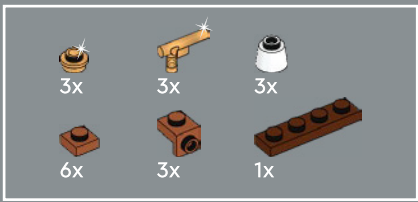

60

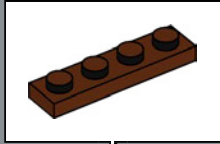
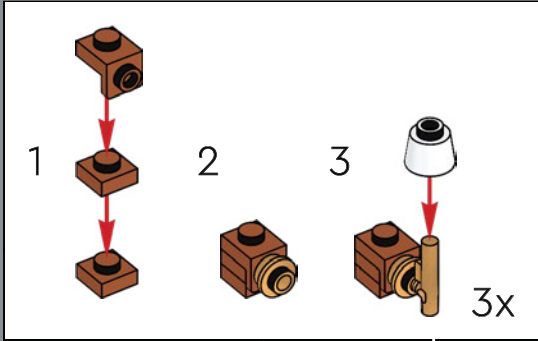

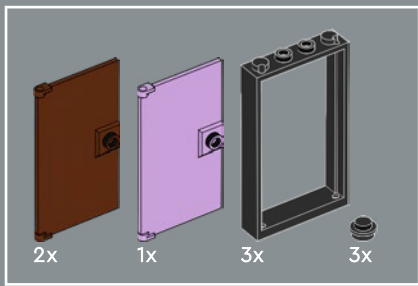

61

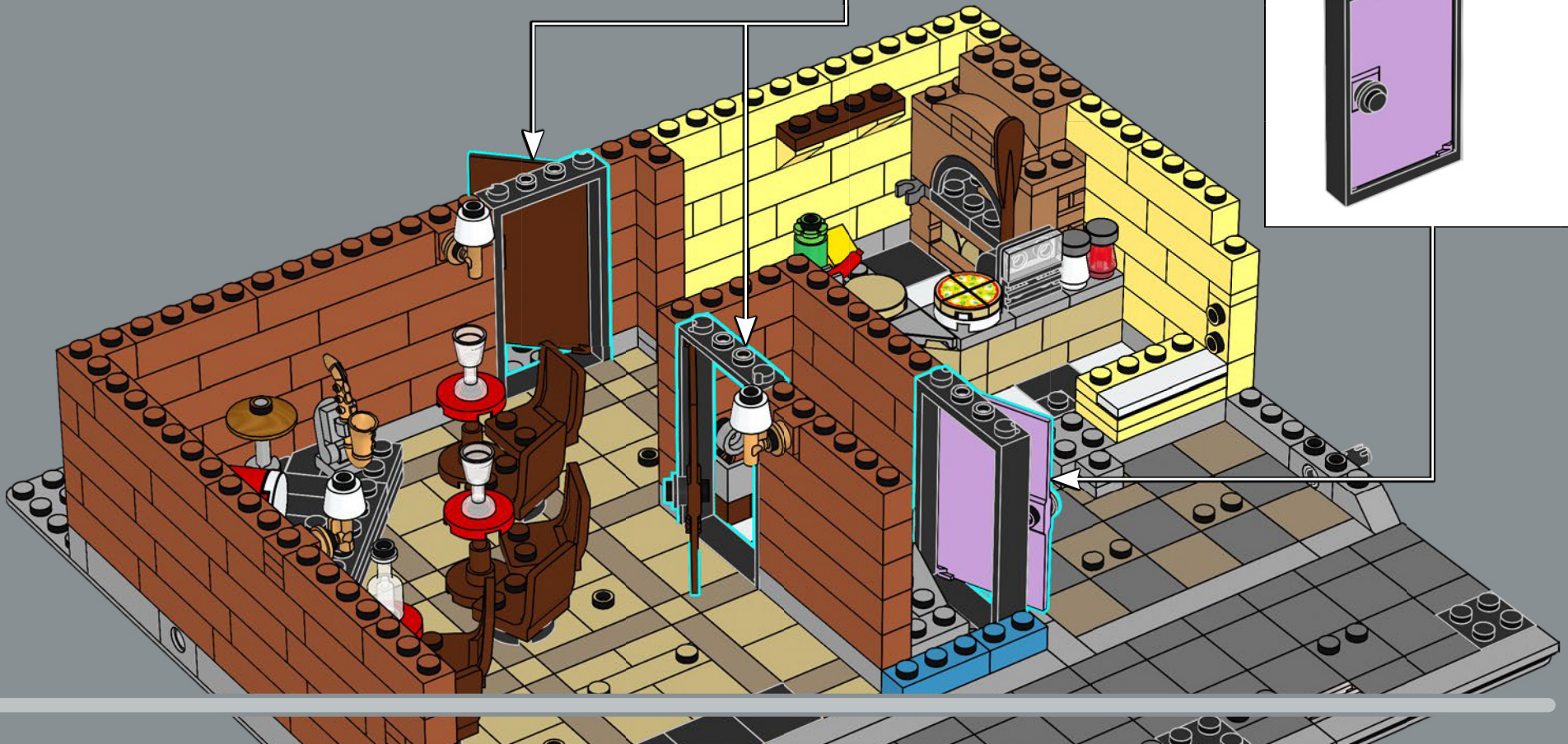
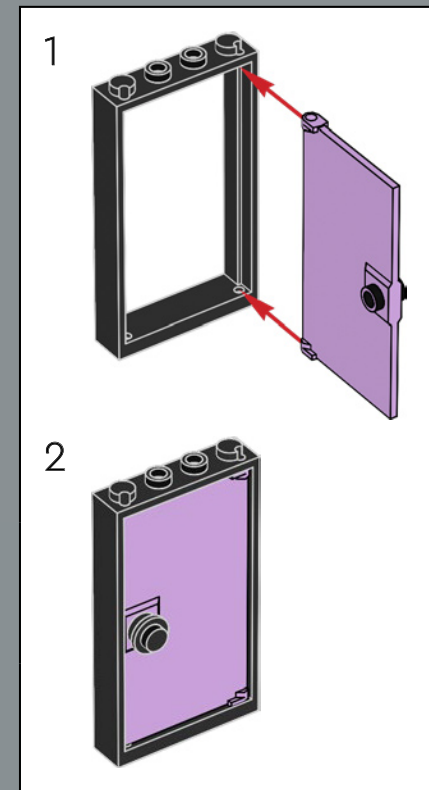
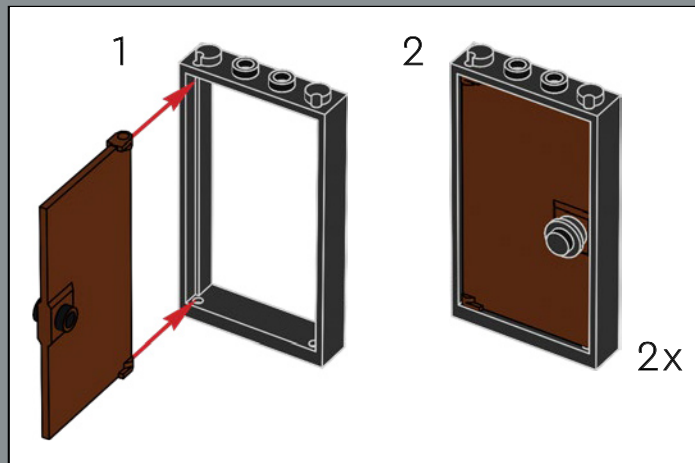

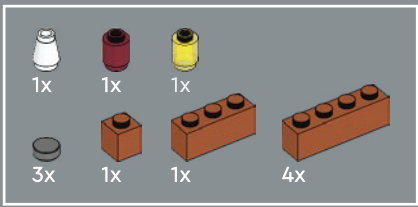

62

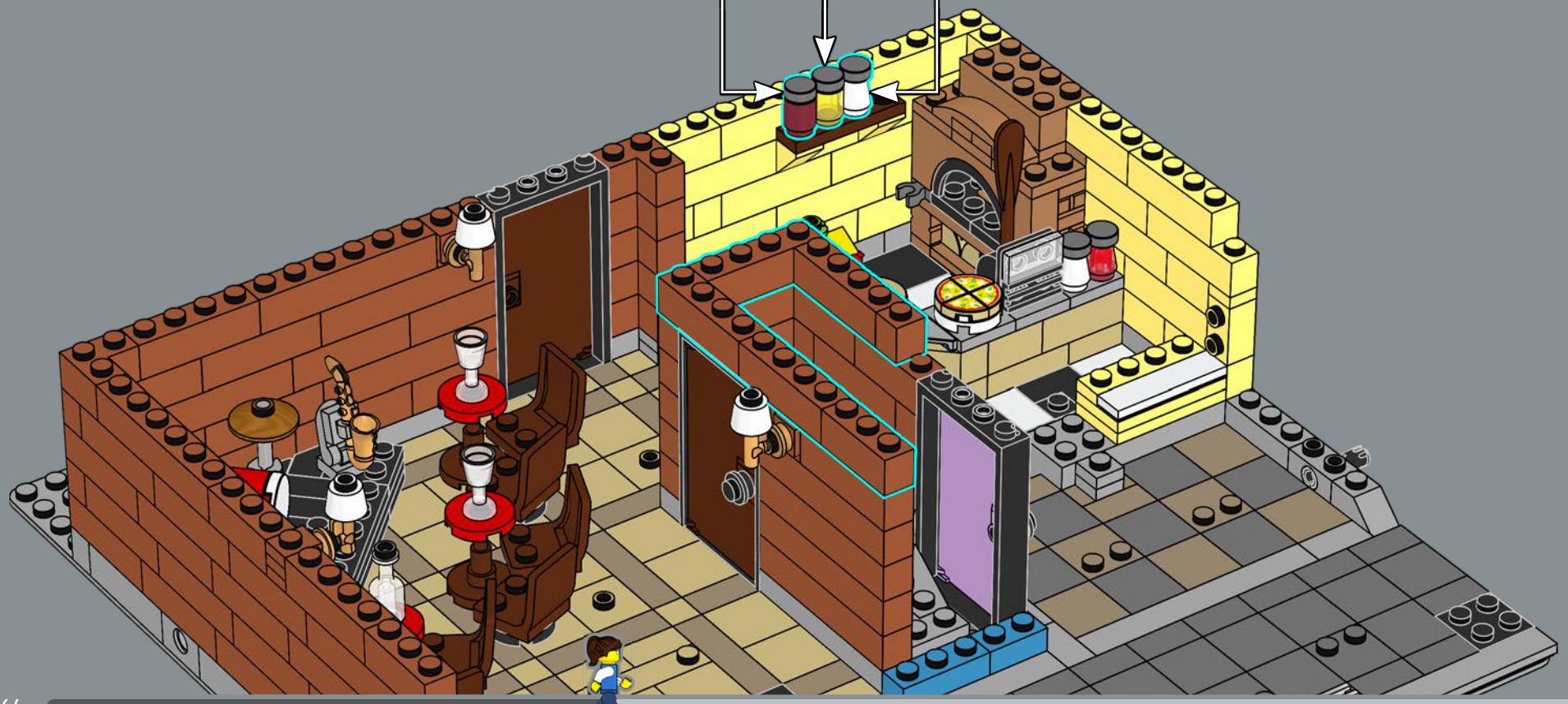
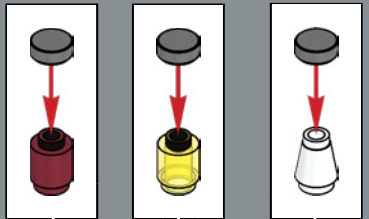

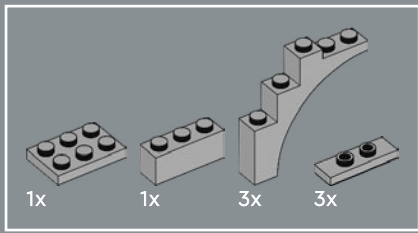

63

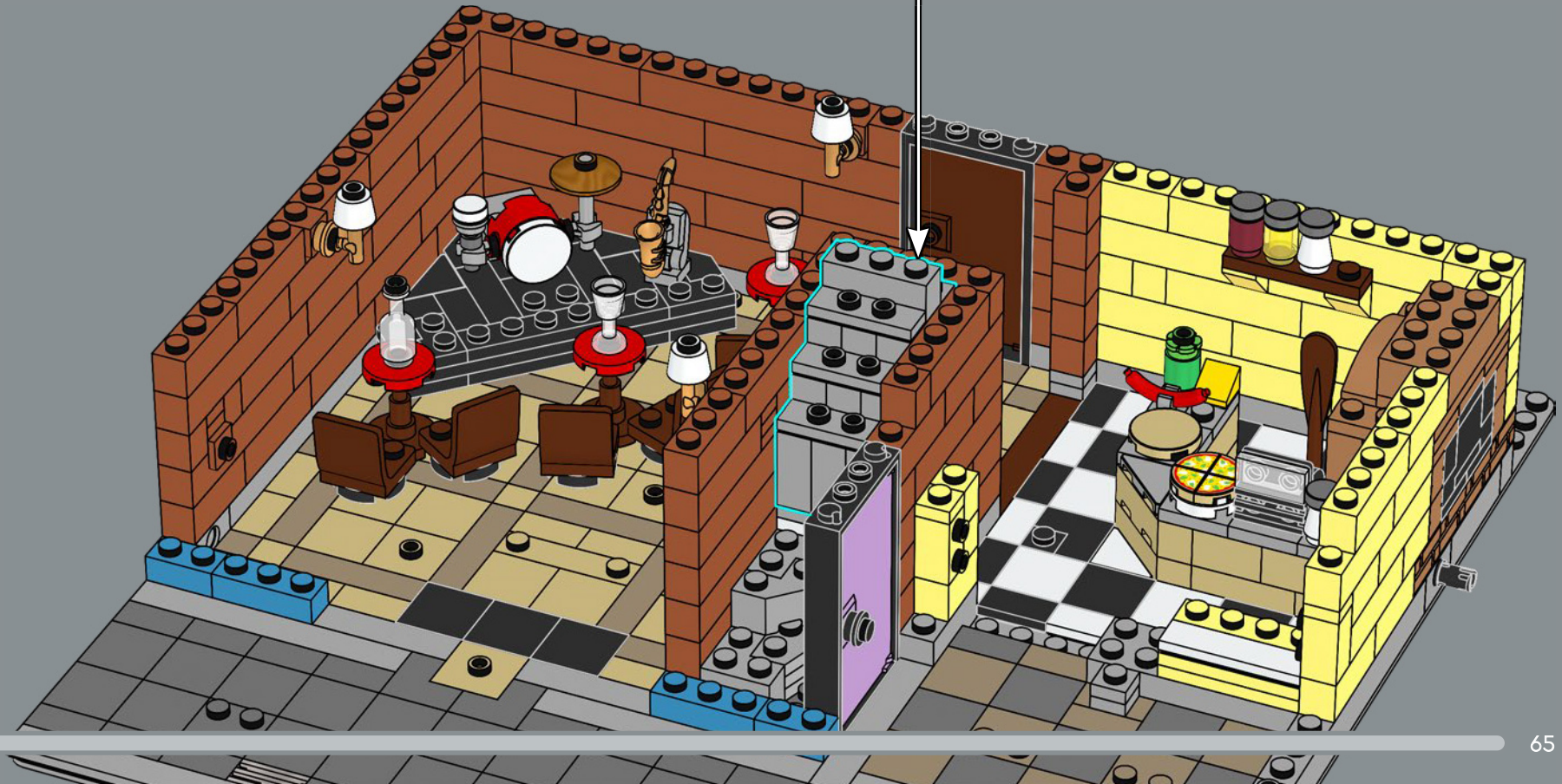
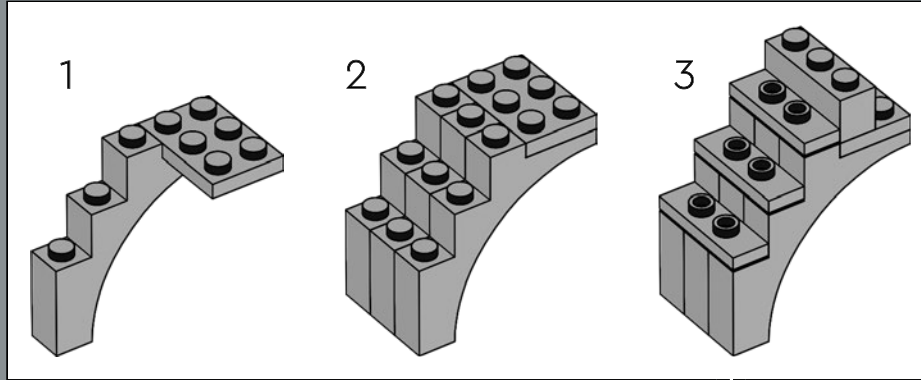

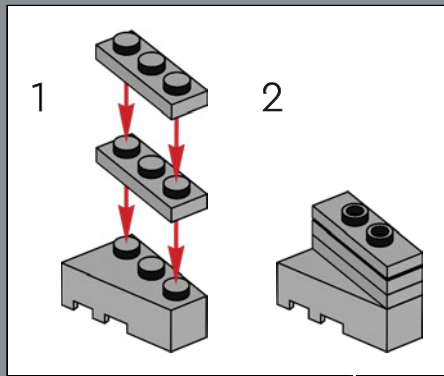
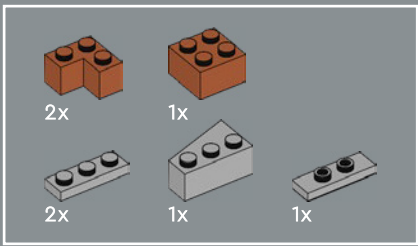

64

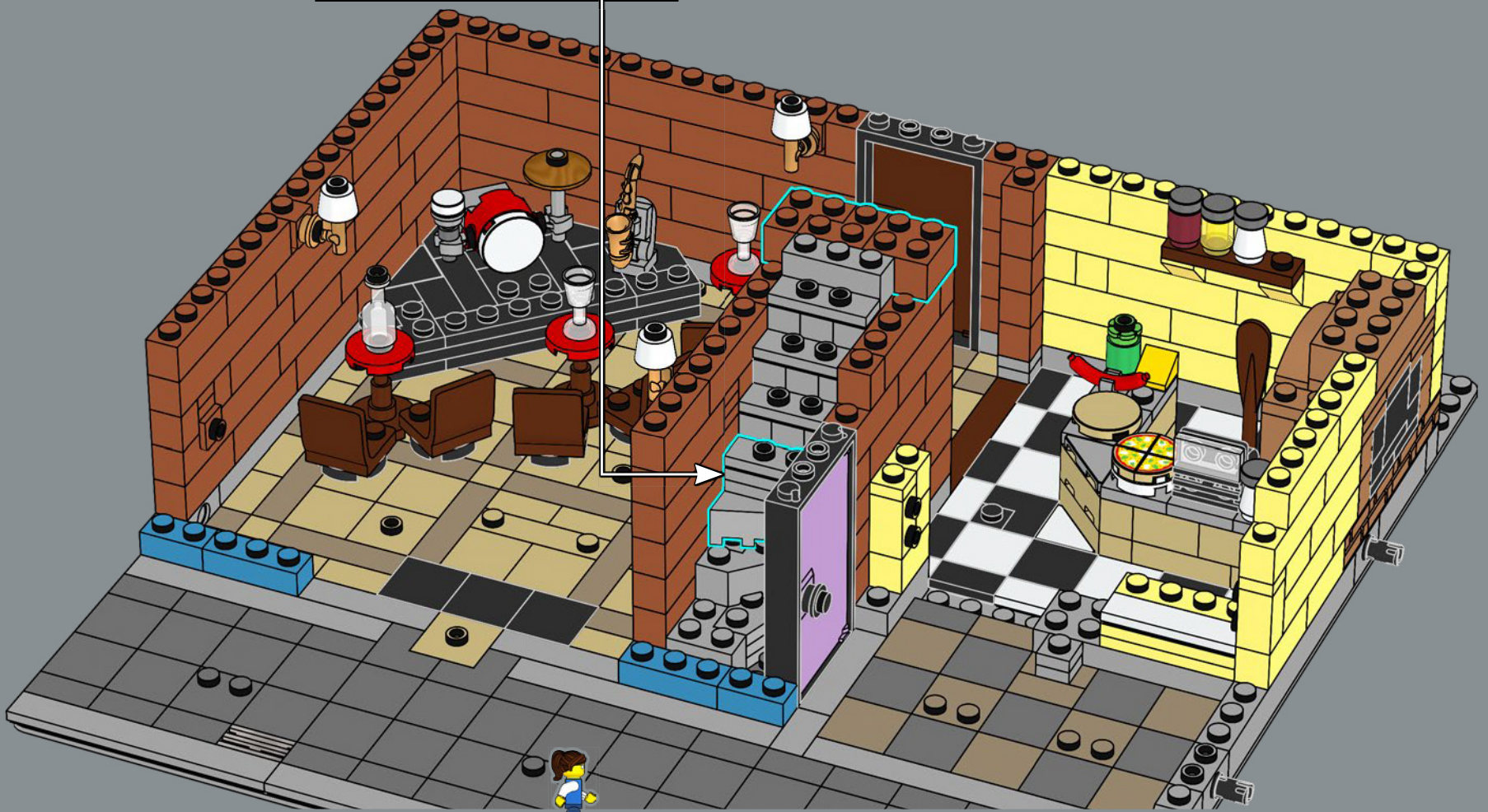

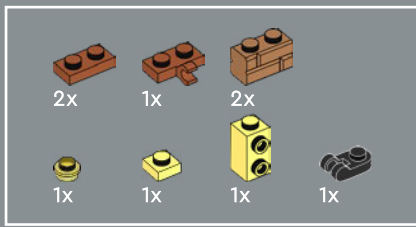

65

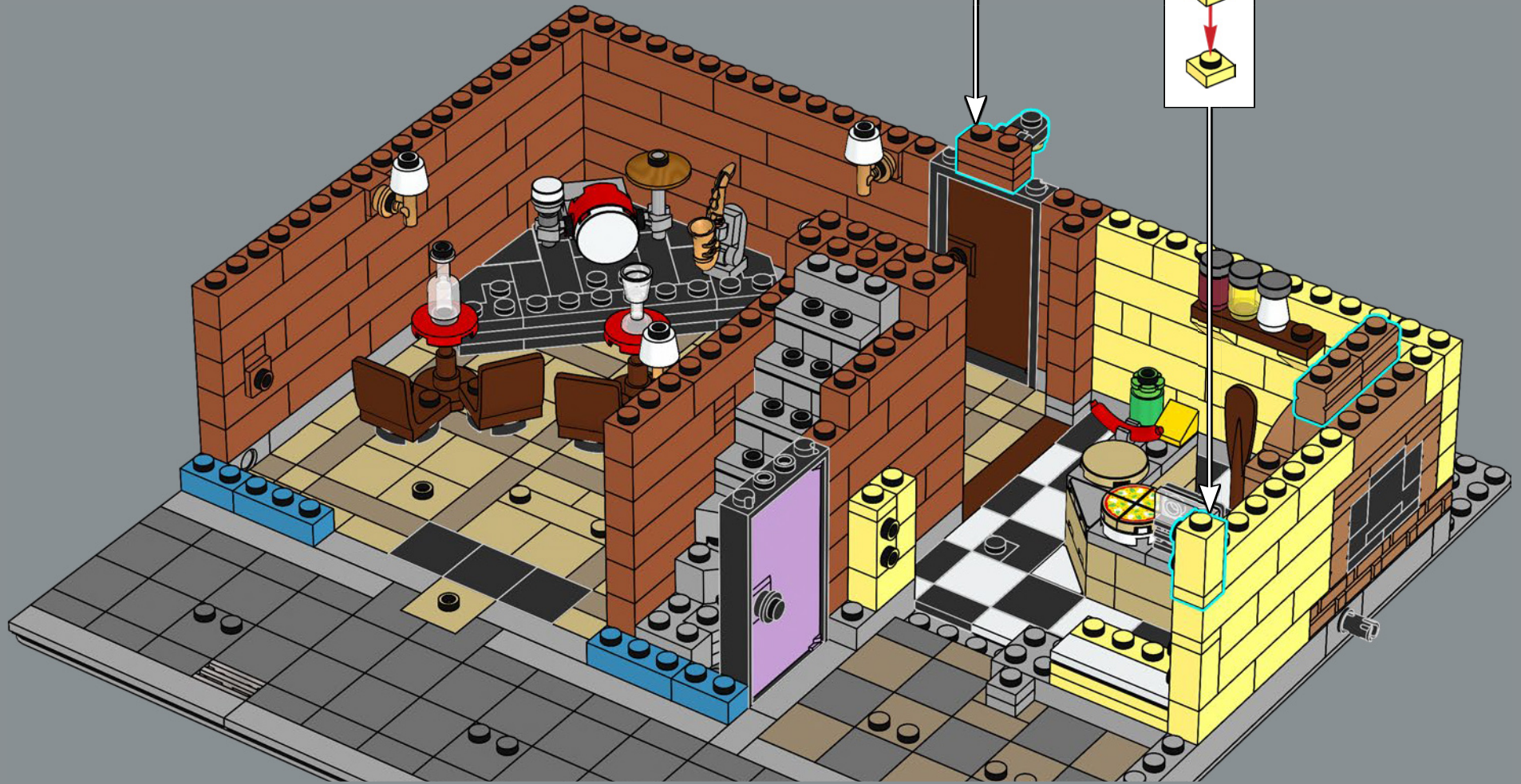
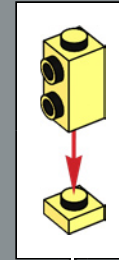
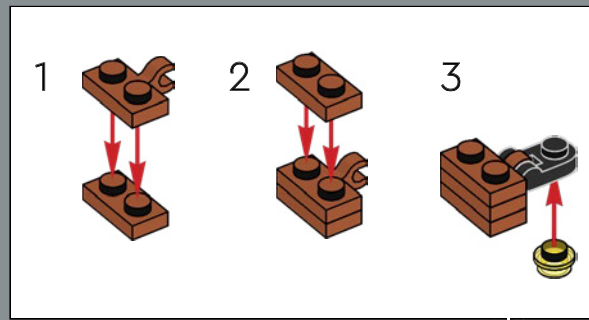

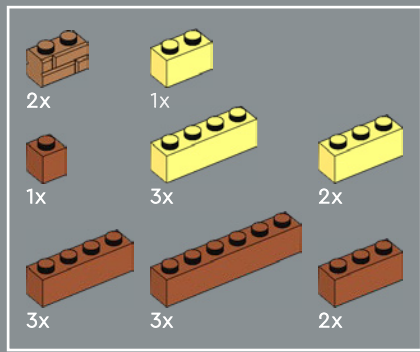

66



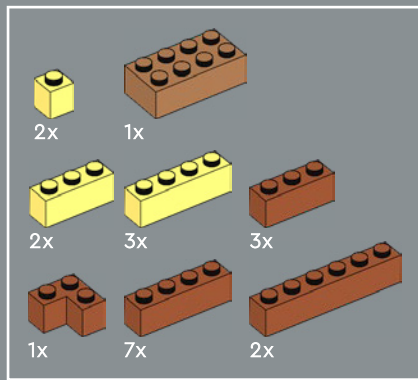

67



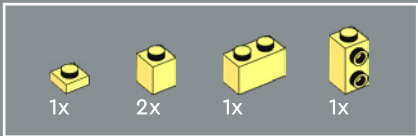

68

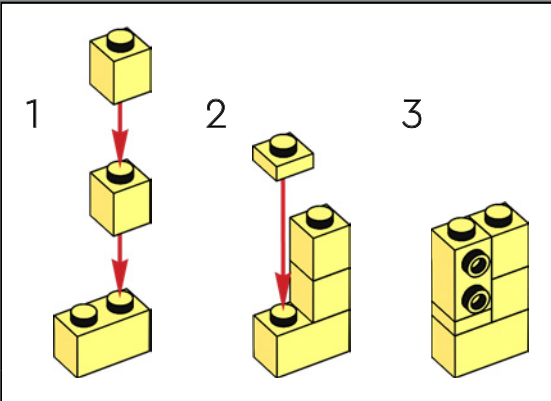

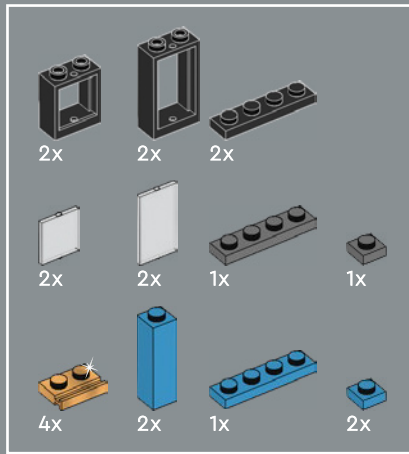
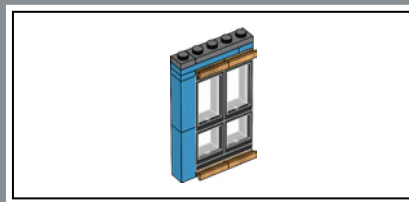

69

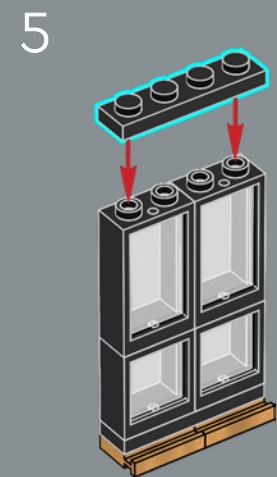
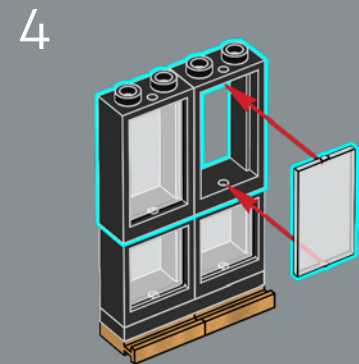
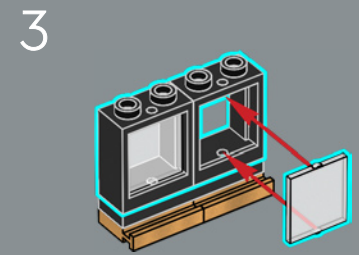
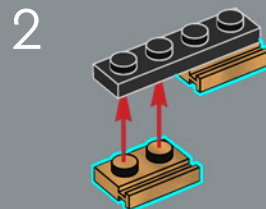
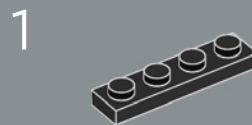

6

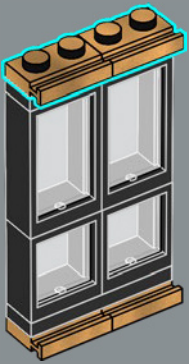

7

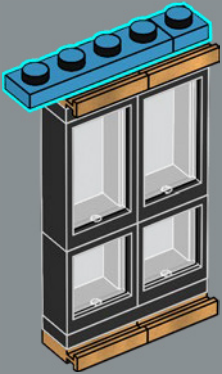

8

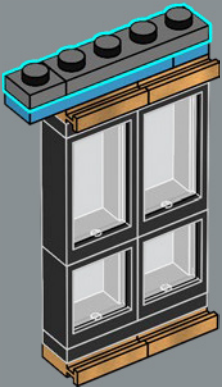

9

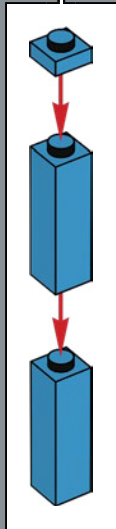
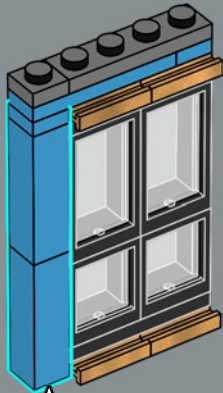

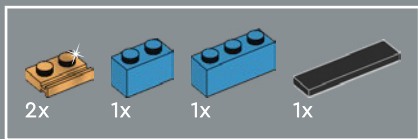

70

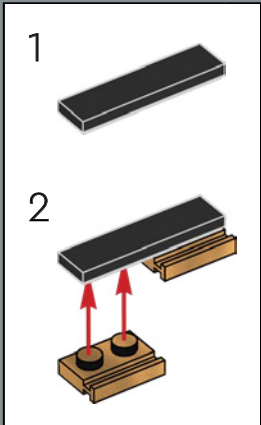
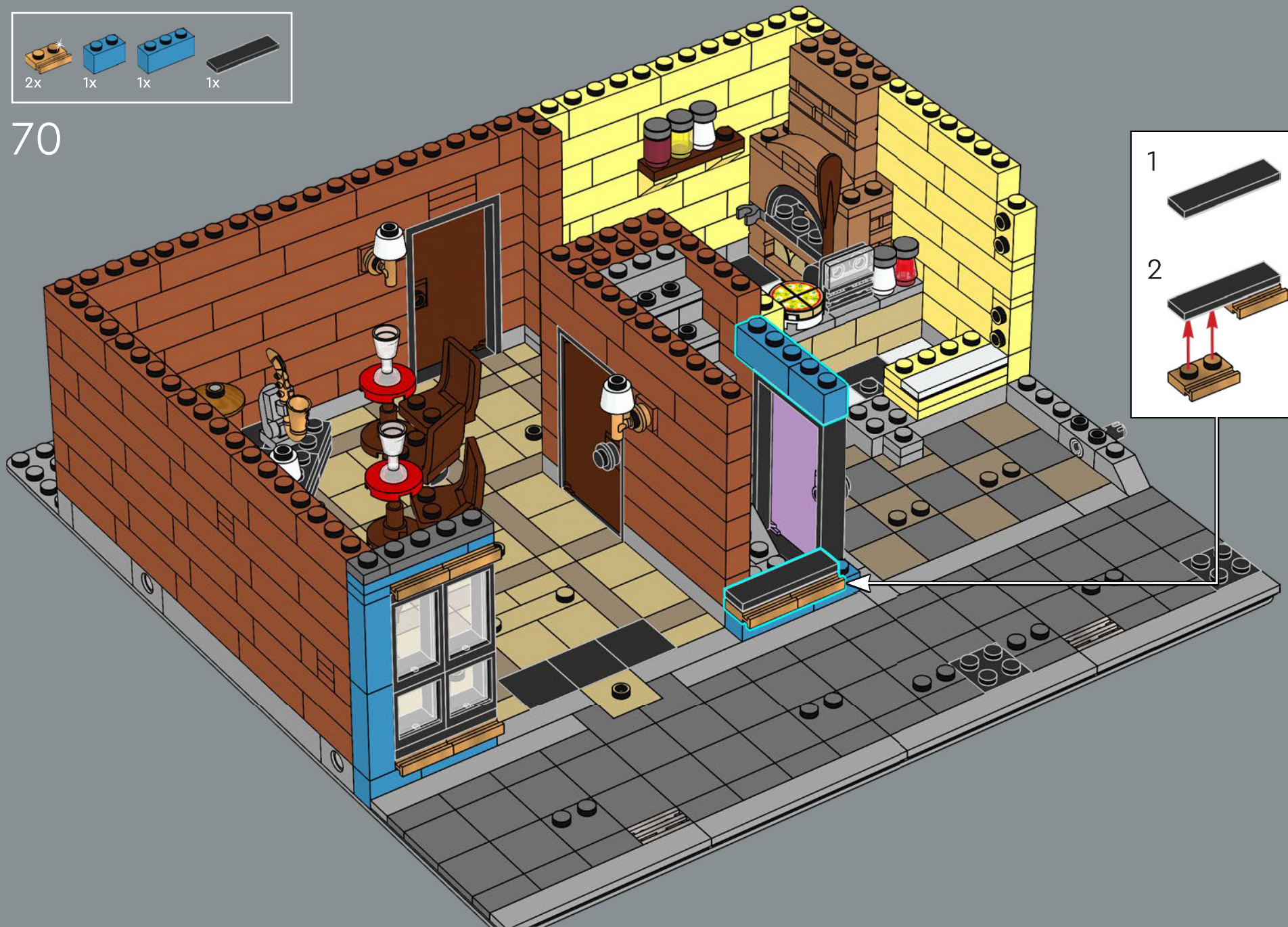

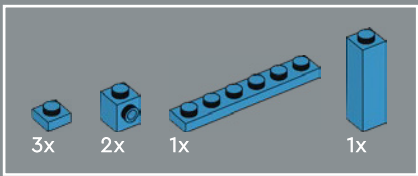

71

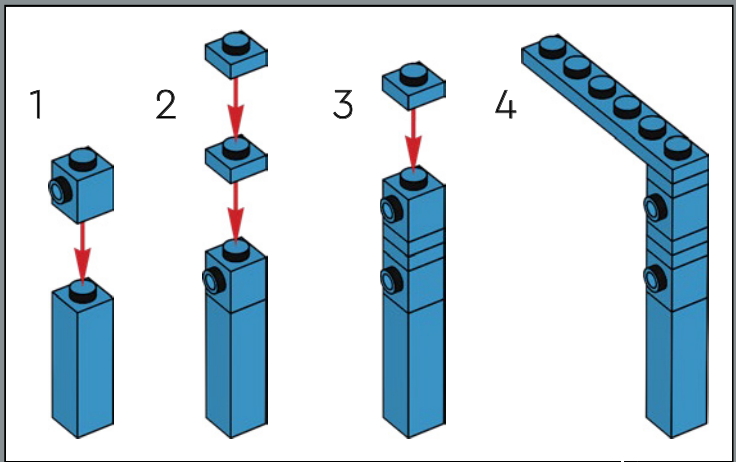

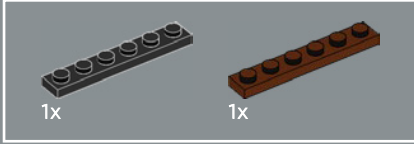

72

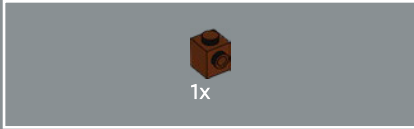
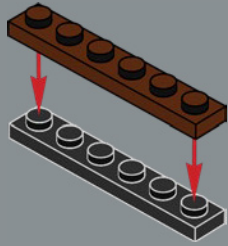

73

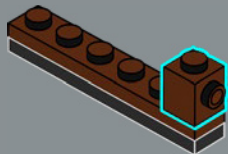

74

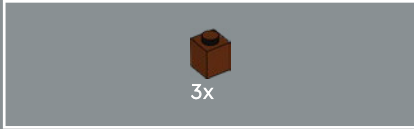

75

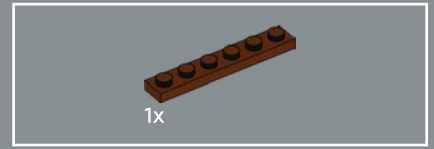

76

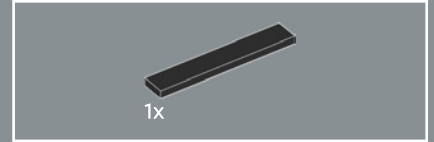

77



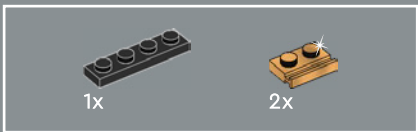

78

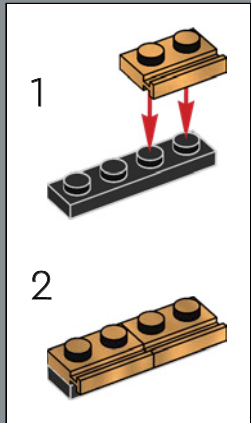

79



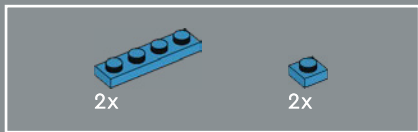

80

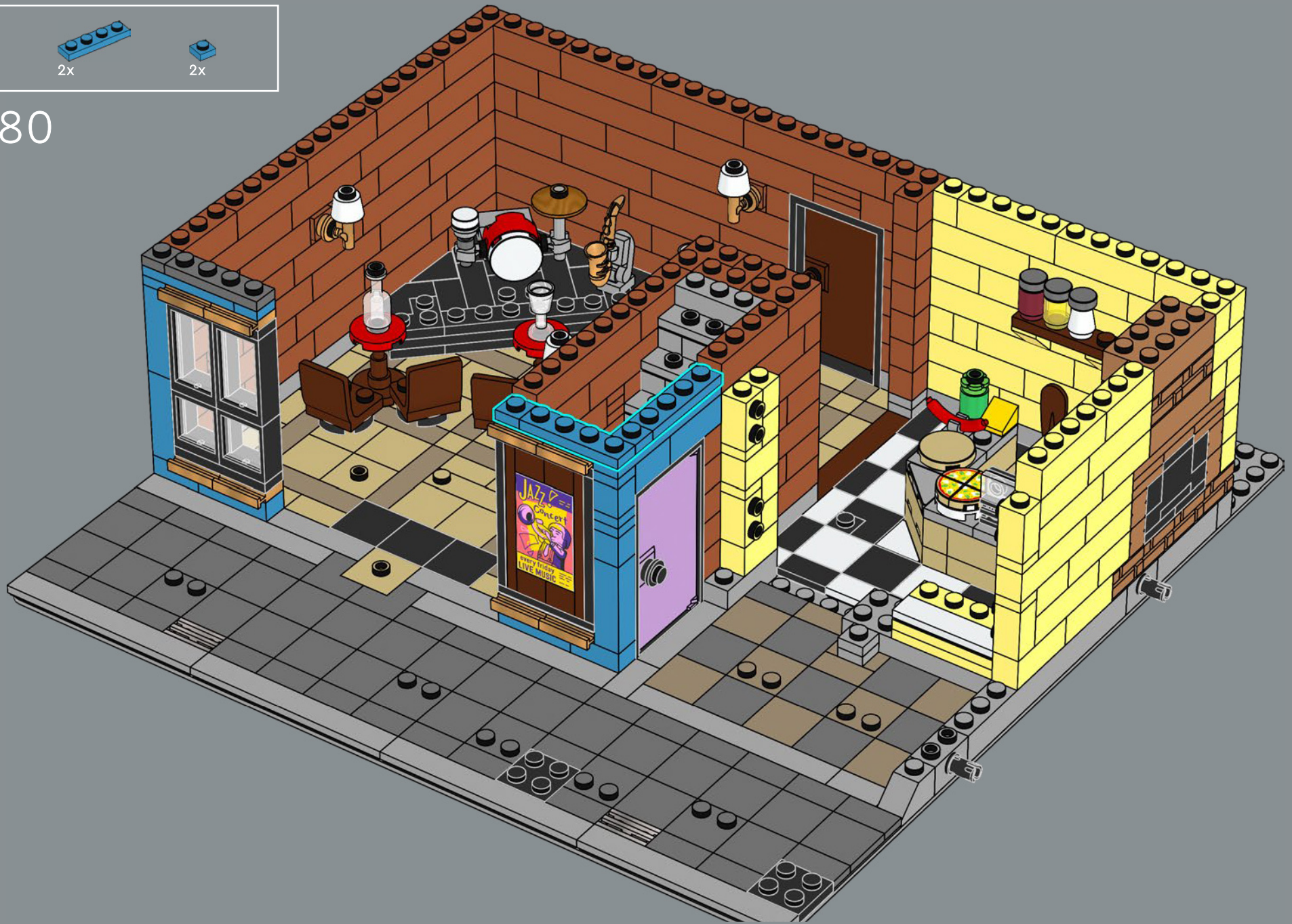

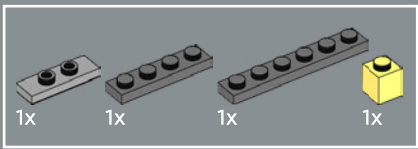

81



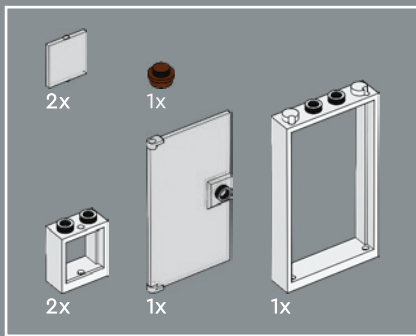

82

1

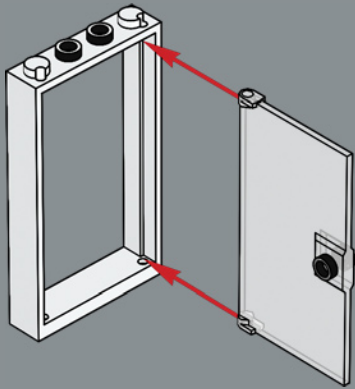

2



3

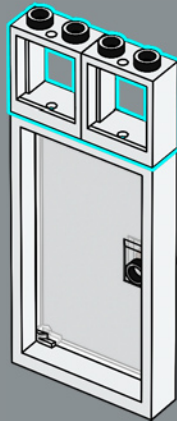

4

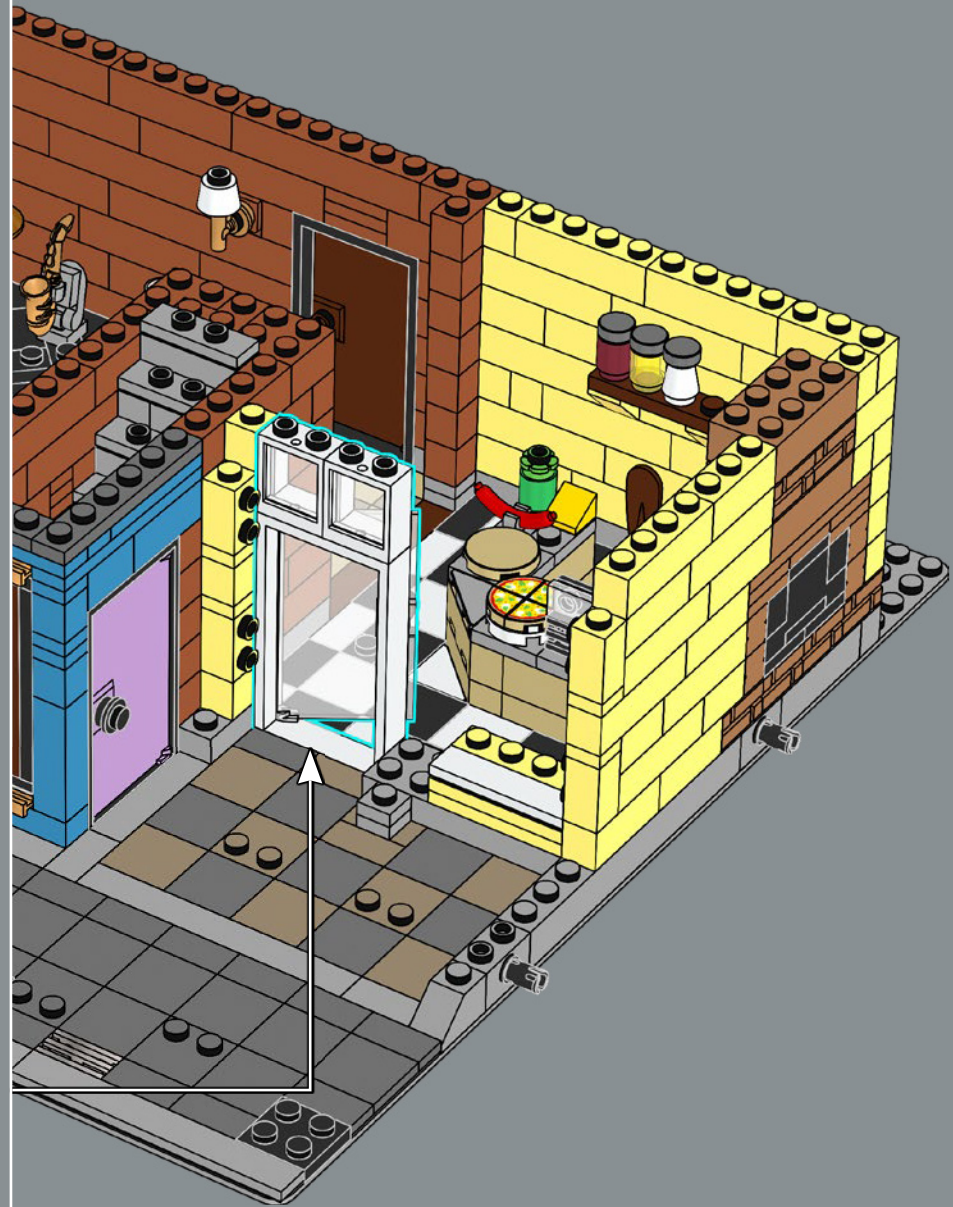
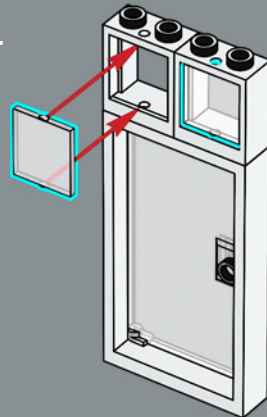

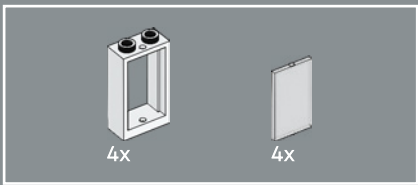

83

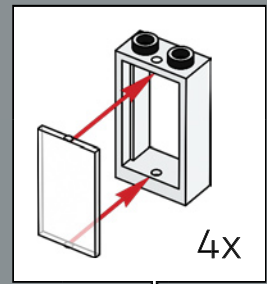

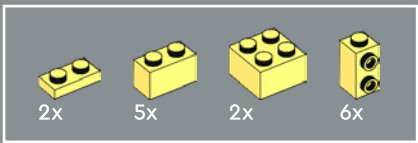

84

1

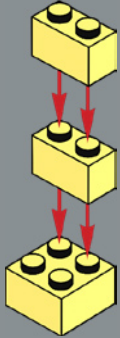

2

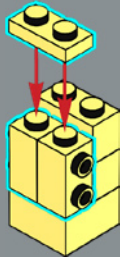

3

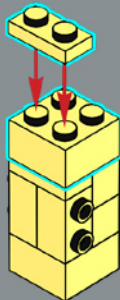

4

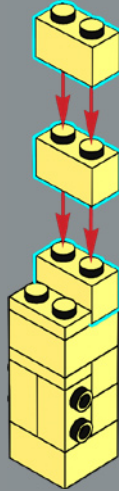

5

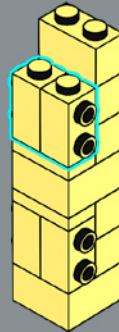

6

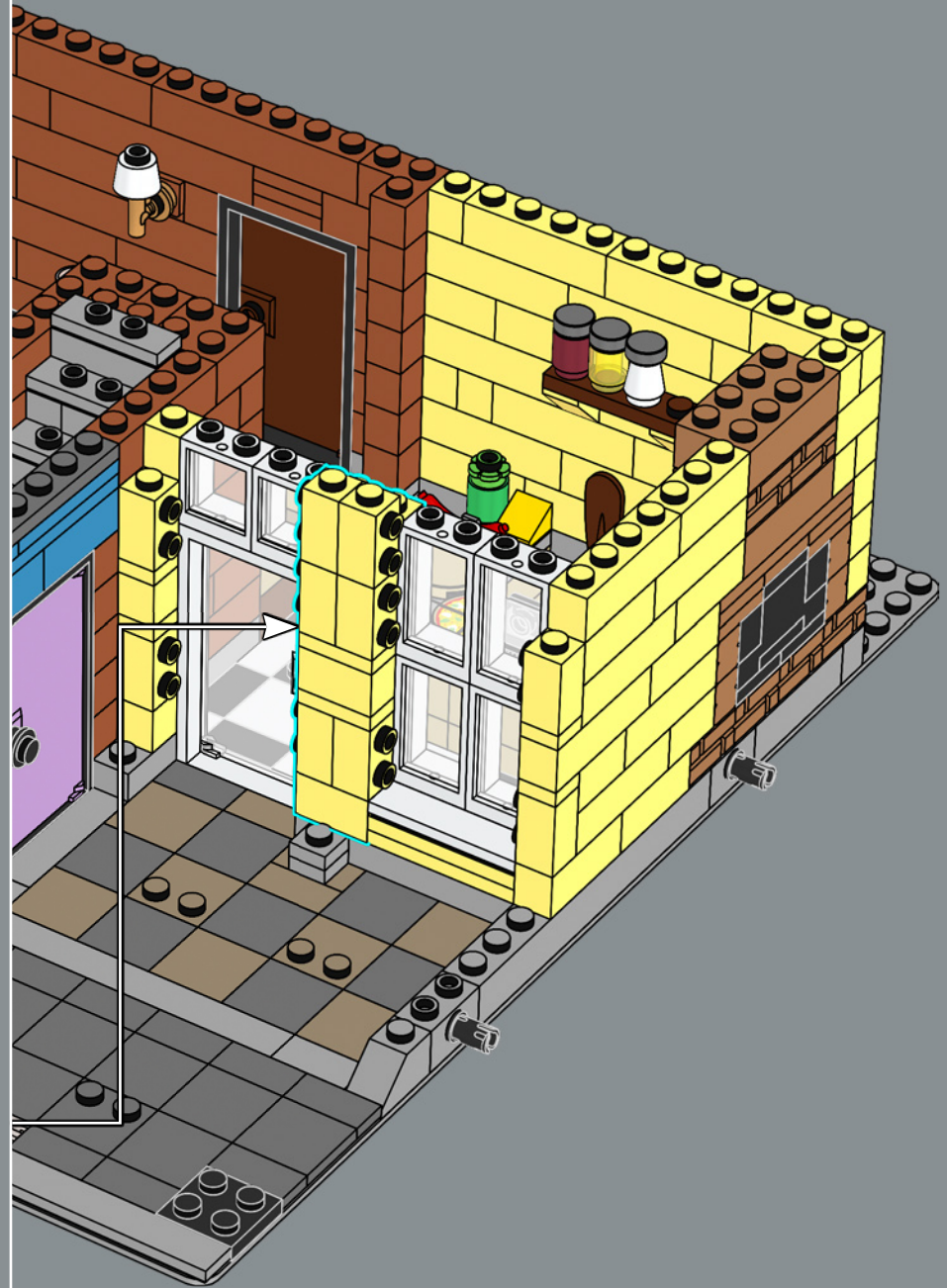



3x

85



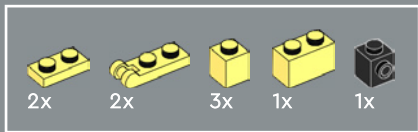

86

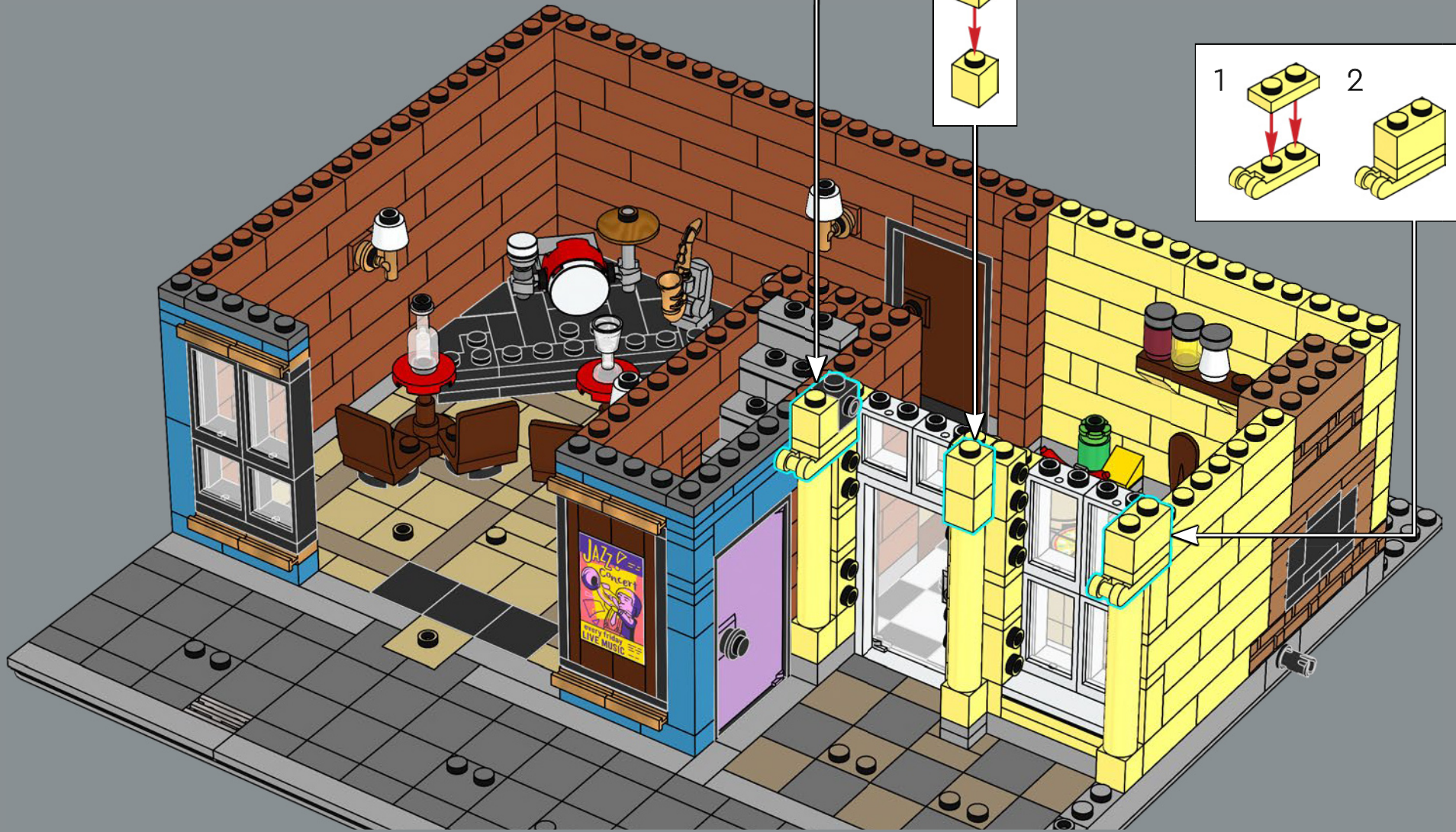
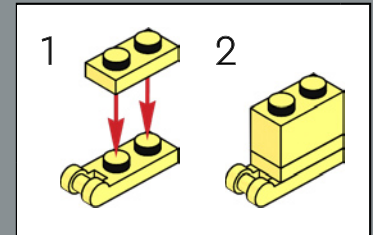
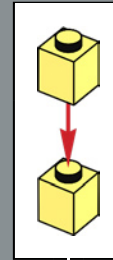
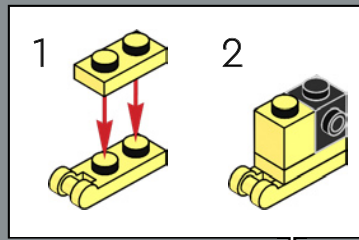

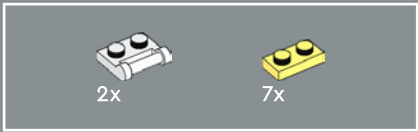

87

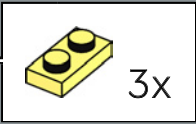
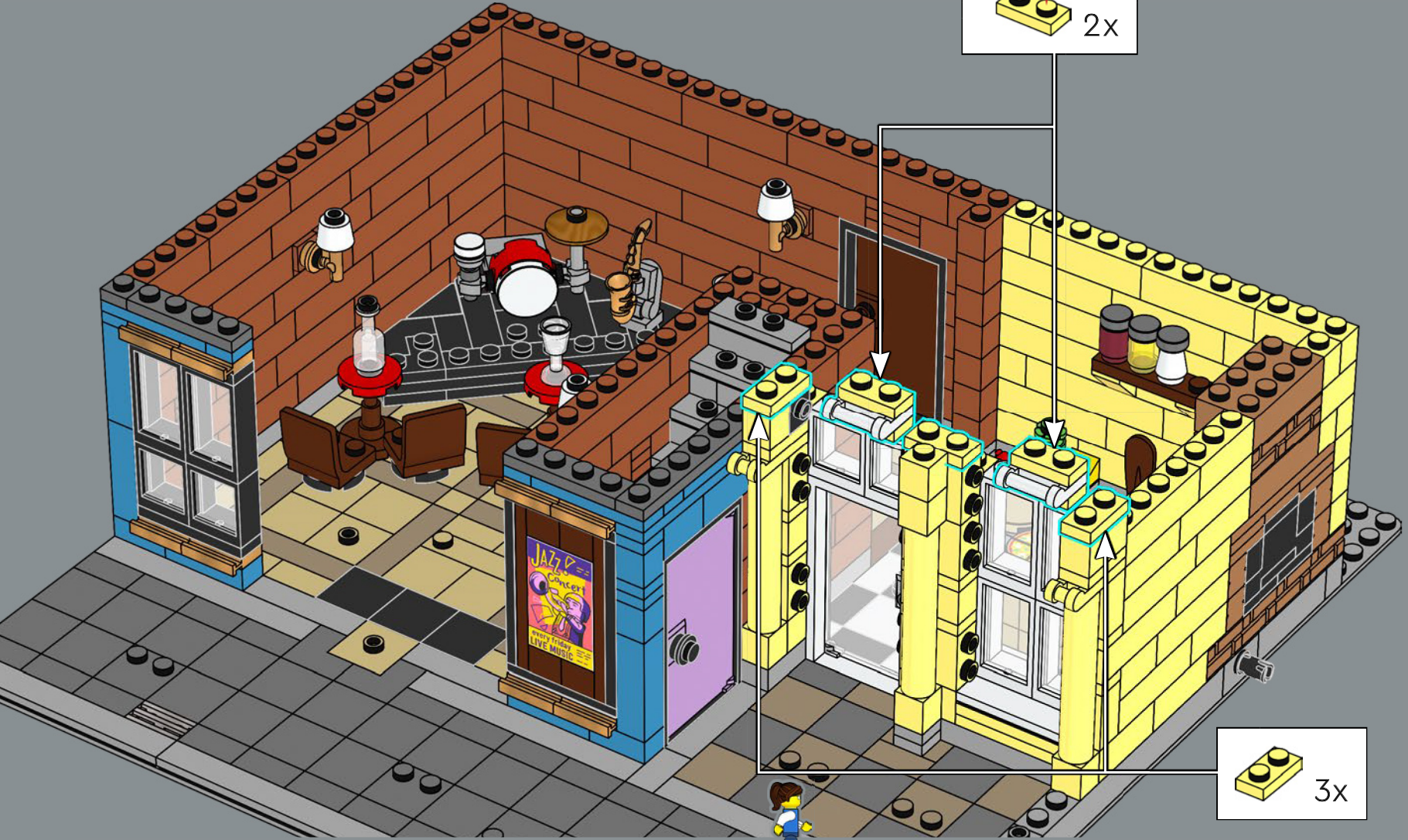
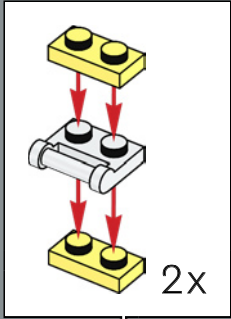

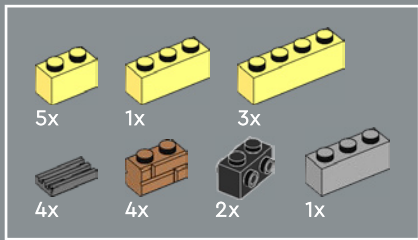

Add in these ventilation units to keep things cool.
The oven, and the music, can get pretty hot!

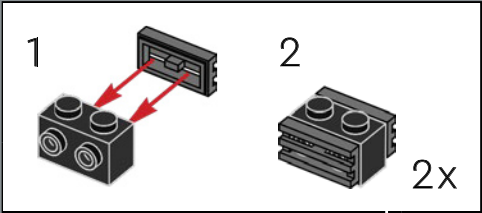

88



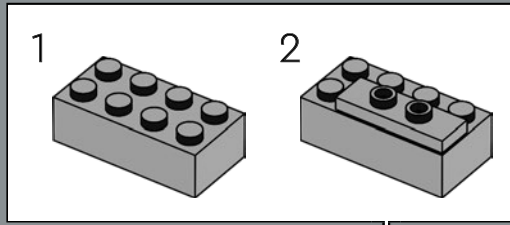
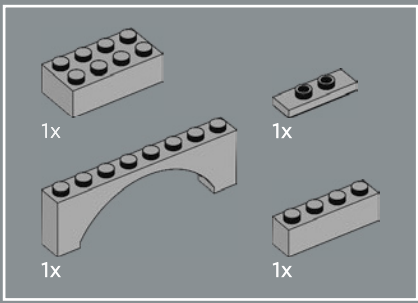

89



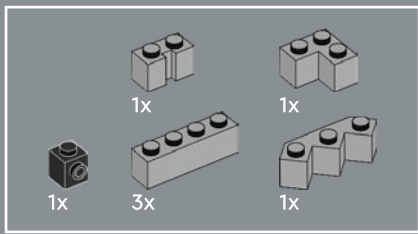

90



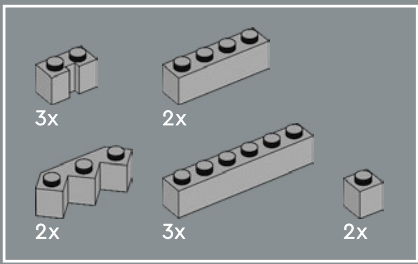

91

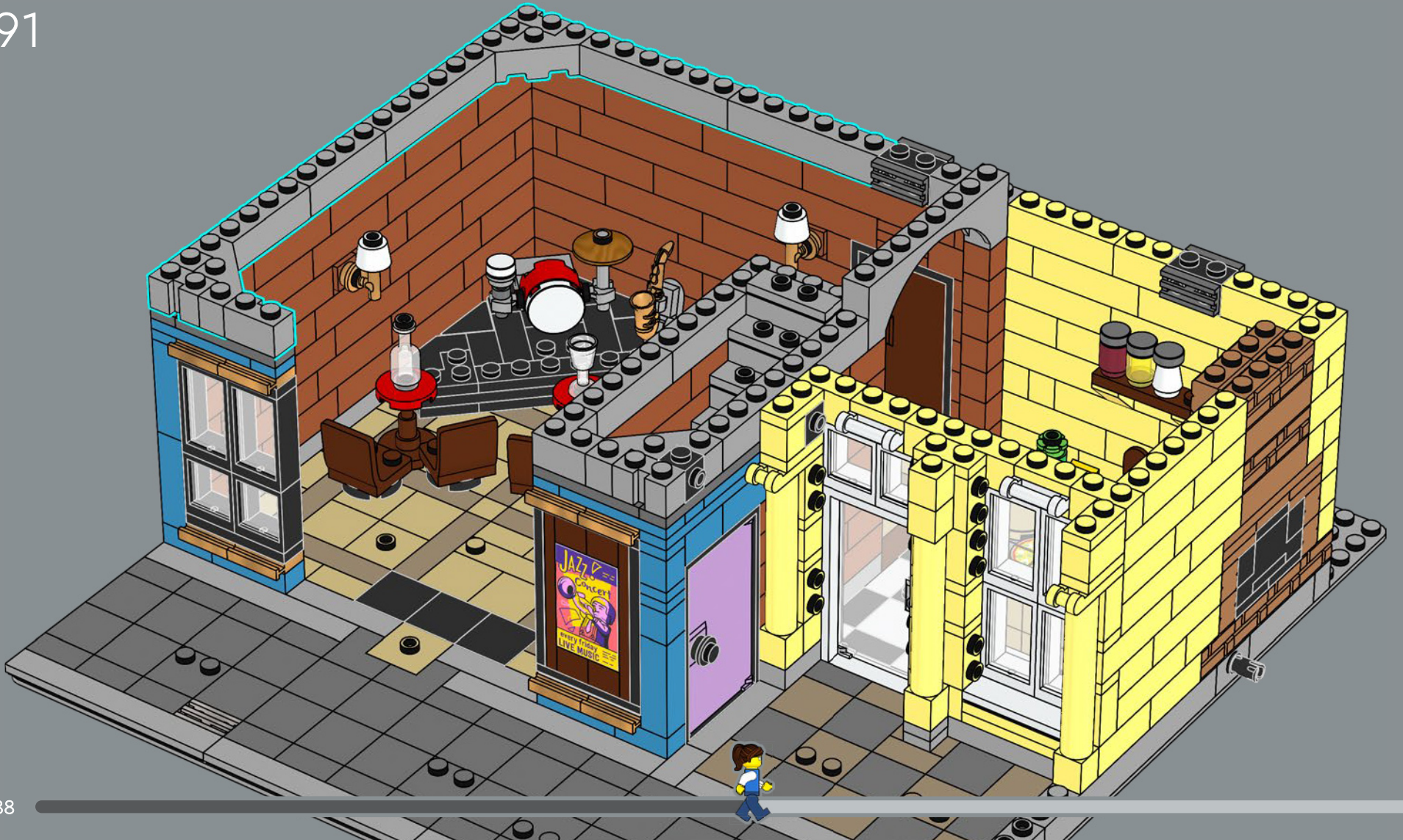

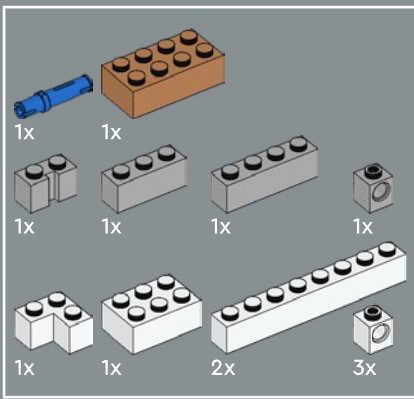

92

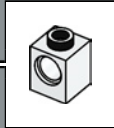
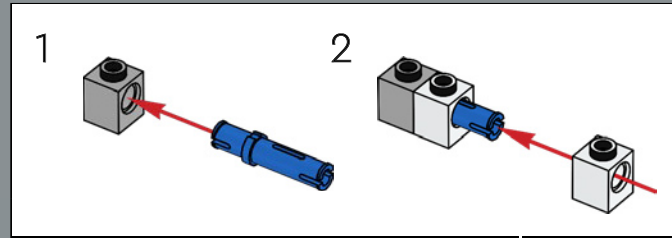

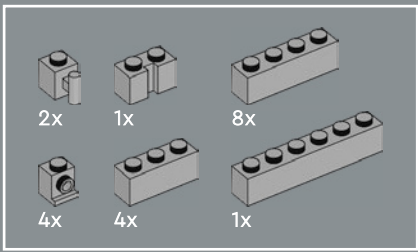

93



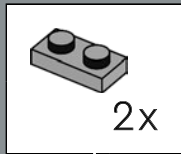
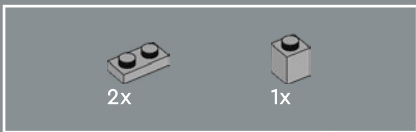

94

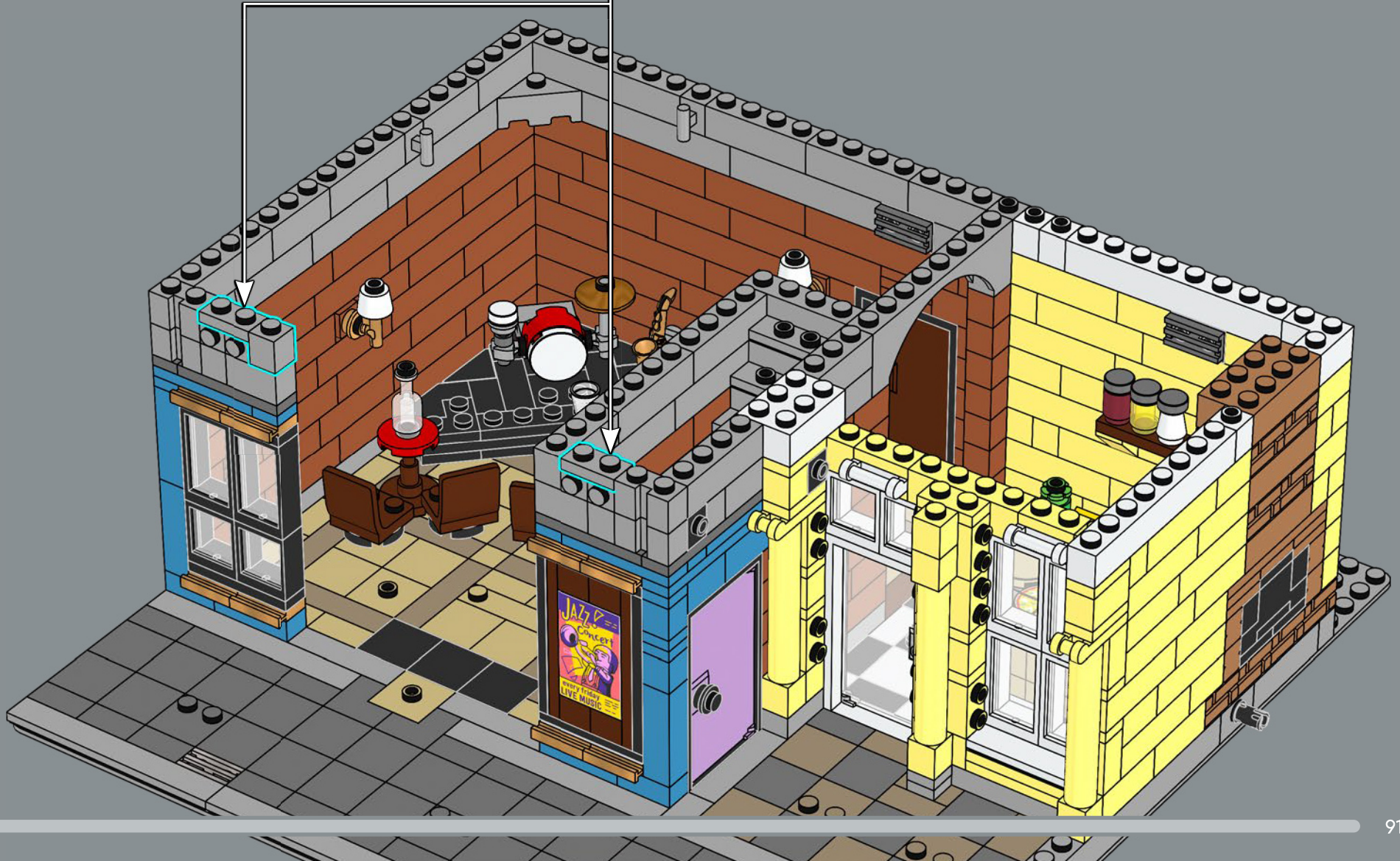

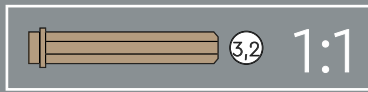
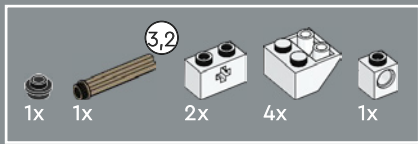

95

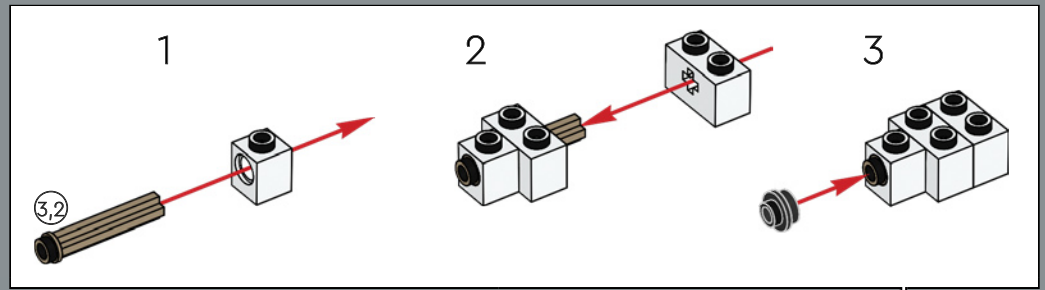

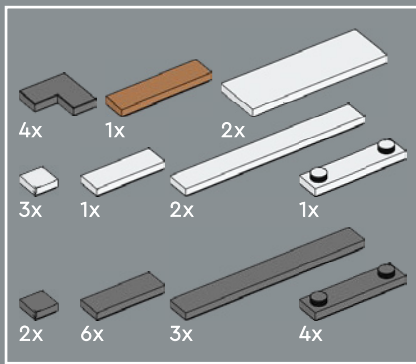

96



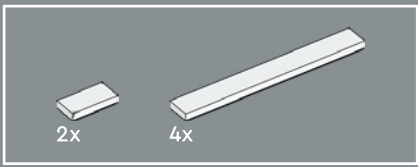

97

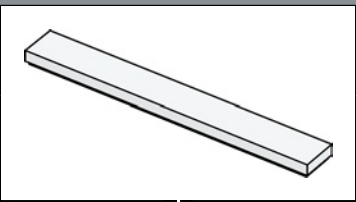



98

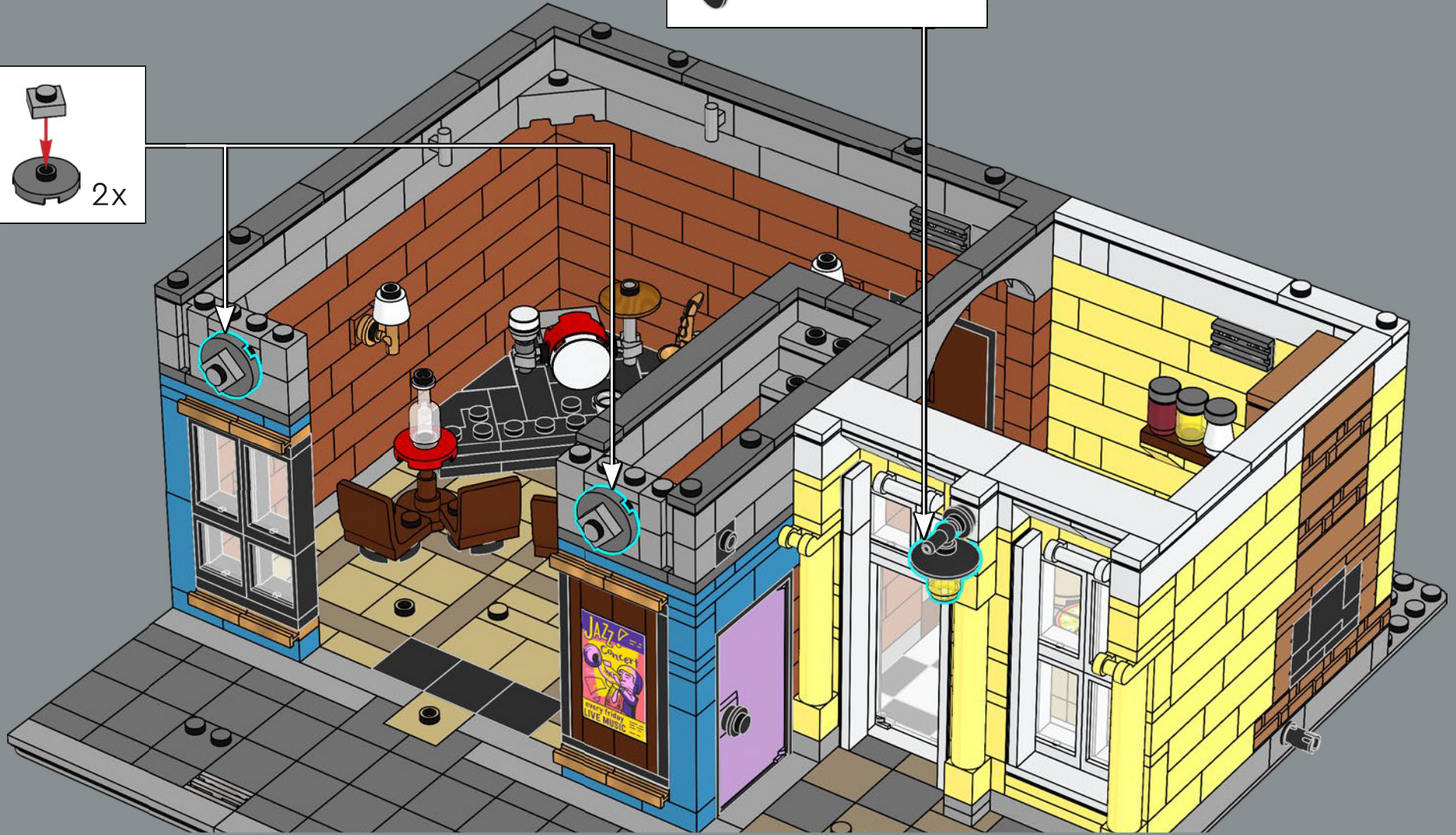
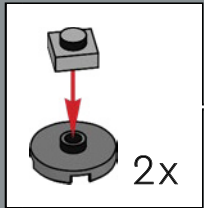
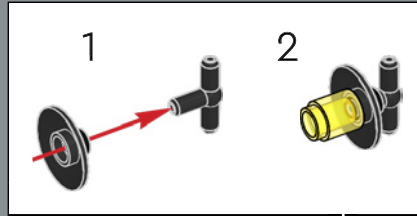

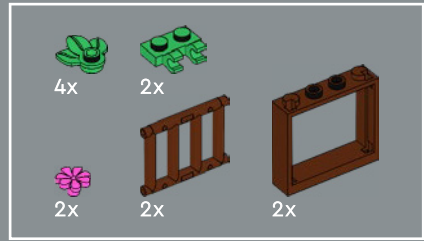

99

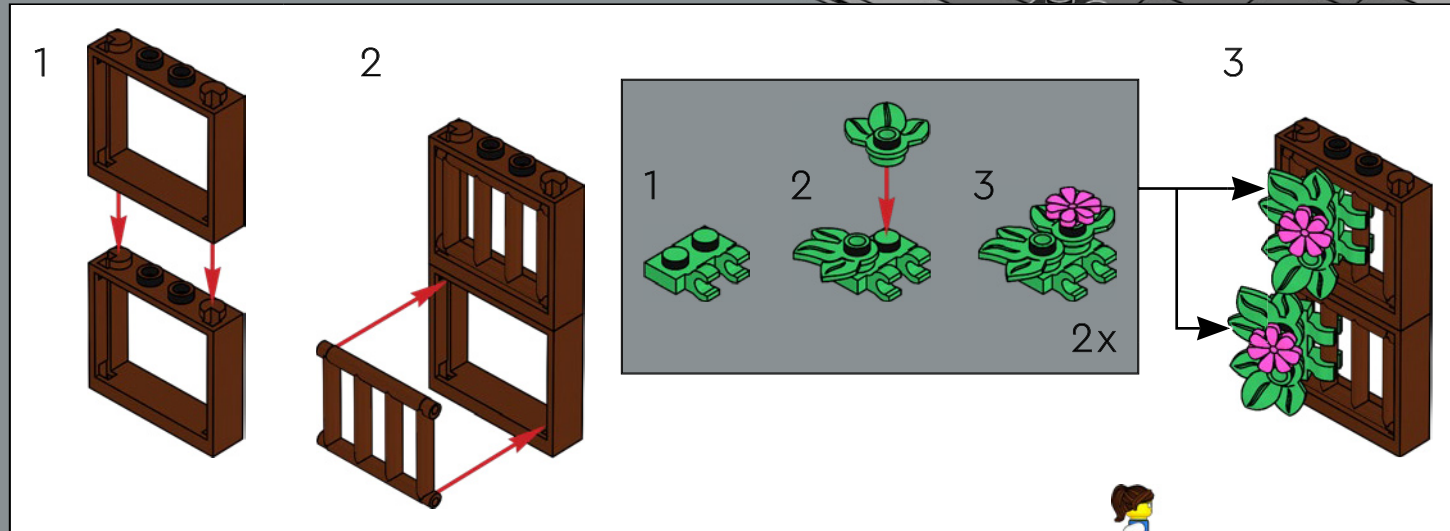



100

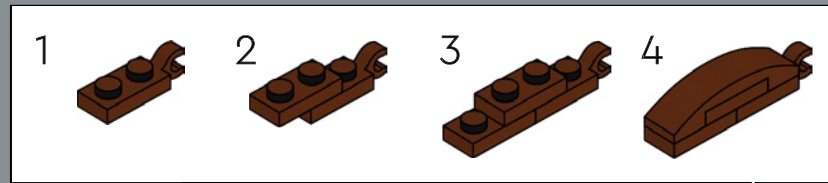

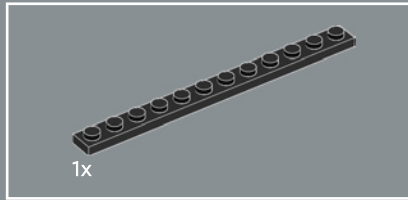

101

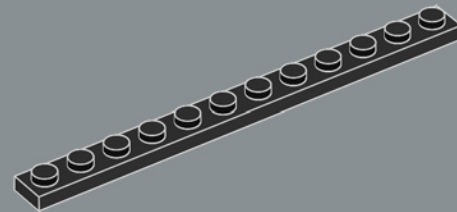

102

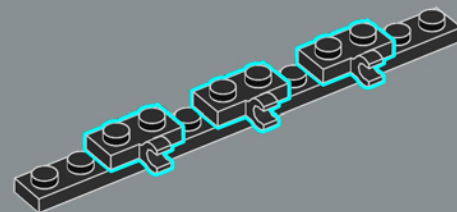

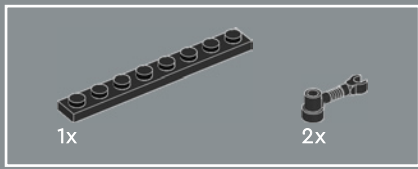

103

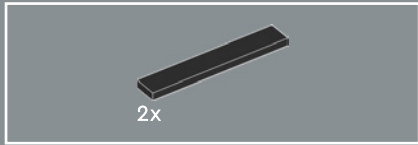
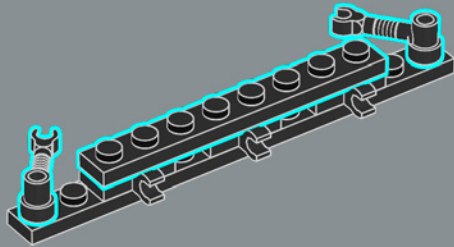

104

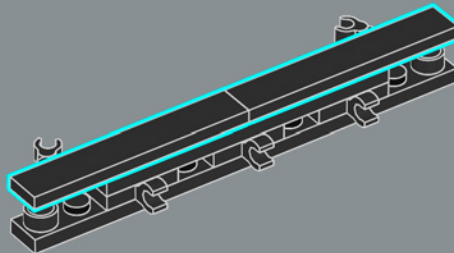

105

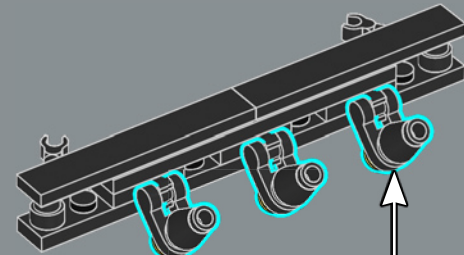

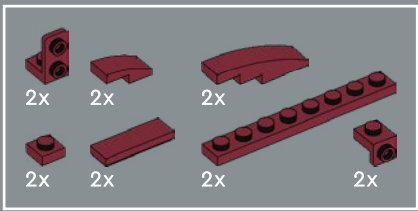

106

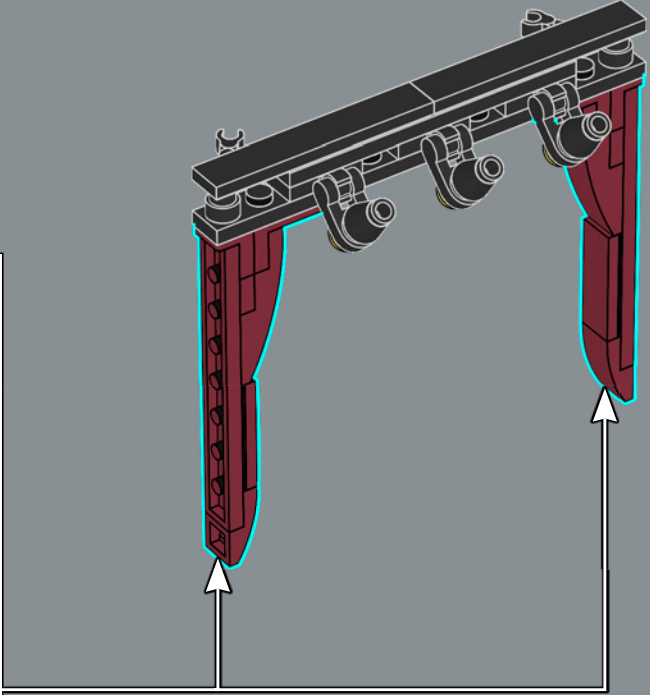
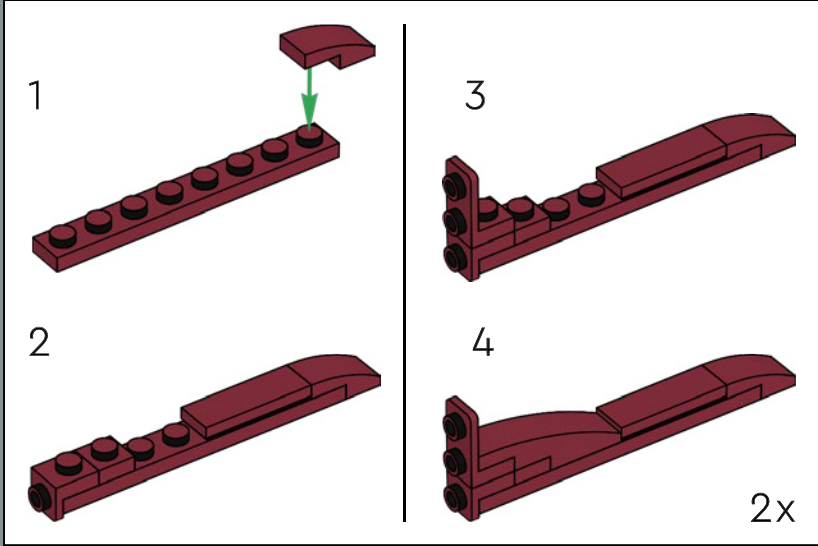

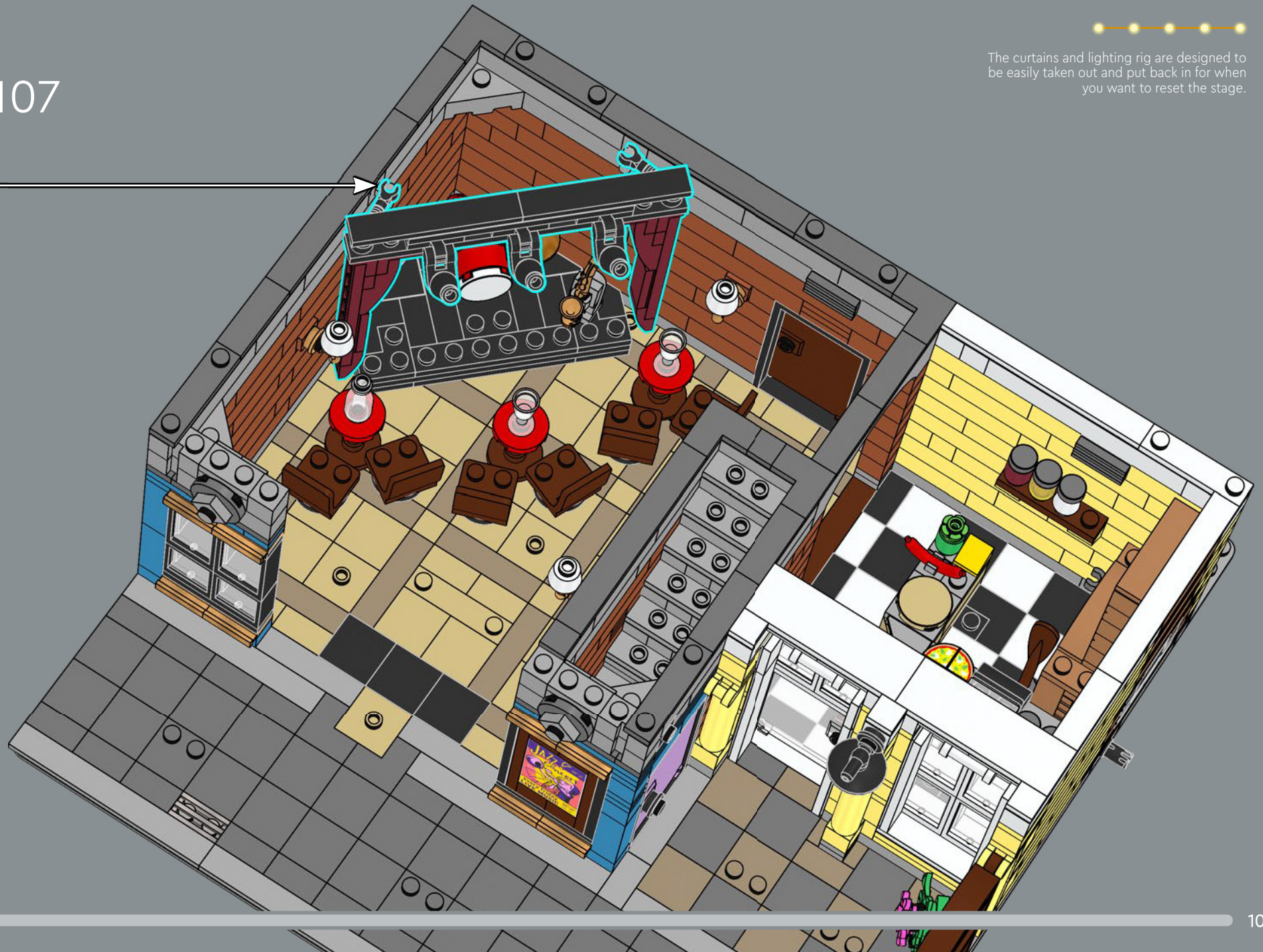

The curtains and lighting rig are designed to be easily taken out and put back in for when you want to reset the stage.

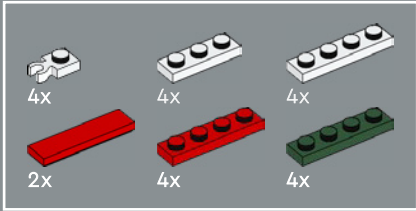

108

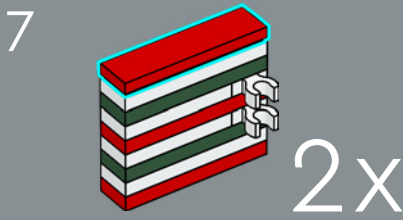
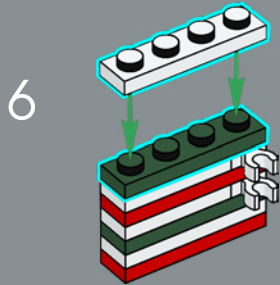
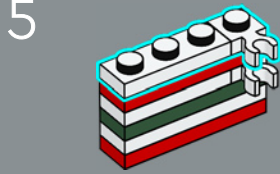
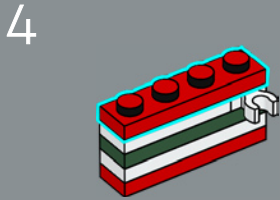
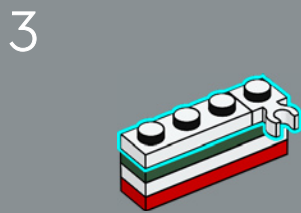
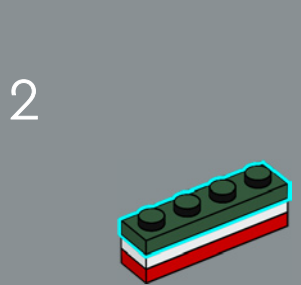
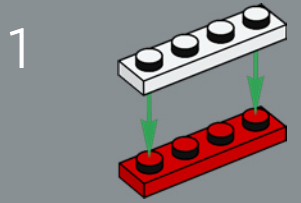



109

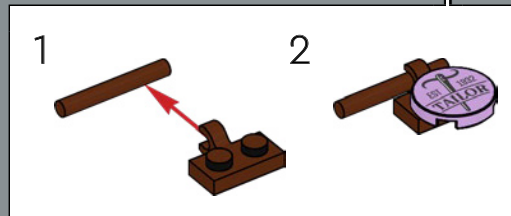
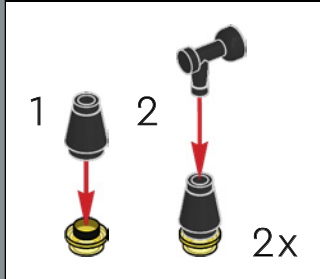



115

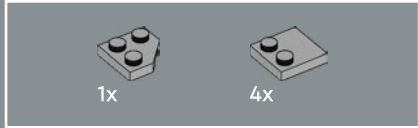
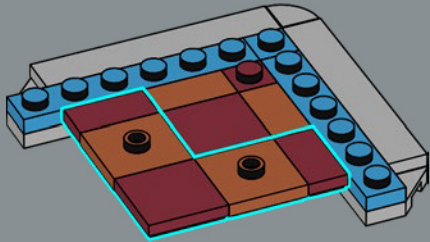

116

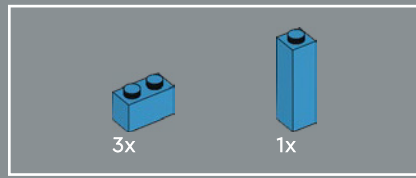
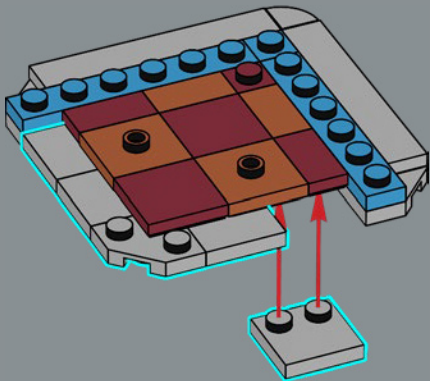

117

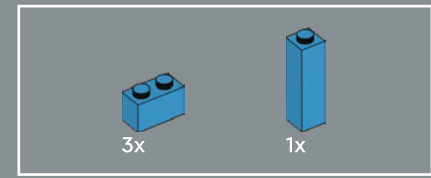
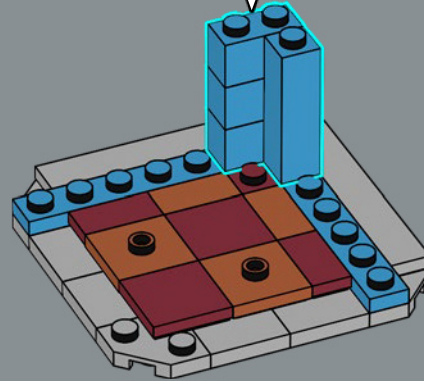
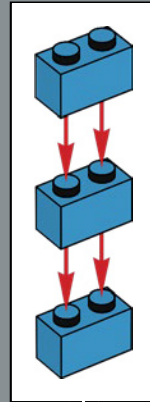

118

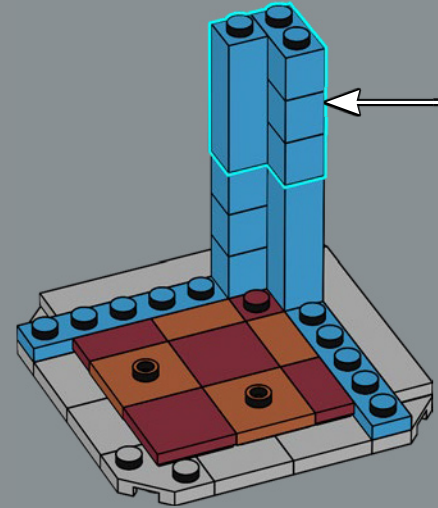
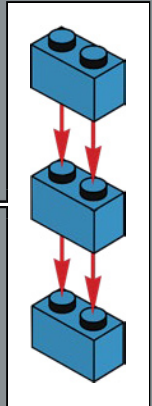

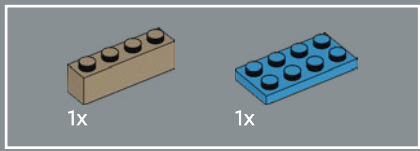

119

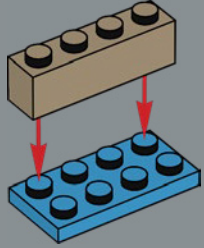

120

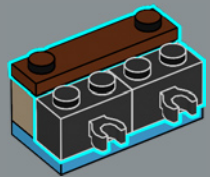

121

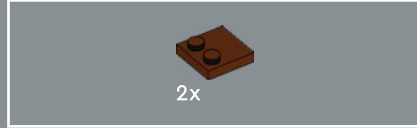
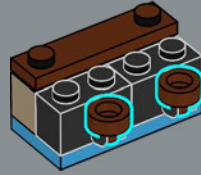

122

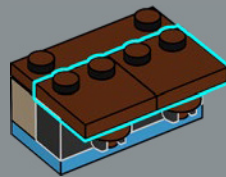

123

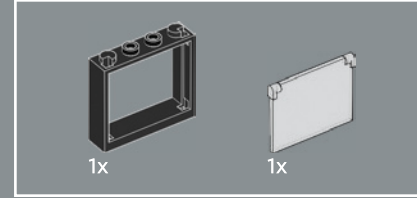
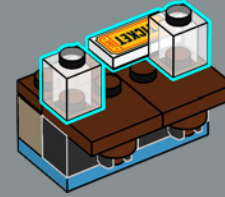

124

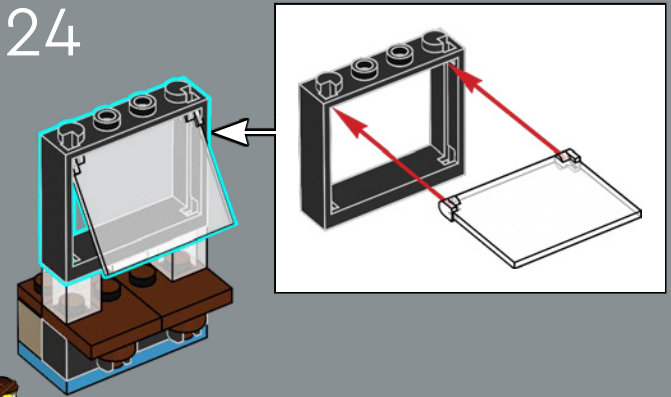

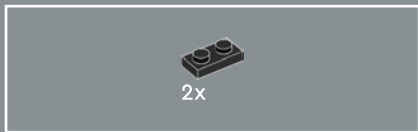

125

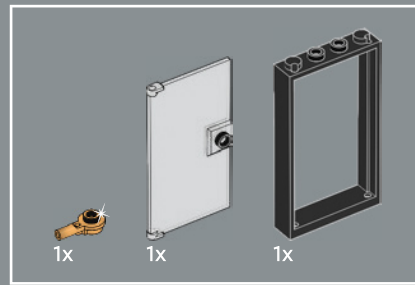
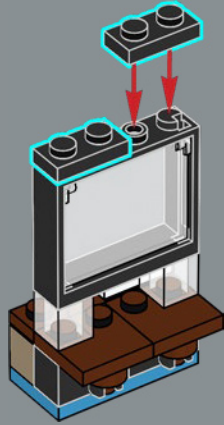

127

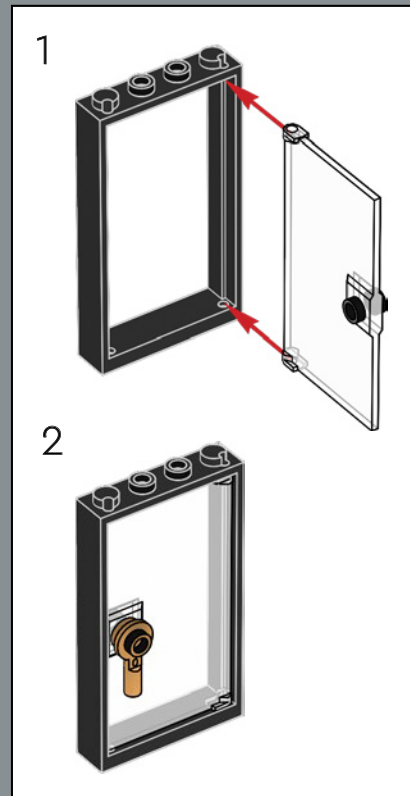

126

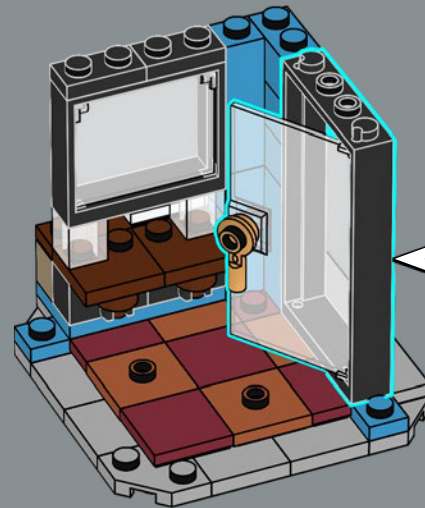
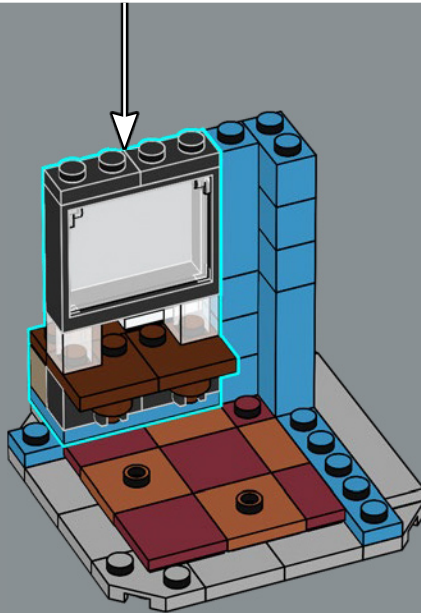



4x

128

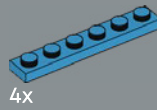
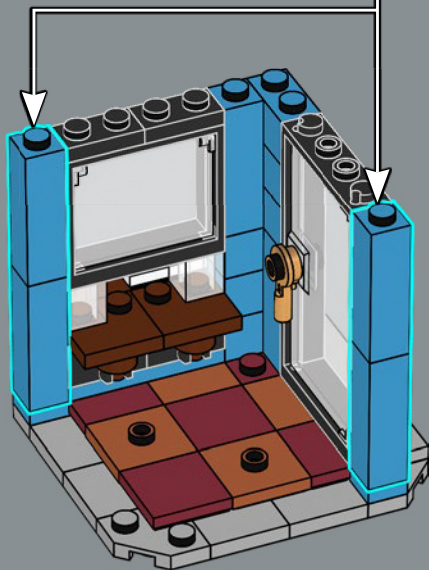
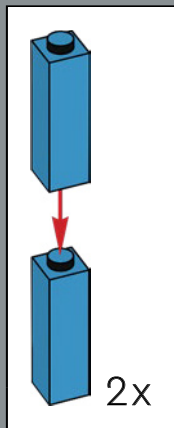

4x



2x

129

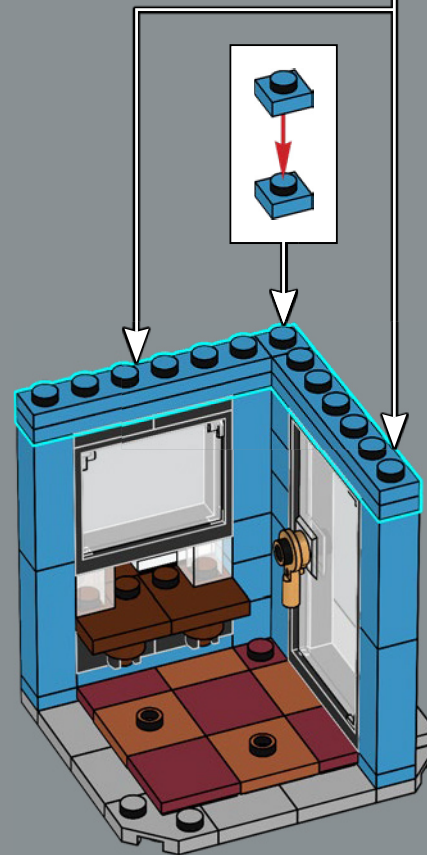
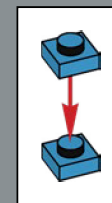
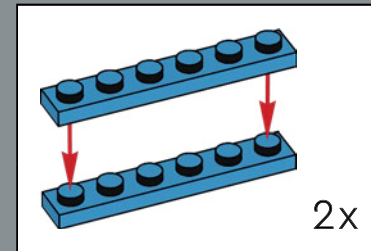

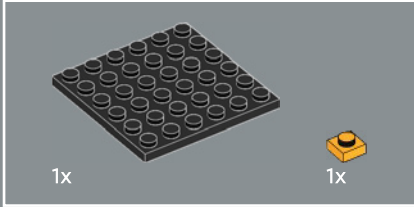

130

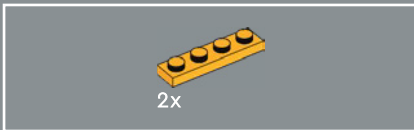
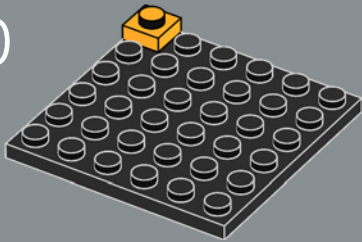

131

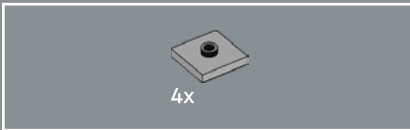
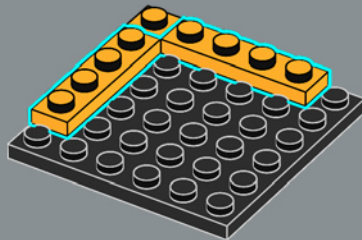

132

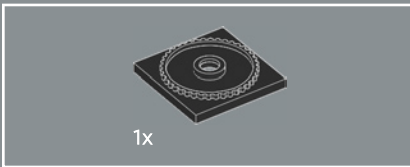
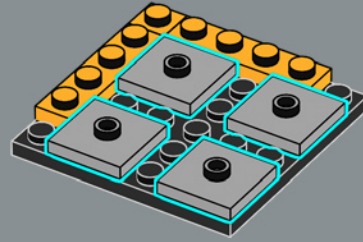

133

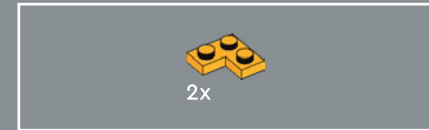
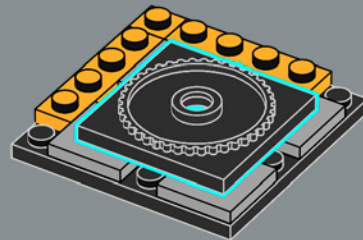

134

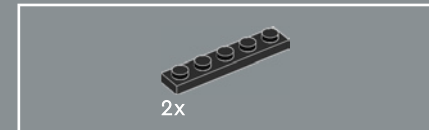
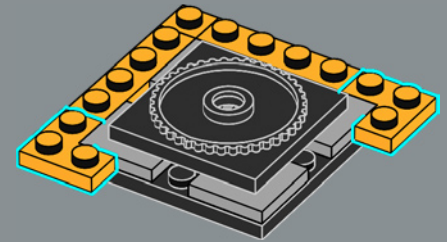

135

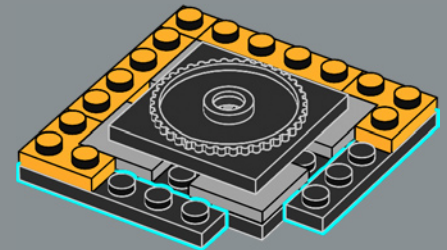

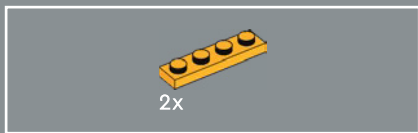

136

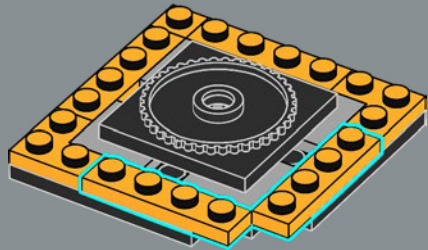

137

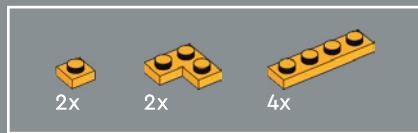
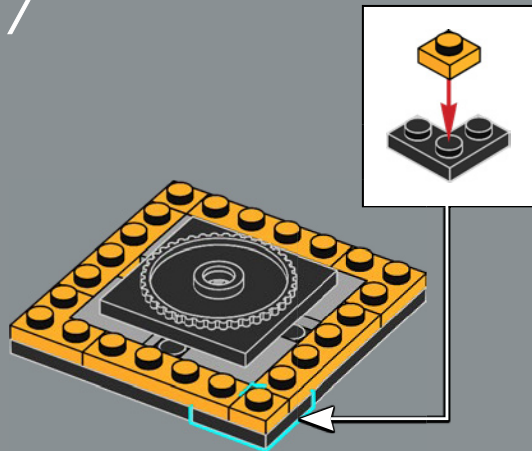

138

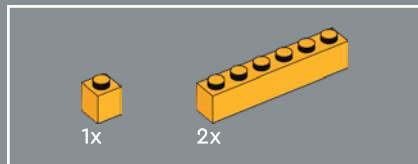
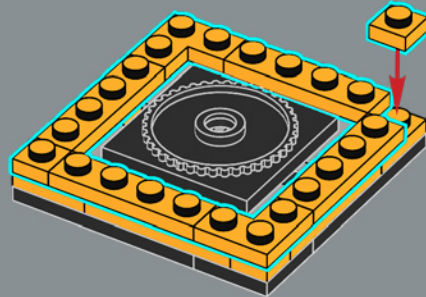

139

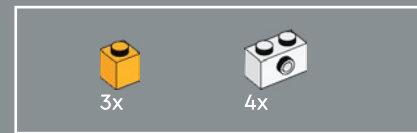
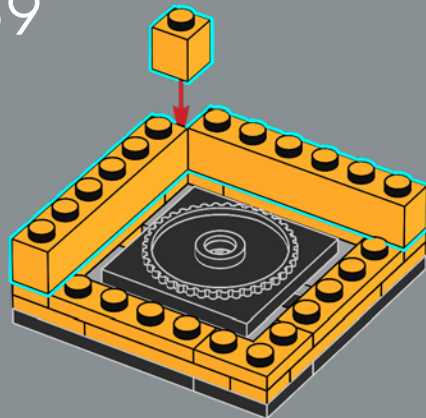

140

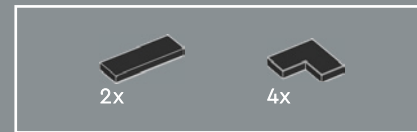
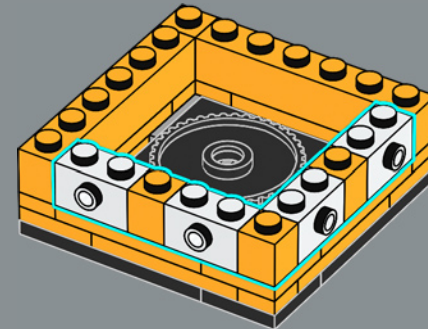

141

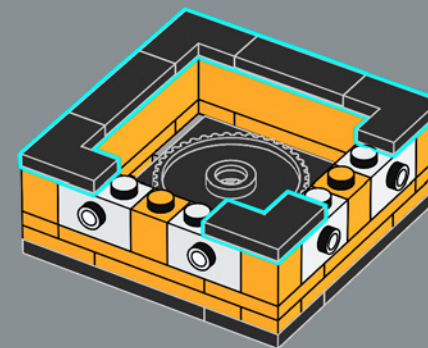



142

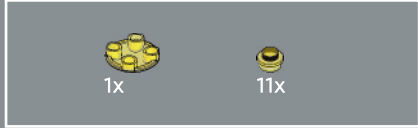
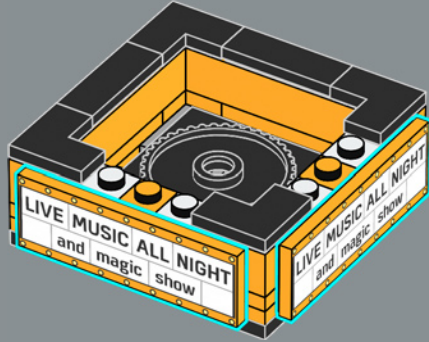

143

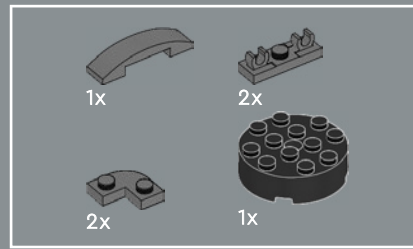
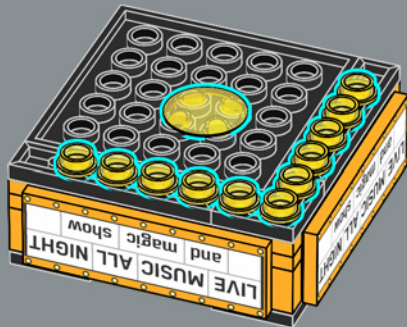

144

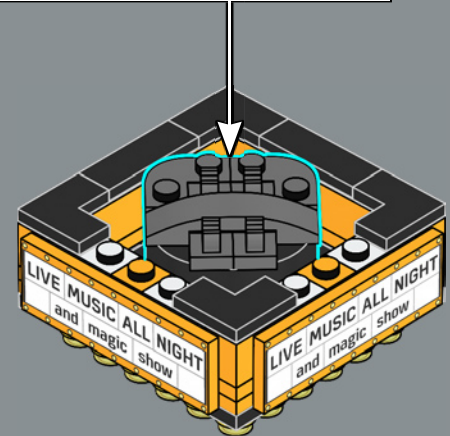
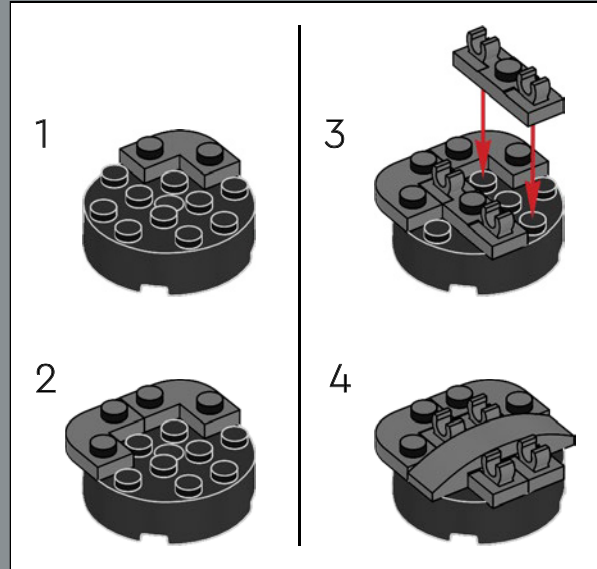

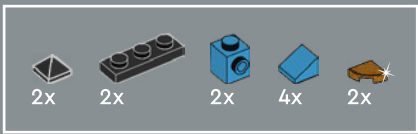

145

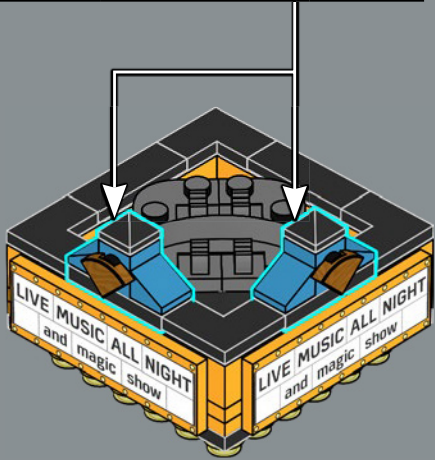
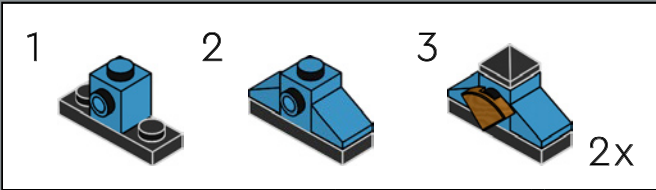

The Jazz Club not only supports music but all kinds of performing arts as well. Stay late enough and see what new tricks the local magician has up her sleeve.

146

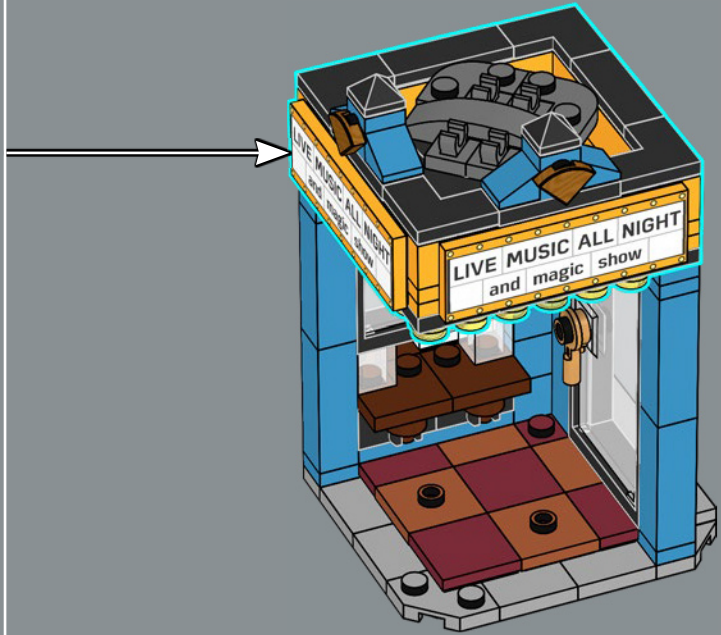

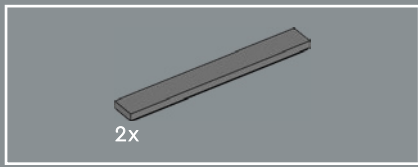

147

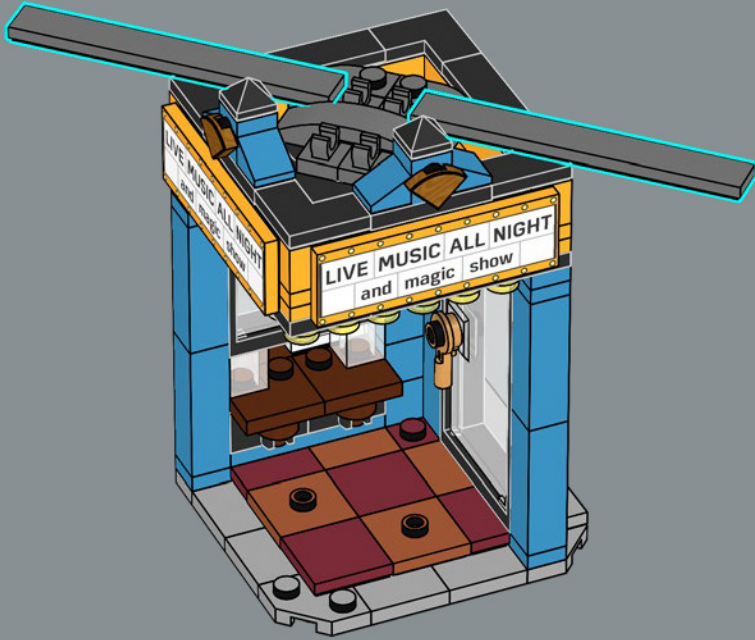

148



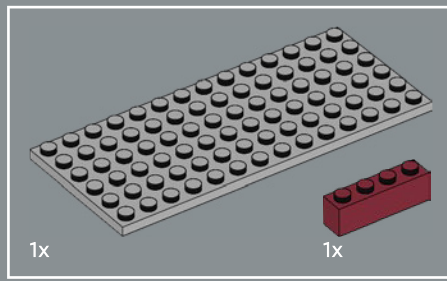

149

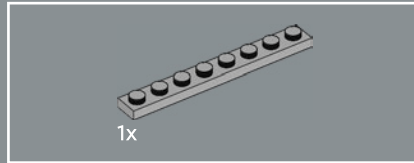
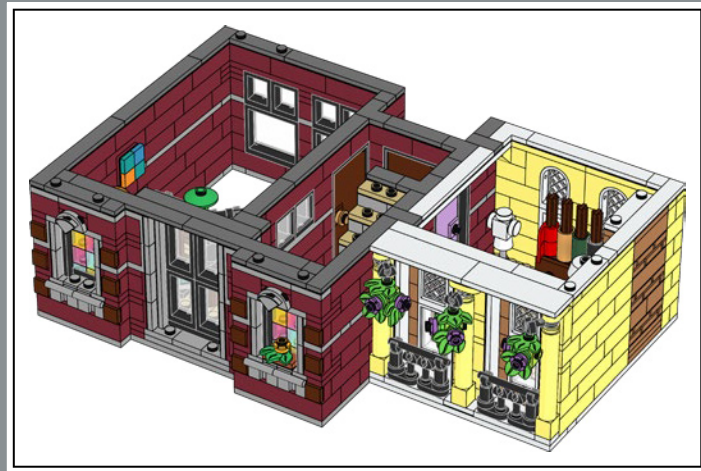
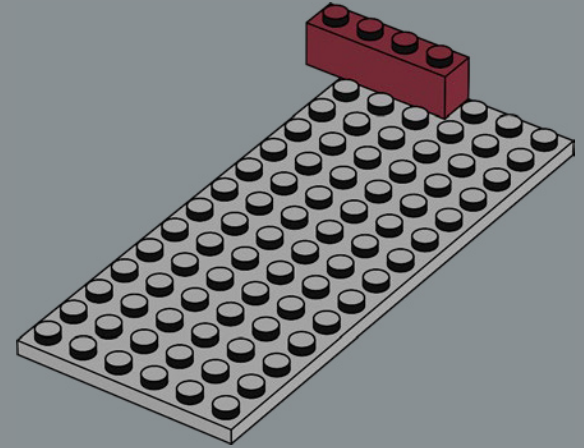

150

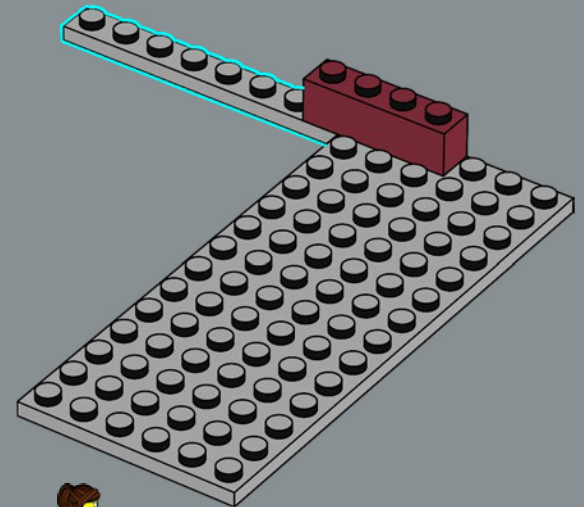

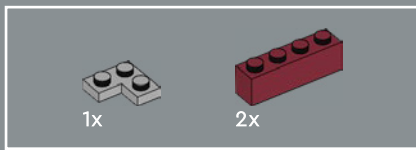

151

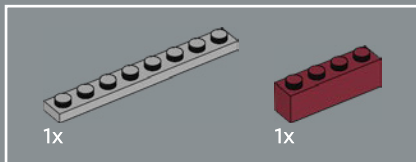
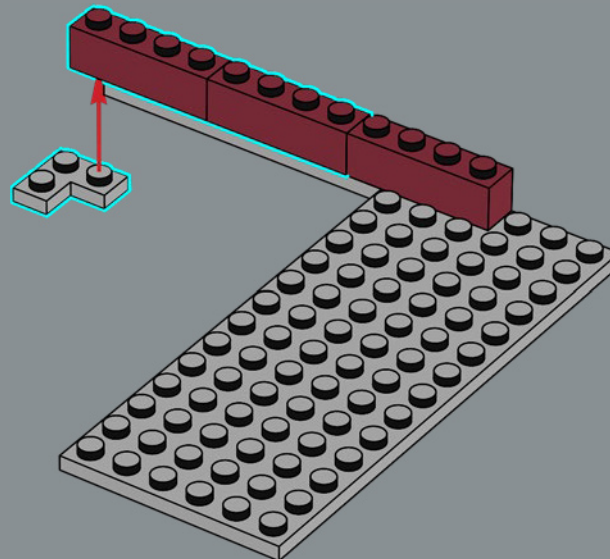

152

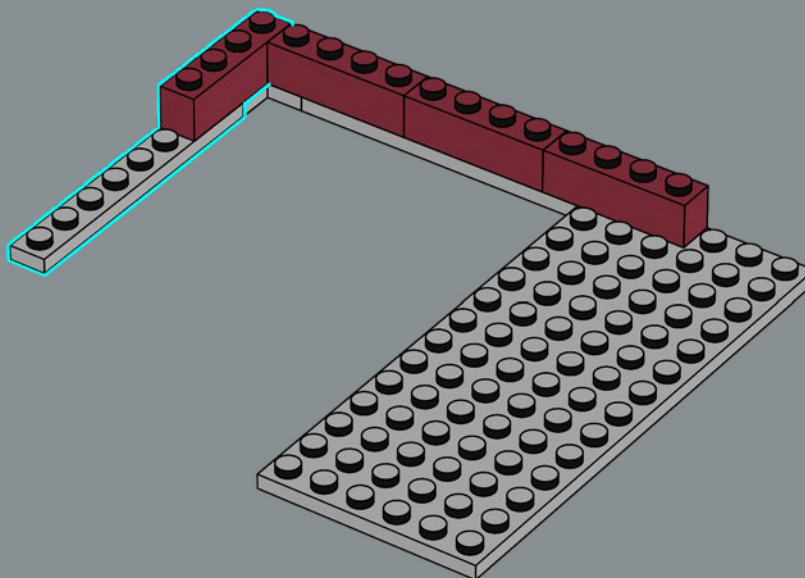

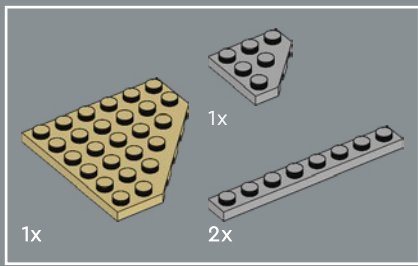

153

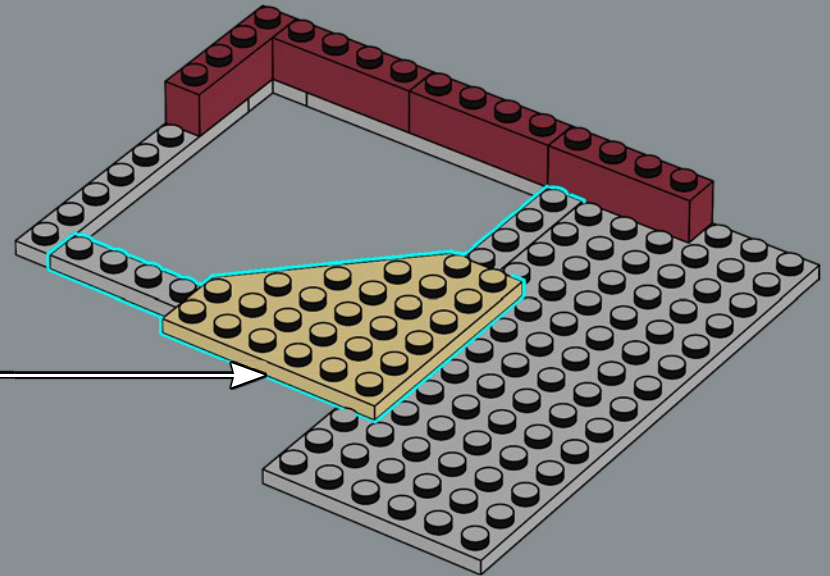
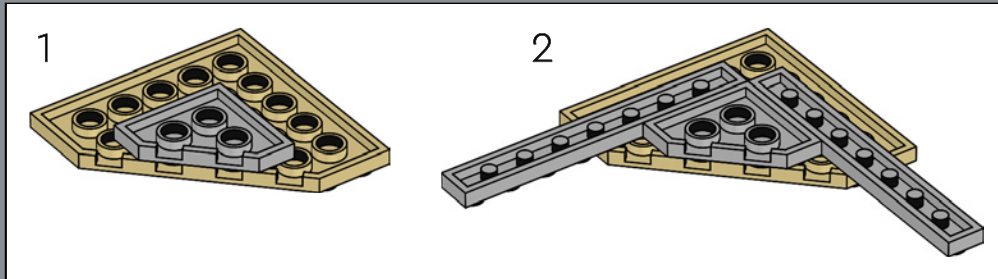

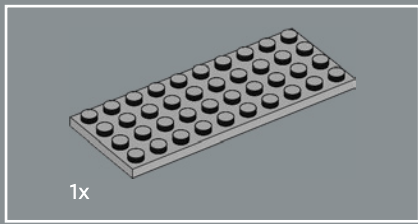

154

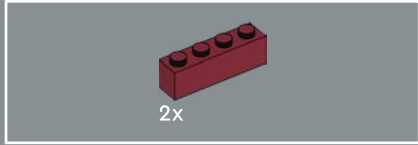
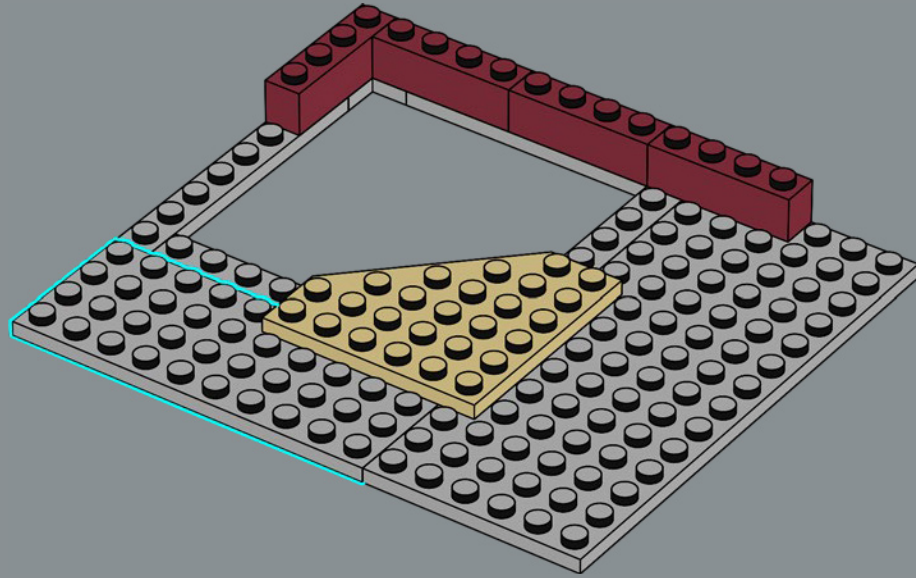

155

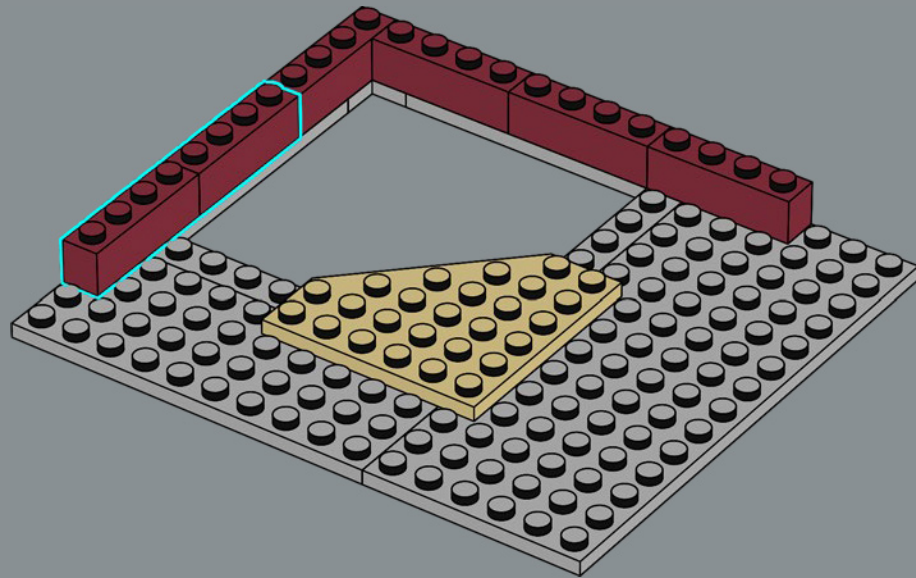

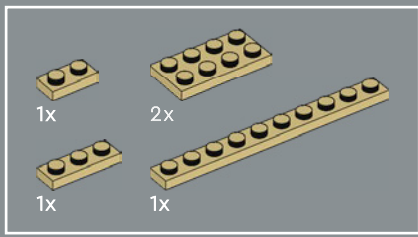

156

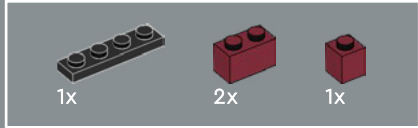
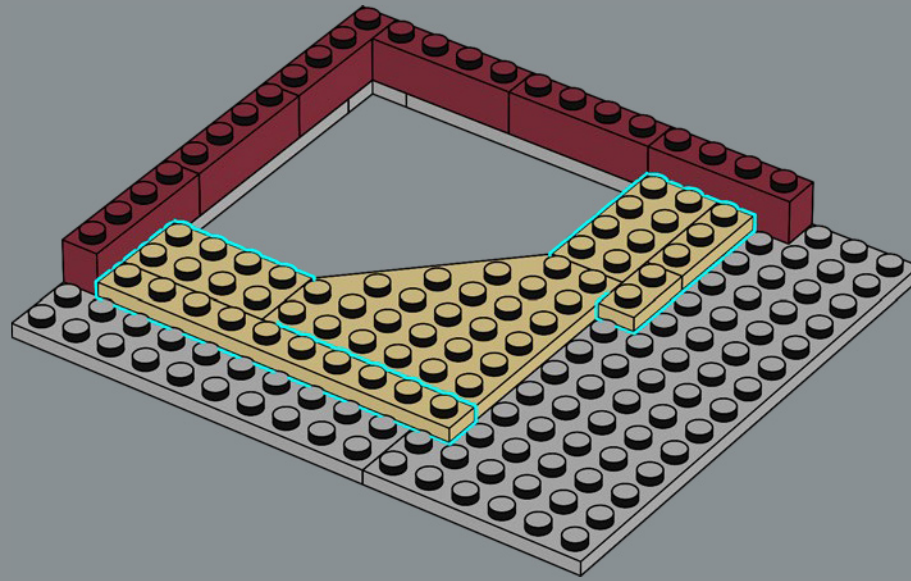

157

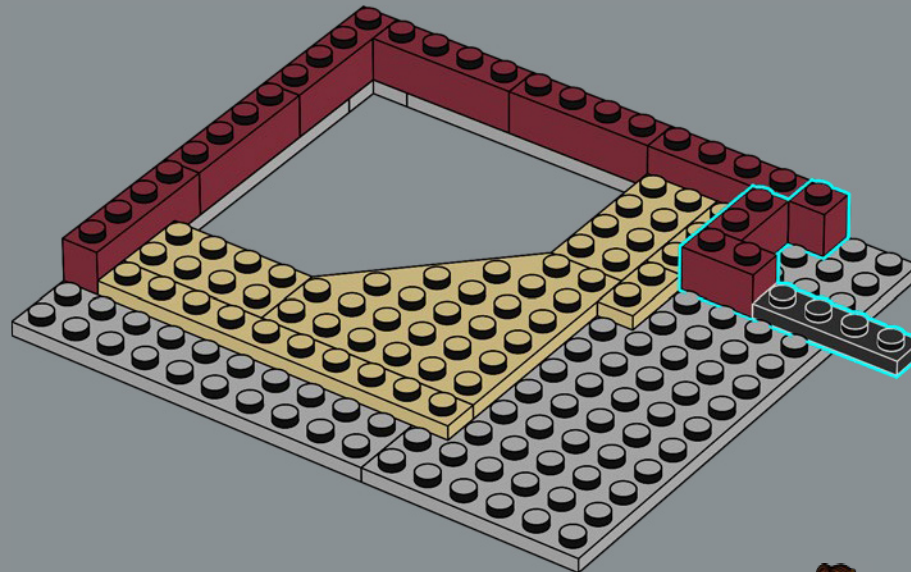

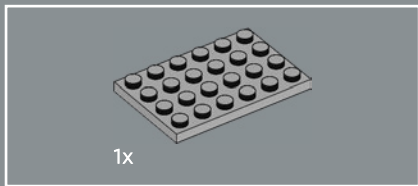

158

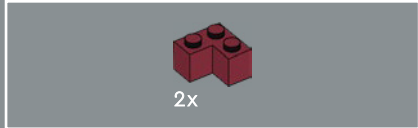
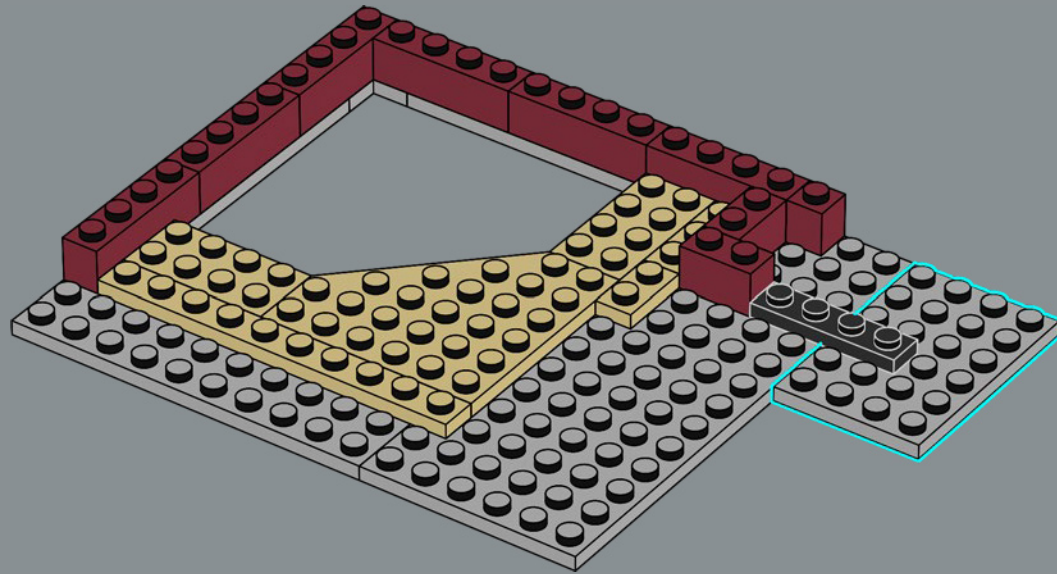

159

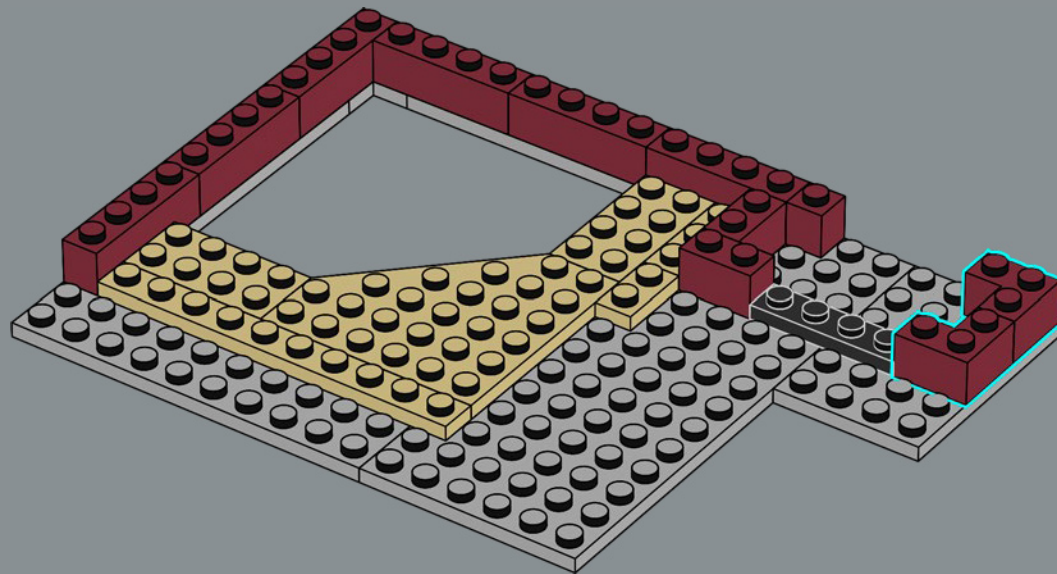

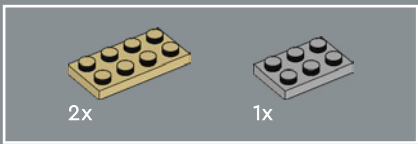

160

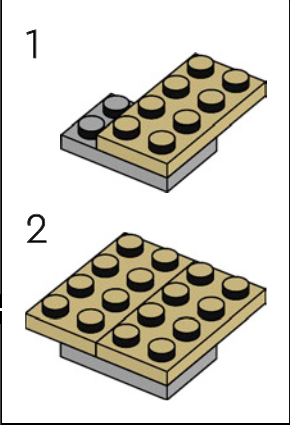
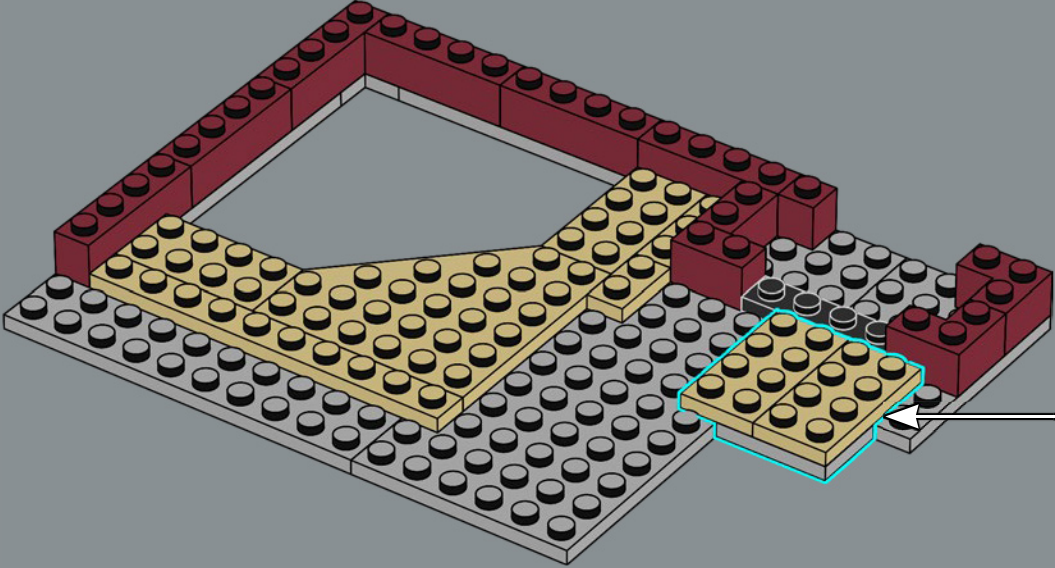

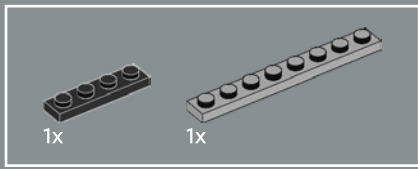

161

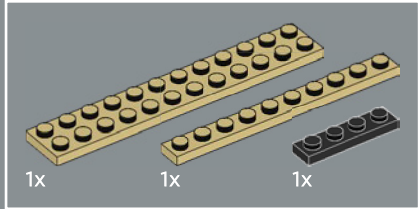
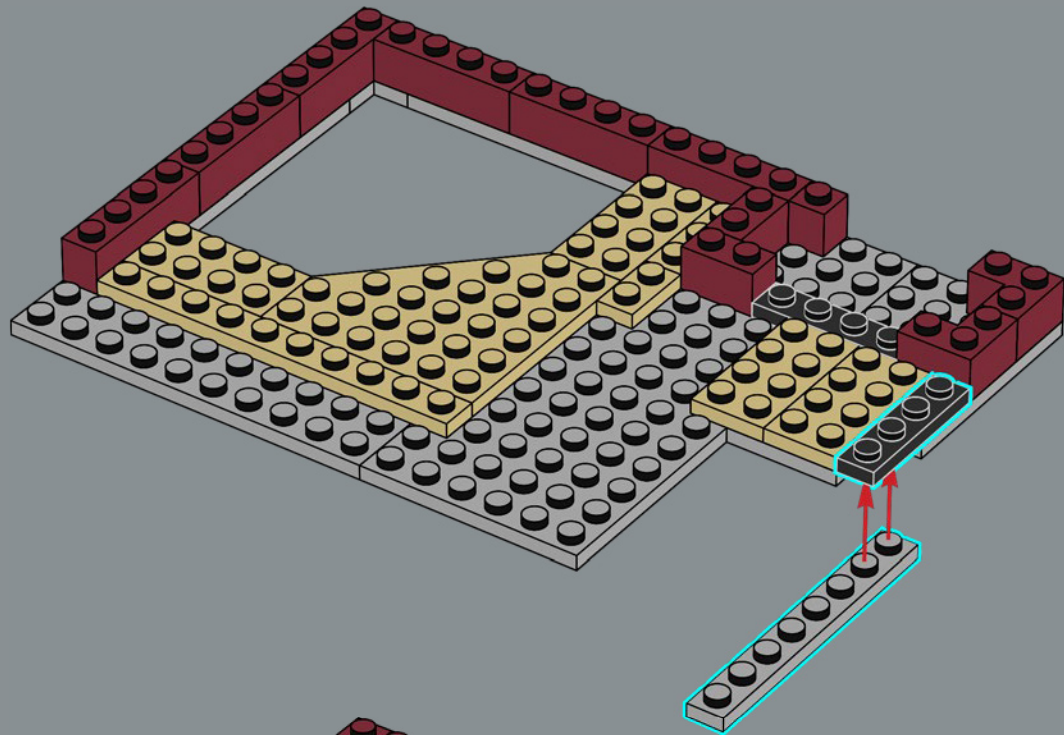

162

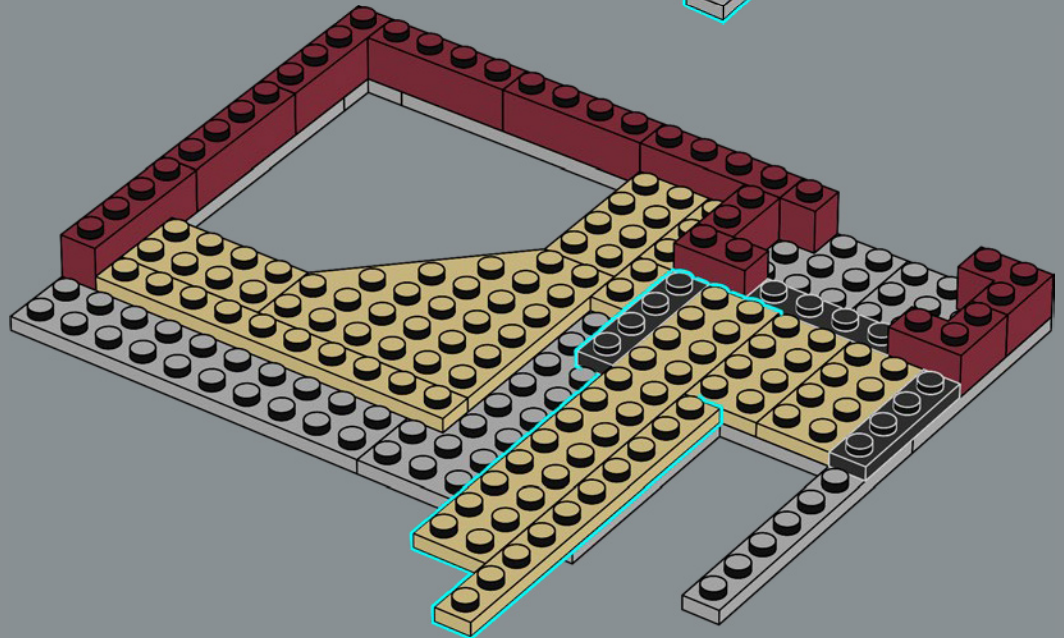

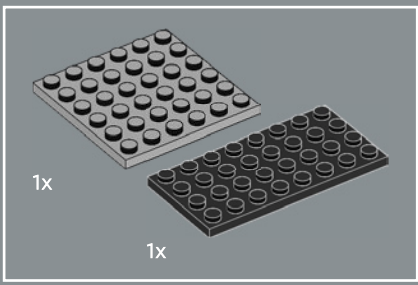

163

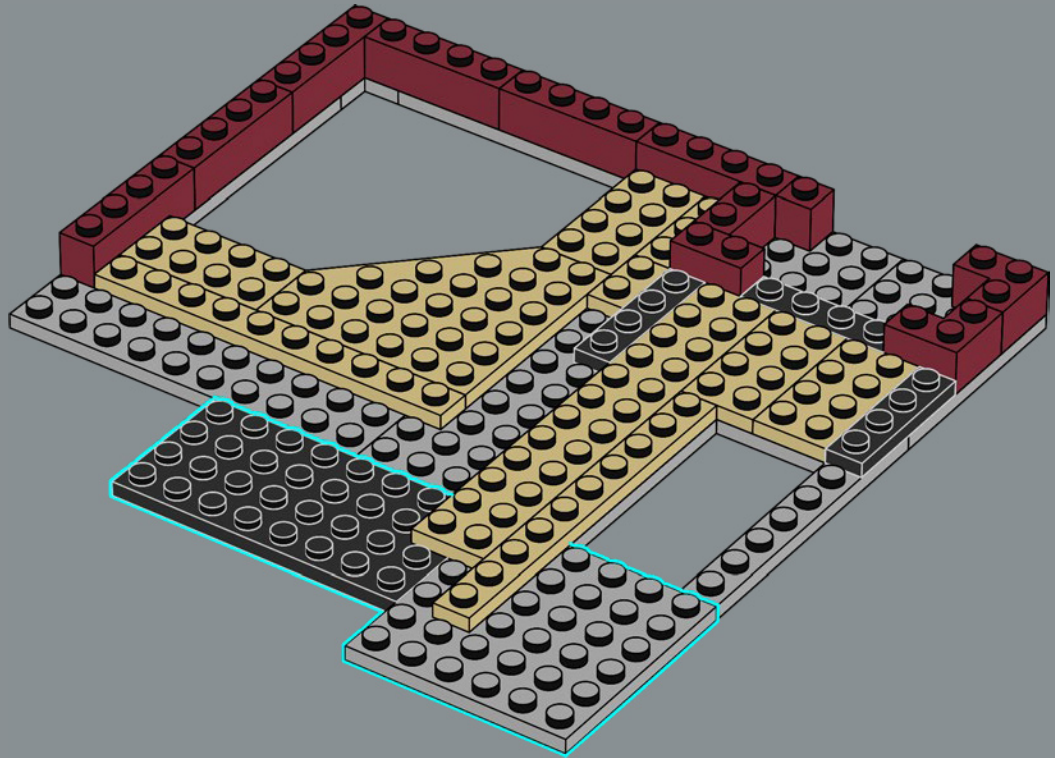

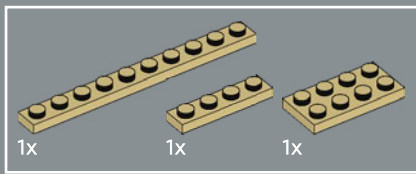

164

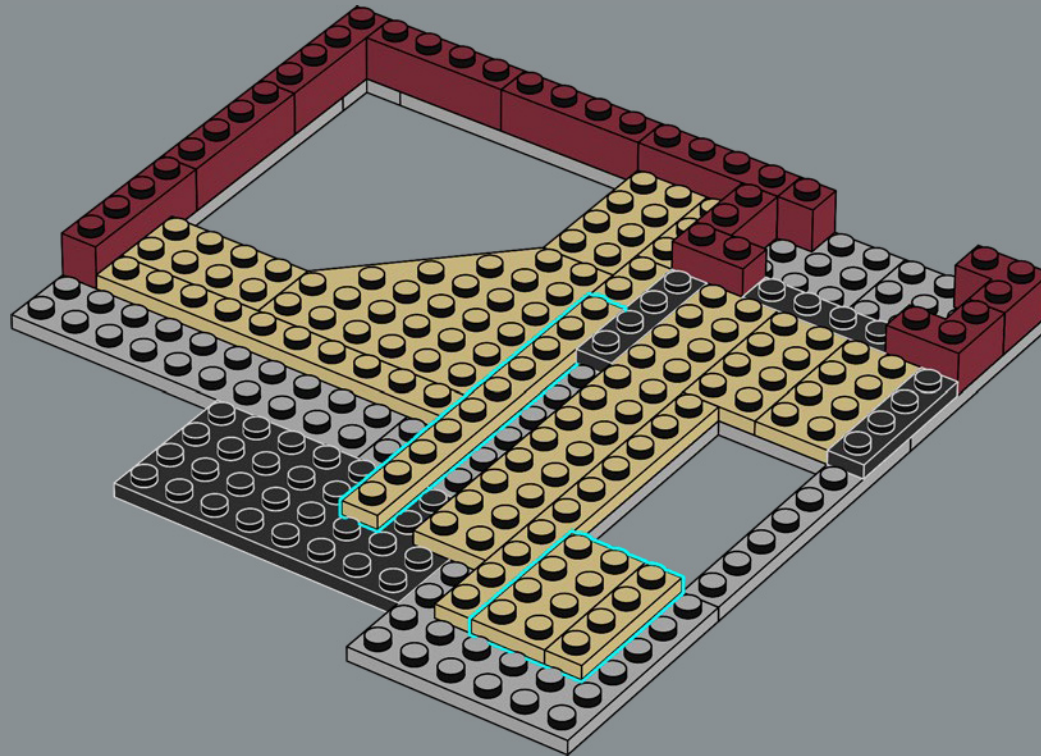

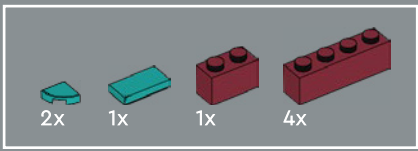

165

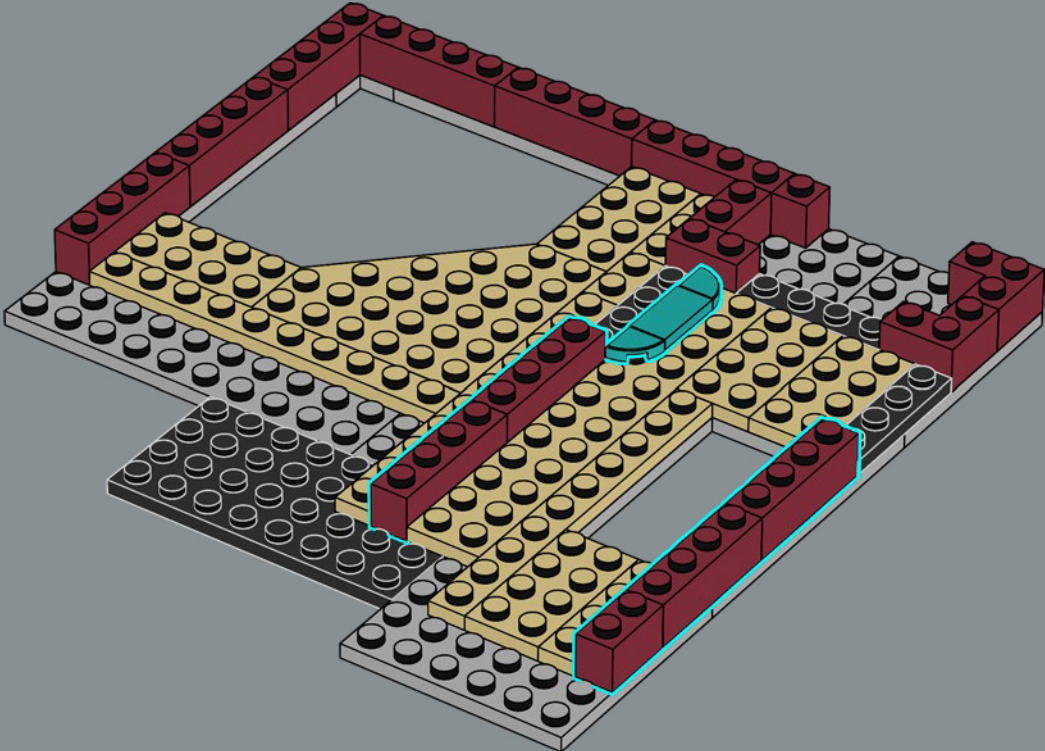

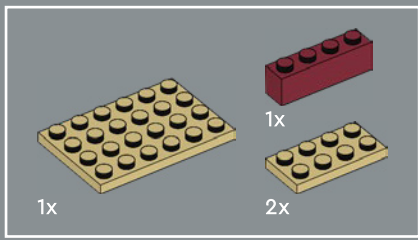

166

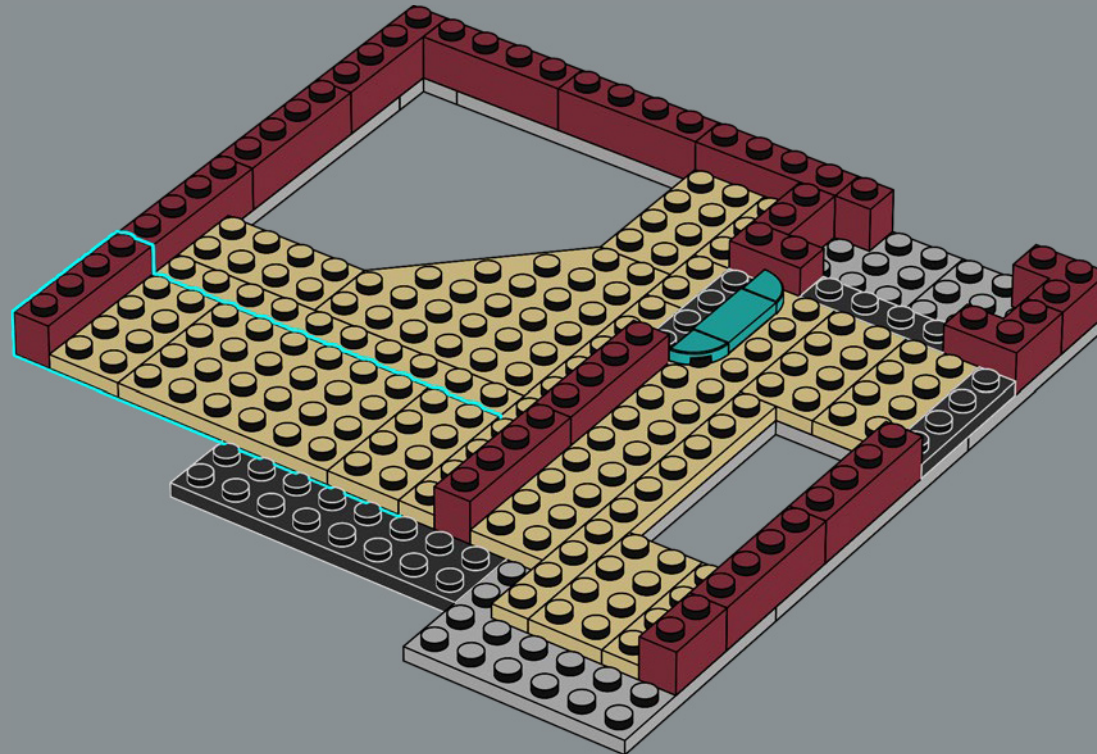

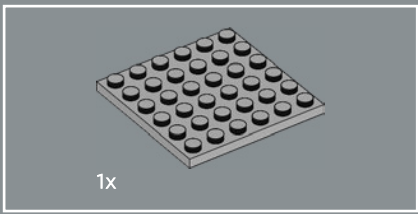

167

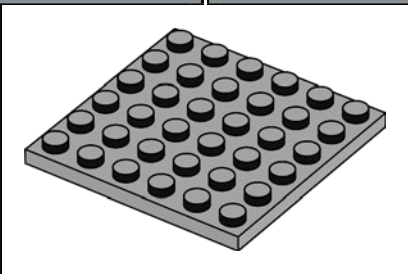
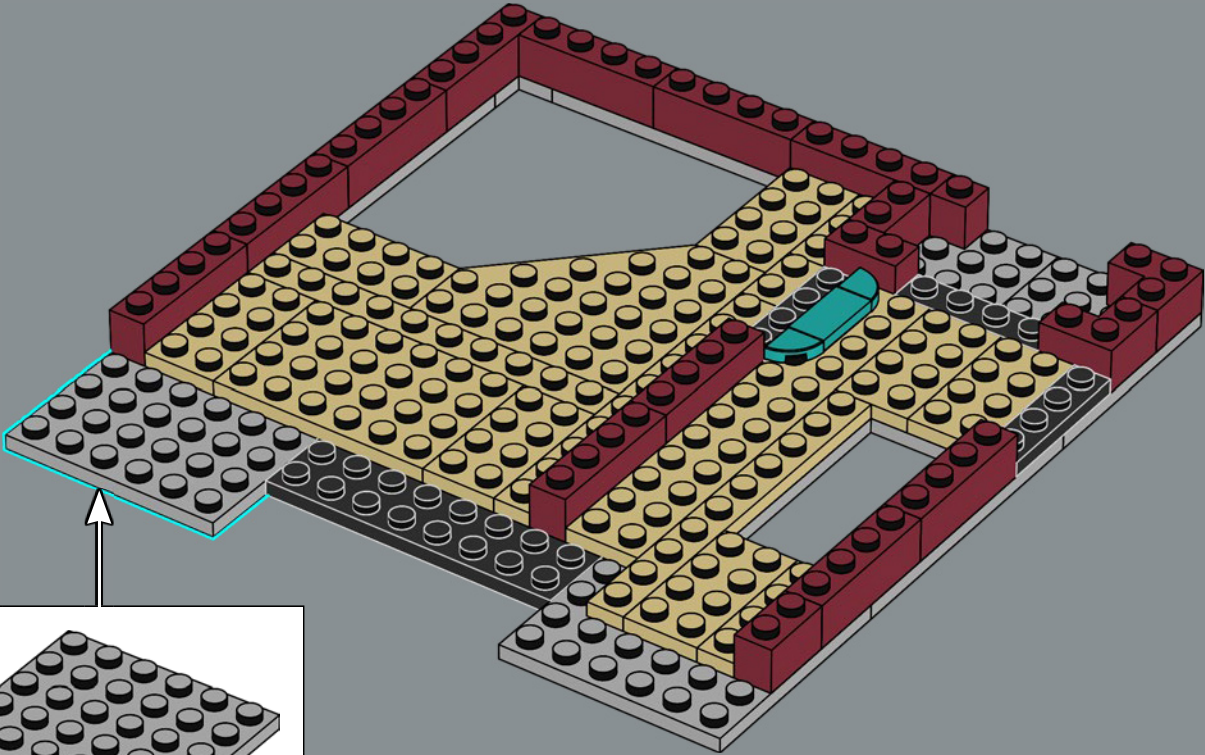

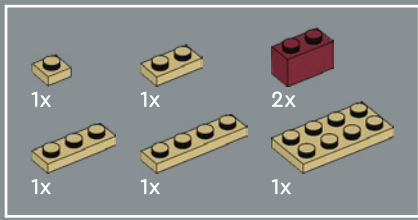

168

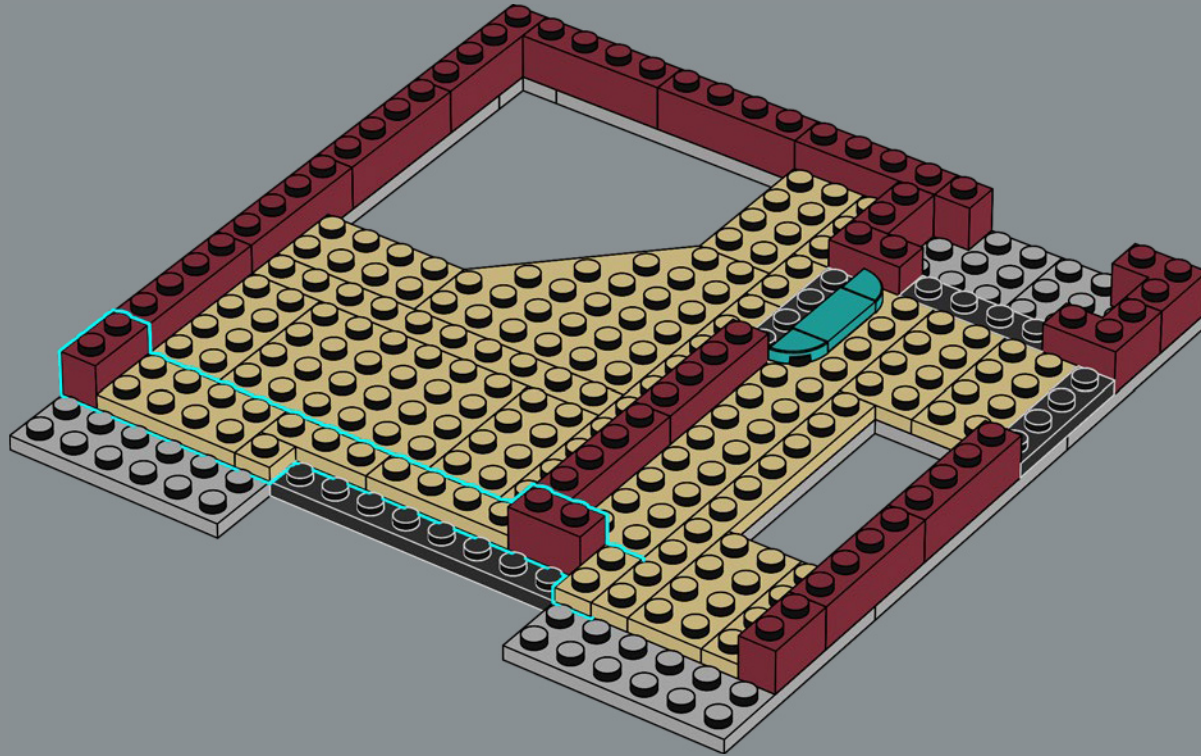

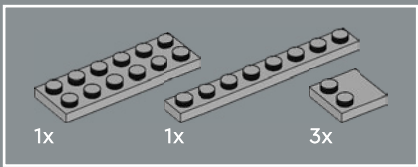

169

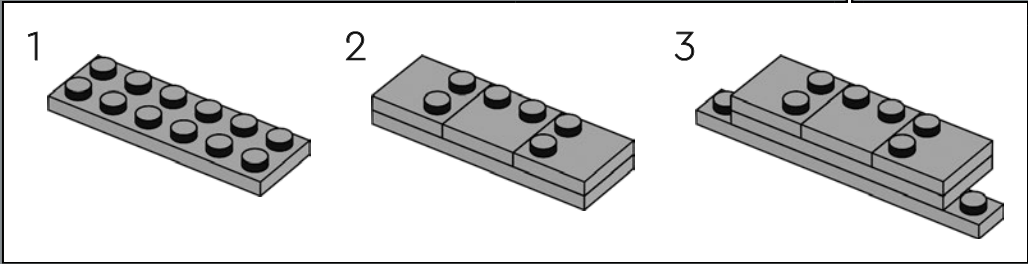
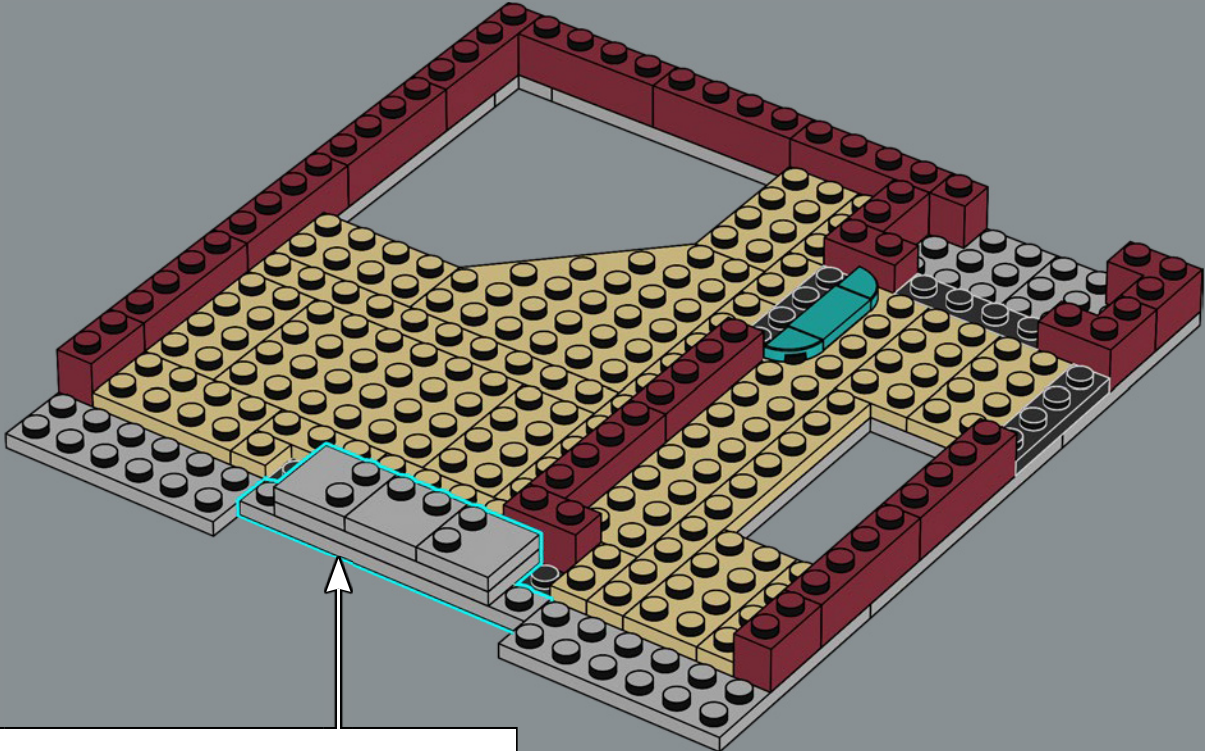

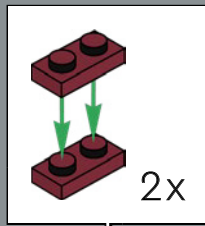
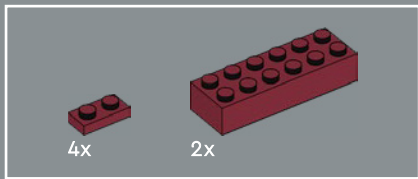

170

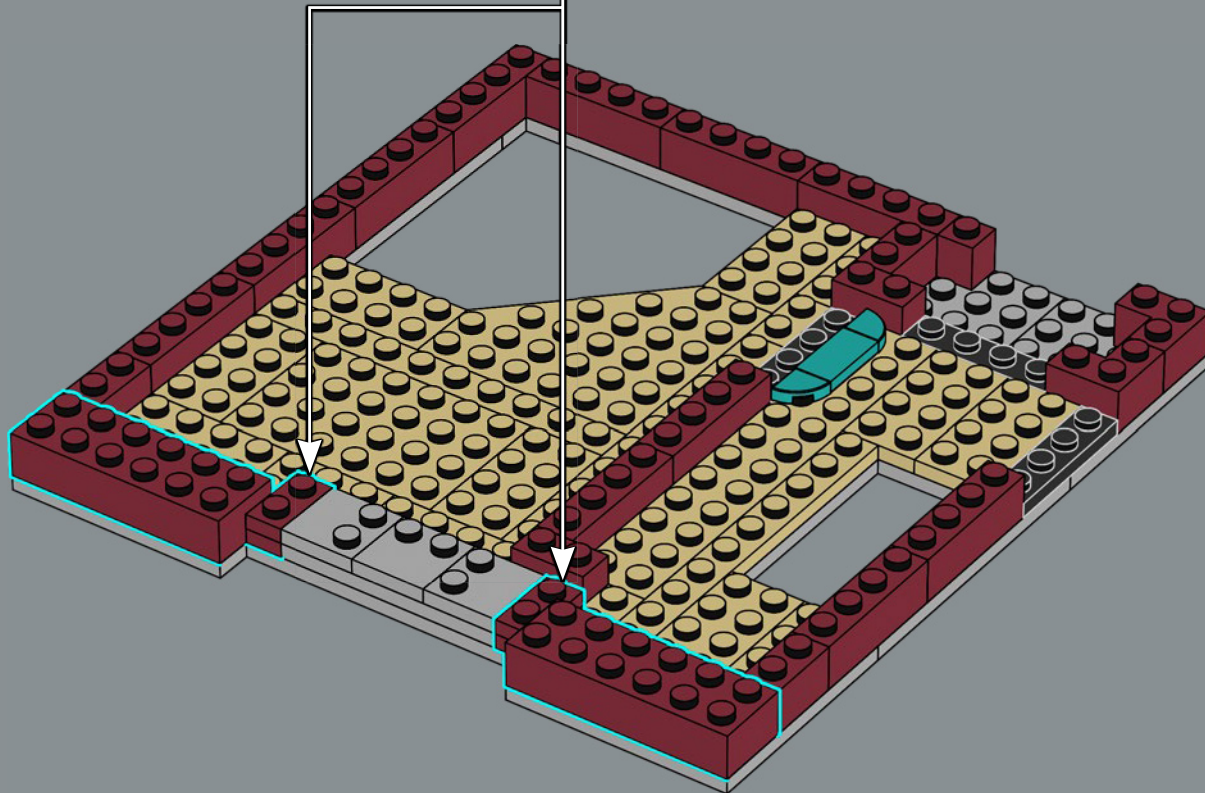

5x 4x

171

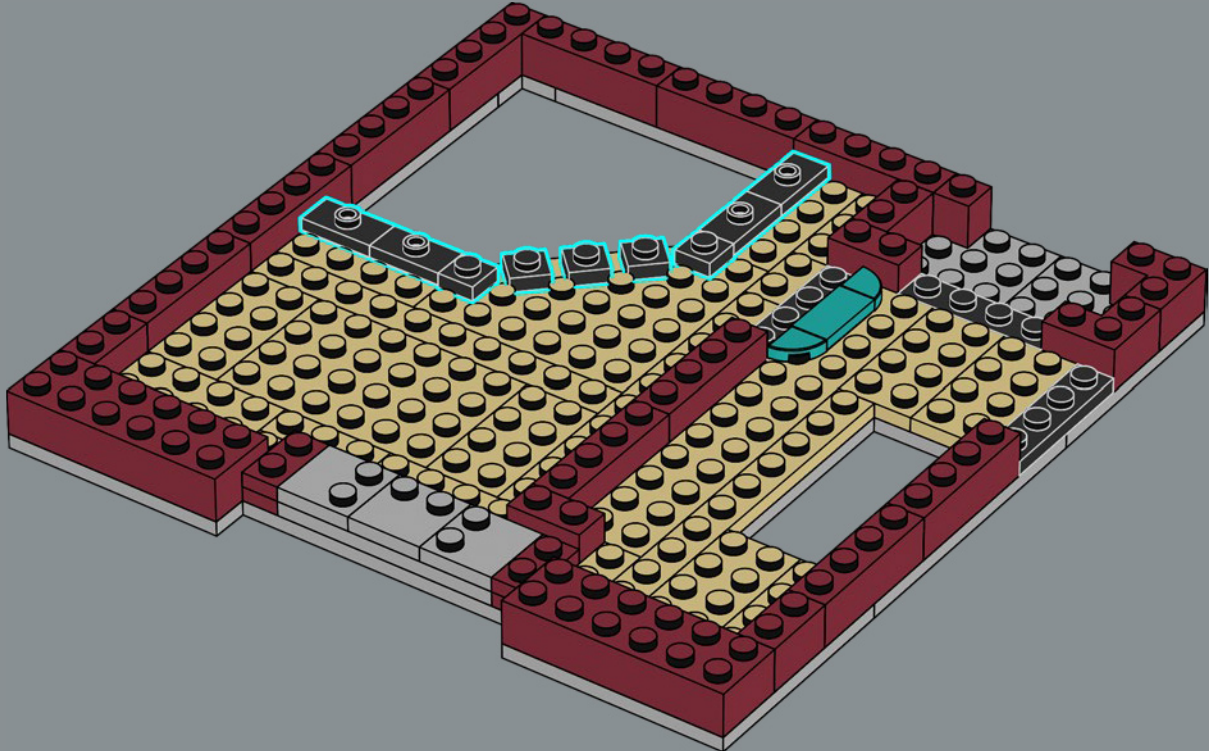

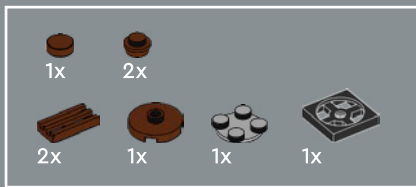

172

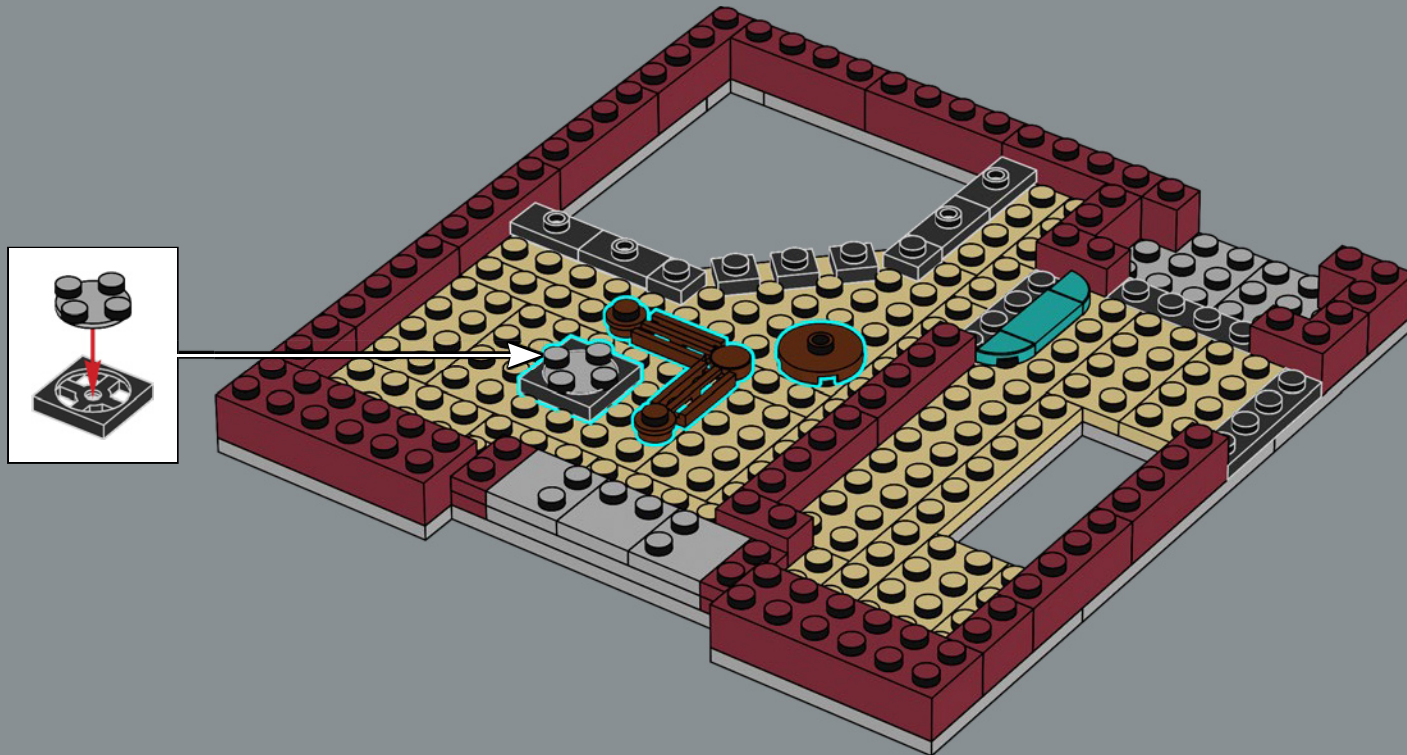

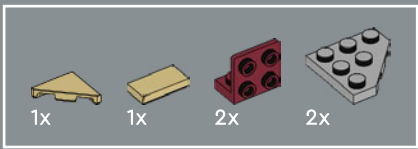

173

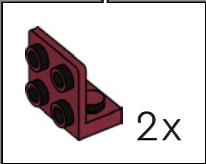
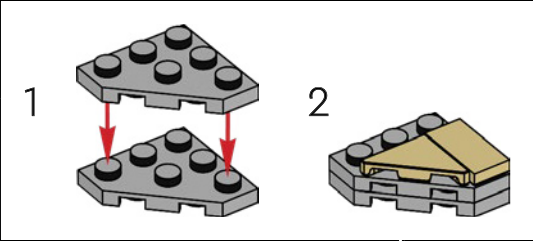
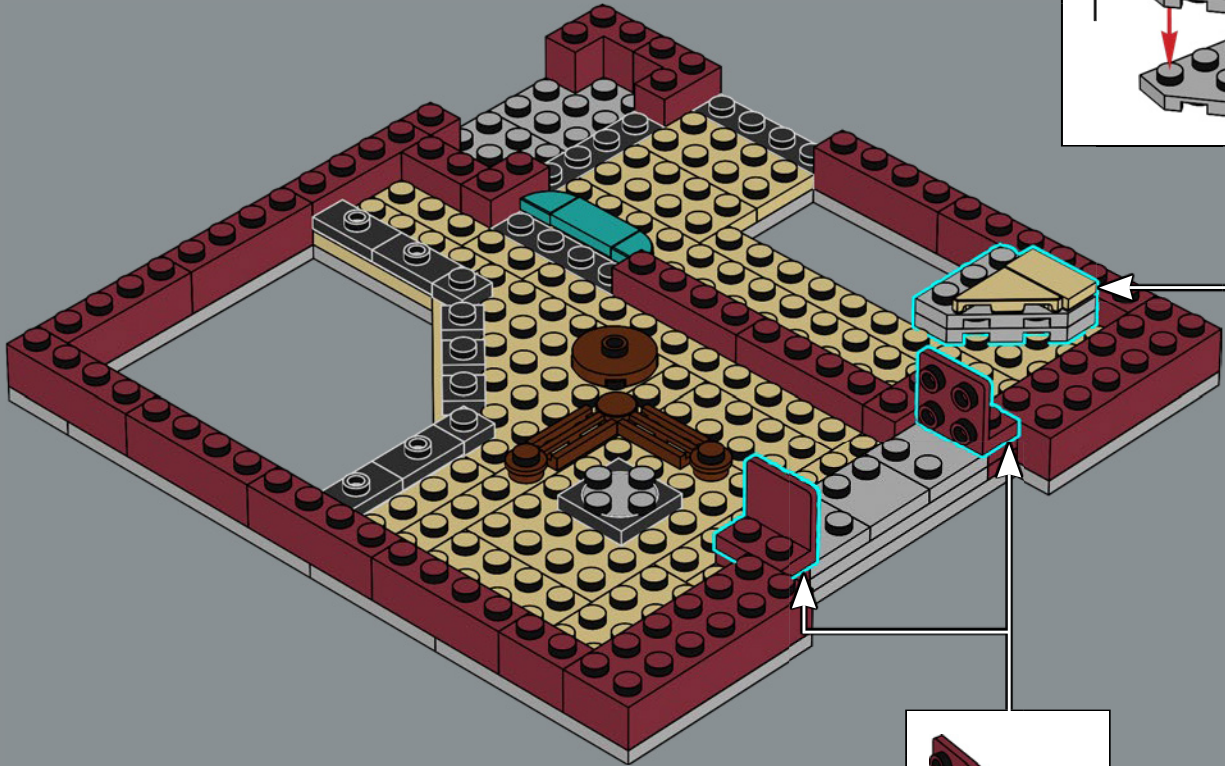

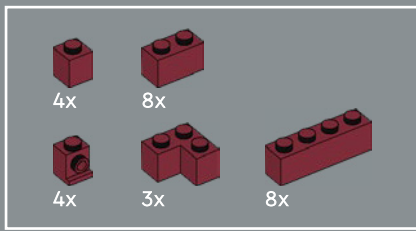

174

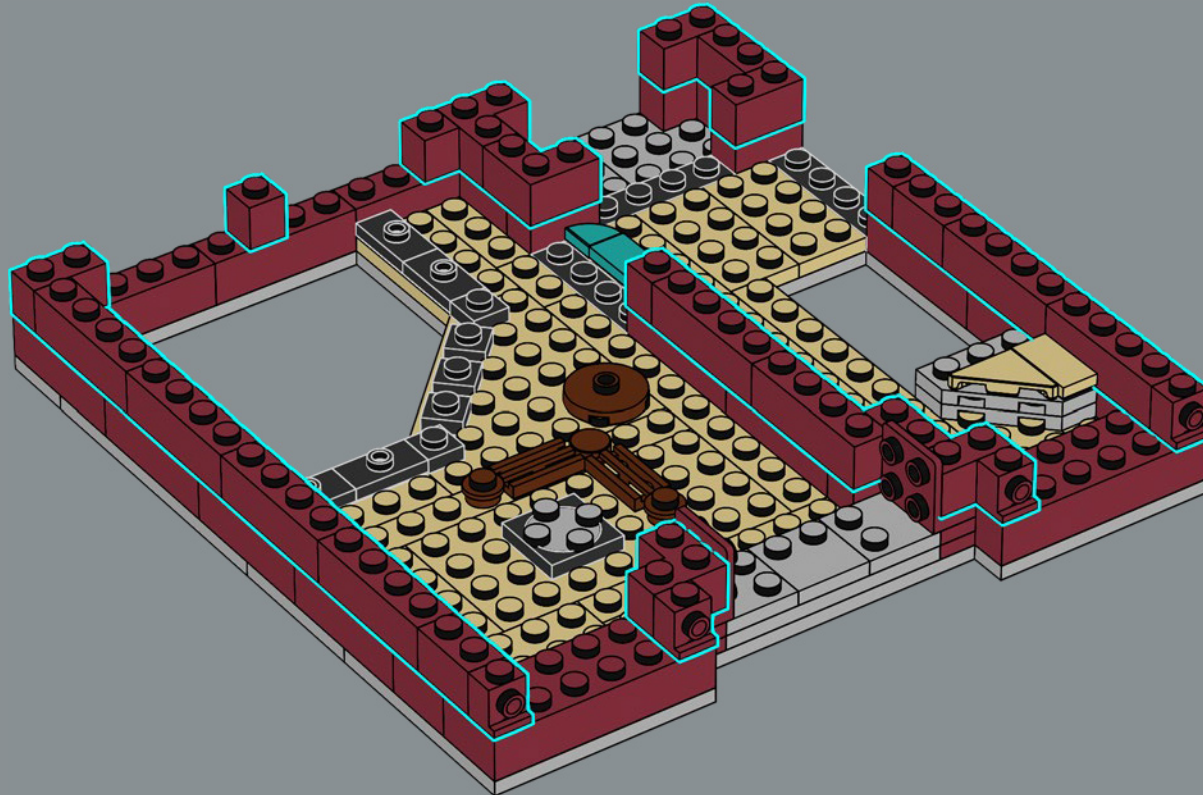

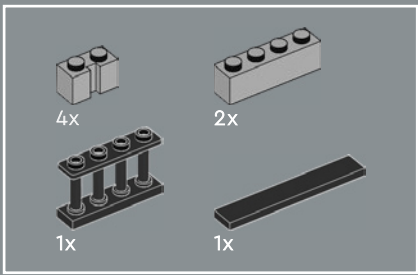

175

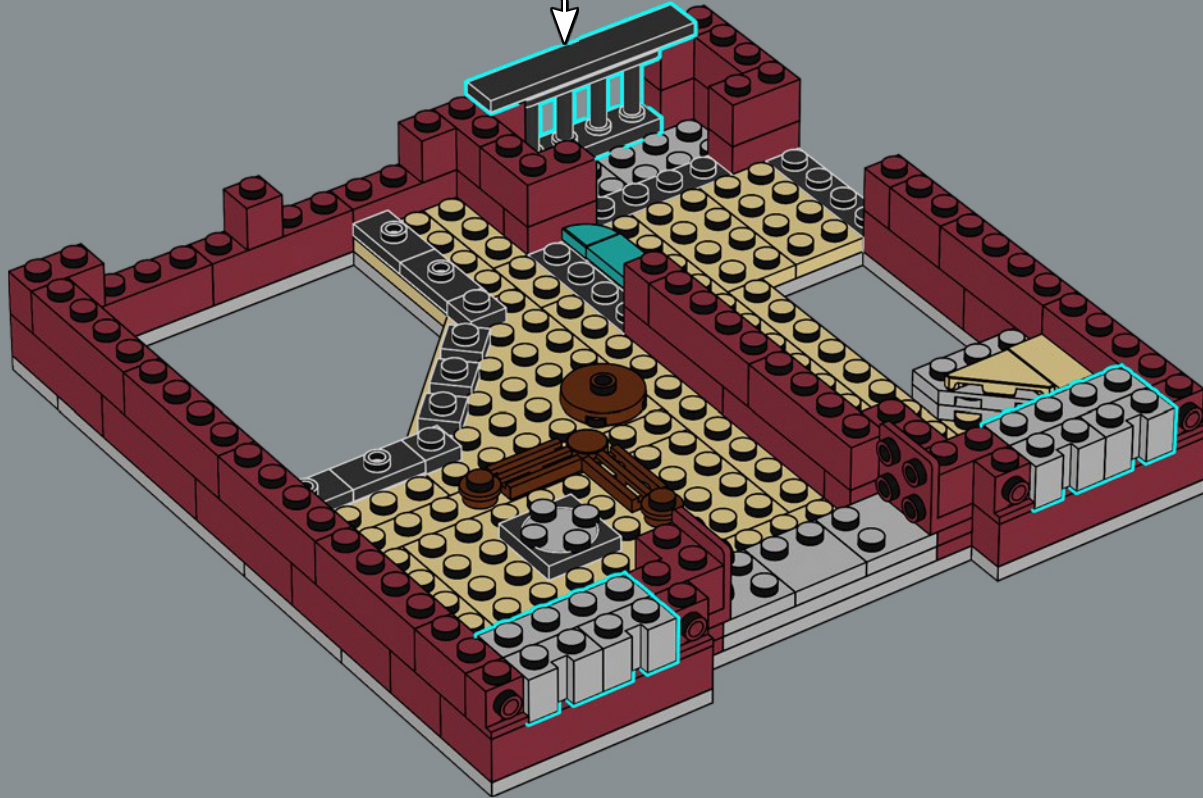
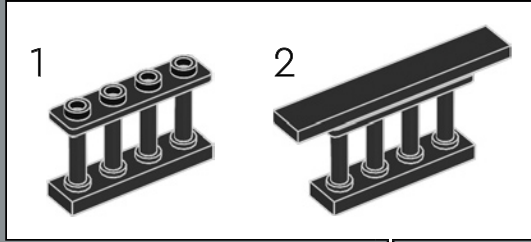

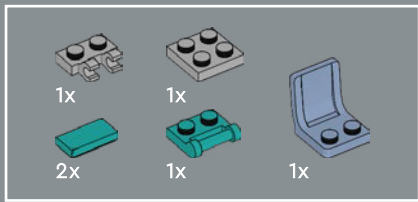

176

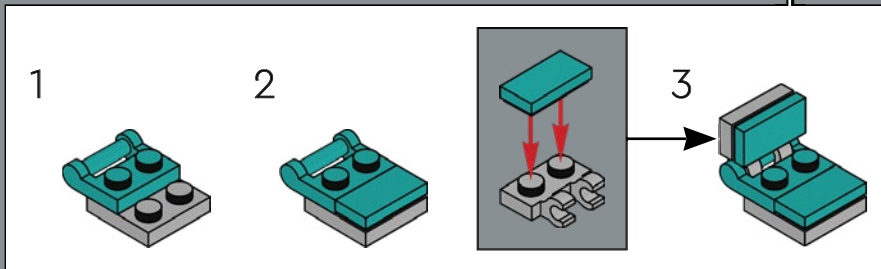
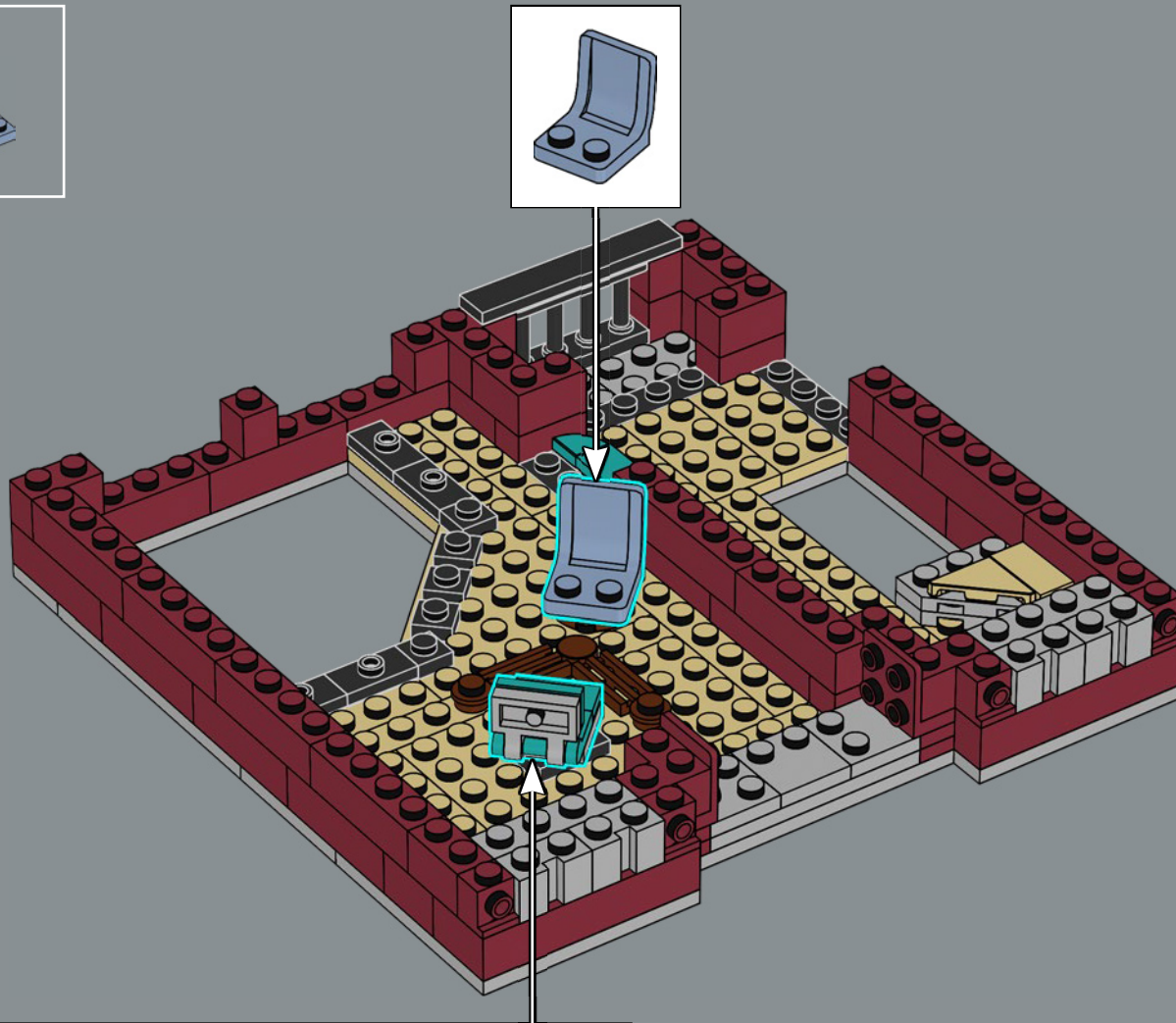



177

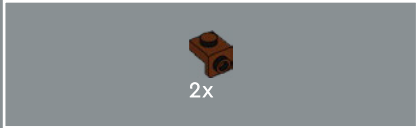
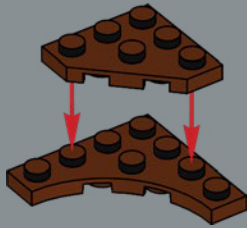

178

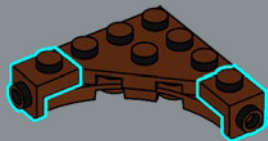

179

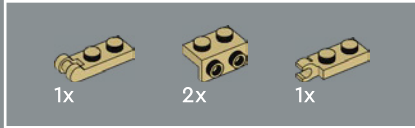
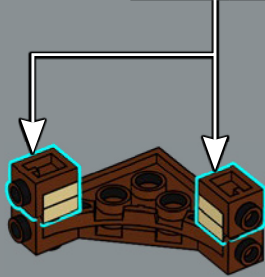
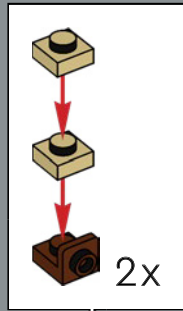

180

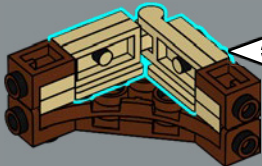
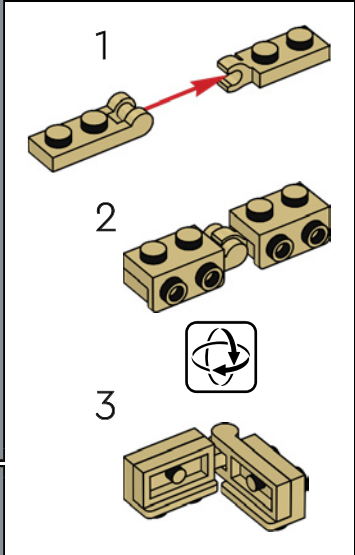

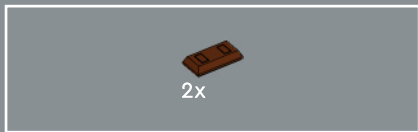

181

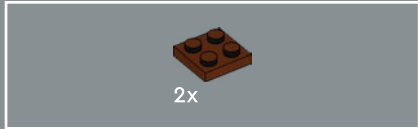
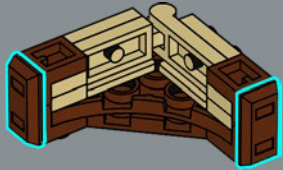

182

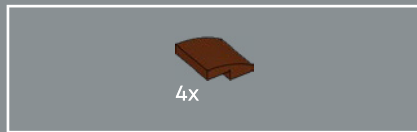
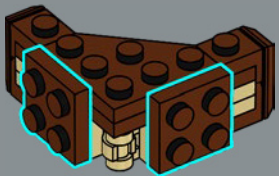

183

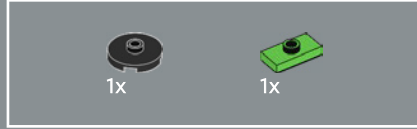
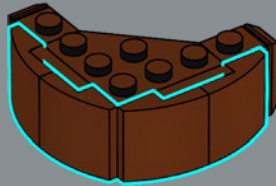

184

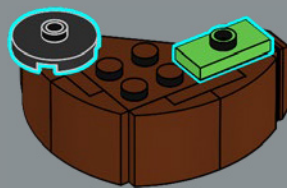

The club owner wanted something special for her office, so she ordered this unusual desk that is oriented to a 45-degree angle.

185

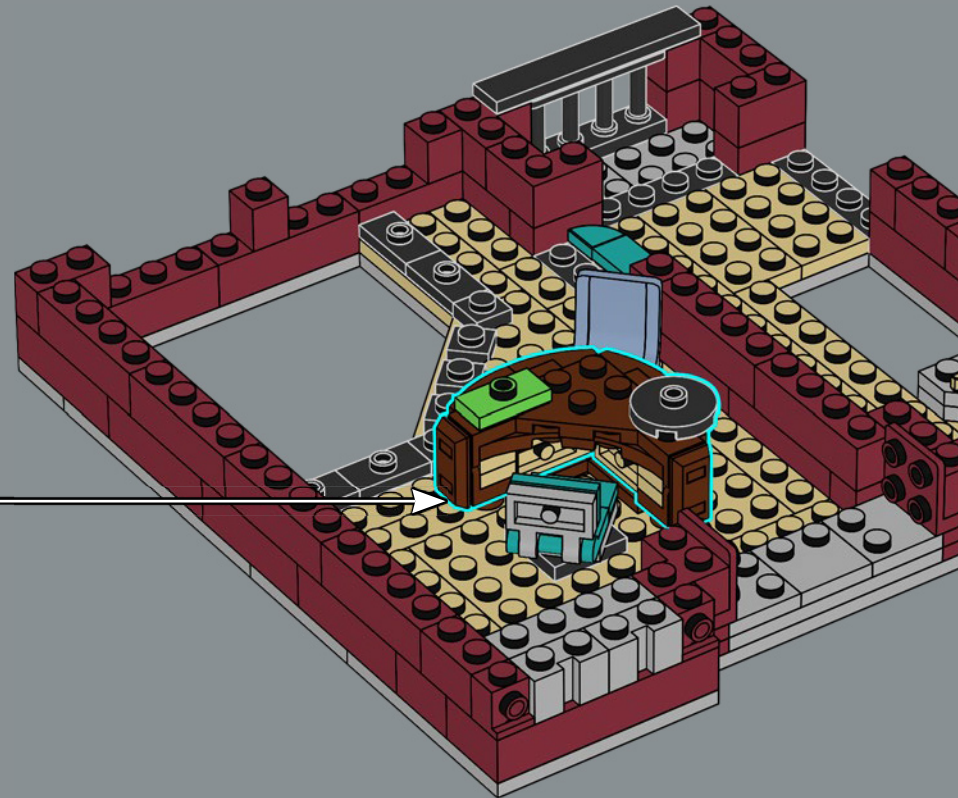

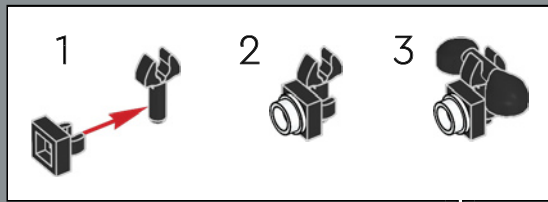

186

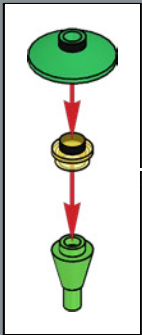
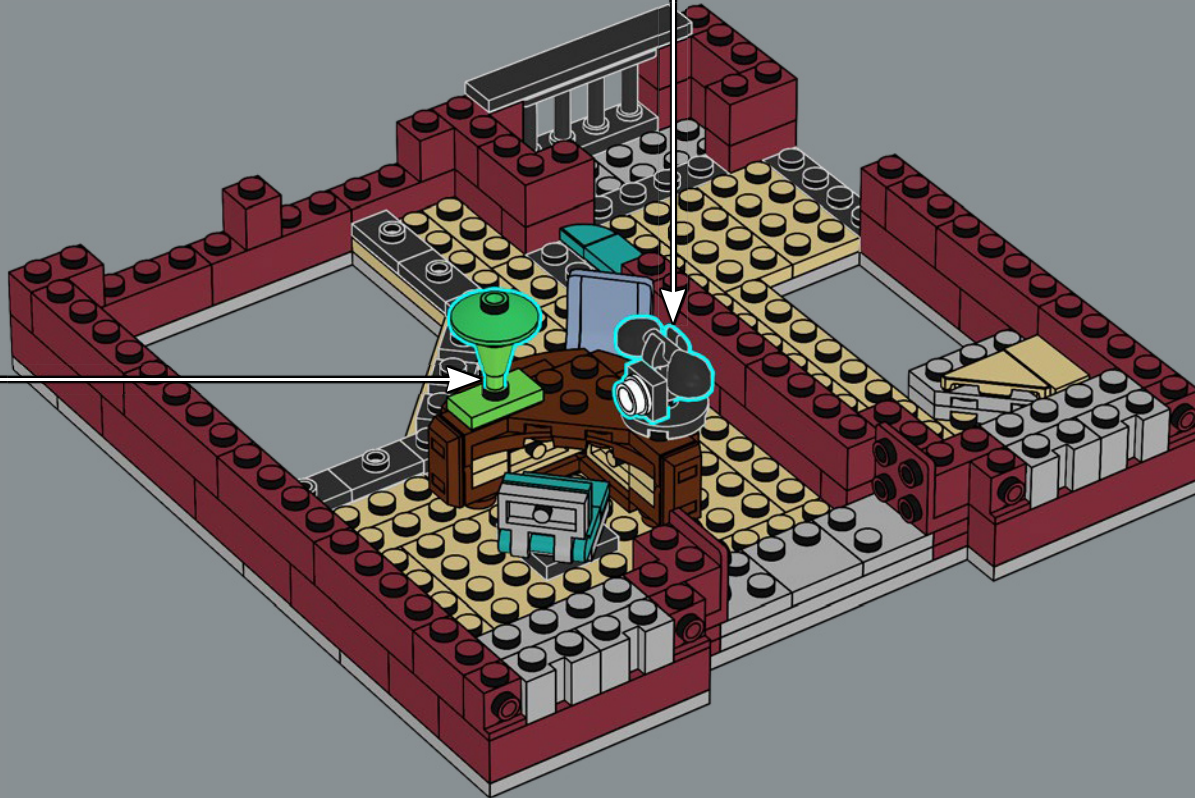



The club owner loves spotting up-and-coming artists and giving them a chance to shine on stage. She was one of the first to recognise the talent of the saxophone player from the LEGO® 10255 Assembly Square.

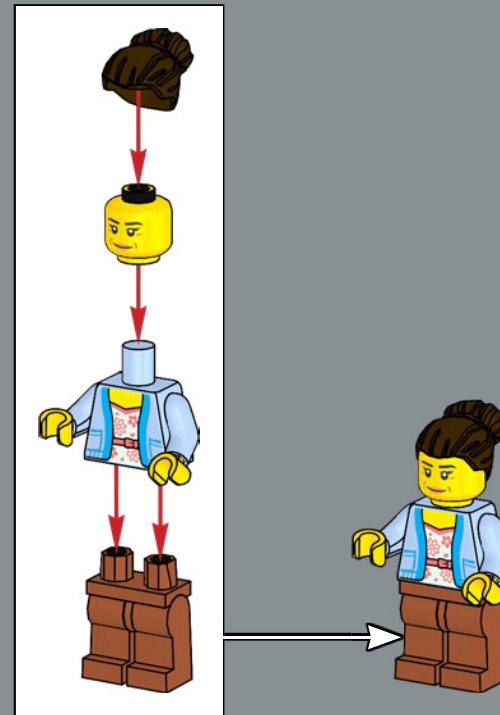



187

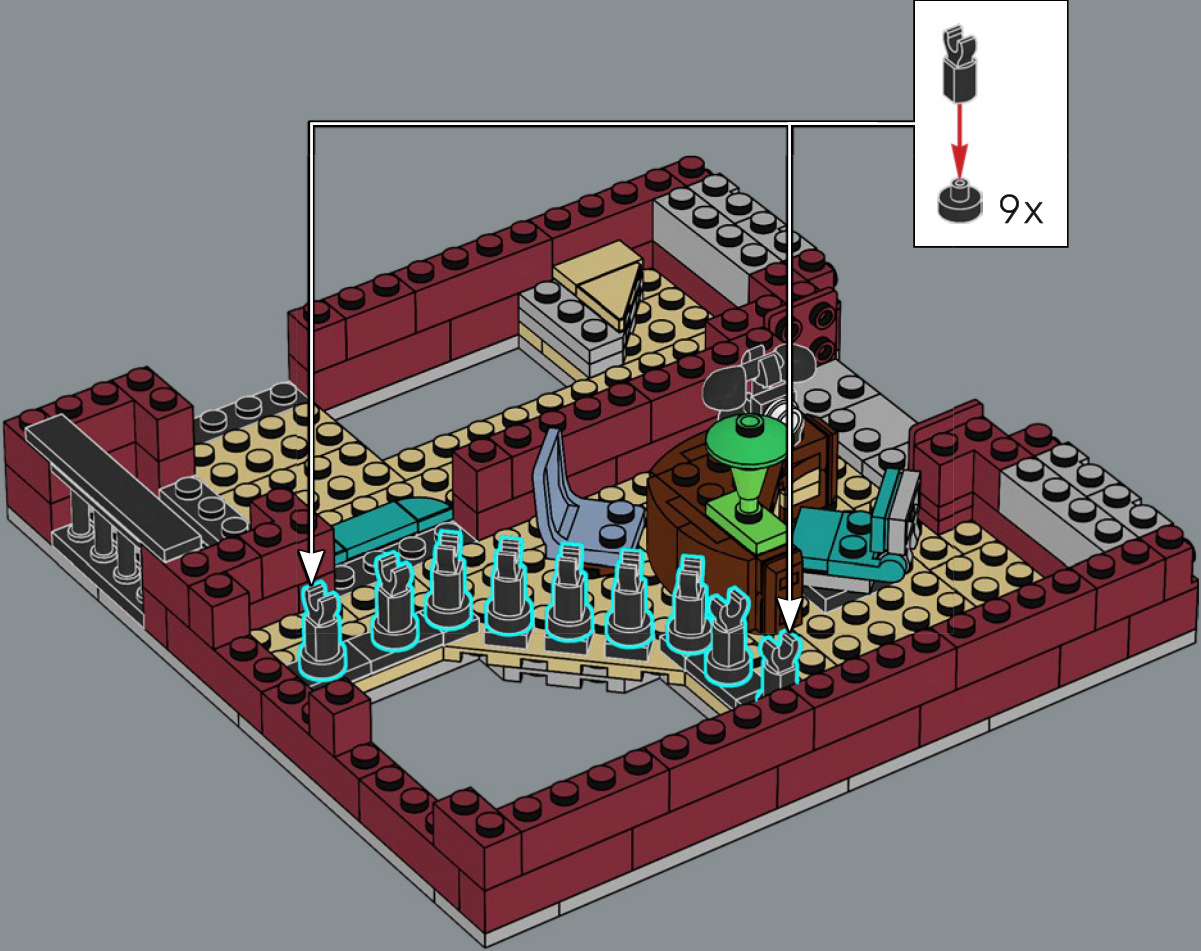



The manager has her own private balcony where she can listen in on the evening's performances.

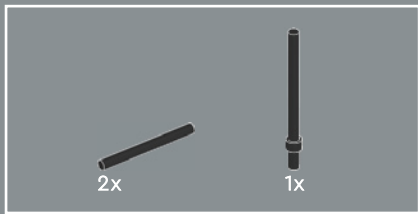

188

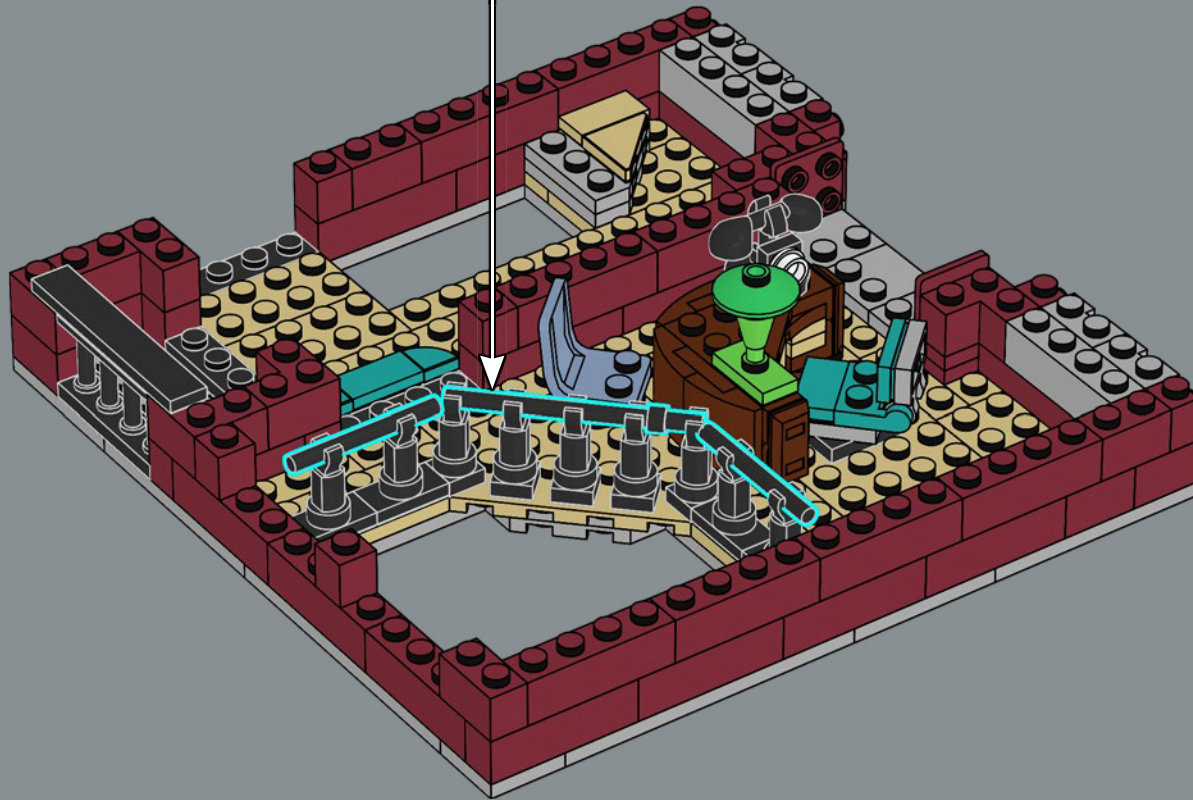

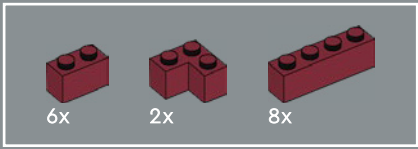

189

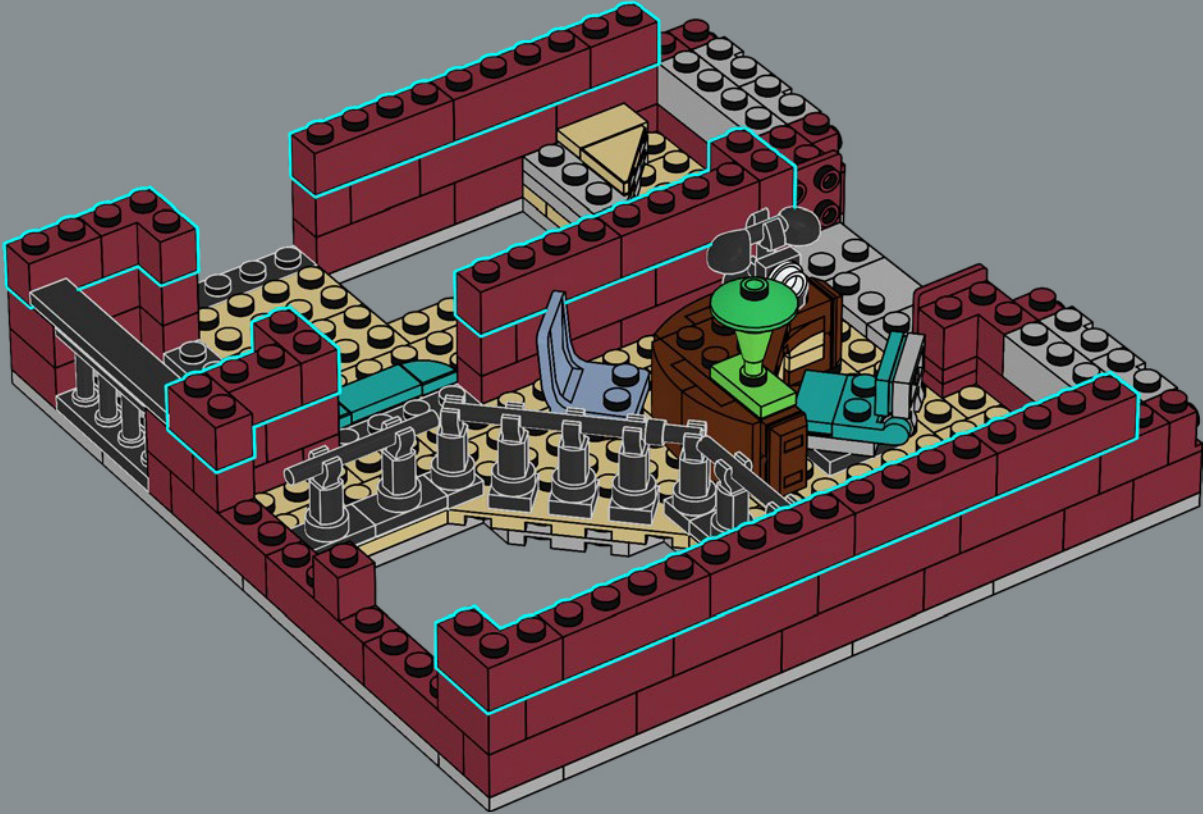

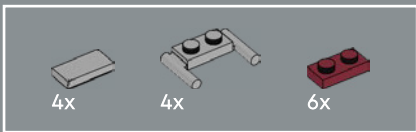

190

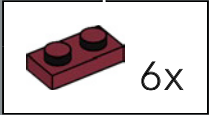
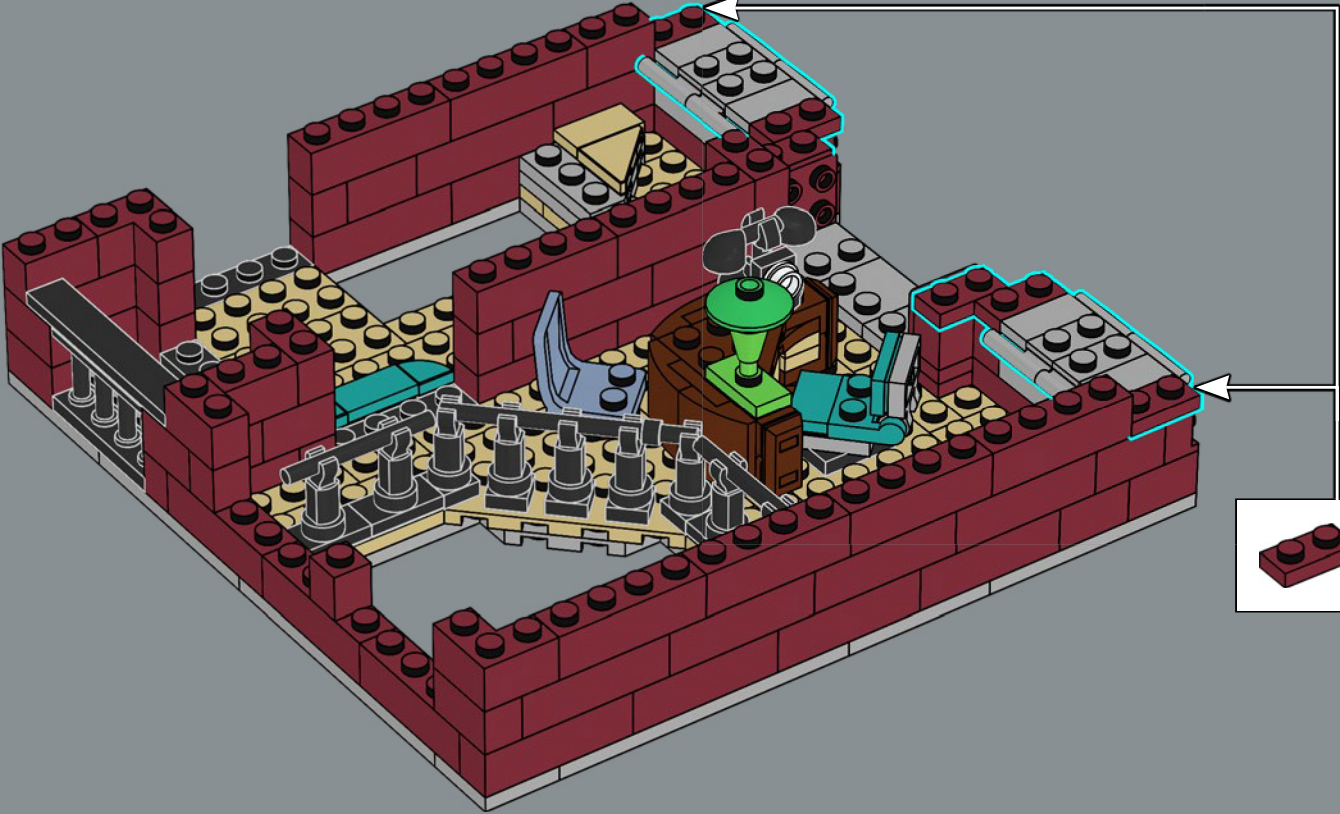

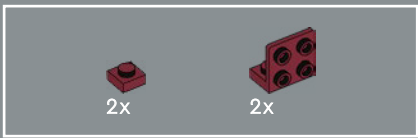

191

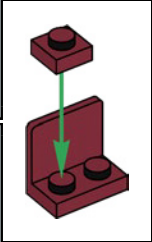
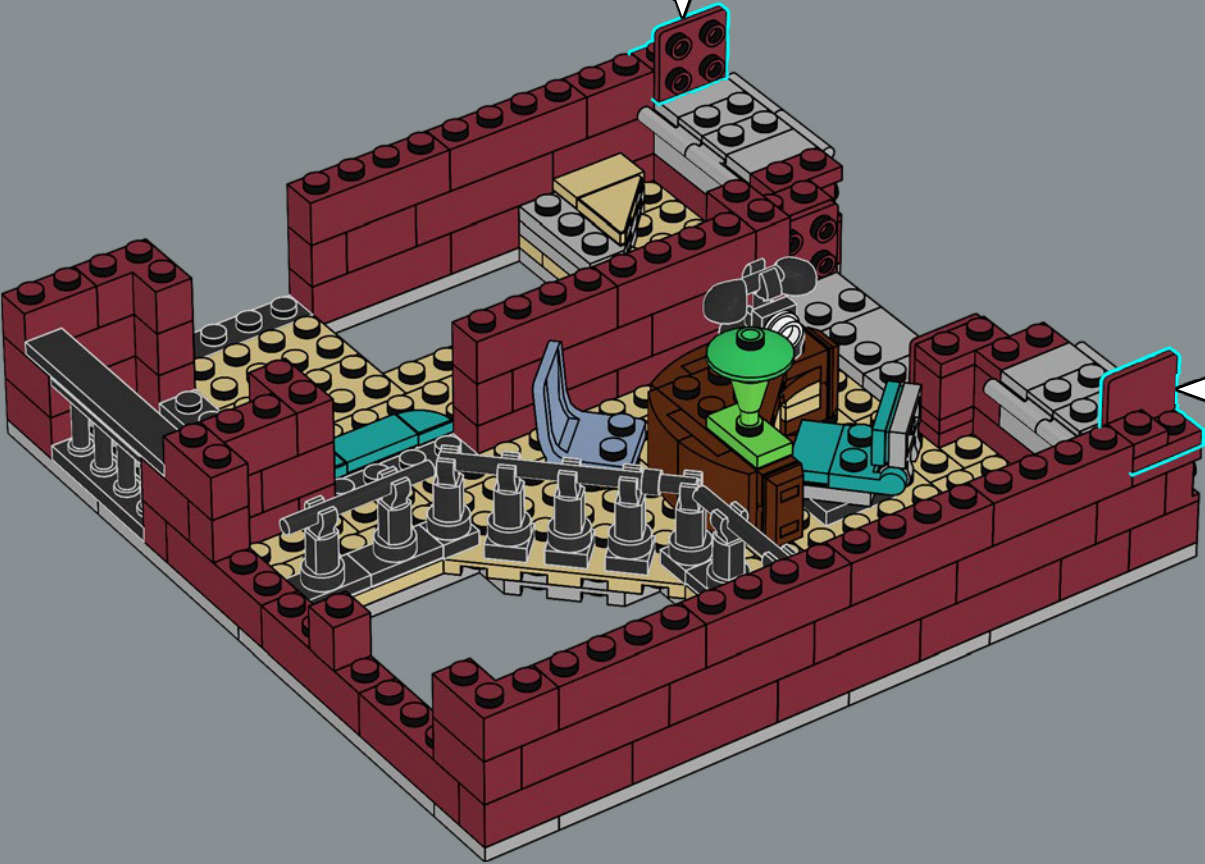
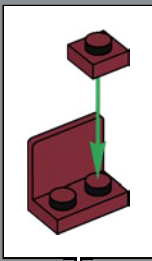



192

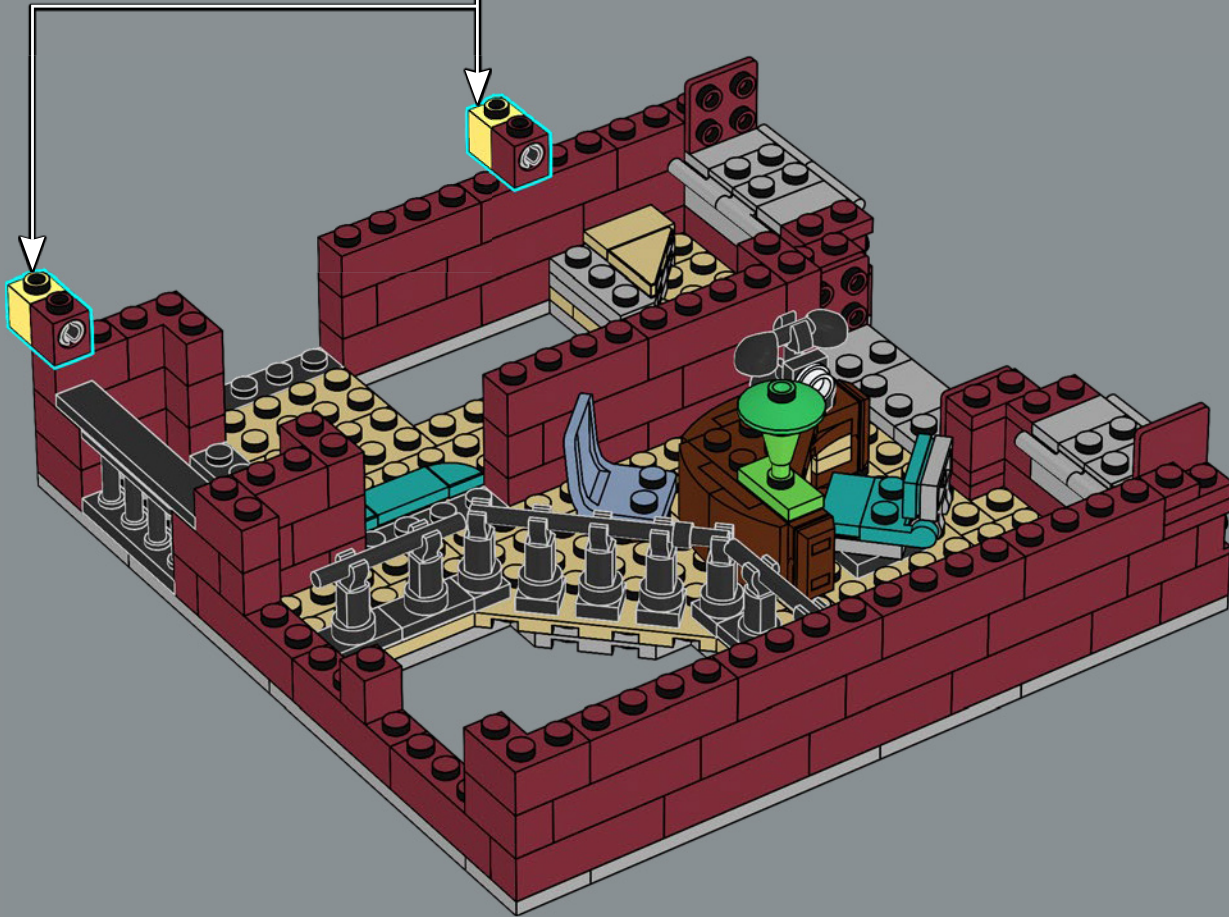
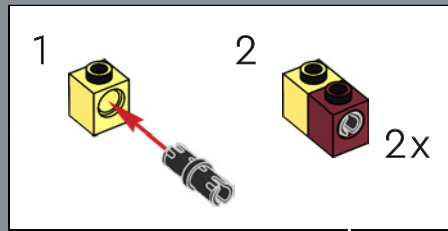

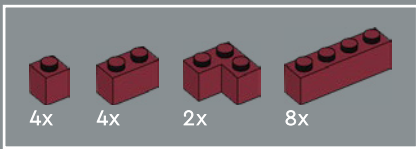

193

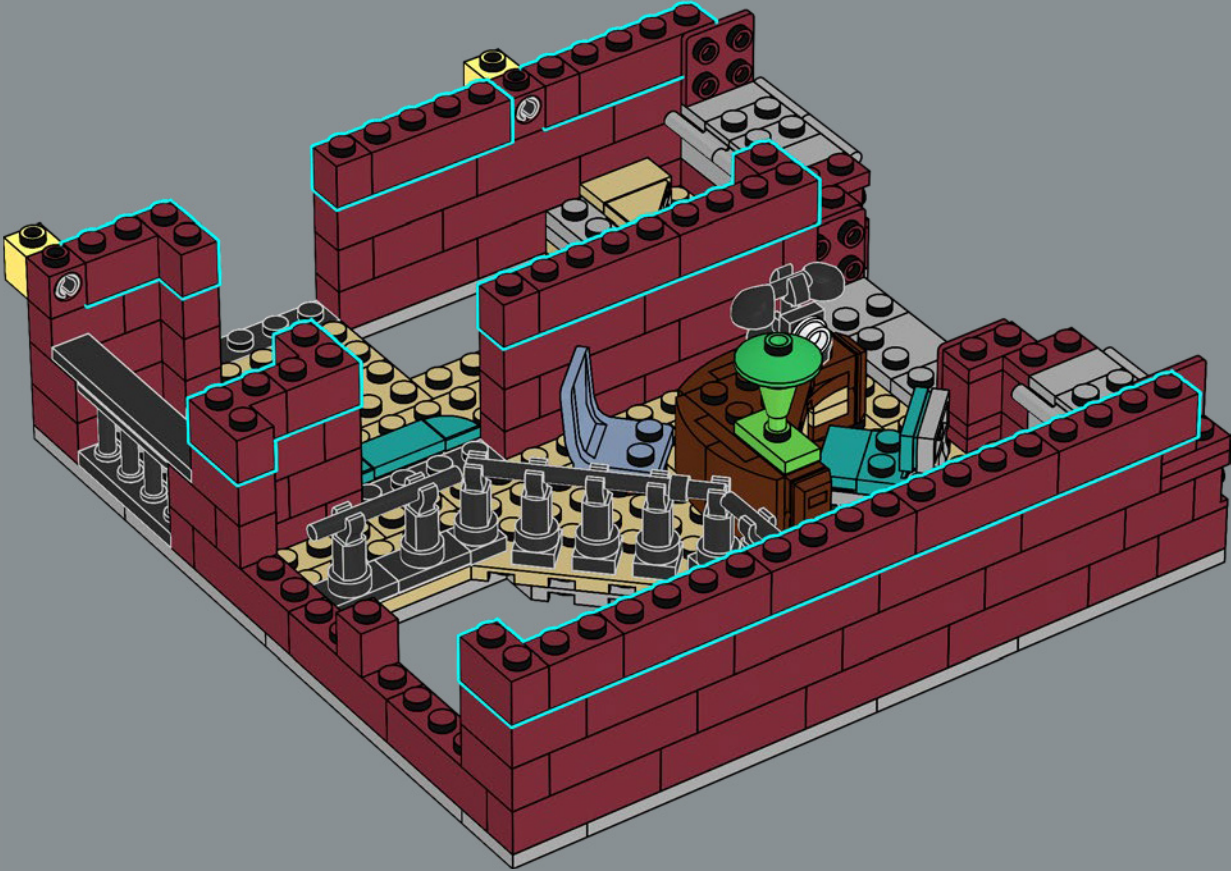

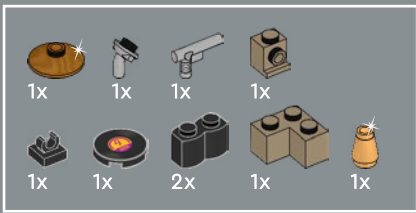

194

1

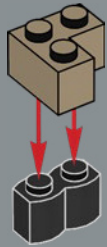

2

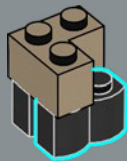

3

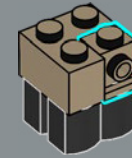

4



5

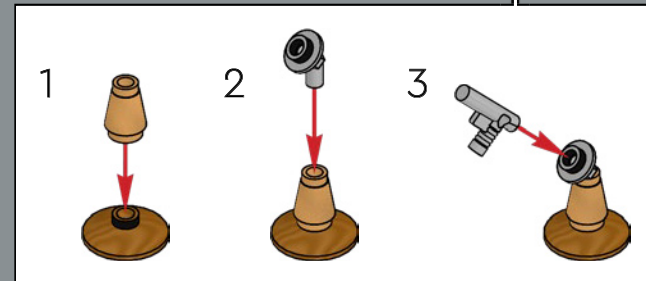



In addition to live music, the club owner loves listening to the latest hits on vinyl. Recently she listened to the chart-topping new album by the rock star from the LEGO® 10260 Downtown Diner.

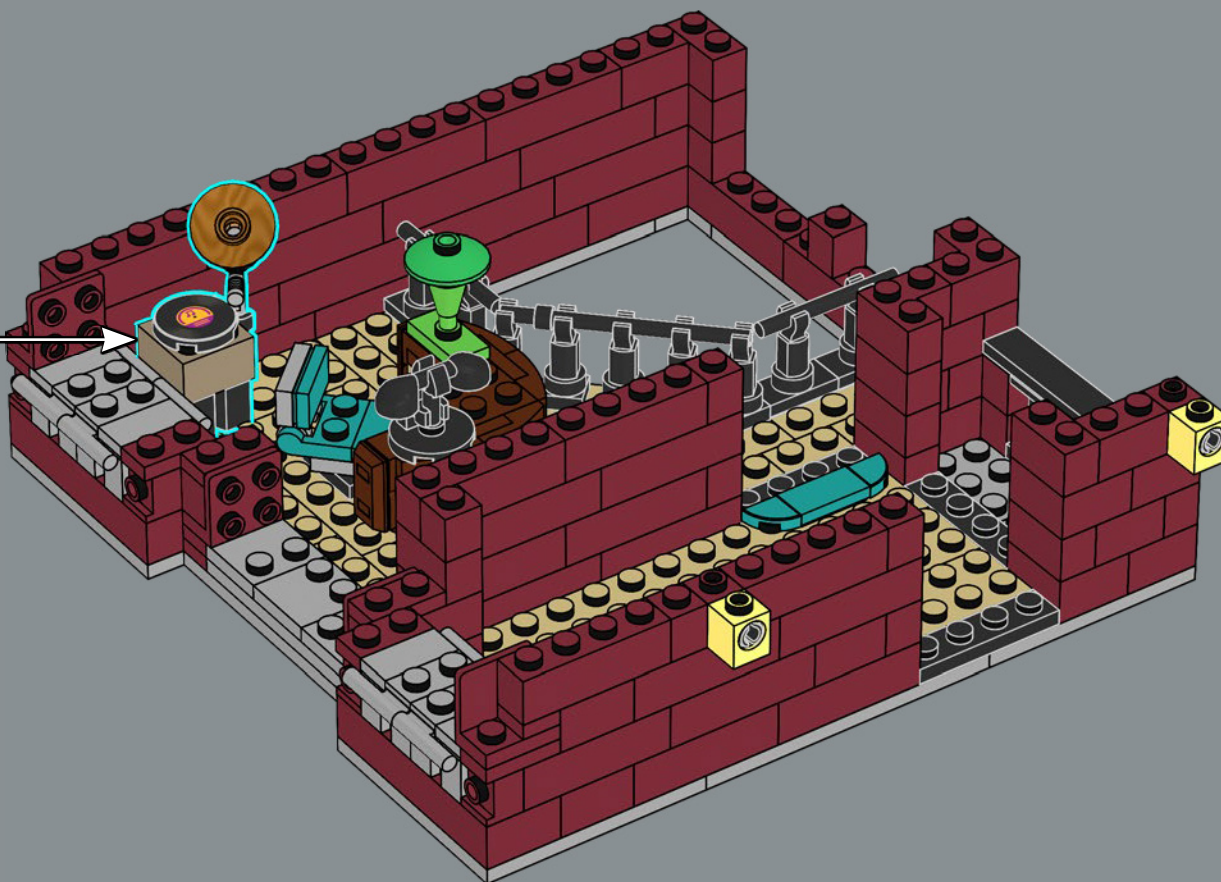

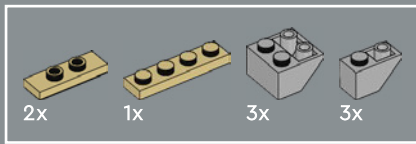

195

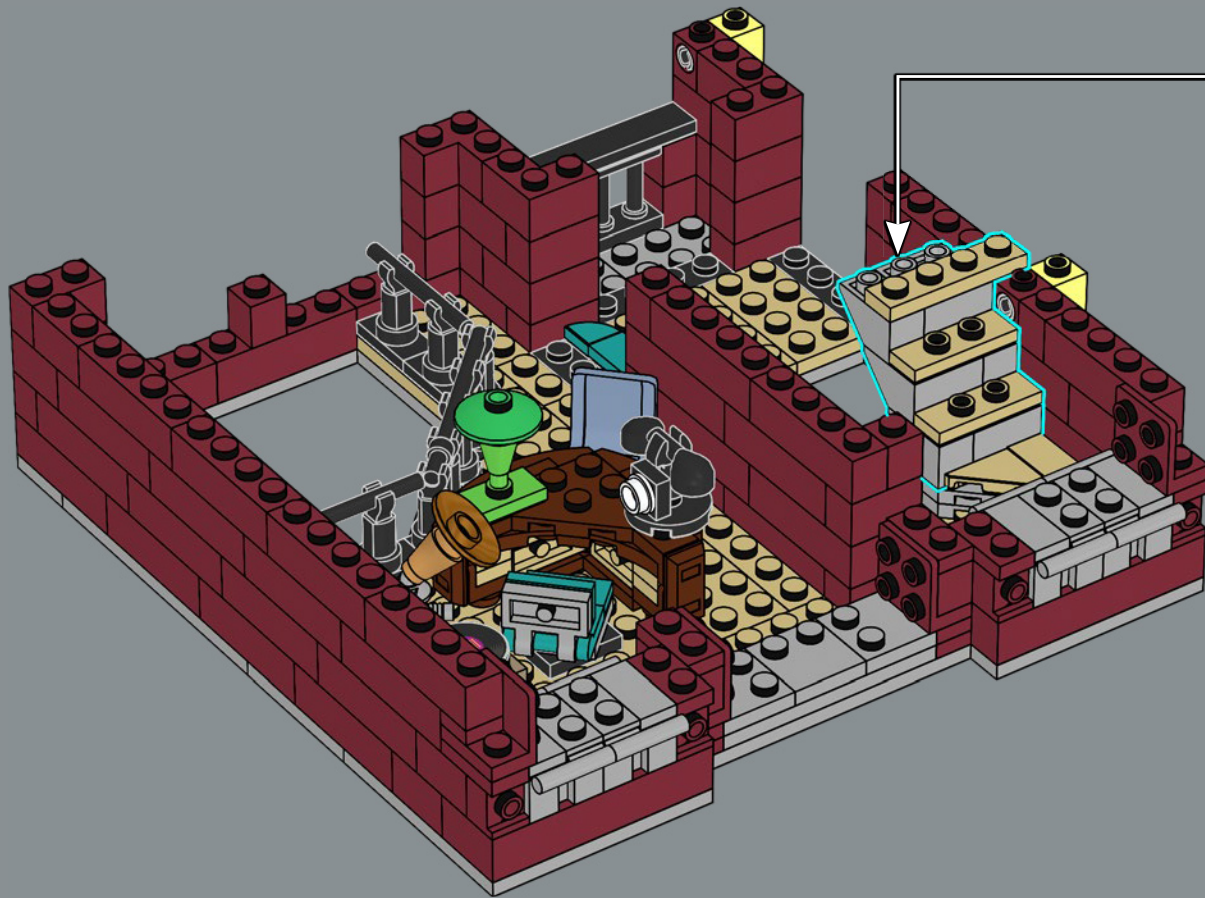
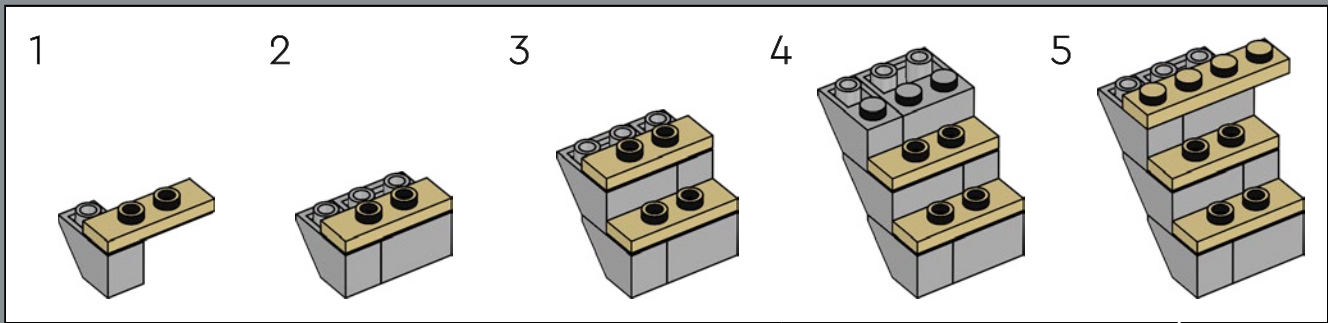



4x

196

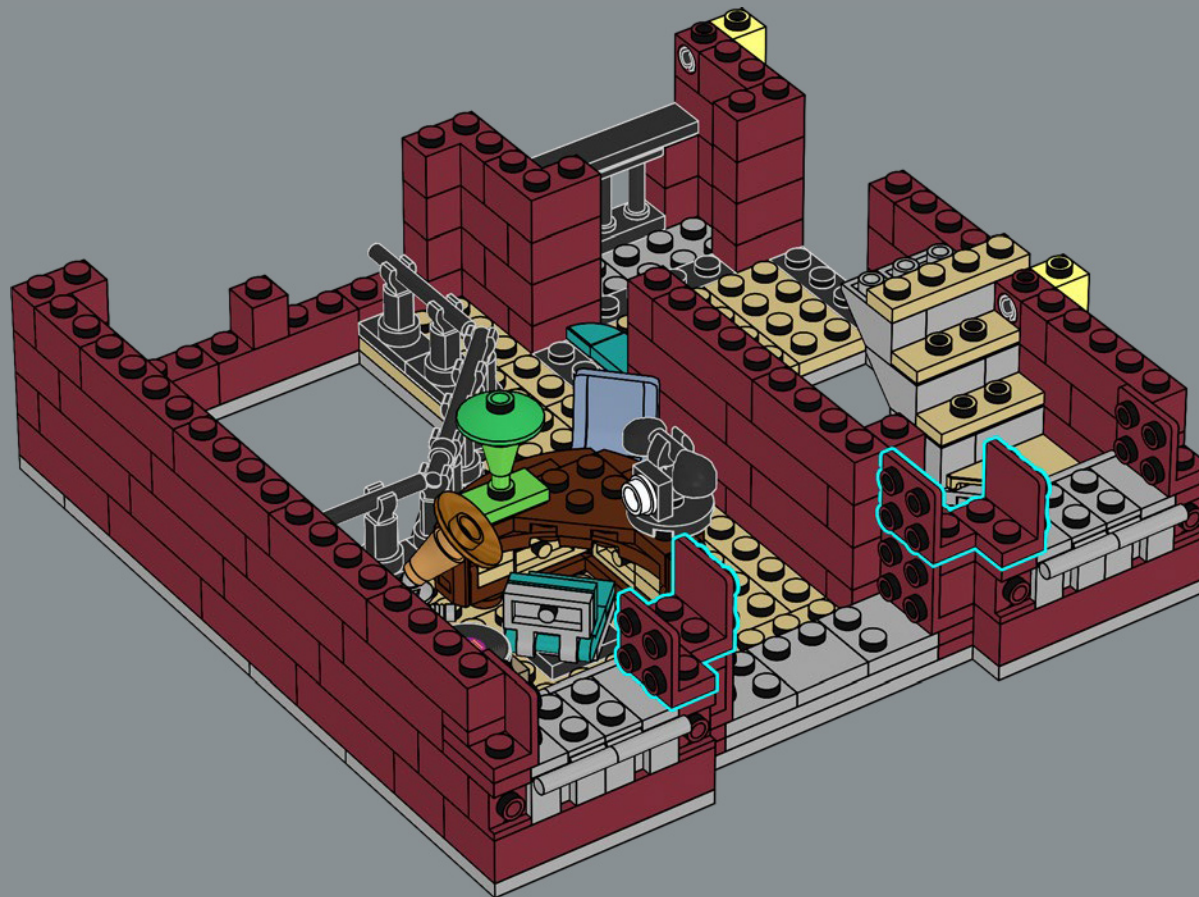

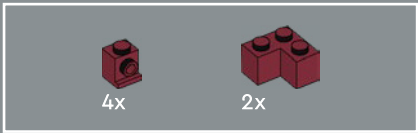

197

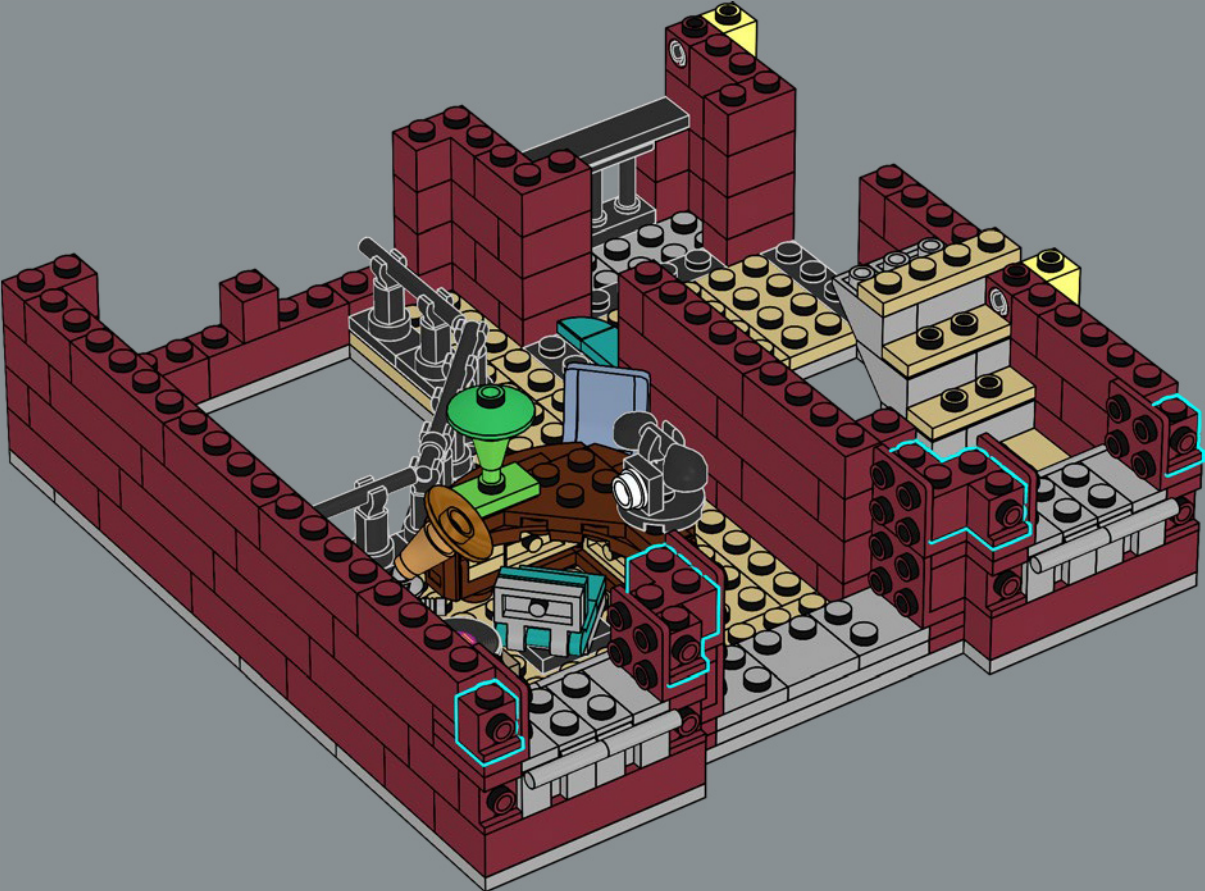

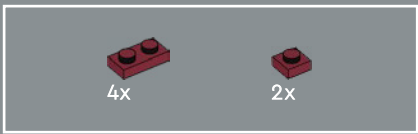

198

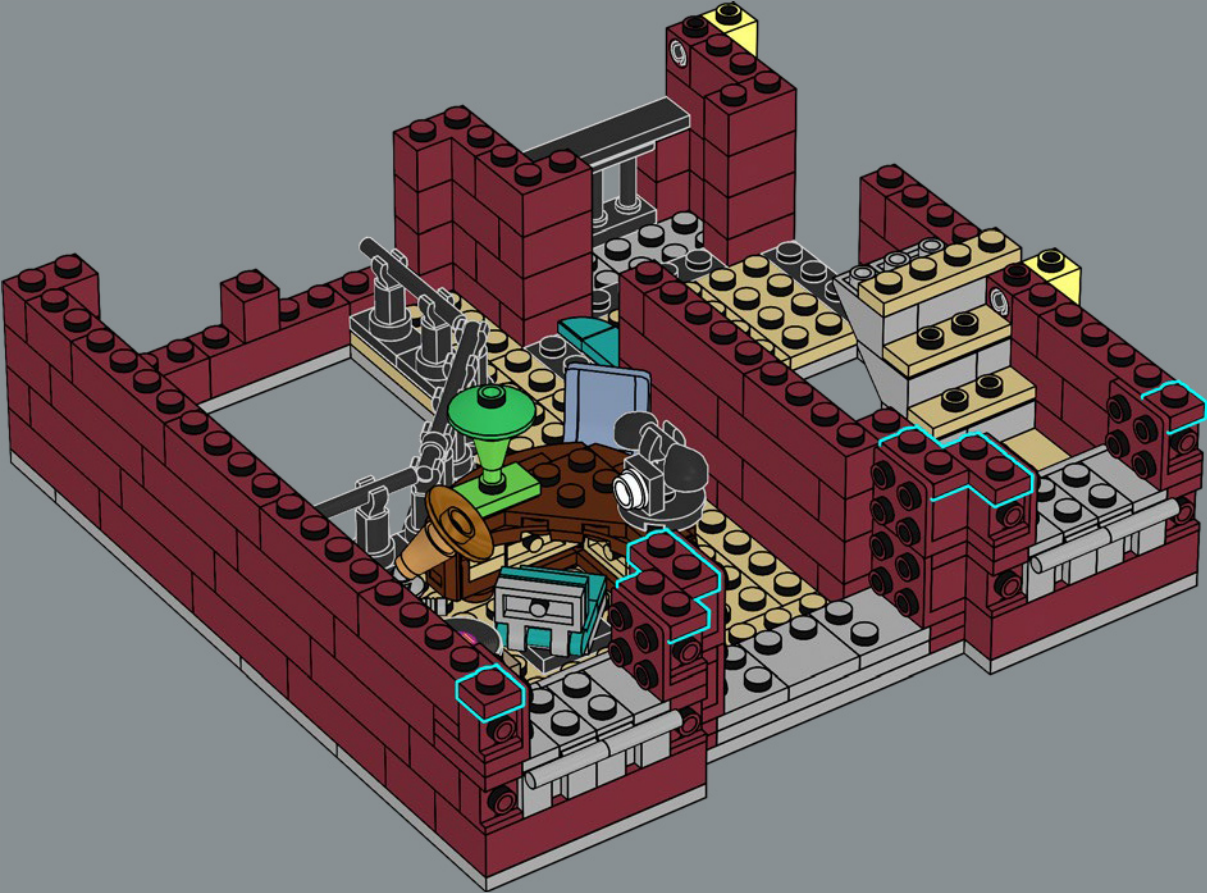

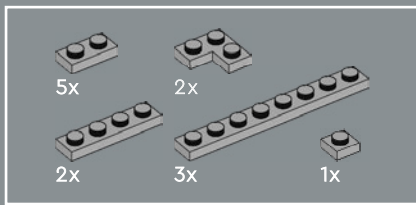

199

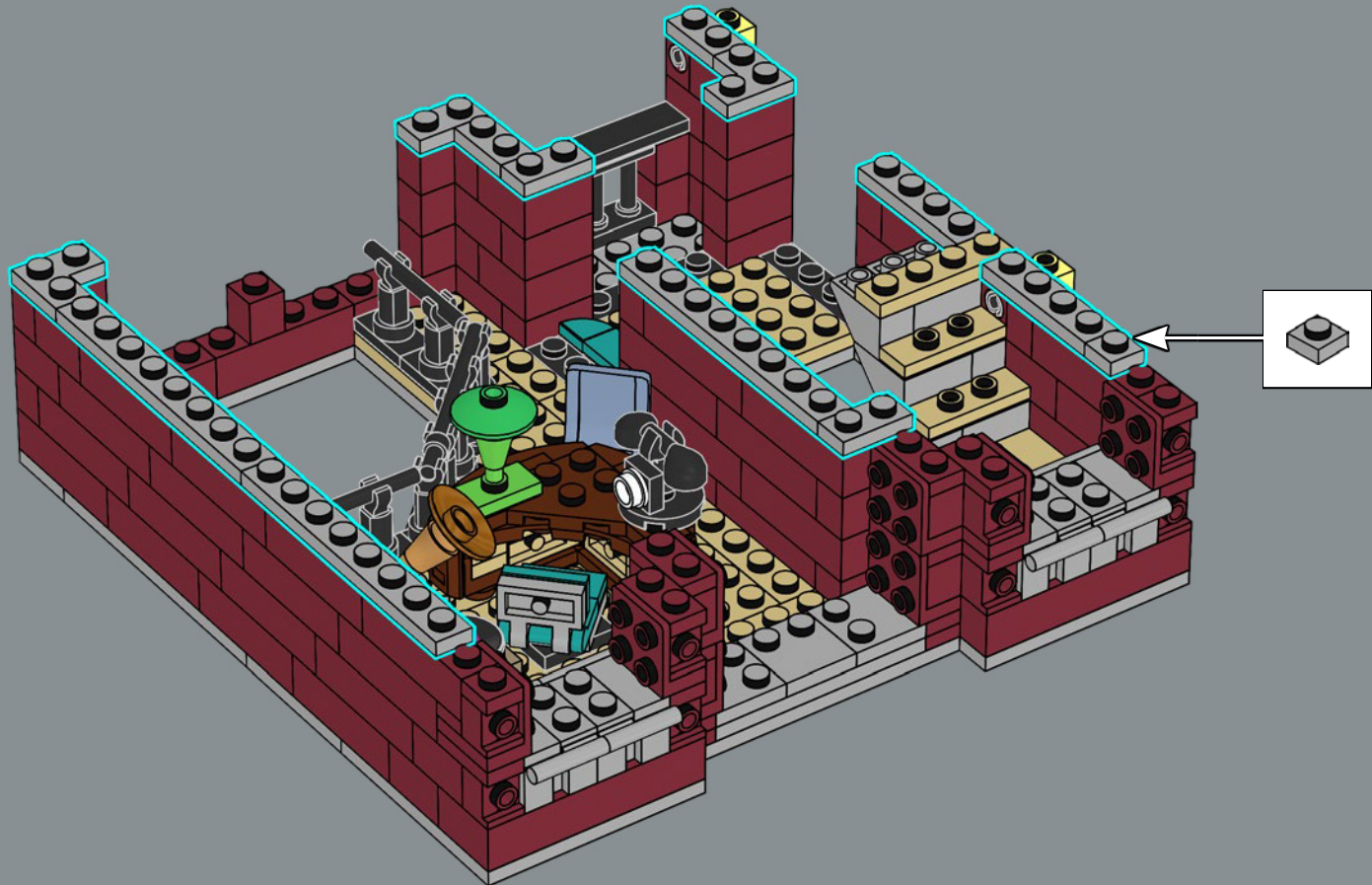



6x

200

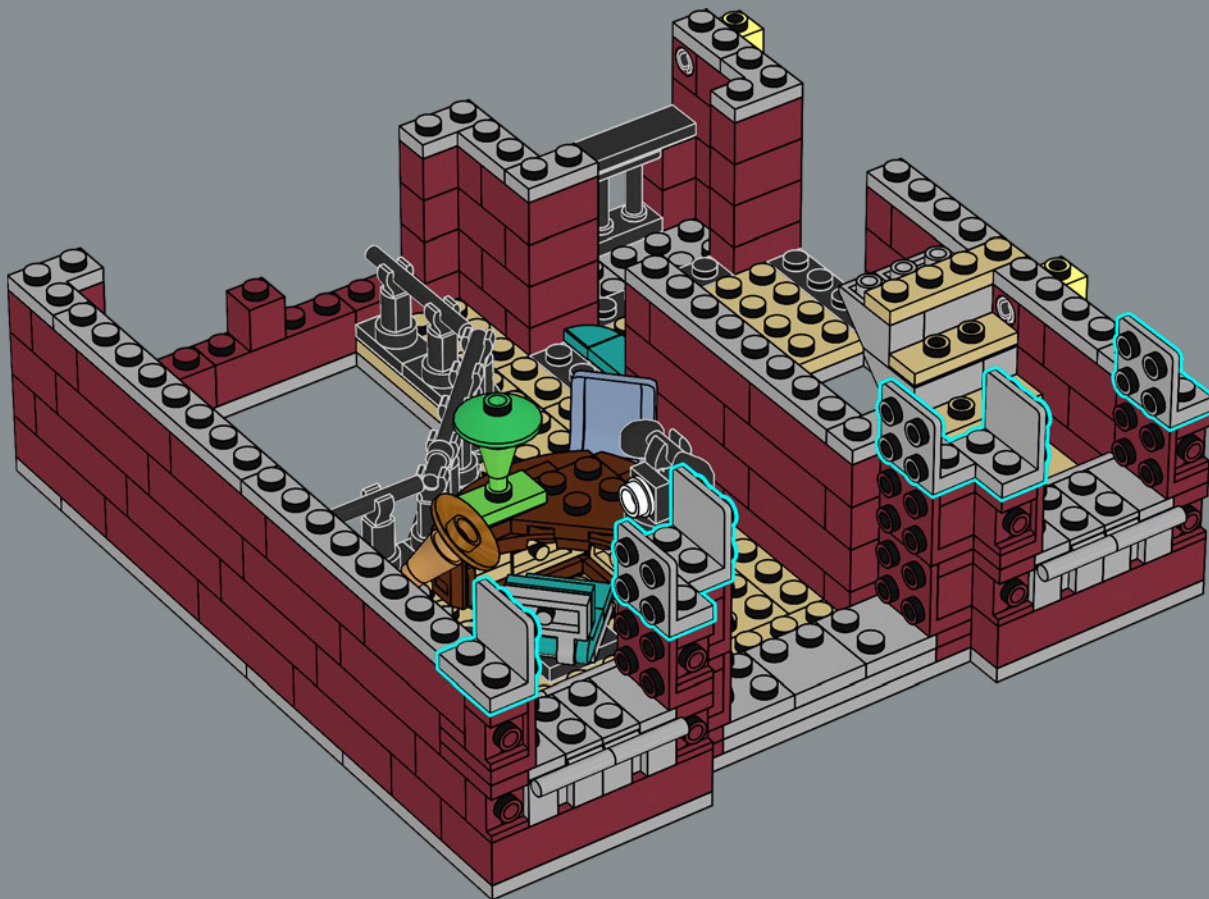



The wall art in the office is a small piece by the artist living in the loft above the LEGO® 10243 Parisian Restaurant.

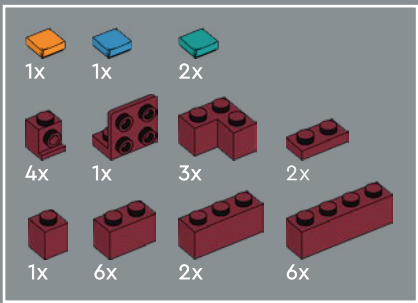

201

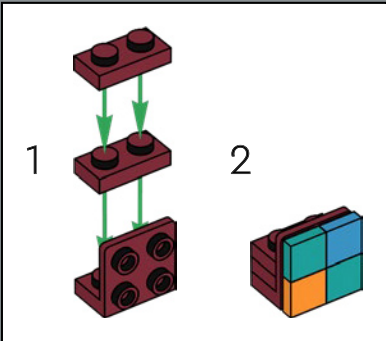

1 2

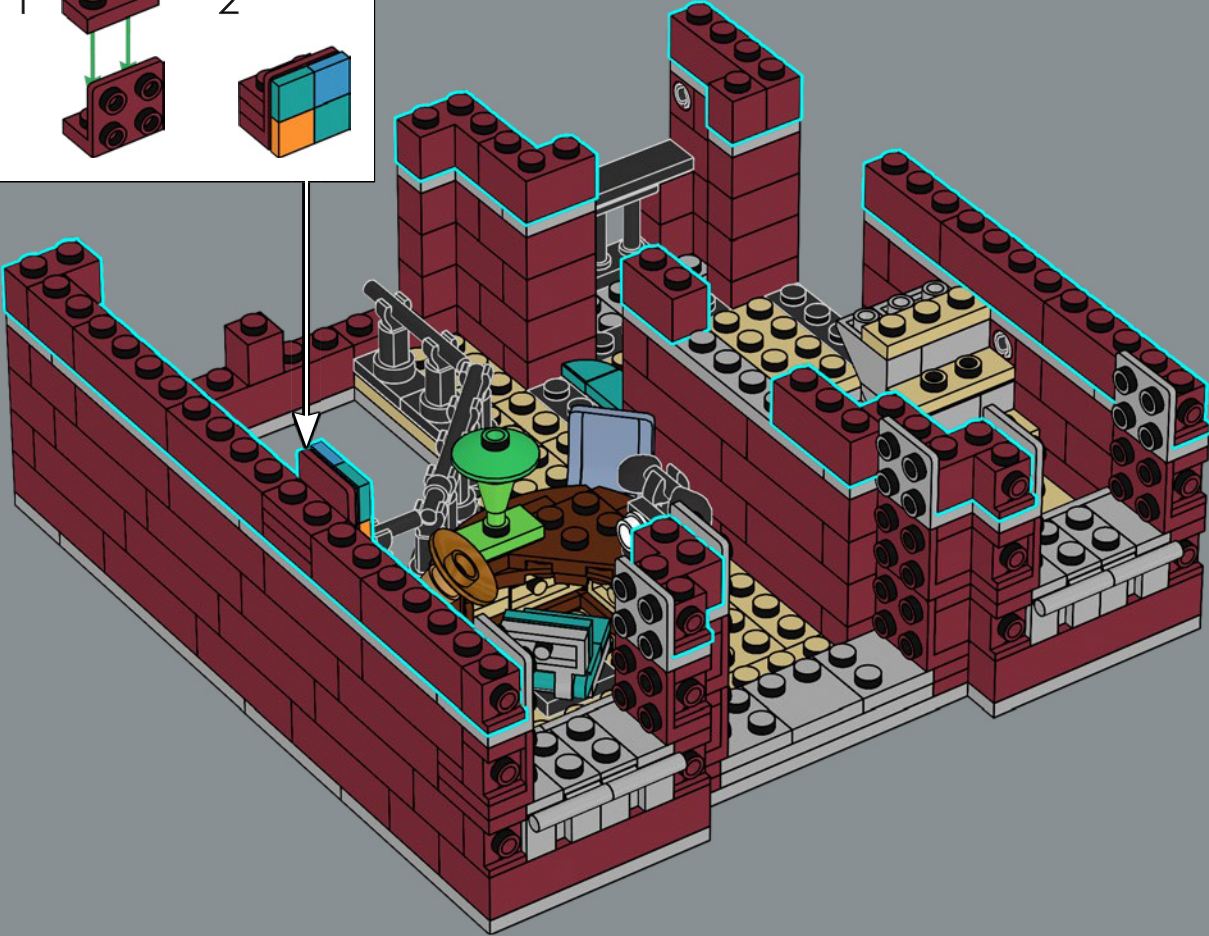



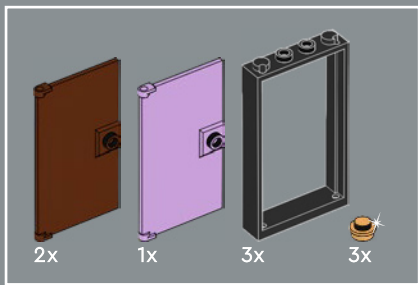

202

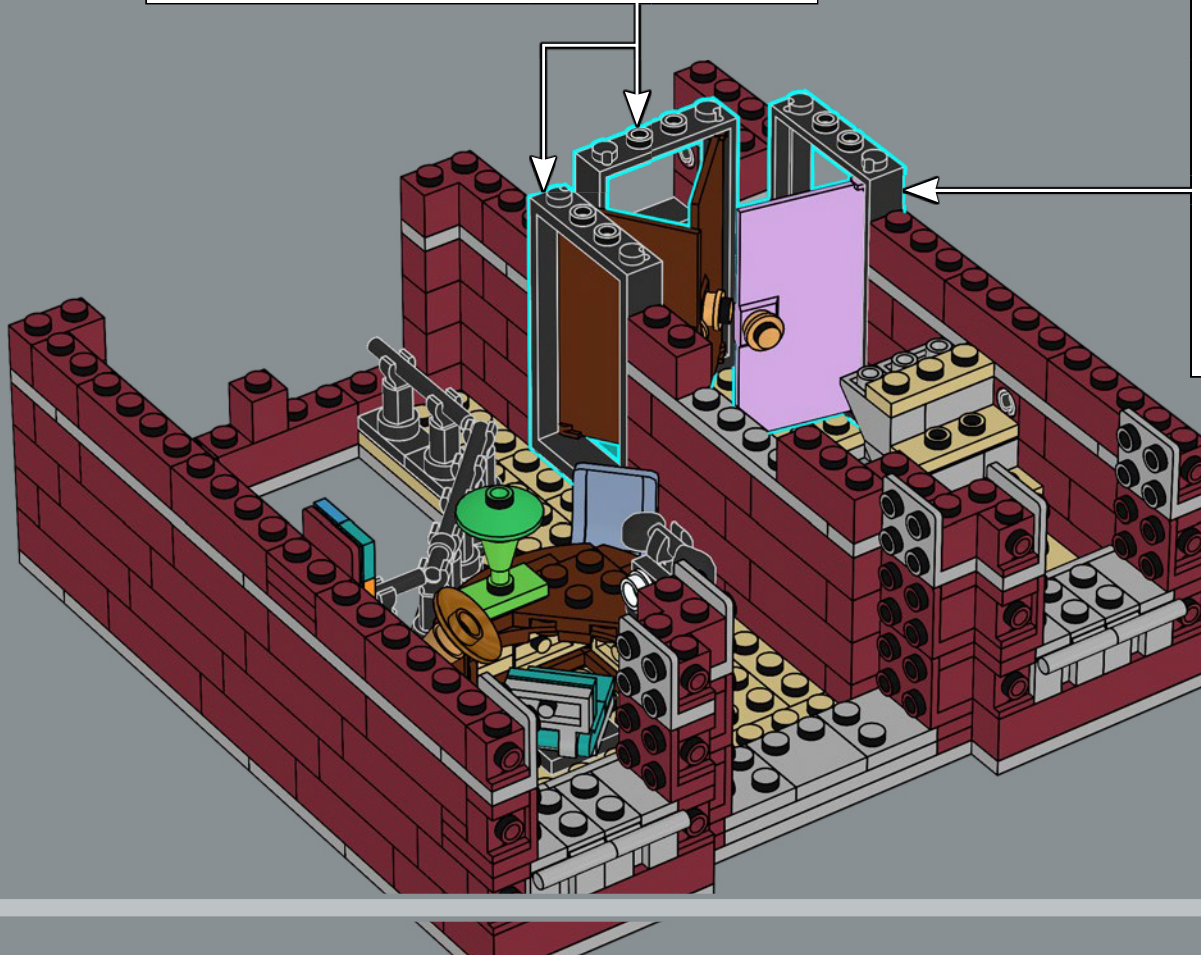
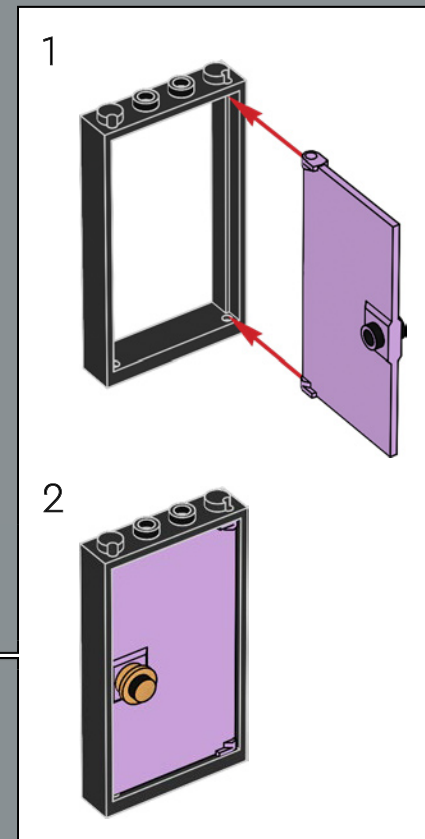
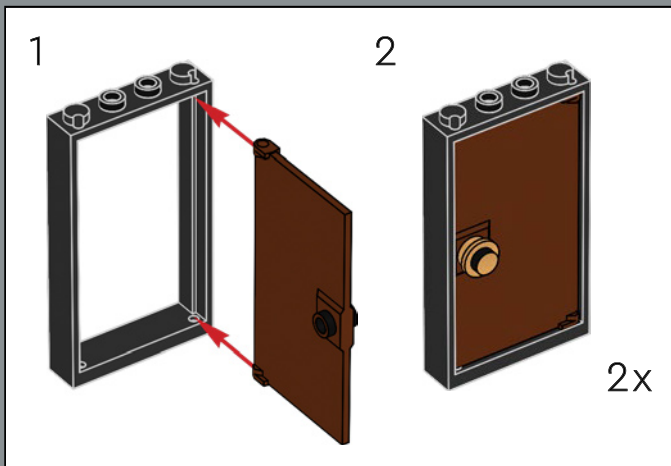

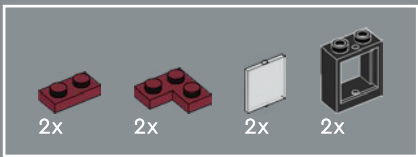

203

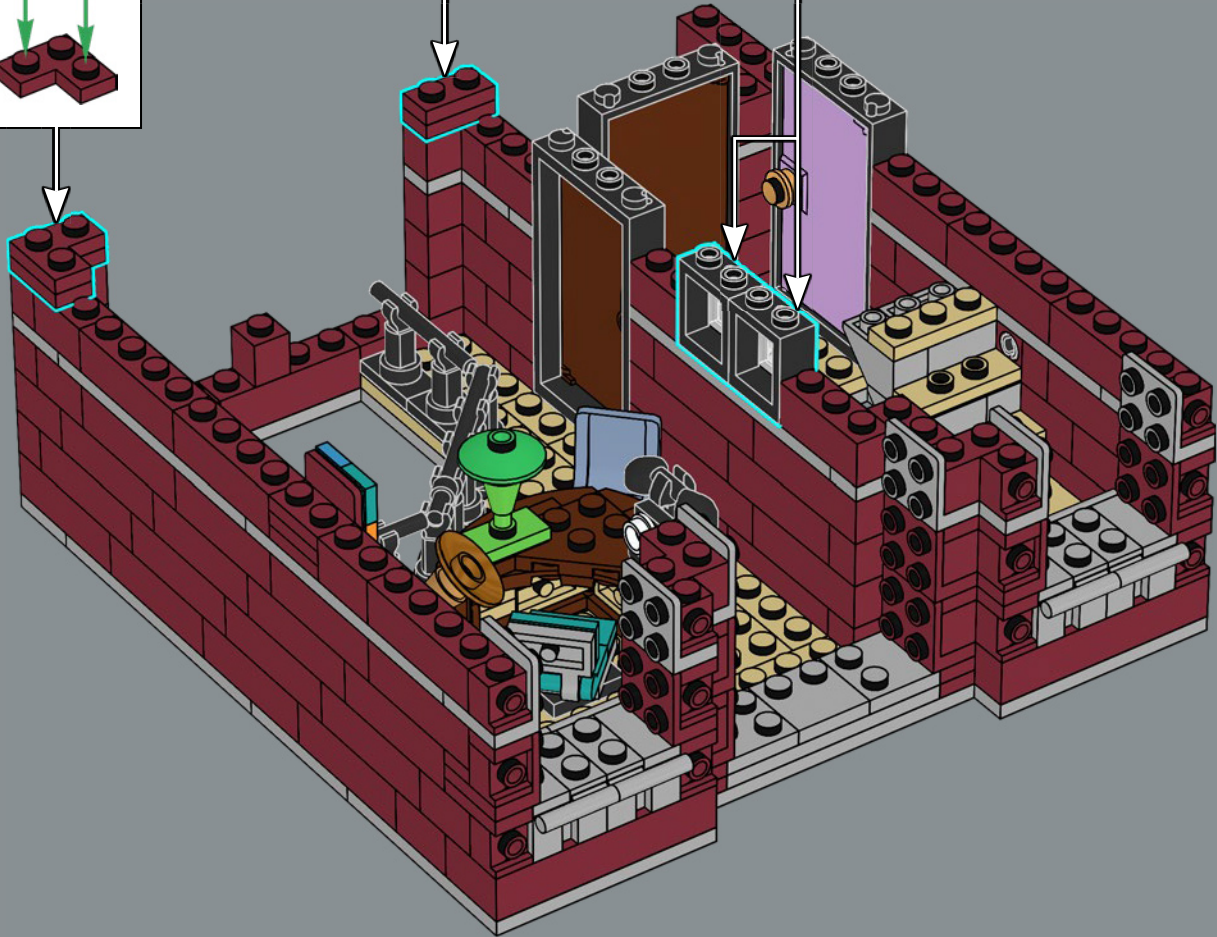
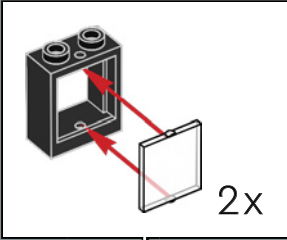
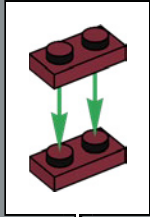
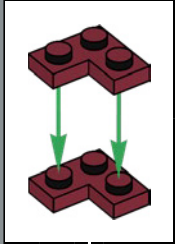

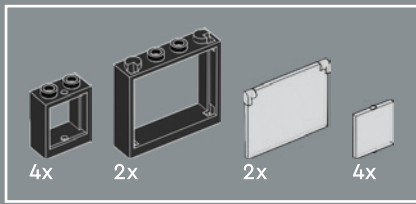

204

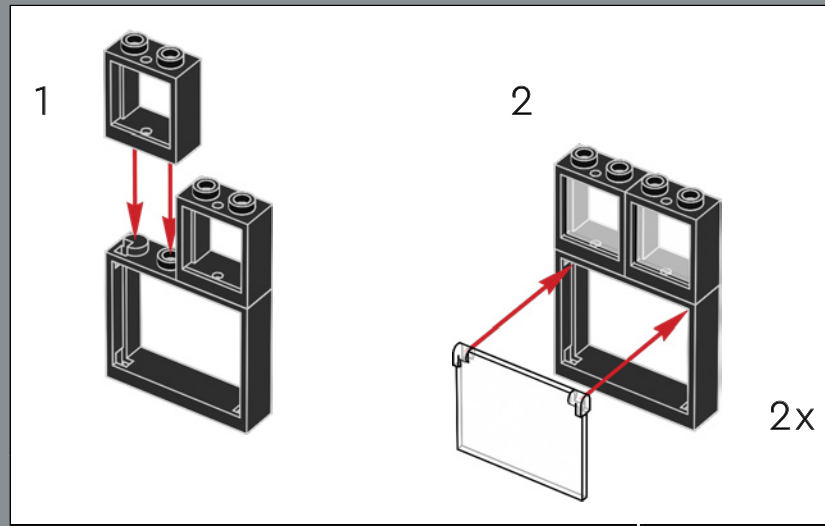



205

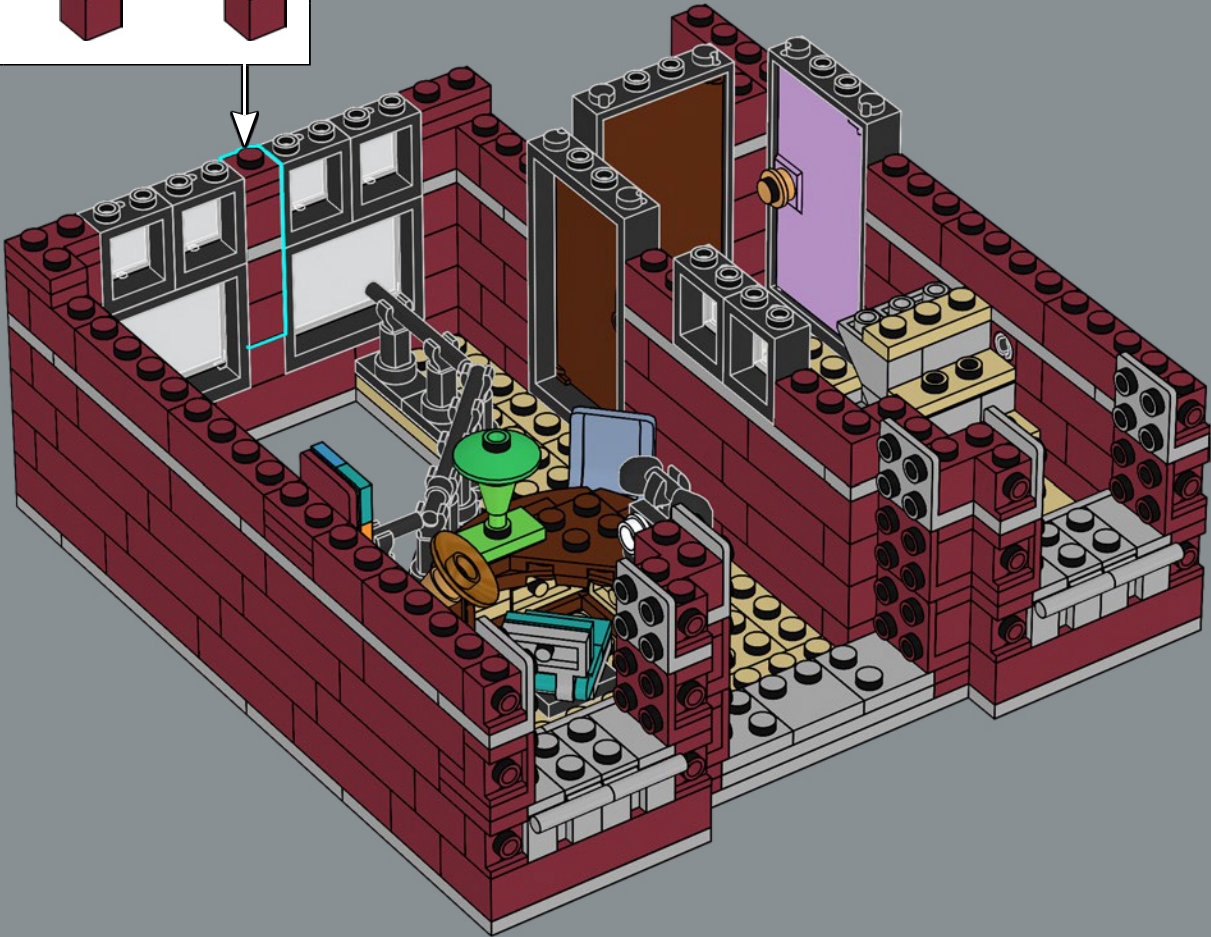
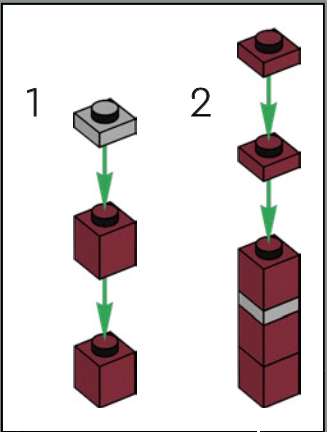

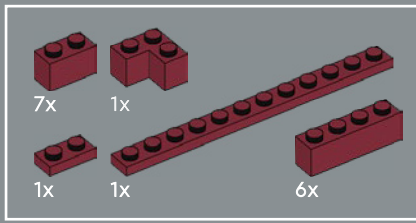

206



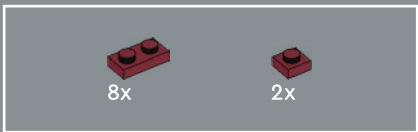

207

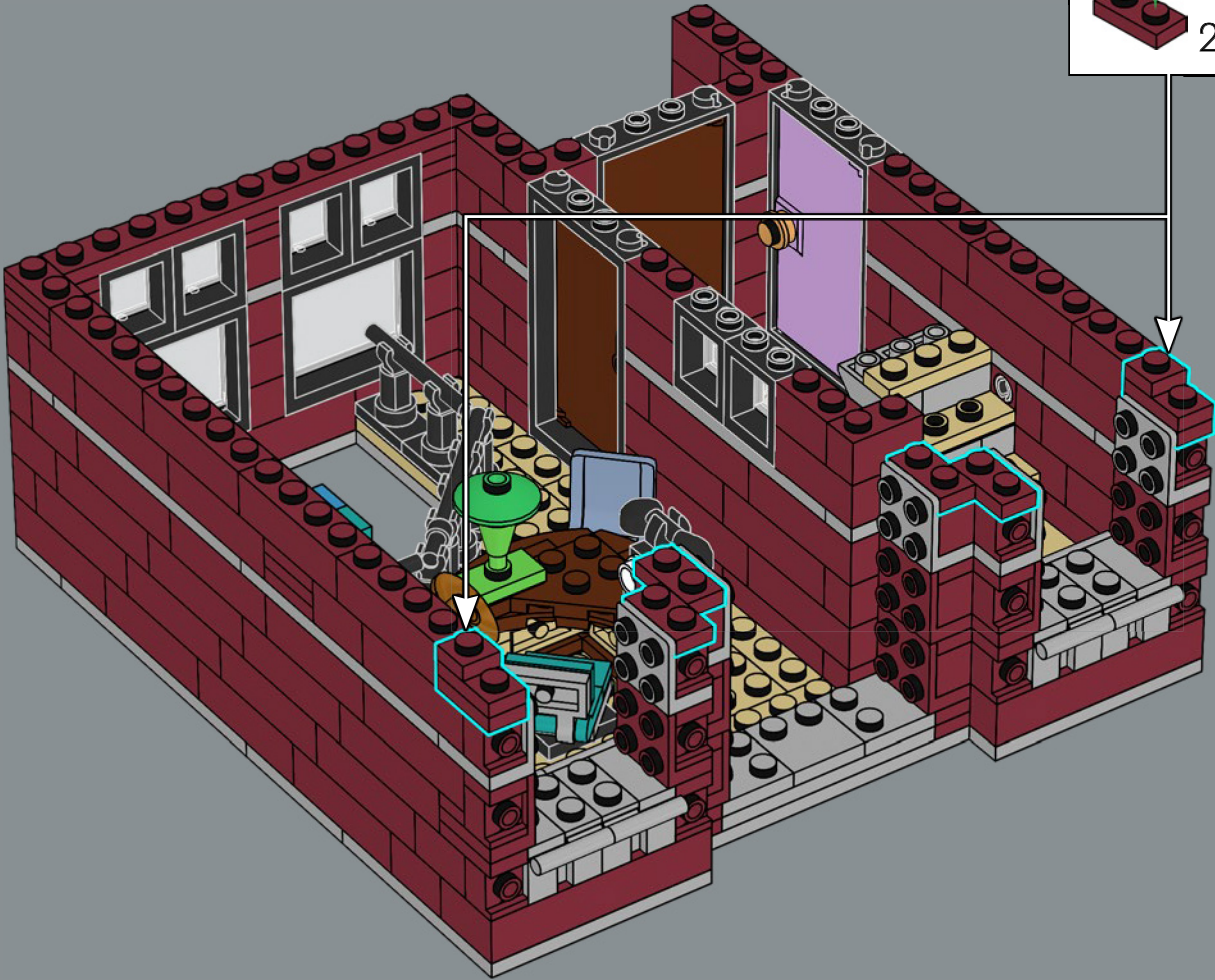
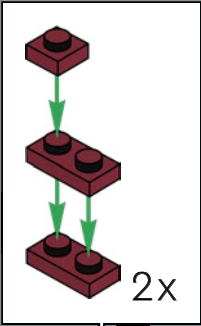

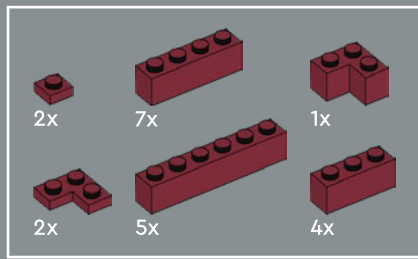

208

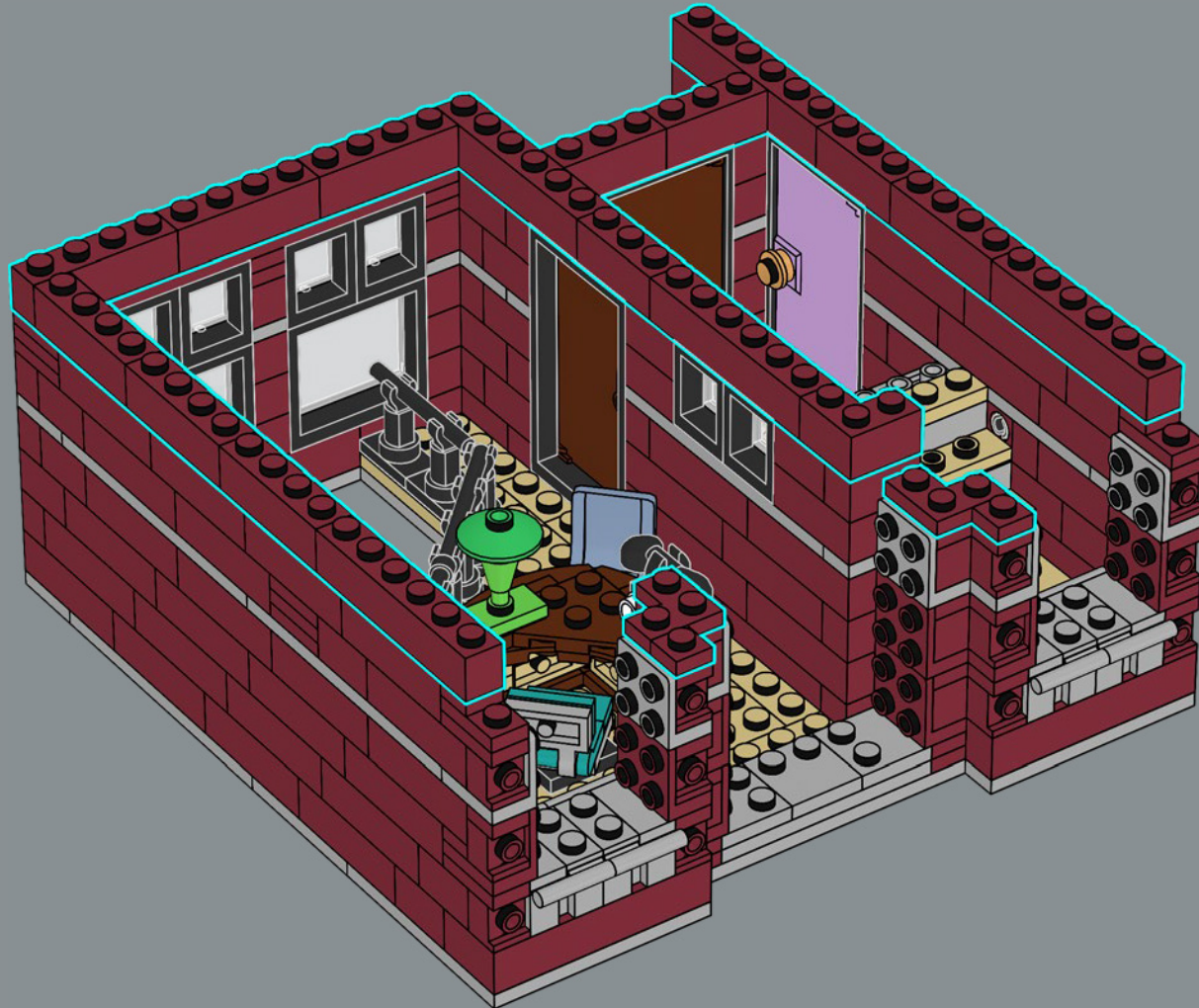



8x

209

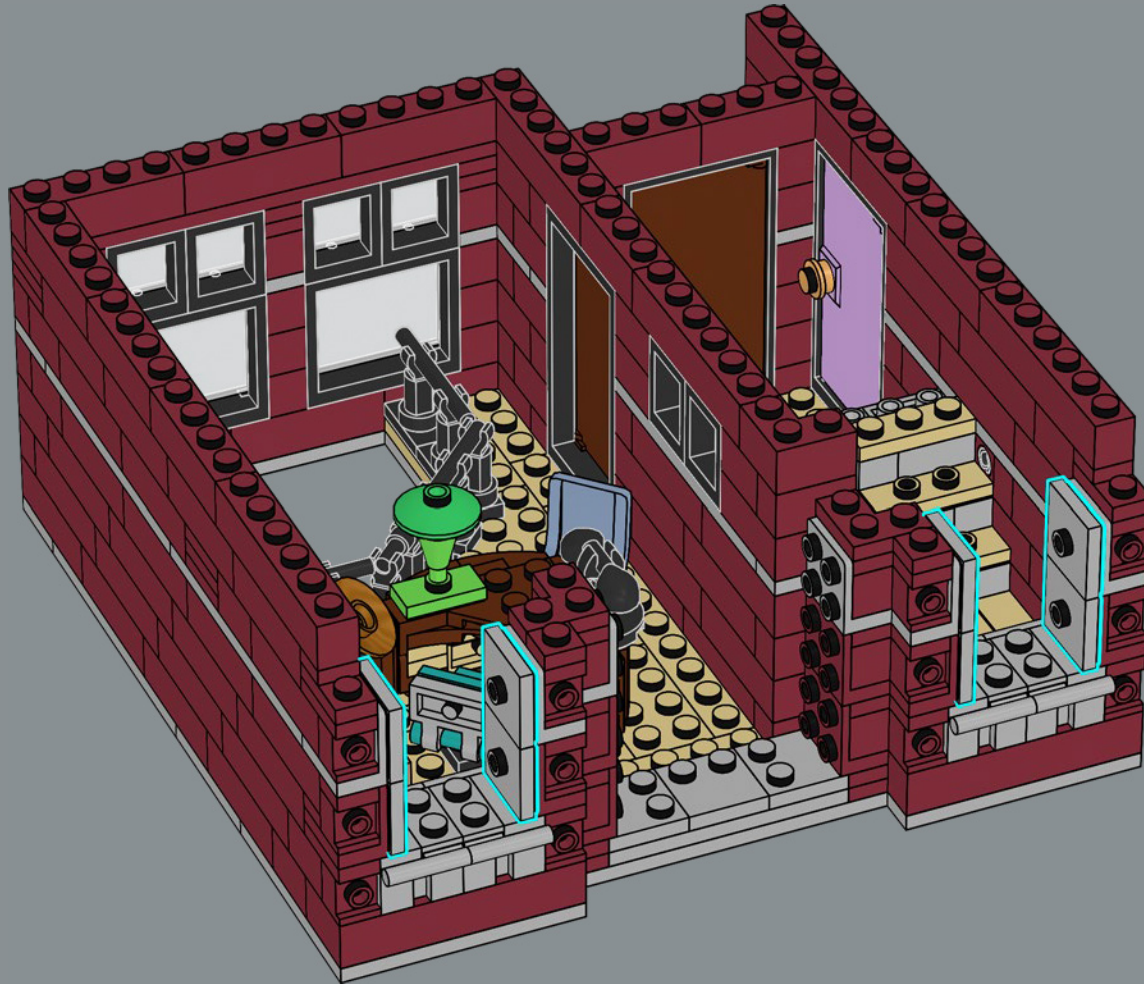

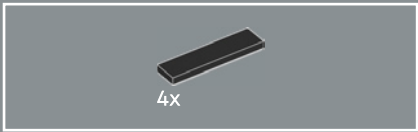

210

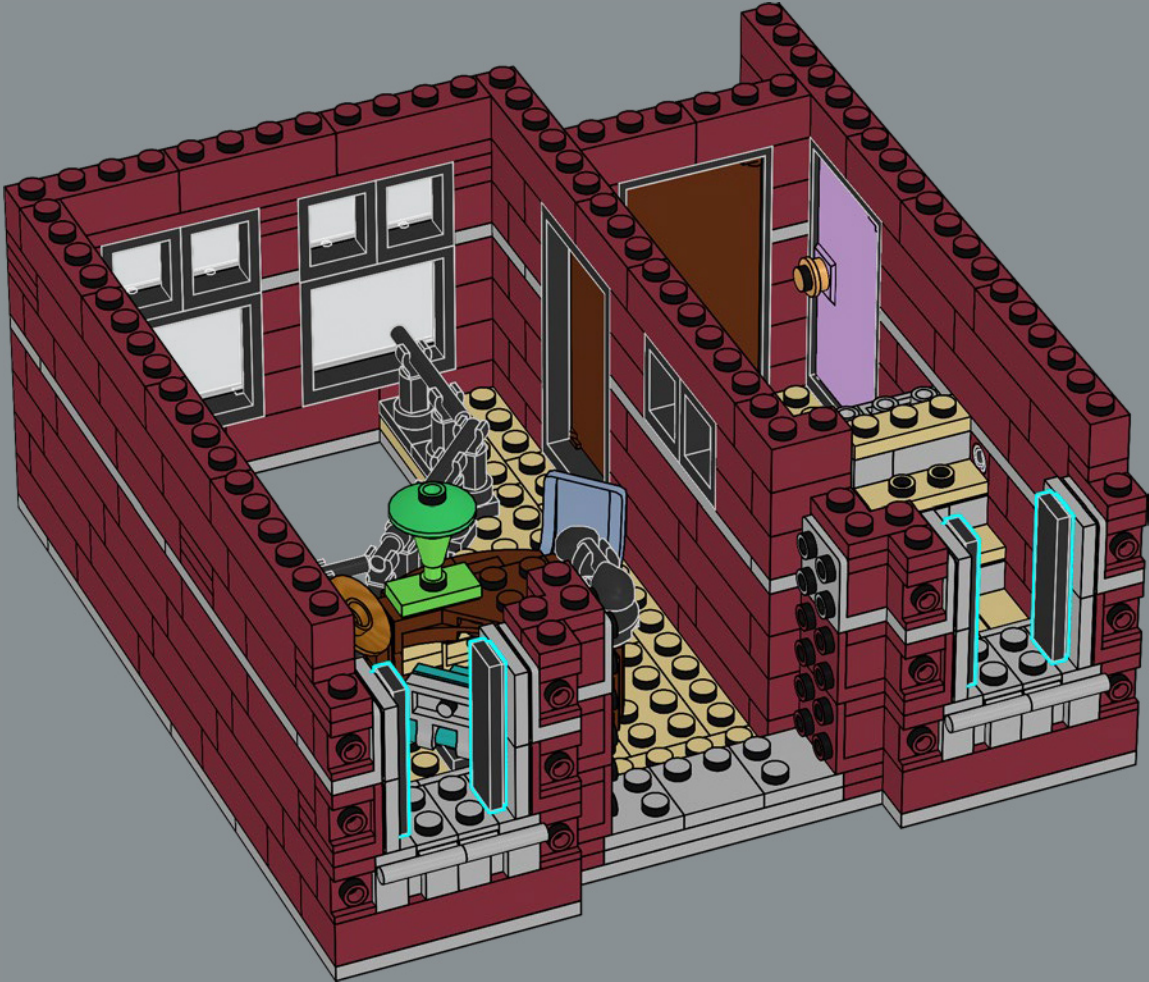

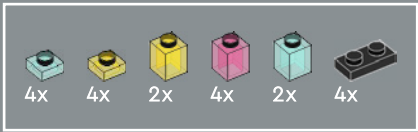

211

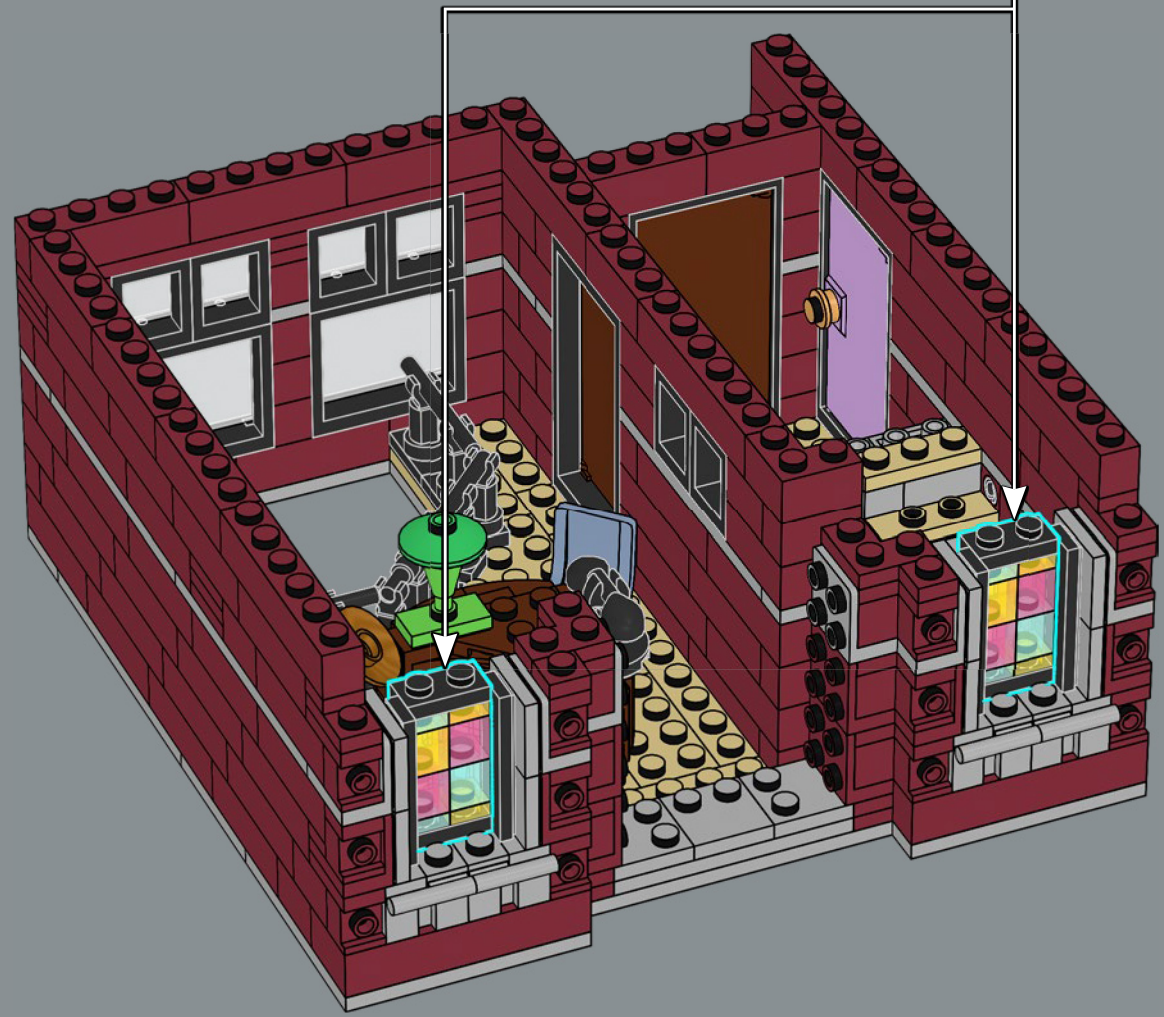
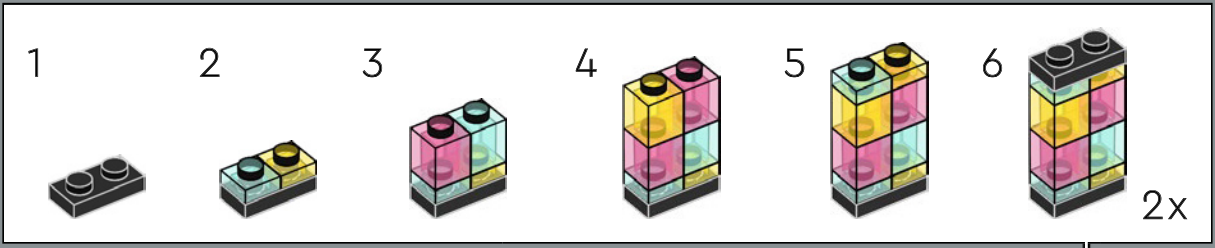

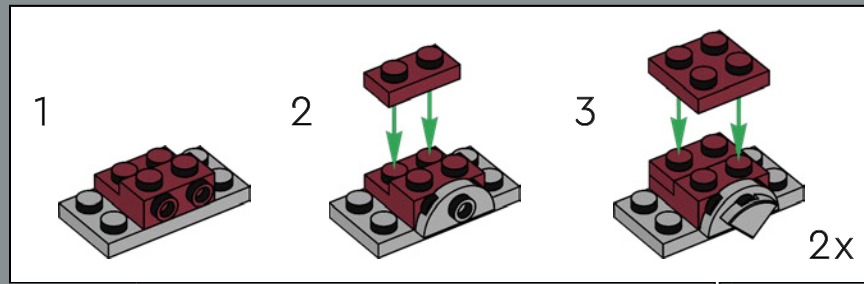
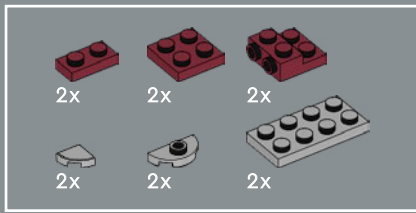

212

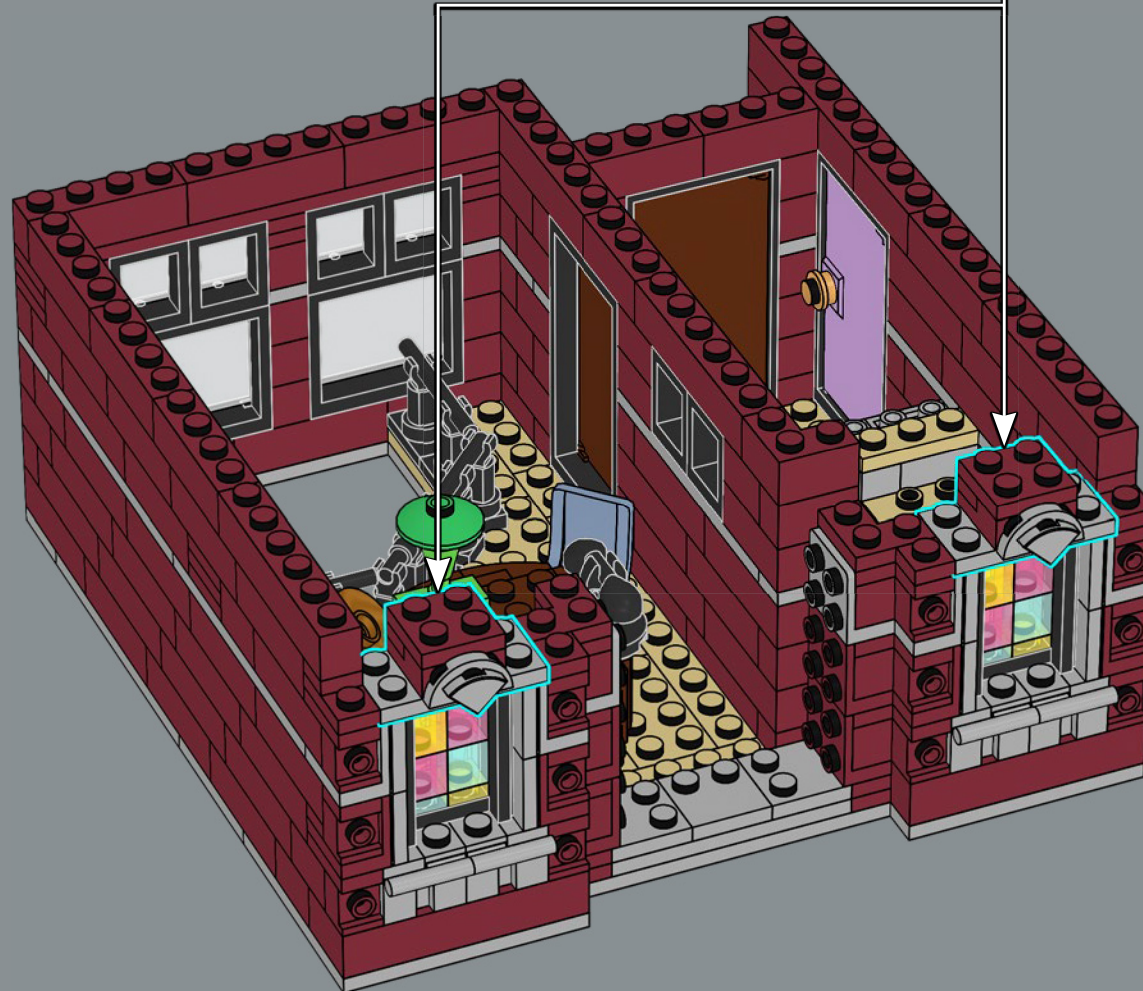

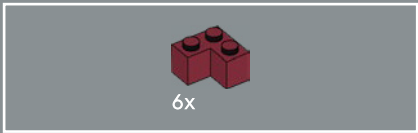

213

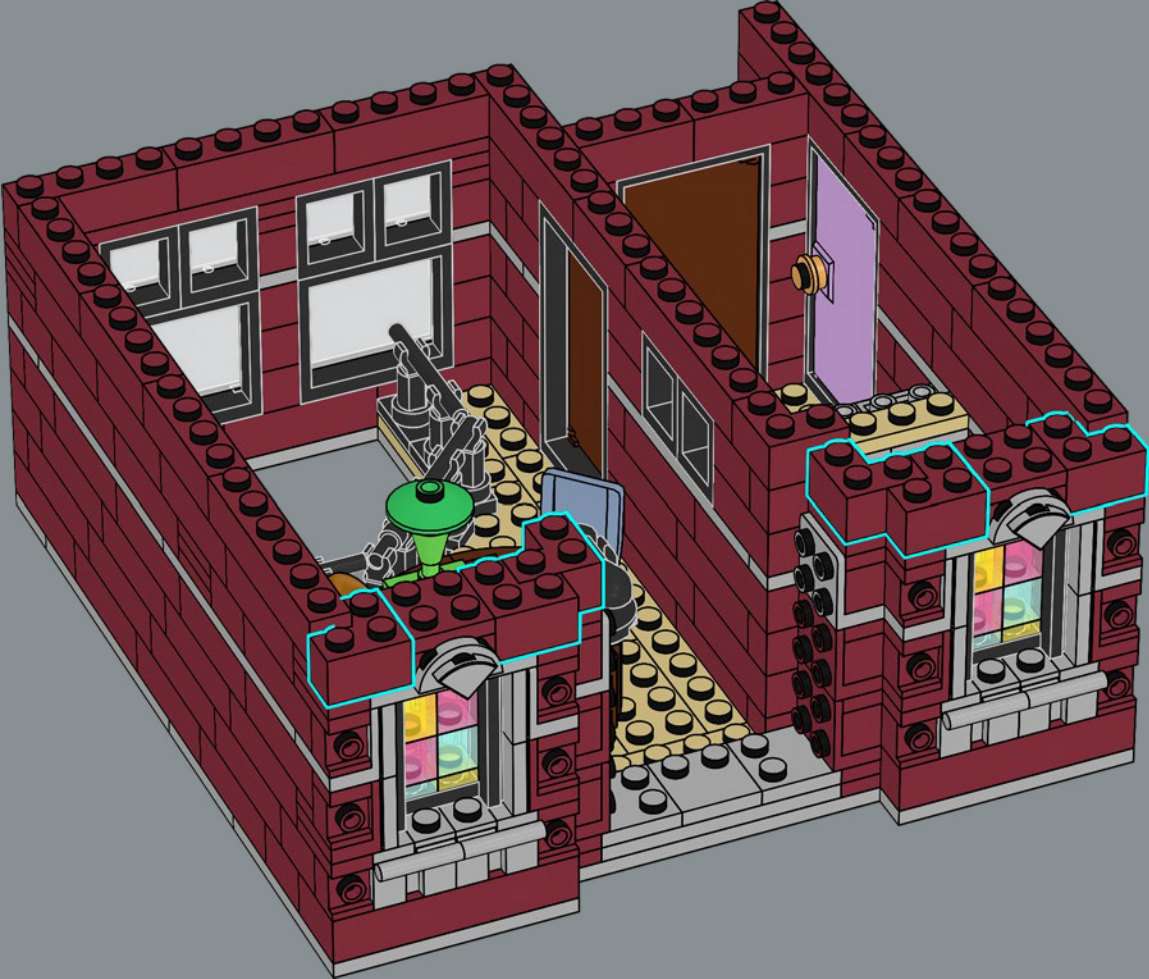

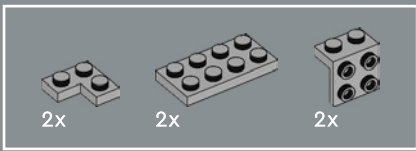

214

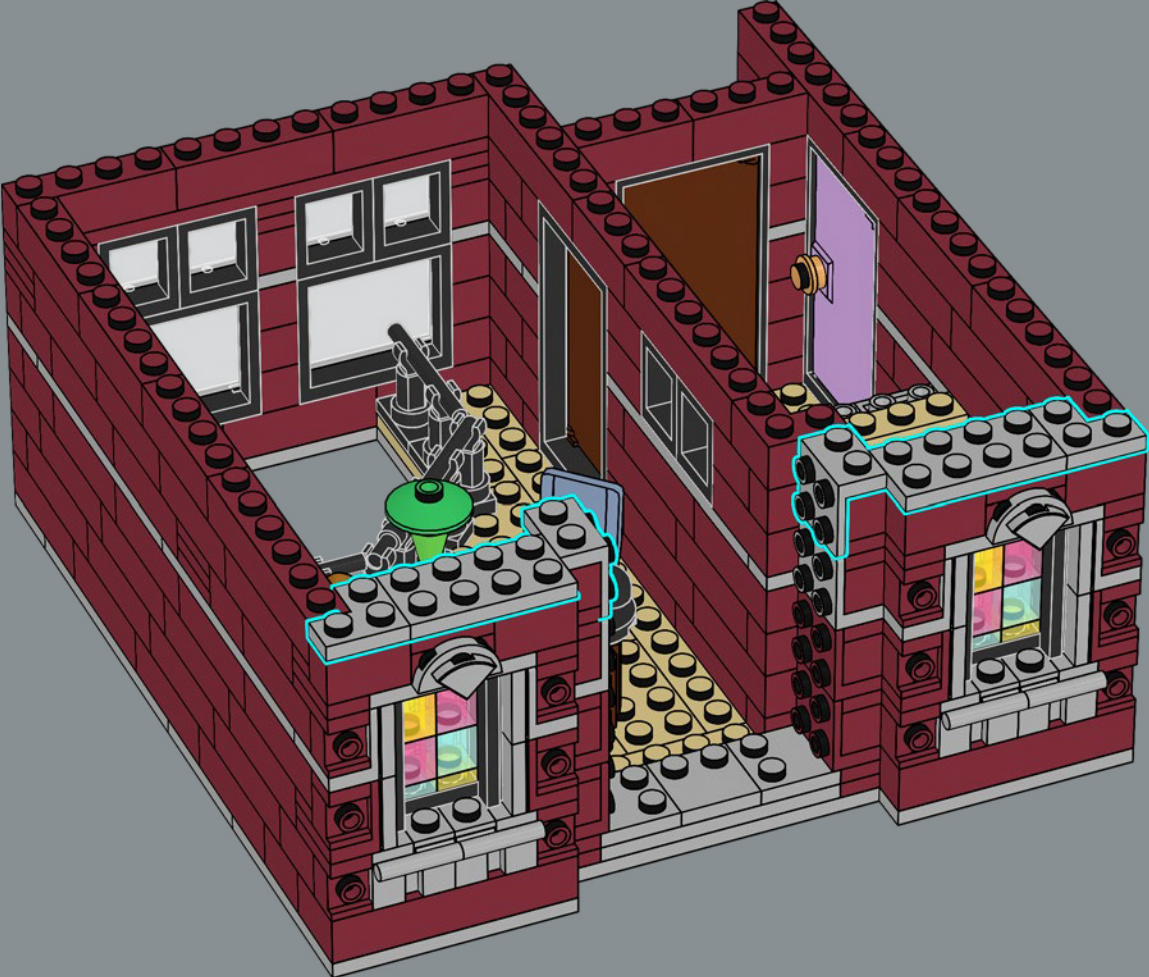

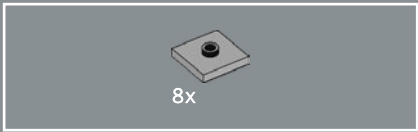

215

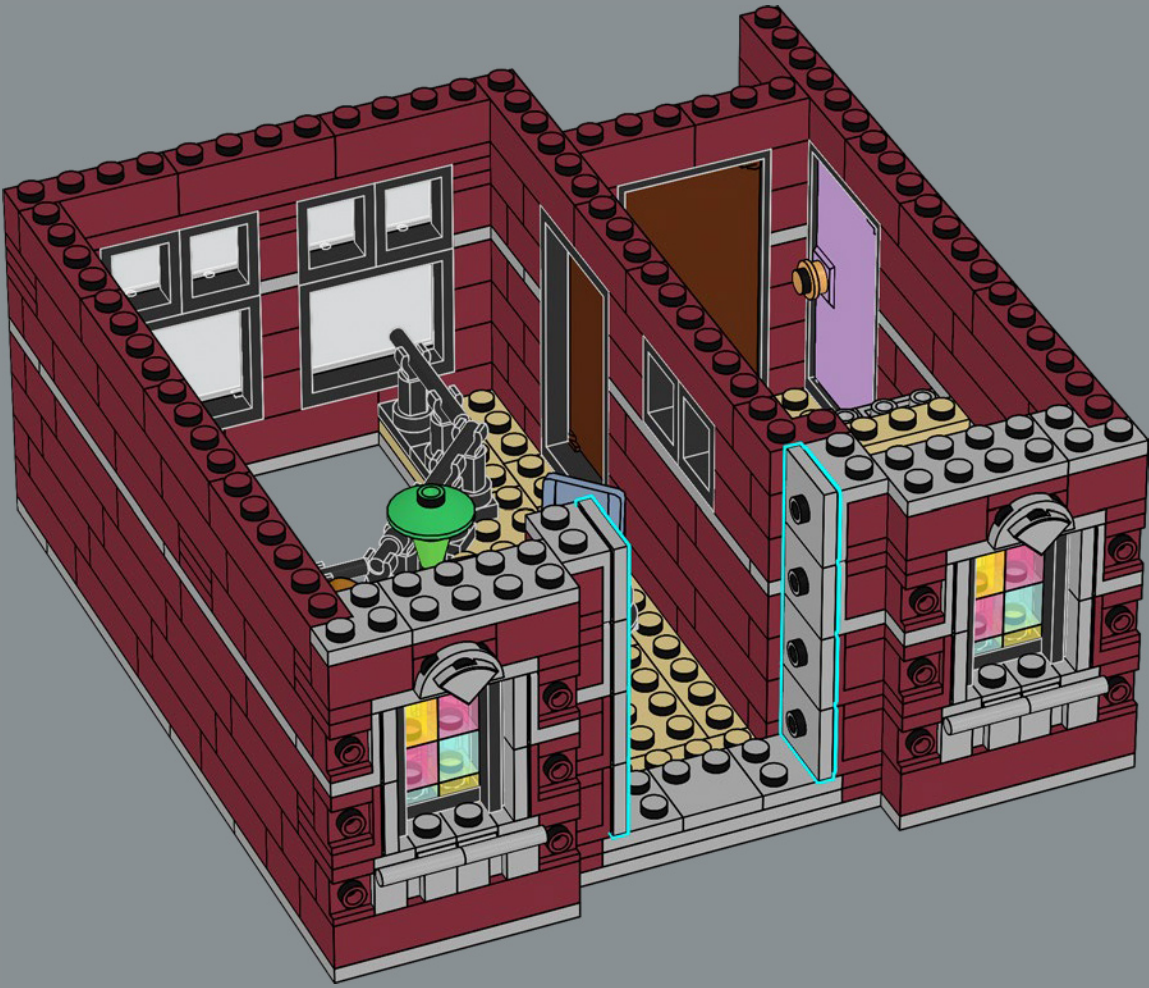

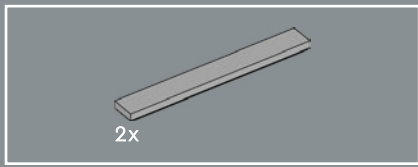

216

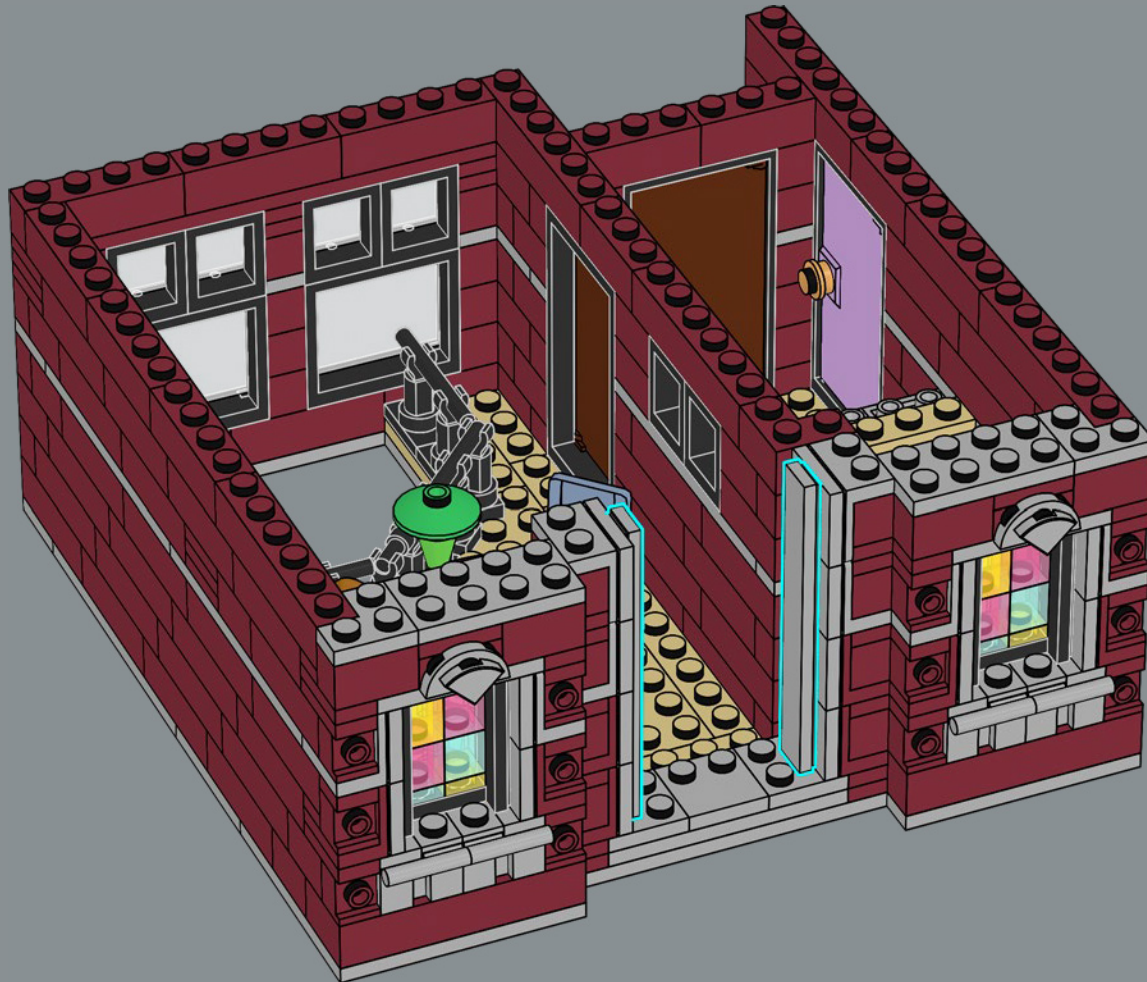

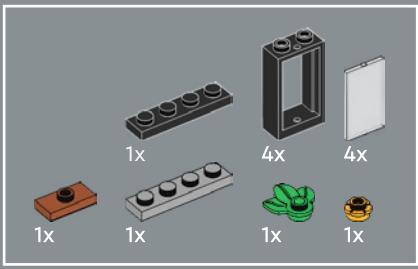

217

1

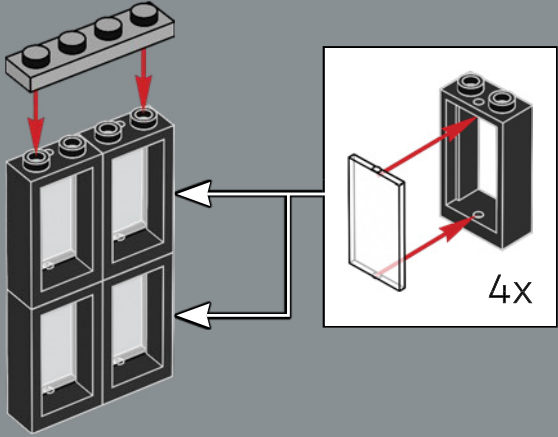

2

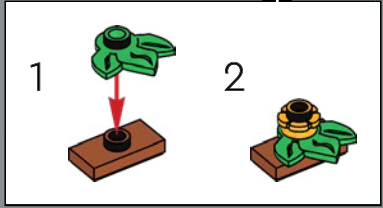
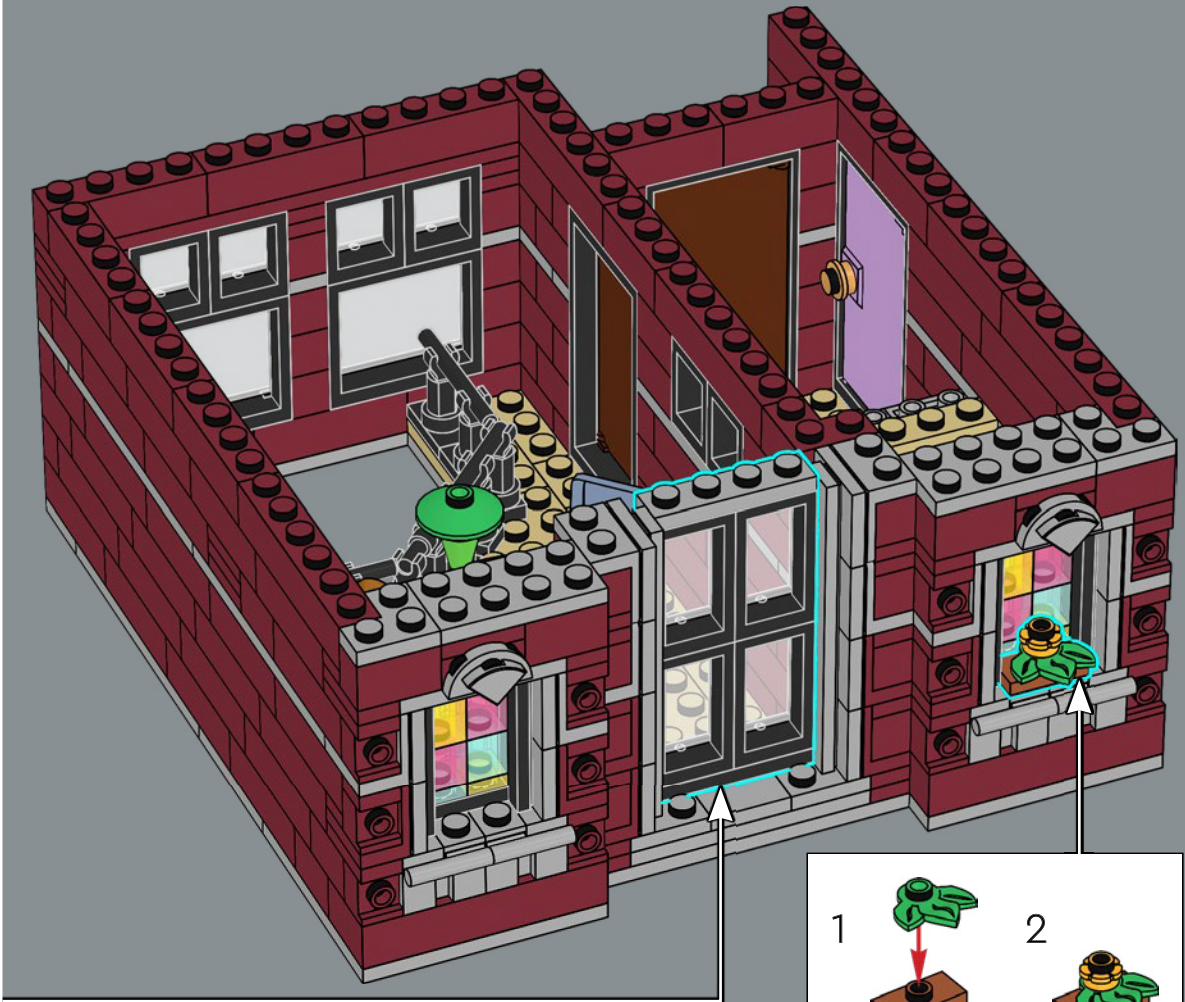
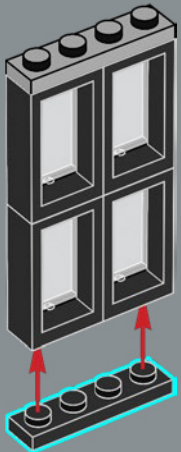

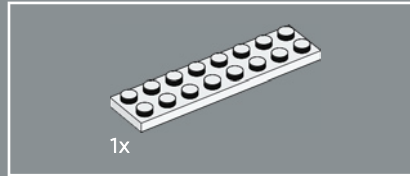
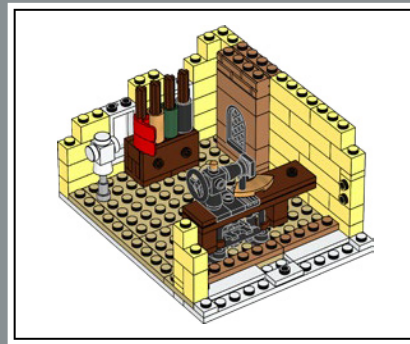

1x

218

Have you purchased a new outfit at the LEGO® 10211 Grand Emporium, but it just doesn't fit right? Visit the tailor, who will be happy to assist you.

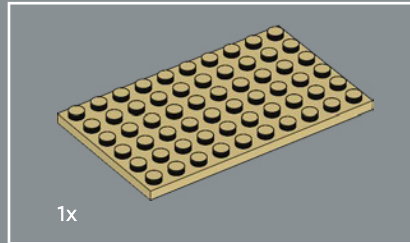
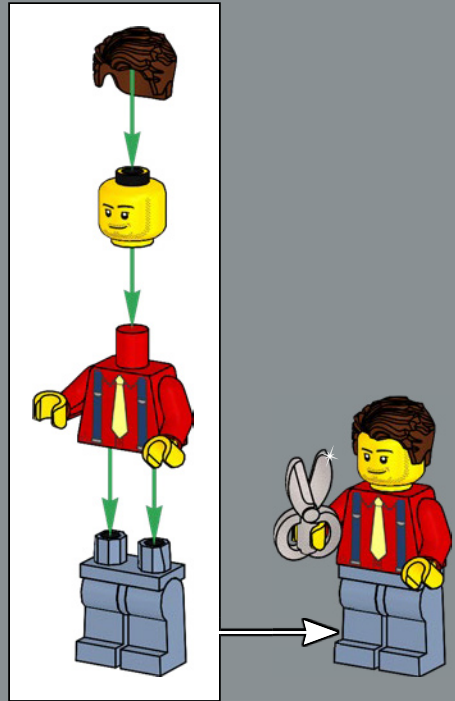
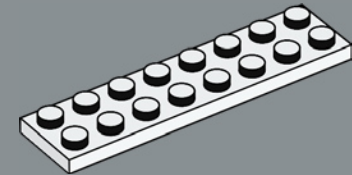

1x

219

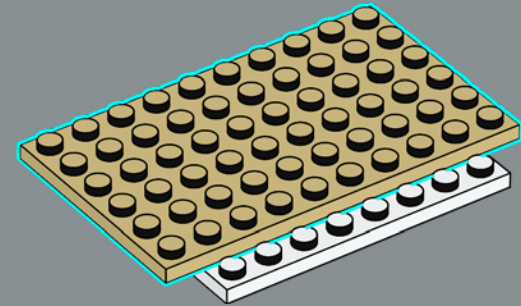

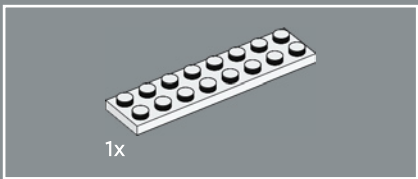

220

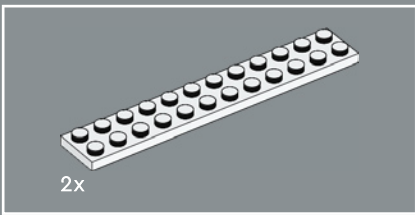
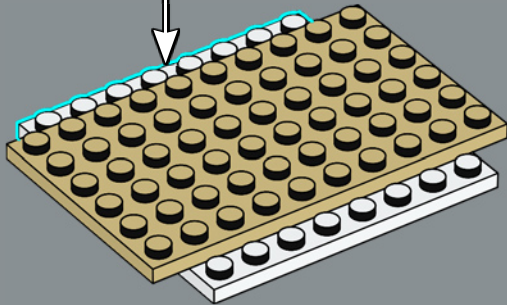
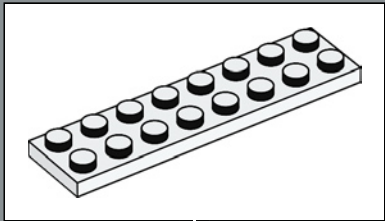

221

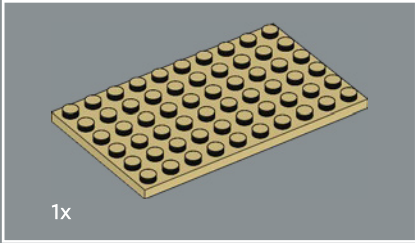
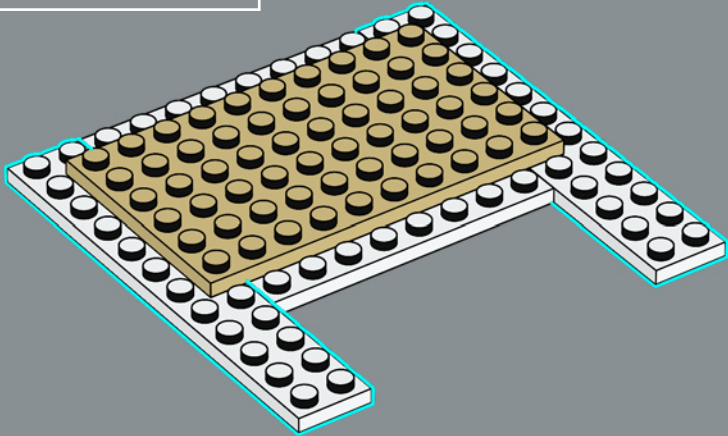

222

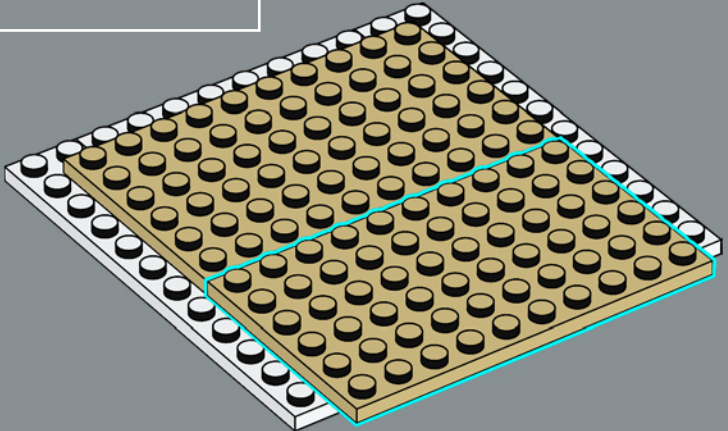

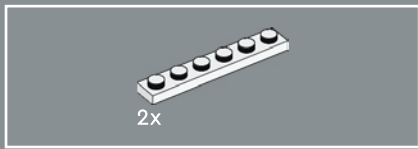

223

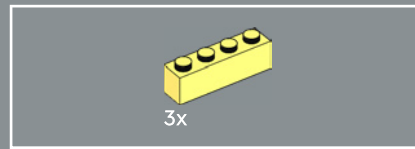
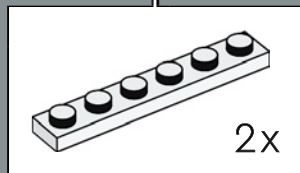
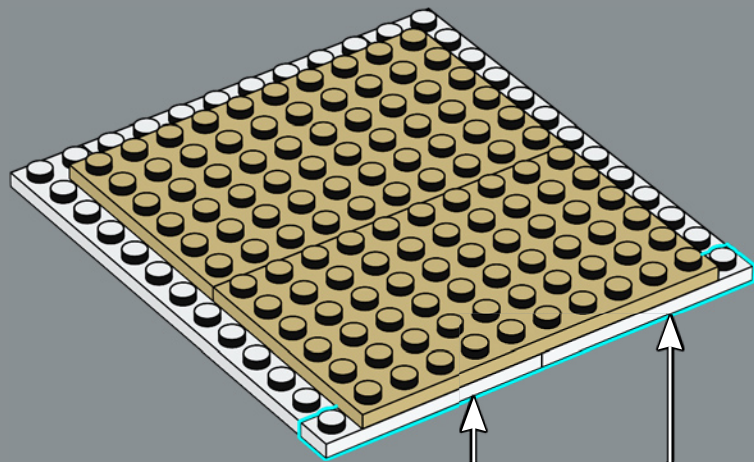

224

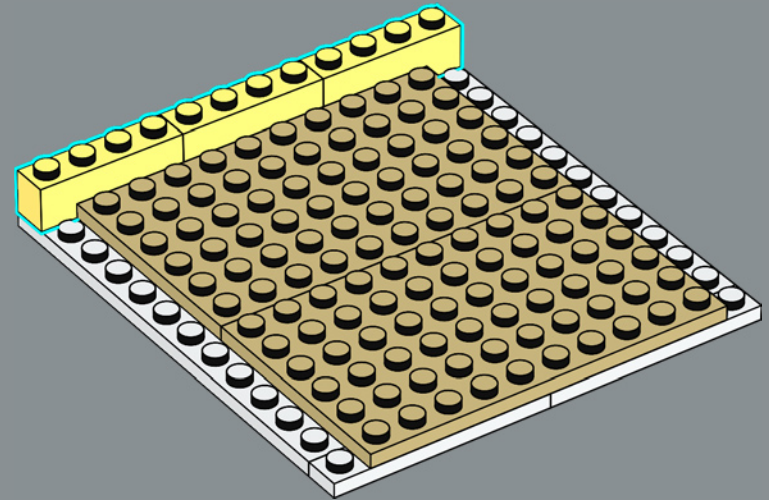

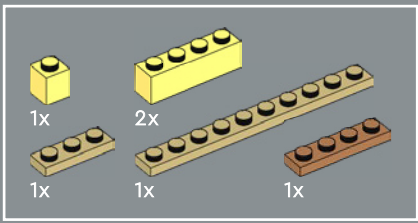

225

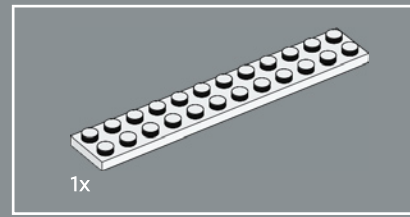
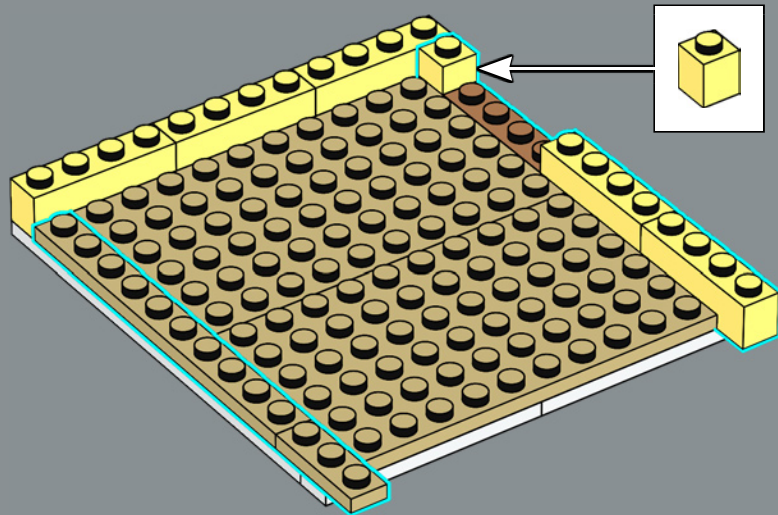

226

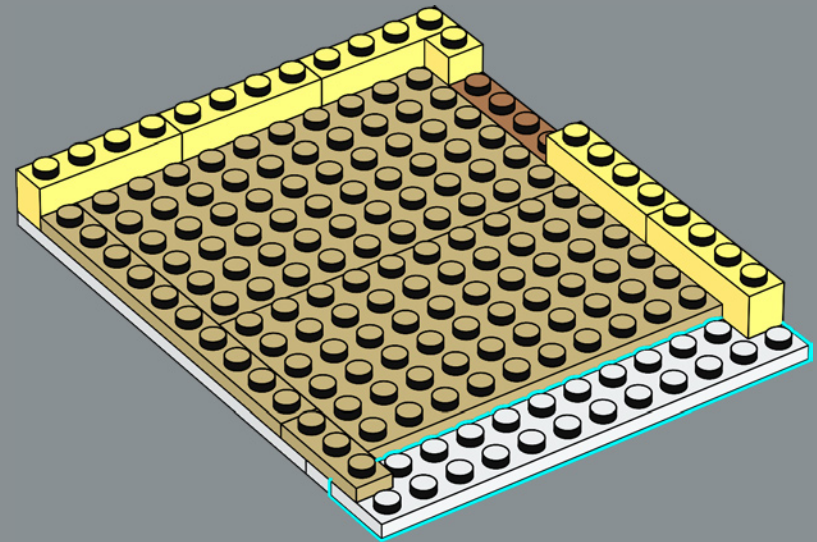

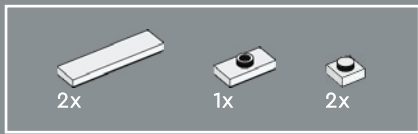

227

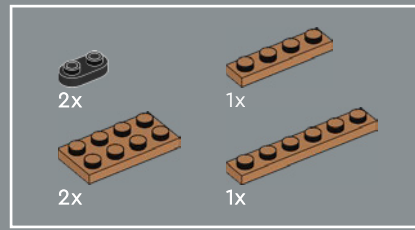
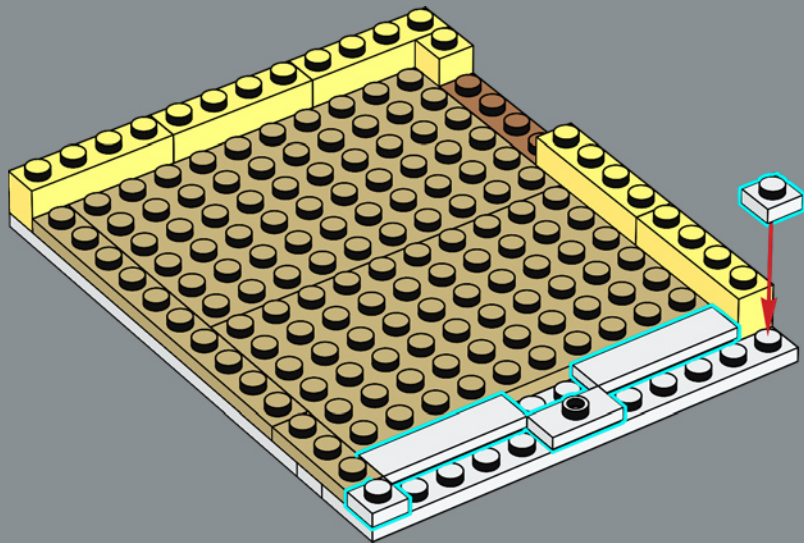

228

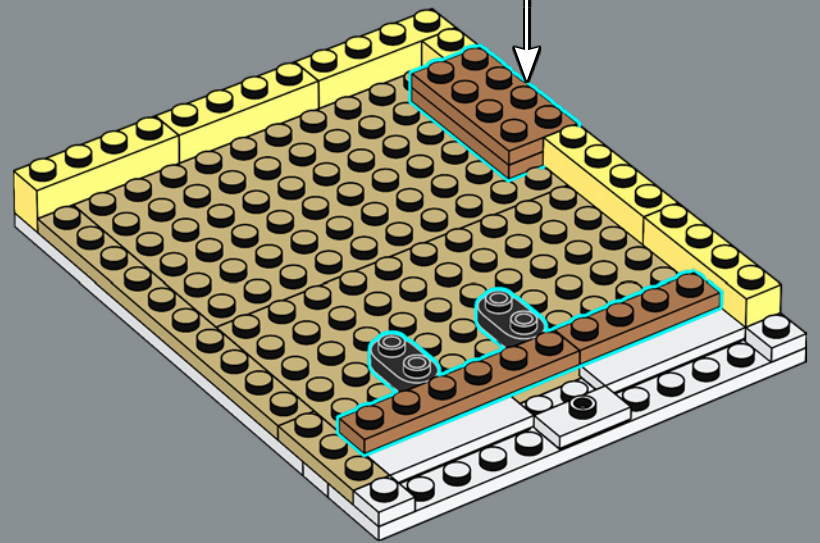
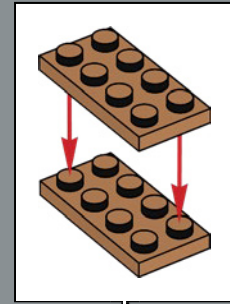

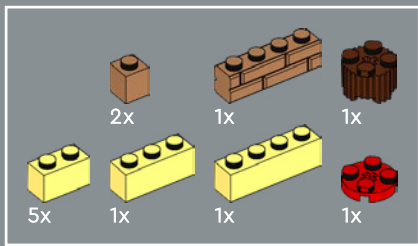

229

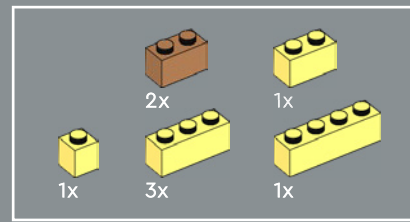
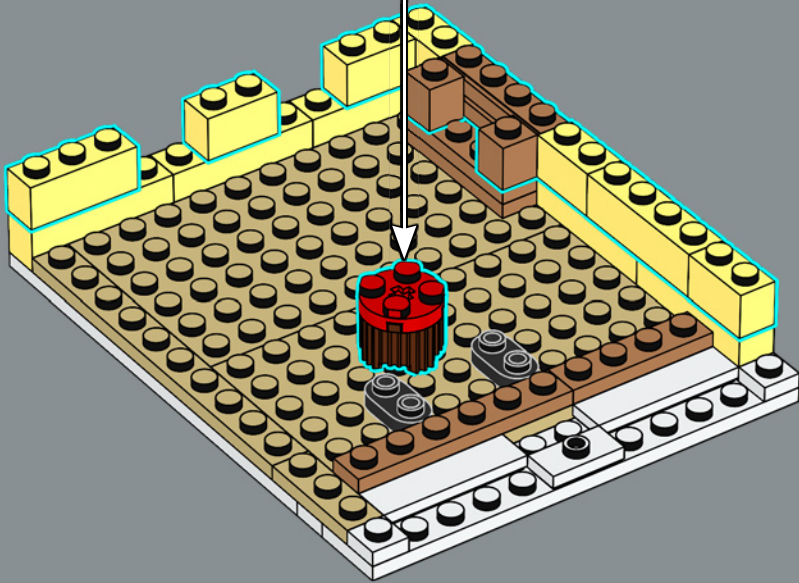
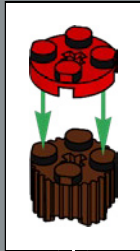

230

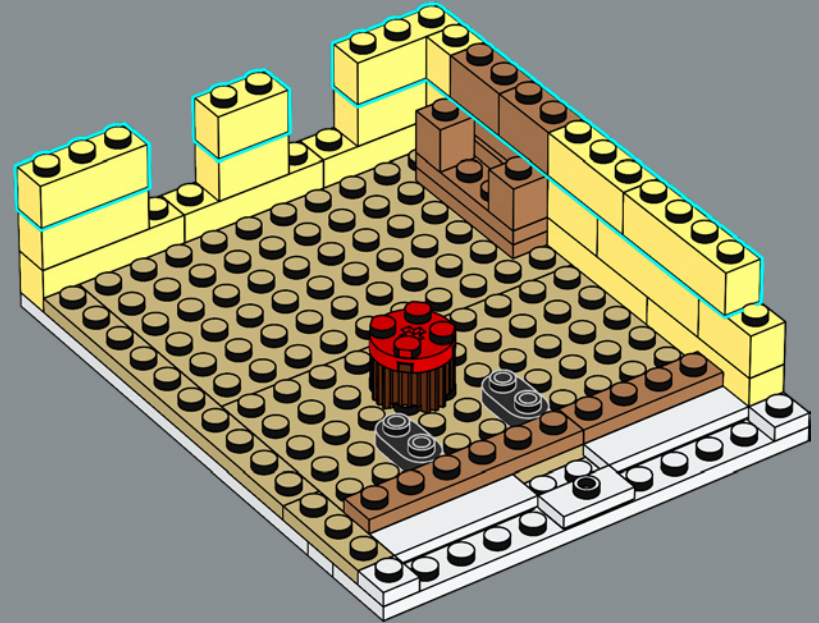



231

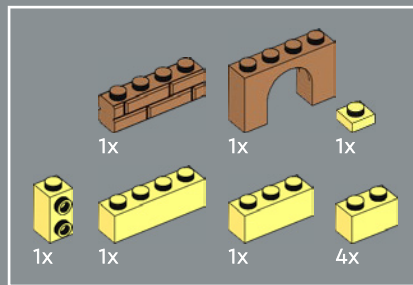
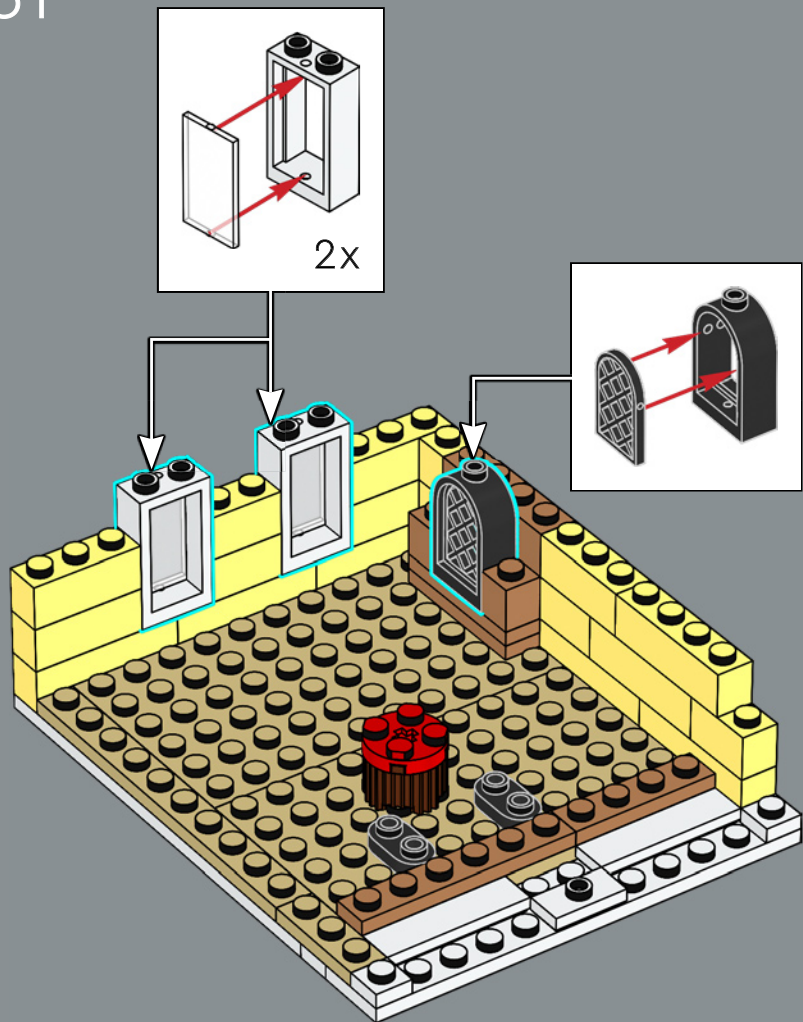

232

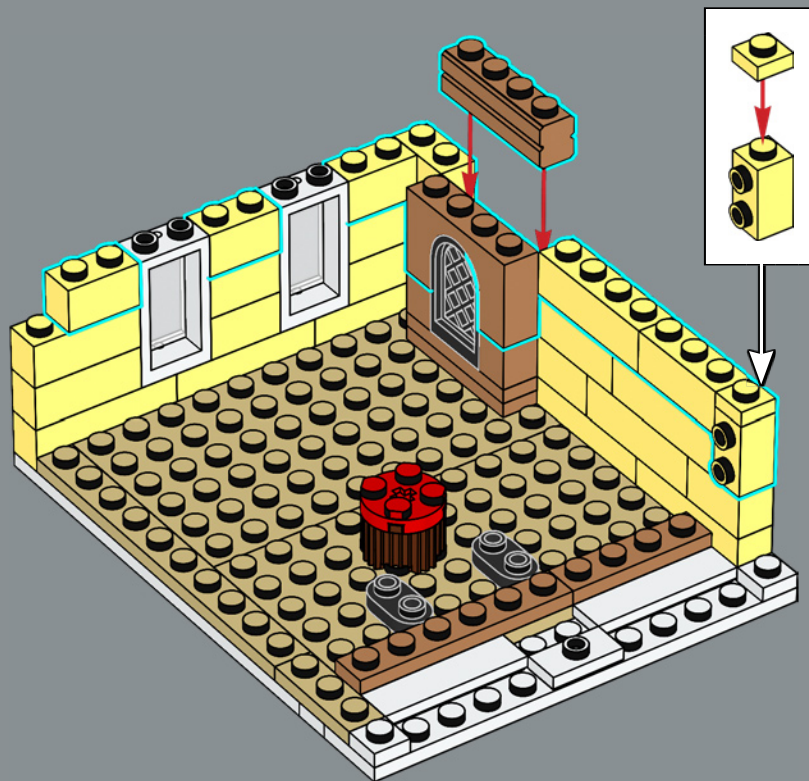

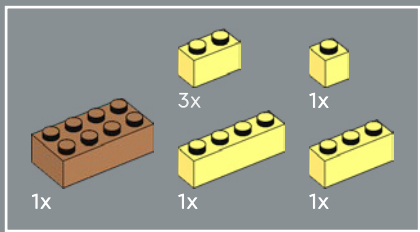

233

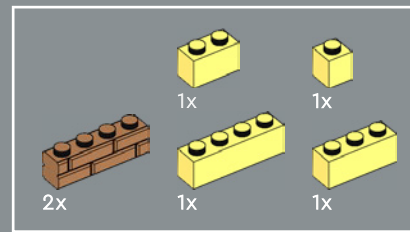
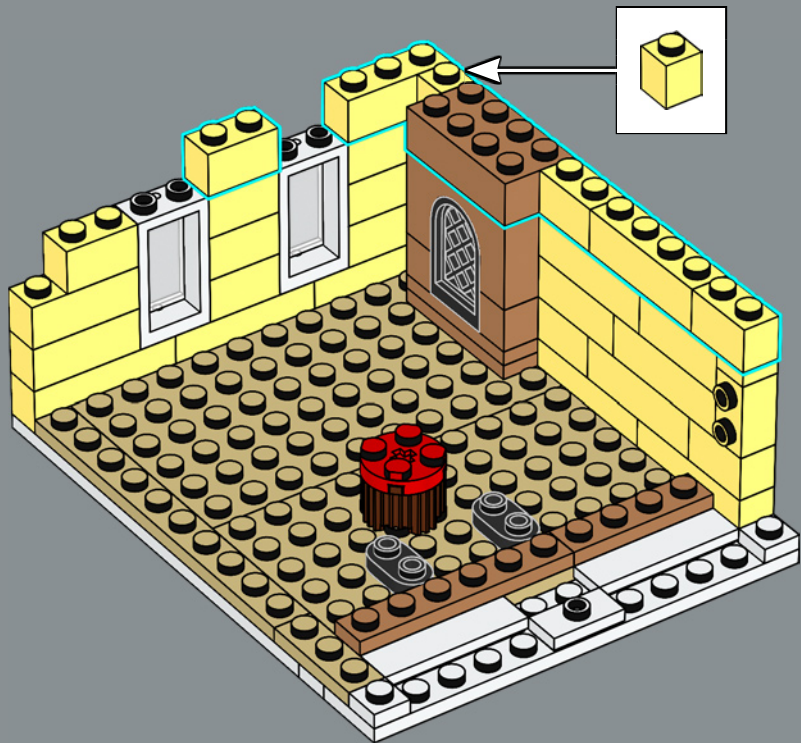

234

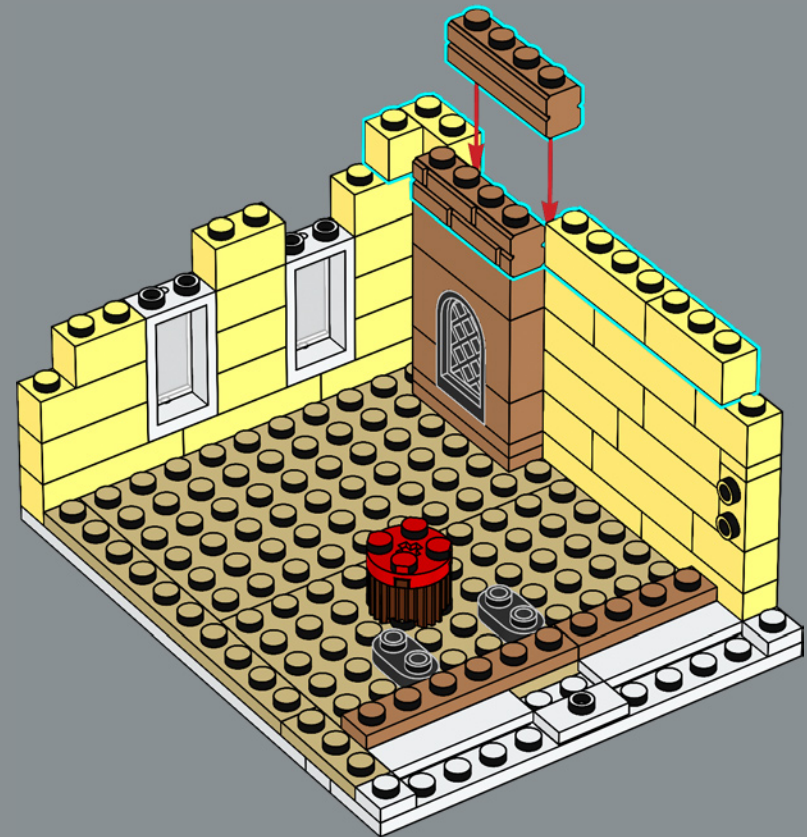

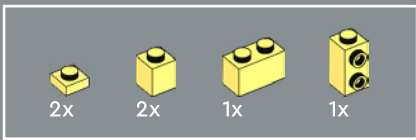

235

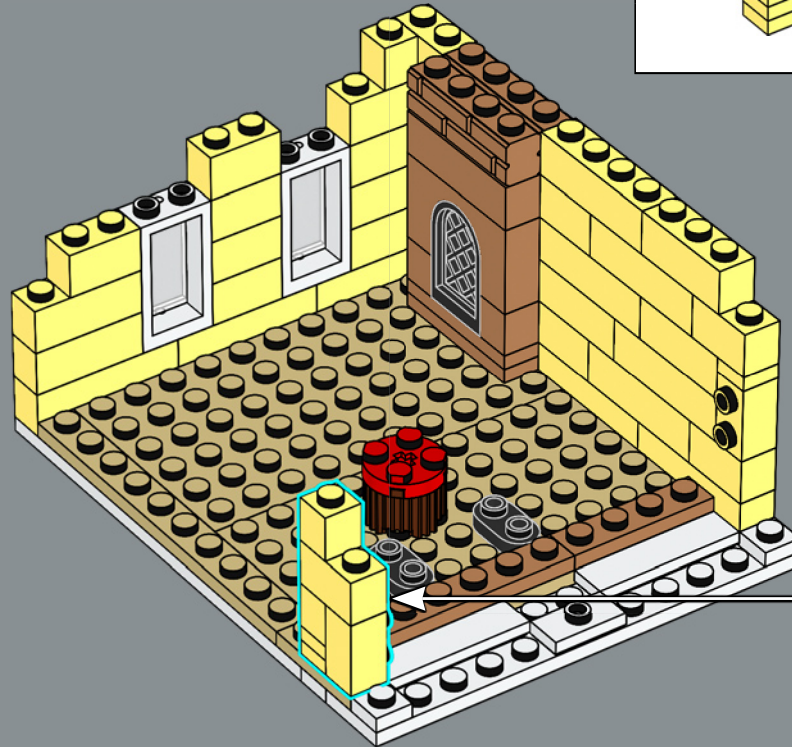
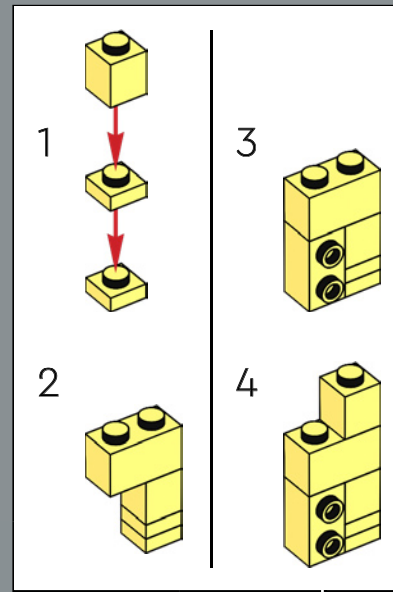

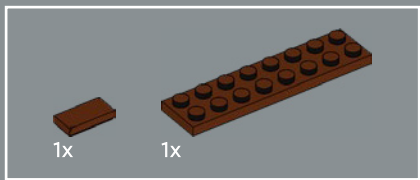

236

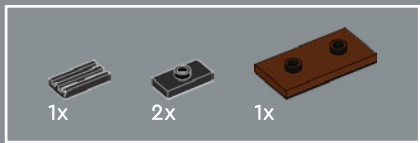
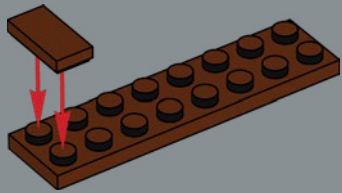

237

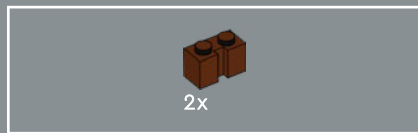
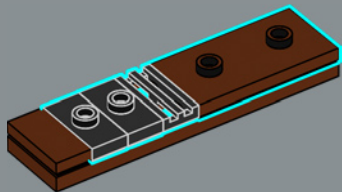

238

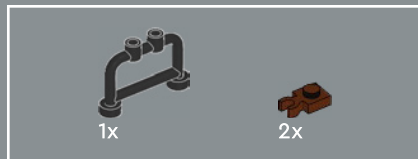
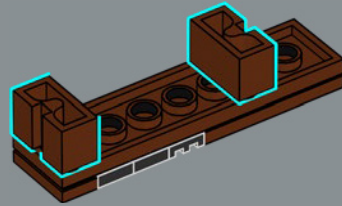

239

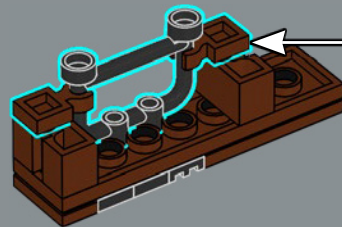
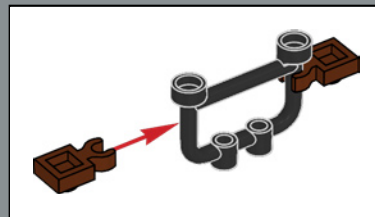

240

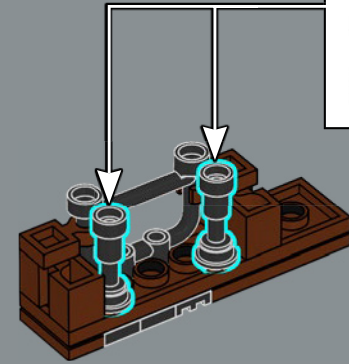
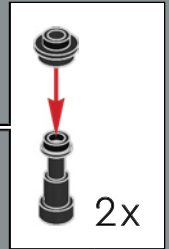

241

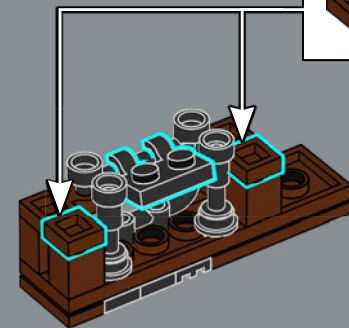



242

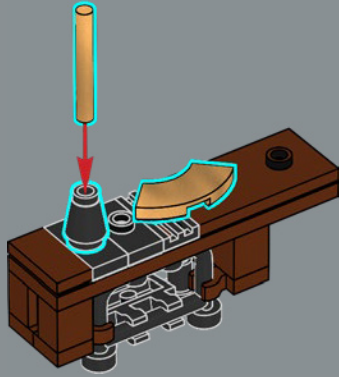

243

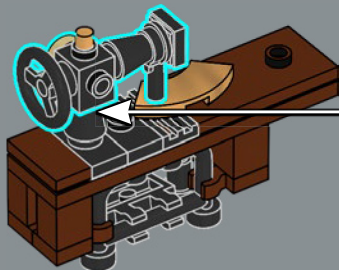
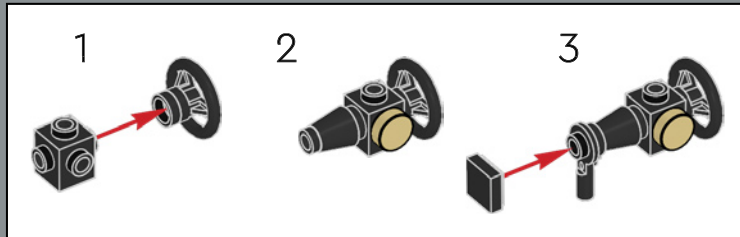

The tailor has just finished the singer's gown; golden thread and fabric are still left on the sewing machine!

244

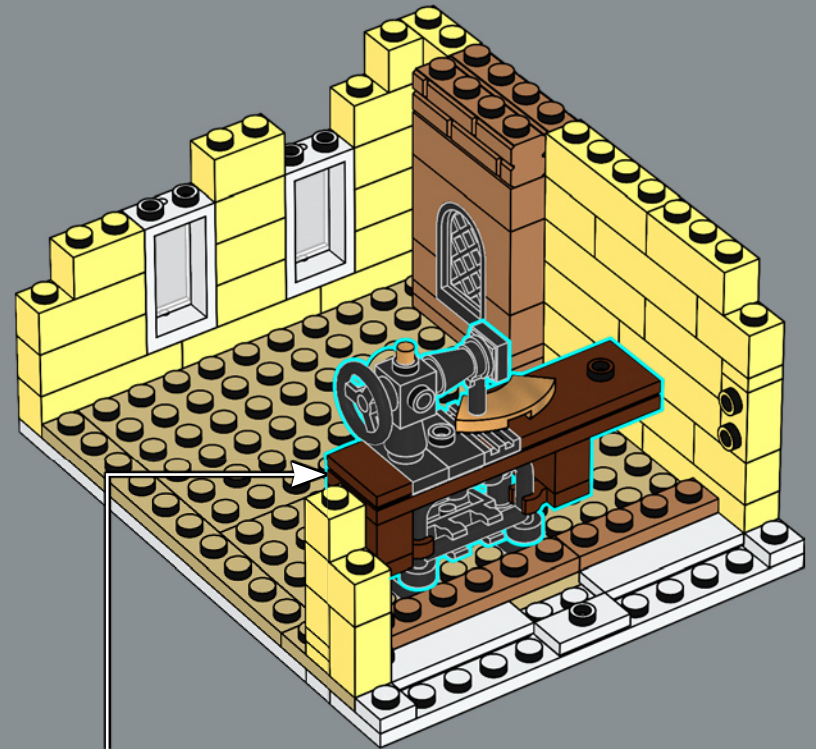

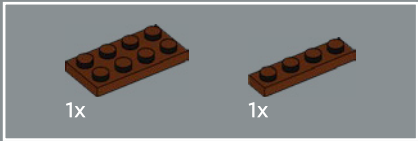

245

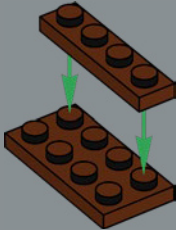

246

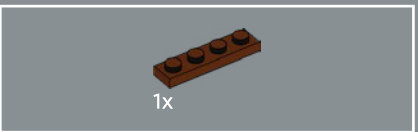
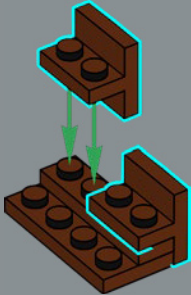

247

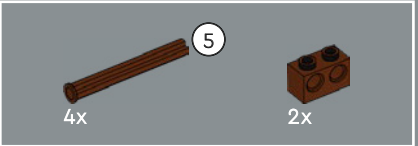
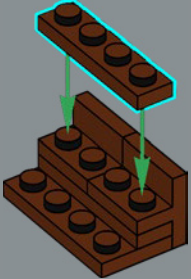

248

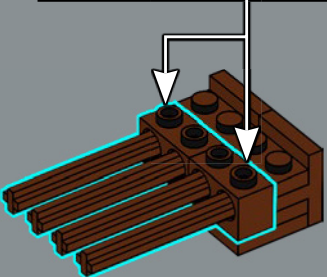
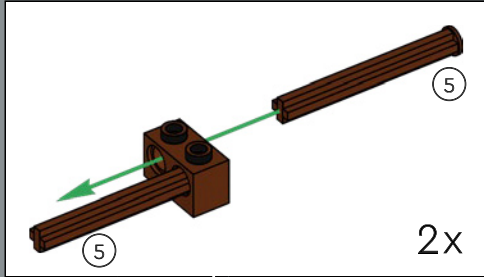

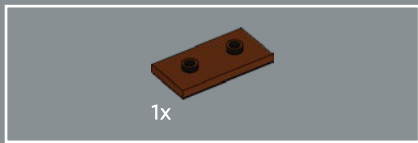

249

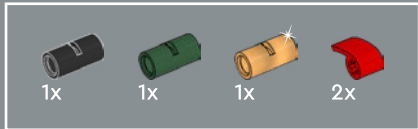
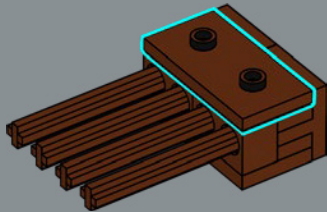

250

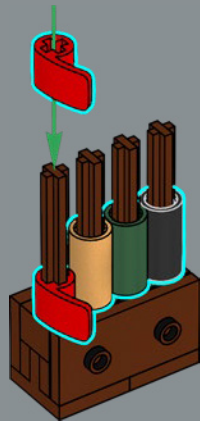

The elements making up the red cloth first appeared as elements in LEGO® Technic sets.

251

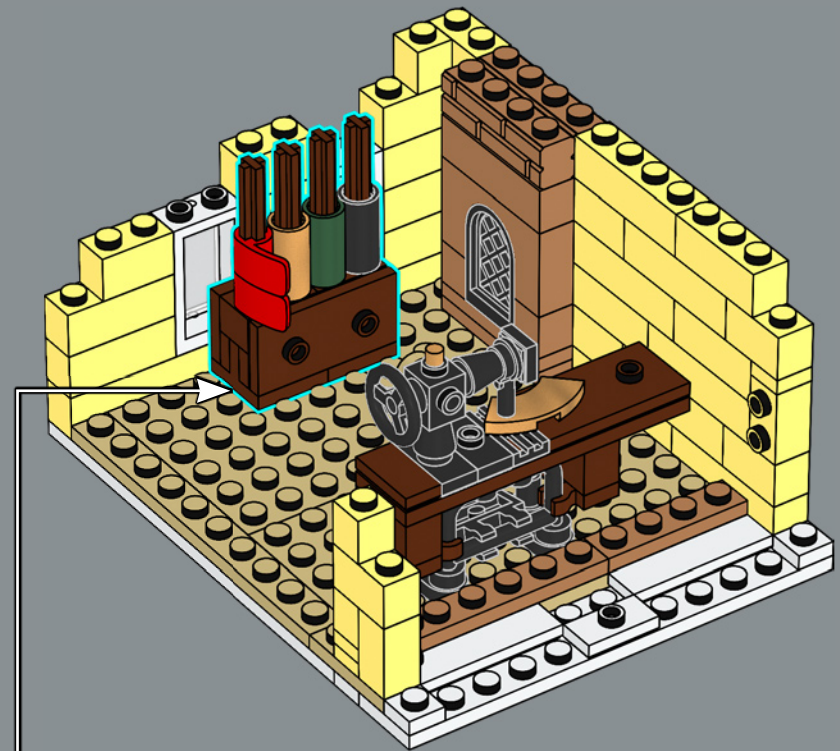



252

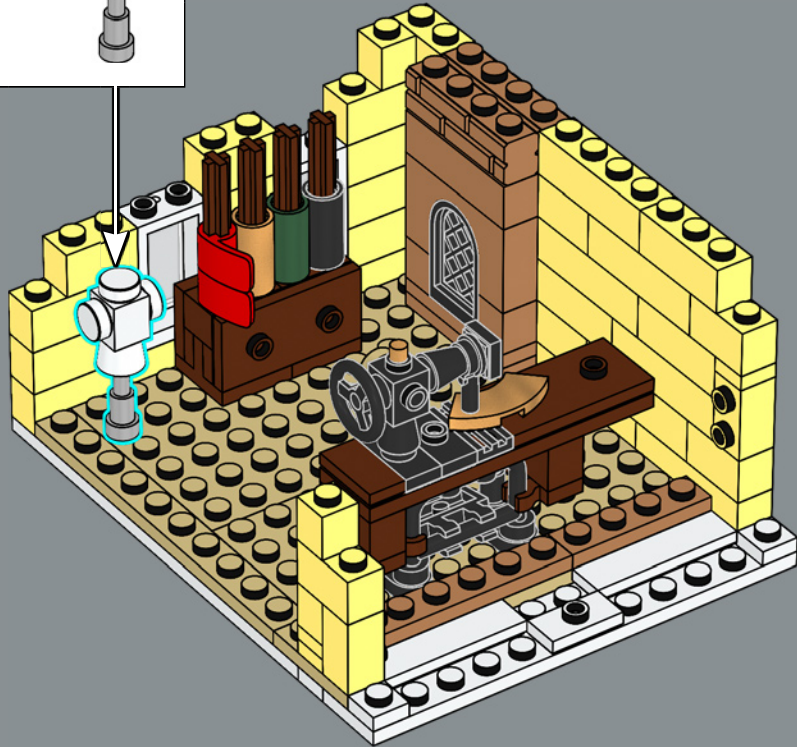
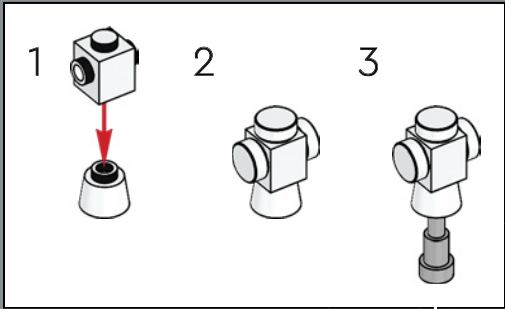

253

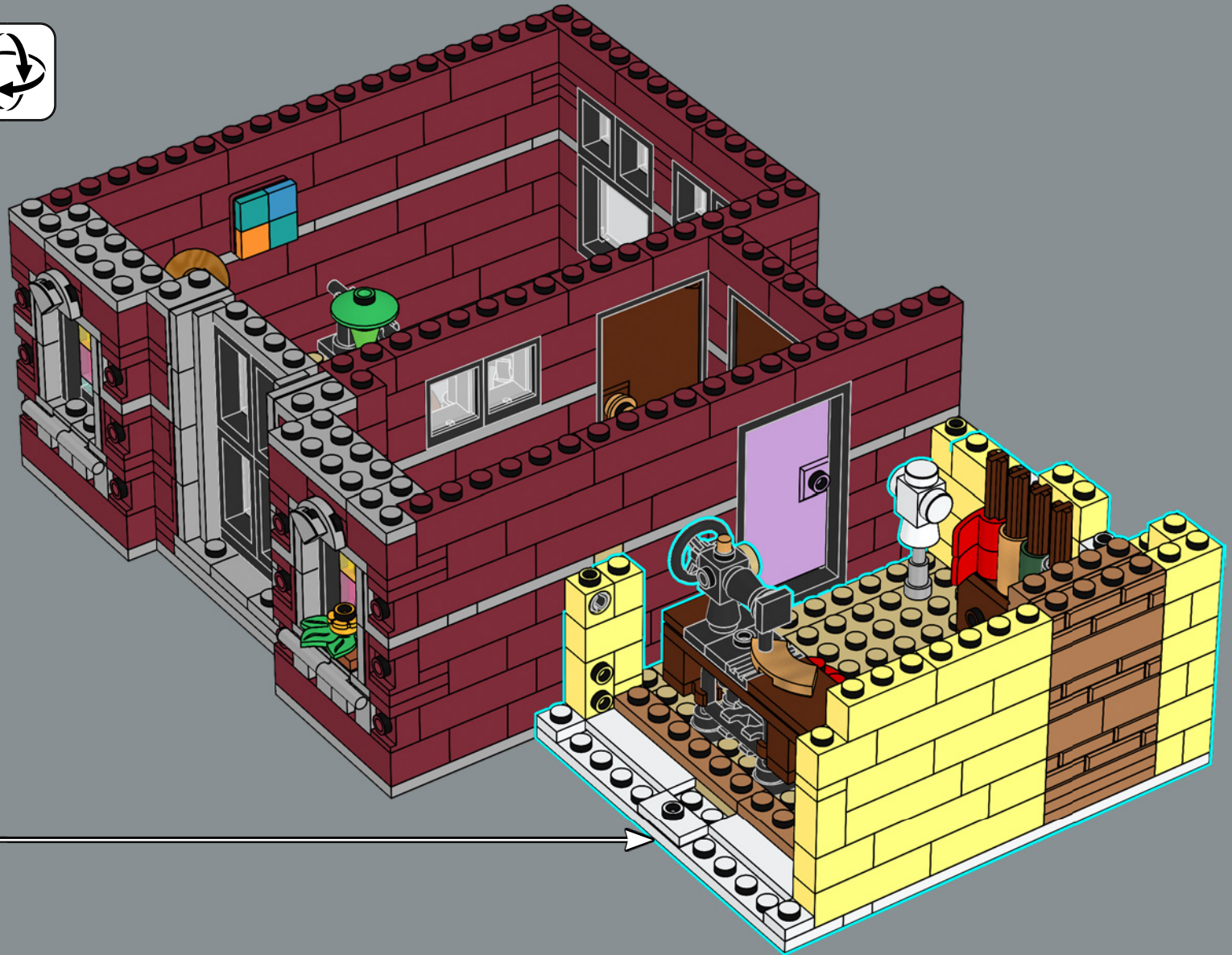

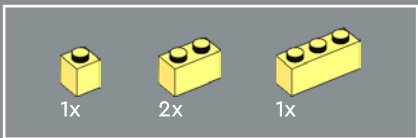

254

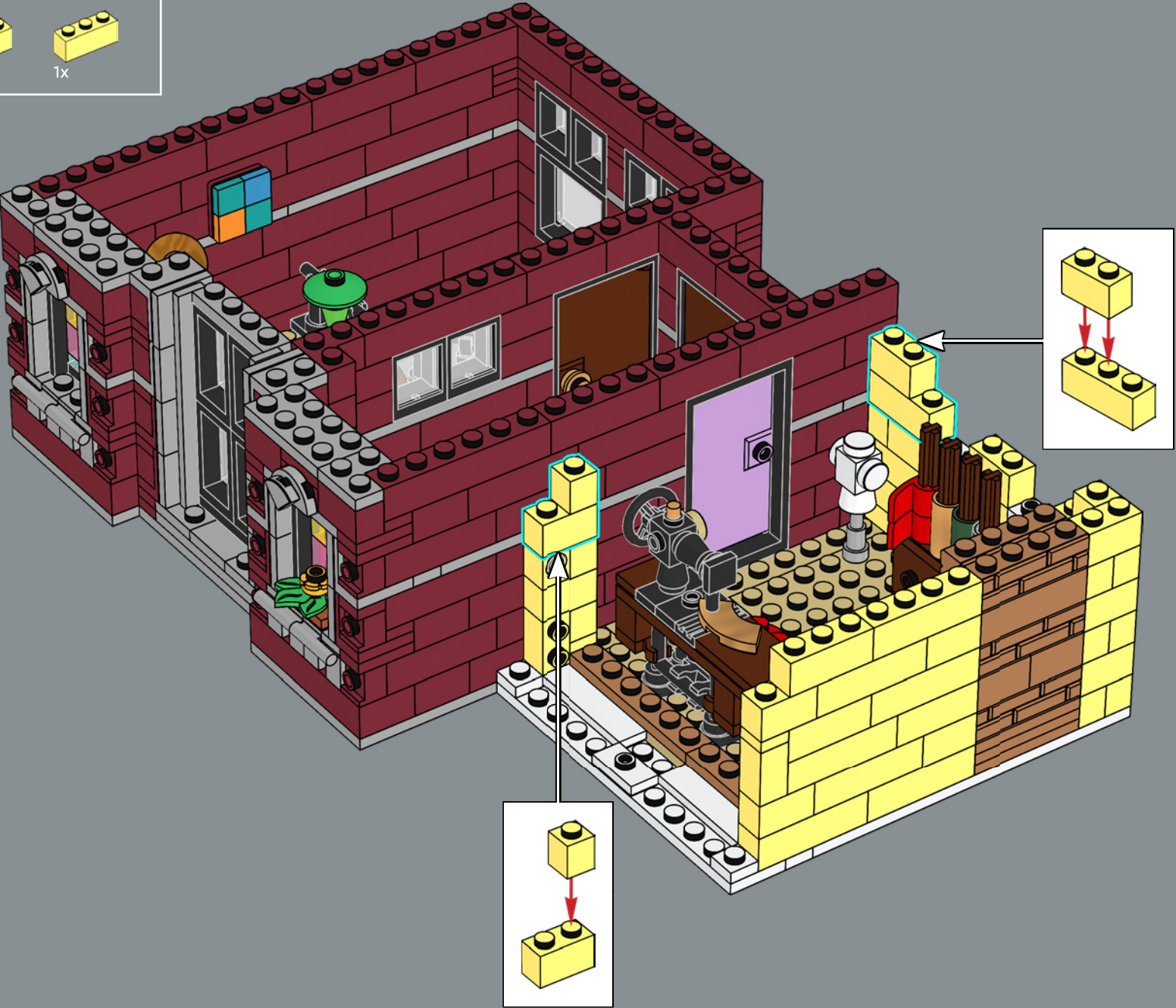

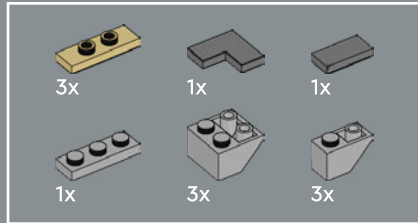

255

1

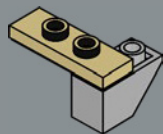

2

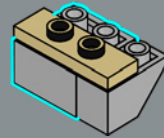

3

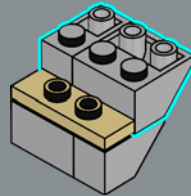

4

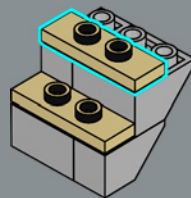

5

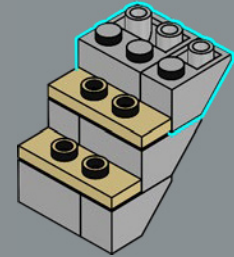

6

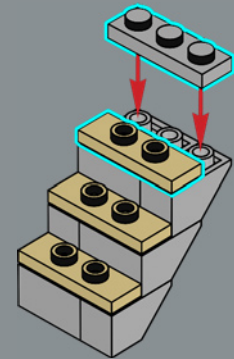

7

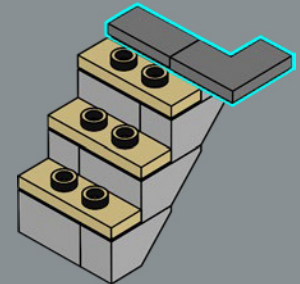





12x

256

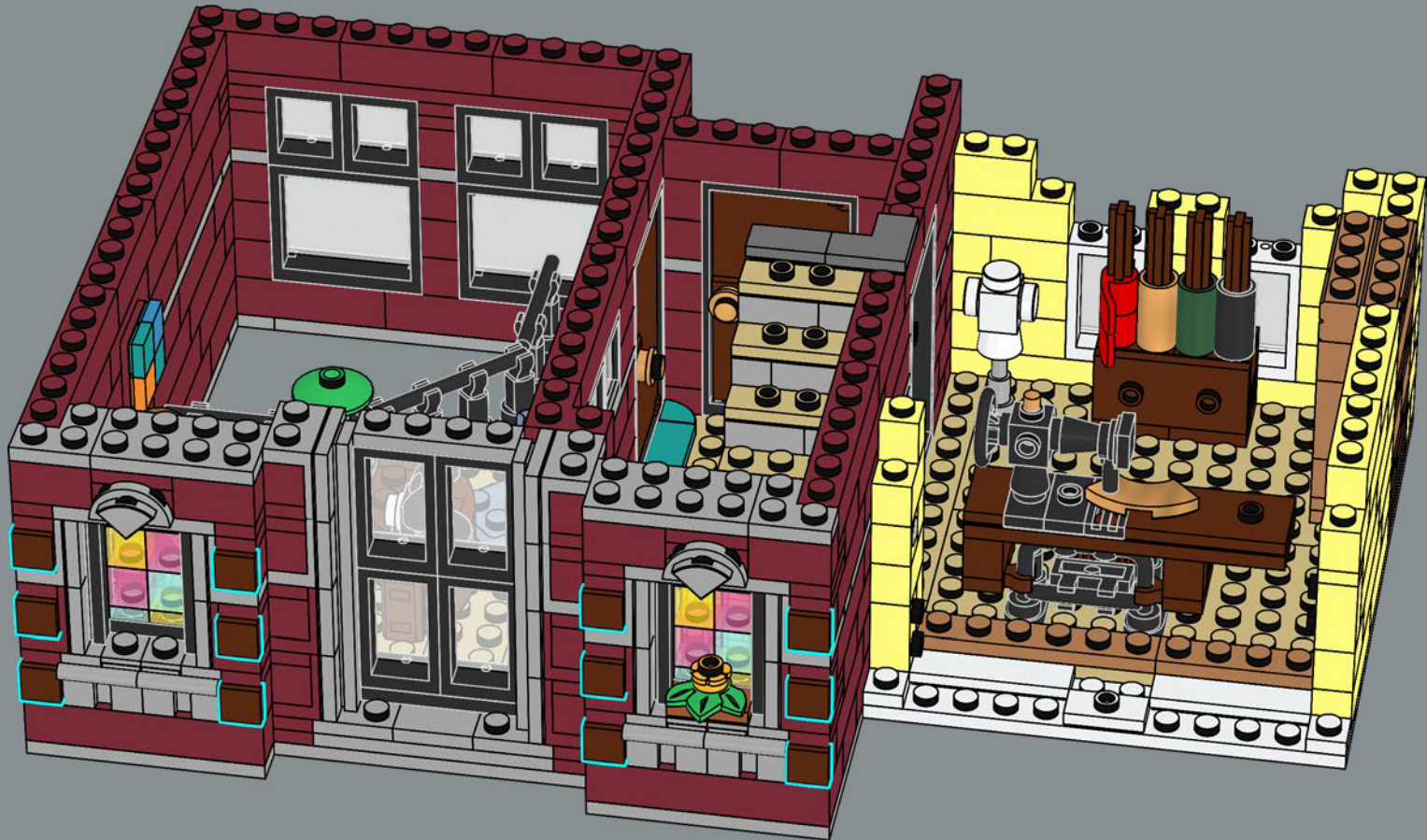

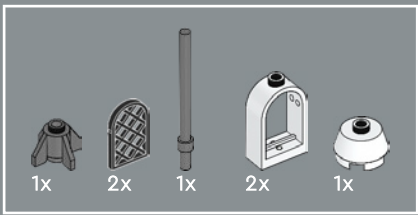

257

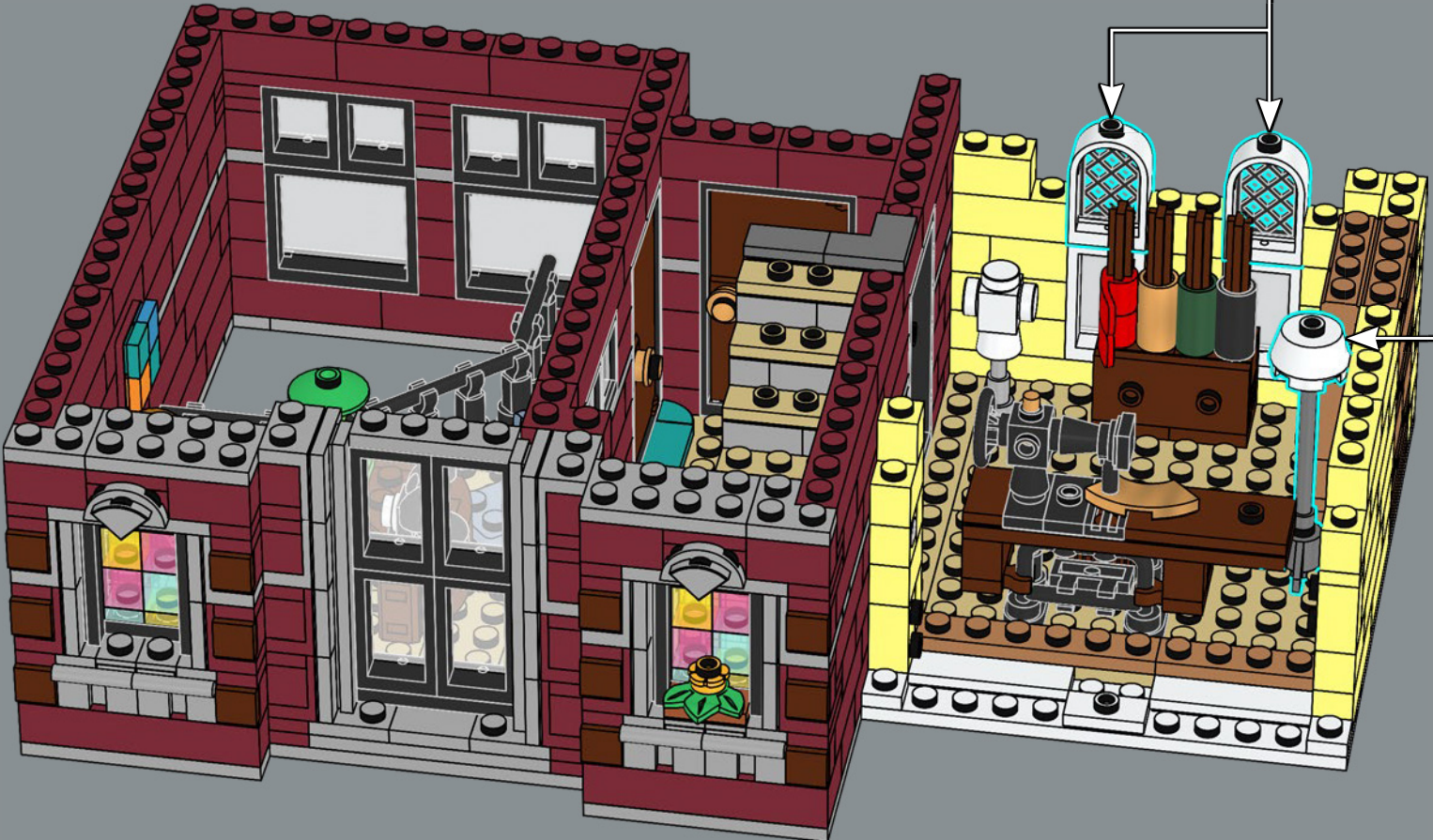
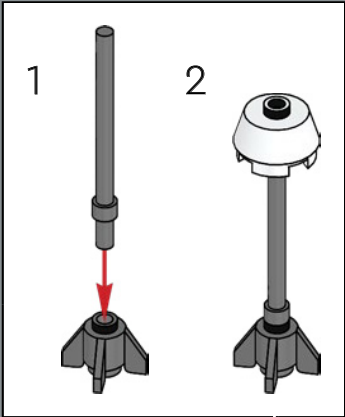
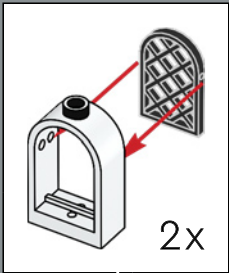

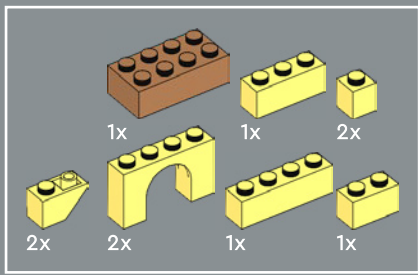

258

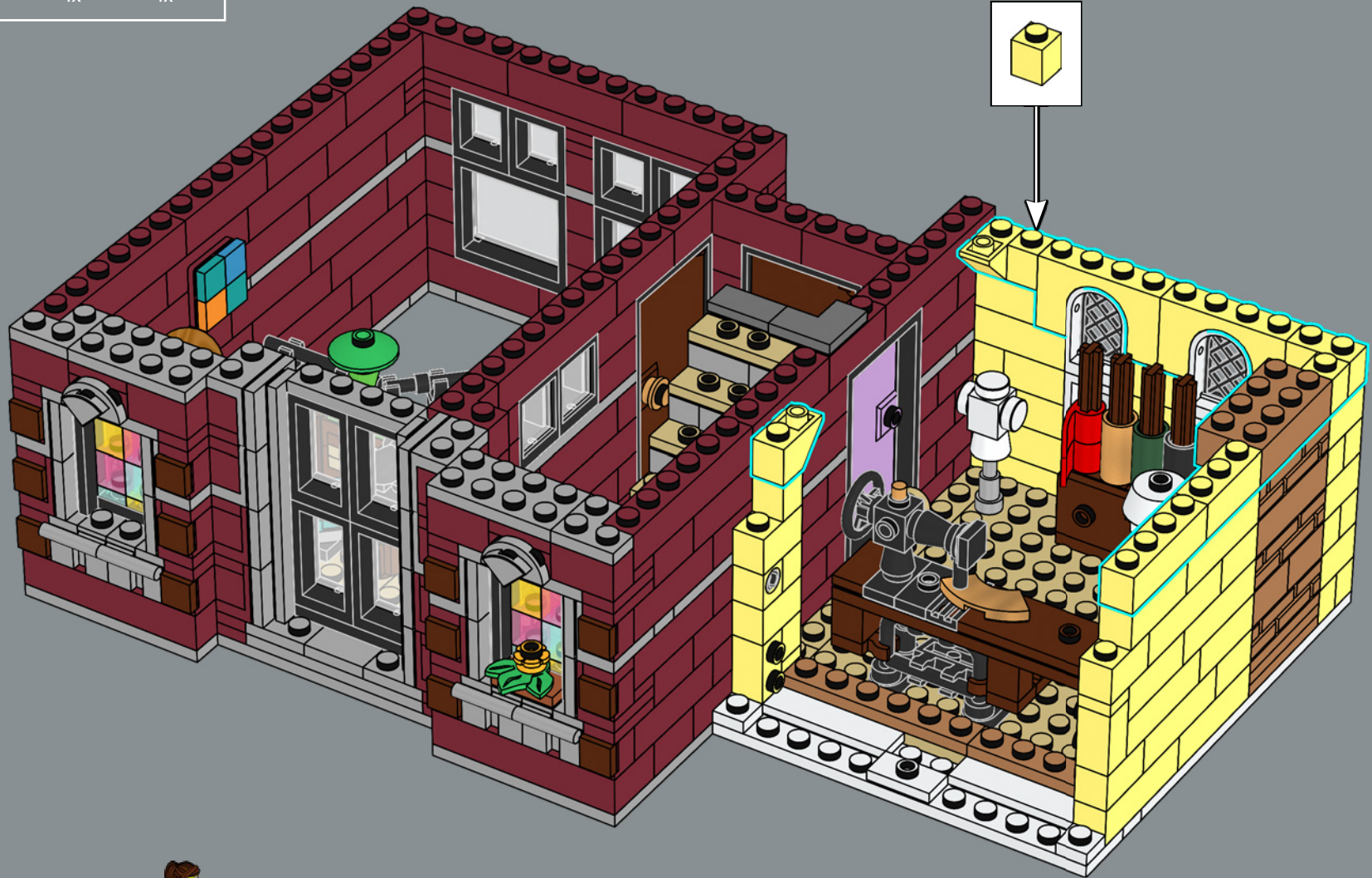



259

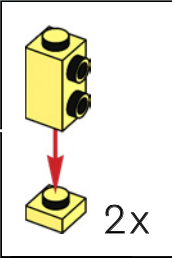
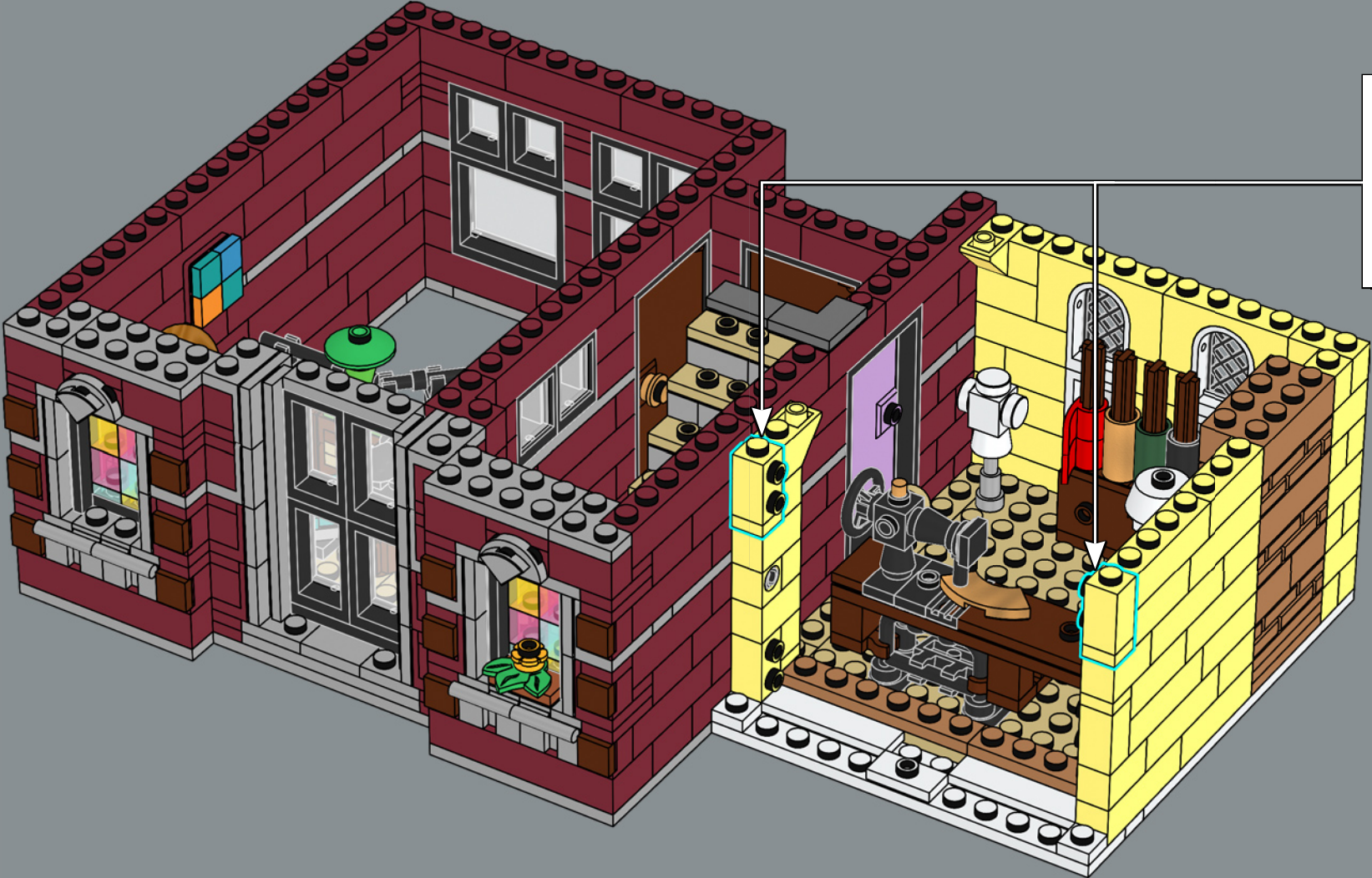

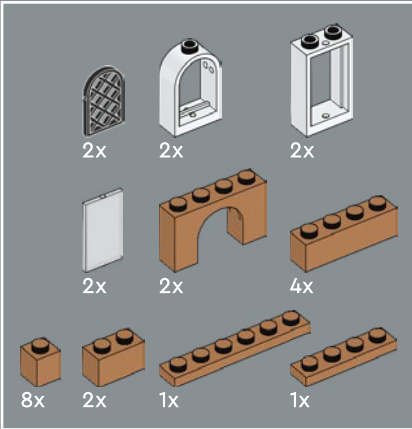
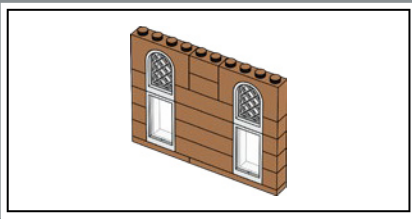

260

1

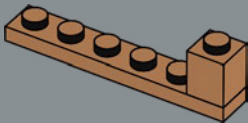

2

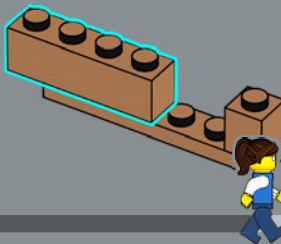

3

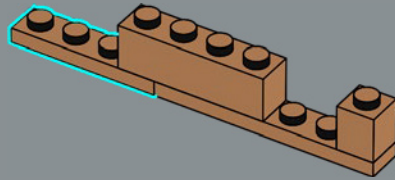

4

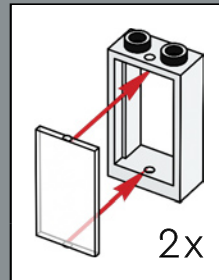
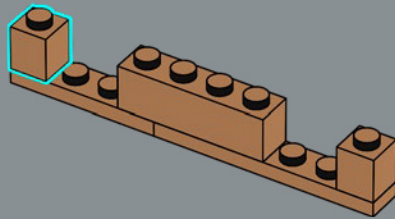

5

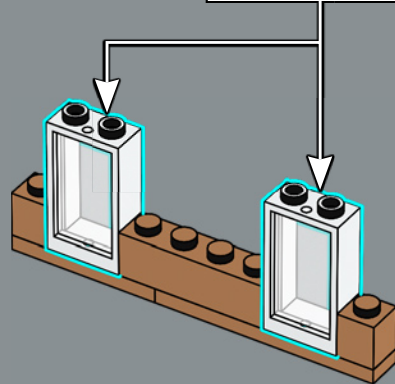

6

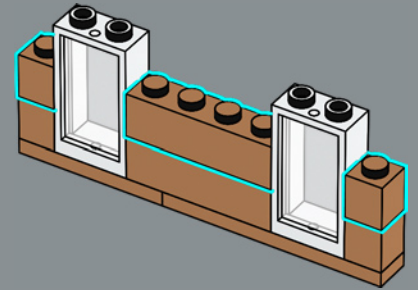

7

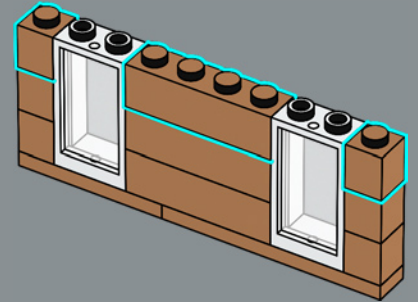

8

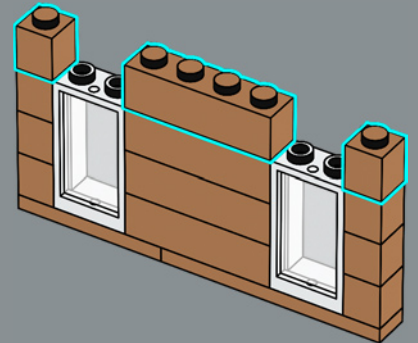

9

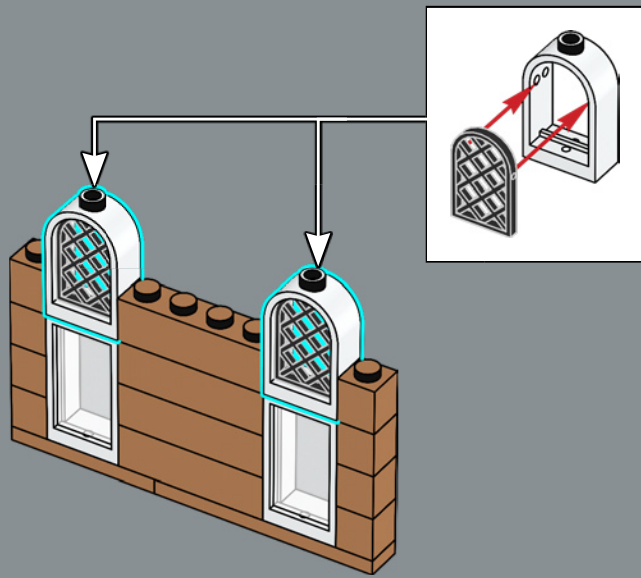

10

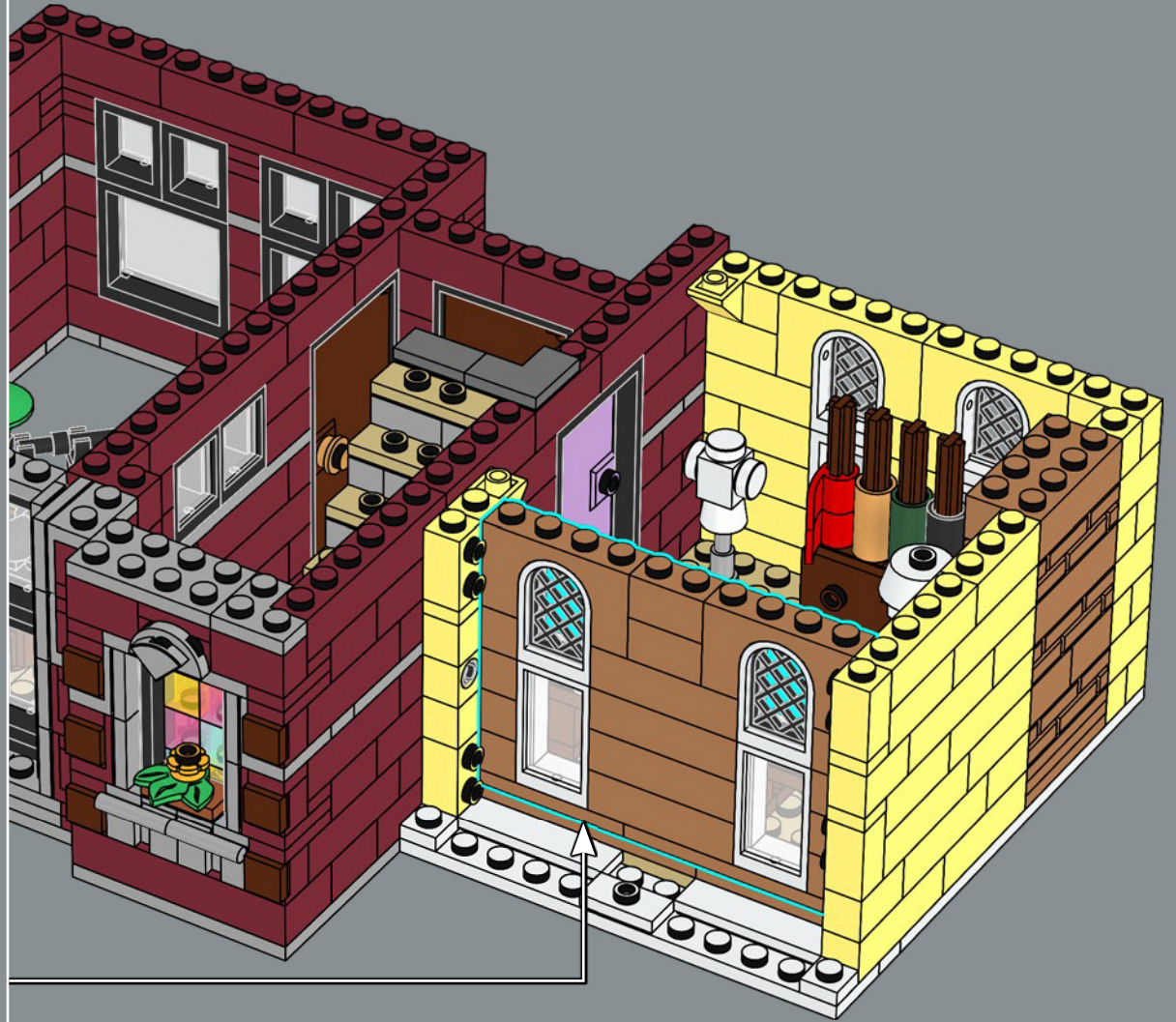
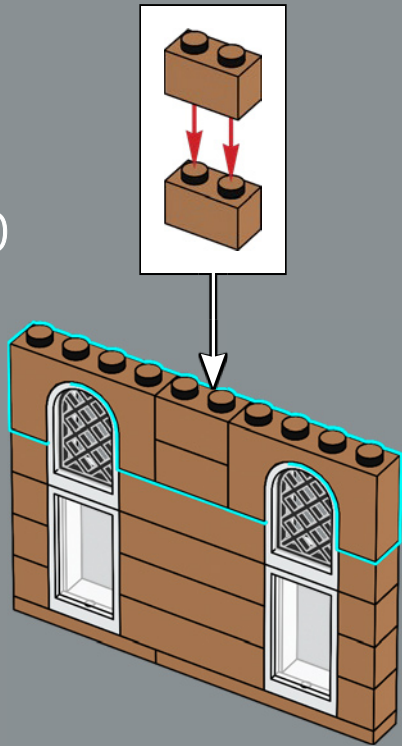

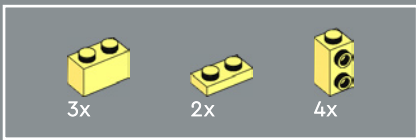

261

1

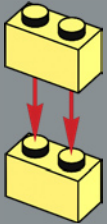

2

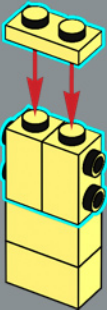

3

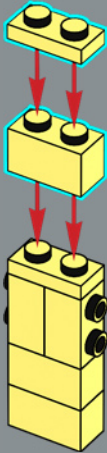

4

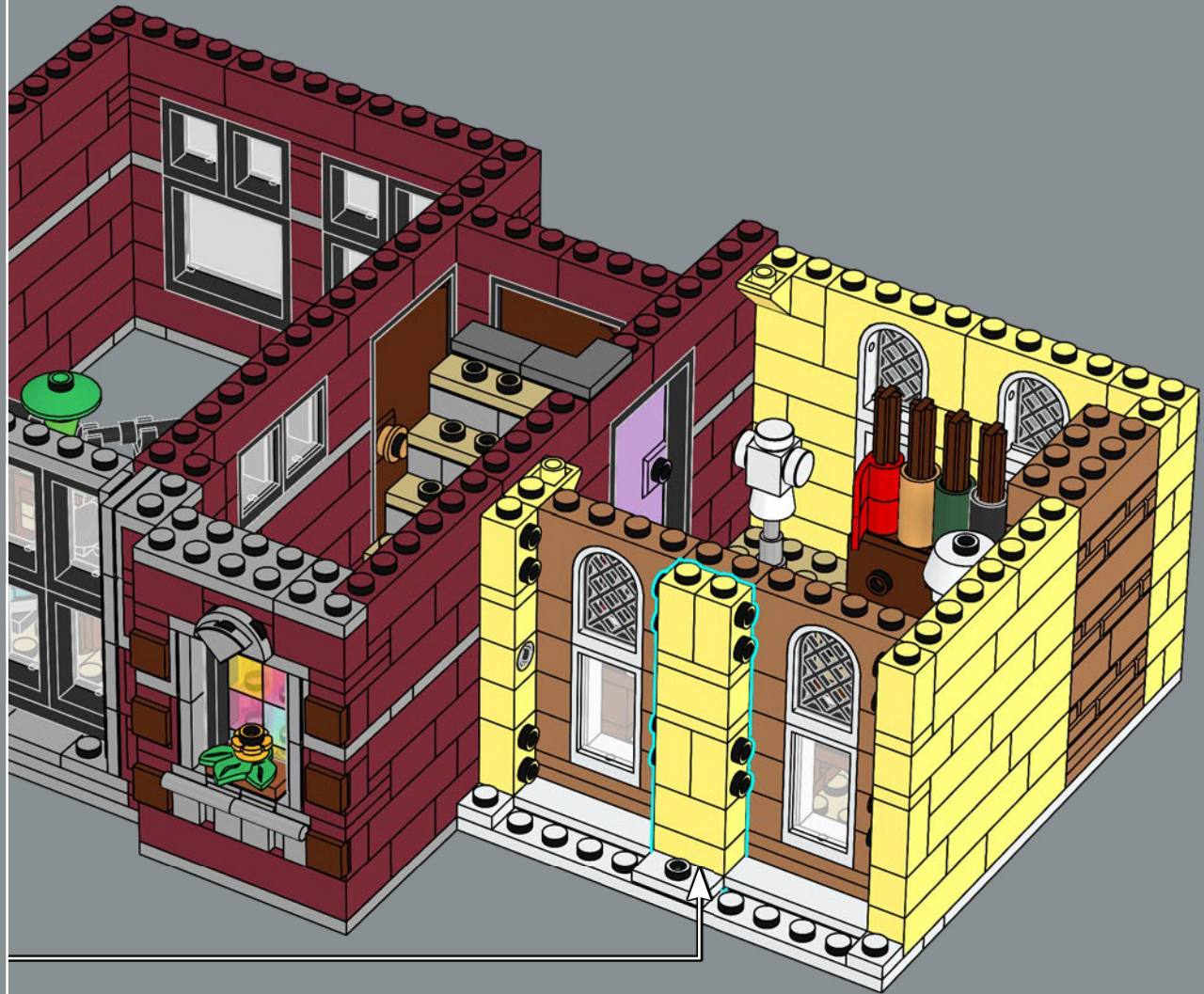
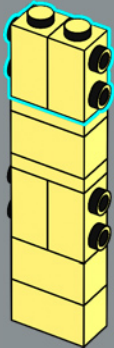

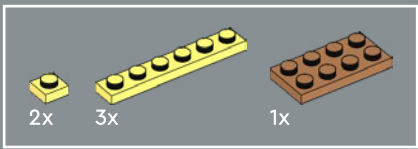

262



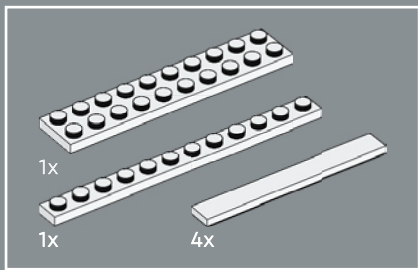

263



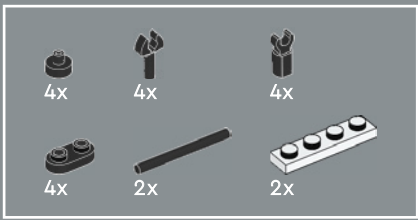

264

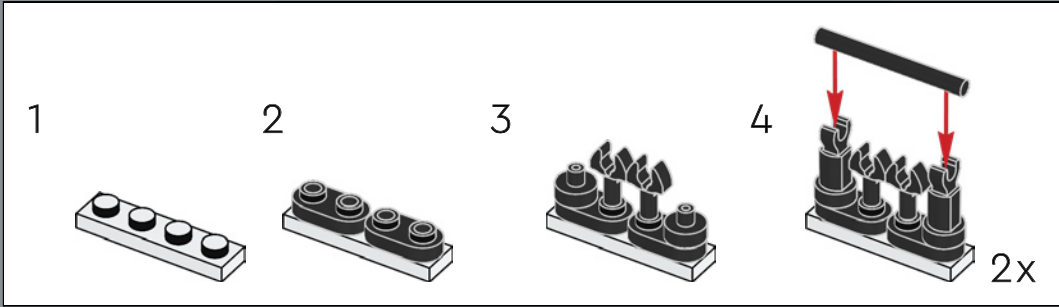

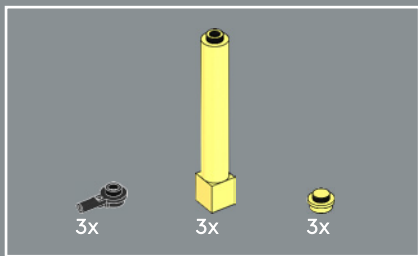

265

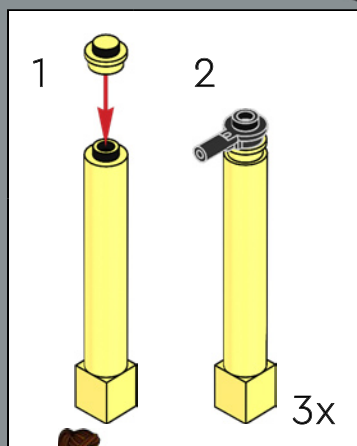
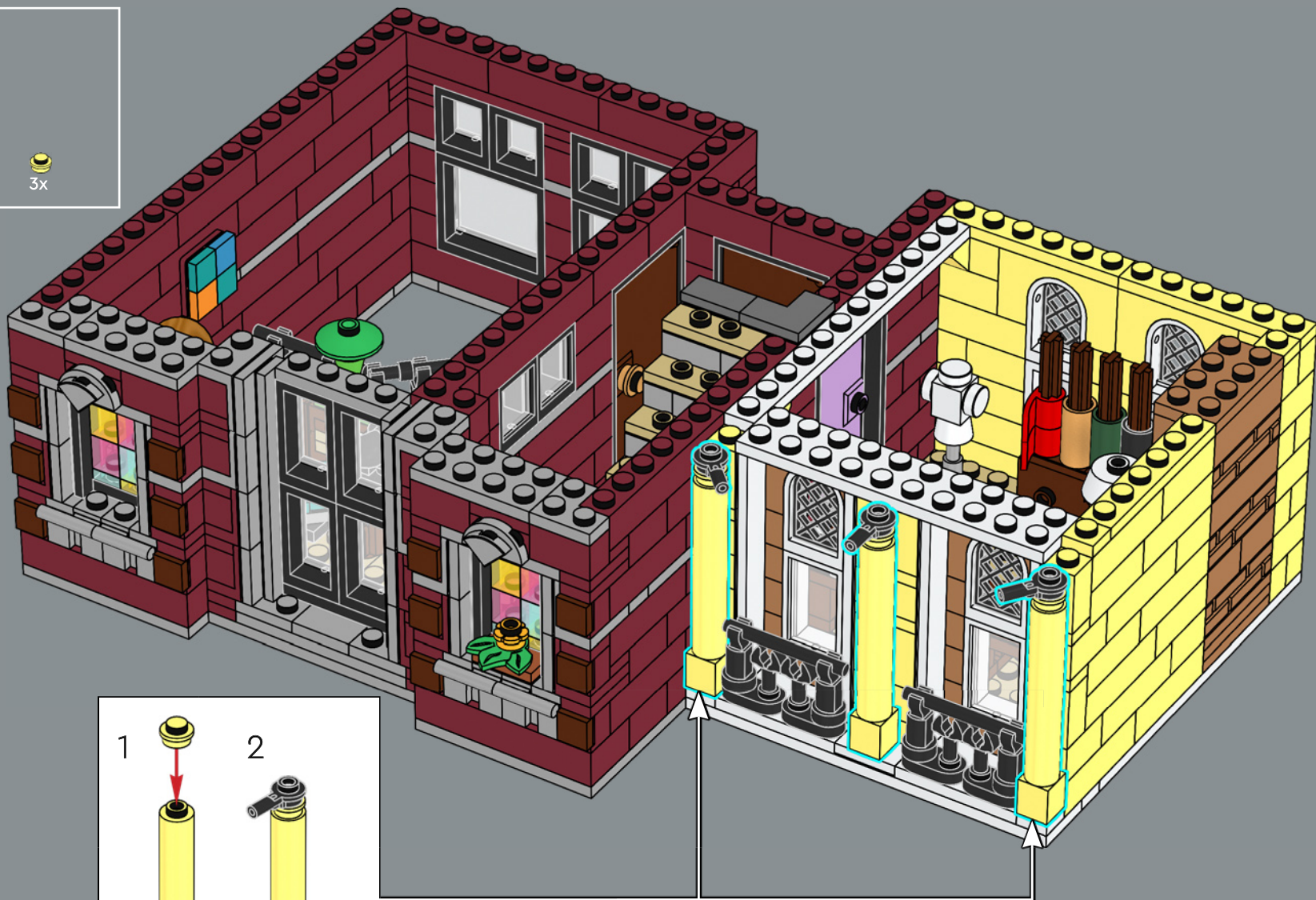



3x

266

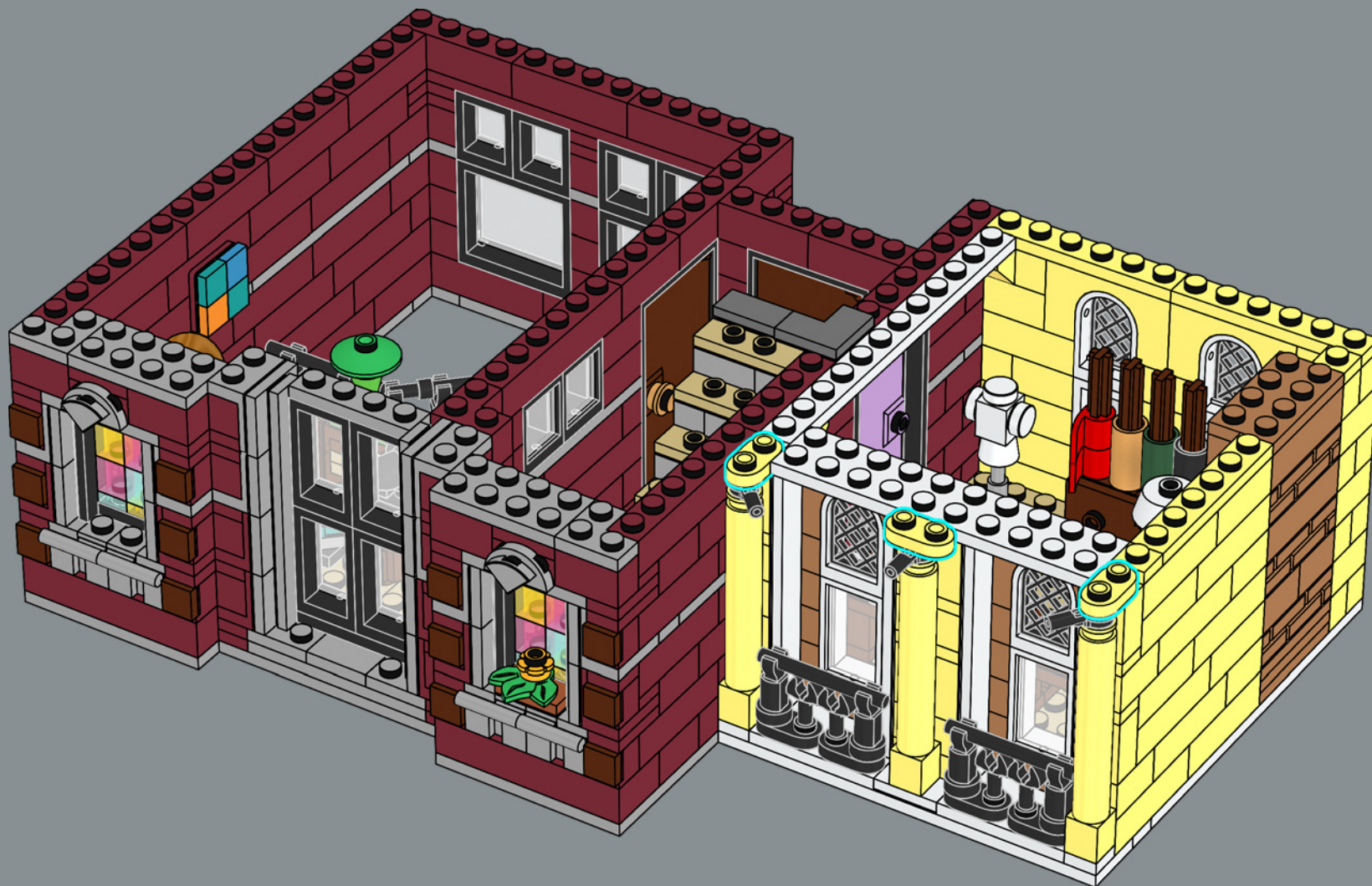

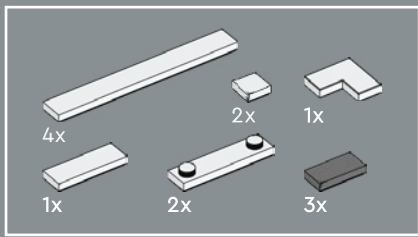

267

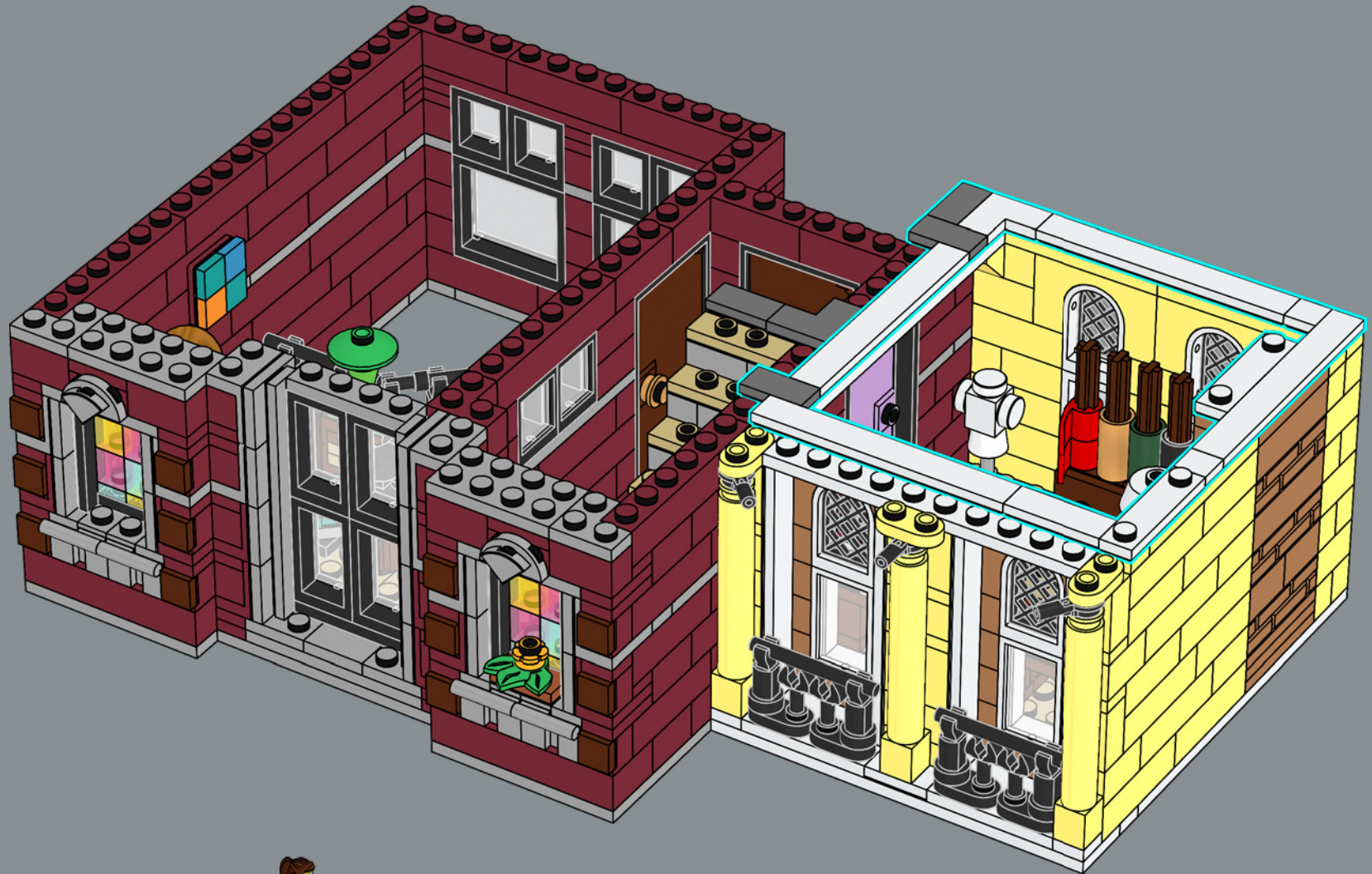

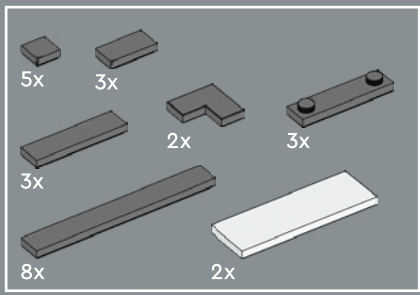

268

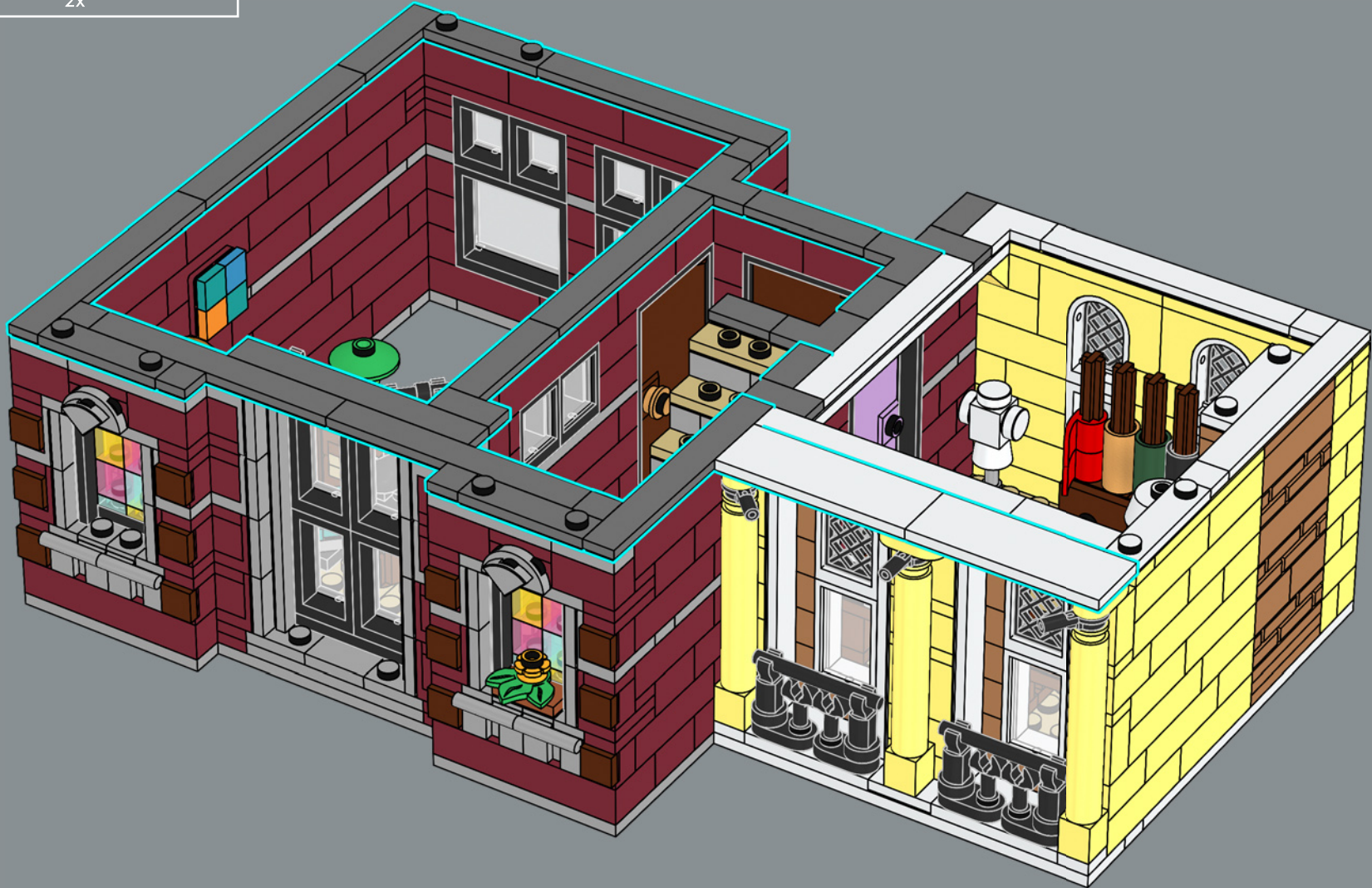



269



Lavender hanging flowers, a lavender sign, lavender doors... if you need to visit the tailor, just follow the lavender!

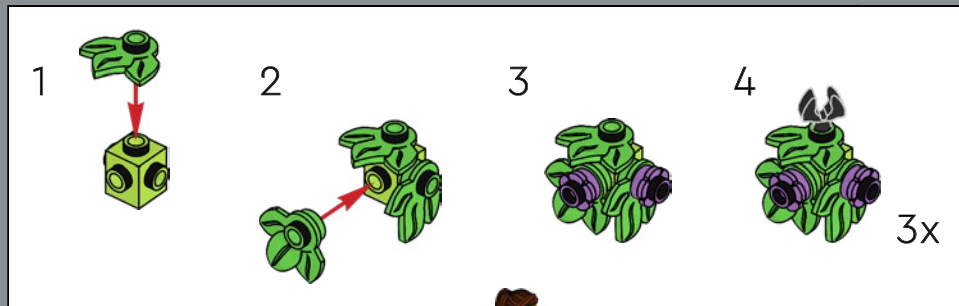

270





The singer is nearly ready for tonight's show. She has picked up her dress from the tailor, had a bite to eat at the Pizzeria, checked in with the manager and now she is warming up in the dressing room.

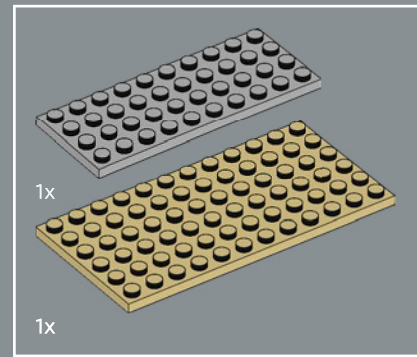

271

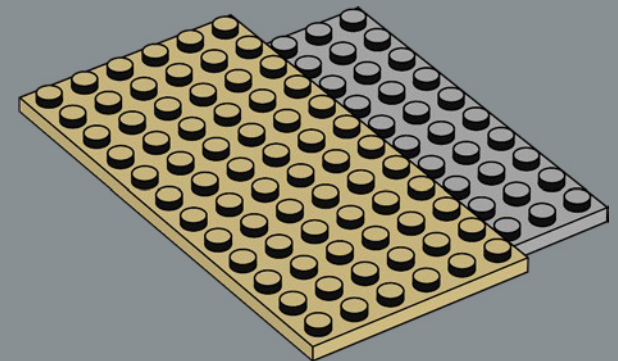
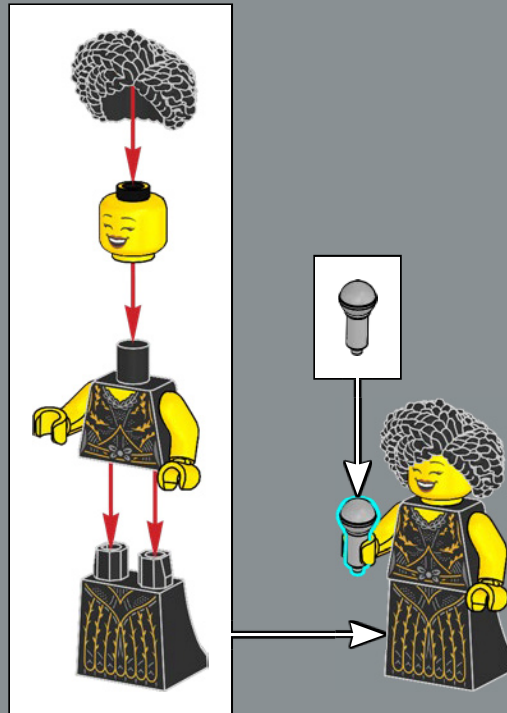
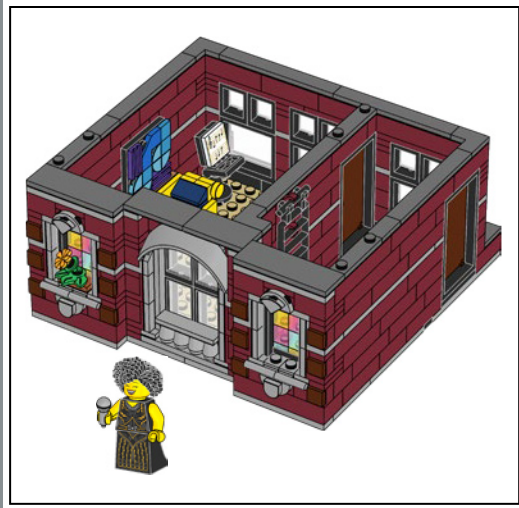

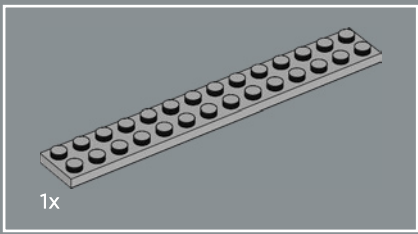

272

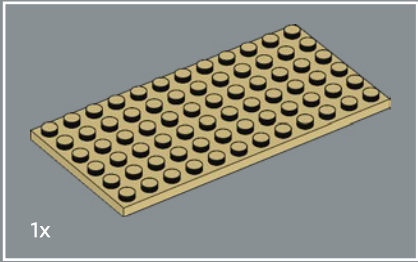
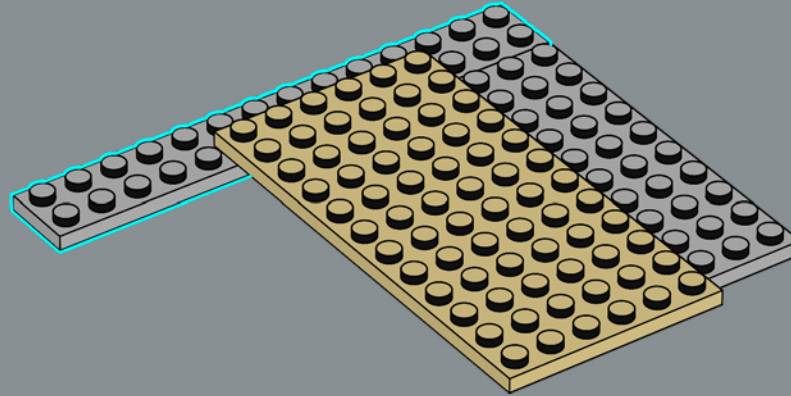

273

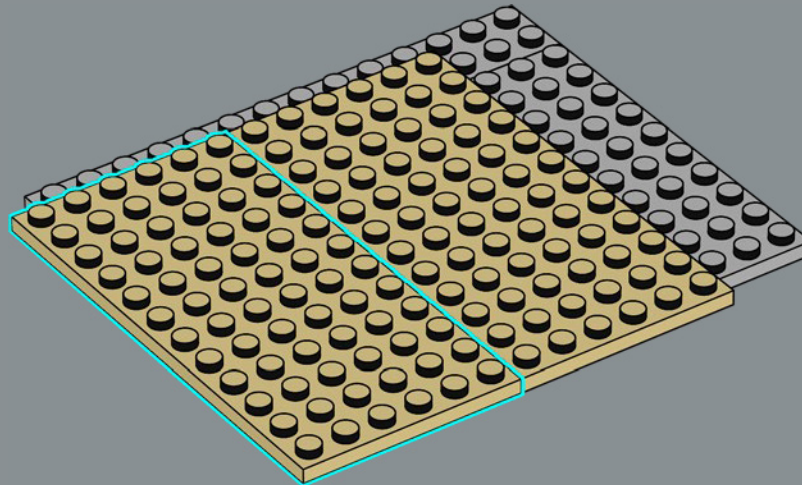

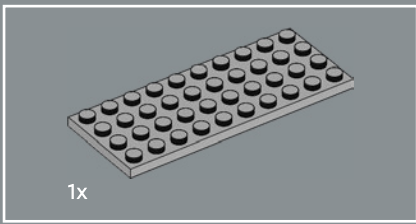

274

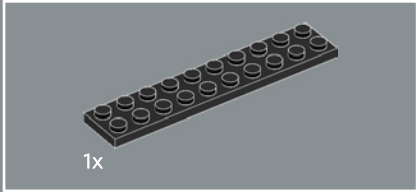
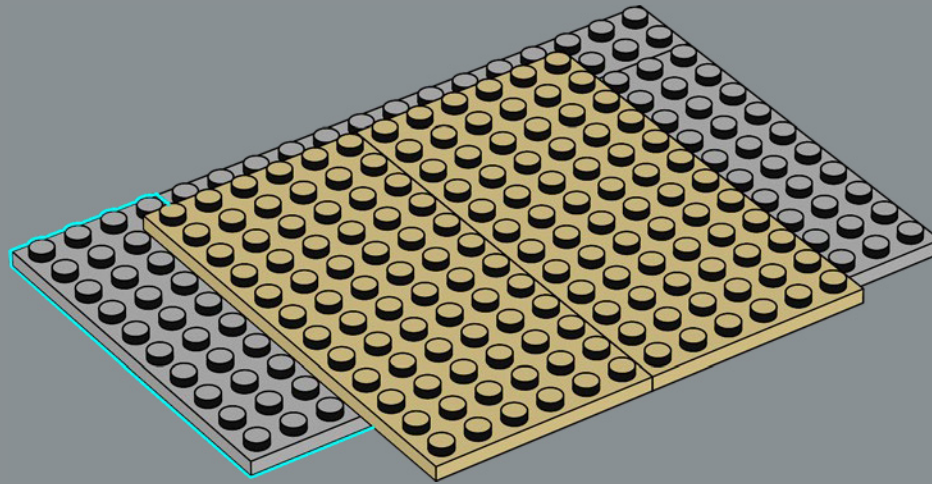

275

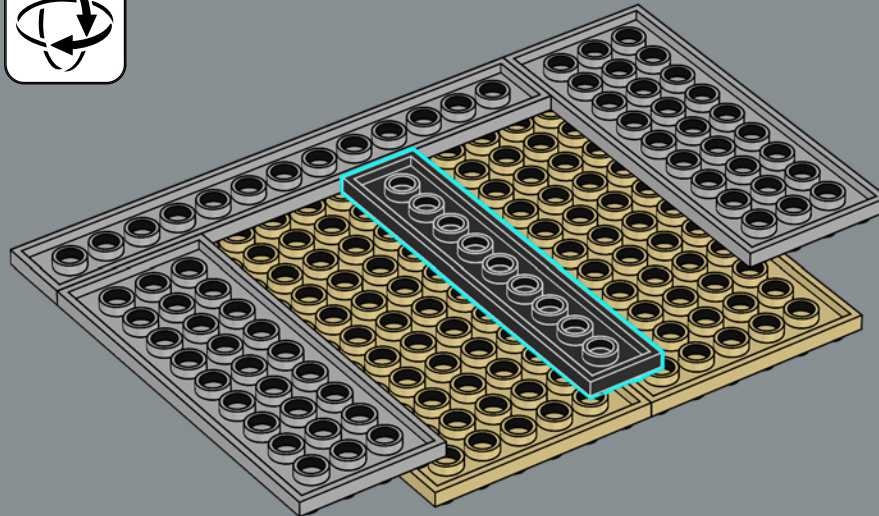

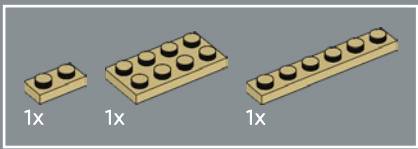

276

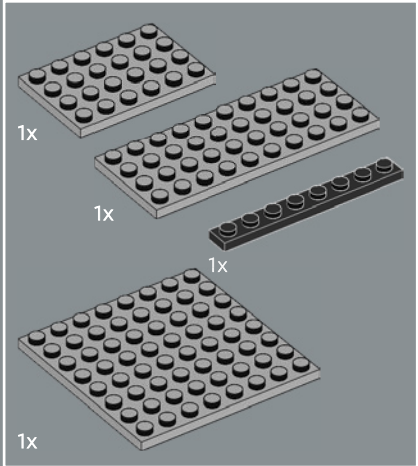
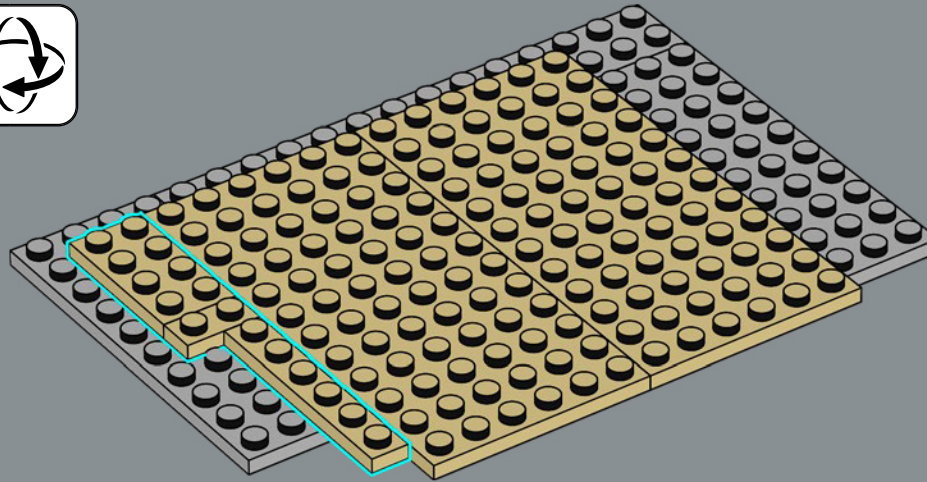

277

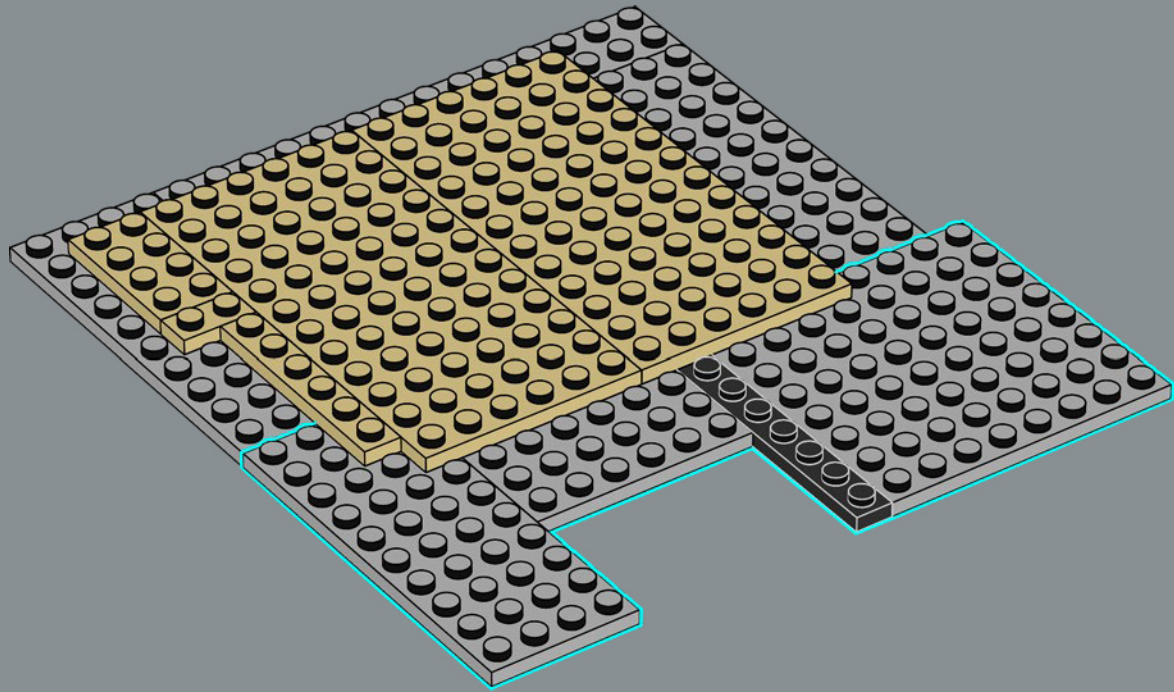

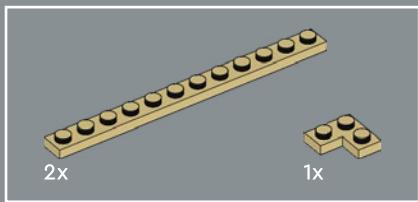

278

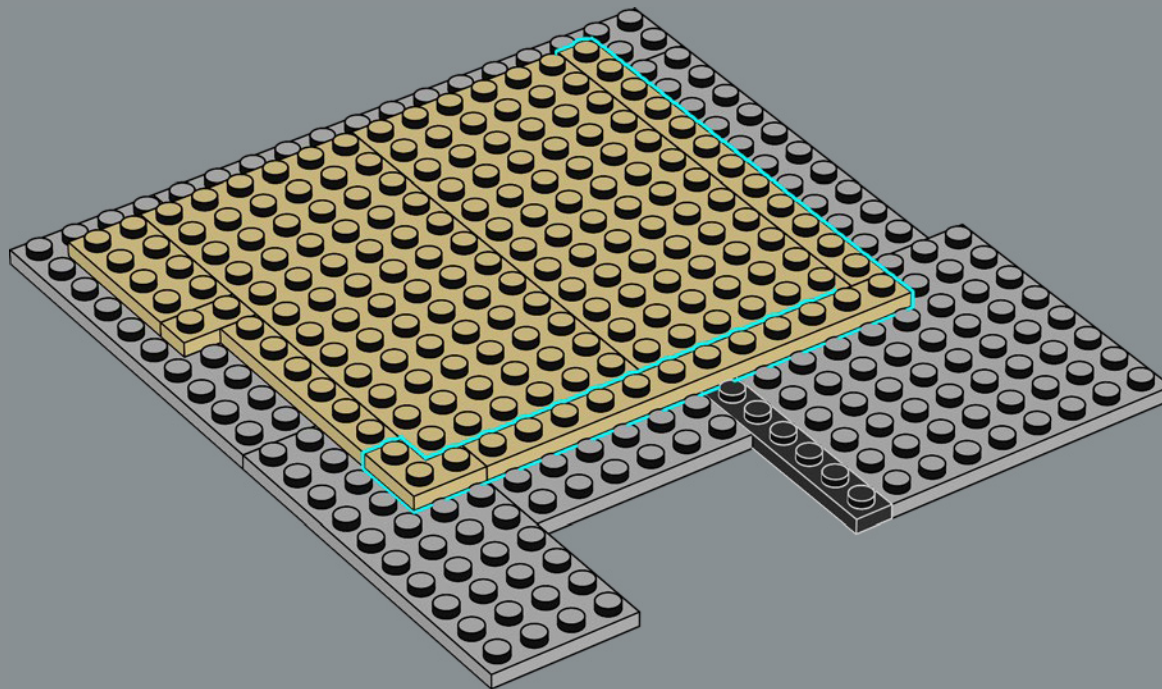

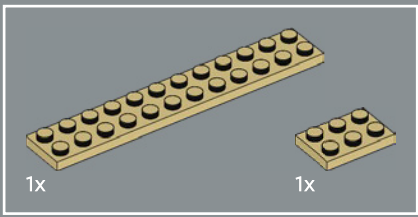

279

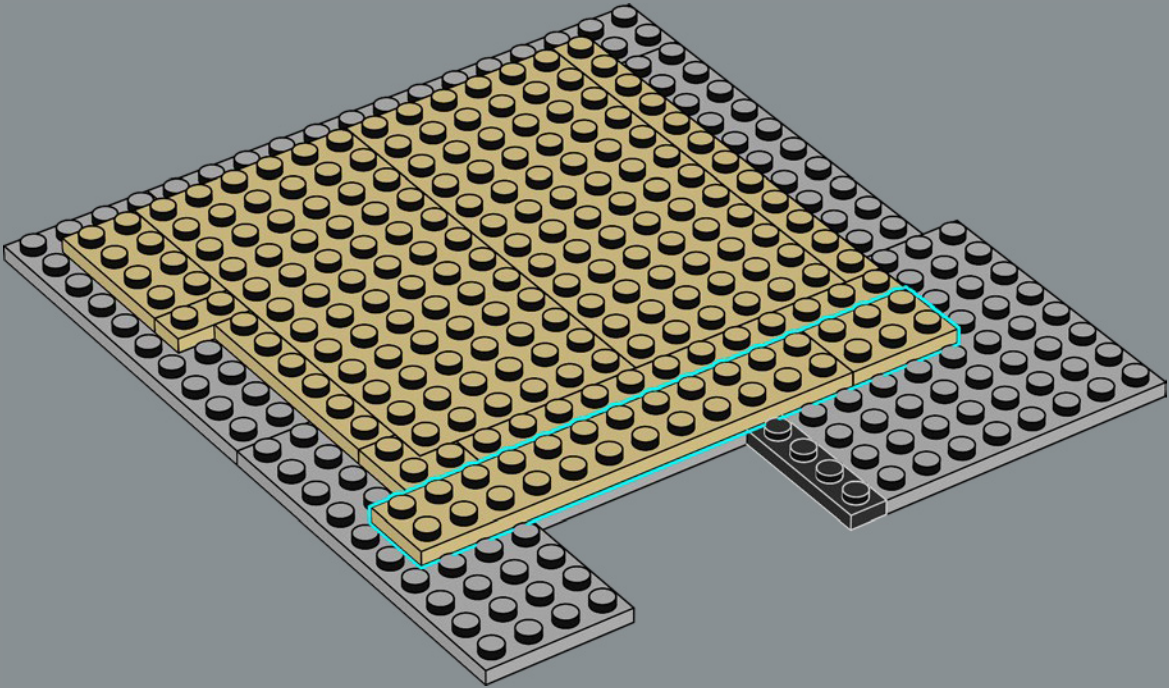

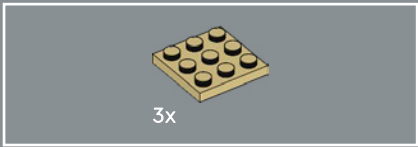

280

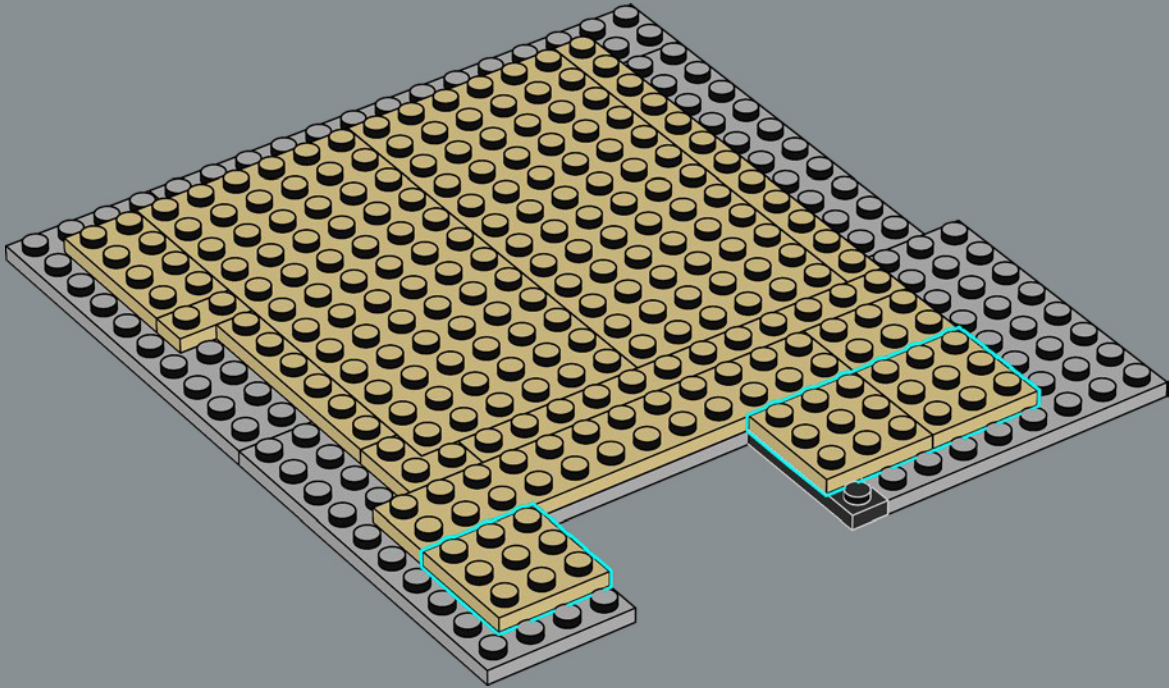

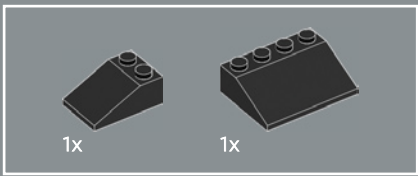

281

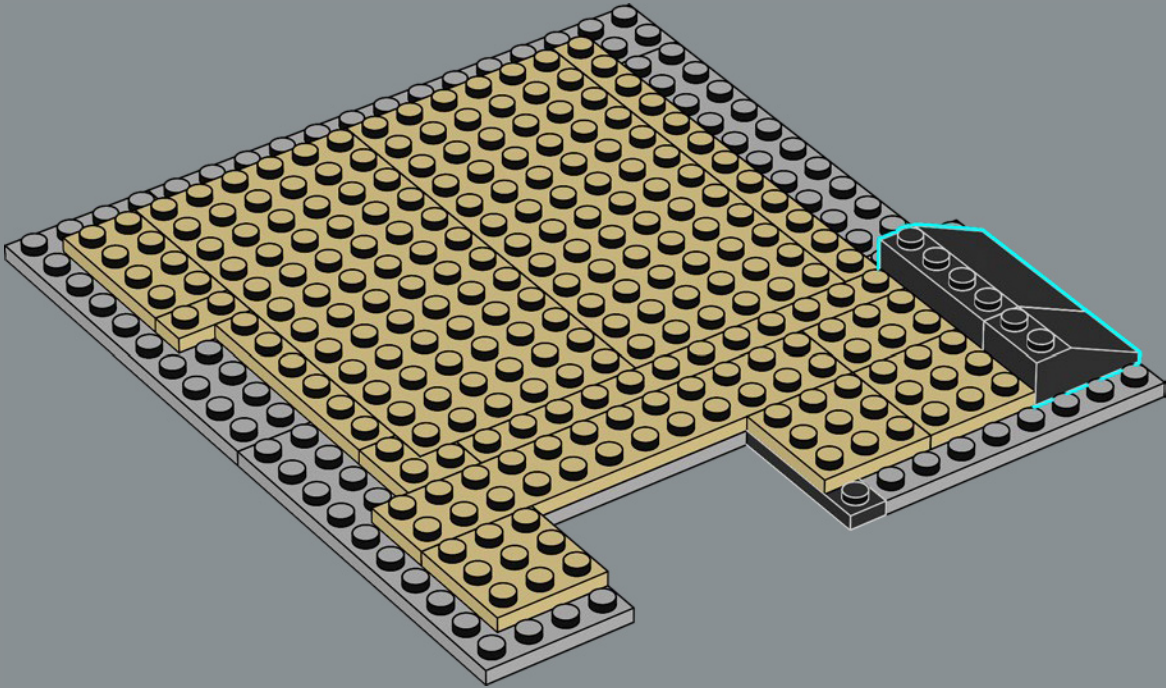

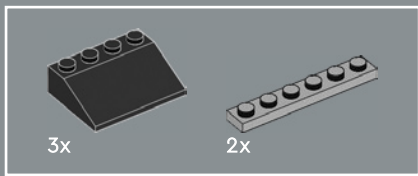

282

1

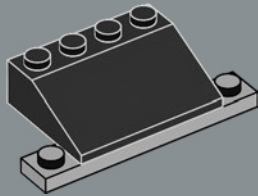

2

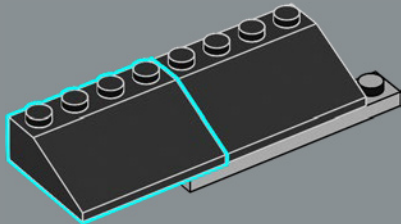

3

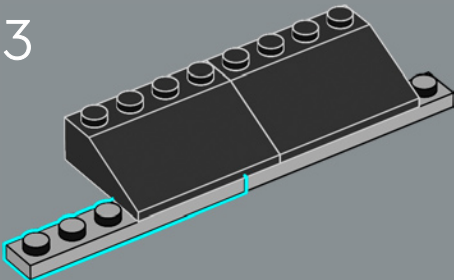

4

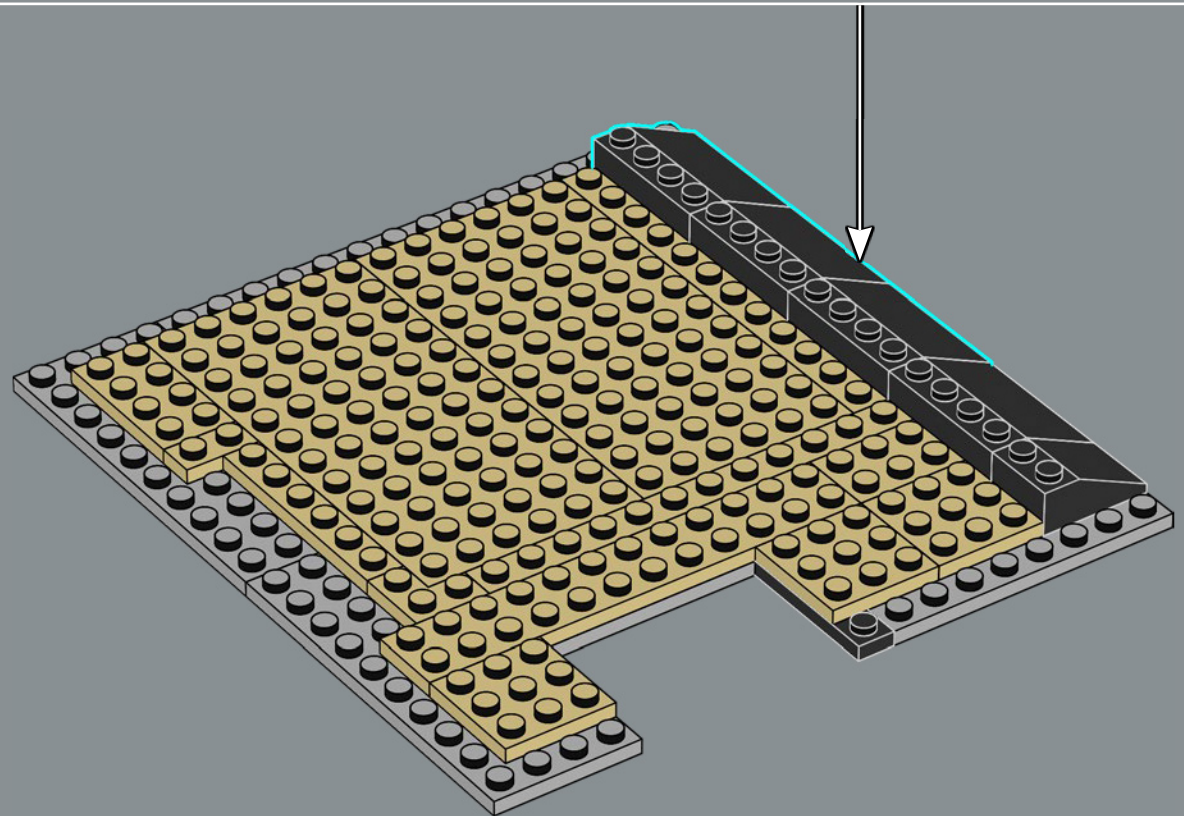
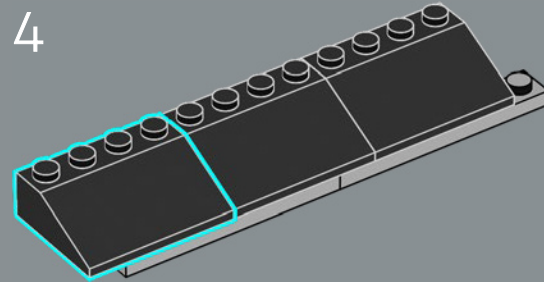

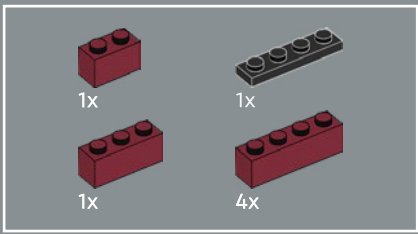

283

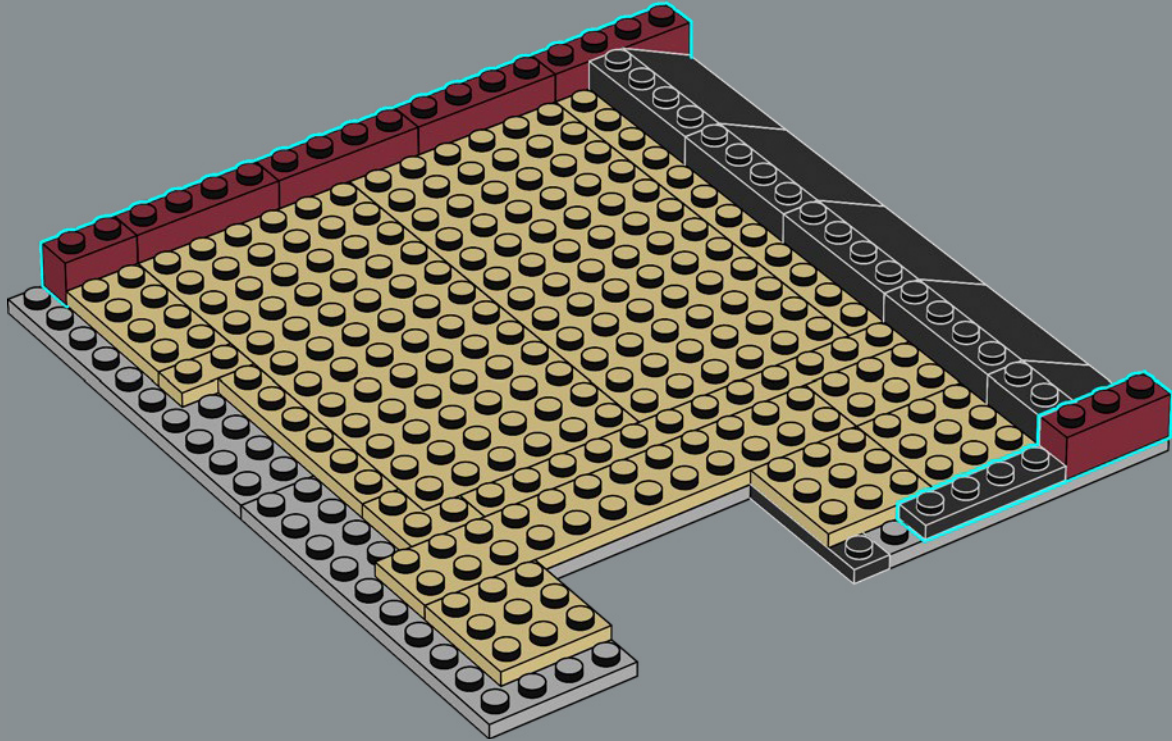

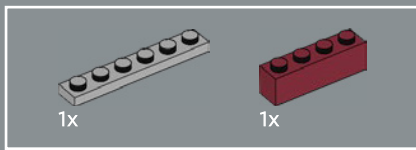

284

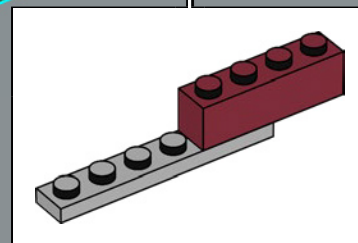
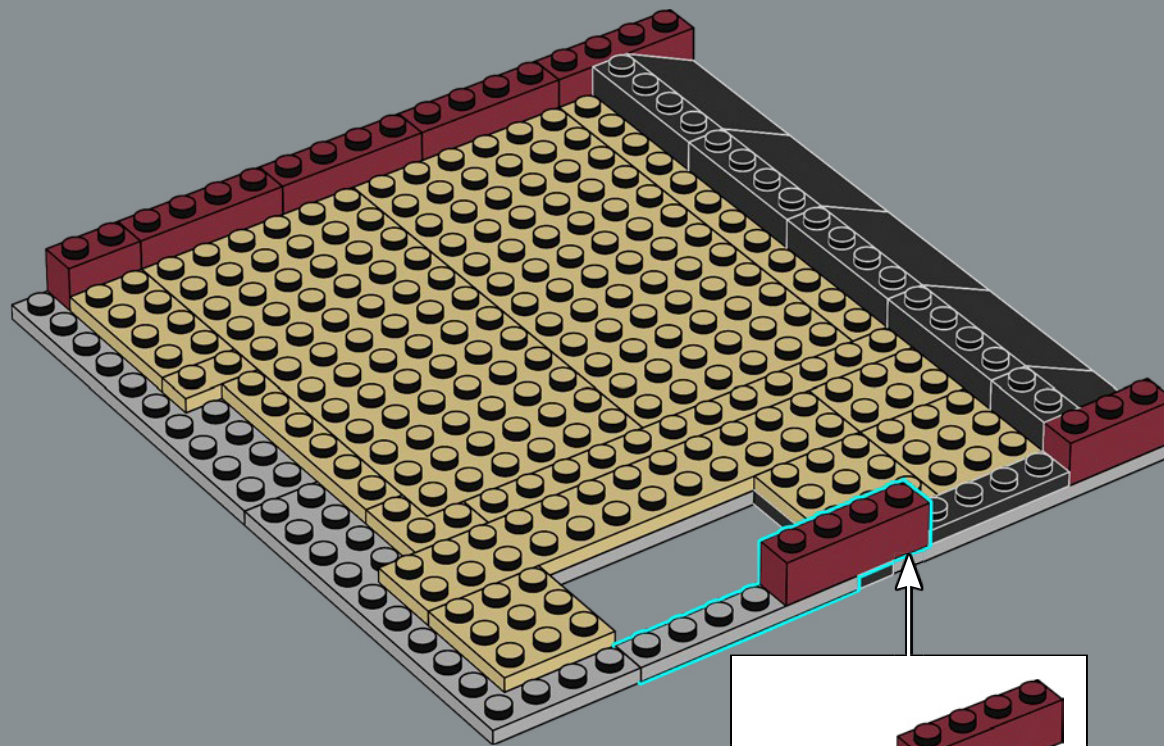

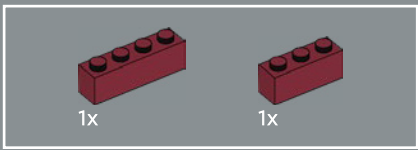

285

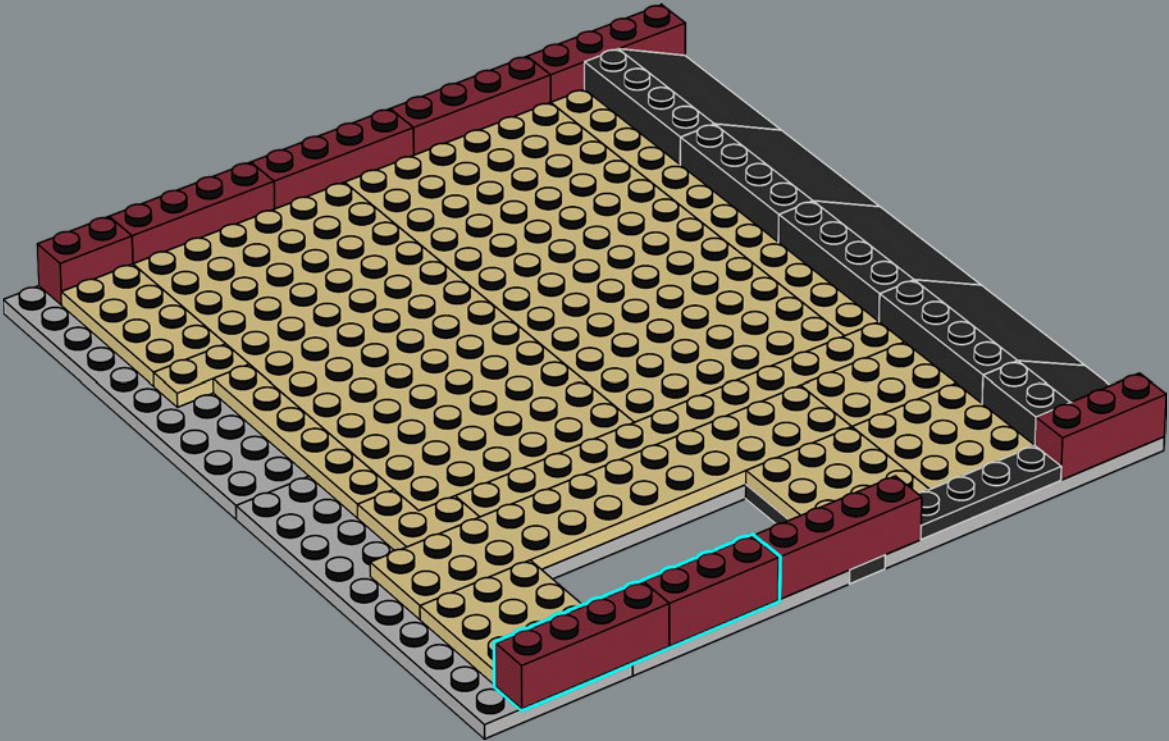

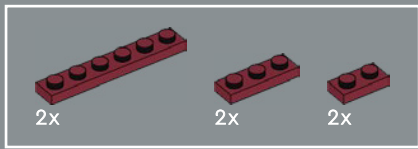

286

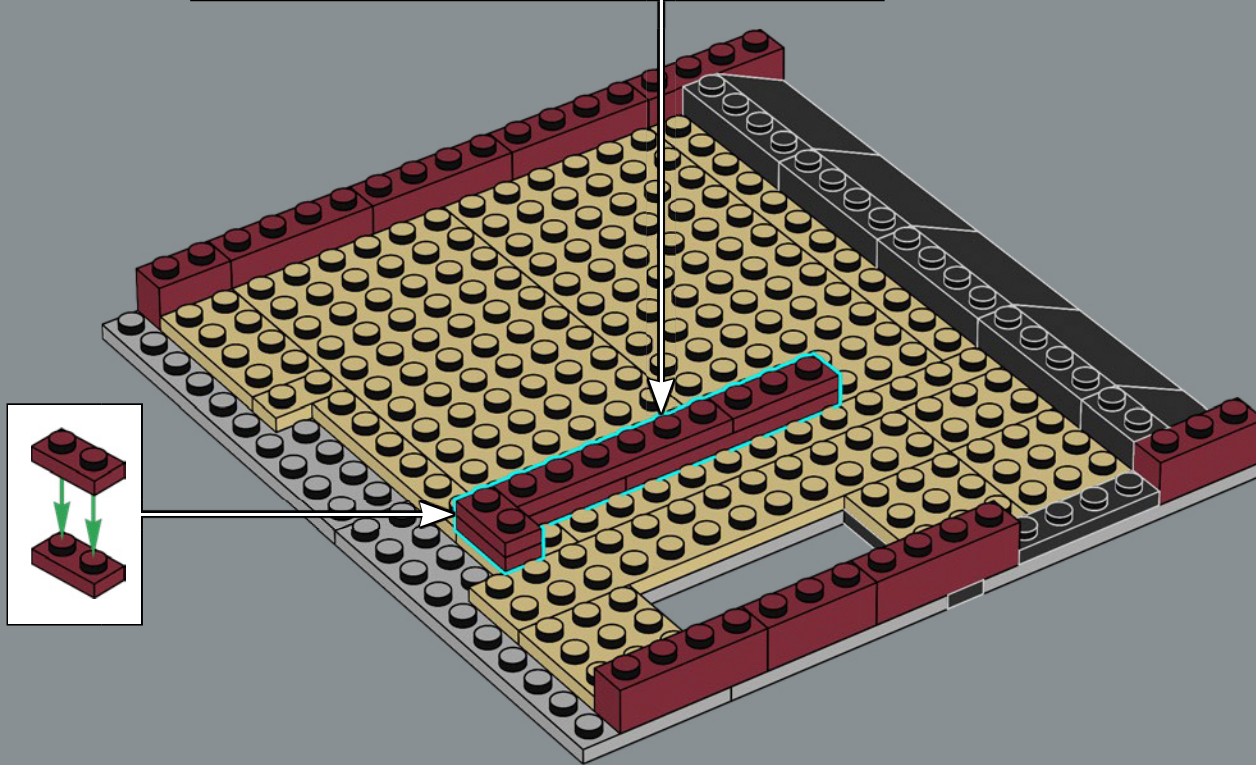
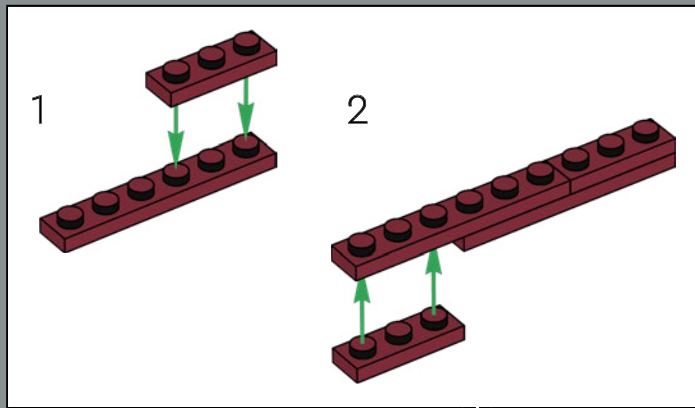

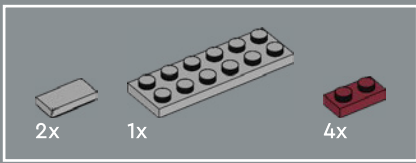

287

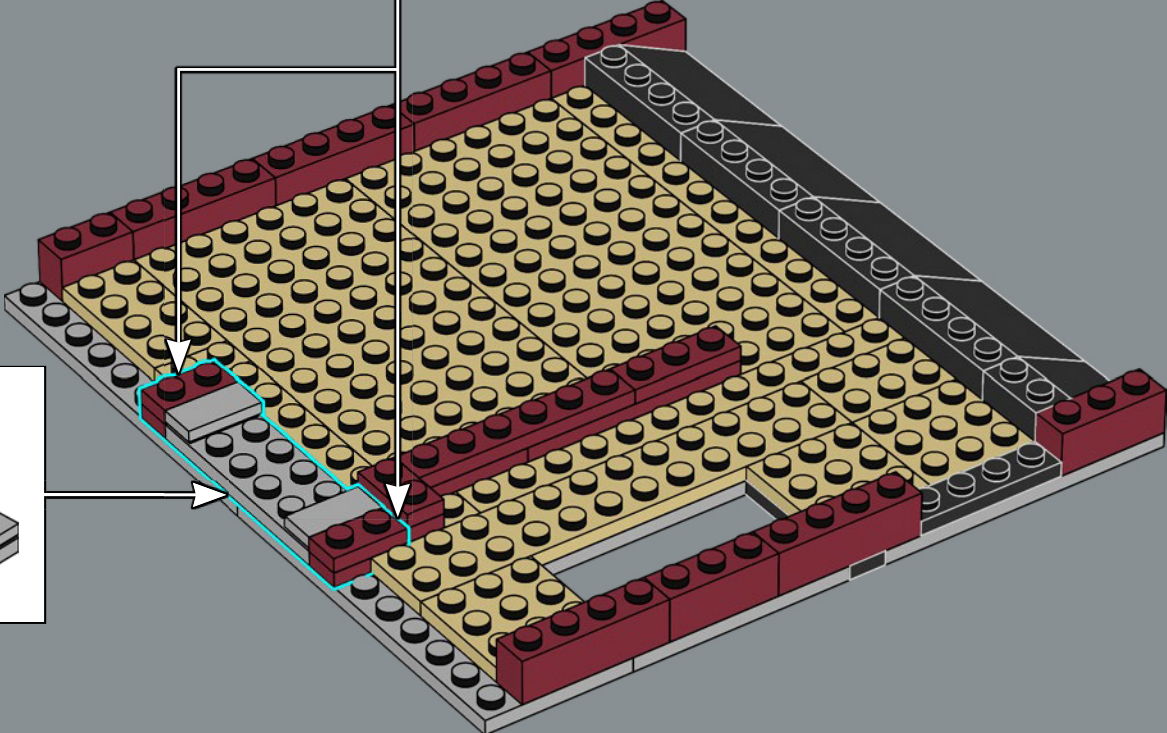
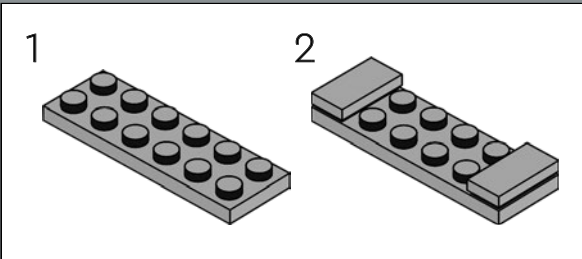
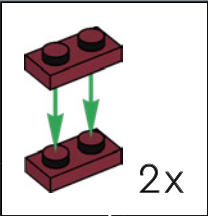

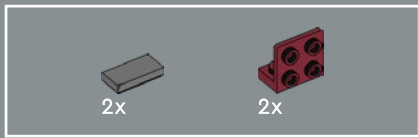

288

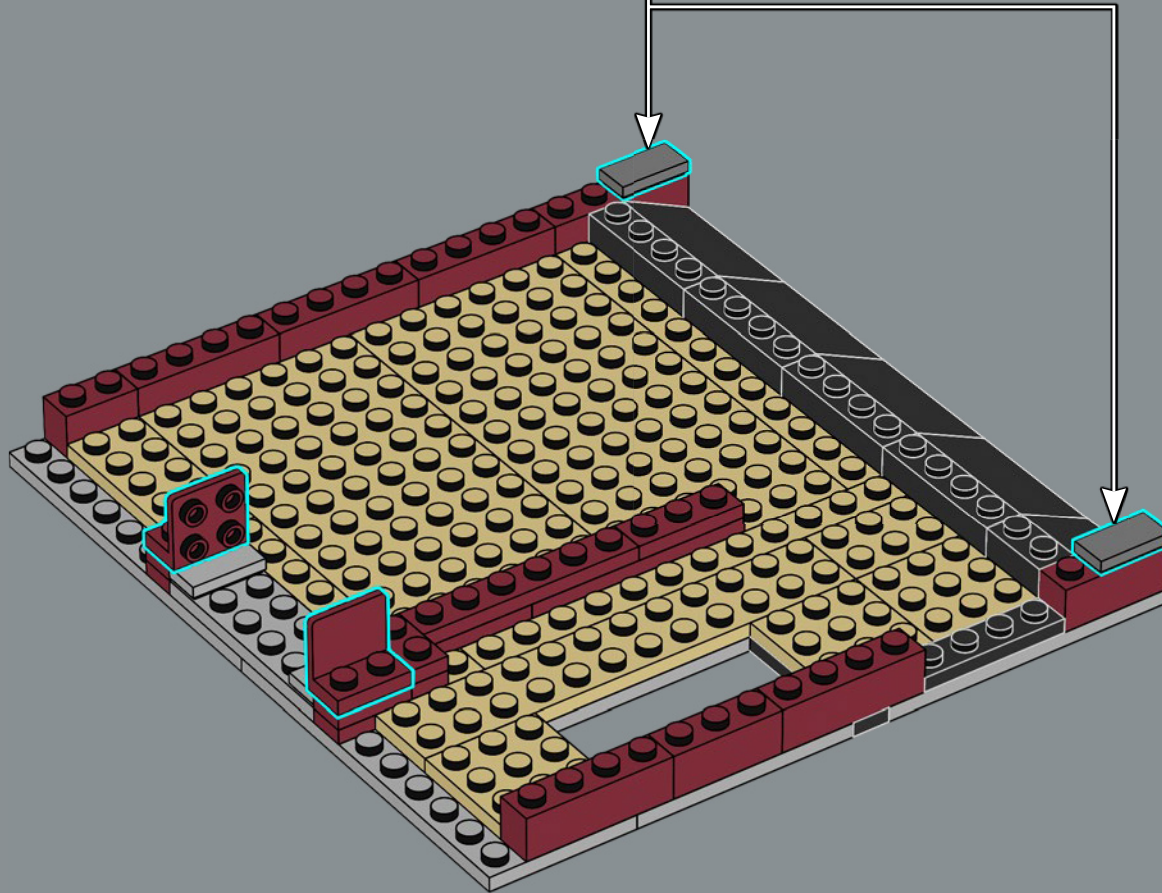

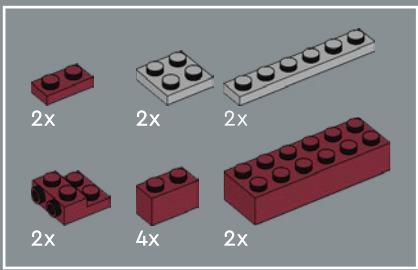

289

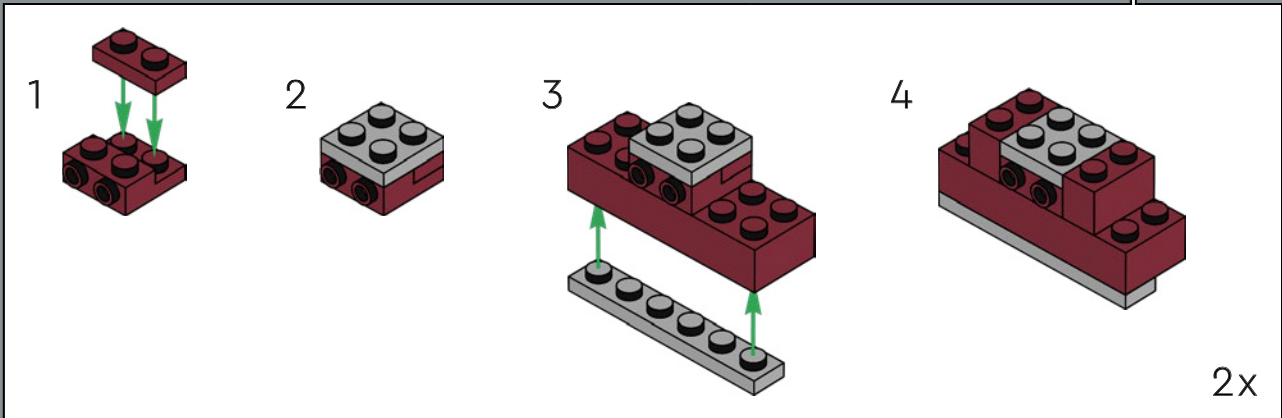
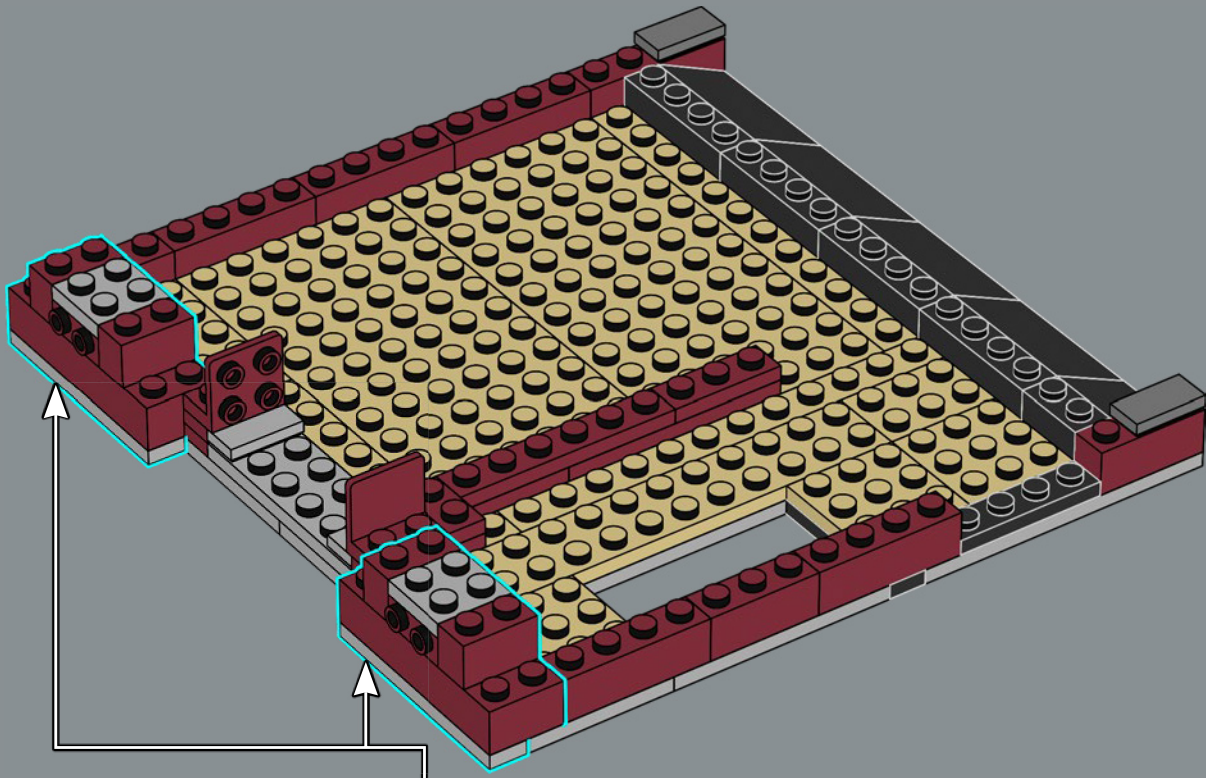

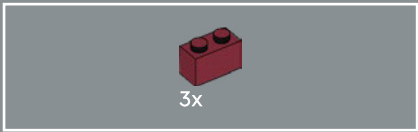

290

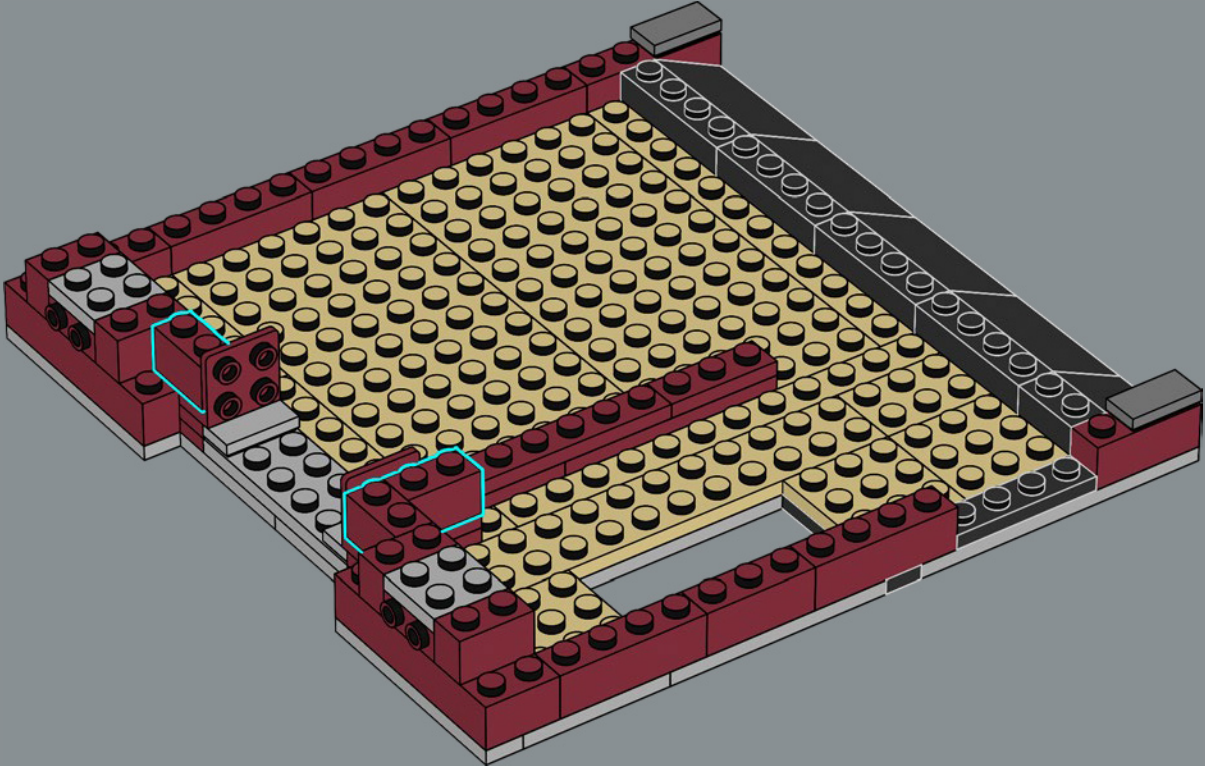

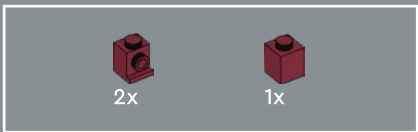

291

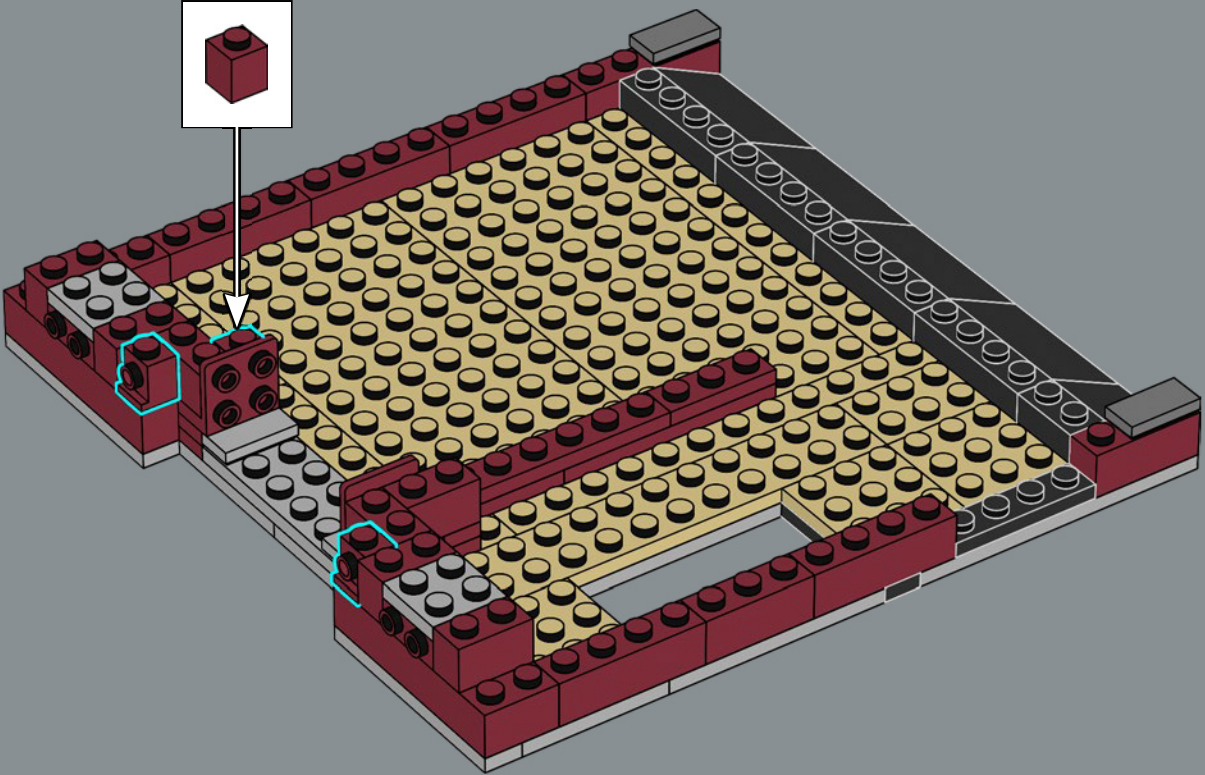



292

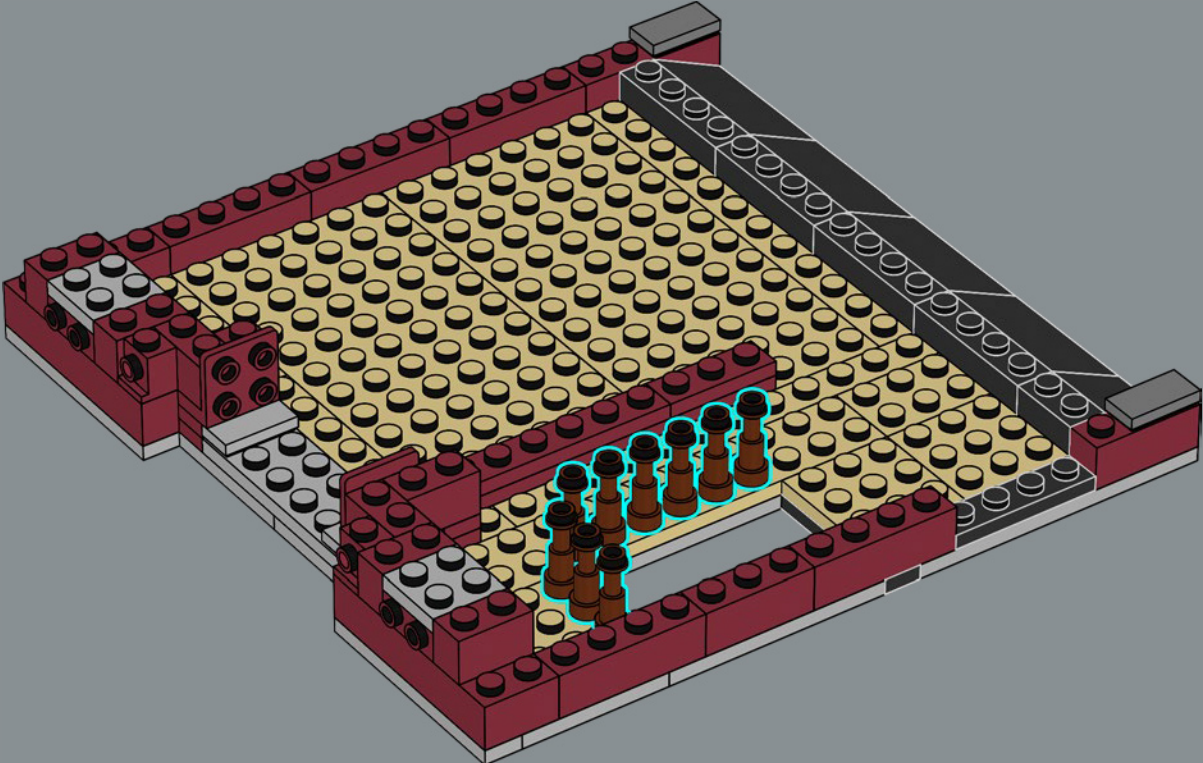



293

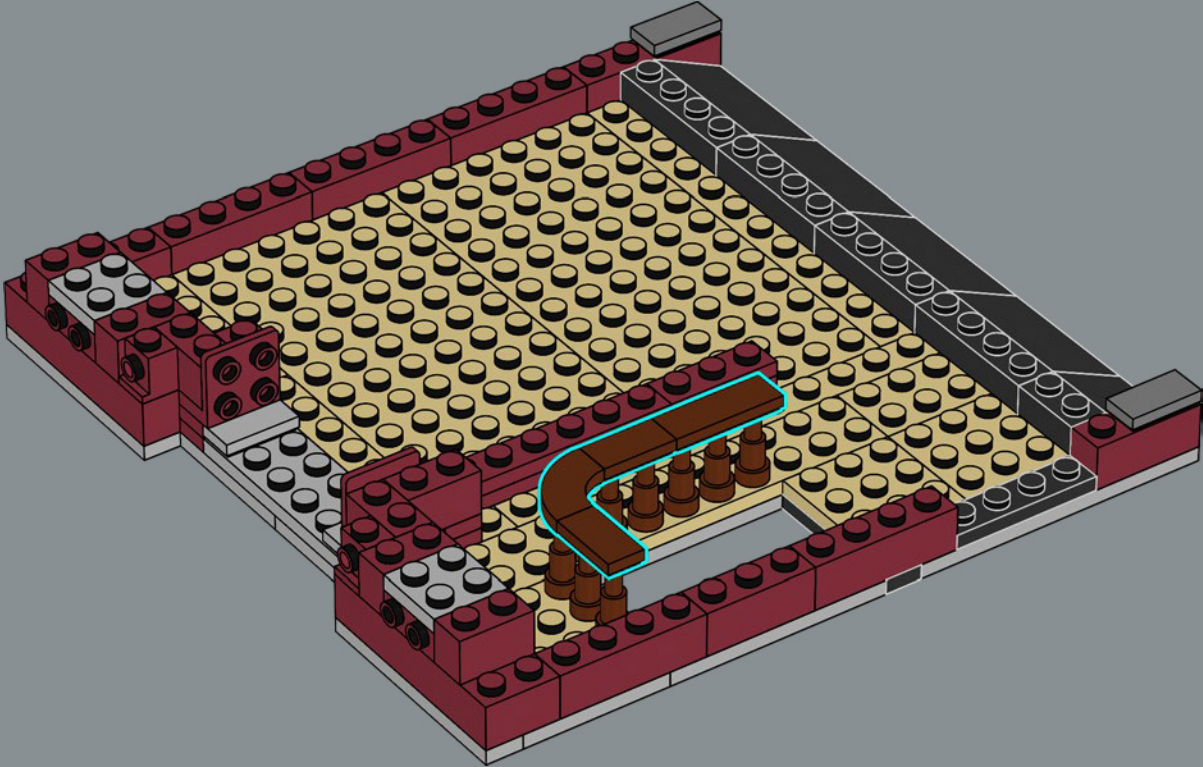

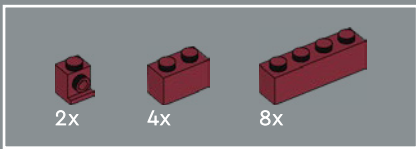

294

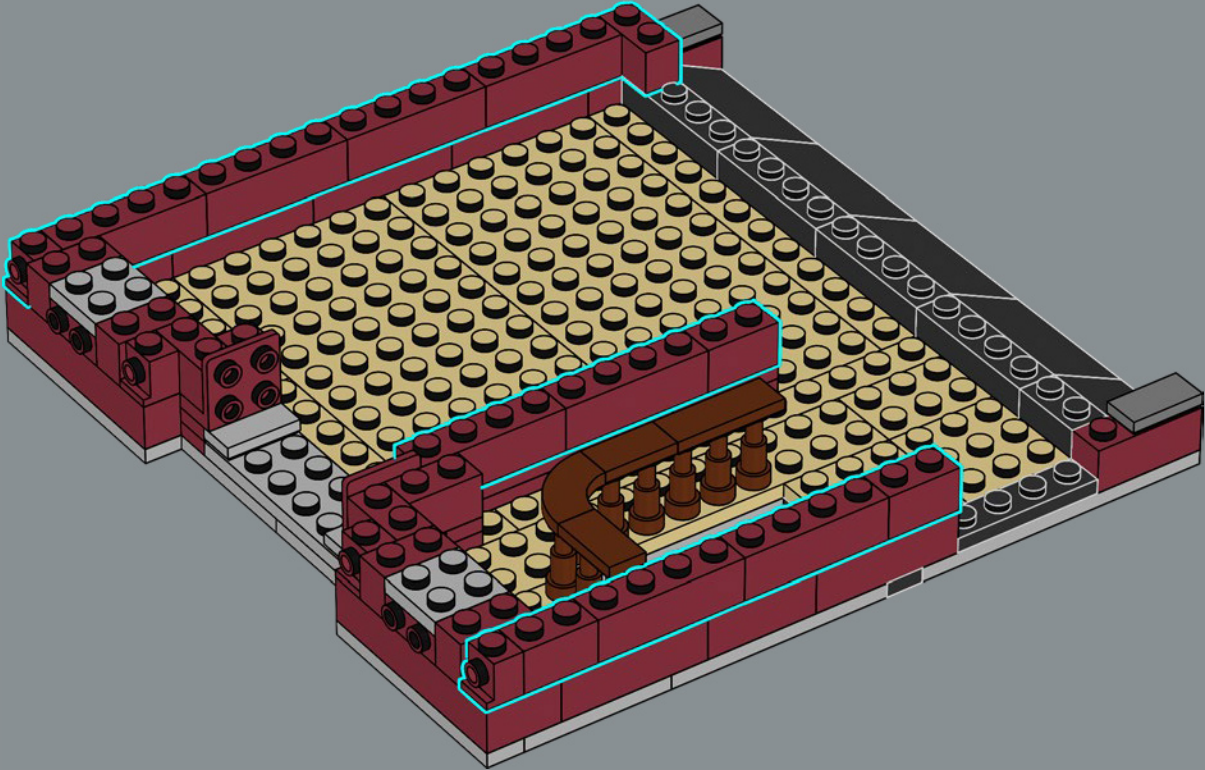

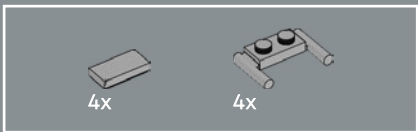

The element used to make the windowsills (1x2 plate with handles) has been in the LEGO® System since 1978!

295

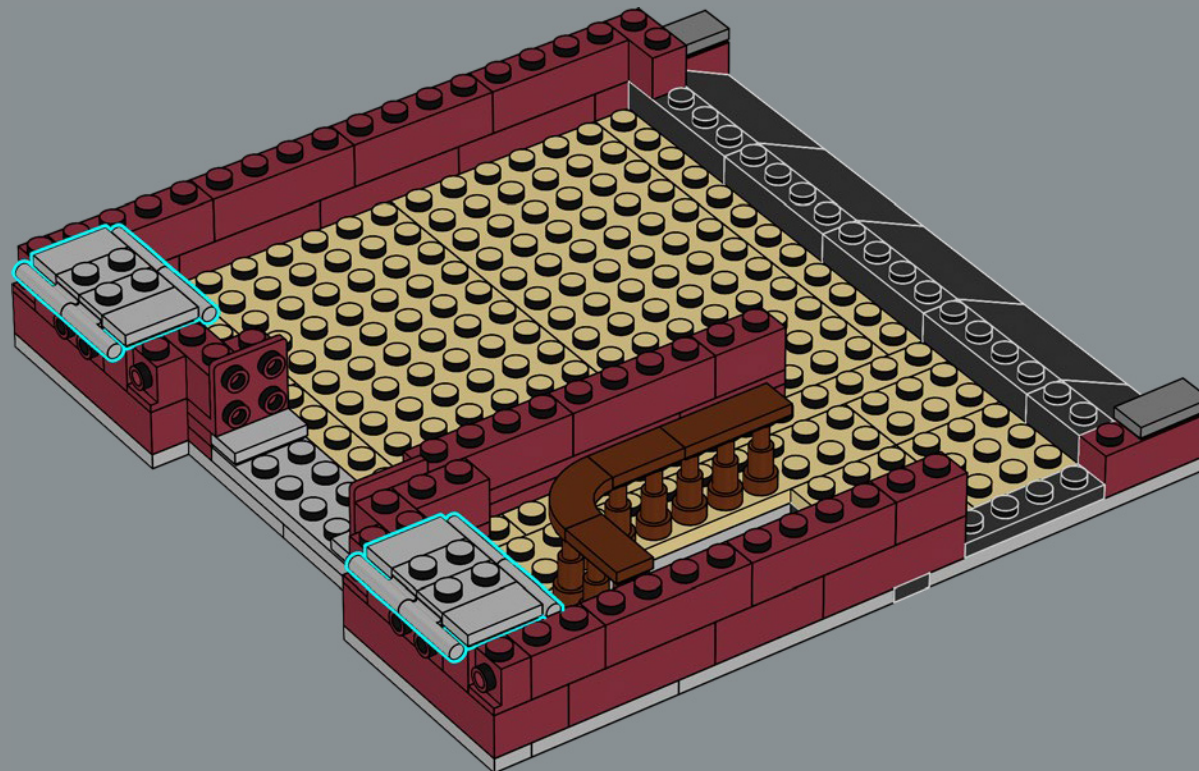

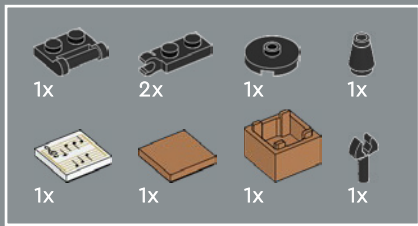

296

1



2



3

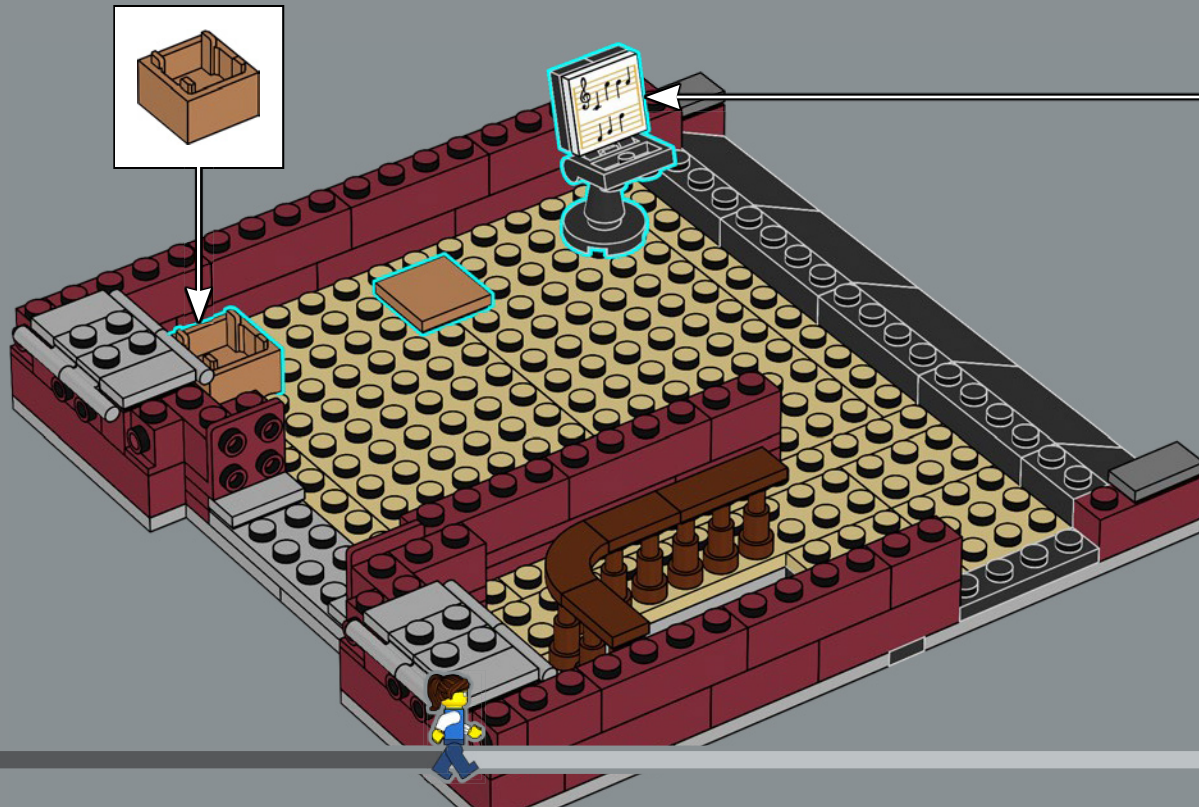
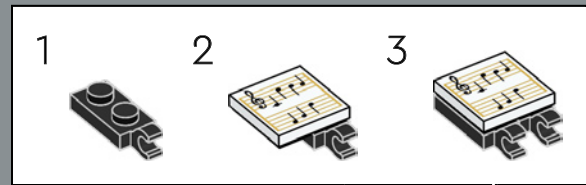

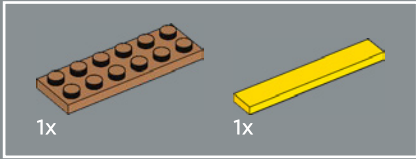
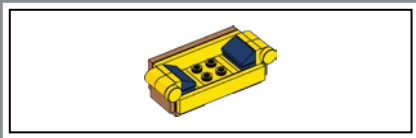

297

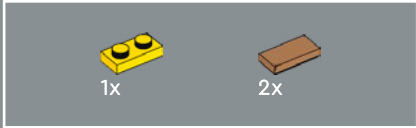
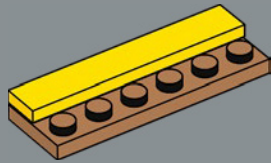

298

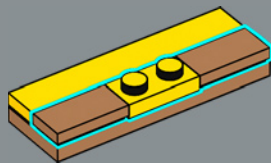

299

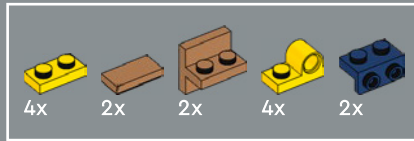
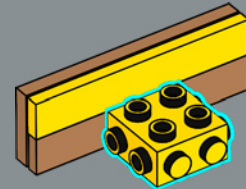

300

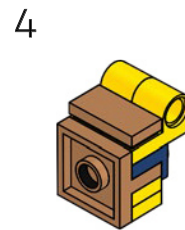
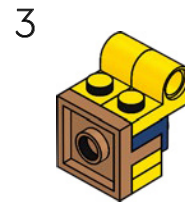
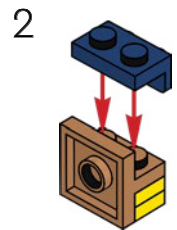
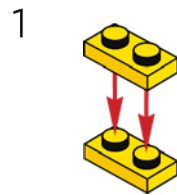

2x

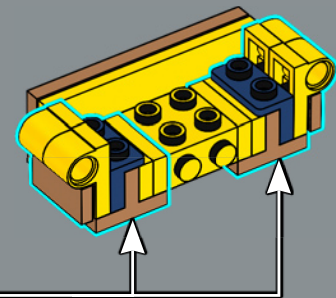

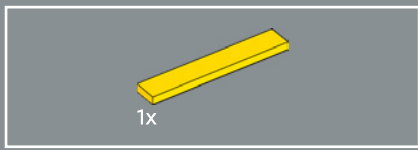

301

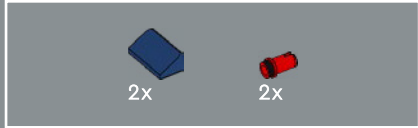
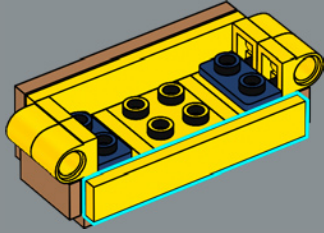

302

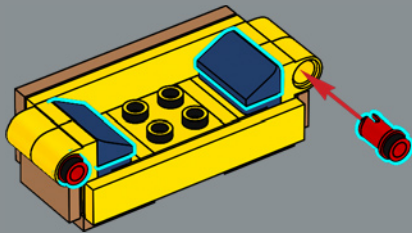

303

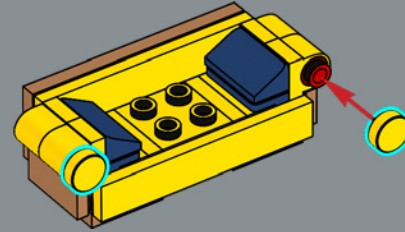

304

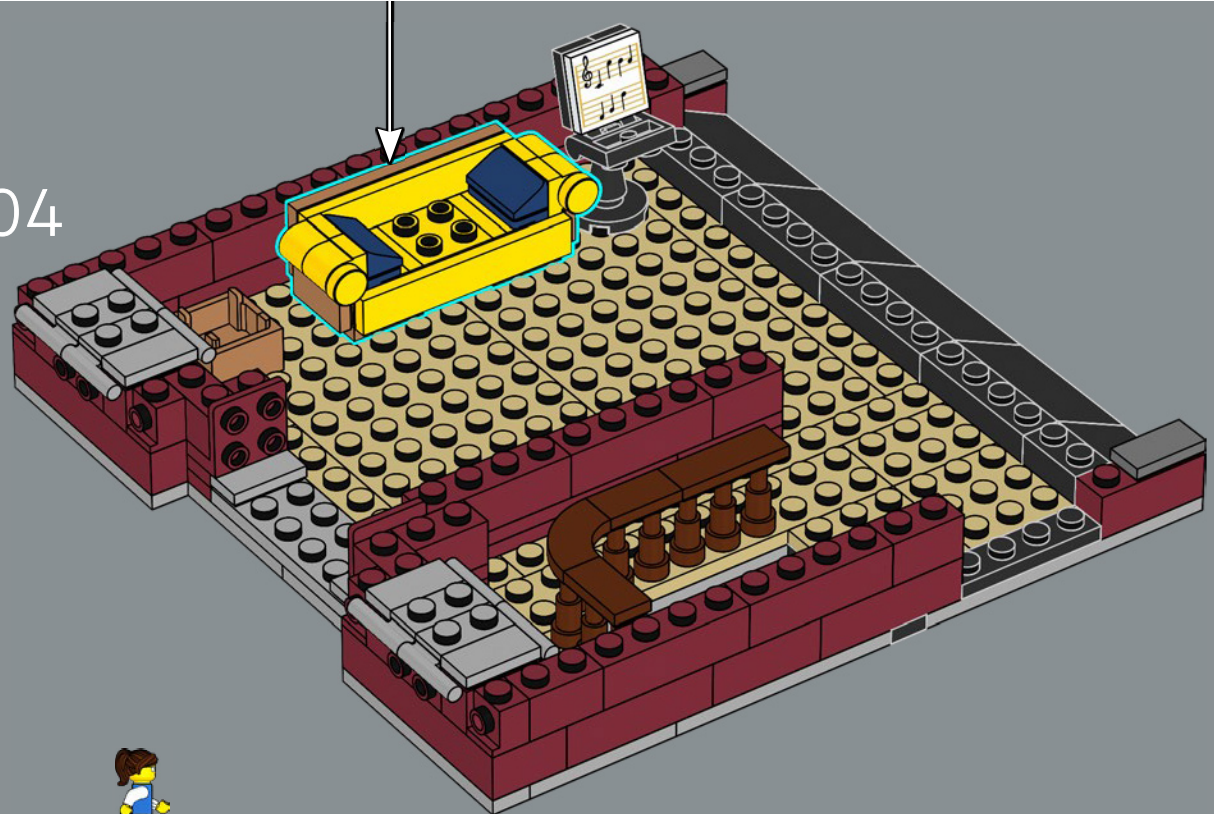



305

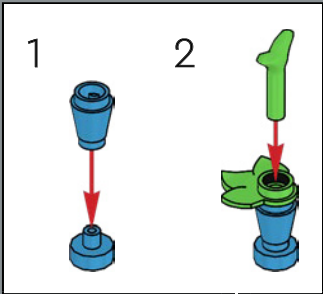

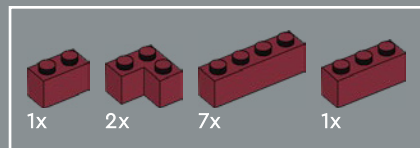

306

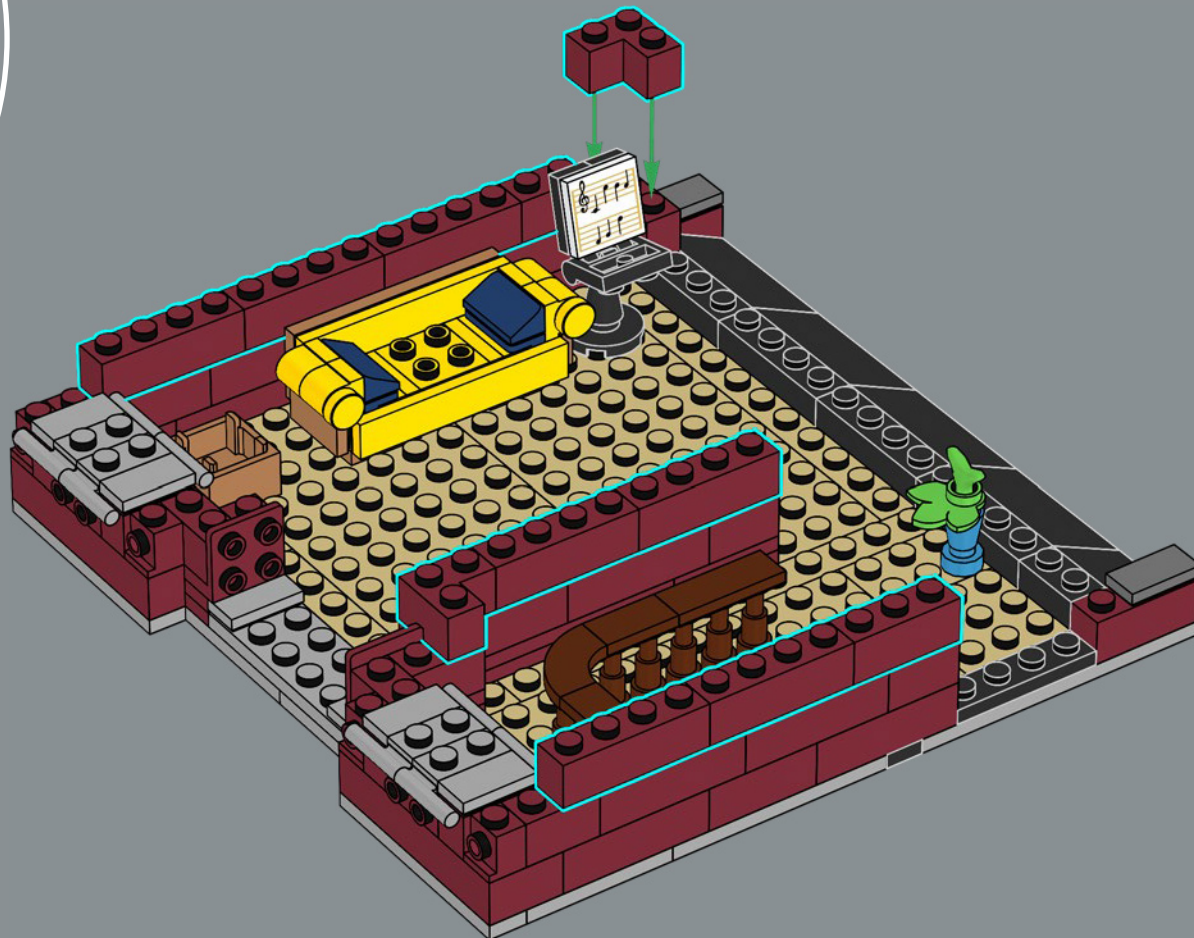

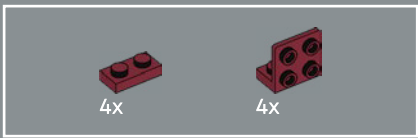

307

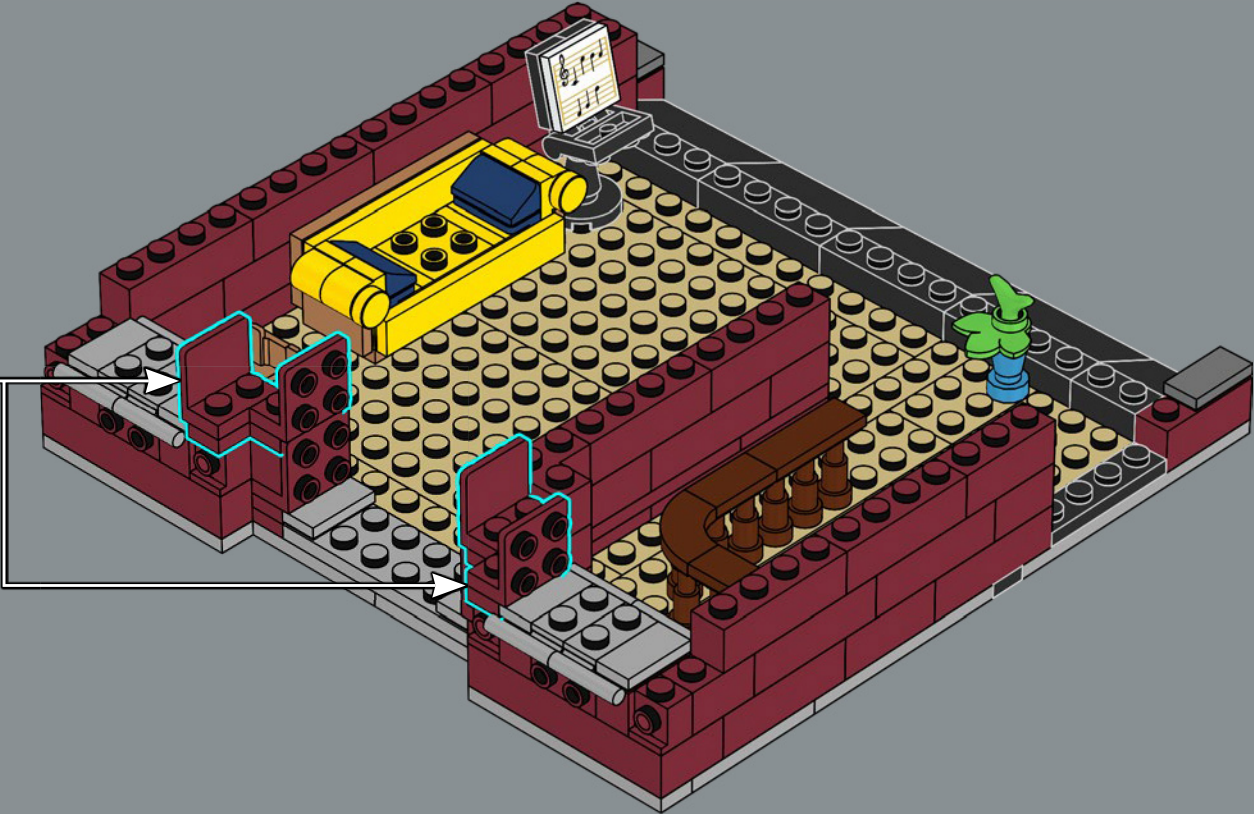
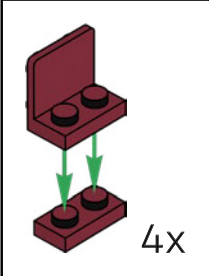

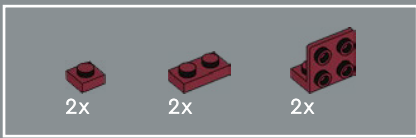

308

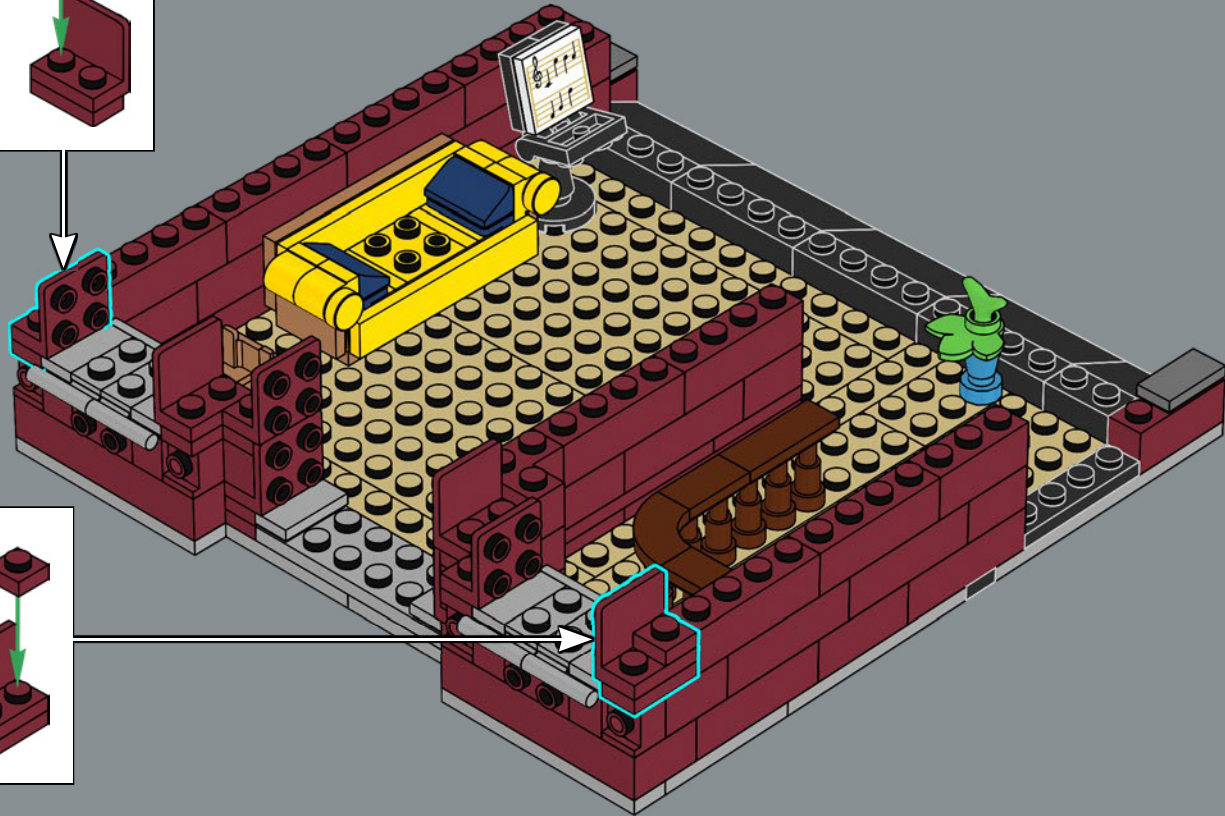
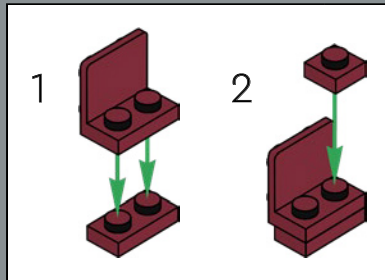
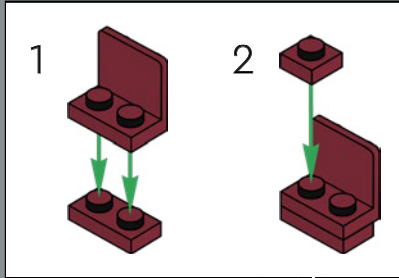

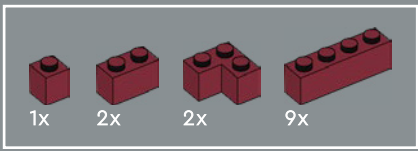

309

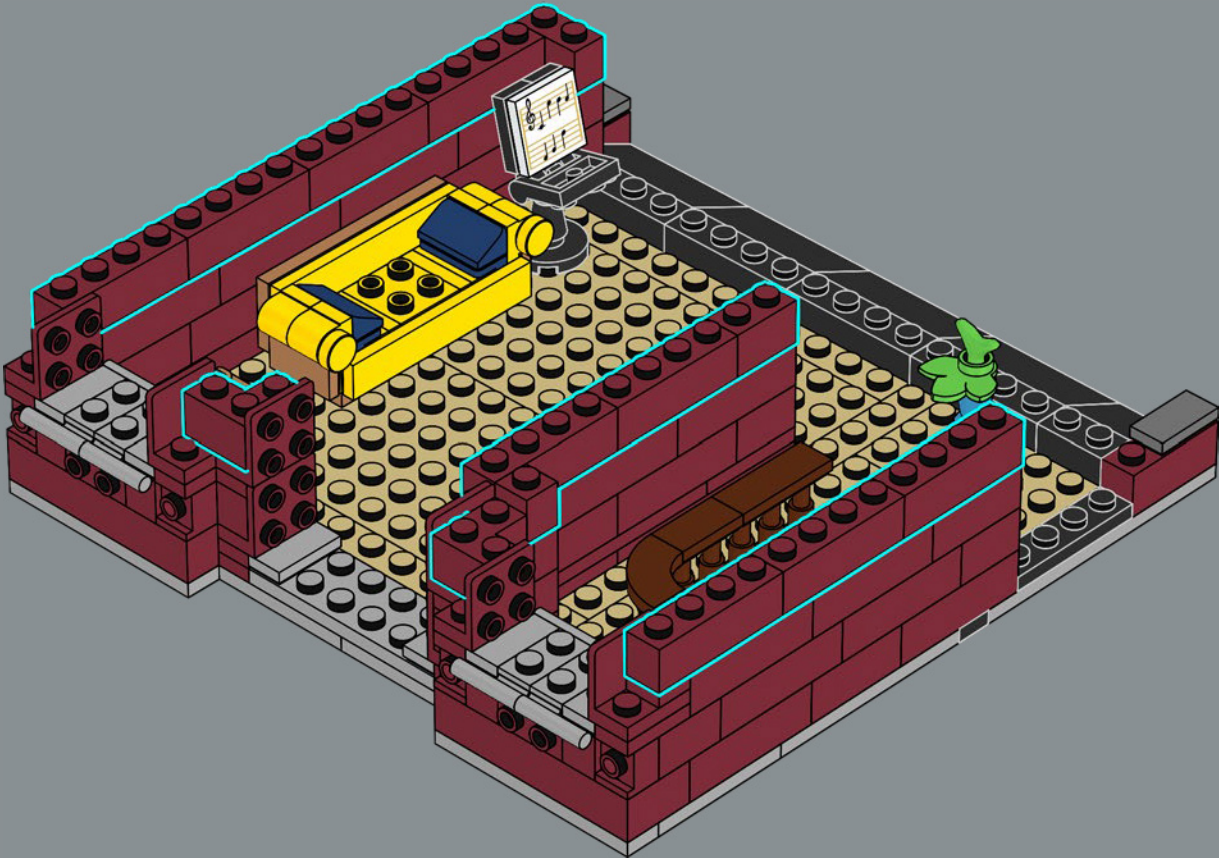



4x

310

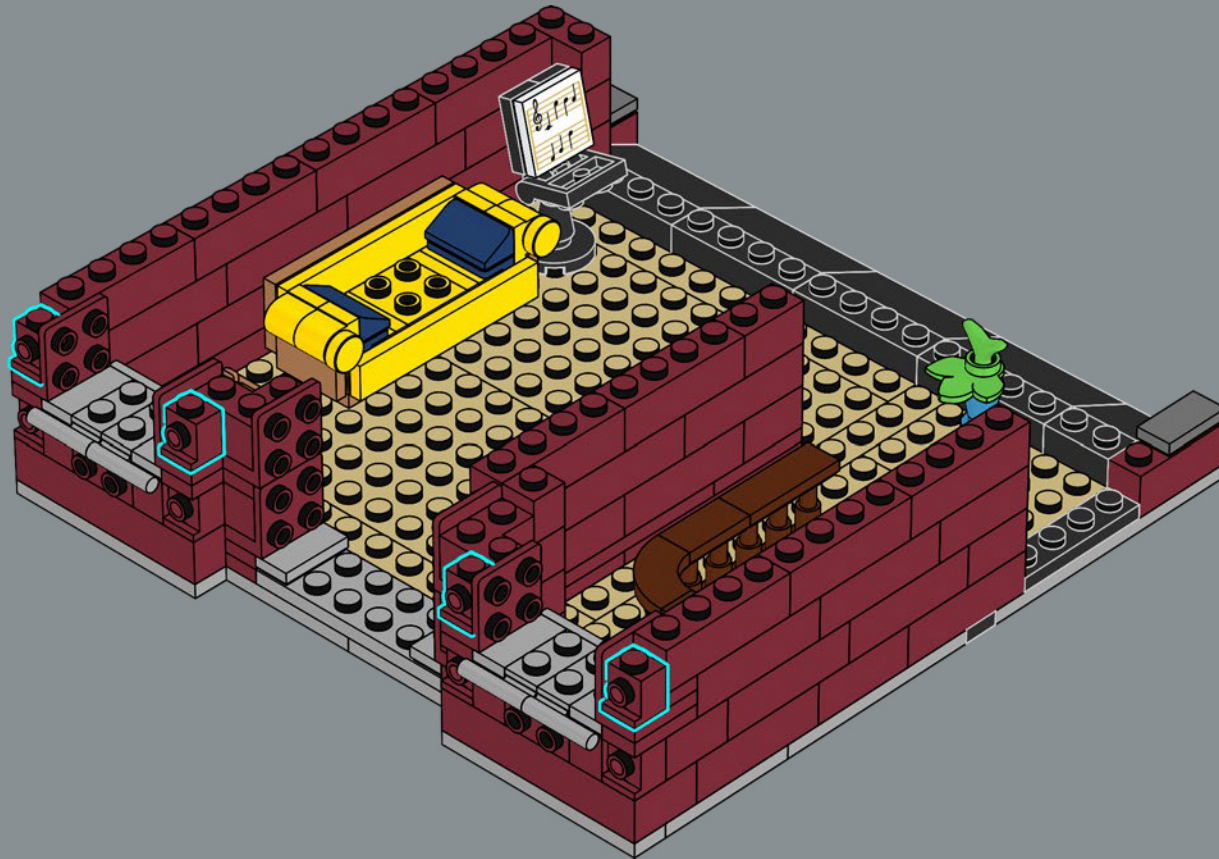

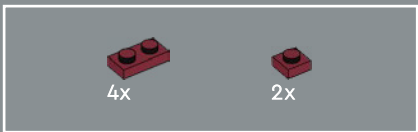

311

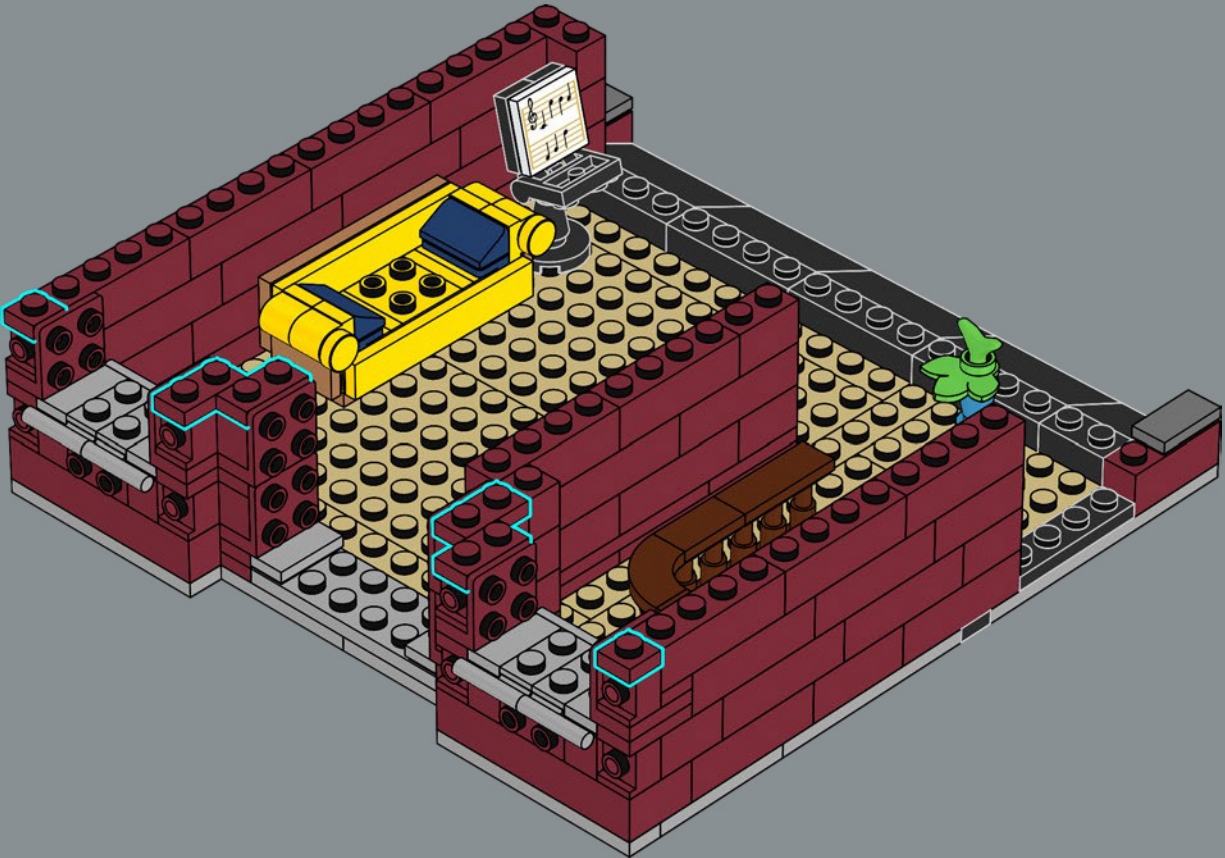

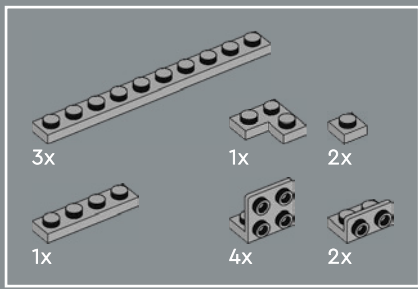

312

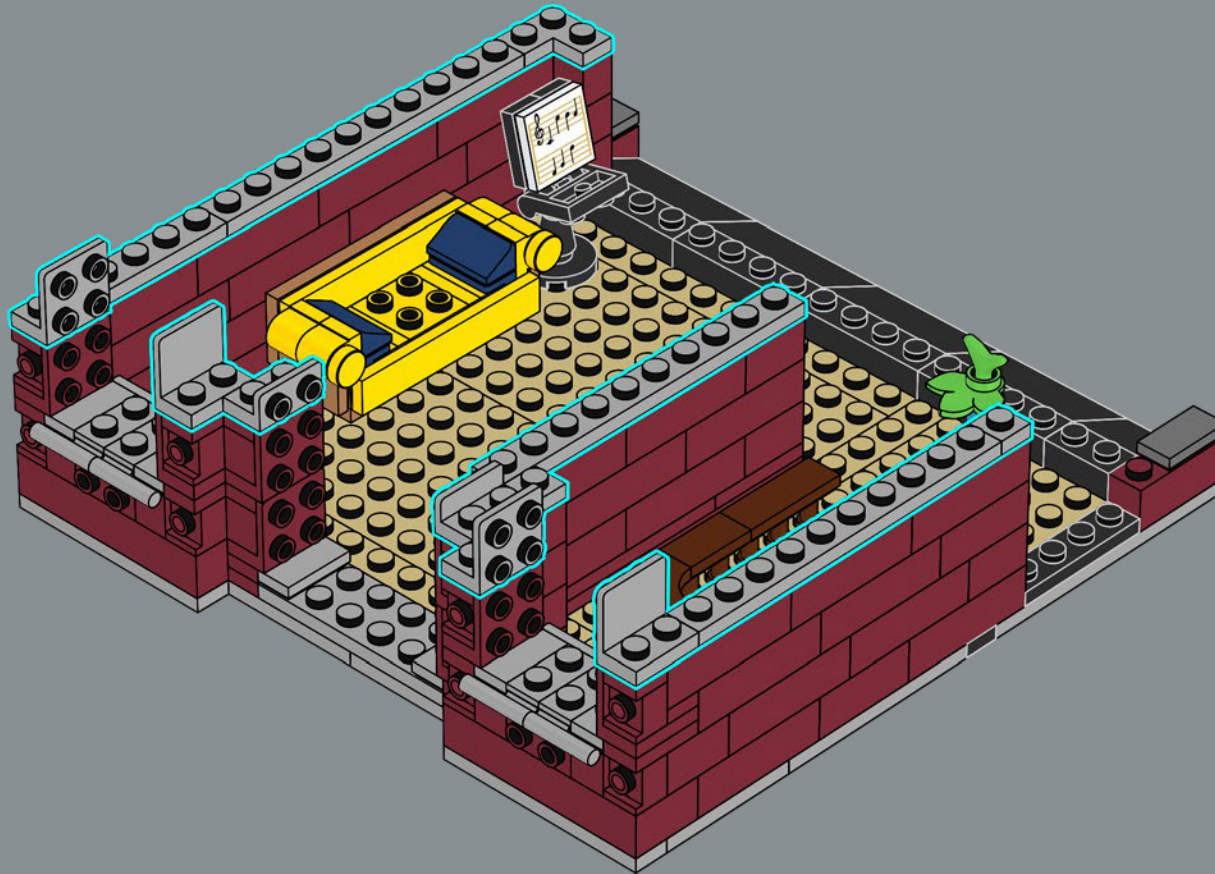

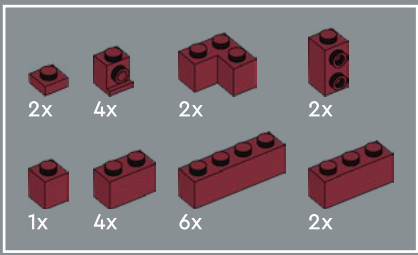

313

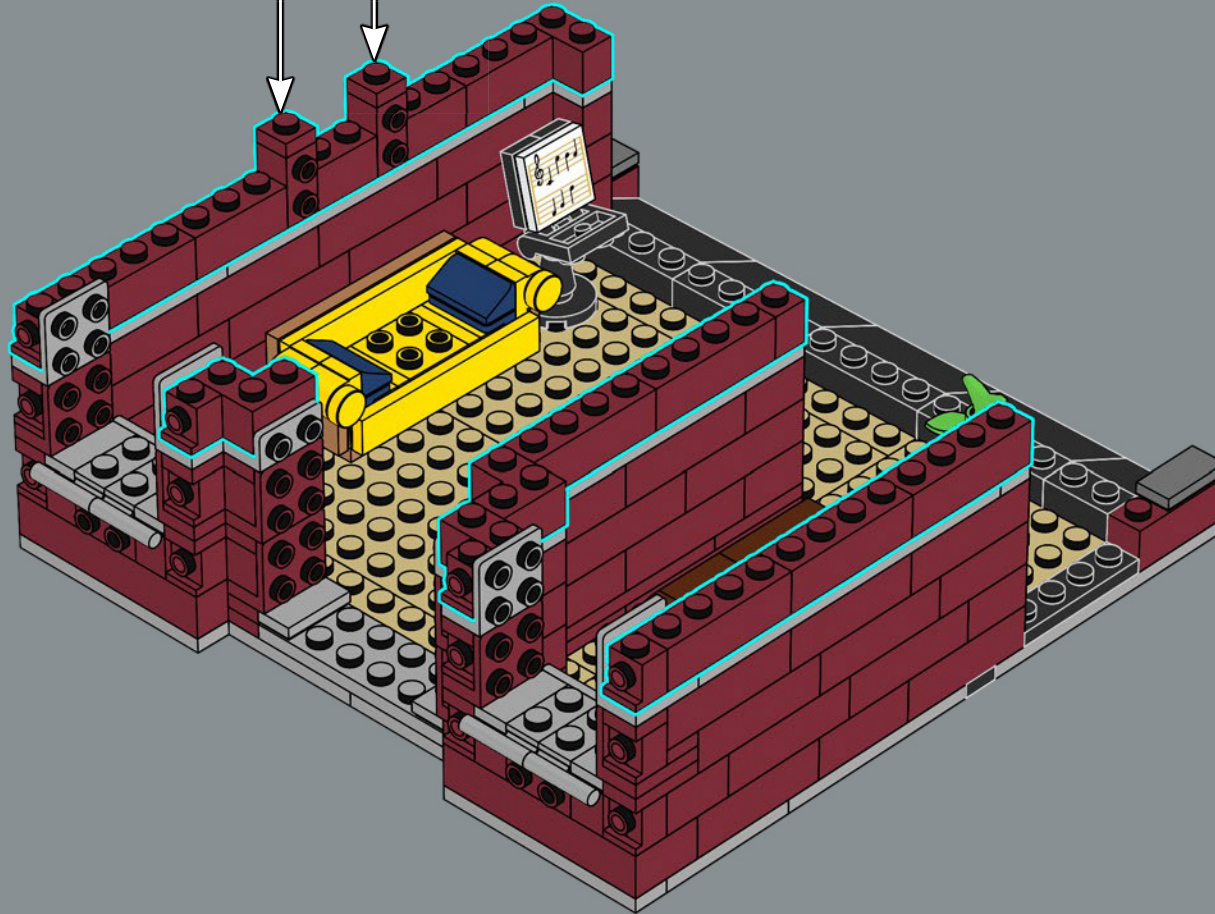
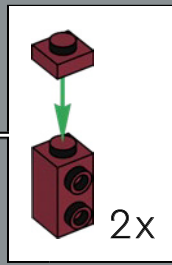

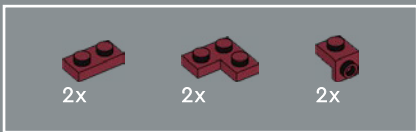

314

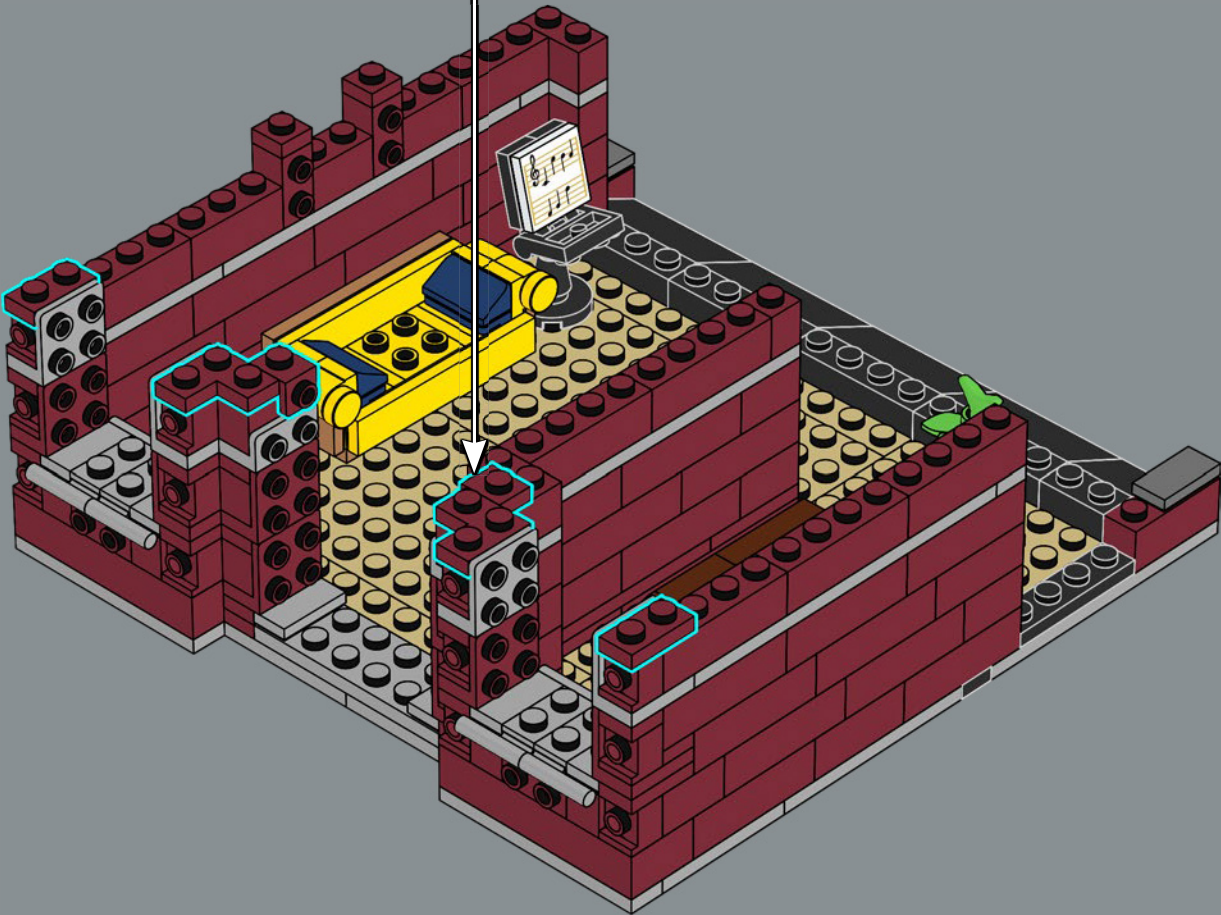
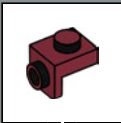

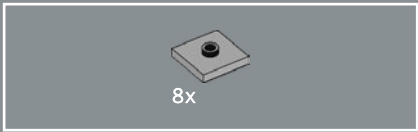

315

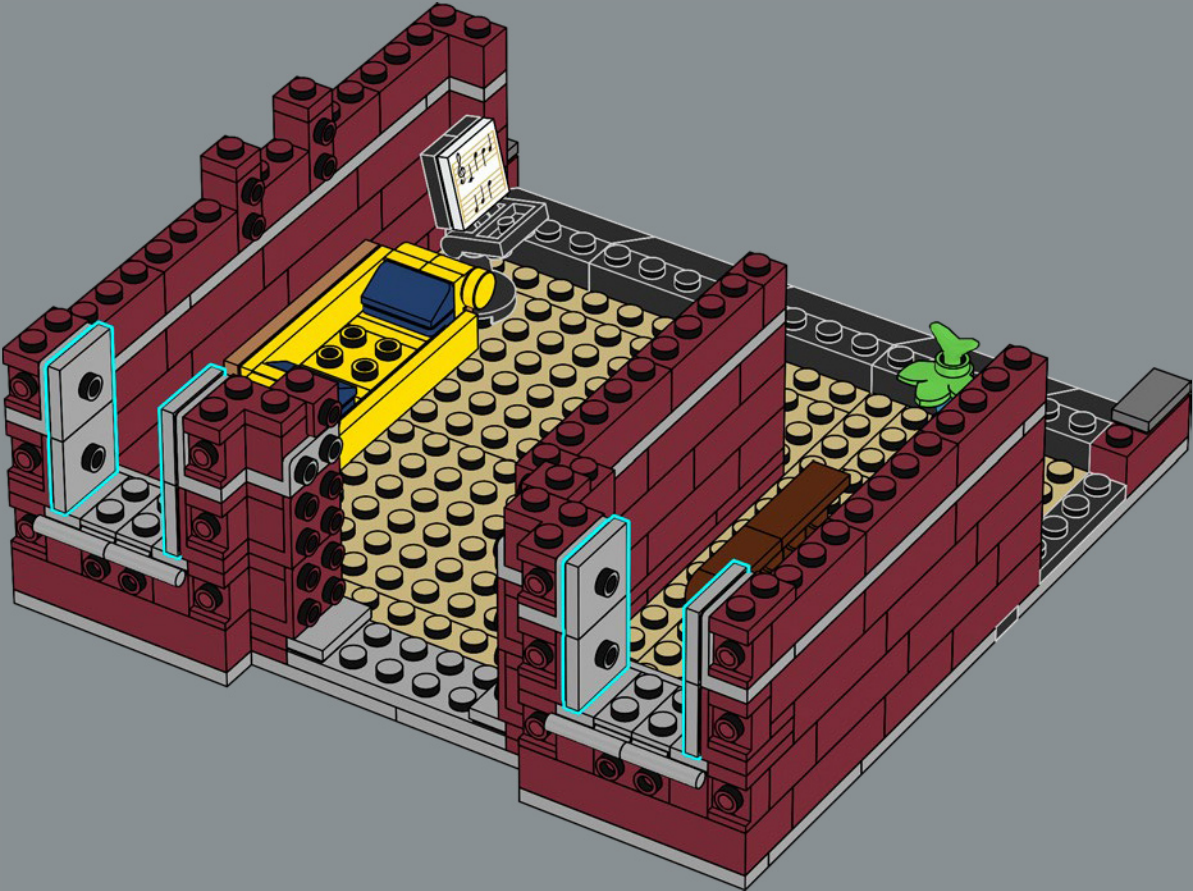

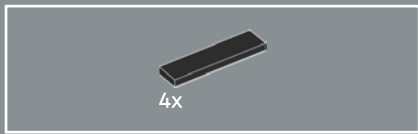

316

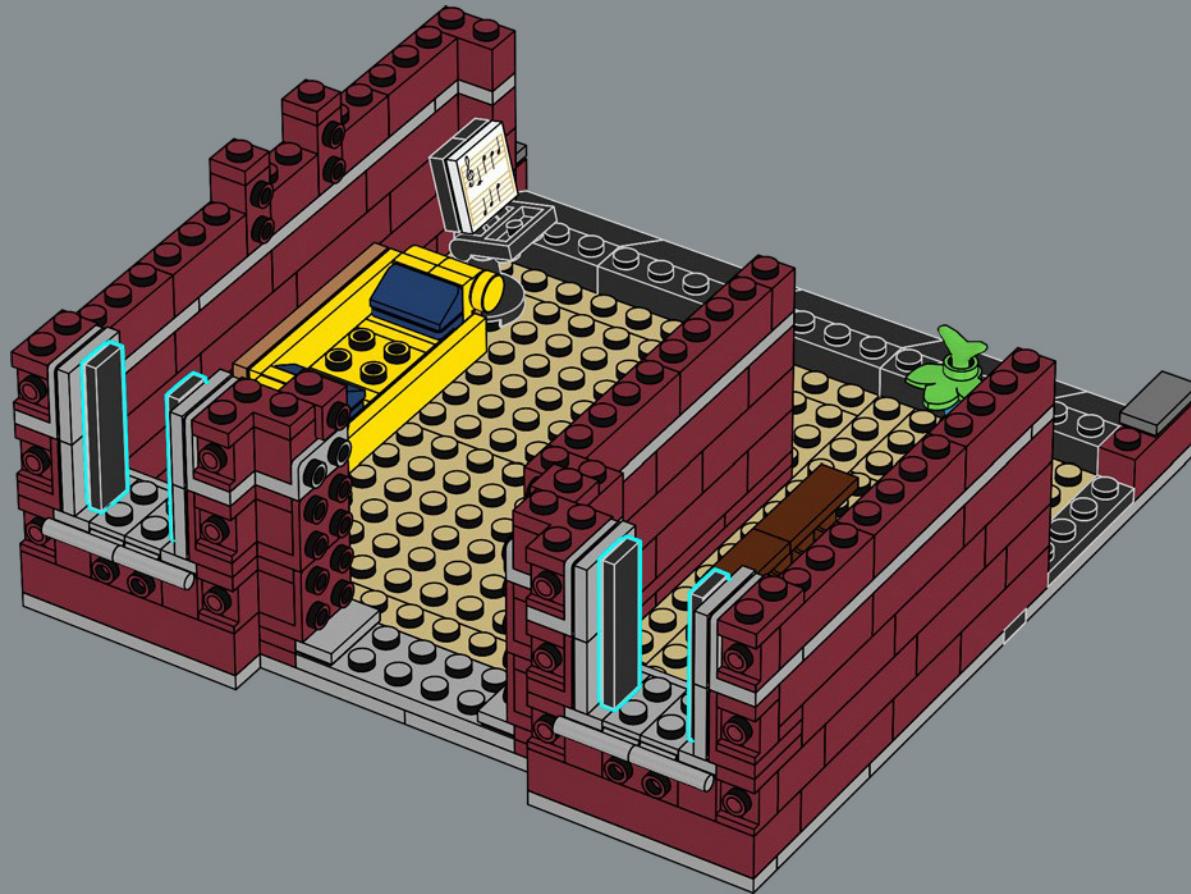



317

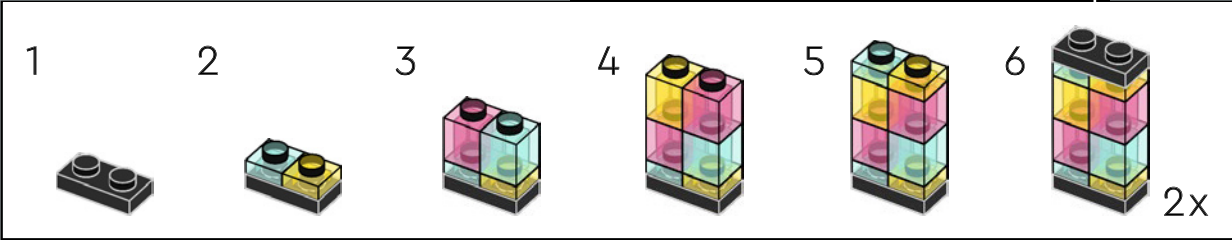
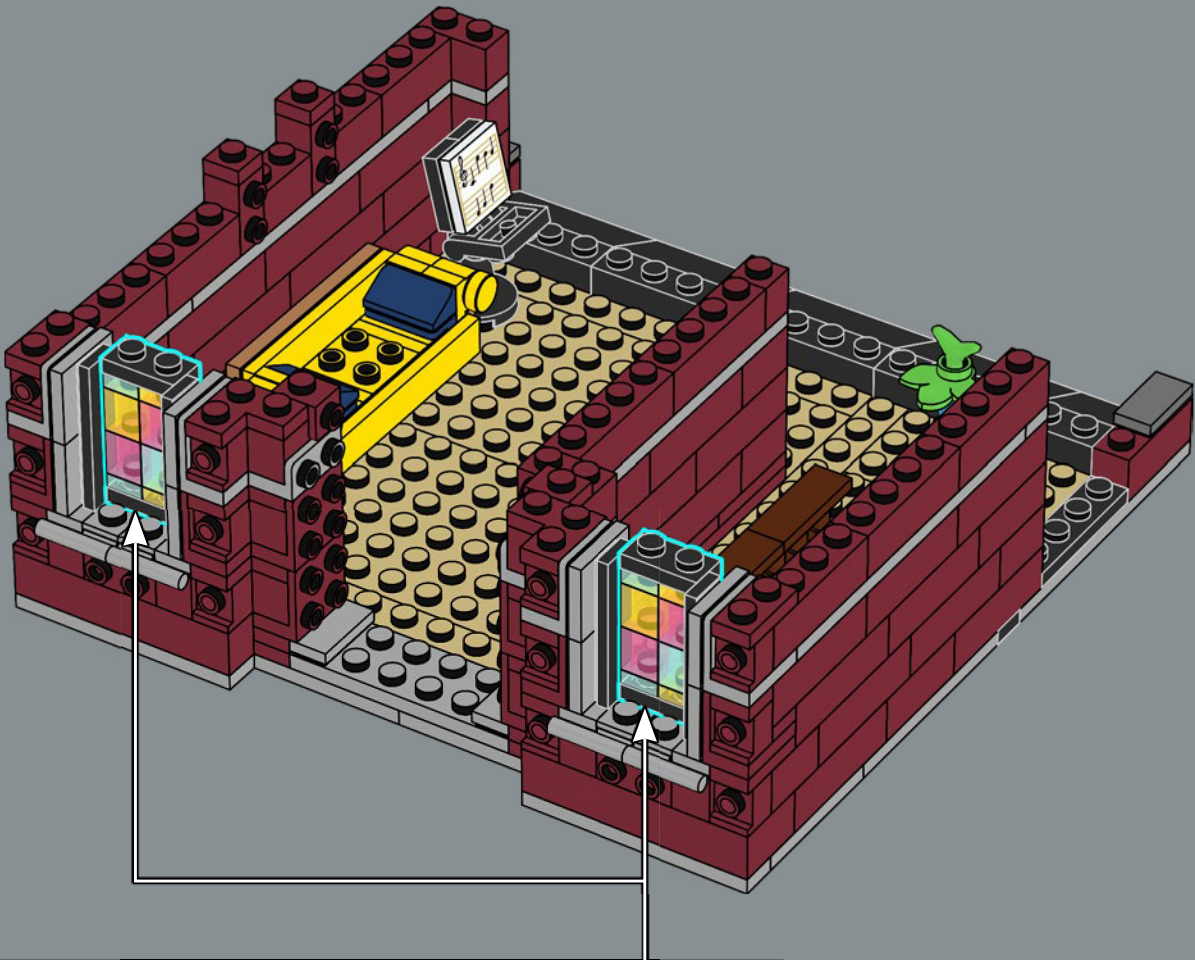

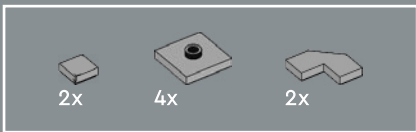

318

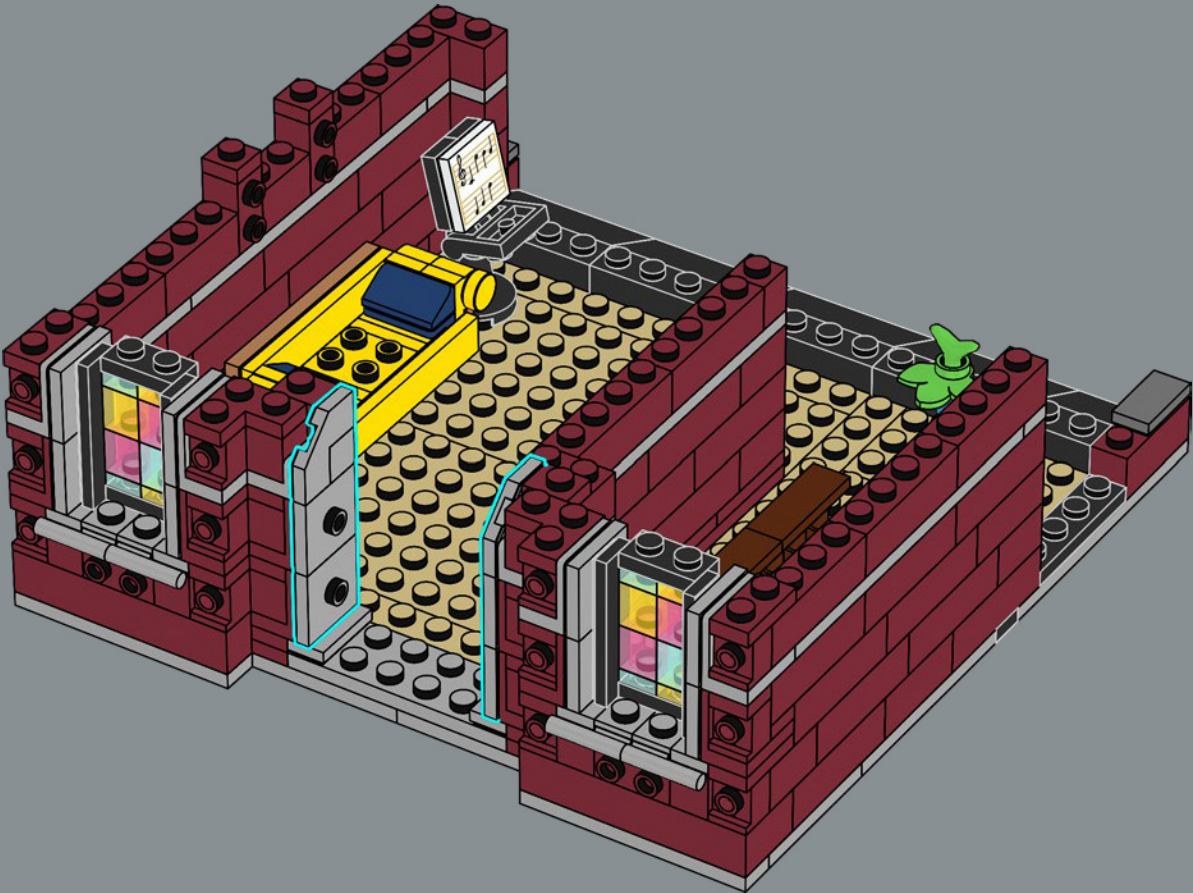

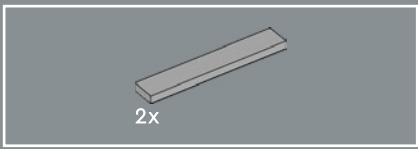

319

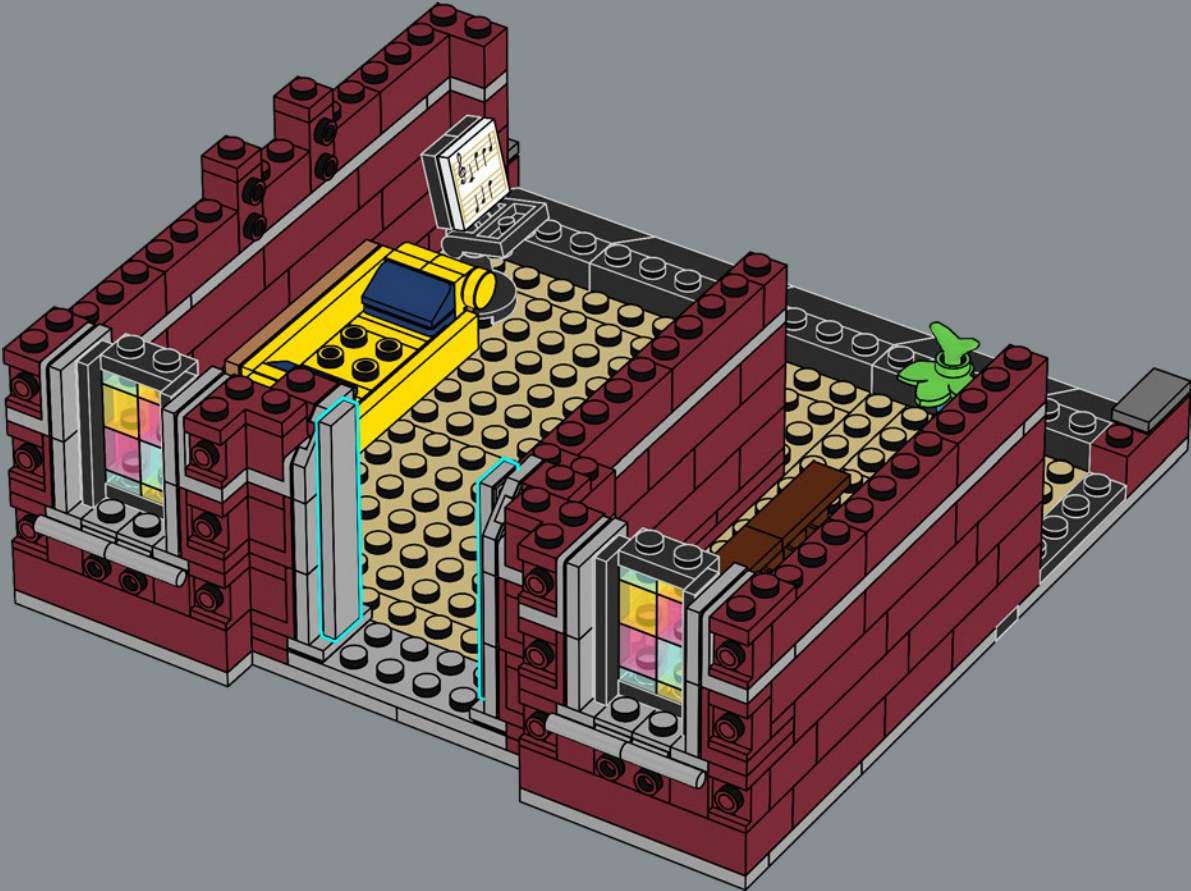

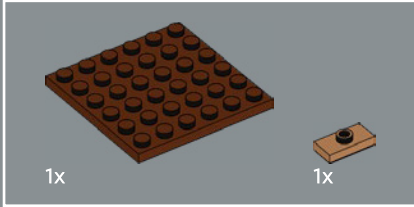
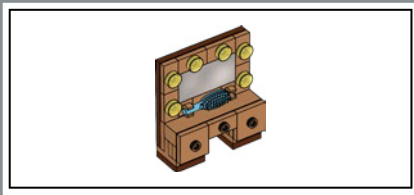

320

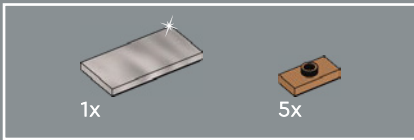
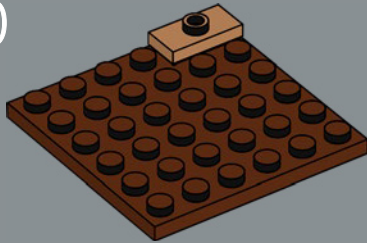

321

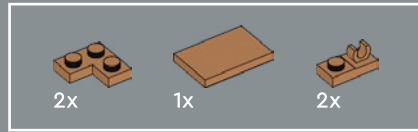
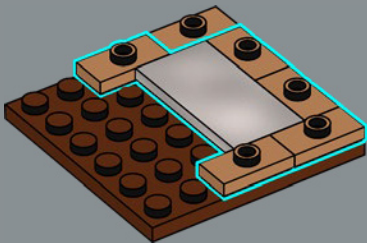

322

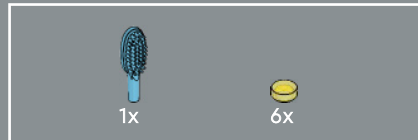
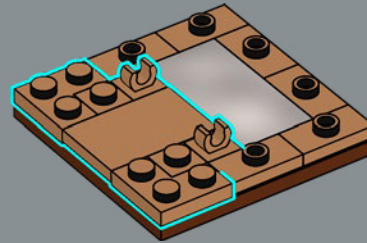

323

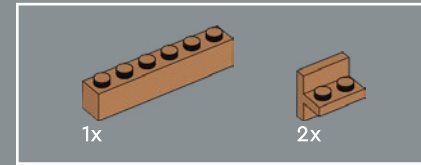
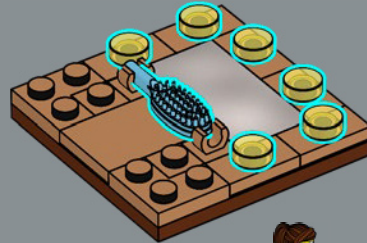

324

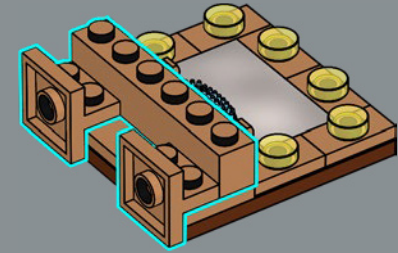

325

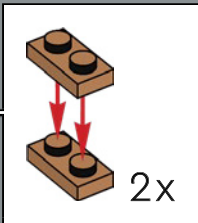
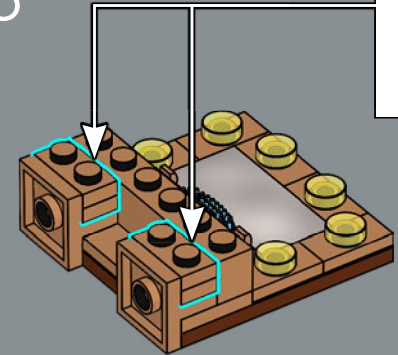

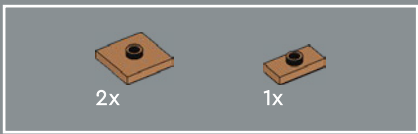

326

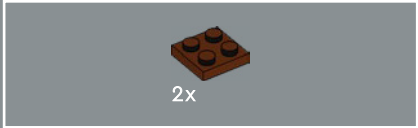
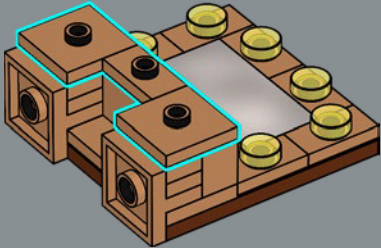

327

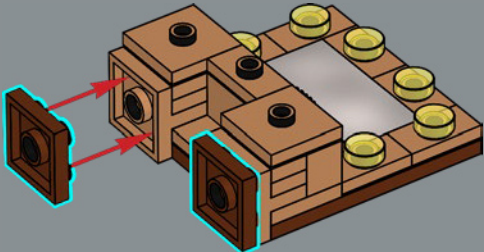

328

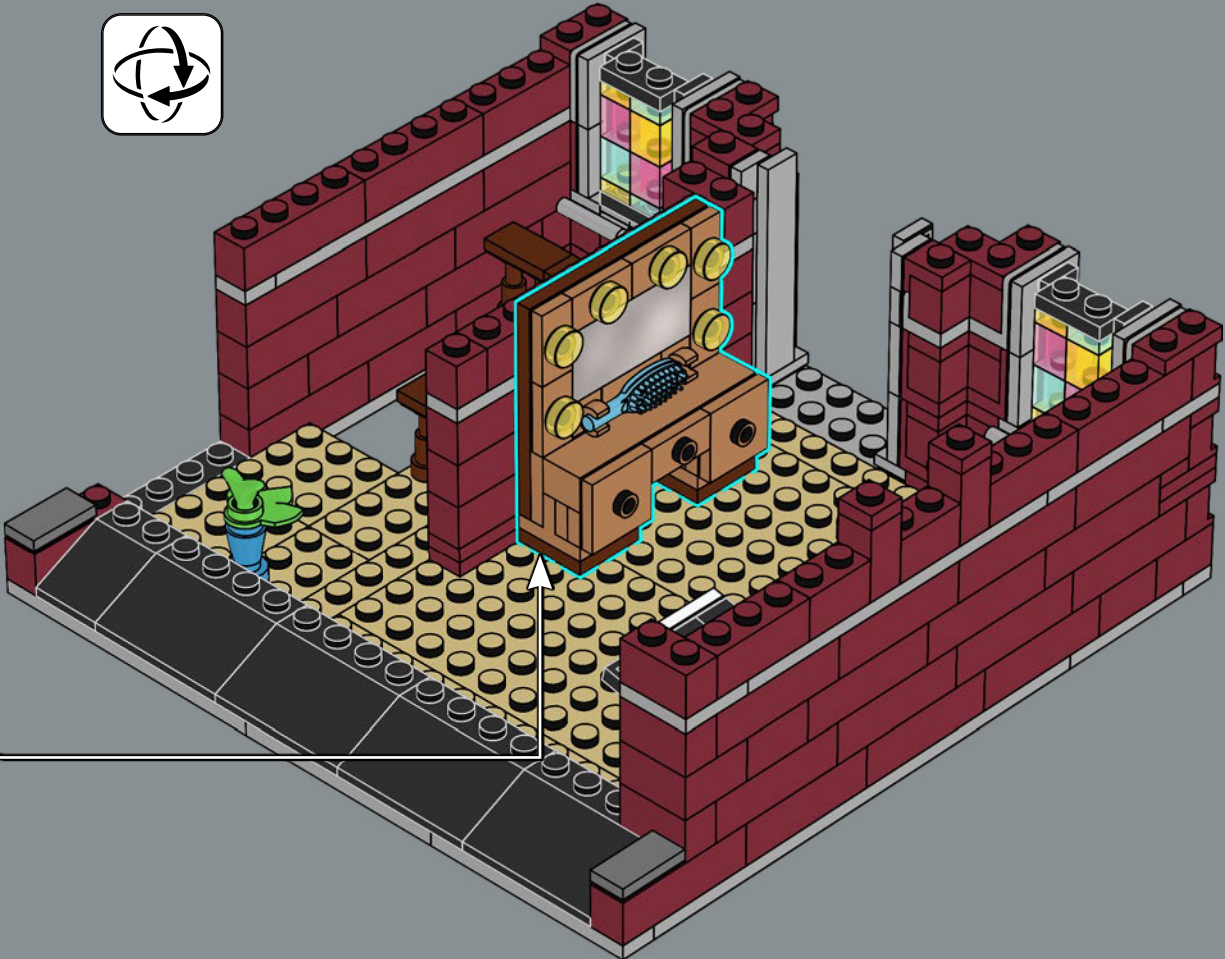

Before you take the stage, take a few minutes at the makeup table to be sure you will look your best under the bright lights.

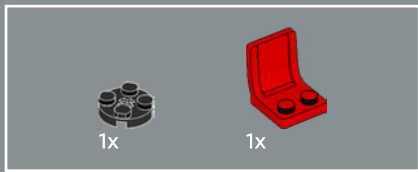

329

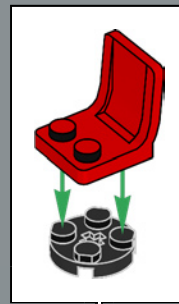

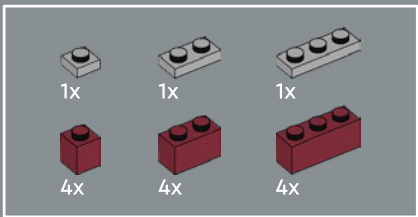

330

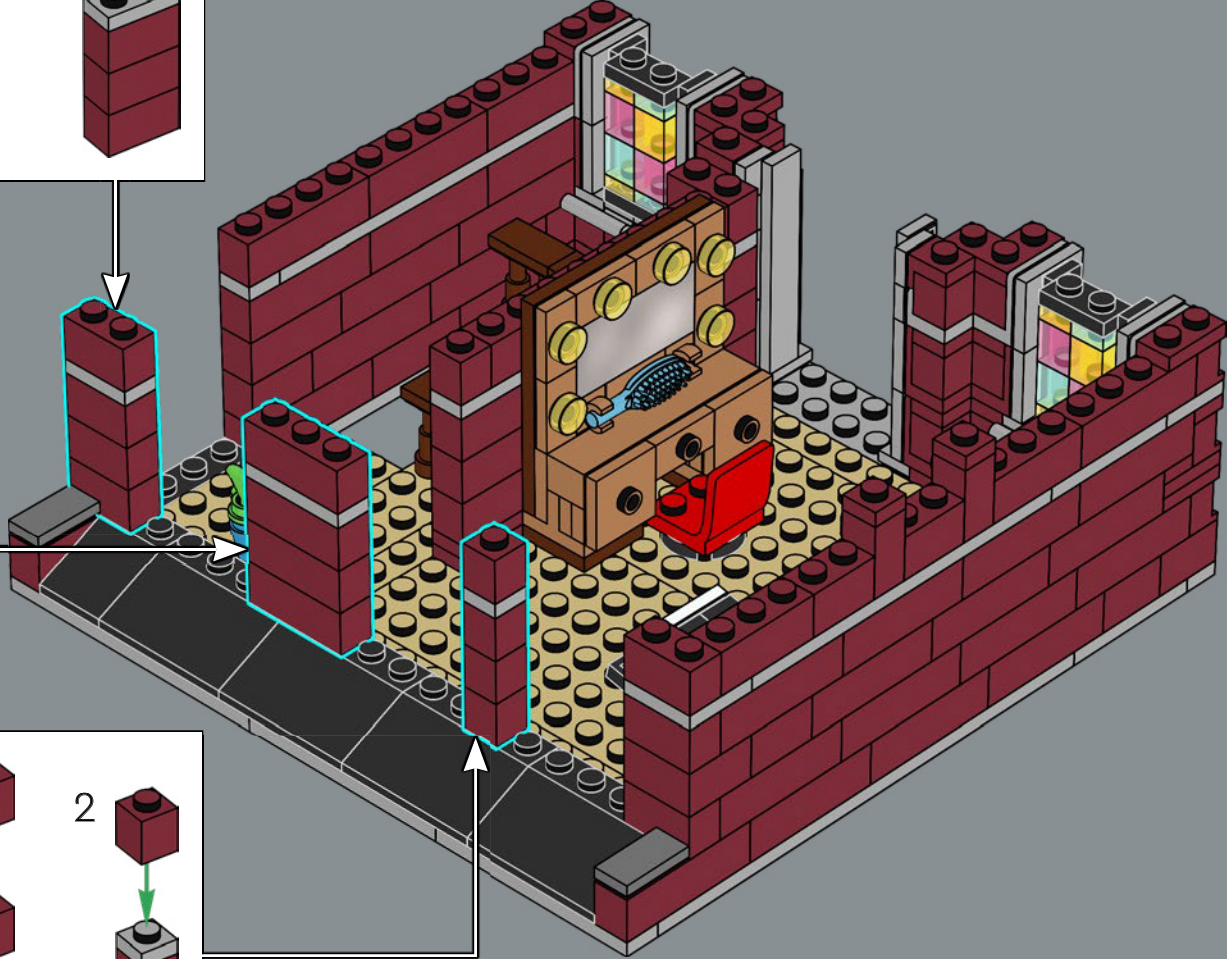
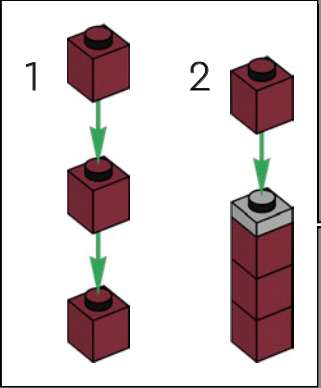
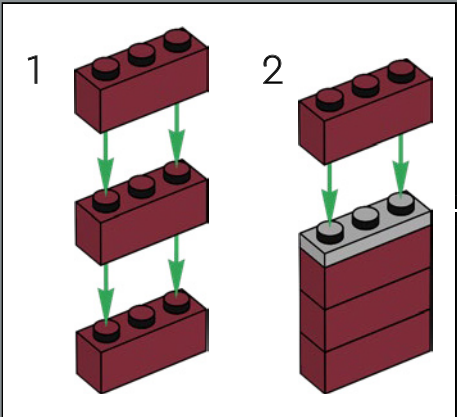
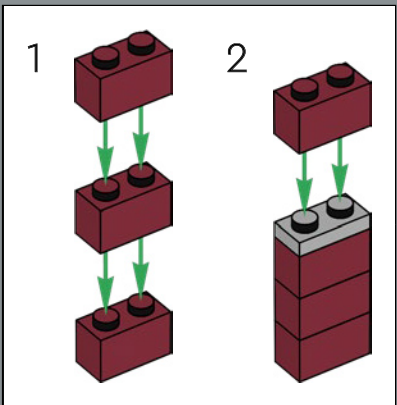

The magician found her trusty magical sidekick the rabbit at the LEGO® 10218 Pet Shop.

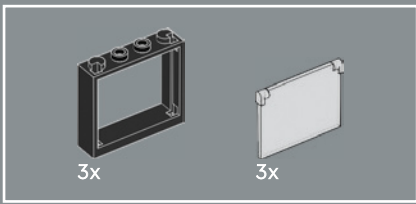

331

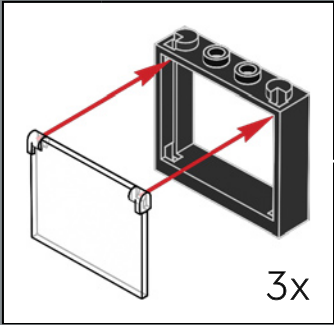
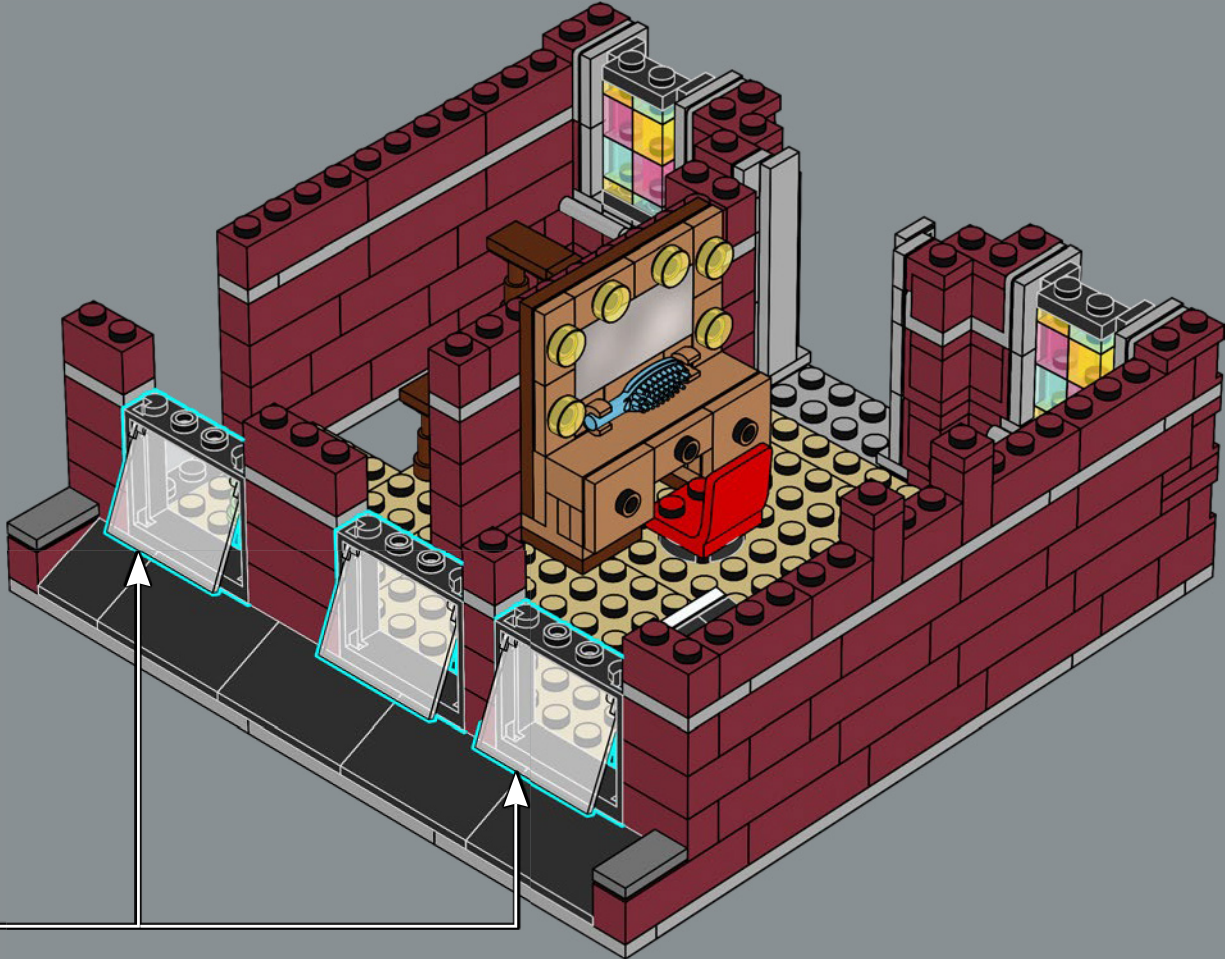

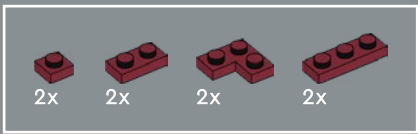

332

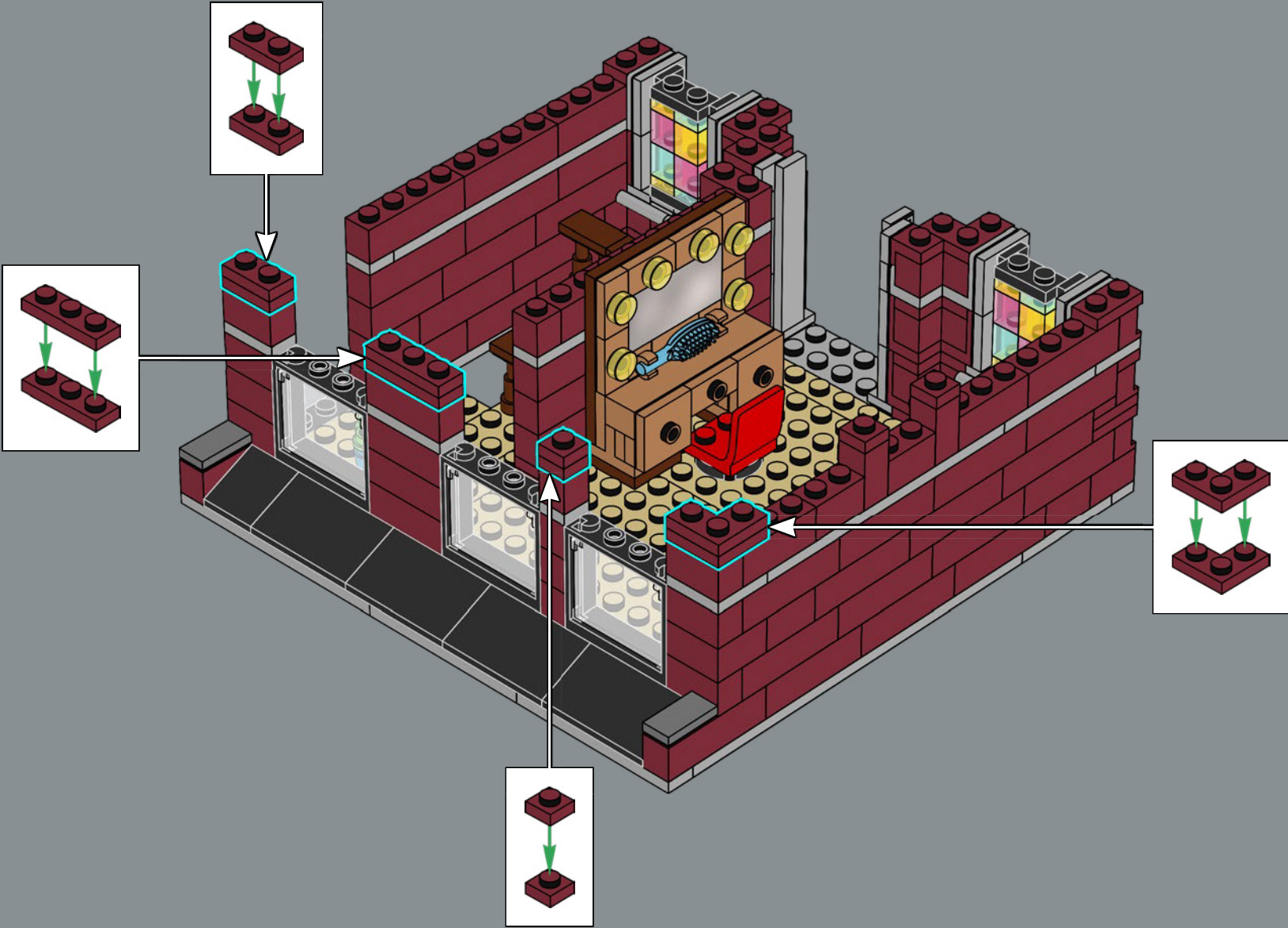

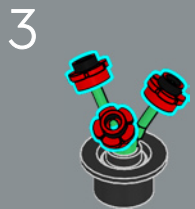
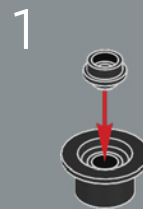
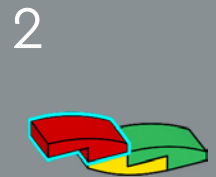
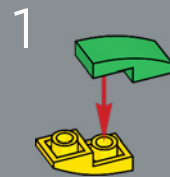
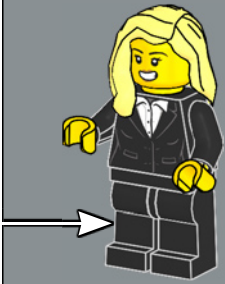
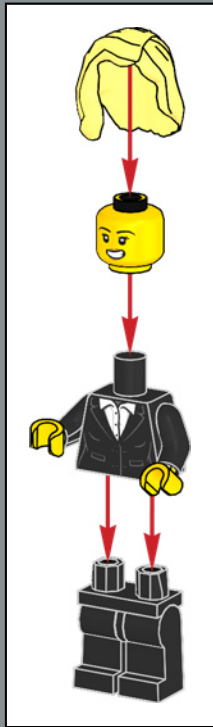

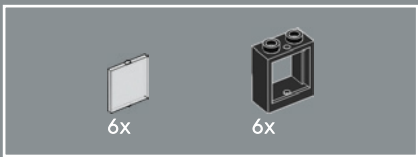

333

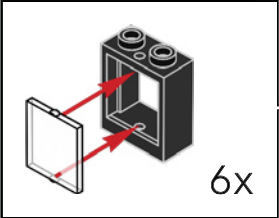
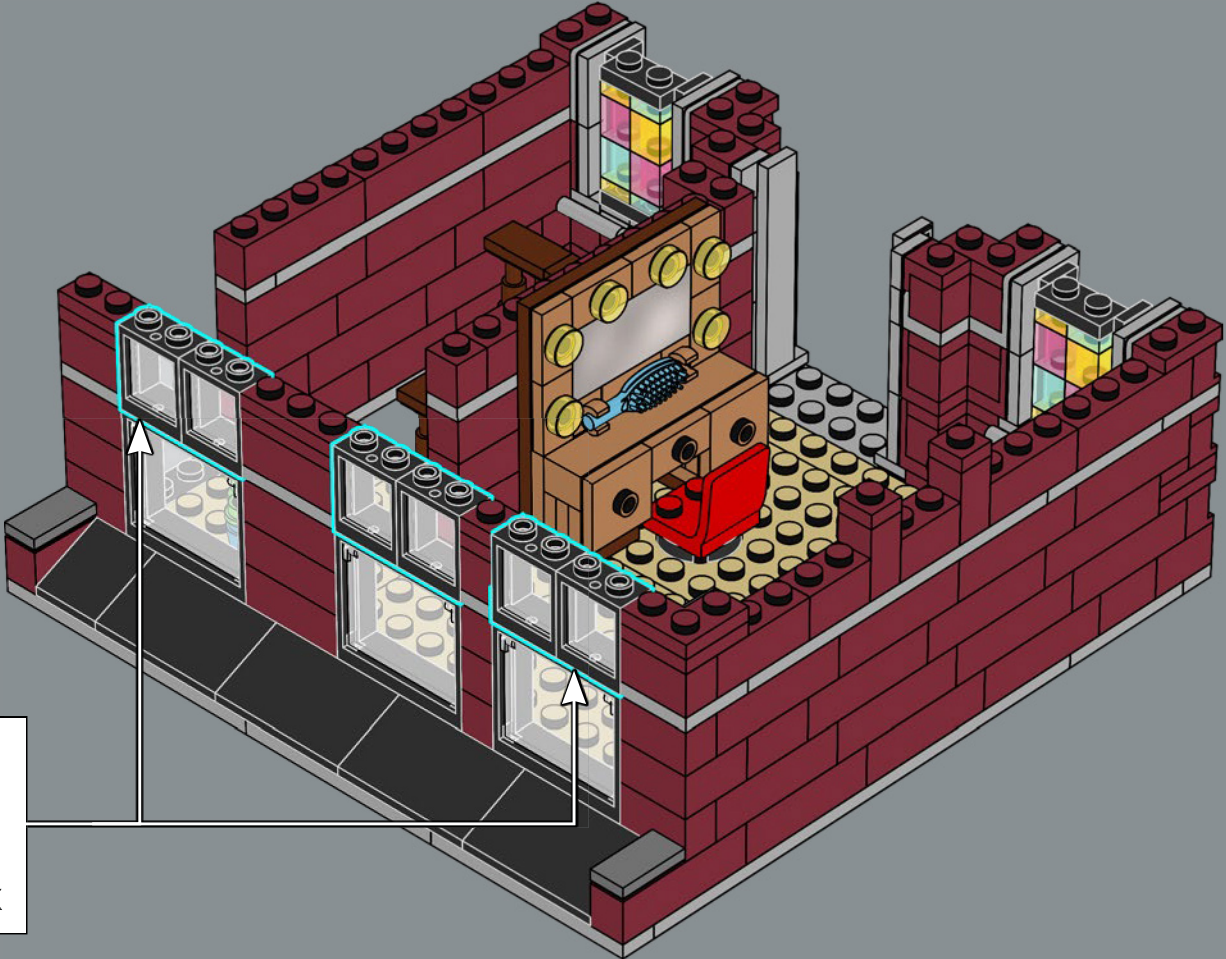

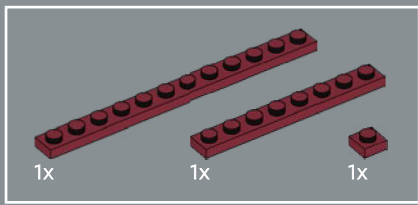

334



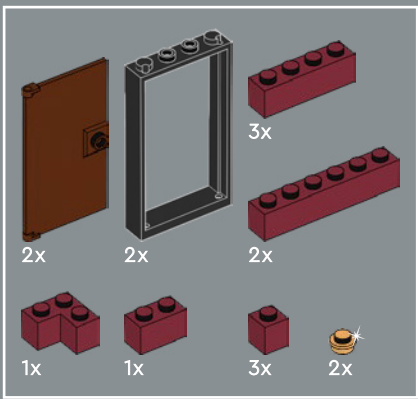

335

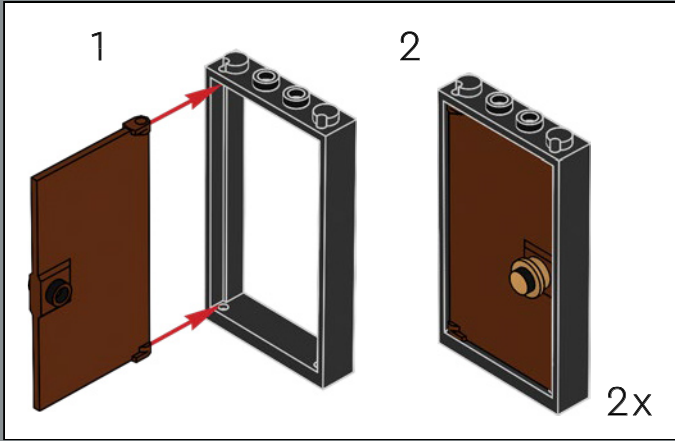

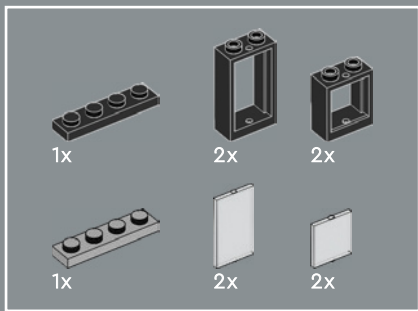

336

1

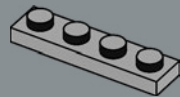

2

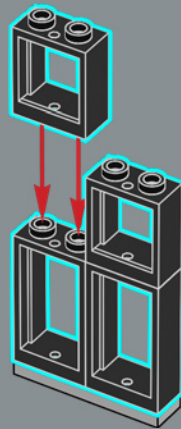

3

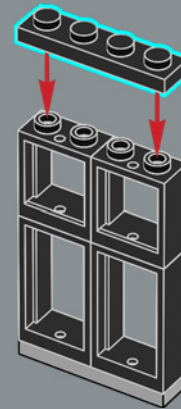

4

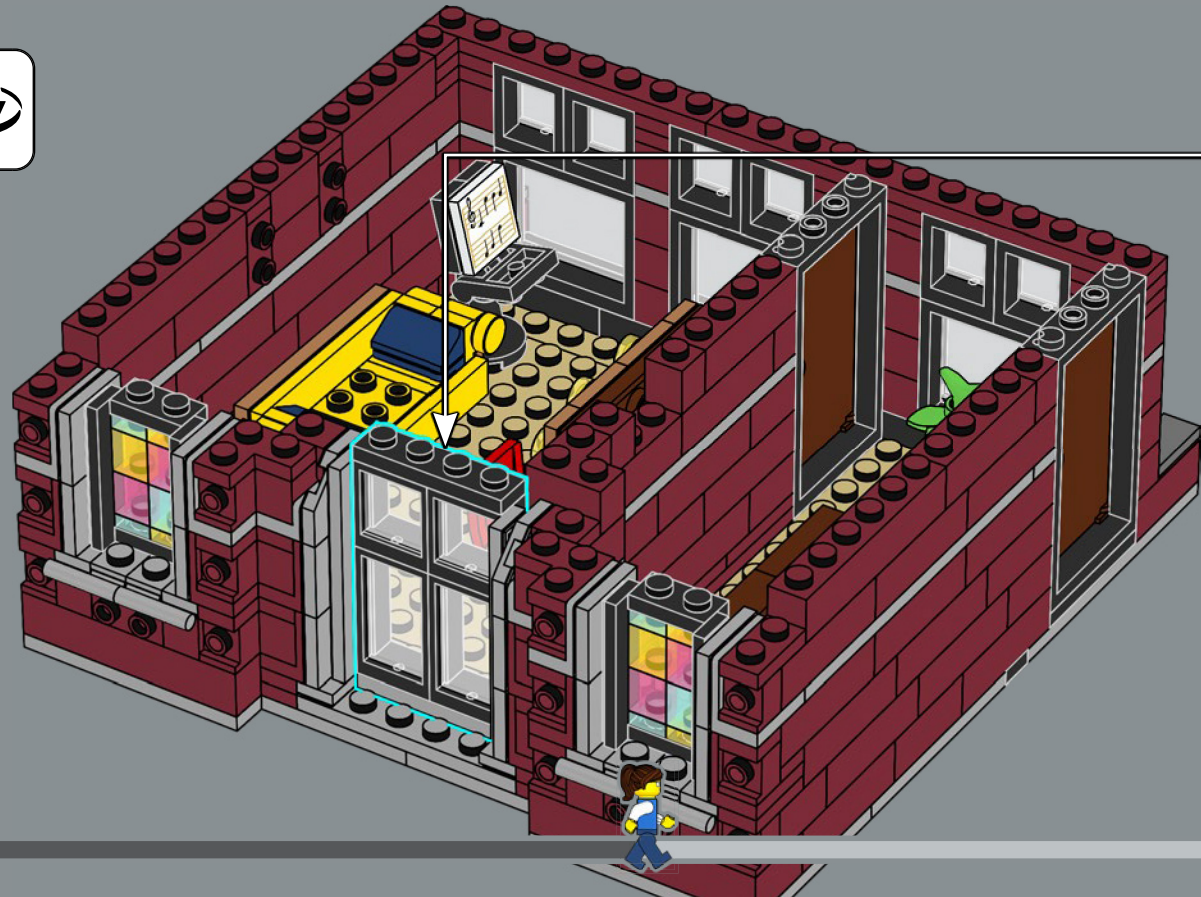
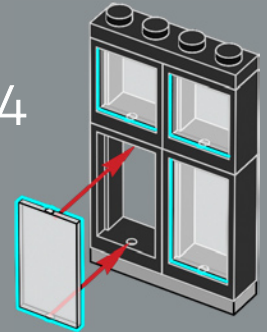

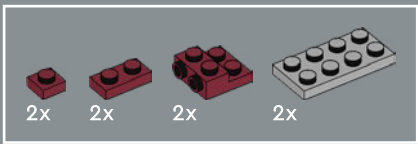

337

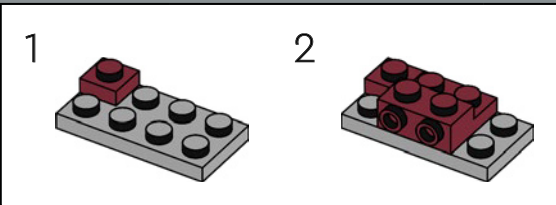
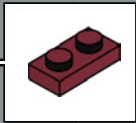
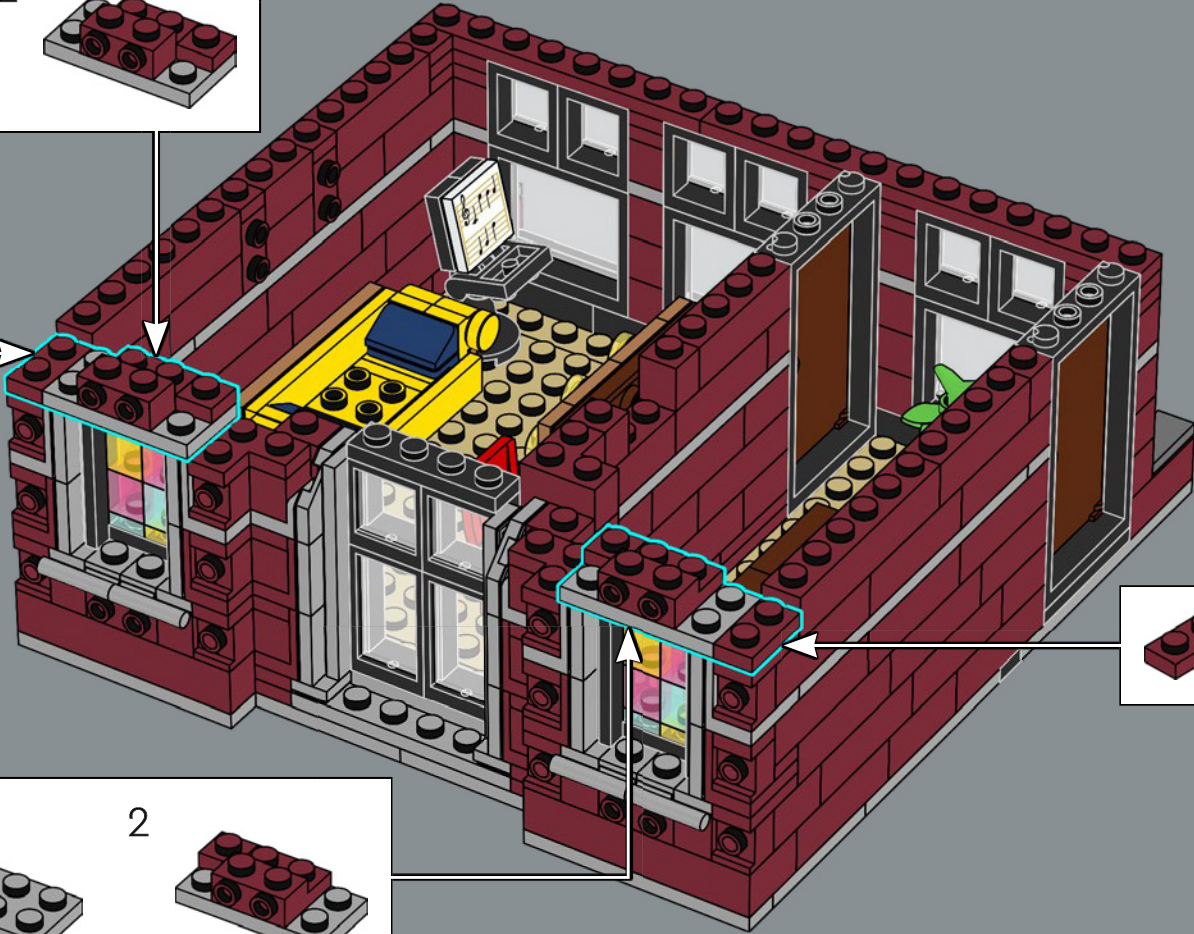
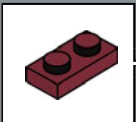
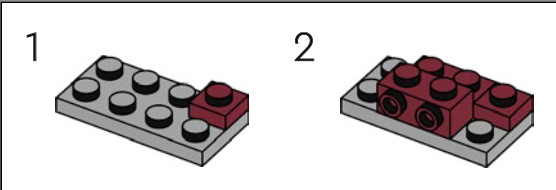

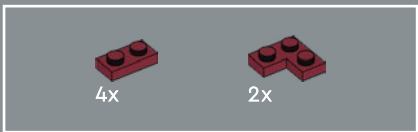

338

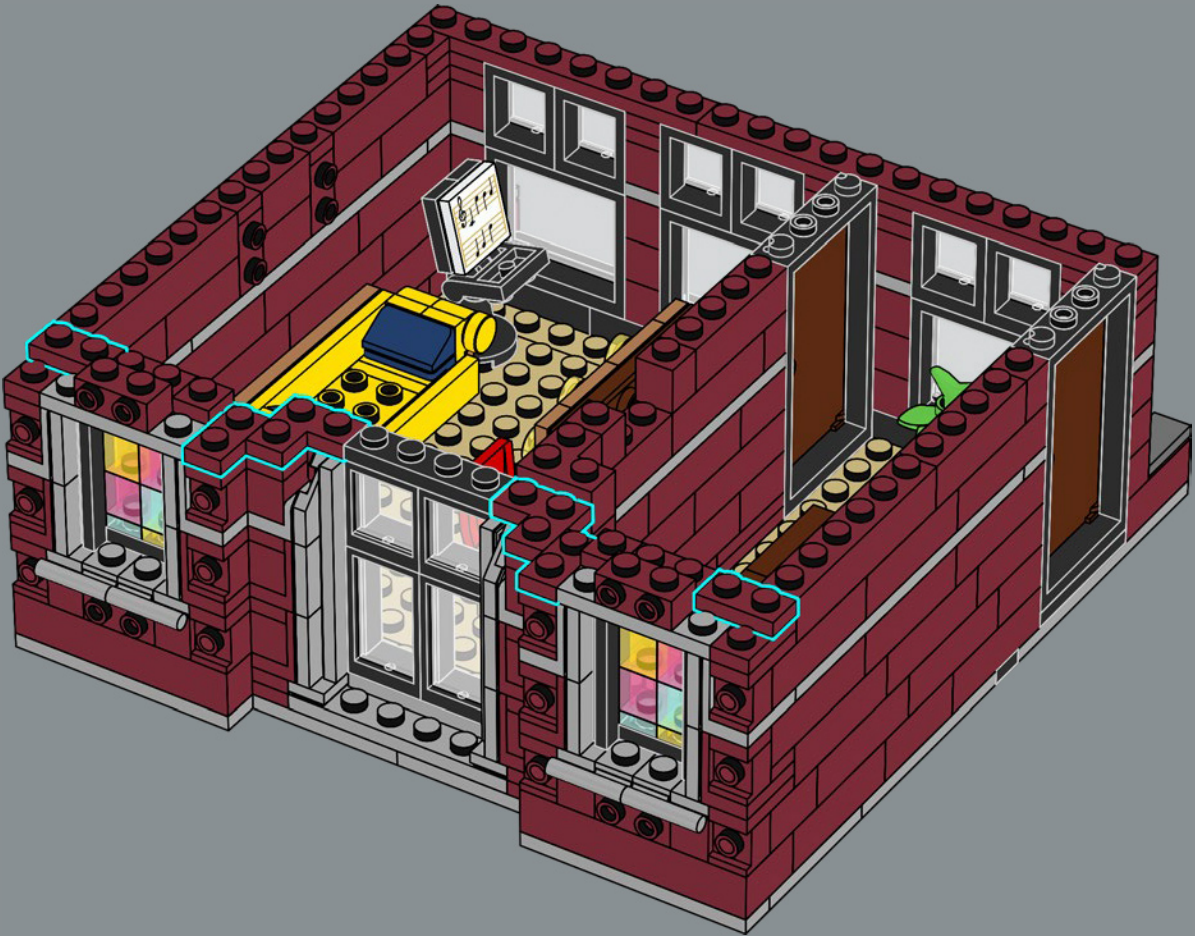

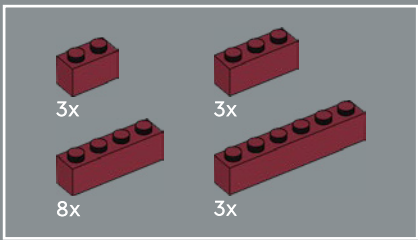

339

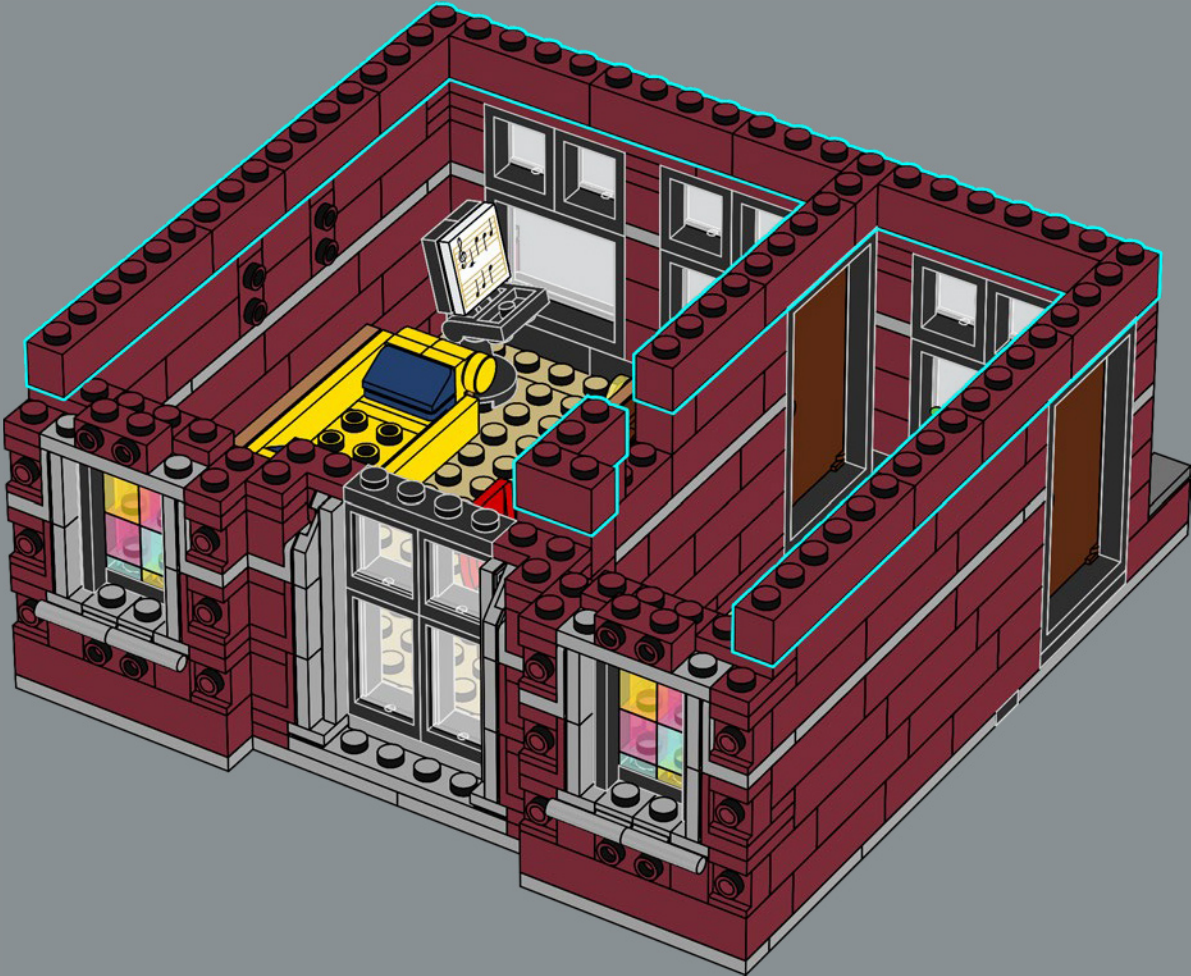

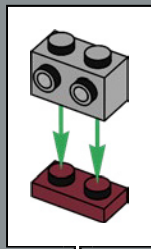
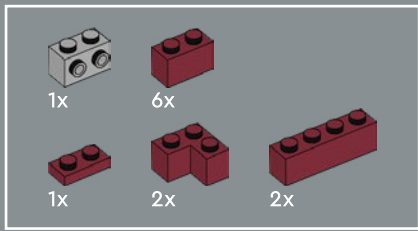

340

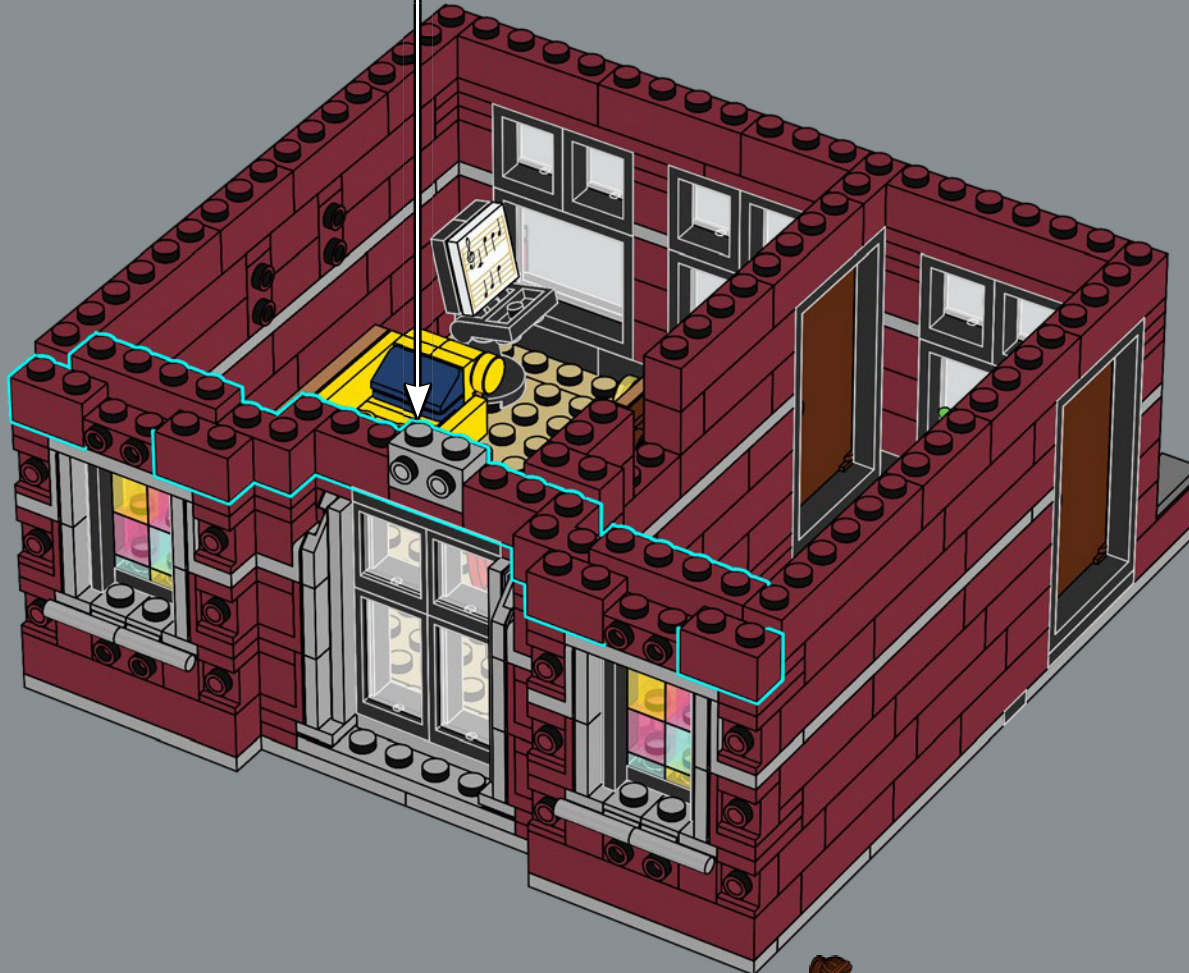

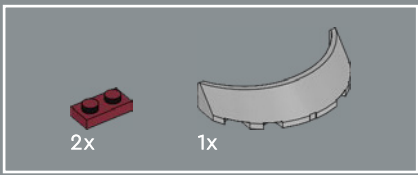

341

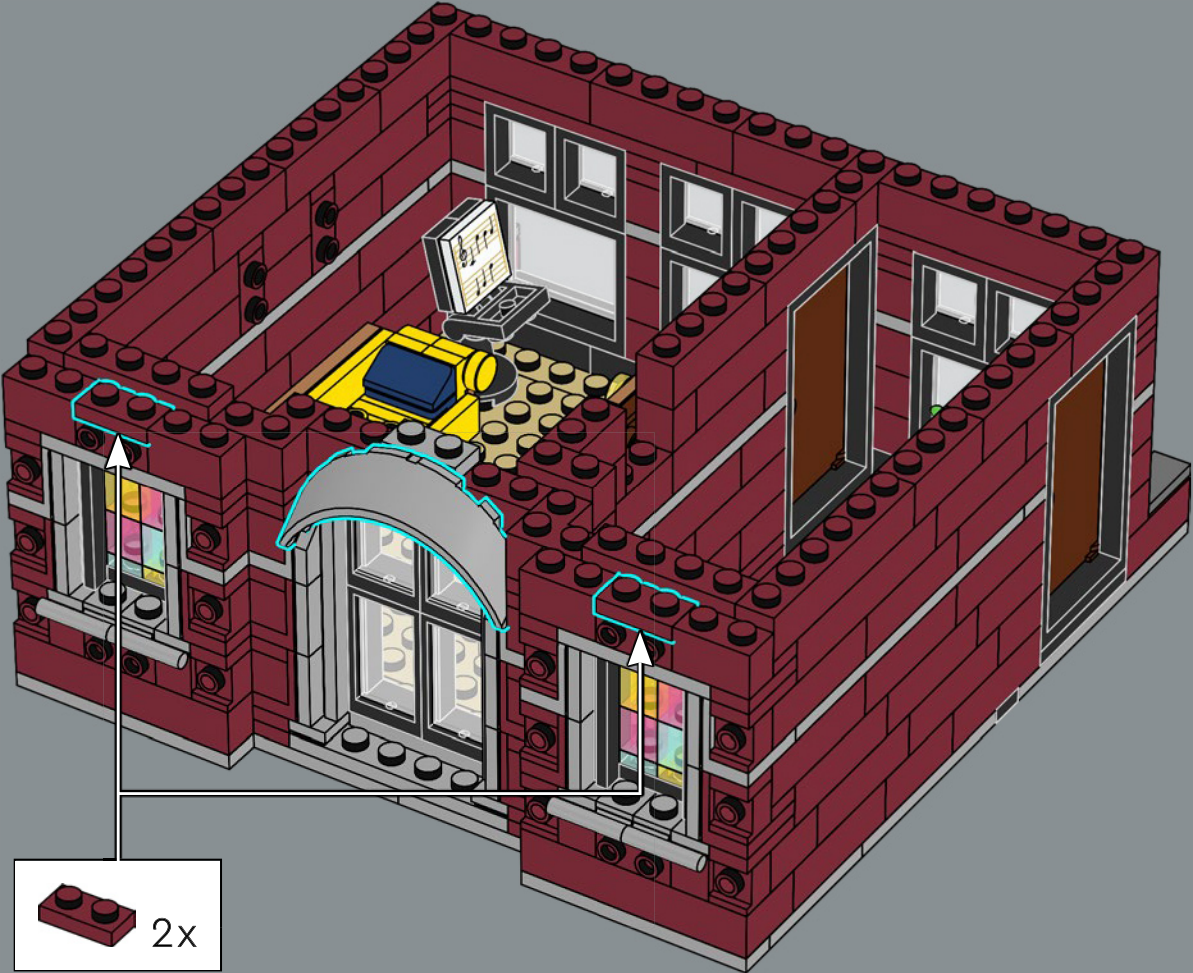

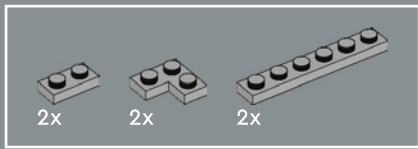

342

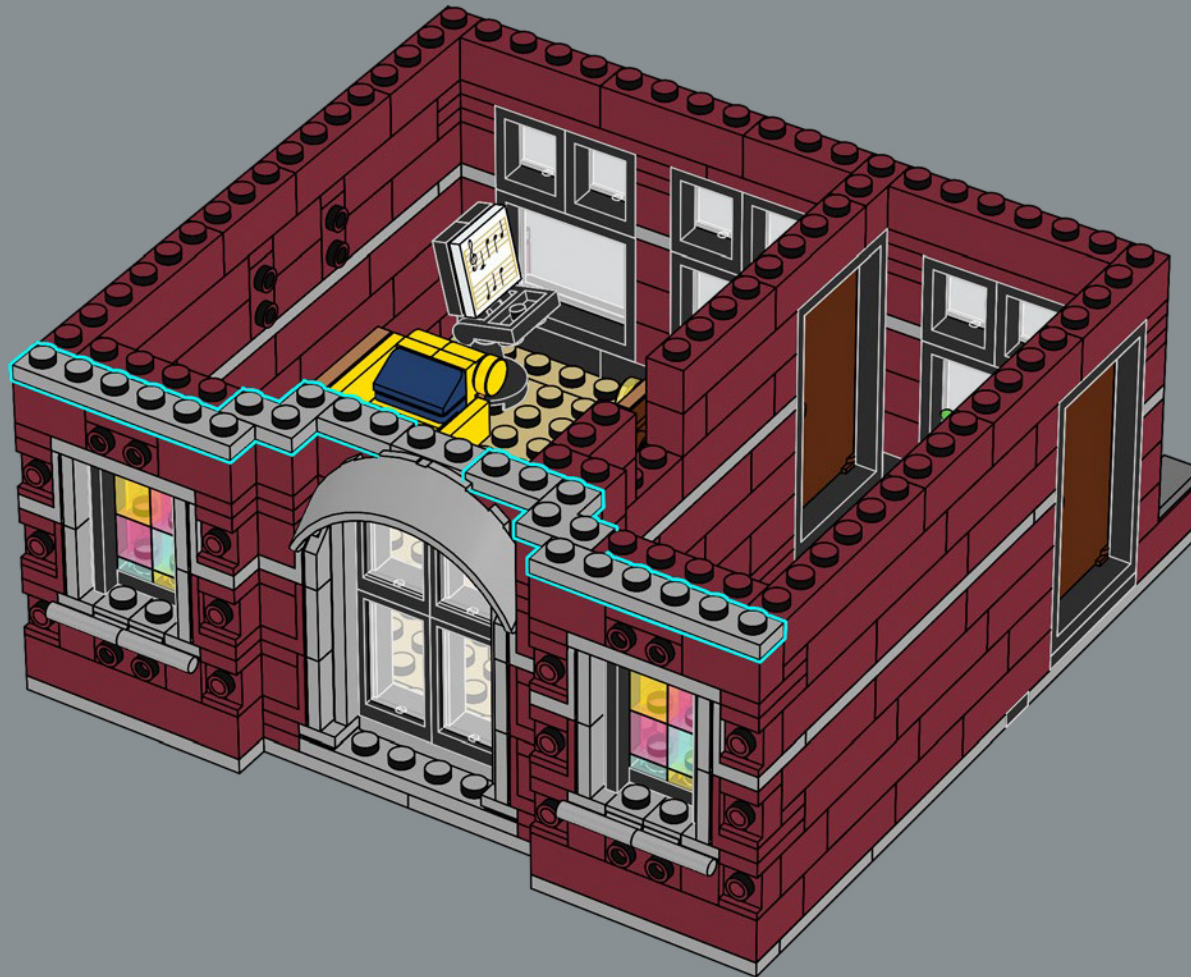

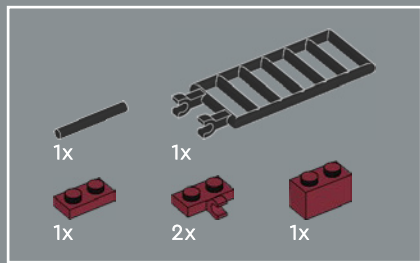

343

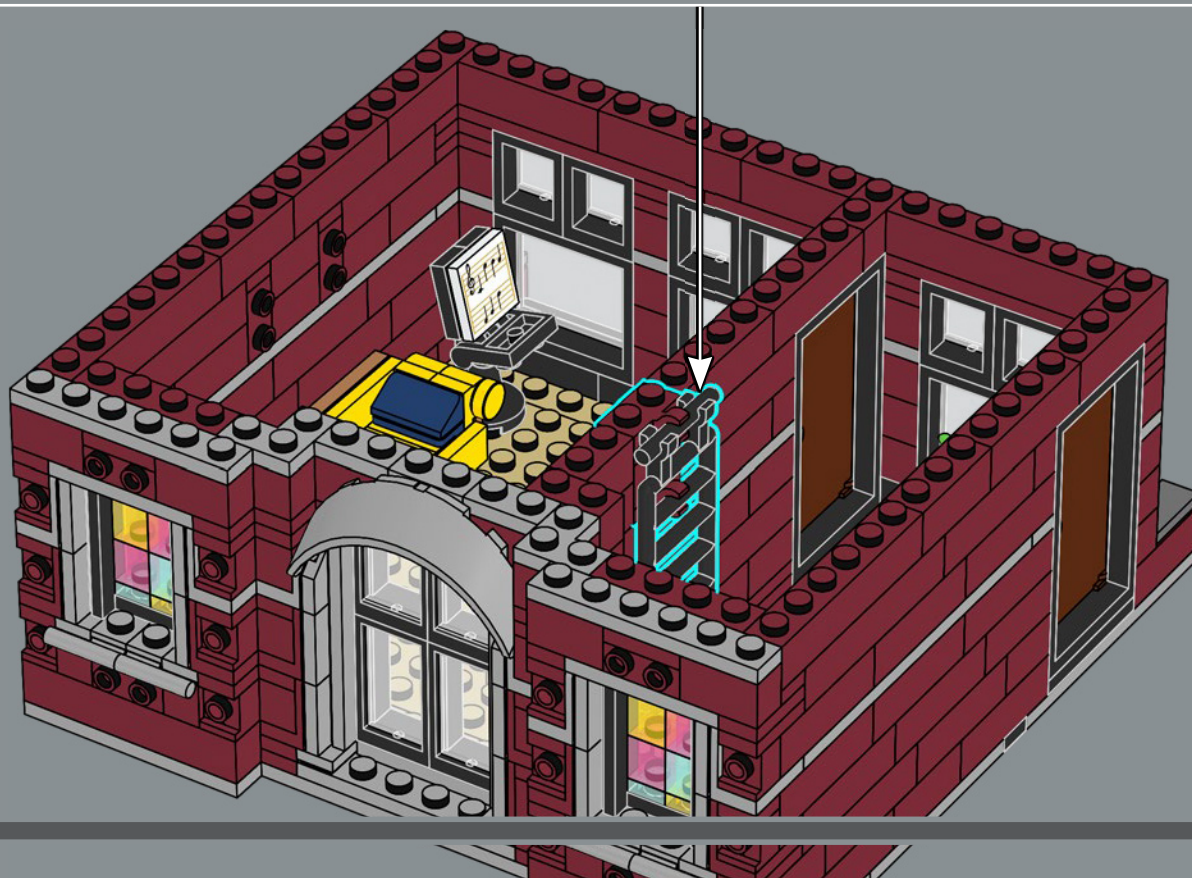
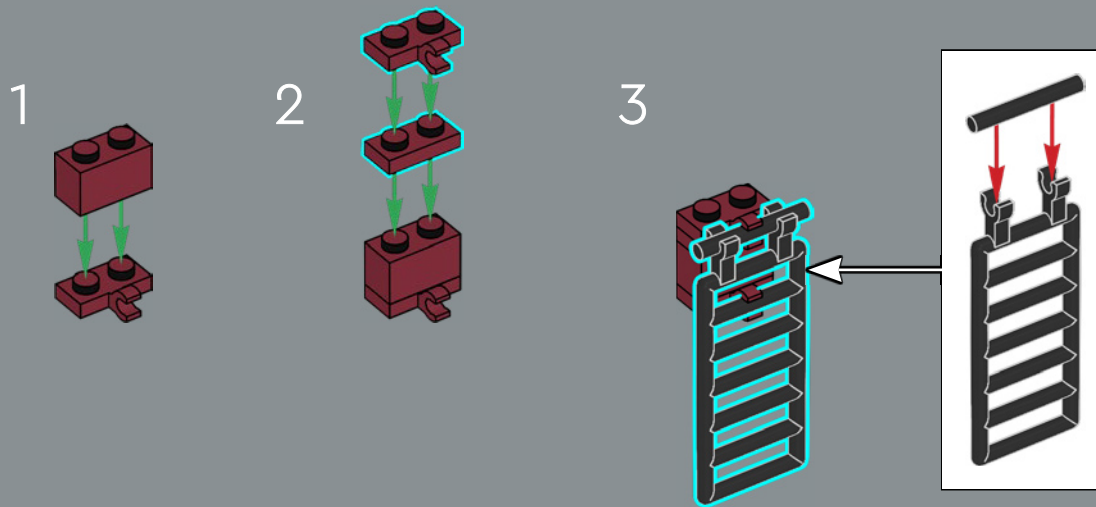

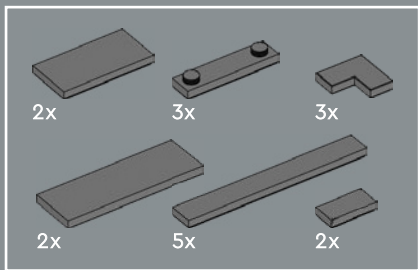

344

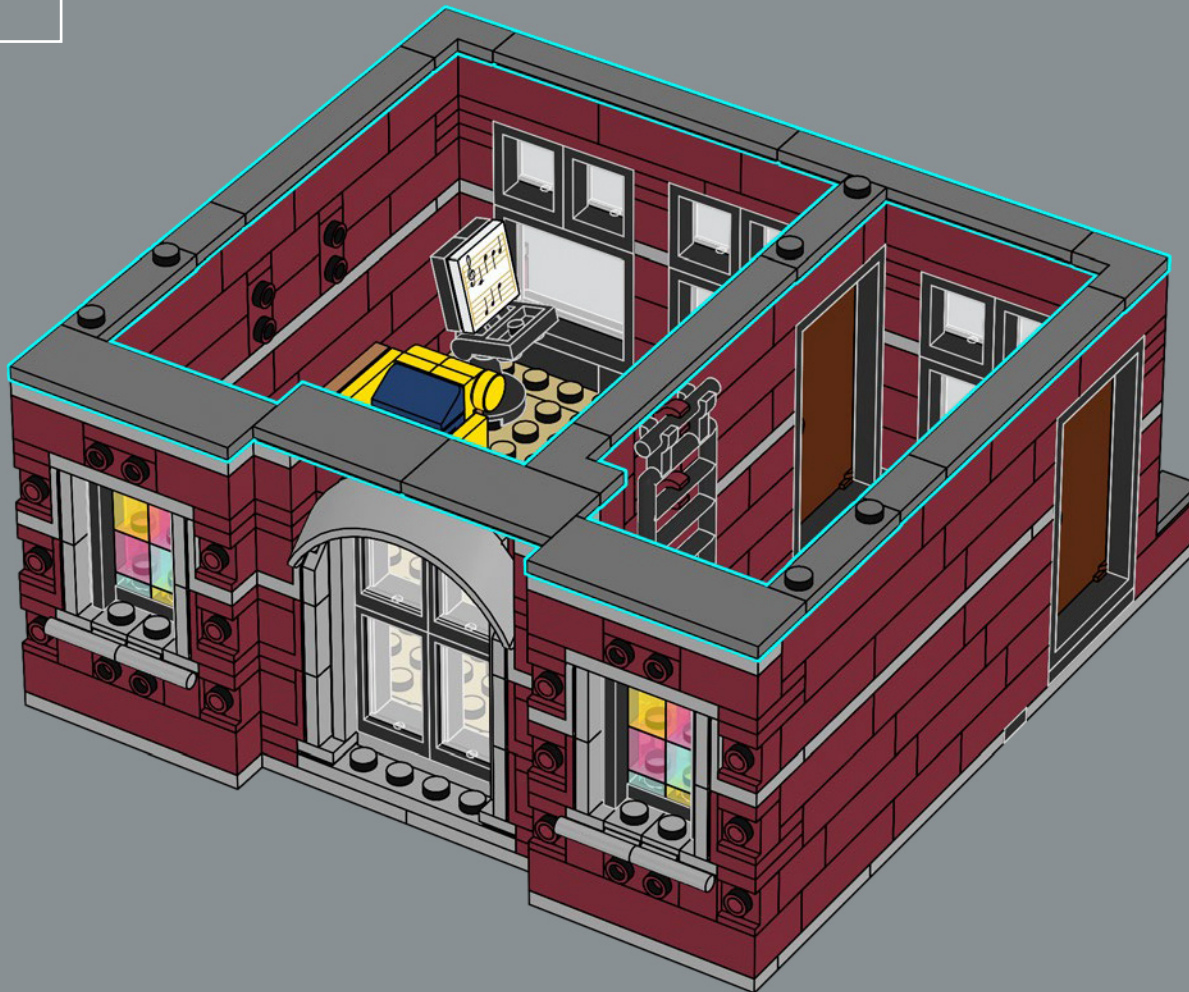

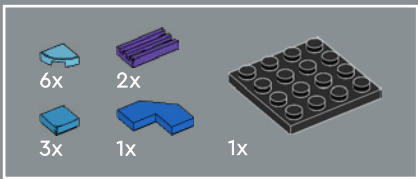

345

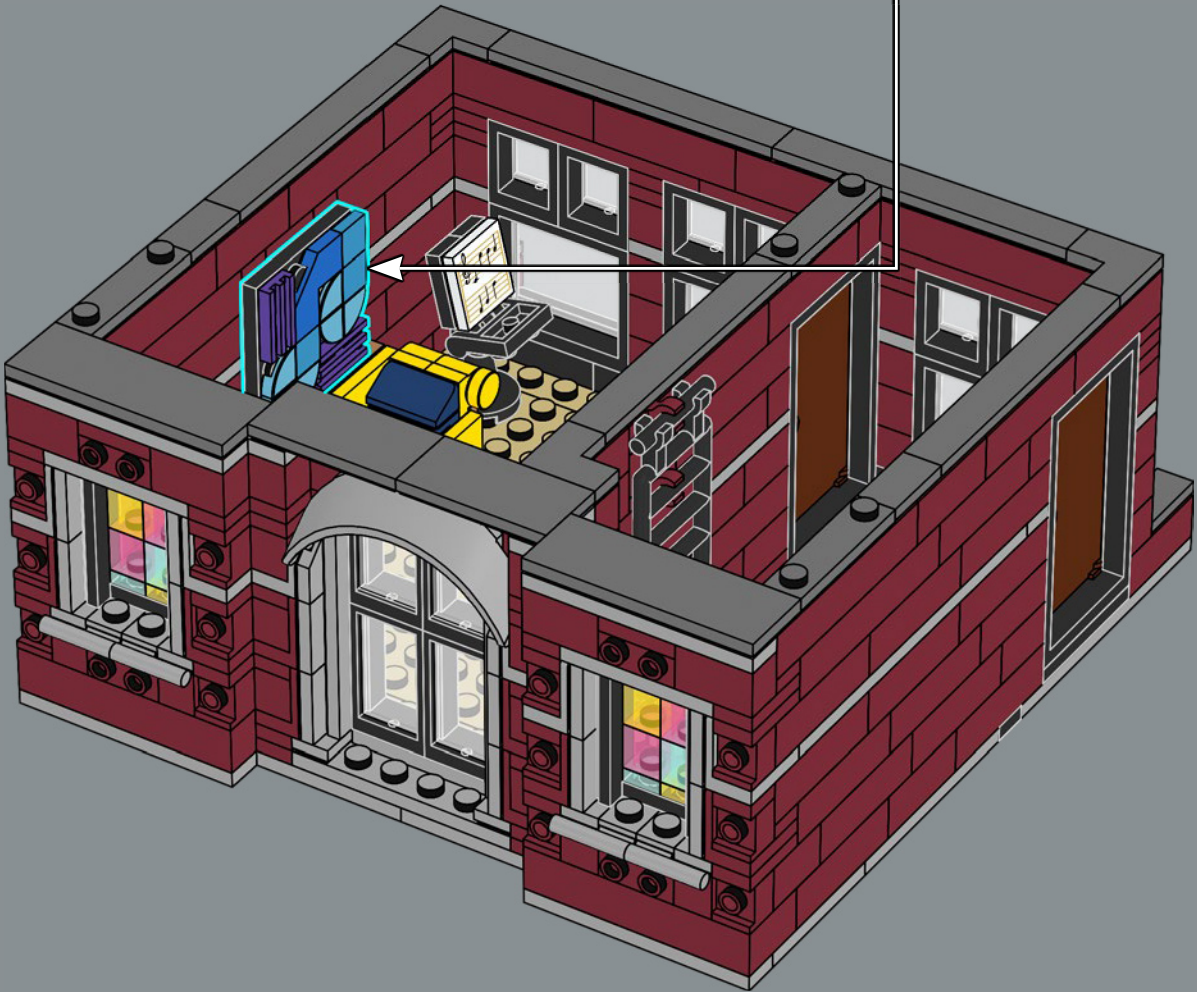
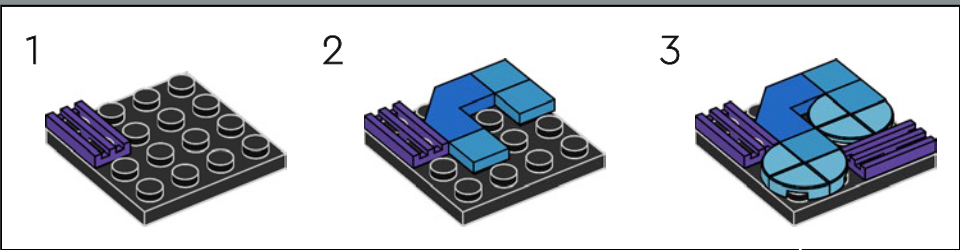

This painting of 'The Blues' was sold just down the street, at the Art Gallery in the LEGO® 10297 Boutique Hotel.

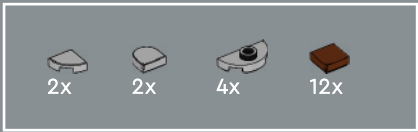

346

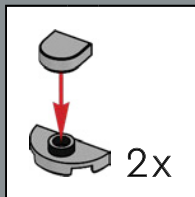
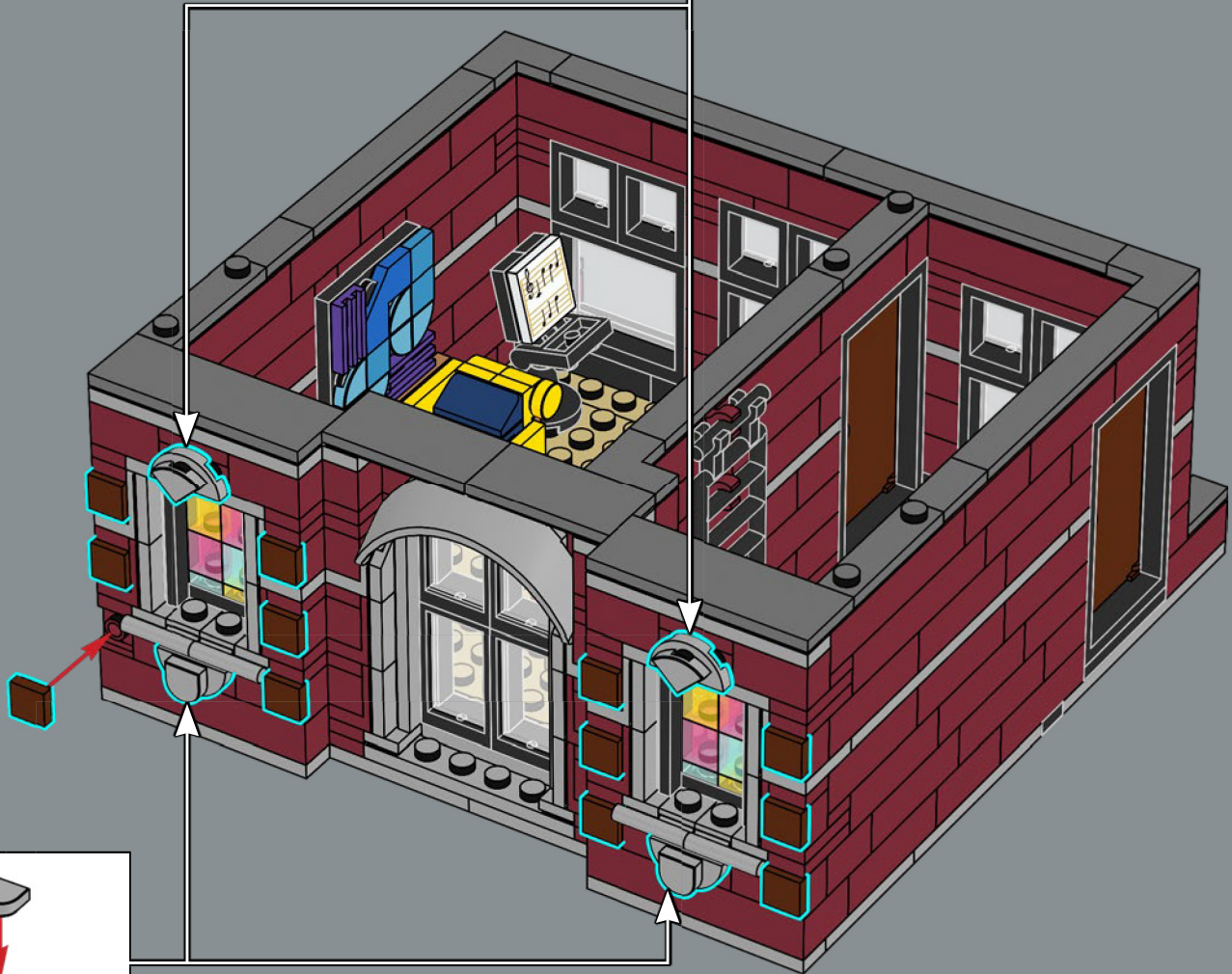
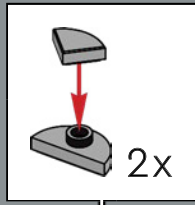

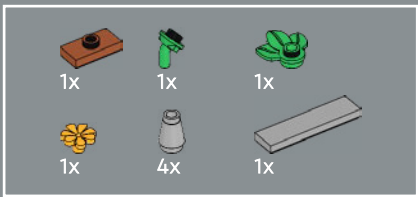

347

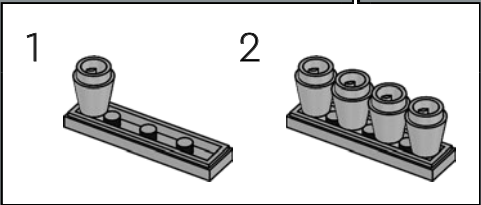
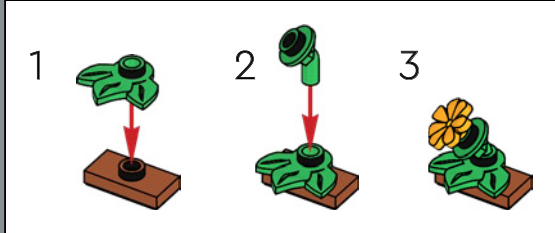
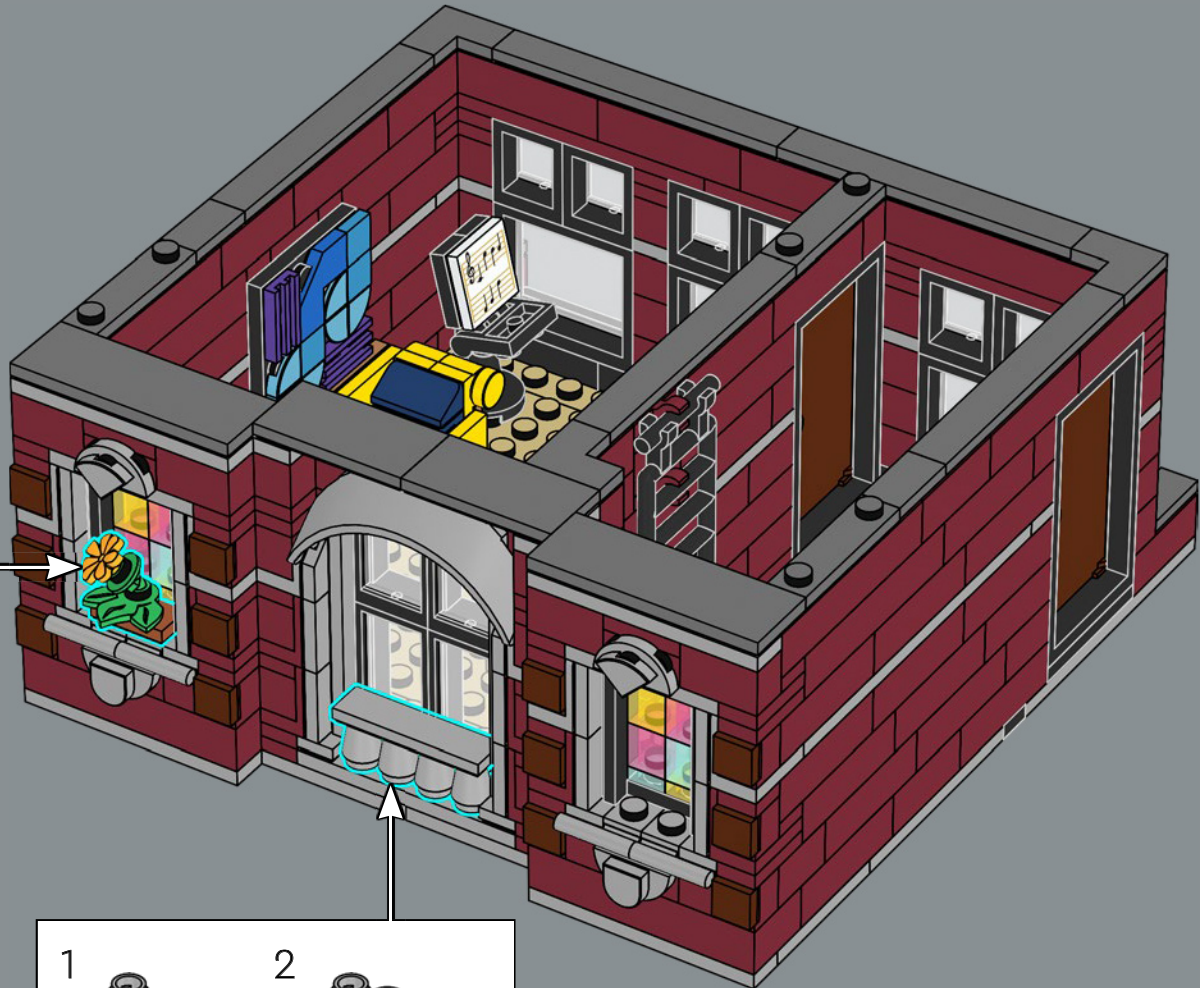

348



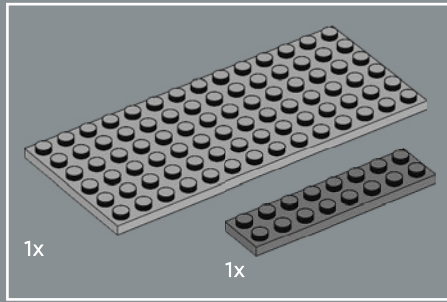

349

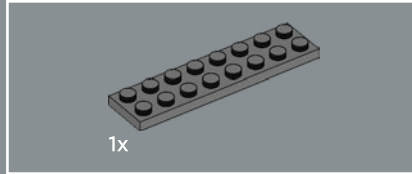
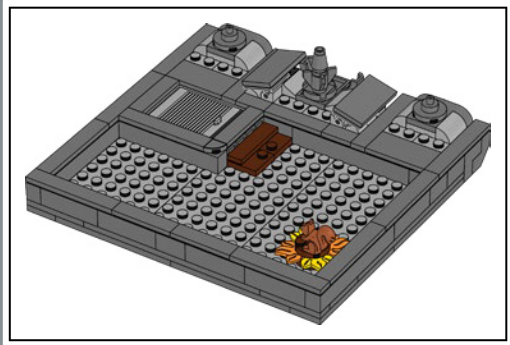
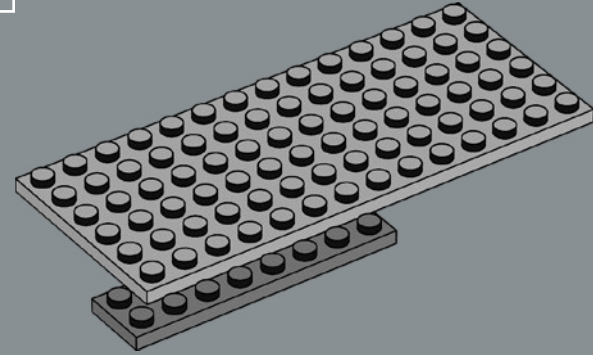

350

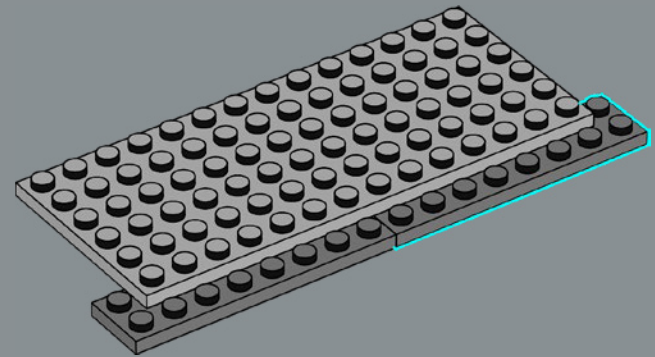

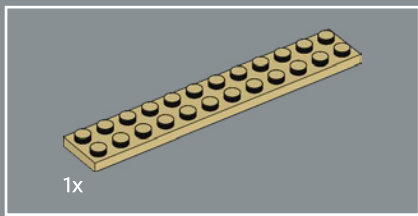

351

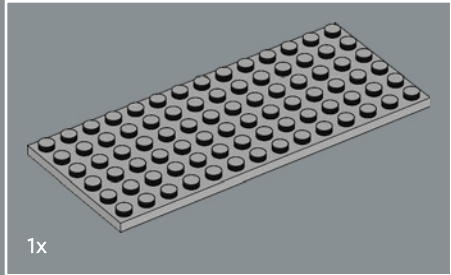
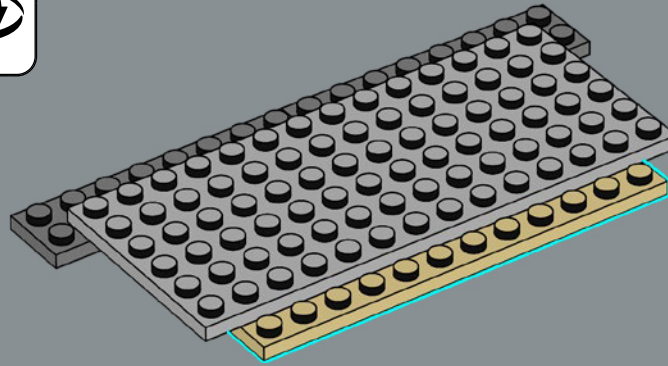

352

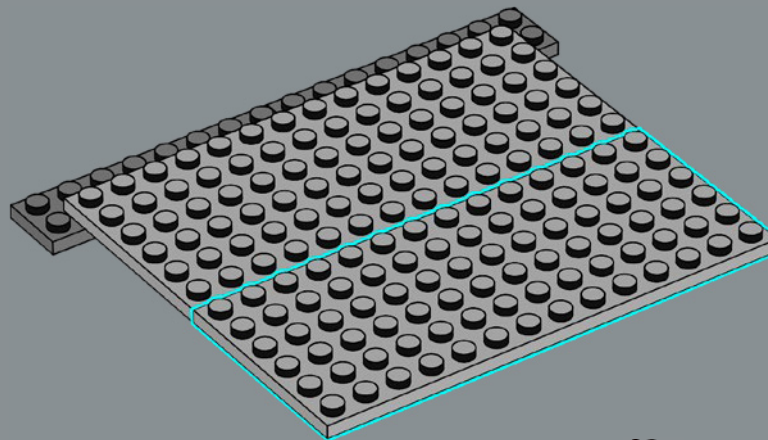

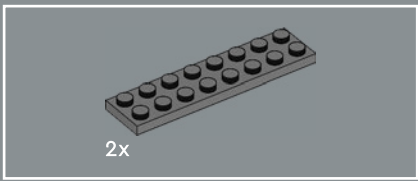

353

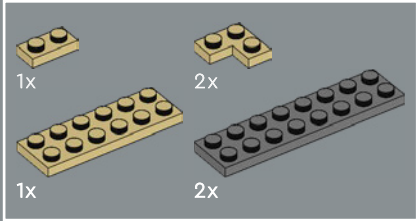
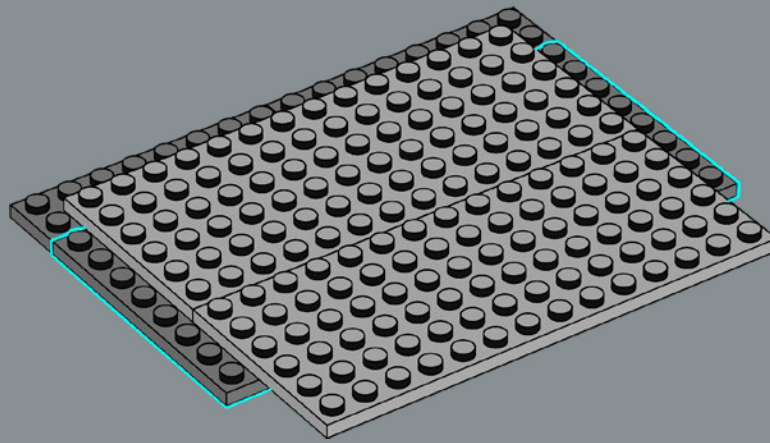

354

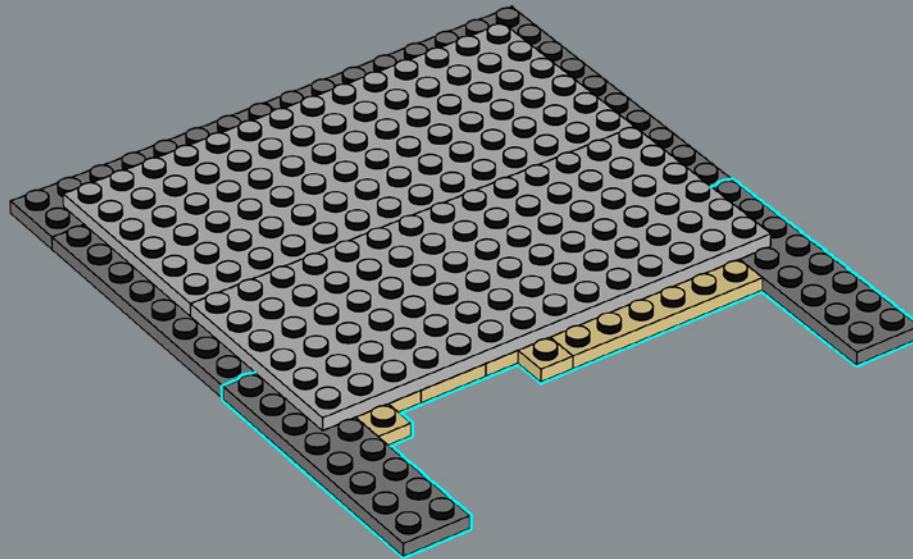

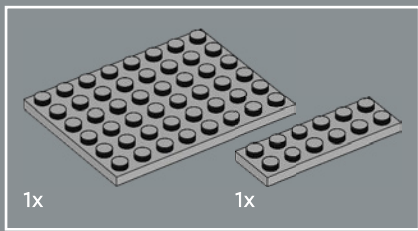

355

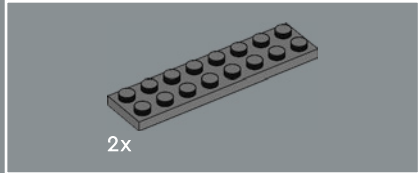
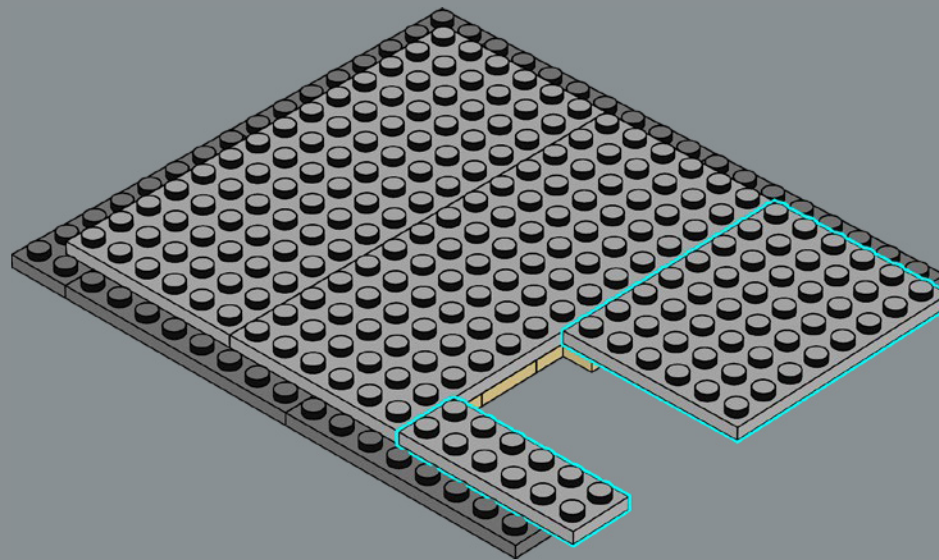

356

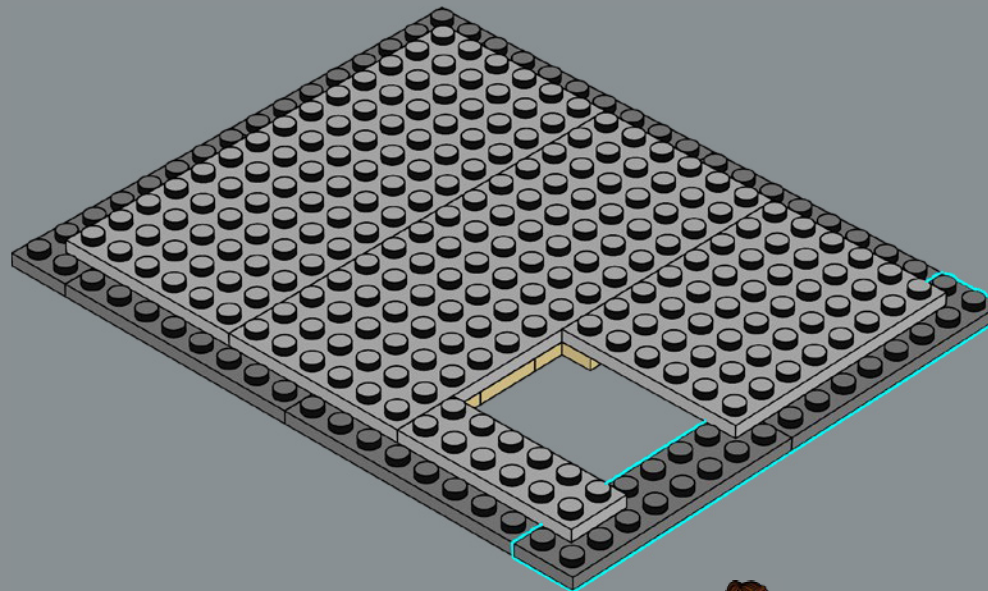

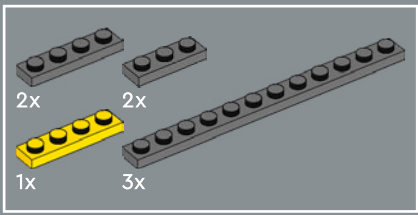

357

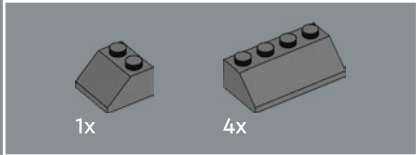
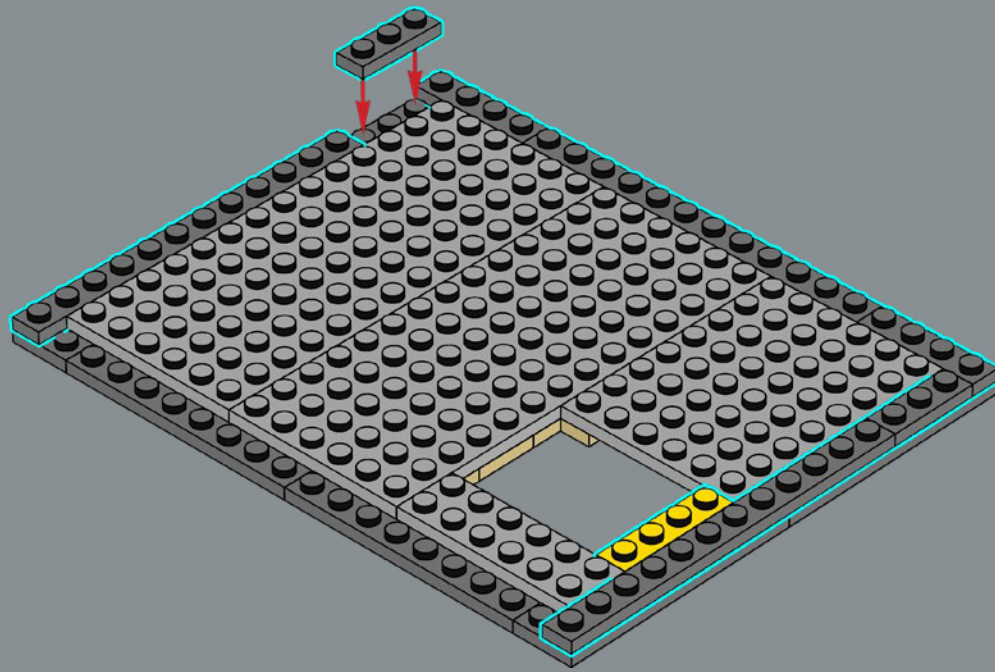

358

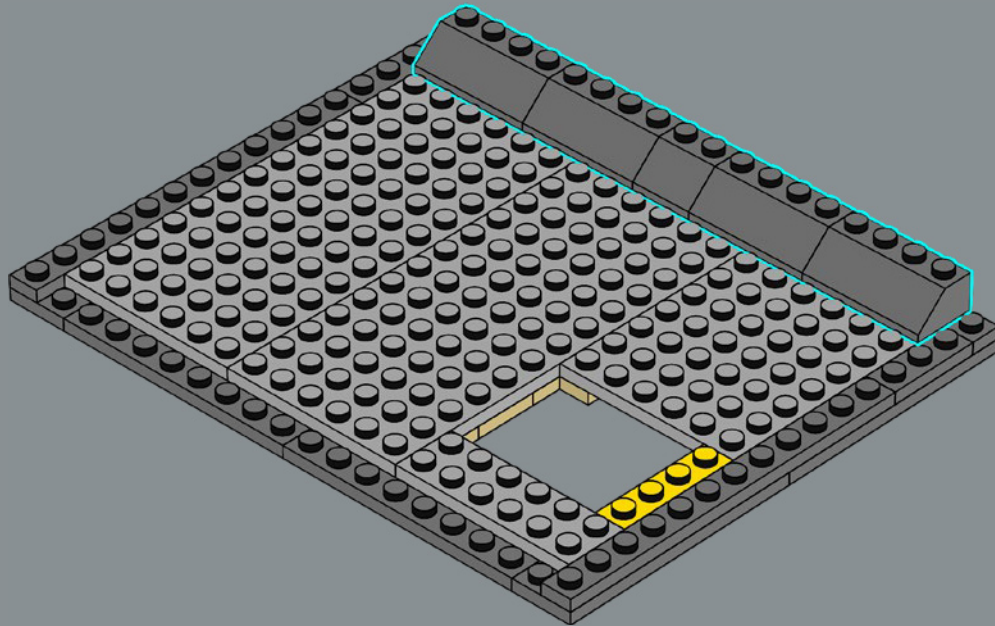

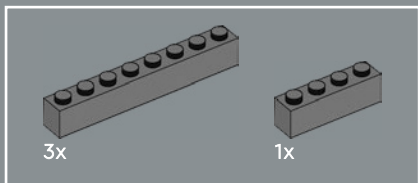

359

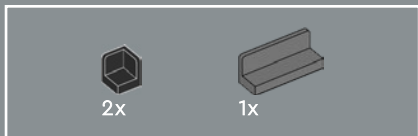
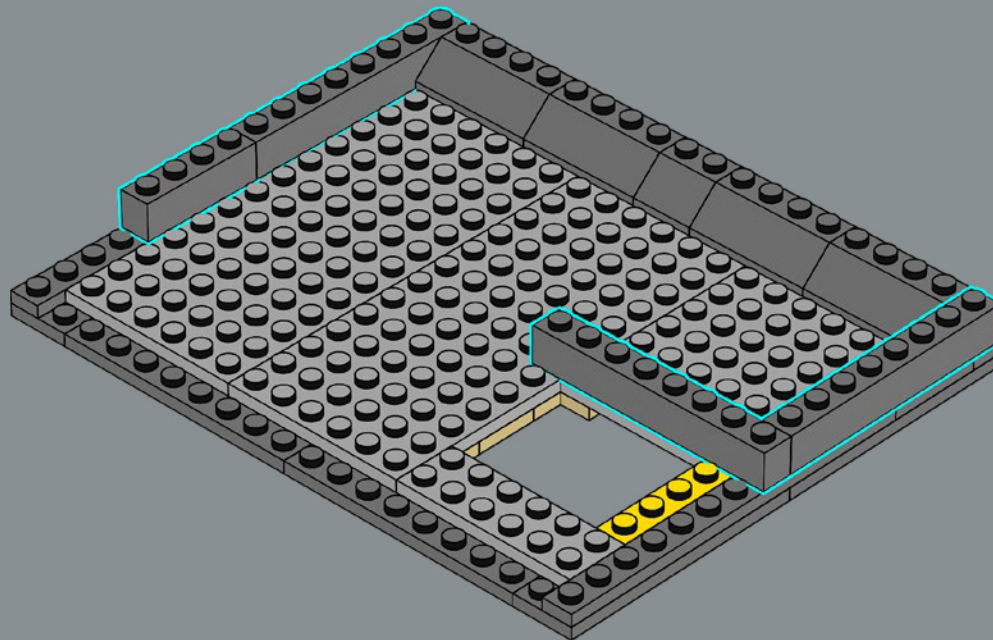

360

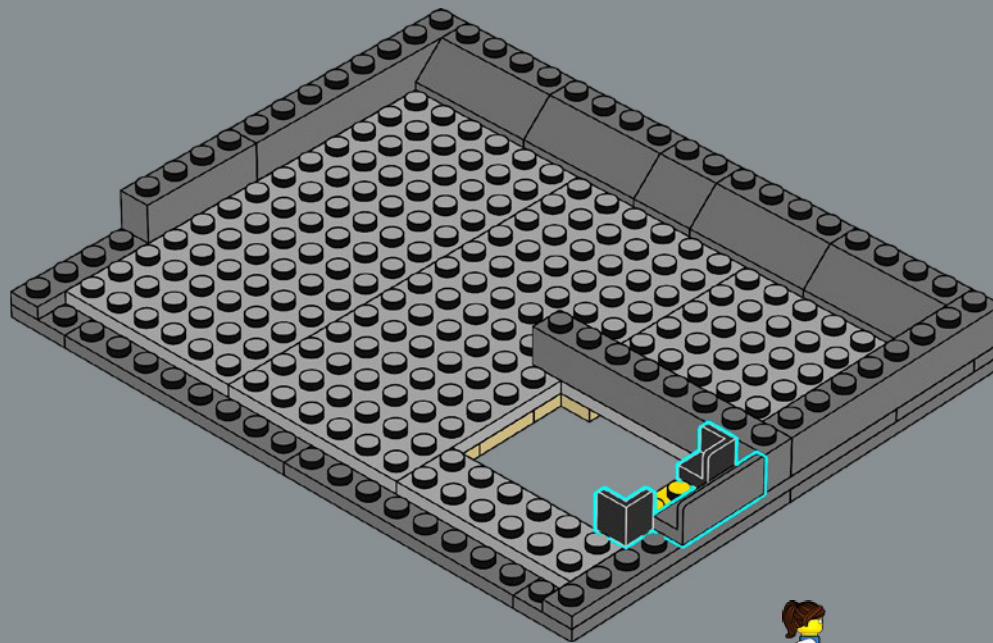

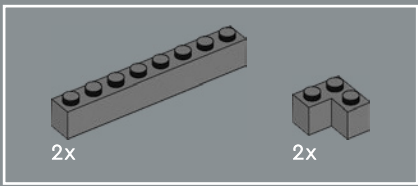

361

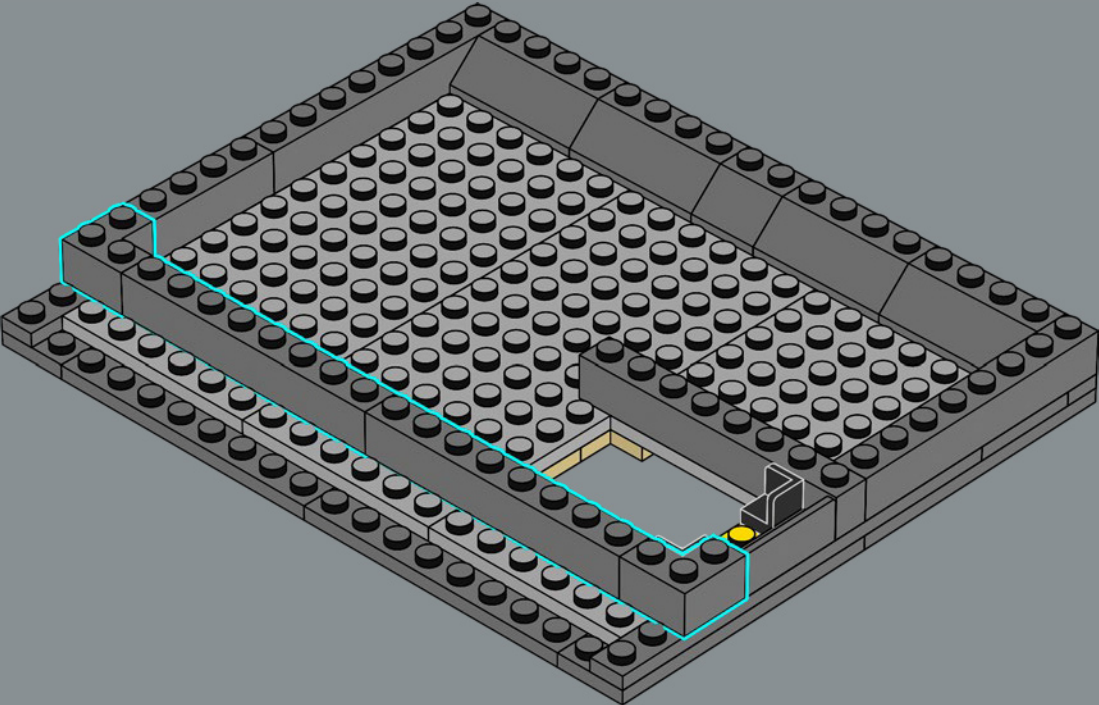

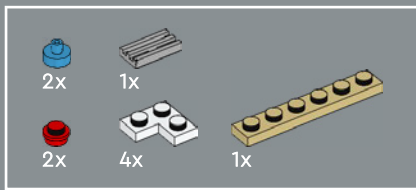

362

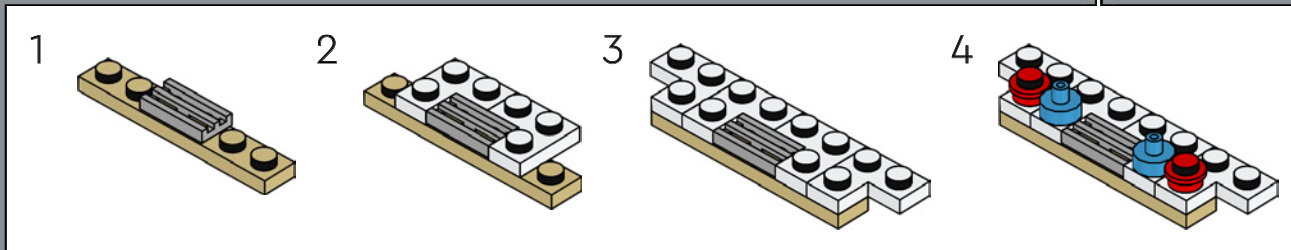
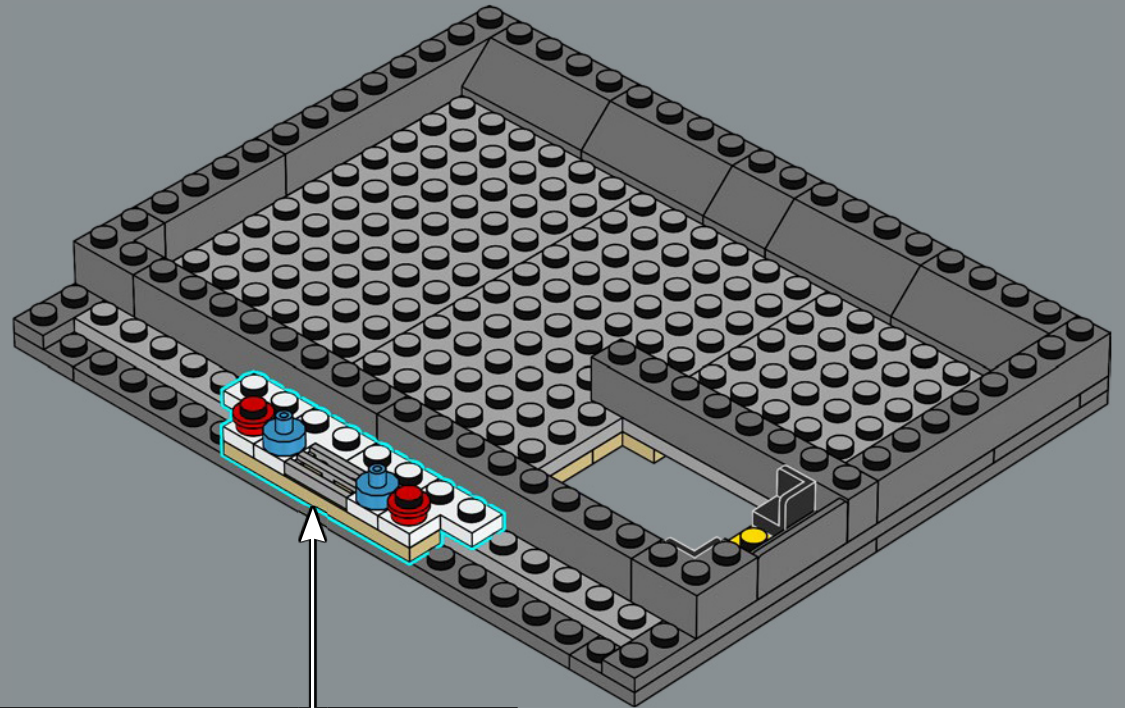

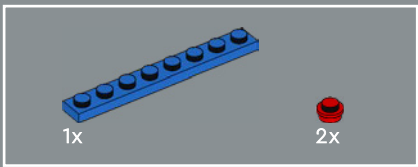

363

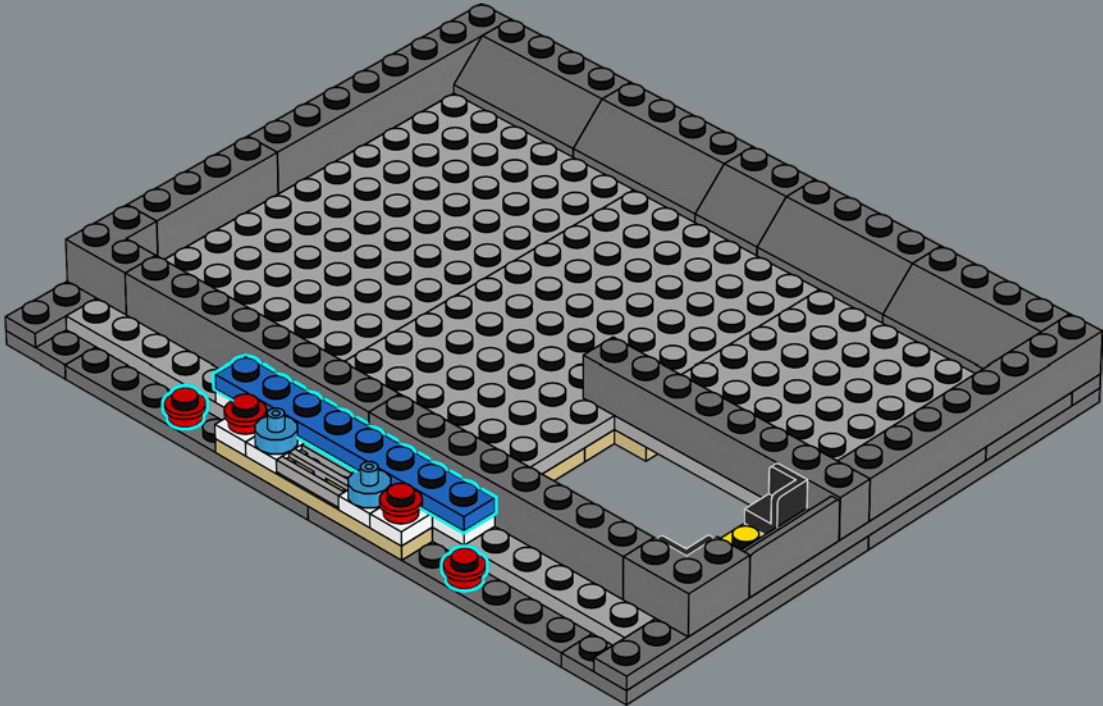

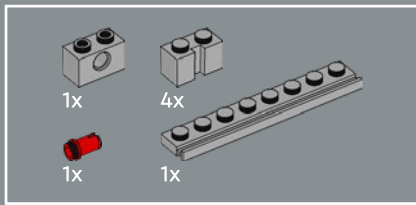

364

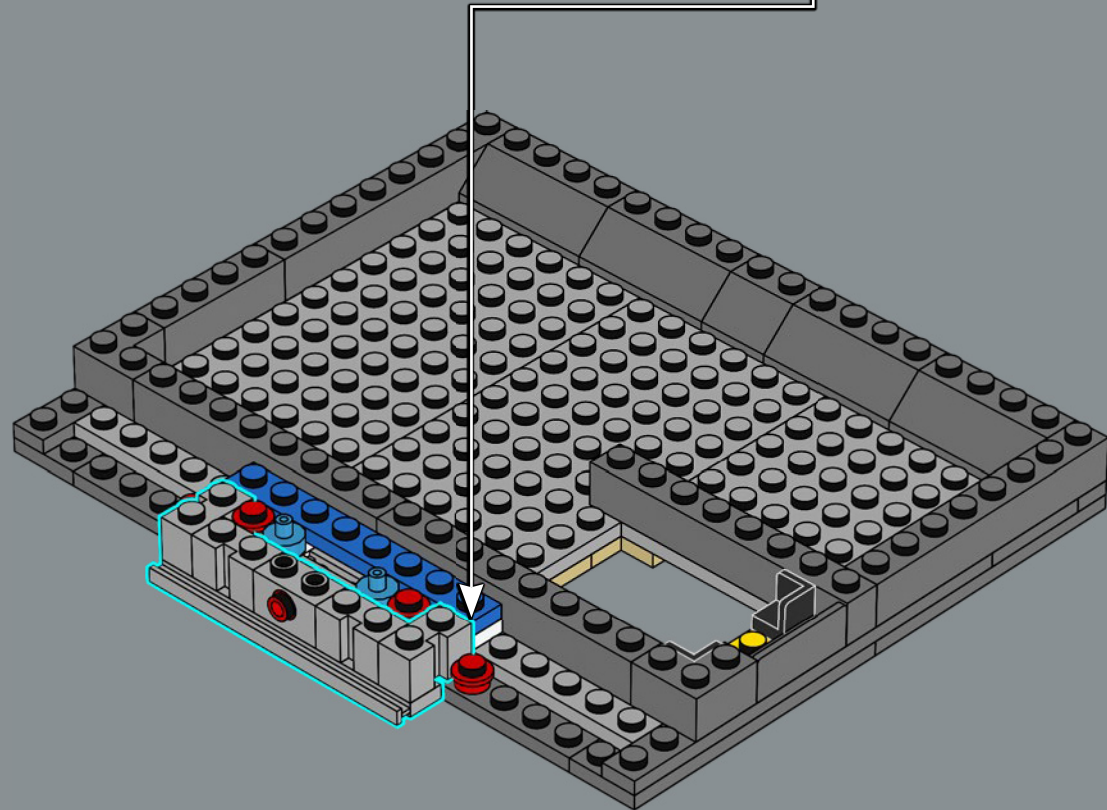
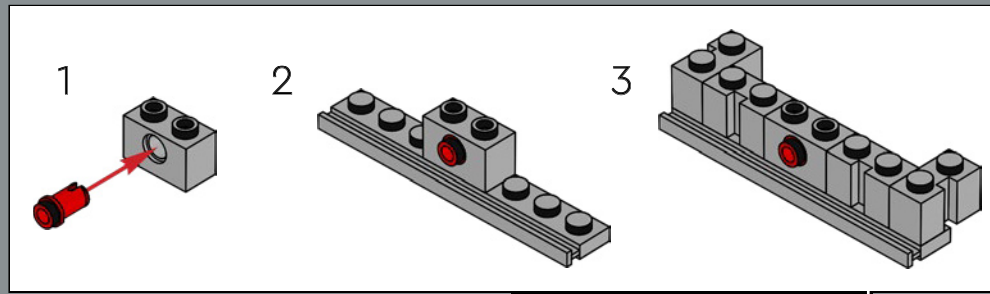

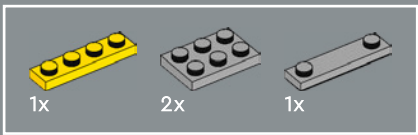

365

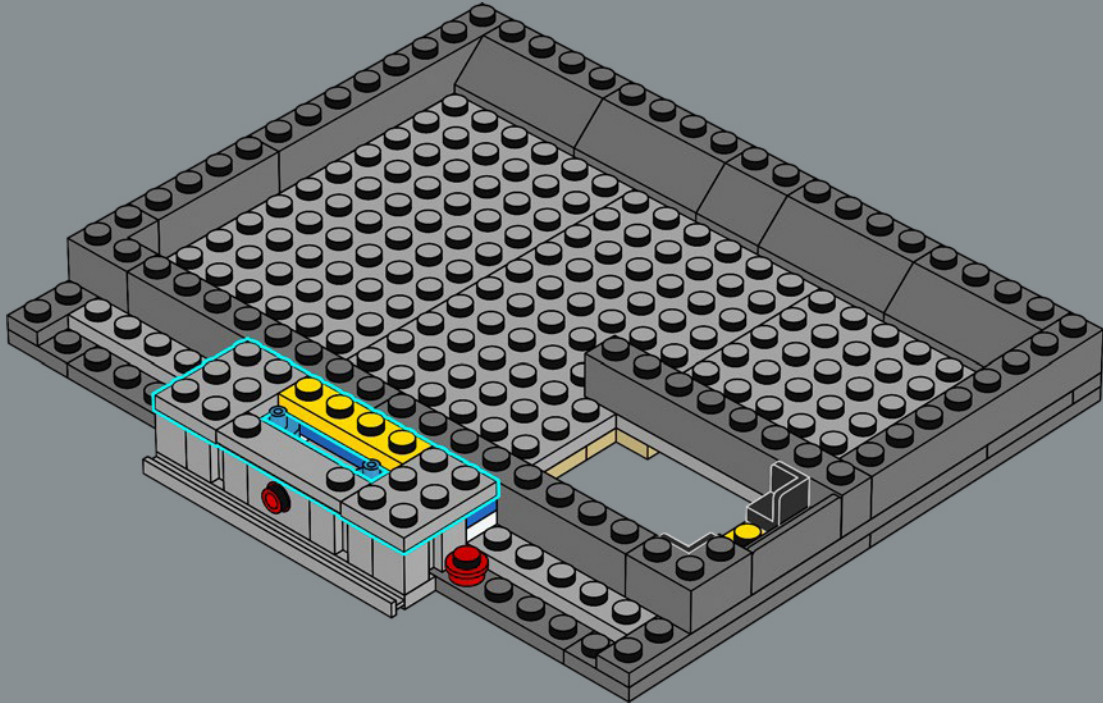

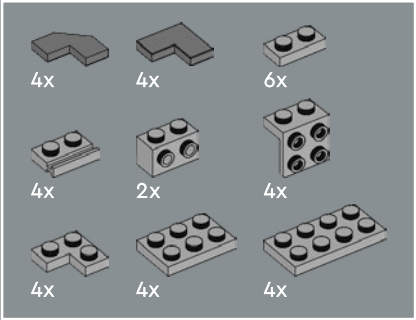
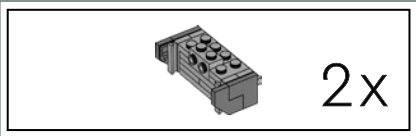

366

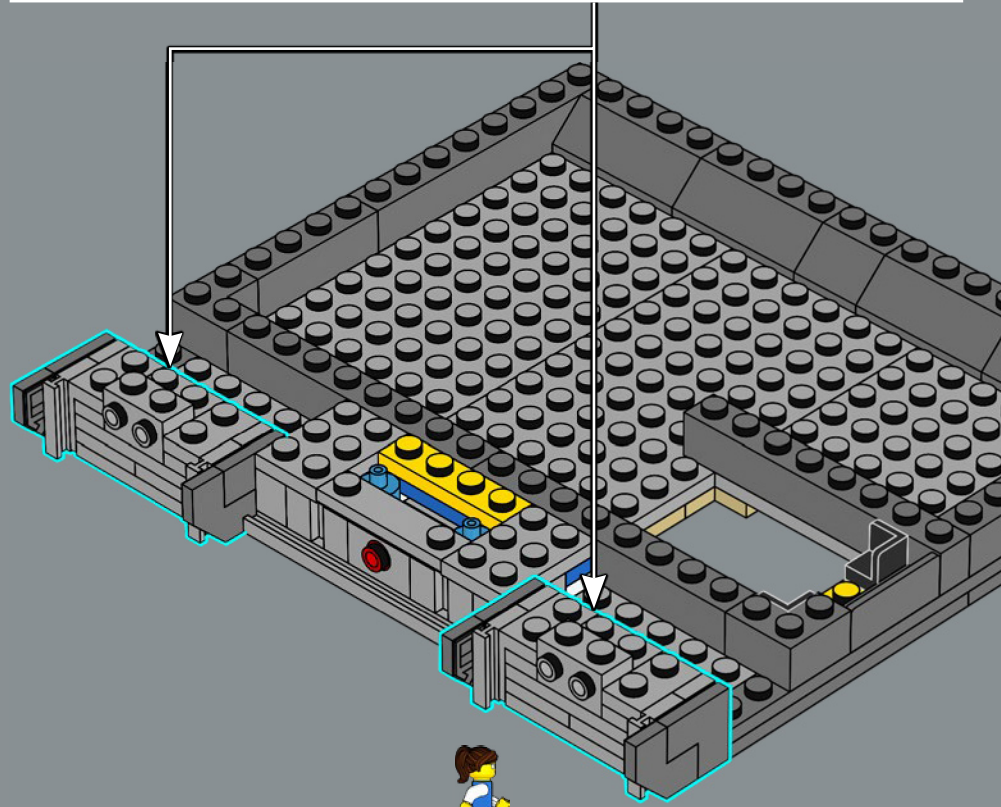
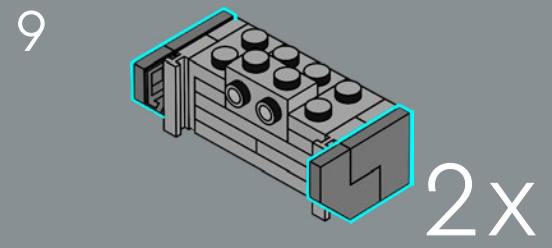
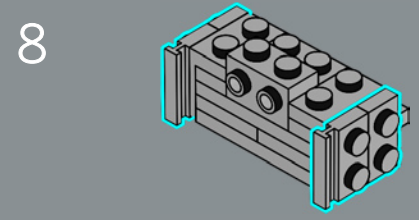
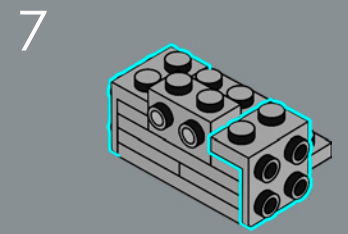
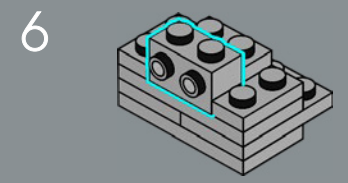
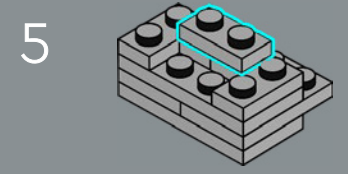
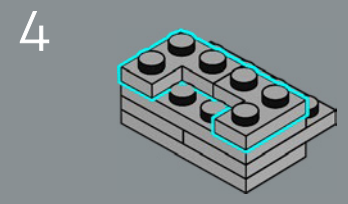
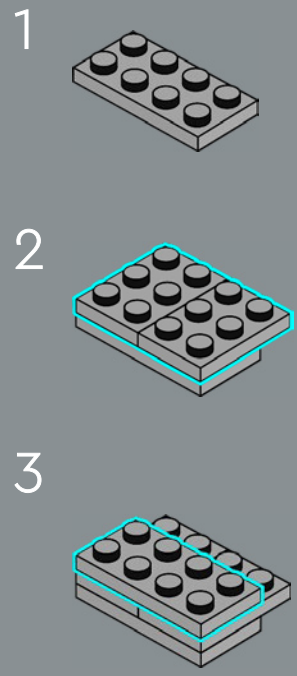

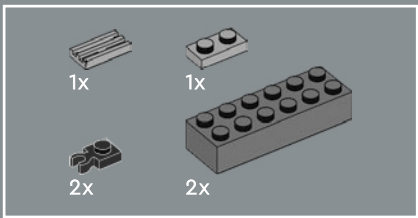

367

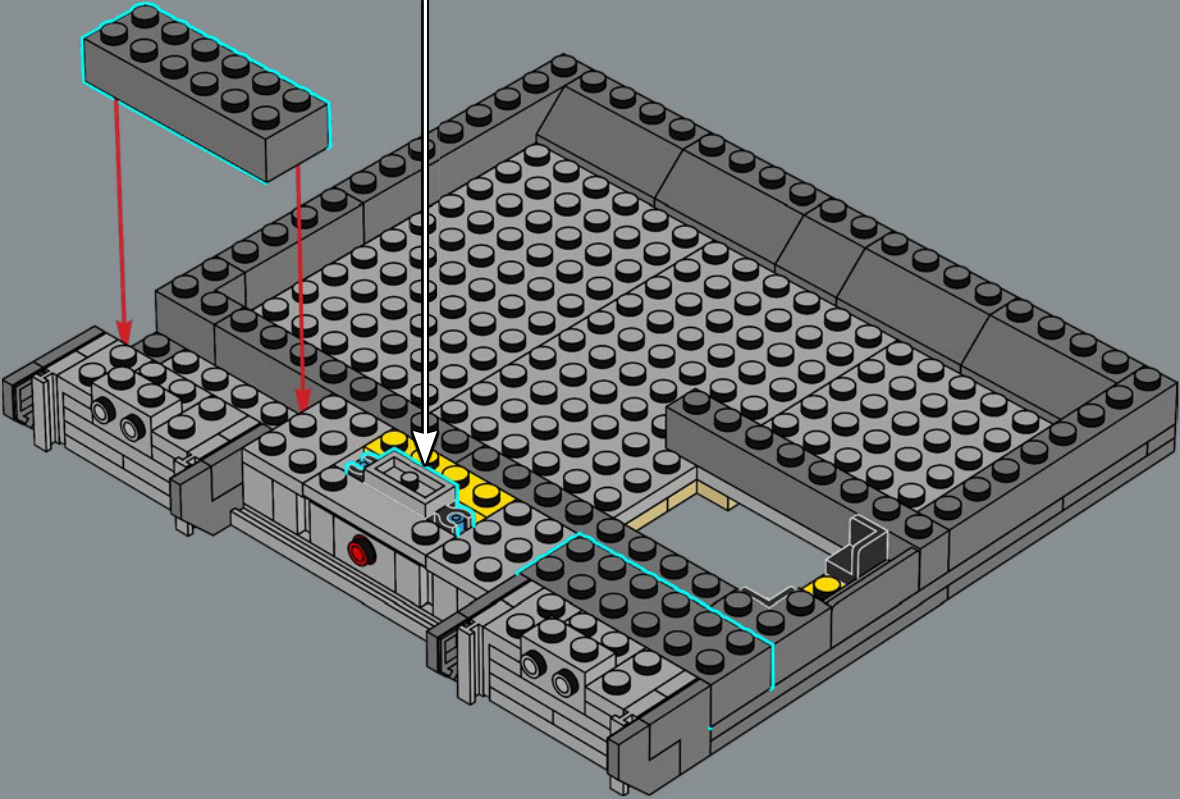
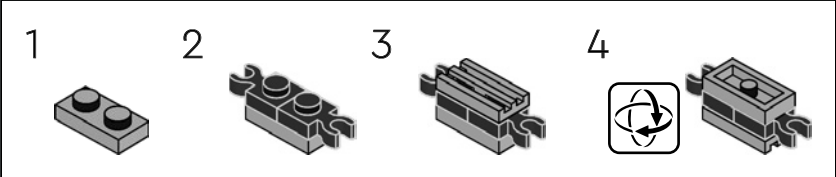

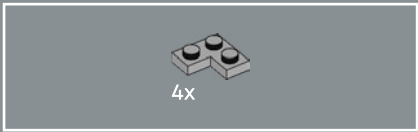

368

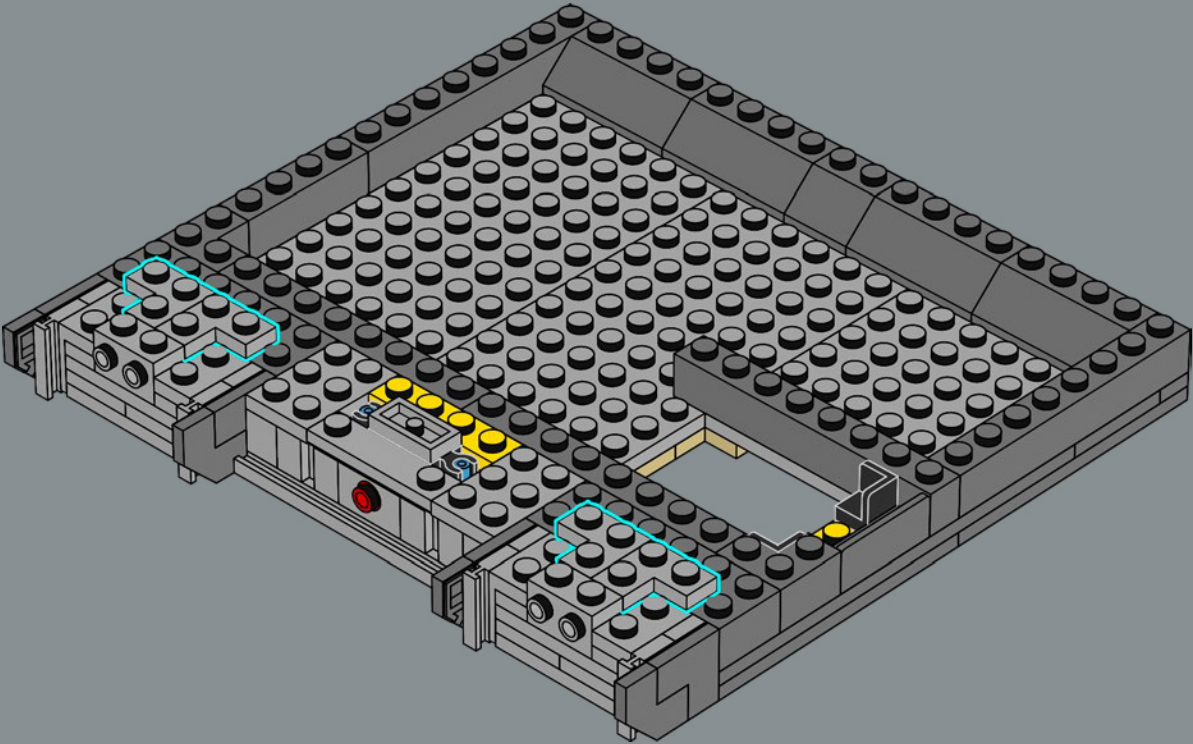

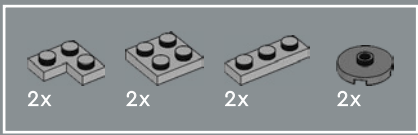

369

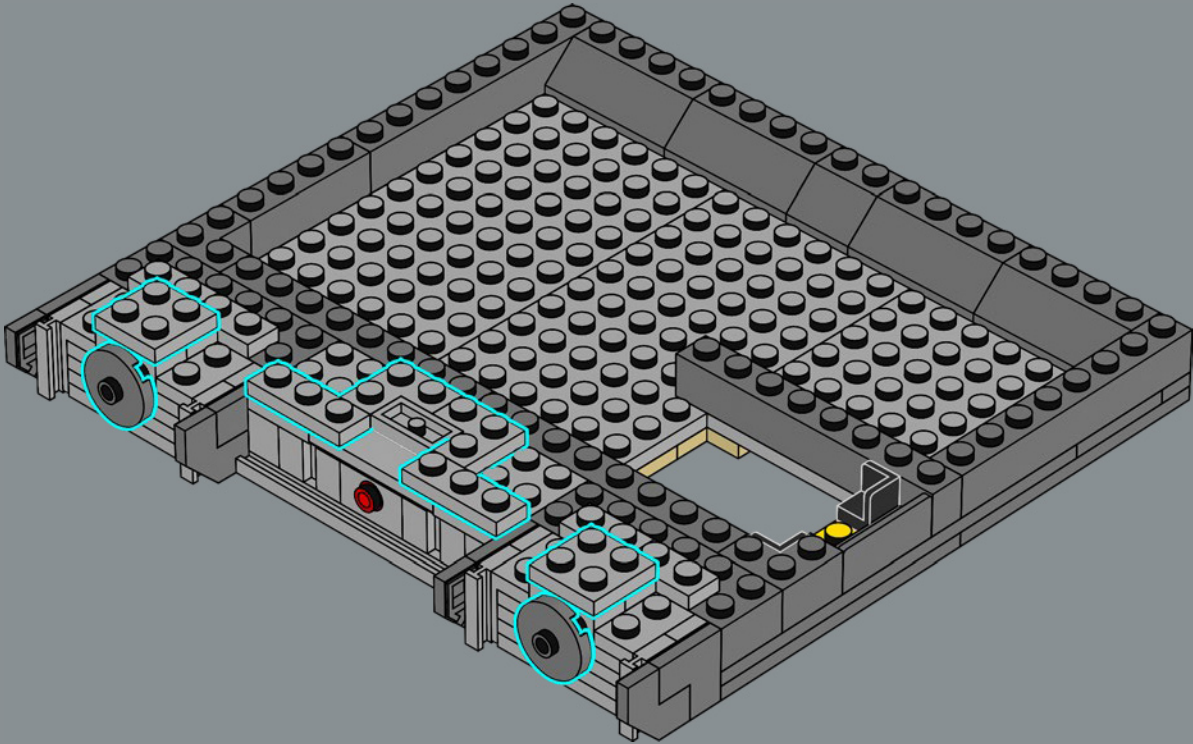



370

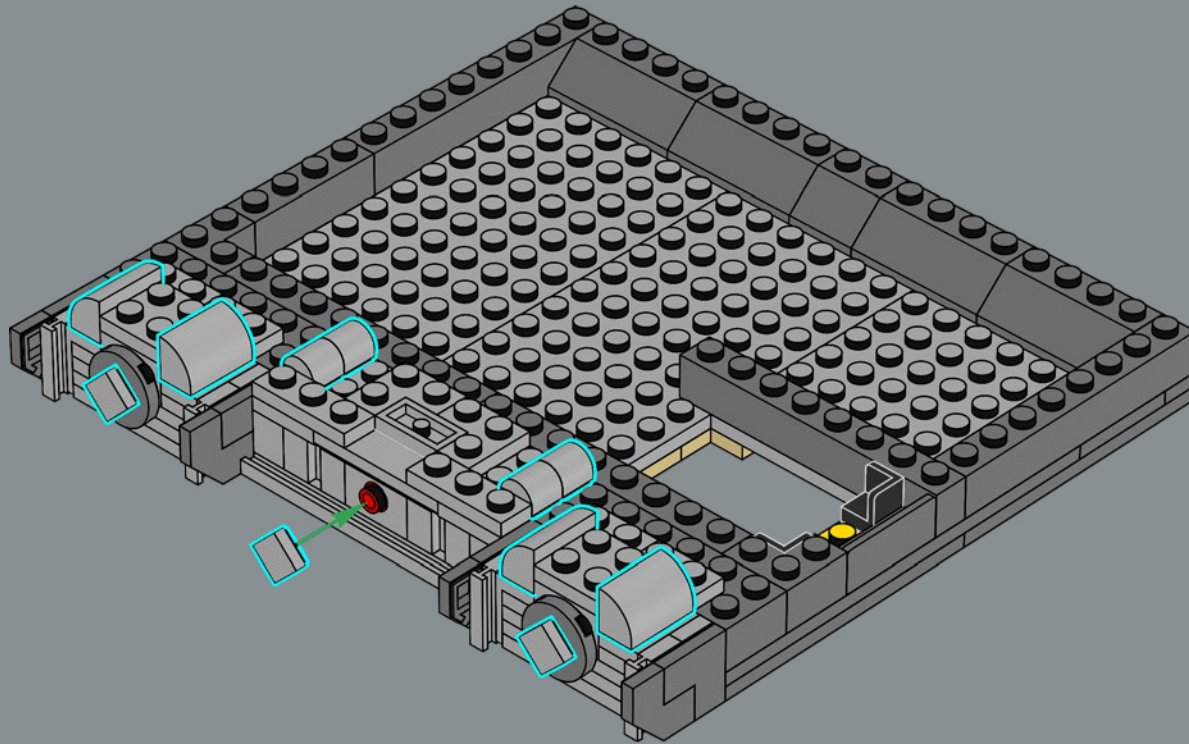

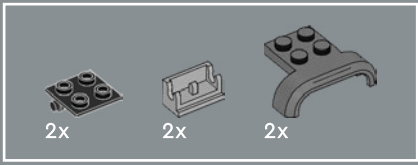

371

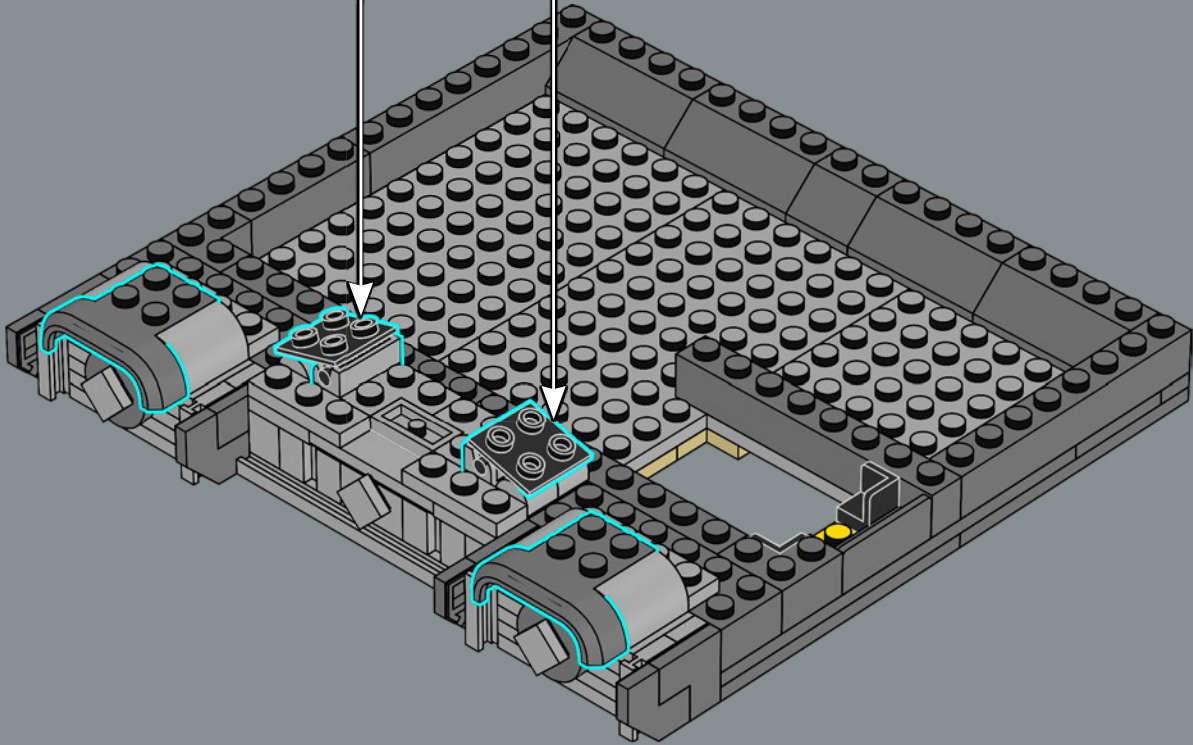
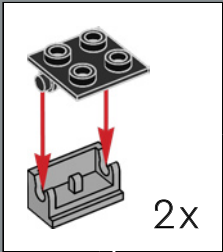

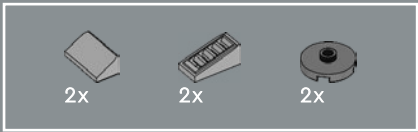

372

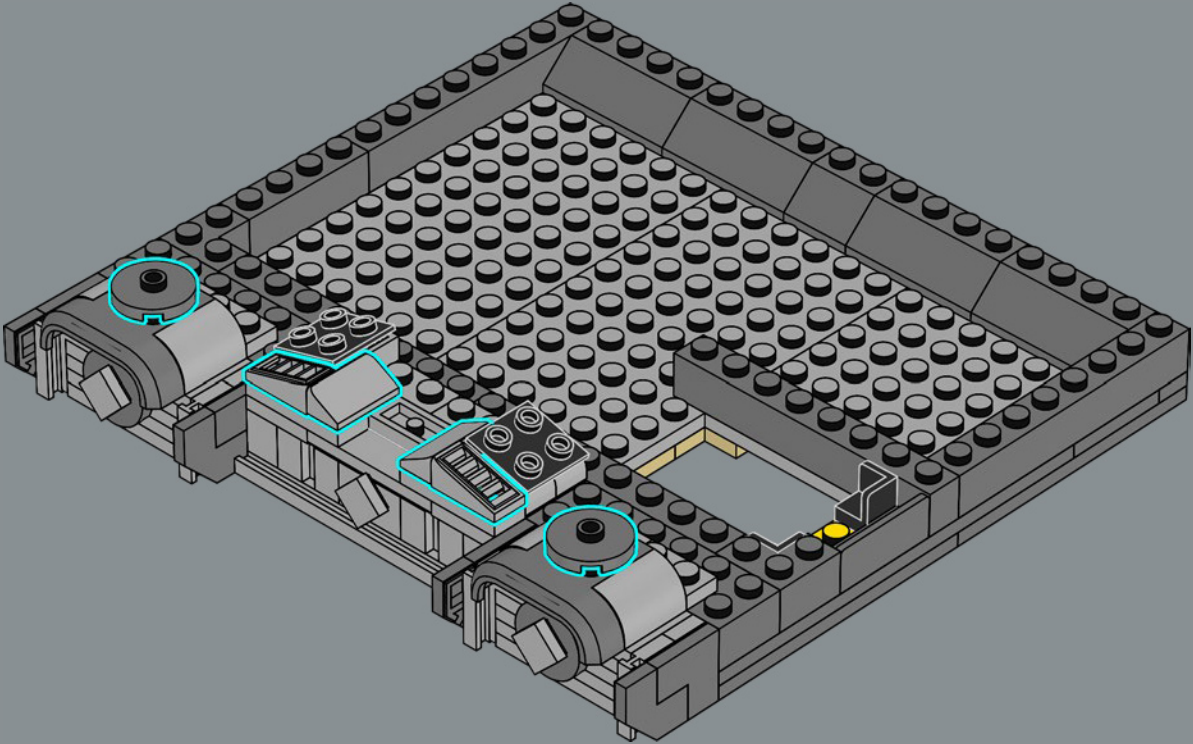

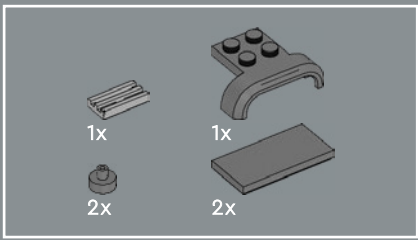

373

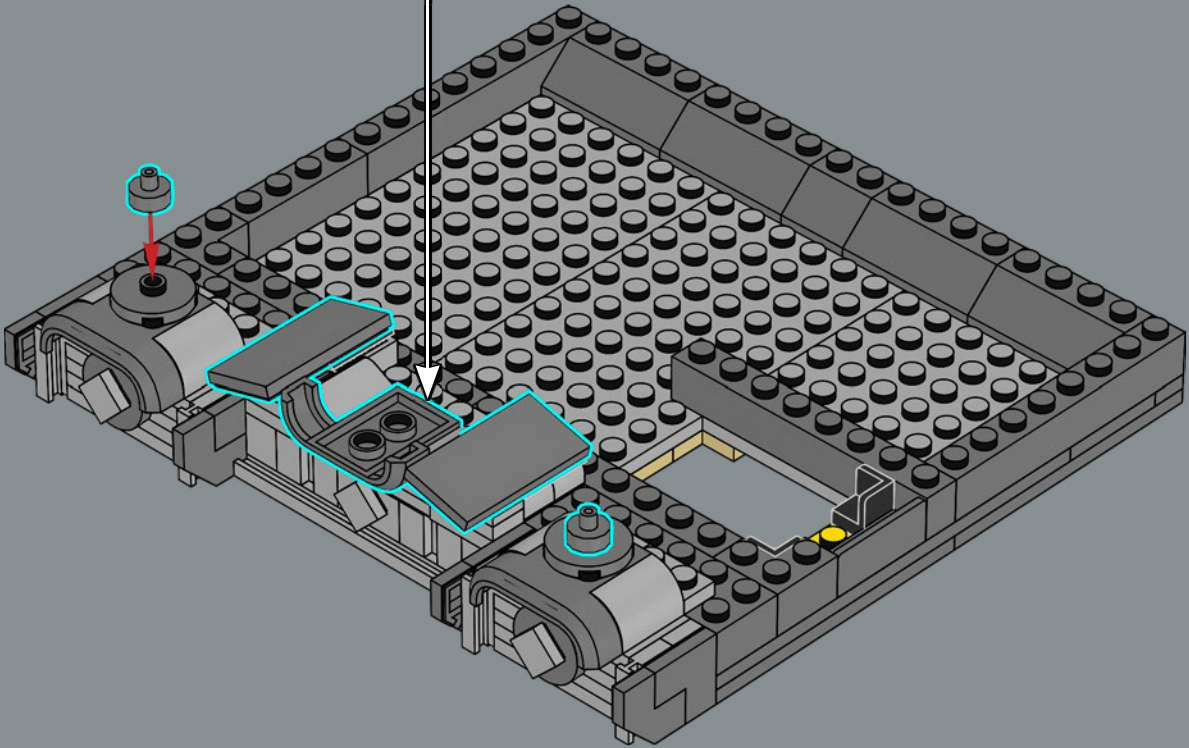
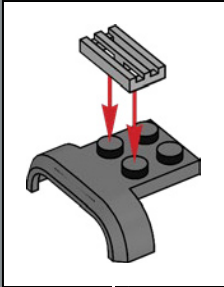



374

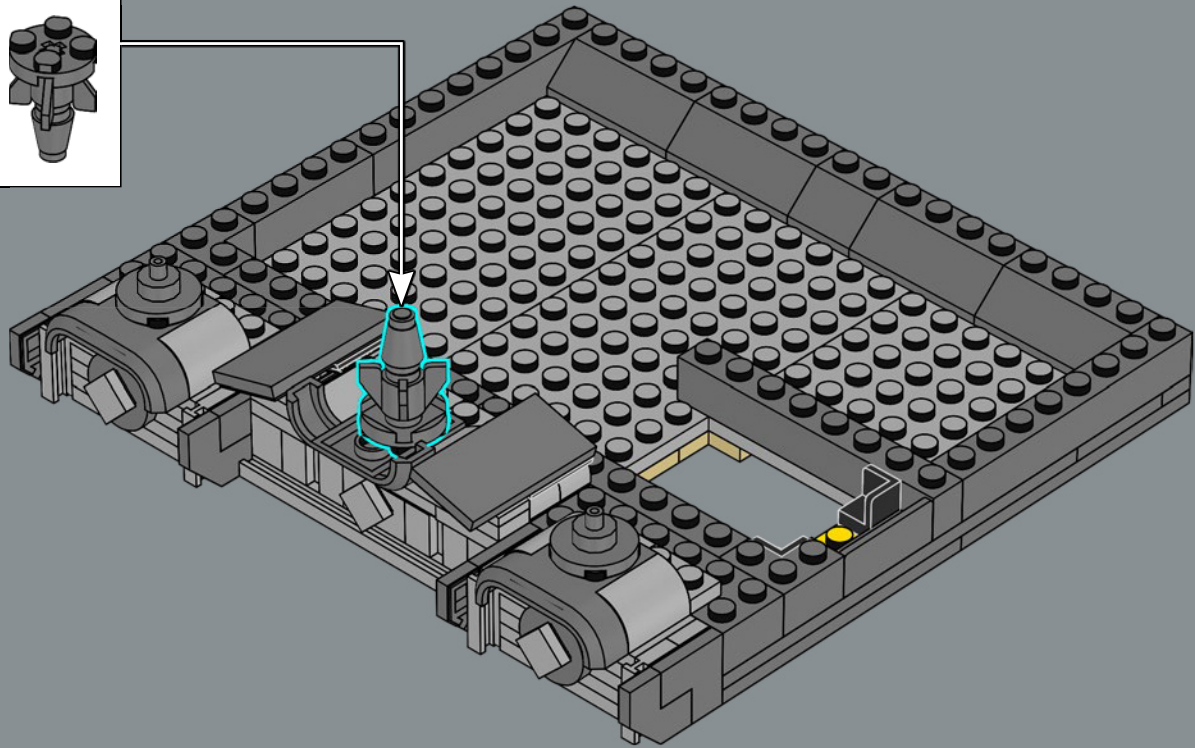
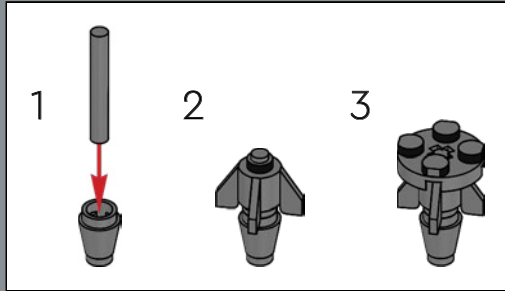

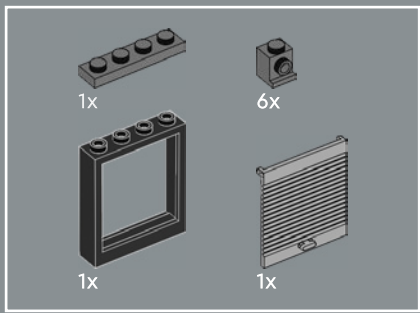

375

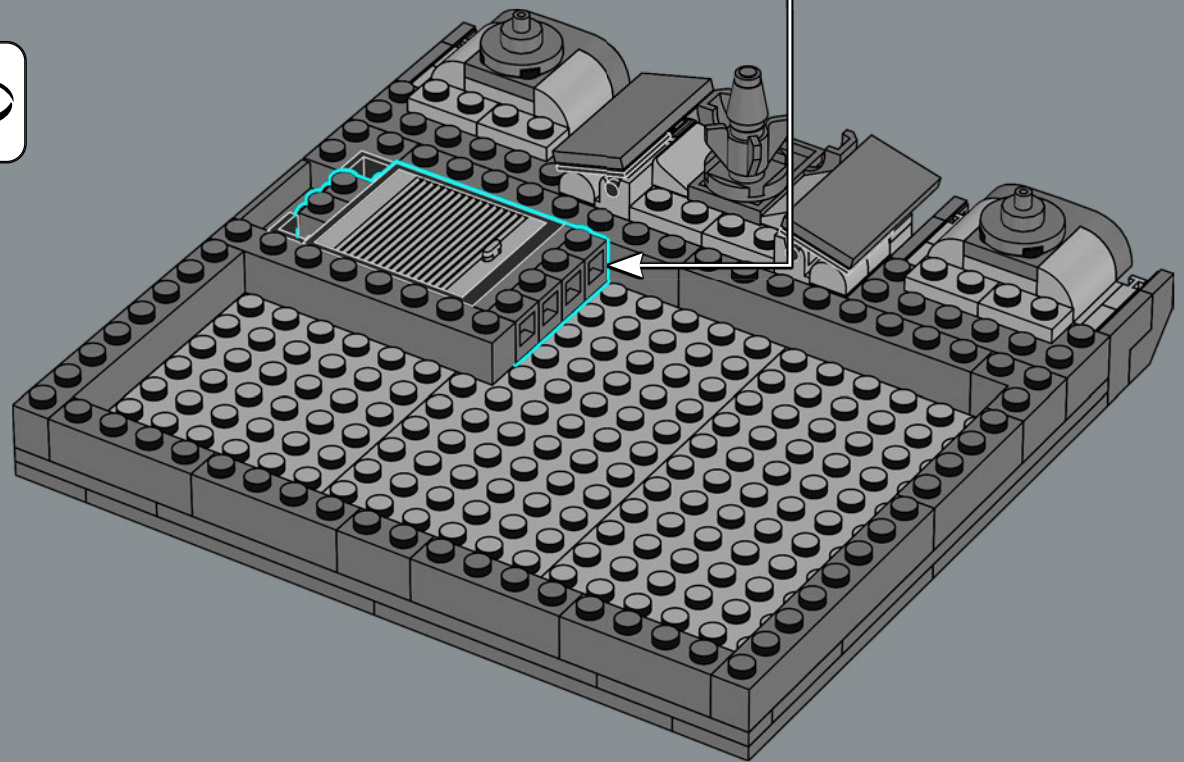
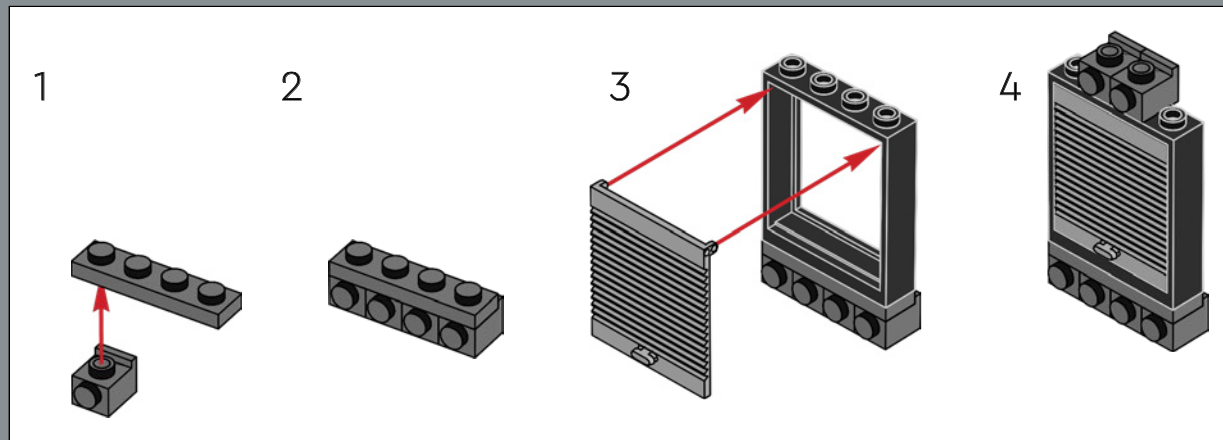

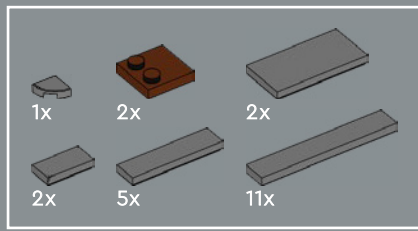

376

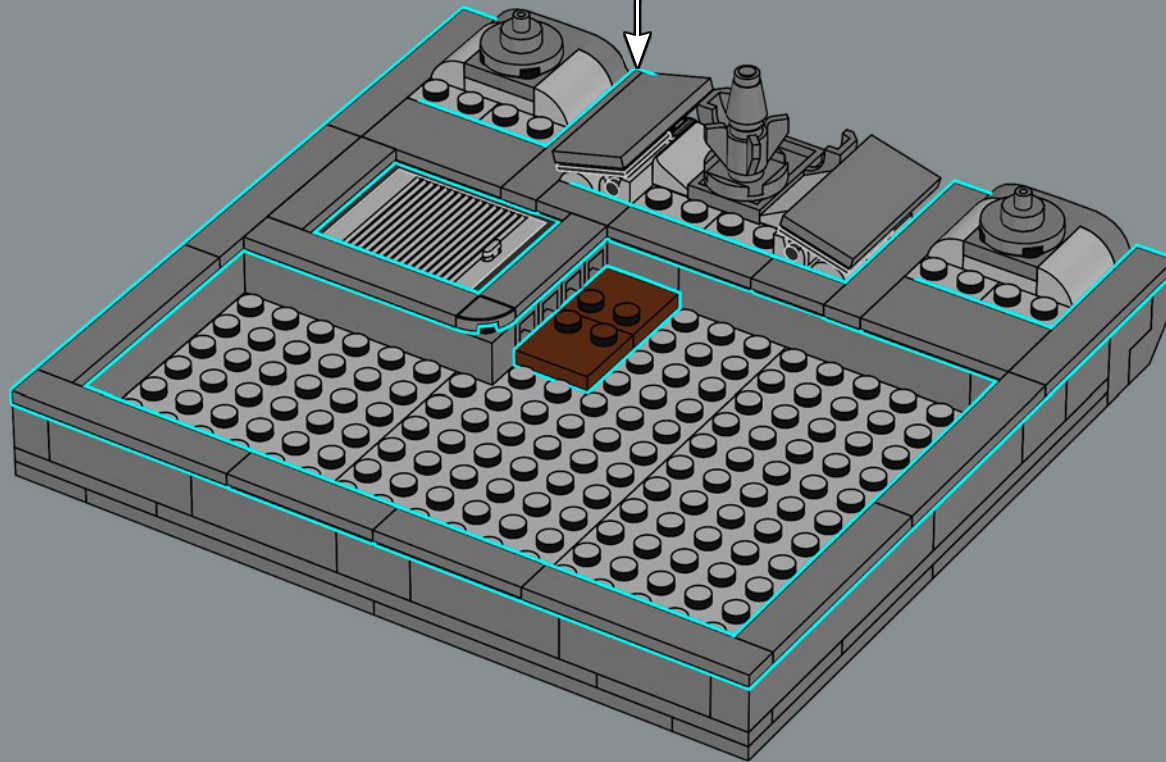
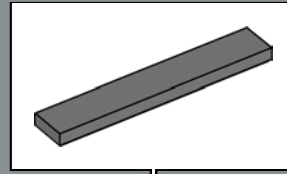

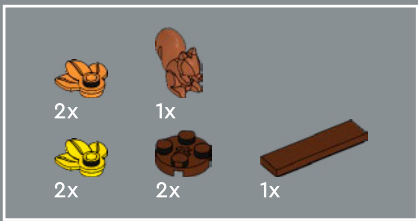

377

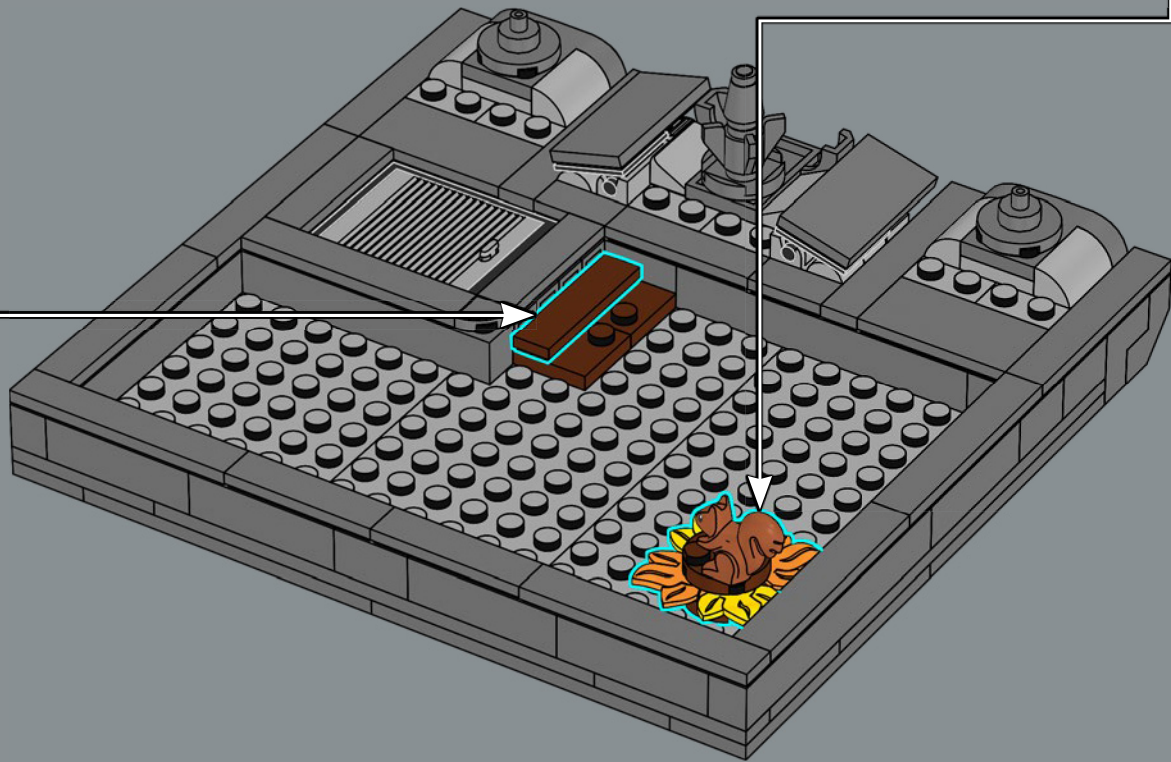
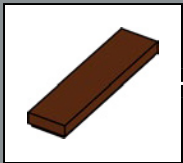



Watch out for the mischievous squirrel! If you stop for a slice of pizza, you might just find it disappears from your hands and ends up on the roof!

378

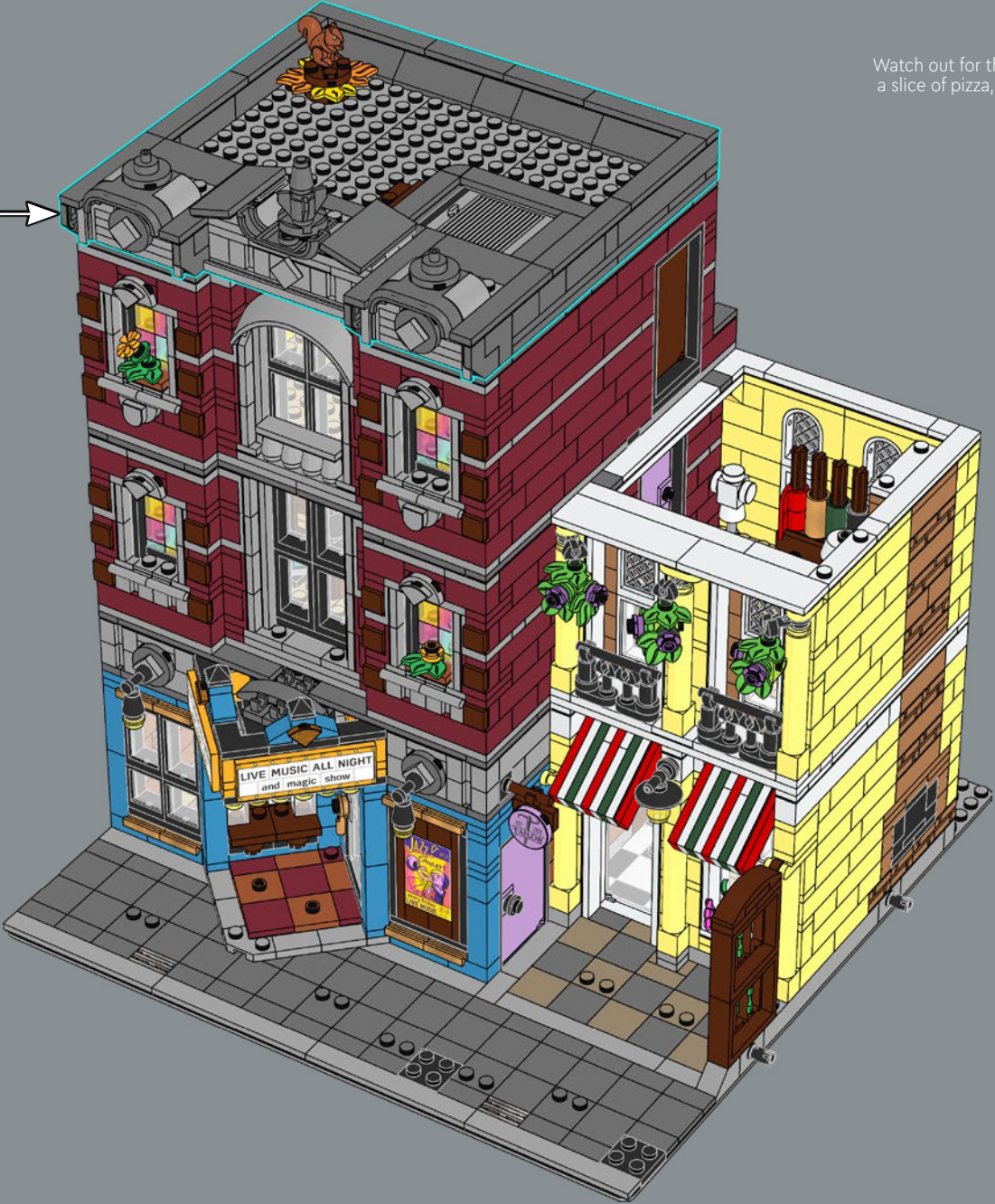

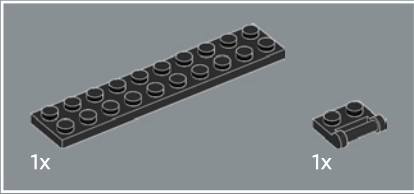

379

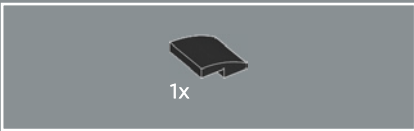
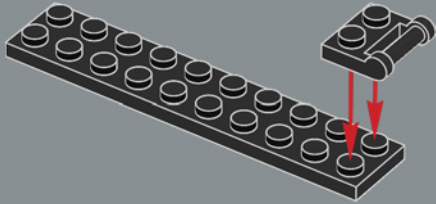

380

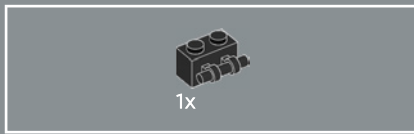
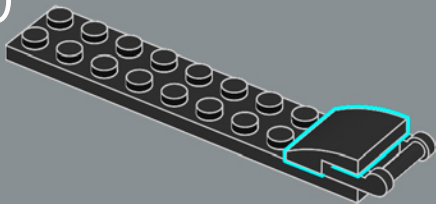

381

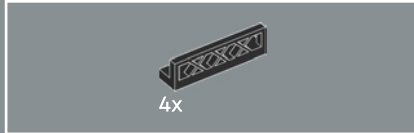
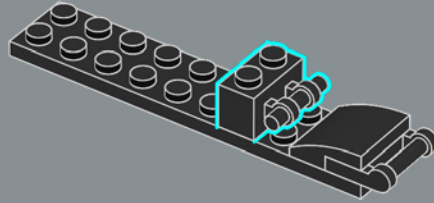

382

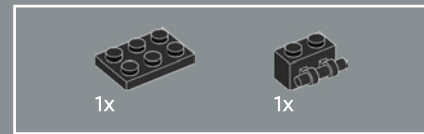
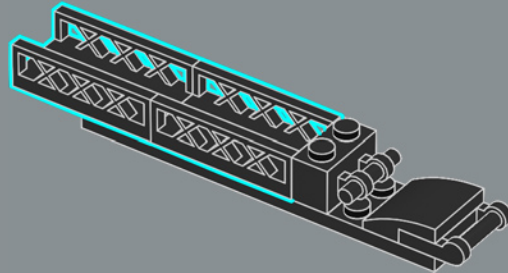

383

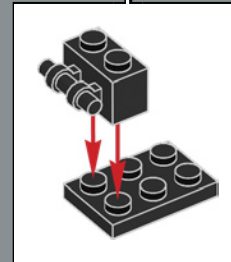
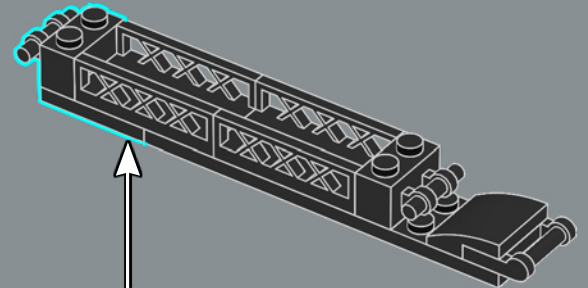

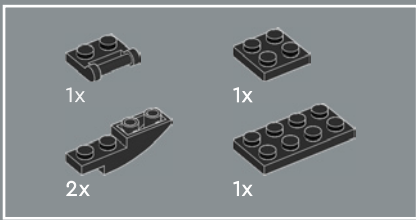

384

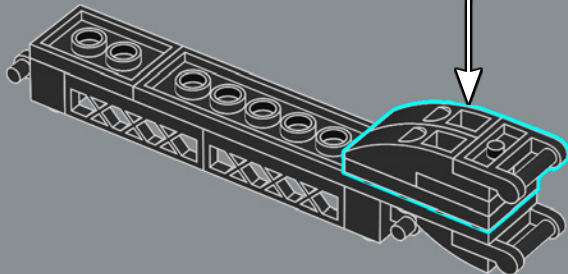
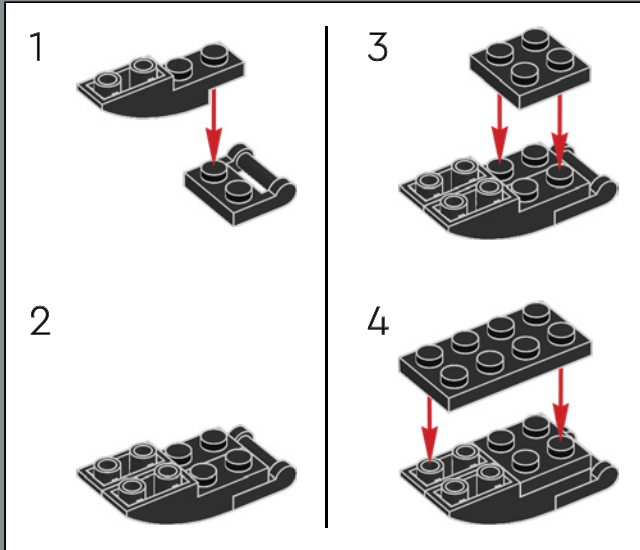

385

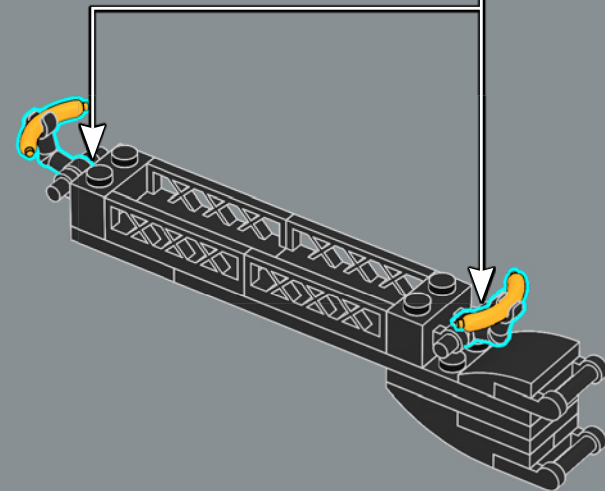
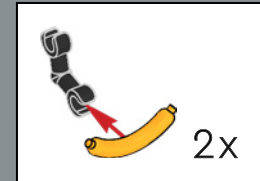

The LEGO® sausage has proven to be an incredibly useful element. It has appeared in 9 colours in dozens of LEGO sets.



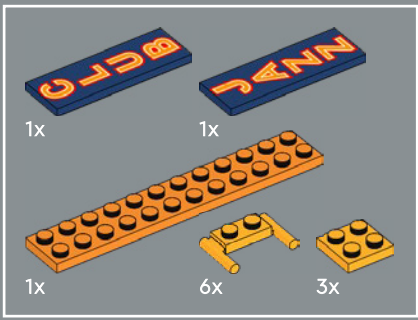

386

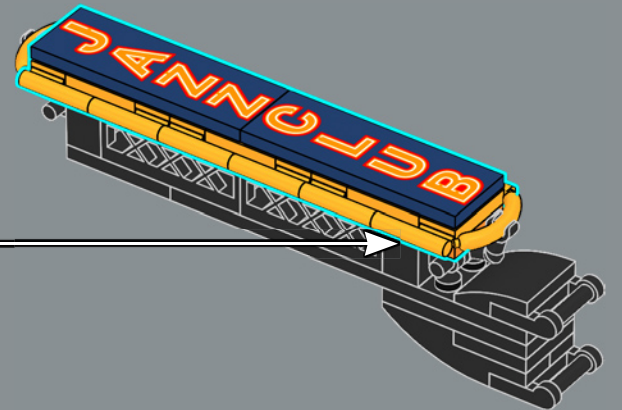
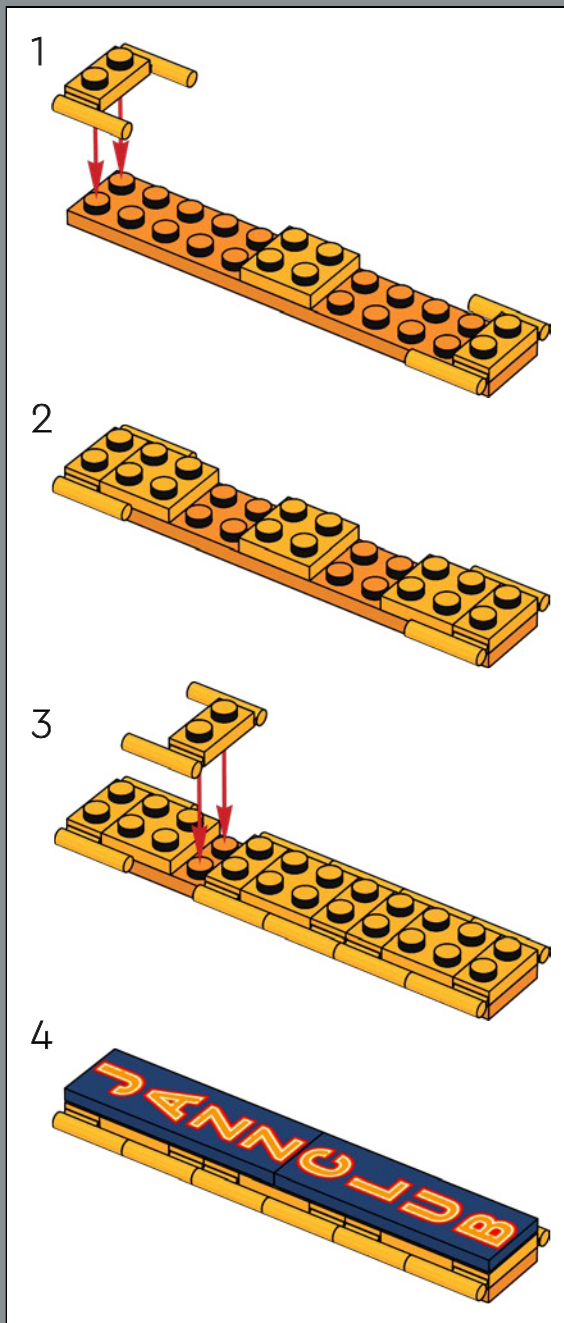

387

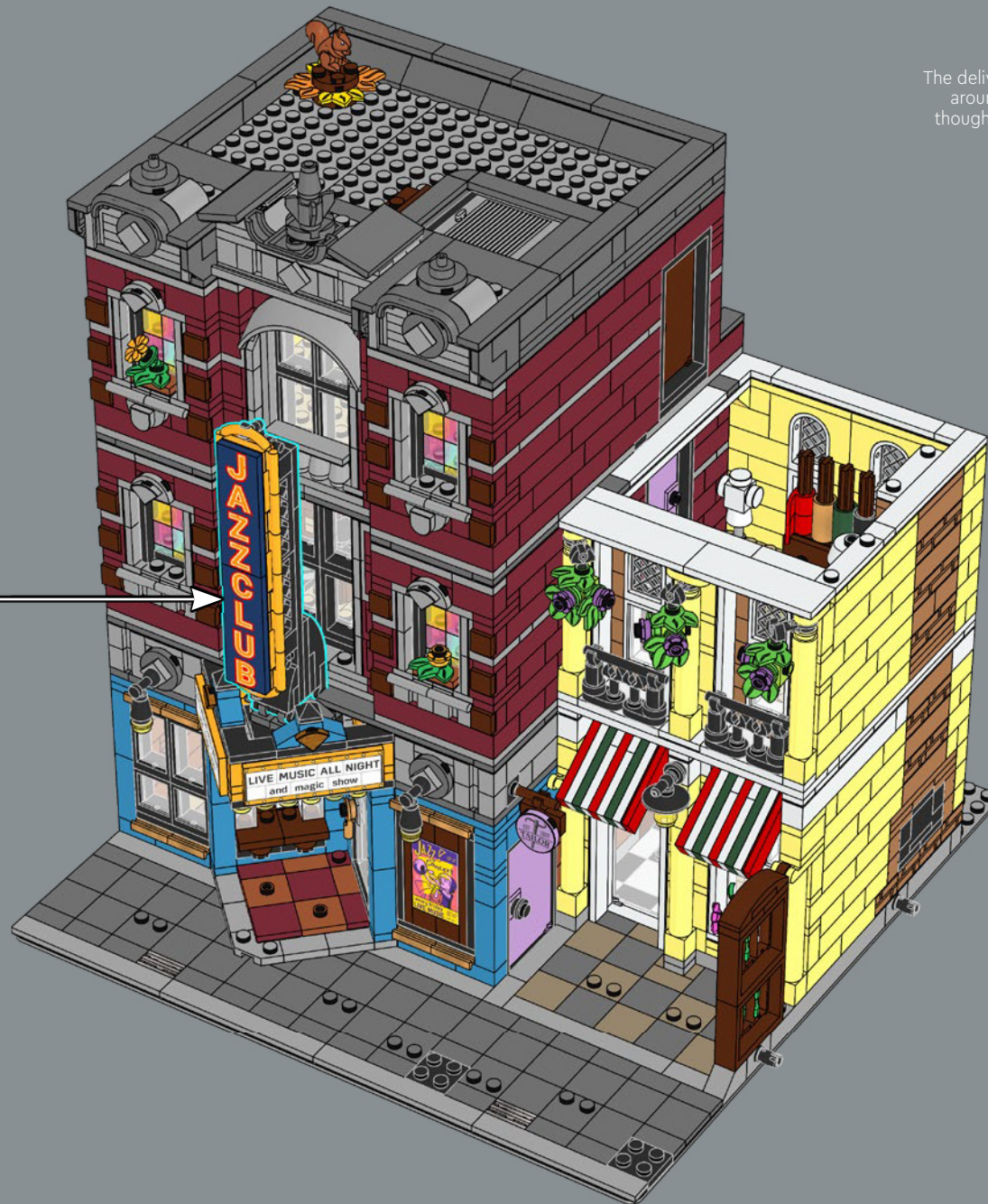

The delivery driver is happy to bring pizza anywhere around town. Don't be surprised if he's a bit late, though. He loves to listen to the Jazz Club's shows, and it can be hard to drag him away.



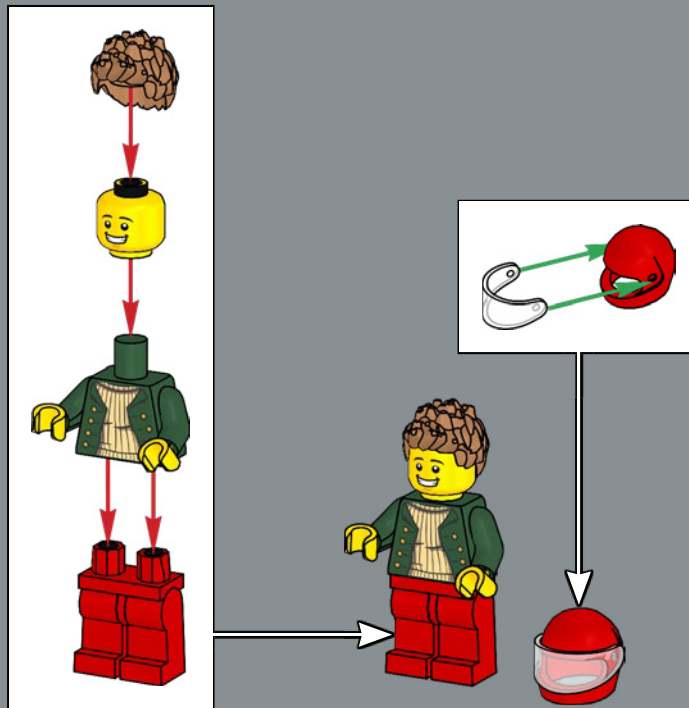

1

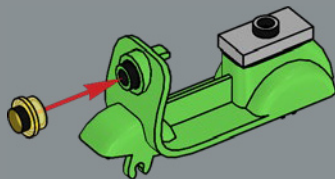

2

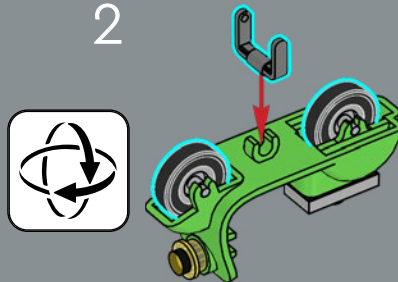

3

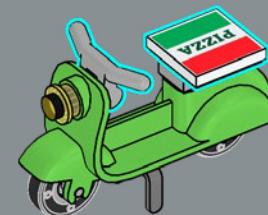
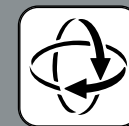

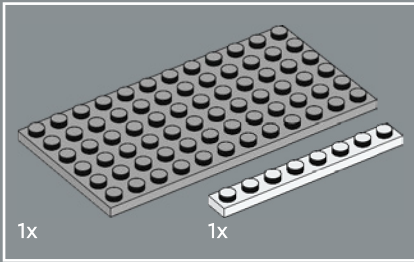
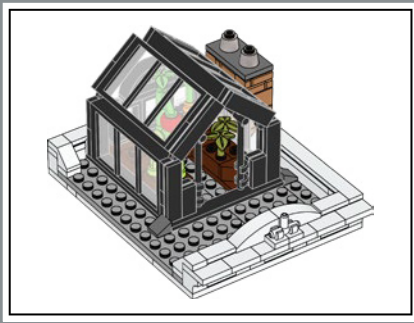

388

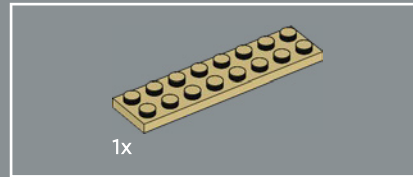
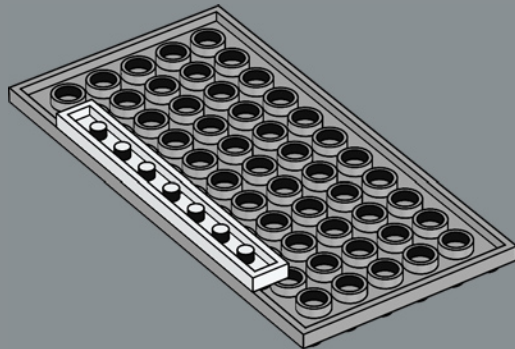

389

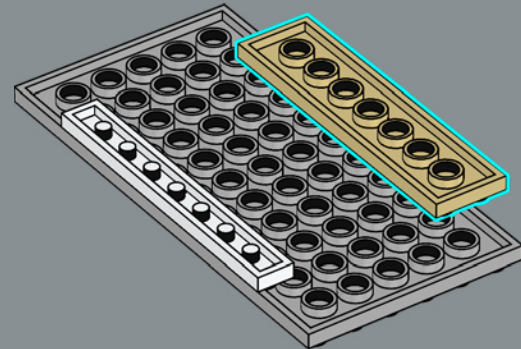

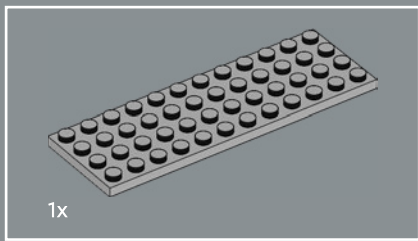

390

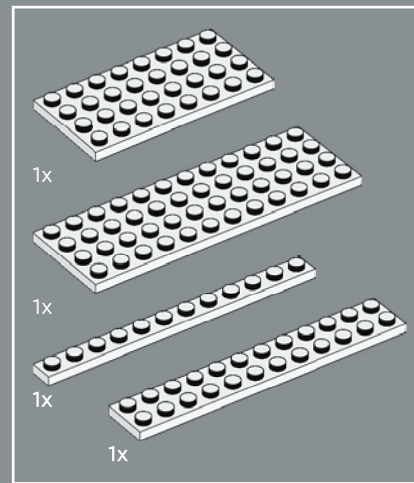
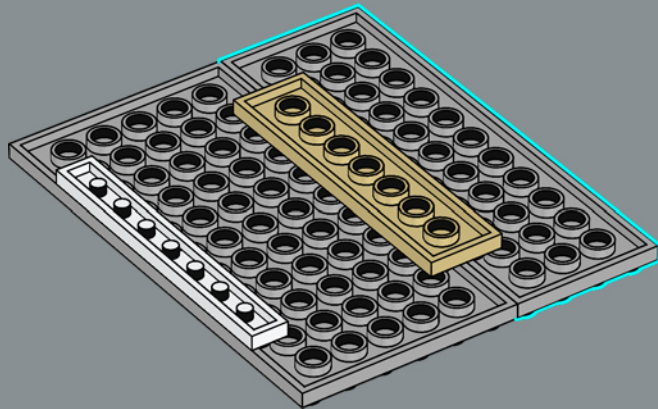

391

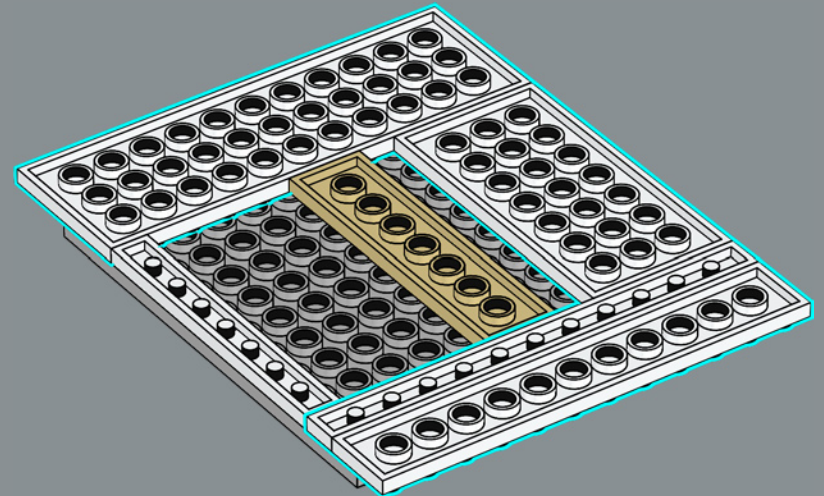

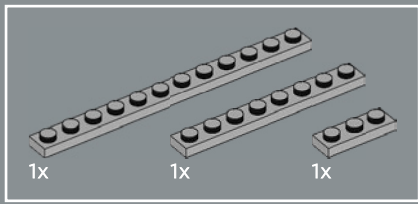

392

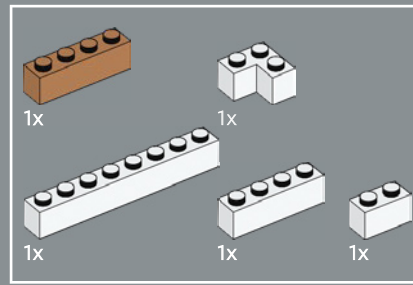
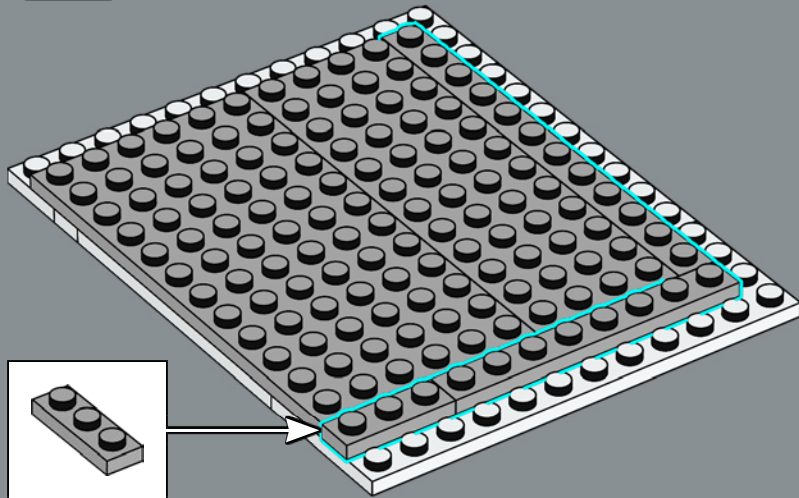

393

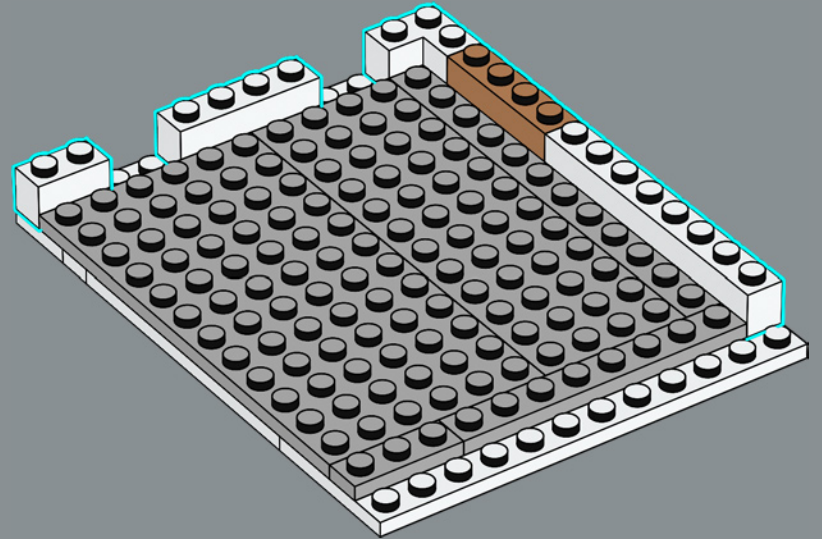



3x

394

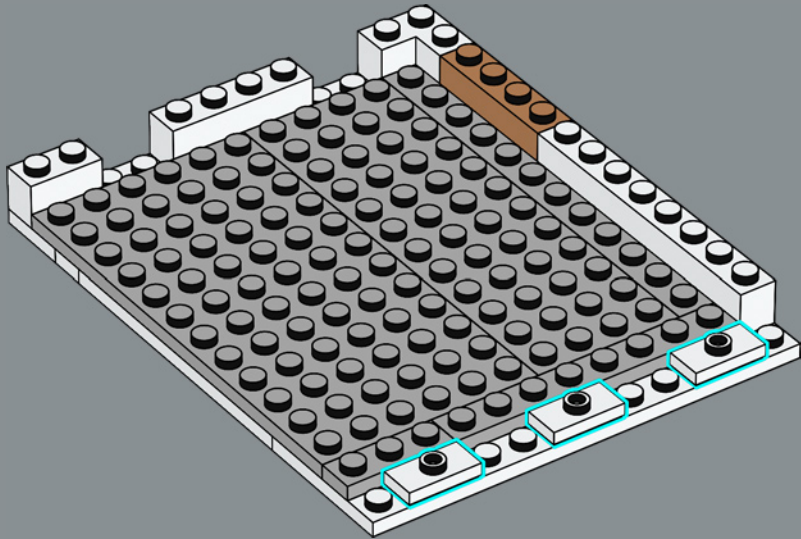

1x



1x

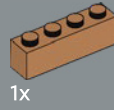

1x

395

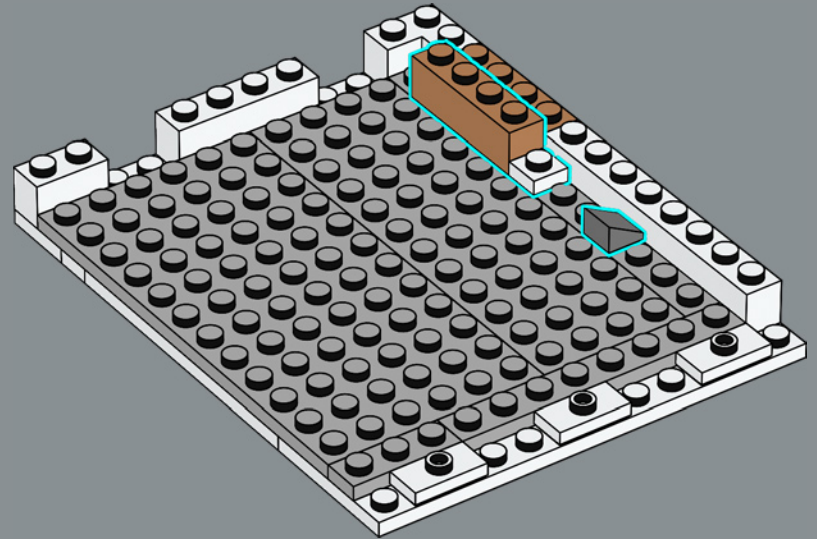

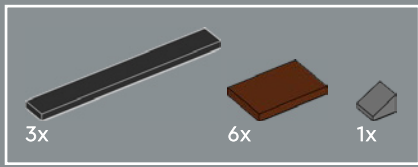

396

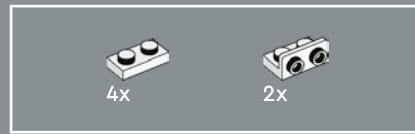
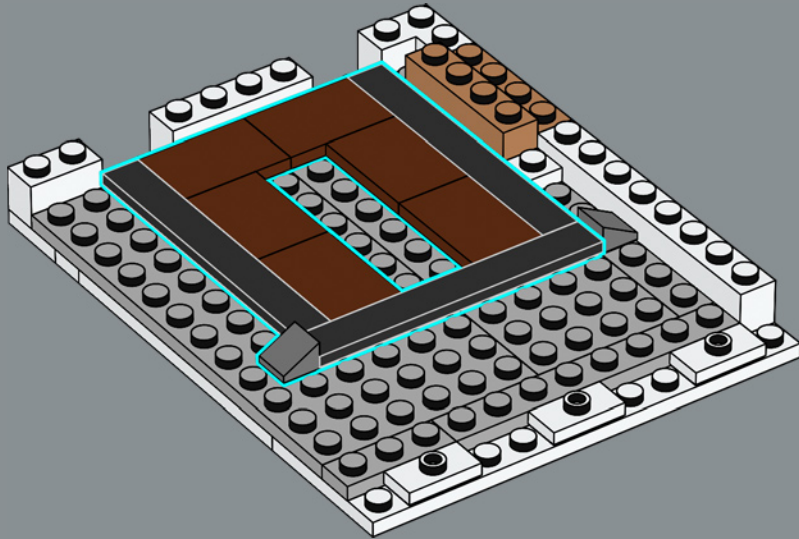

397

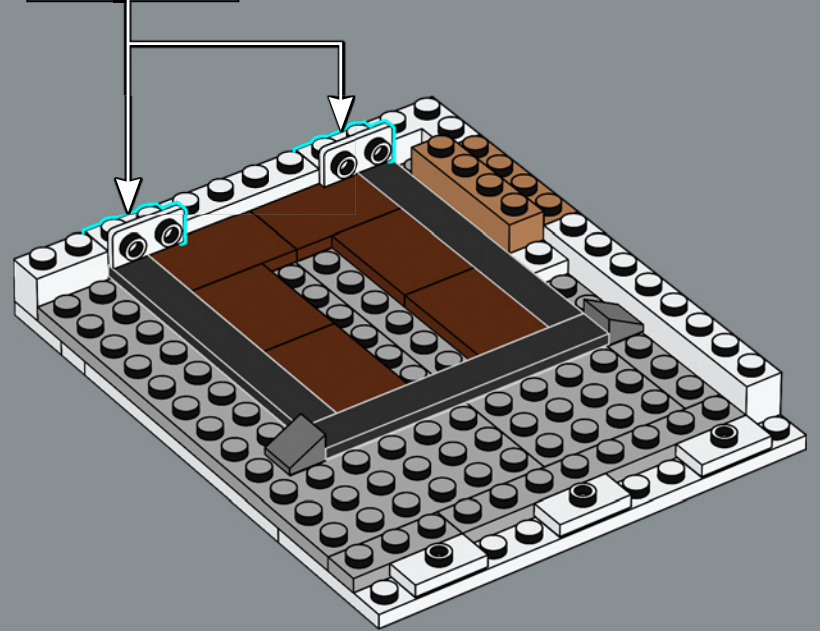
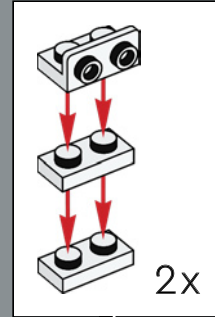

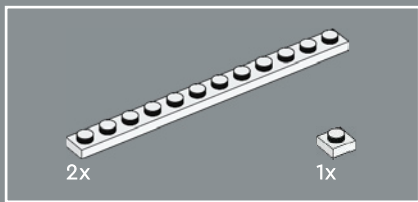

398

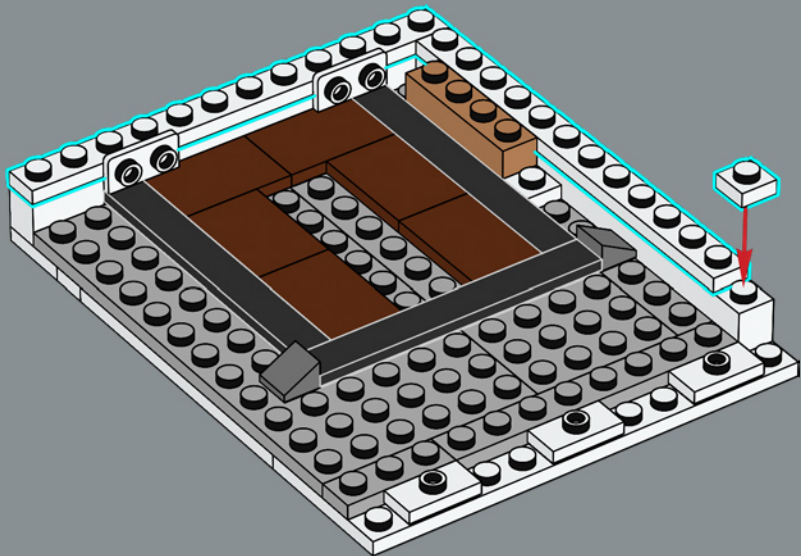

399

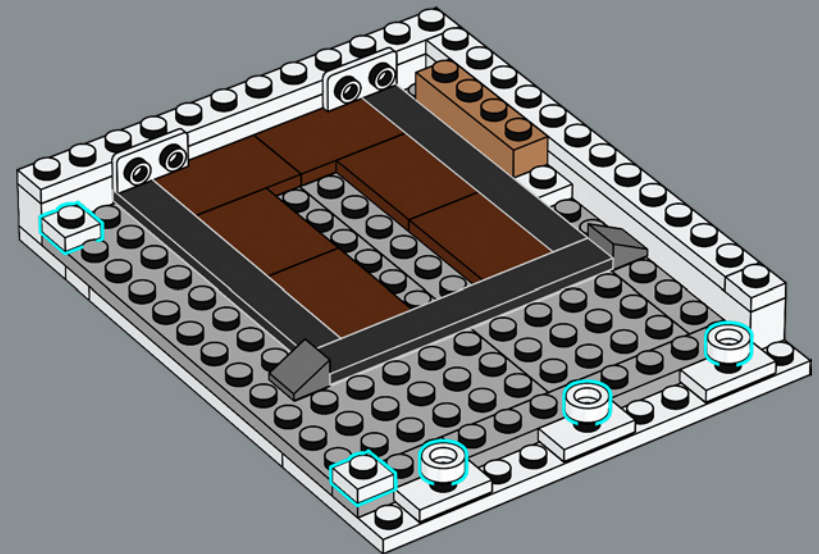



400

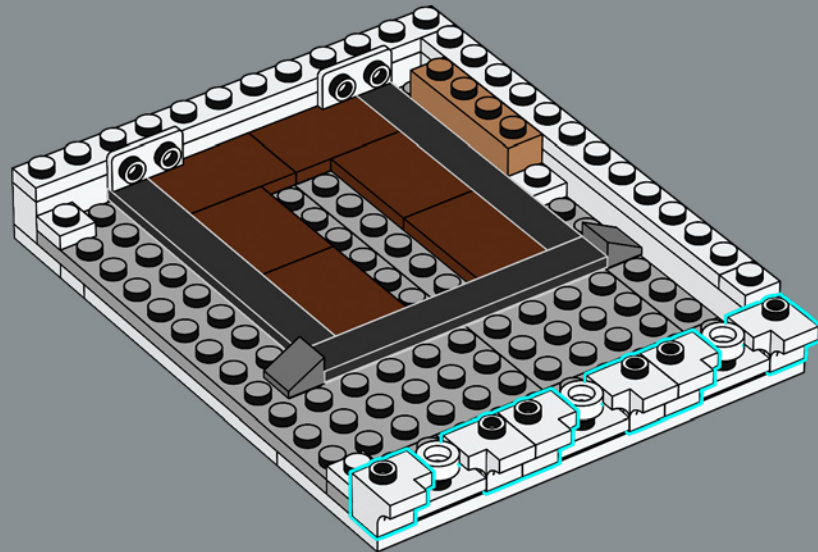

401

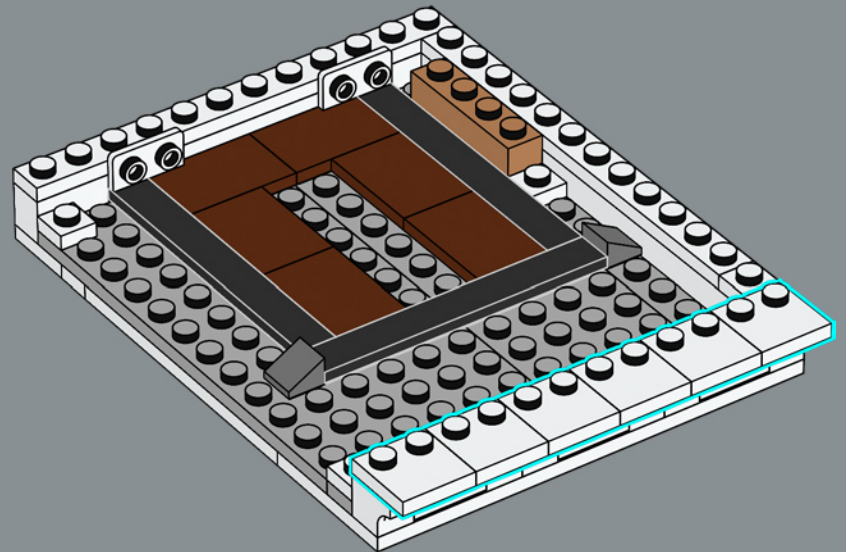

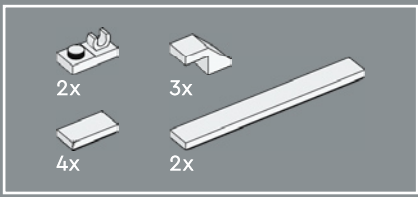

402

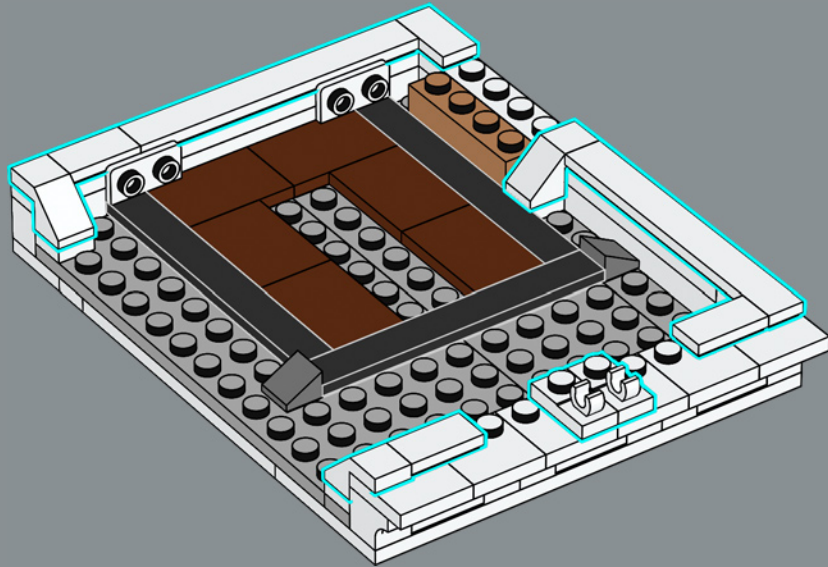

403

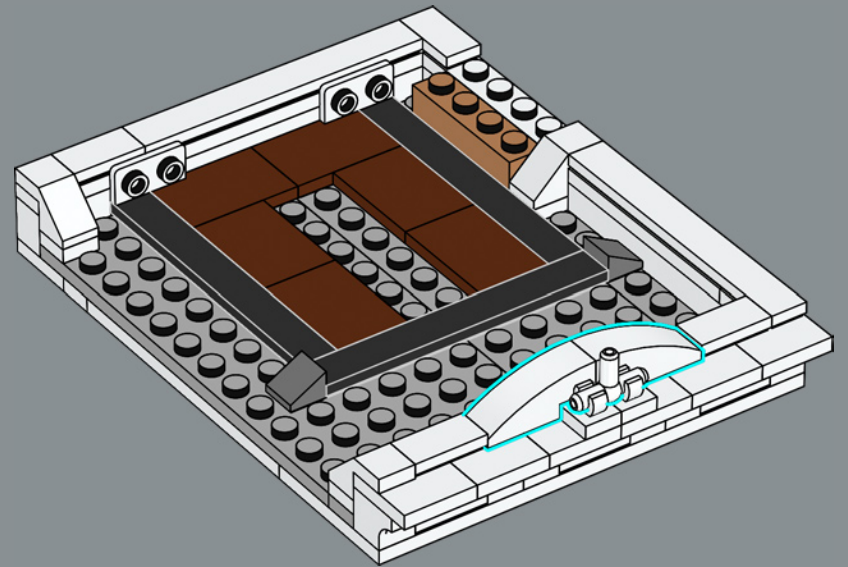

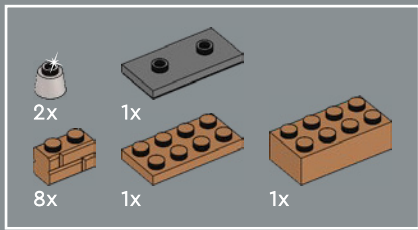

404

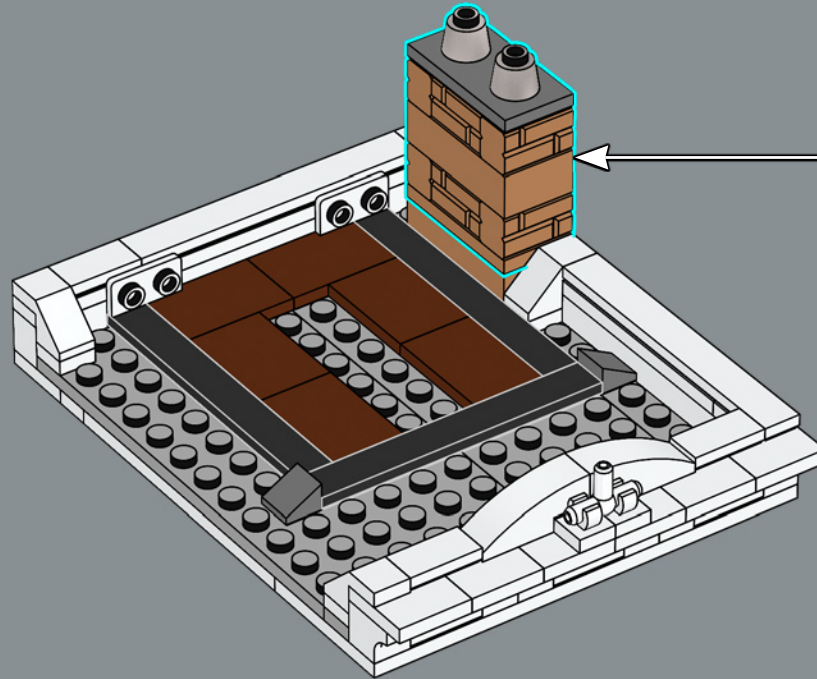
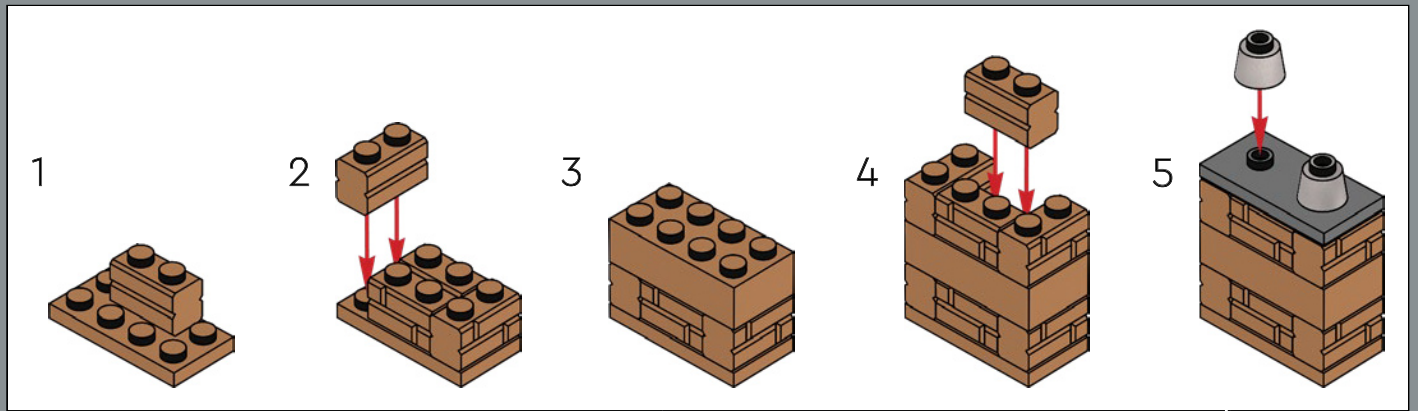

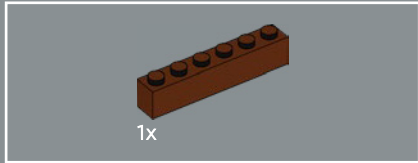

405

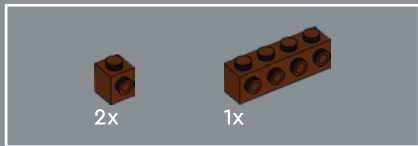
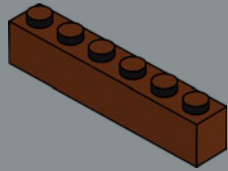

406

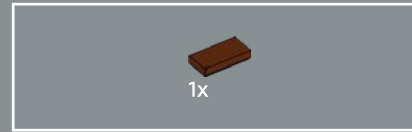
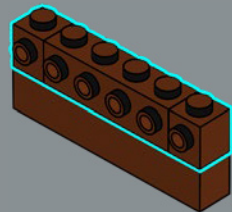

407

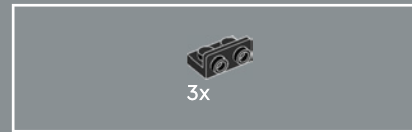
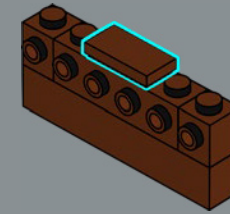

408

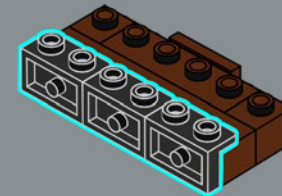

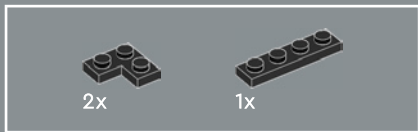

409

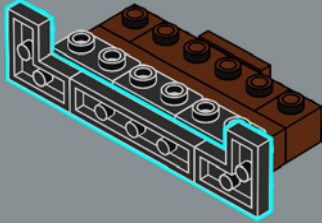

410

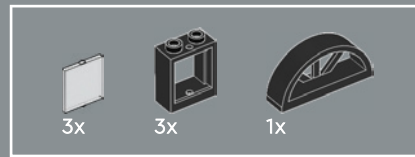
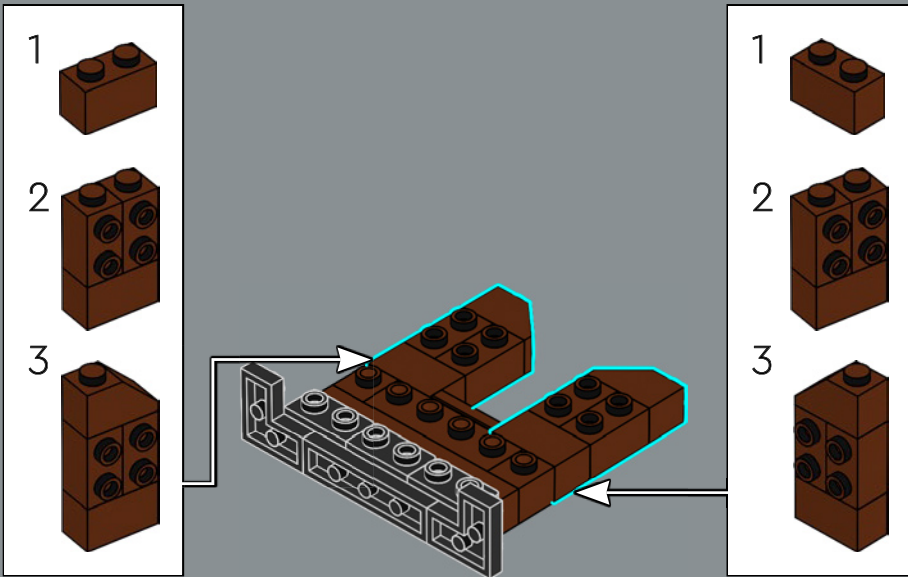

411

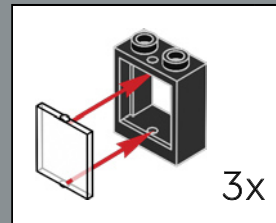
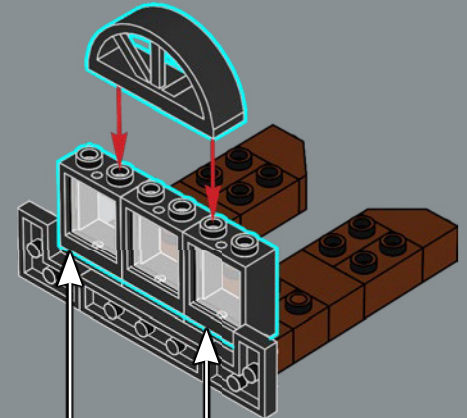

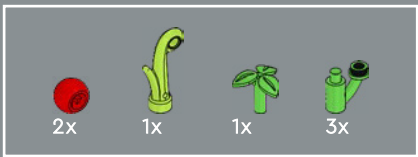

412

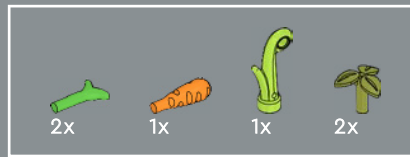
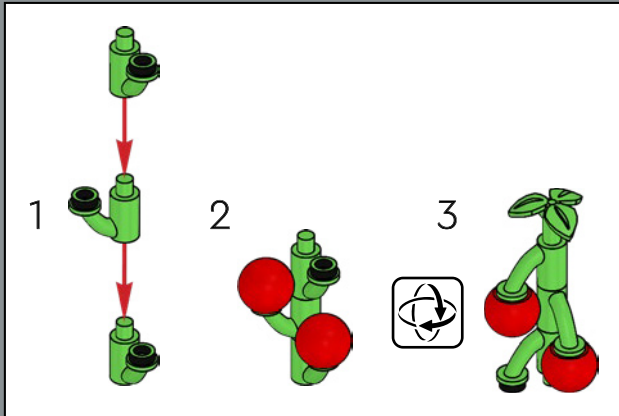

413



The pizza chef grows his own tomatoes and several herbs for his pizzas. The carrot, however, is reserved for the magician's rabbit.

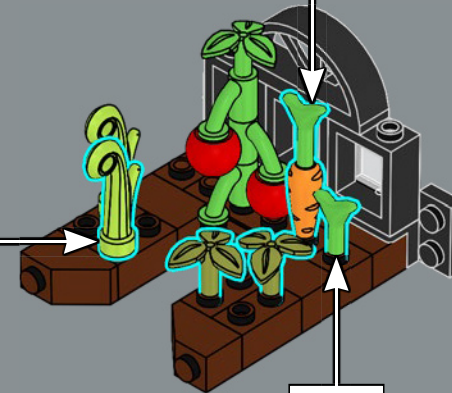
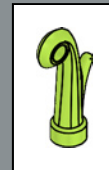
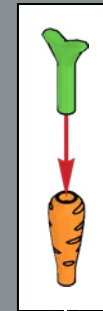

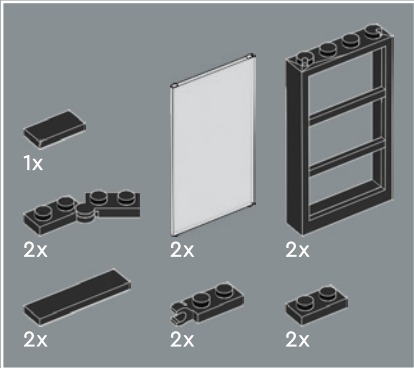

414

1



2

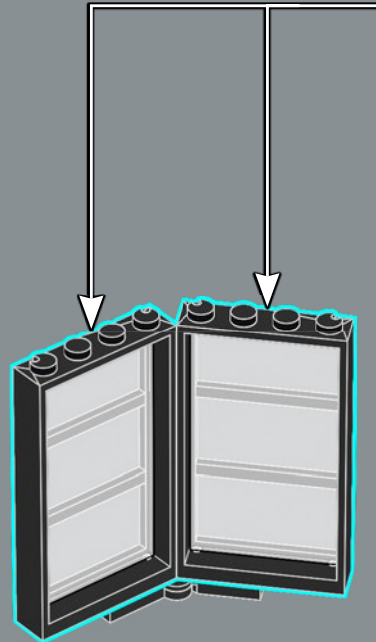

3

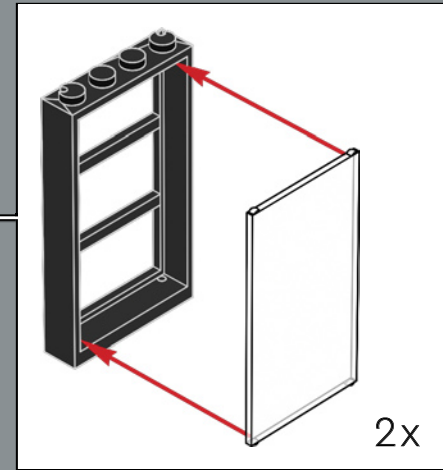
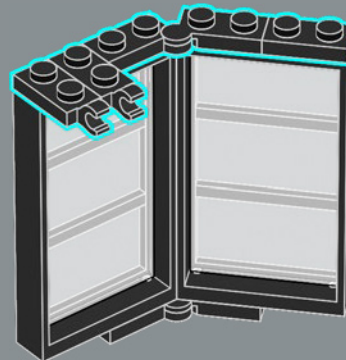

4

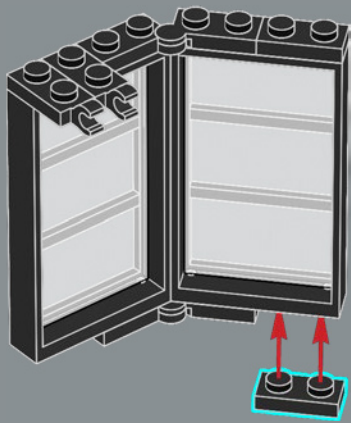

5

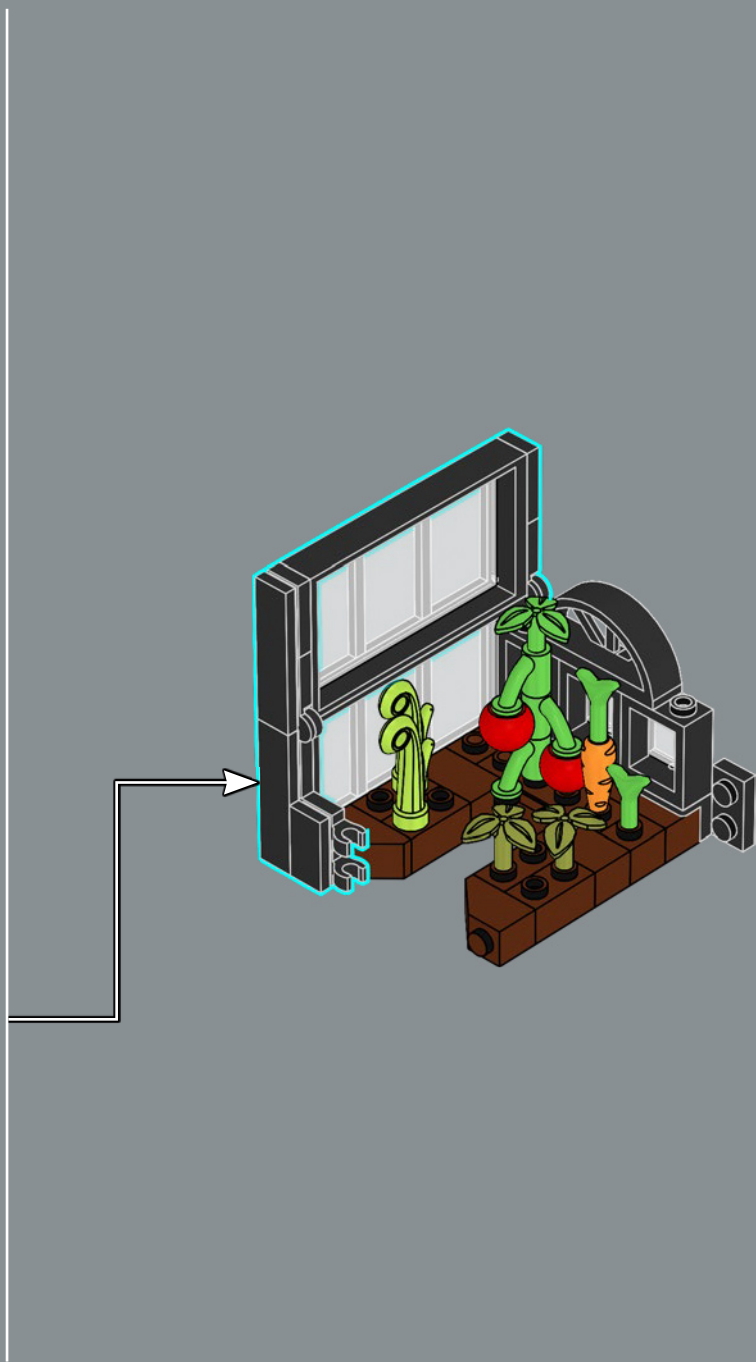
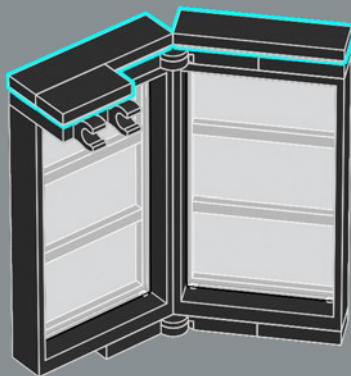

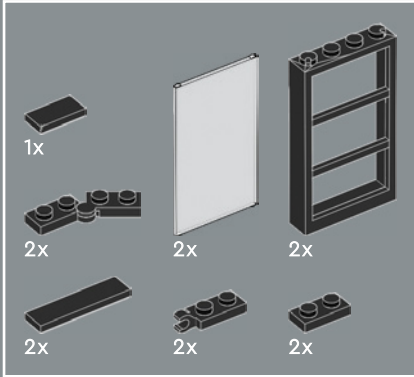
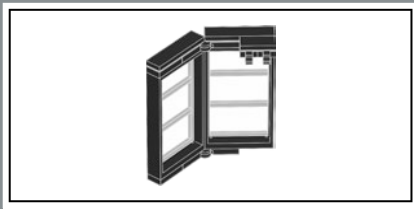

1



2

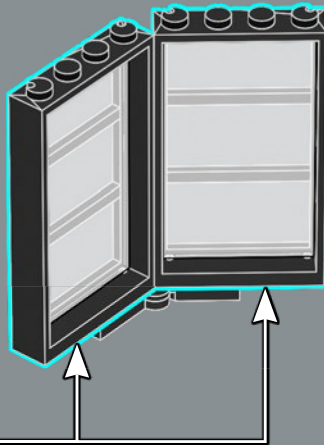

415

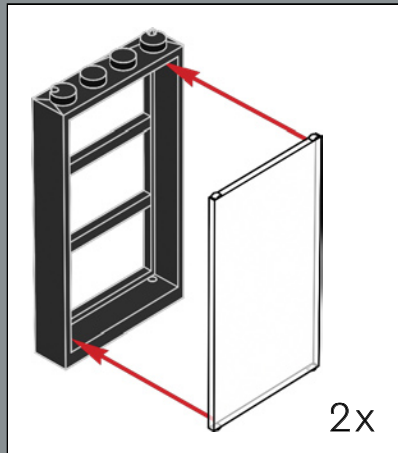

3

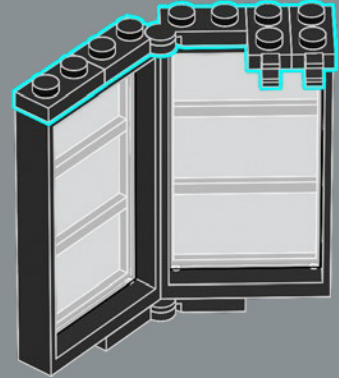

4

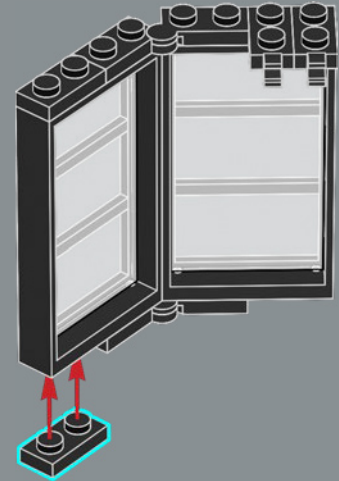

5

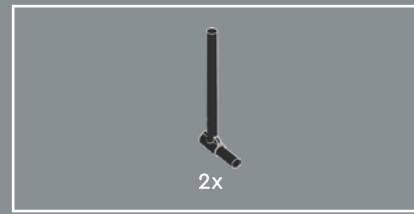
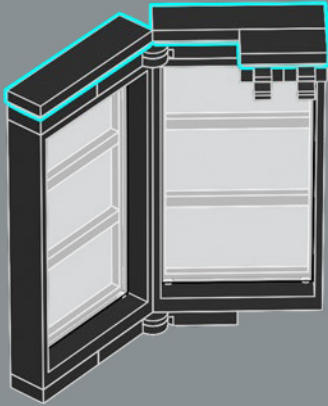

416

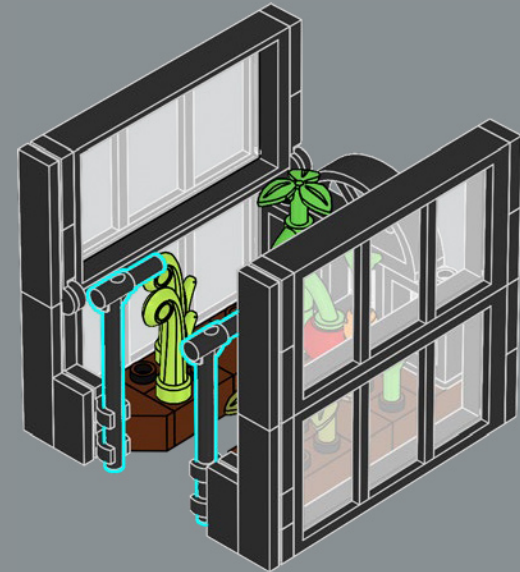
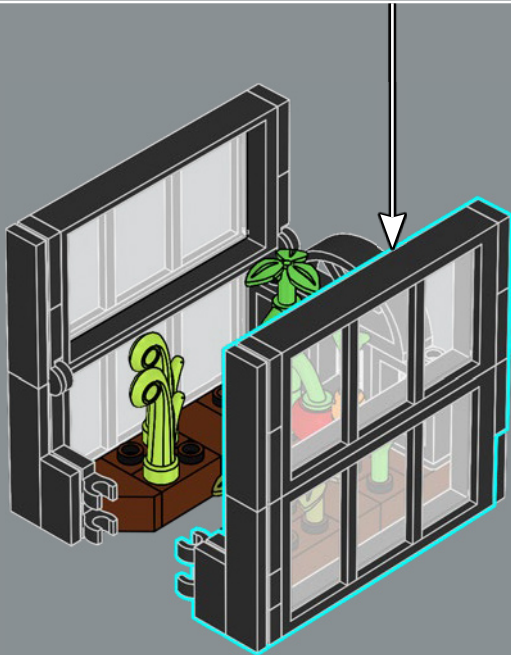

417



418



419

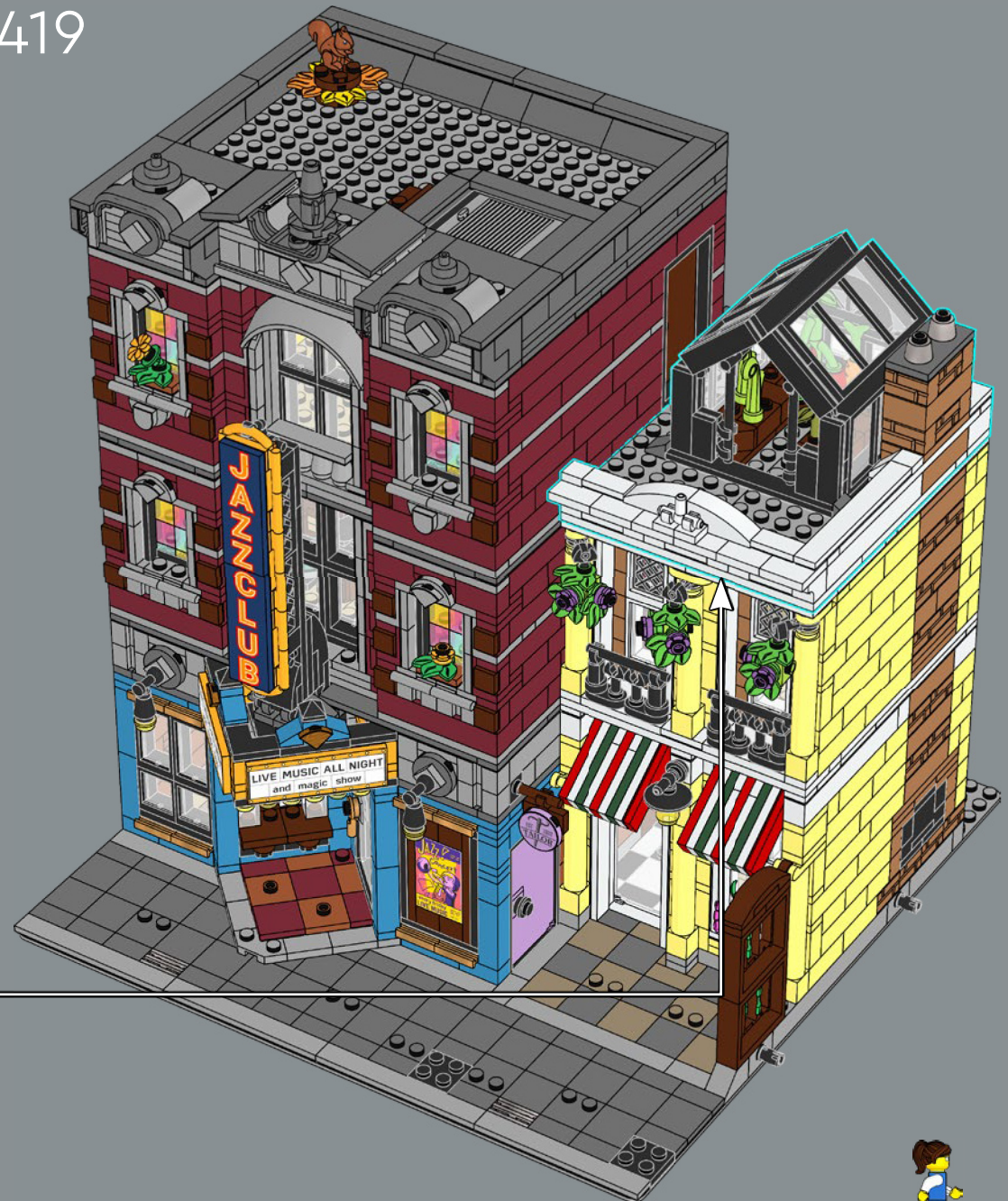



420

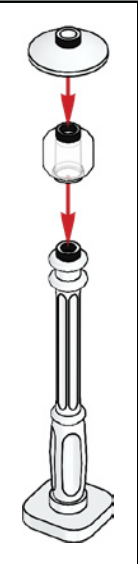
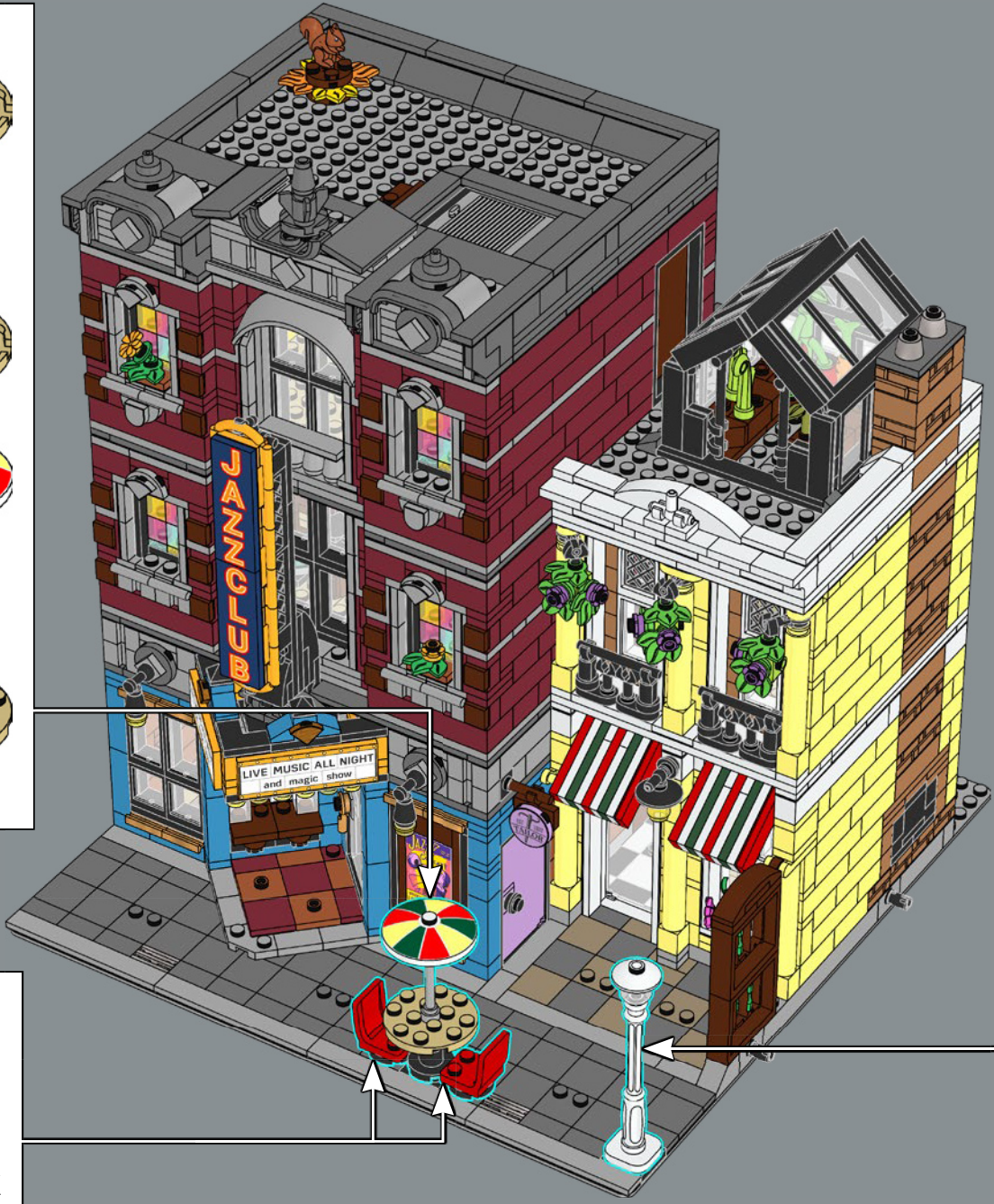
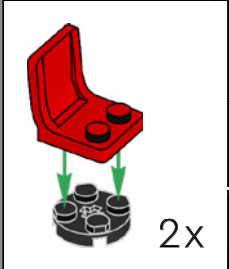
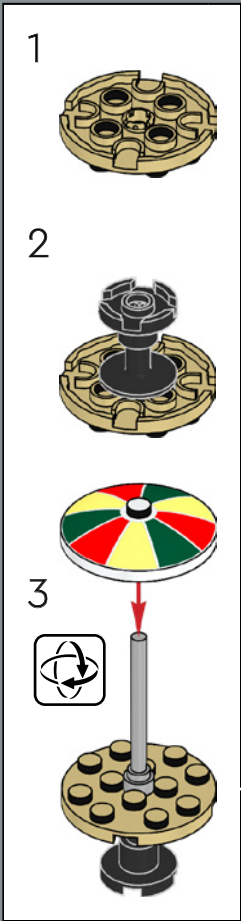



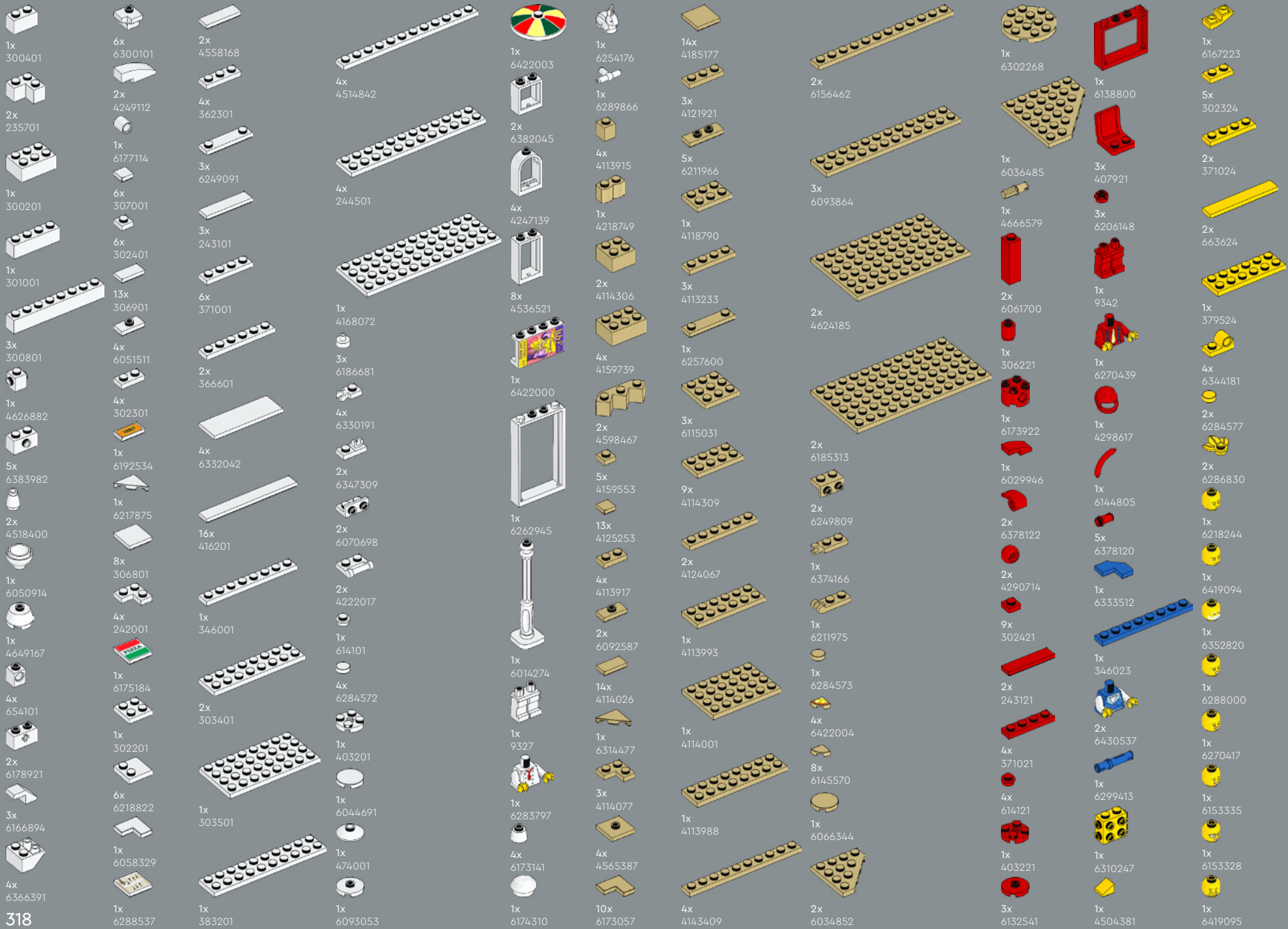



- 3x 4570877
- 2x 4614158
- 2x 6092602
- 2x 6315197
- 4x 6248949
- 1x 6313129
- 1x J5 6172566
- 1x 6384077
- 2x 6220959
- 1x 6251294
- 16x 6252258
- 21x 6254552
- 4x 6256058
- 6x 6253734
- 32
- 1x 6247362
- 1x 6168665
- 1x 6244787
- 2x 6166107
- 1x 6247369
- 1x 6337596
- 4x 6240551
- 8x 6252043
- 1x 6274739
- 1x 6306726
- 1x 6283590
- 4x 6277483
- 2x 6238674
- 8x 6252045
- 6x 6274740
- 19x 6240216
- 1x 6171728
- 1x 4267425
- 2x 6213782
- 3x 6213779
- 1x 6210775
- 2x 6240467
- 8x 6240553
- 3x 6174006
- 2x 6188696
- 1x 6306726
- 1x 4558595
- 2x 6253884
- 1x 6103249
- 1x 6240515
- 1x 6313826
- 1x 6001822
- 1x 6273590
- 9x 6055172
- 4x 4496699
- 1x 6092591
- 5x 4507045
- 2x 6396392
- 17x 6175927
- 1x 6270031
- 1x 6031821
- 2x 6216905
- 1x 6422001
- 1x 6422002
- 2x 6350417
- 2x 4162916
- 103x 6052777
- 10x 4541528
- 4x 6089268
- 2x 6311108
- 24x 4539092
- 1x 4539099
- 2x 6267414
- 2x 6173168
- 2x 6042953
- 24x 4539114
- 2x 4539090
- 61x 4539097
- 10x 4585751
- 2x 4585479
- 23x 4541376
- 70x 4539102
- 31x 4541379
- 18x 6264025
- 2x 4539105
- 4x 4539076
- 2x 4583299
- 2x 4539062
- 3x 4541507
- 2x 6253142
- 4x 6384234
- 2x 6359683
- 2x 6313126
- 17x 6335330
- 6x 6359716
- 3x 6003033
- 8x 6020073
- 2x 6422005
- 6x 6331205
- 1x 6209681
- 1x 6212994
- 2x 6430410
- 2x 6245265
- 4x 6061685
- 2x 6186542
- 4x 6073040
- 4x 6099714
- 4x 6020923
- 1x 6409778
- 1x 6349342
- 2x 4211199
- 4x 6146858
- 1x 4658005
- 24x 4211288
- 3x 4221744
- 2x 4211150
- 2x 4224243
- 4x 4211151
- 4x 4216695
- 4x 6196221
- 1x 6100769
- 6x 6311441
- 1x 6257604
- 3x 4211190
- 1x 4211194
- 2x 6307618
- 1x 4211186
- 1x 4211204
- 2x 4221590
- 1x 4211211
- 1x 4217848
- 2x 6186673
- 2x 6401027
- 2x 6238874
- 1x 6313124
- 2x 6290983
- 1x 6338135
- 3x 4216581
- 1x 6284586
- 2x 4211159
- 4x 6102360
- 1x 6342958
- 1x 6075207
- 1x 6228841
- 1x 6428805
- 1x 6267760
- 1x 6093515
- 1x 6422007
- 6x 6248918
- 2x 6271128
- 2x 4595889
- 6x 4211206
- 12x 6310449
- 4x 6159763
- 1x 4609635
- 2x 6261744
- 3x 4211242
- 2x 4211149
- 1x 4211193
- 4x 6201911
- 3x 6062574
- 3x 6103004
- 1x 6153594
- 1x 6036503
- 2x 6151461

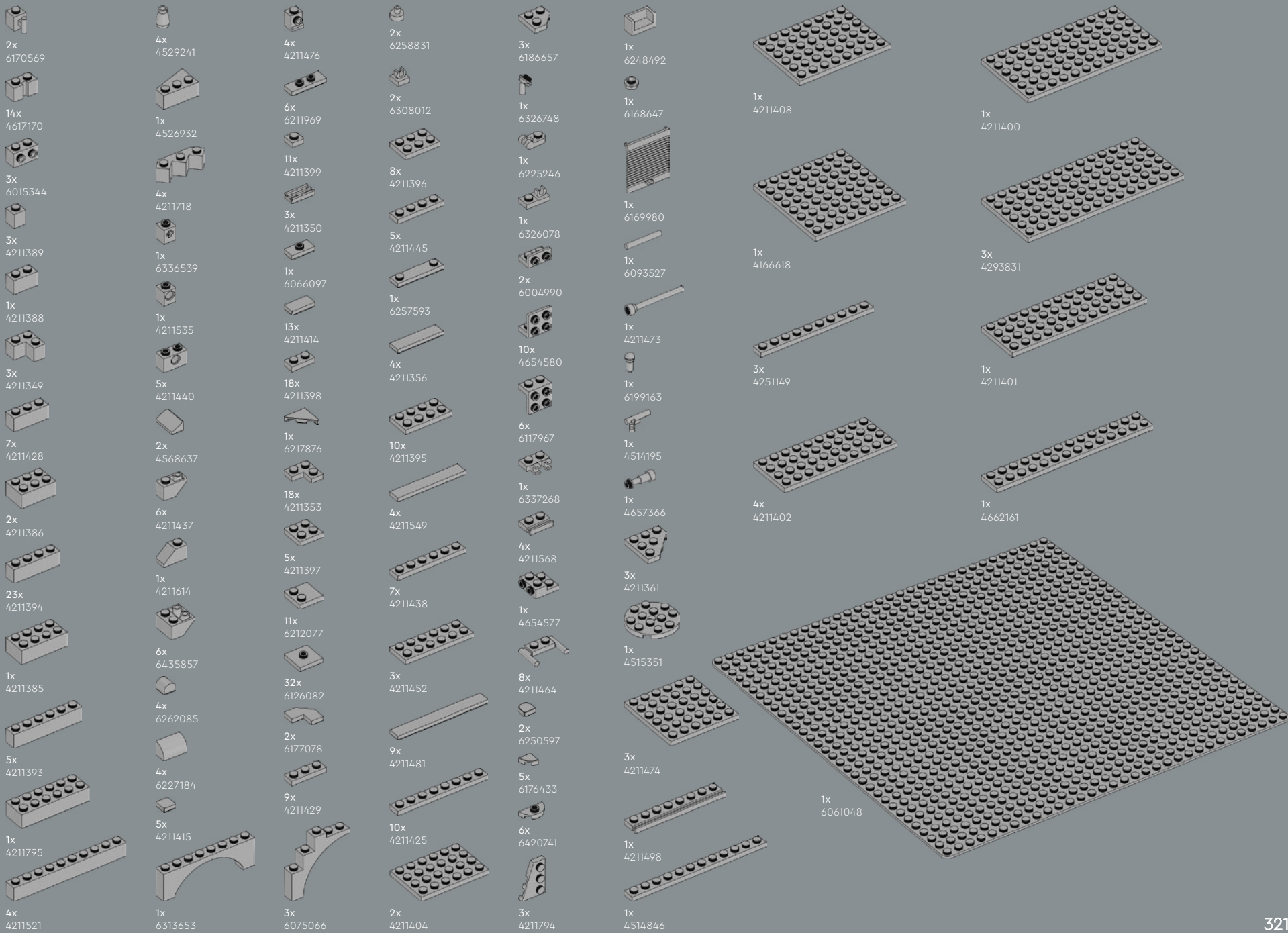

- 4x 4210719
- 11x 4210848
- 1x 4648256
- 4x 4210631
- 42x 4211052
- 16x 6247784
- 32x 4211055
- 5x 6309059
- 4x 6177079
- 6x 4568734
- 2x 4211133
- 3x 4211043
- 8x 4211053
- 6x 4211001
- 10x 6257592
- 1x 6307616
- 6x 4560184
- 1x 4211056
- 11x 4210651
- 2x 4210875
- 5x 4211099
- 2x 6321746
- 1x 6170420
- 1x 6350724
- 1x 6310596
- 1x 6245283
- 3x 6178912
- 2x 6331222
- 6x 4211044
- 1x 4529240
- 4x 4504378
- 1x 4211054
- 4x 4211127
- 1x 6333129
- 2x 6029948
- 2x 4211109
- 1x 4211103
- 2x 6271752
- 1x 6413106
- 2x 6296892
- 2x 6000606
- 18x 4211008
- 8x 4210997
- 3x 6133611
- 2x 6365692
- 1x 6271127
- 5x 6284596
- 1x 6199549
- 1x 4211042
- 6x 6115080
- 2x 6411395
- 2x 6388124
- 6x 6209684
- 1x 6149768
- 1x 6431074
- 2x 6344038
- 2x 6285465
- 6x 6150307
- 1x 6058368
- 1x 6386209
- 2x 6206151
- 21x 6022084
- 42x 6022083
- 2x 6212064
- 19x 6201646
- 35x 6036232
- 18x 6430416
- 6x 6380625
- 2x 6316263
- 4x 6070301
- 3x 6190252
- 5x 4523159
- 11x 6058014
- 13x 6201647
- 1x 6248756
- 2x 6296524
- 3x 6211356
- 2x 6296964
- 3x 6319958
- 3x 6296501
- 1x 4549990
- 2x 4655690
- 1x 4529247
- 1x 6335111
- 8x 6338242
- 3x 6190252
- 5x 4523159
- 1x 6173654
- 1x 6093529
- 1x 6038163
- 3x 6167585
- 1x 6390147
- 1x 6158322
- 10x 6057986
- 26x 4656783
- 4x 4569382
- 4x 6055309
- 6x 6223183
- 6x 6135191
- 1x 6099341
- 3x 6174192
- 1x 6273854
- 1x 6106193
- 7x 6292154
- 4x 6021997
- 4x 6218360
- 2x 6102994
- 8x 6177535
- 1x 6102990
- 3x 6334099
- 1x 6187006
- 2x 6102998
- 3x 6167700
- 4x 6093494
- 3x 6295464
- 2x 6313600
- 2x 6347304
- 4x 6313599
- 1x 6312464
- 1x 6163633
- 2x 4619636
- 2x 6317181
- 1x 6096993
- 9x 6420725
- 9x 6004943
- 3x 6154879
- 4x 6004938
- 1x 6404754
- 4x 6133838
- 4x 6151658
- 10x 6151664
- 3x 6133728
- 1x 6210675
- 7x 6151657
- 3x 6223733
- 1x 4258308
- 1x 6420734
- 2x 6092111
- 2x 6278156
- 1x 4540203
- 2x 4211469
- 2x 6251591
- 2x 6078236
- 1x 6227939



[LEGO.com/service](https://www.LEGO.com/service)



YOU COULD WIN



YOU COULD WIN

Your feedback will help shape the future development of this product series.

Visit:

DU KÖNNTEST GEWINNEN

Dein Feedback trägt zur Weiterentwicklung dieser Produktreihe bei.

Geh auf:

VOUS POURRIEZ GAGNER

Vos commentaires nous aideront à concevoir les futurs produits de cette gamme.

Visitez :

POTRESTI VINCERE TU

La tua opinione ci aiuterà a migliorare la creazione futura di questa linea di prodotti.

Visita:

PUEDES GANAR

Tu opinión contribuirá al futuro de esta serie de productos.

Visita:

轻松获奖

您的反馈将有助于我们在今后改进本产品系列。

请访问:

LEGO.com/productfeedback

You also have the chance to win a LEGO® set.

Terms and conditions apply.*

Außerdem hast du die Chance, ein LEGO® Set zu gewinnen.

Es gelten die Teilnahmebedingungen.*

Vous pourriez également gagner un ensemble LEGO®.

Des conditions s'appliquent.*

Hai anche la possibilità di vincere un set LEGO®.

Termini e condizioni sono applicabili.*

También tienes la oportunidad de ganar un set LEGO®.

Aplican términos y condiciones.*

您还有机会赢取乐高®套装。

条款和条件适用。*

*LEGO.com/productfeedback-terms

