



Booklet available in English on
Livret disponible en français sur
Folleto disponible en español en



PRIZED FOR CENTURIES, FOREVER IN BLOOM

Theophrastus, a student of Aristotle, loved them. Confucius, the great philosopher, wrote poems for them. For centuries, orchids have found their way into the hearts of many, and today they find their way into yours. While other orchids require the highest levels of attention, the LEGO® Orchid will thrive even in low light, does not require extreme humidity and is probably the easiest to get to bloom again and again.

APPRÉCIÉES DEPUIS DES SIÈCLES, TOUJOURS DANS LA FLEUR DE L'ÂGE

Théophraste, un étudiant d'Aristote, les adorait. Confucius, le grand philosophe, a écrit des poèmes à leur sujet. Depuis des siècles, les orchidées trouvent leur place dans le cœur de nombreuses personnes, et aujourd'hui, elles trouveront leur place dans le vôtre. Alors que d'autres orchidées nécessitent une attention particulière, l'orchidée LEGO® s'épanouit même en faible lumière, ne nécessite pas d'humidité extrême et est probablement la plus facile à faire fleurir encore et encore.

APRECIADAS DURANTE SIGLOS, SIEMPRE EN FLOR

A Teofrasto, un alumno de Aristóteles, le encantaban. Confucio, el gran filósofo, les dedicó algunos poemas. Las orquídeas se han ganado el corazón de muchos durante siglos, y es probable que hoy también se ganen el tuyo. Mientras que otras orquídeas requieren toda la atención de sus cuidadores, las Orquídeas LEGO® resisten la falta de luz, no requieren humedad extrema y pueden florecer una y otra vez con muy poco esfuerzo.





The three models cannot be built simultaneously.
Les trois modèles ne peuvent pas être construits simultanément.
No es posible construir simultáneamente los tres modelos.

FLOWERS JUST THE WAY YOU LIKE IT

Featuring six full blossoms and two smaller buds, you can trim stems to different lengths, rotate roots and leaves to keep them healthy, and get new arrangements simply by moving blossoms around any way you like.

DES FLEURS COMME VOUS LES AIMEZ

Avec six fleurs épanouies et deux bourgeons plus petits, vous pouvez tailler les tiges à différentes longueurs, faire tourner les racines et les feuilles pour les garder en bonne santé, et créer de nouveaux arrangements en plaçant les fleurs à votre gré.

FLORES TAL COMO TE GUSTAN

El set incluye seis flores abiertas en plenitud y dos botones más pequeños. Puedes modificar la longitud de los tallos y rotar las raíces y hojas para mantenerlas sanas, así como cambiar la imagen del conjunto simplemente reubicando las flores a tu antojo.



FROM THE DESIGN TEAM

Mike has been designing LEGO® products for well over 9 years now. Creating the geometry of the pot was one of his favorite challenges in this model. *"Designing orchids that sit in a sand-blue fluted pot, that are not only fun to build but also beautiful to look at, was an exciting challenge for me. While real orchids were brought in to inspire me, I must admit that the LEGO Orchid is far easier to care for and is certainly a lot more enjoyable to be around."*

Michael Psiaki, Design Master

UN MOT DE L'ÉQUIPE DE CONCEPTION

Mike conçoit des produits LEGO® depuis maintenant plus de 9 ans. Dans ce modèle, l'un de ses défis préférés a été de créer la géométrie du pot. *« Concevoir des orchidées qui reposent dans un pot cannelé bleu sable, qui sont non seulement amusantes à construire mais aussi belles à regarder, a été un défi passionnant pour moi. Bien qu'on m'ait apporté de vraies orchidées pour m'inspirer, je dois admettre que l'orchidée LEGO est beaucoup plus facile à entretenir et agréable à côtoyer. »*

Michael Psiaki, maître de la conception

IMPRESIONES DEL EQUIPO DE DISEÑO

Mike ha diseñado productos LEGO® por más de 9 años. Crear la geometría de la maceta fue uno de sus desafíos favoritos al trabajar con este modelo. *"Diseñar orquídeas plantadas en una maceta estriada de color azul tenue que fueran hermosas a la vista, además de divertidas de construir, significó un emocionante desafío para mí. Tuve algunas orquídeas en mi oficina para inspirarme, y debo admitir que las Orquídeas LEGO son mucho más fáciles de cuidar; definitivamente, te permiten disfrutar más de tu espacio".*

Michael Psiaki, maestro de diseño

**GROW YOUR
COLLECTION OF
LEGO® BOTANICAL
MODELS**

**AGRANDISSEZ
VOTRE COLLECTION
DE MODÈLES
BOTANIQUES LEGO®**

**HAZ CRECER TU
COLECCIÓN DE
MODELOS LEGO®
BOTANICAL**



10280
Flower Bouquet
Le bouquet de fleurs
Ramo de Flores



10289
Bird Of Paradise
L'oiseau de paradis
Ave del Paraíso



10281
Bonsai tree
Le bonsai
Bonsái



10309
Succulents
Les succulentes
Suculentas

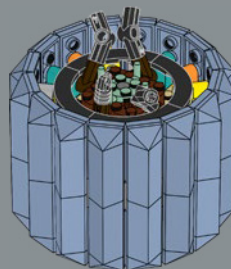
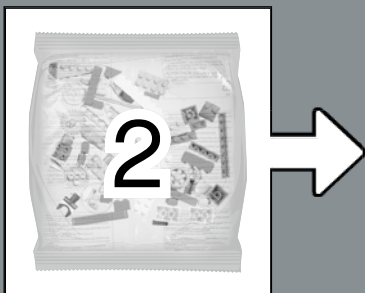
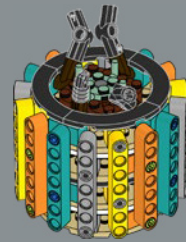
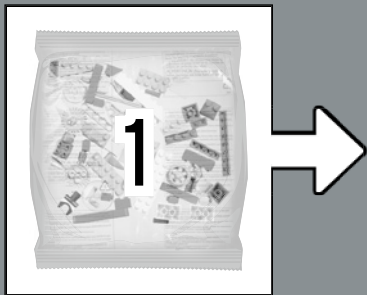
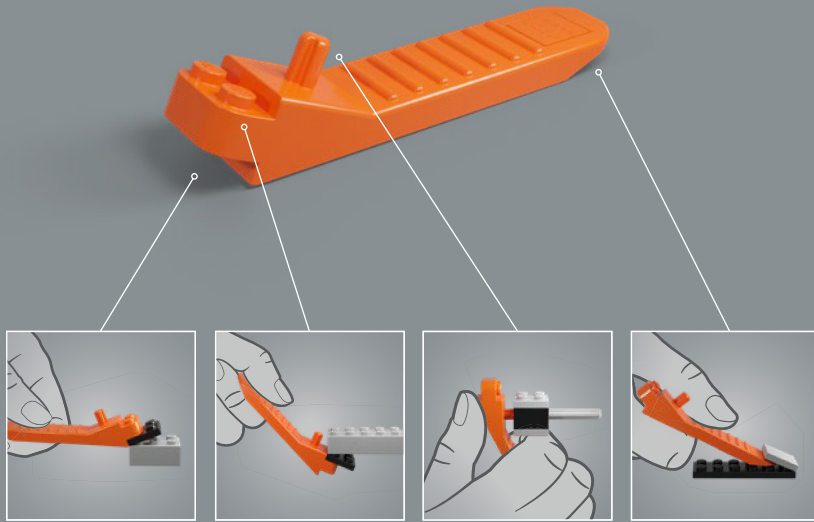

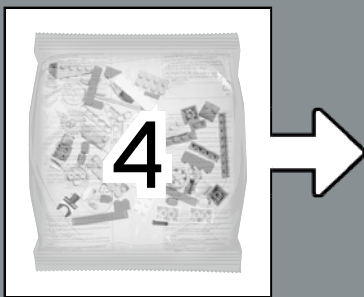
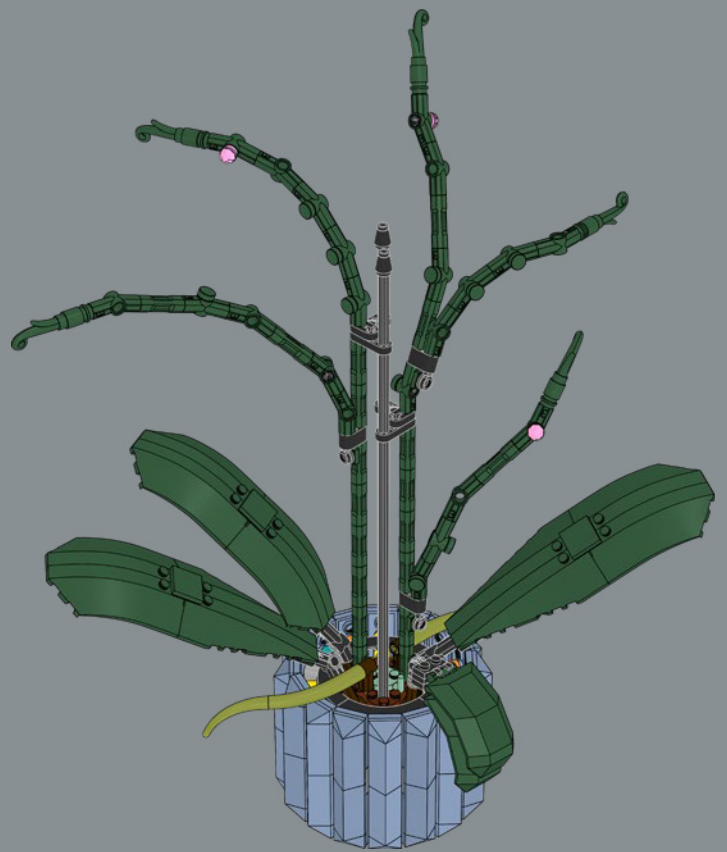
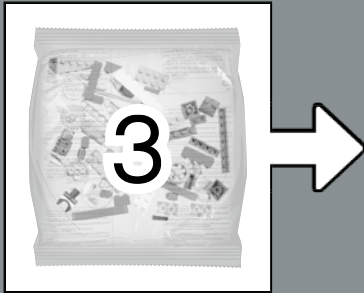

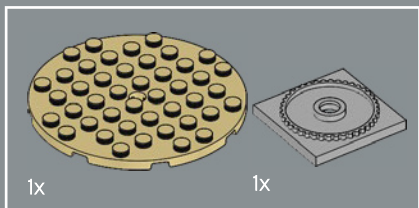

1

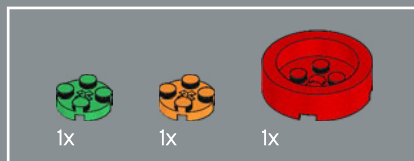
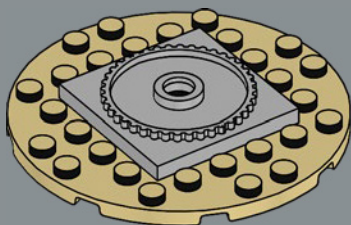

2

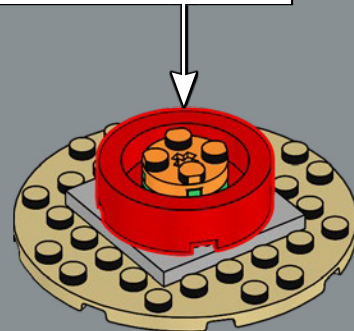
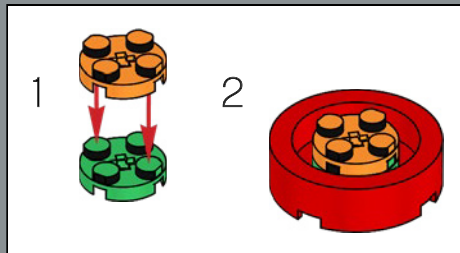



3

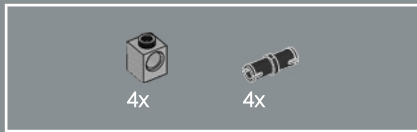
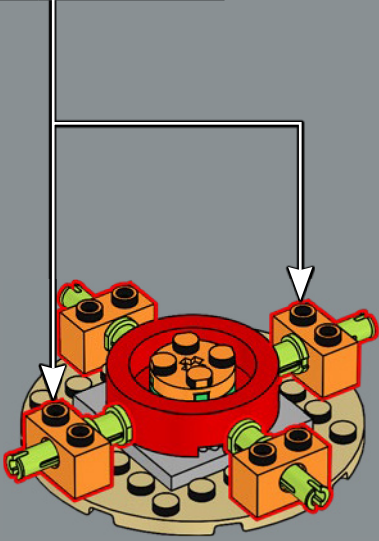
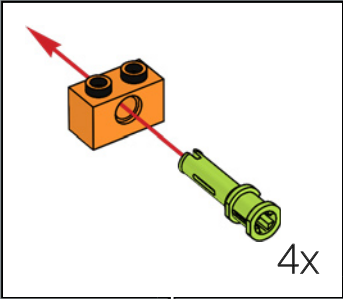

4

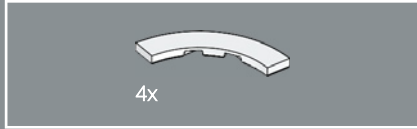
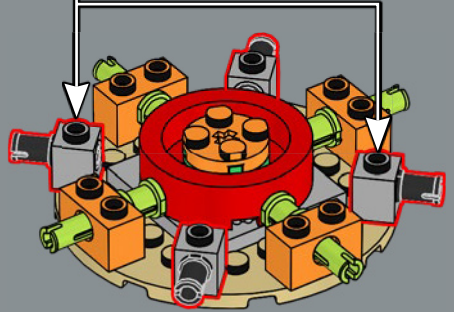
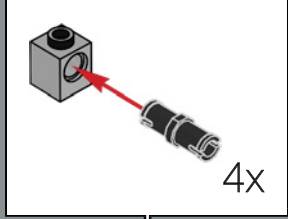

5



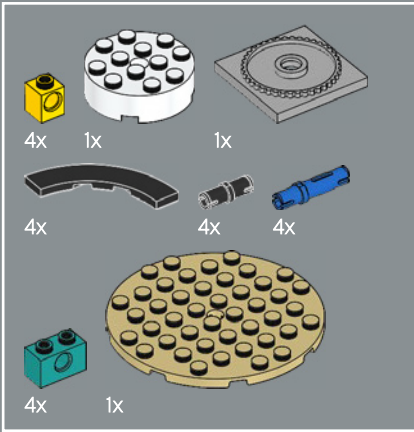
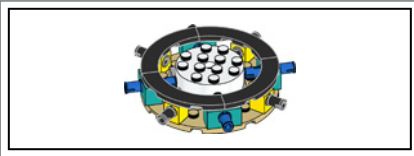

6

1

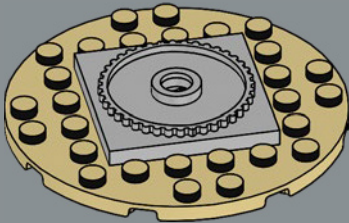

2

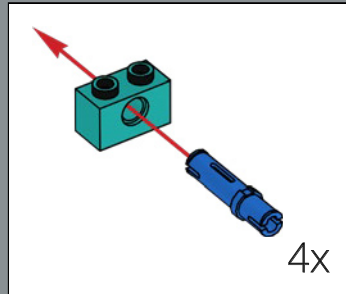
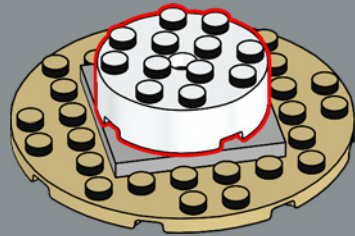

3

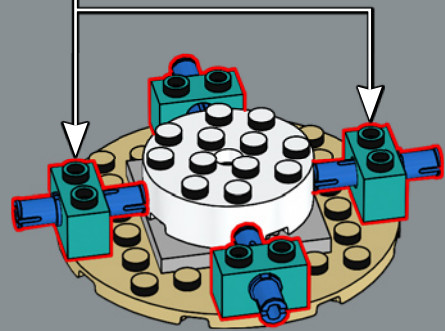

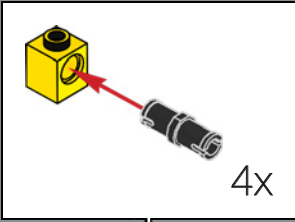

4

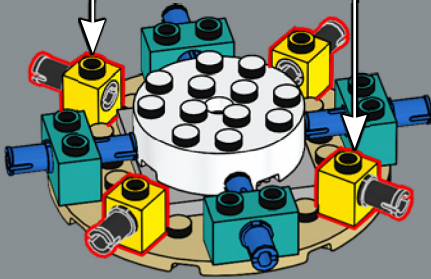

5

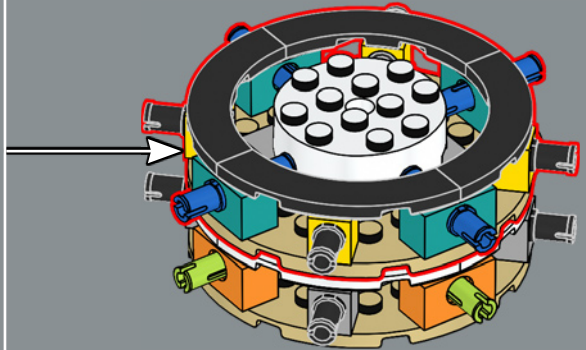
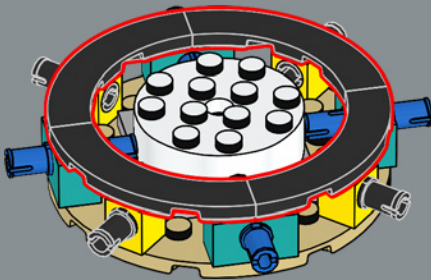

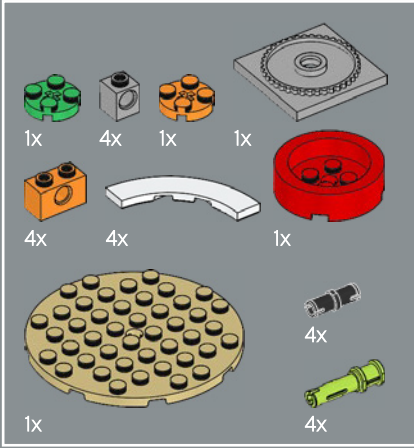
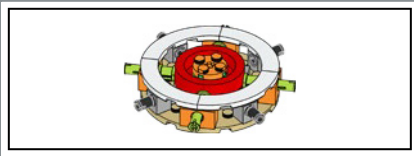

7

1

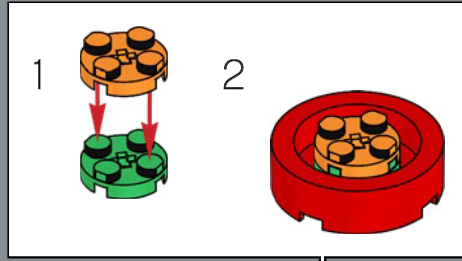
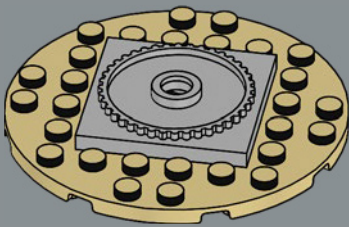

2

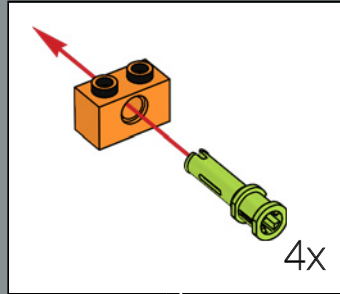
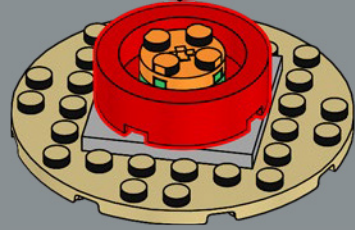

3

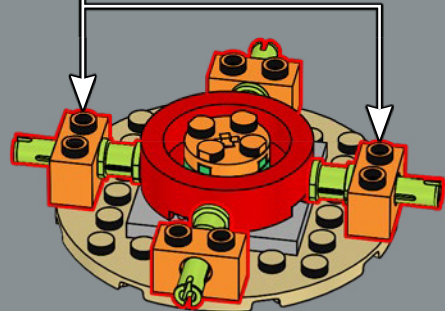



The core of the pot is a modified version of the core used in the large tower of the LEGO® Hogwarts™ Castle set – Professor Sprout would be tickled with this.

La base du pot est une version modifiée de la base utilisée dans la grande tour de l'ensemble LEGO® Le château de Poudlard. Professeure Chourave serait ravie.

El centro de la maceta es una versión modificada del núcleo de la torre más grande del set LEGO® Castillo de Hogwarts™. ¡A la Profesora Sprout le encantaría este modelo!

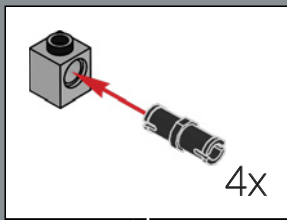

4

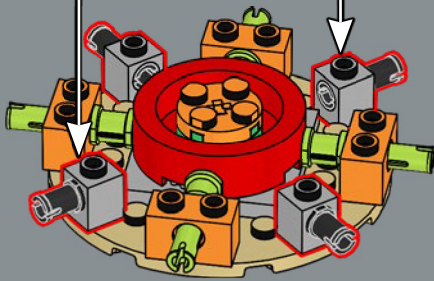

5

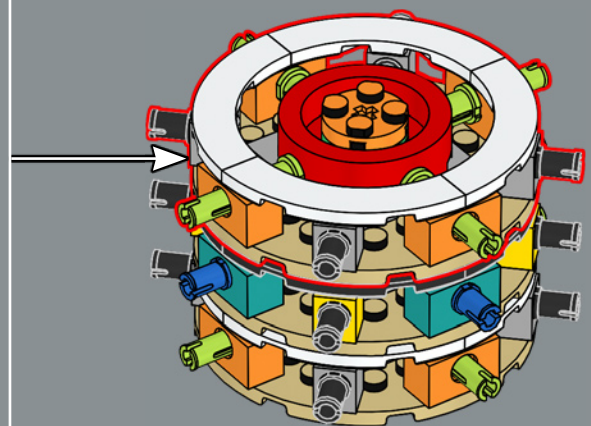
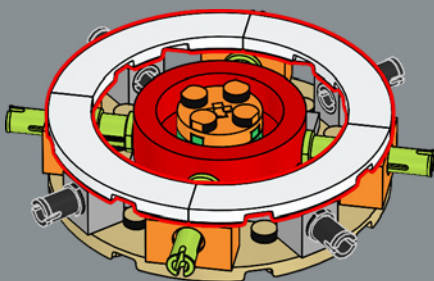

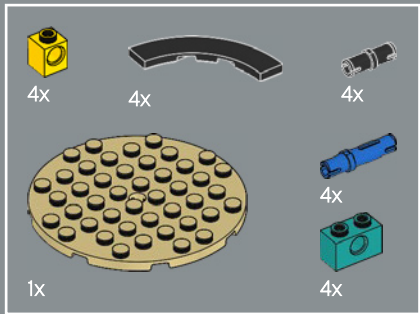

8

1

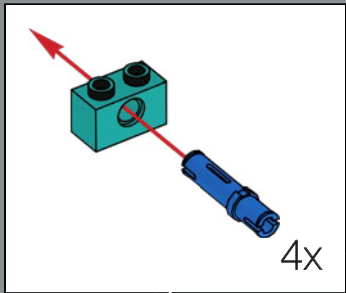
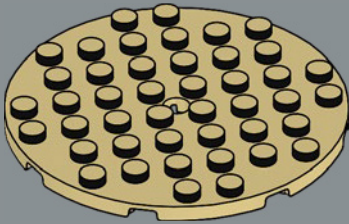

2

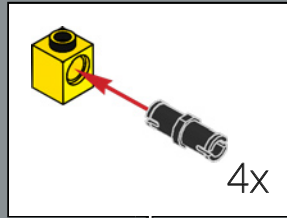
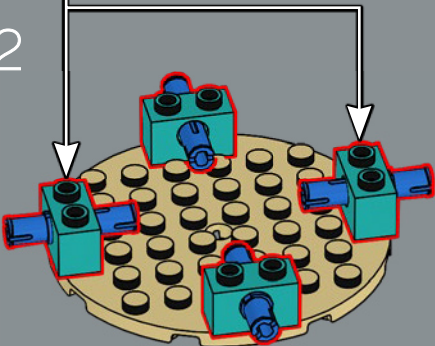

3

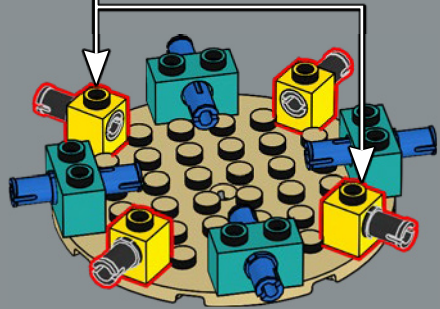

4

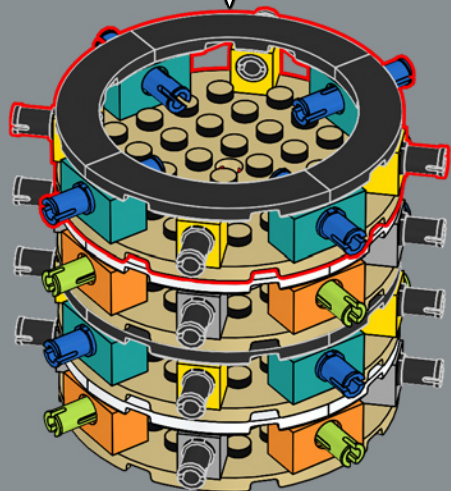
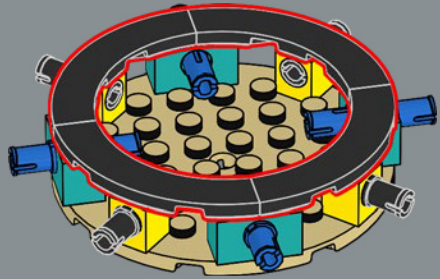

9

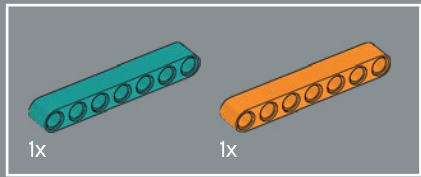
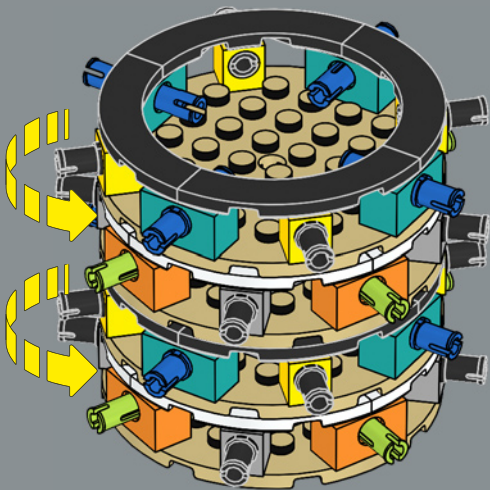

10

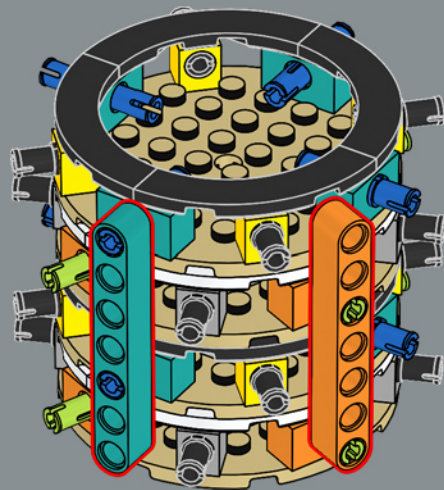

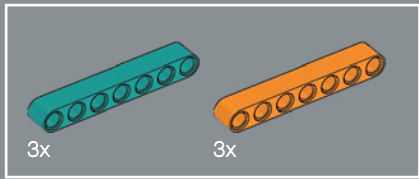

11

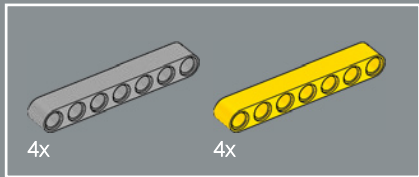
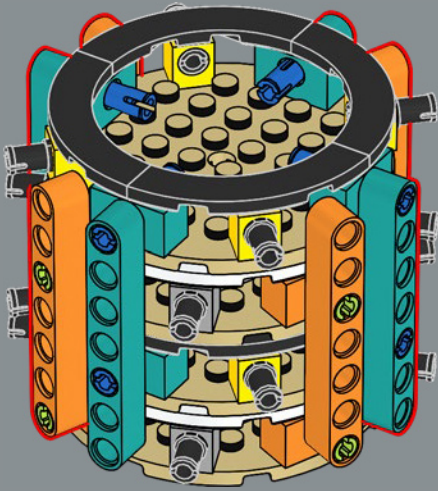

12

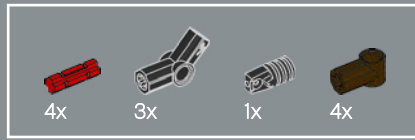
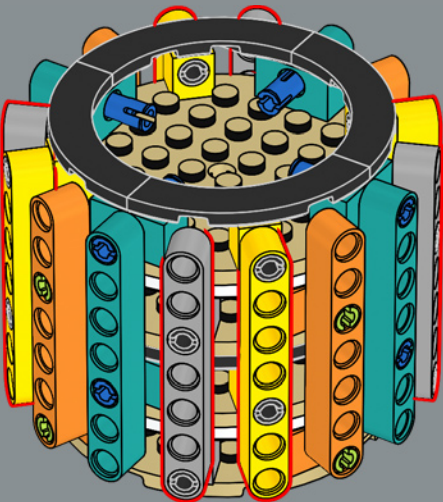

13

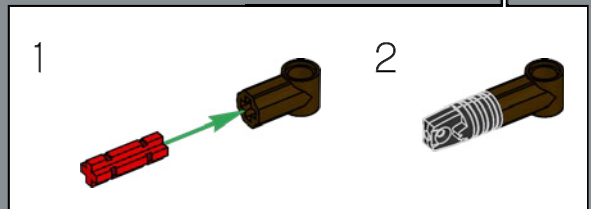
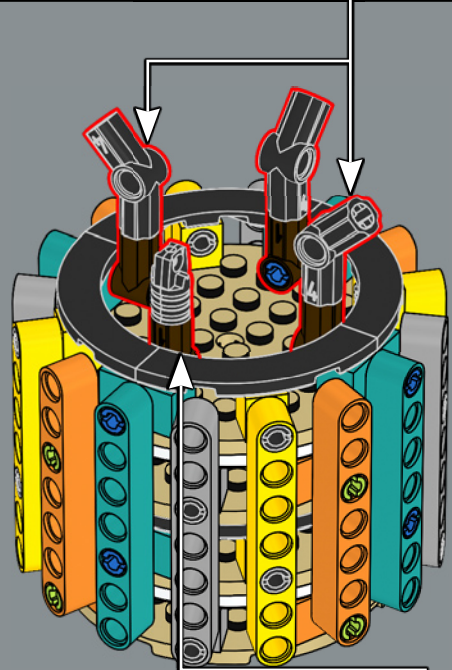
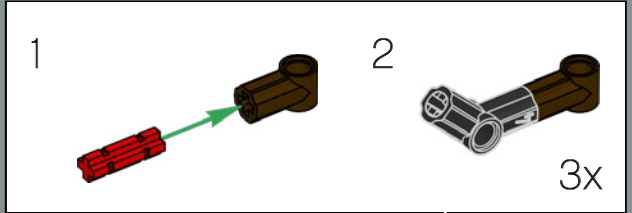



14

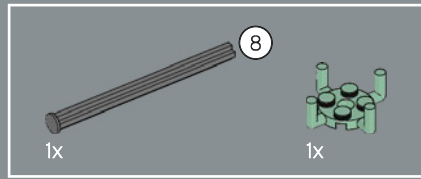
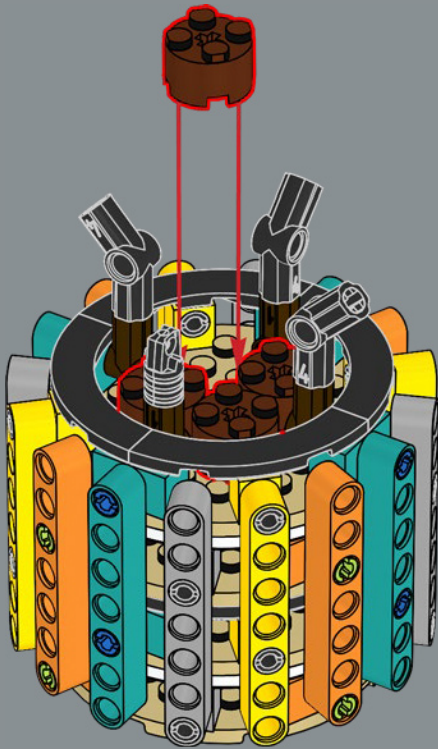

15

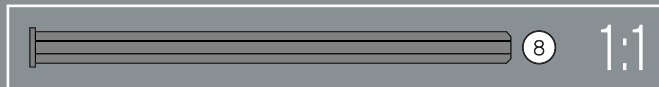
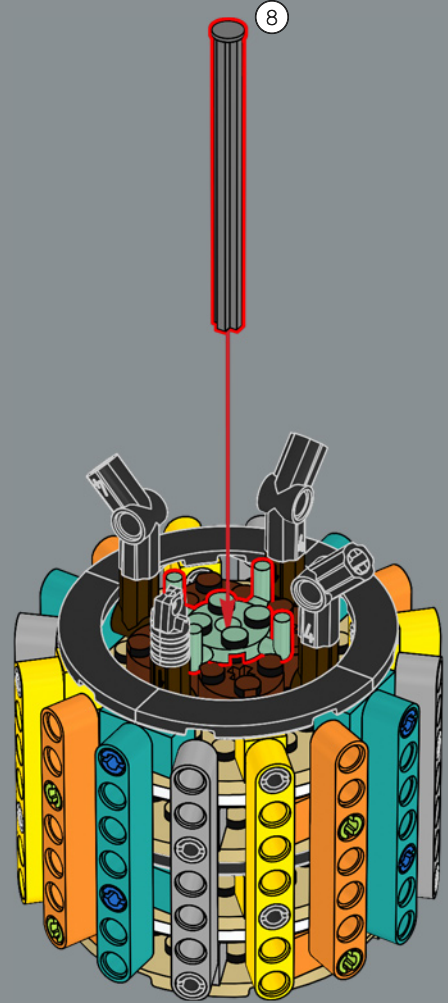

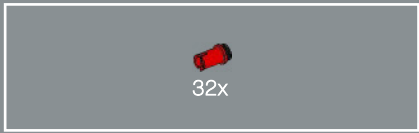

16

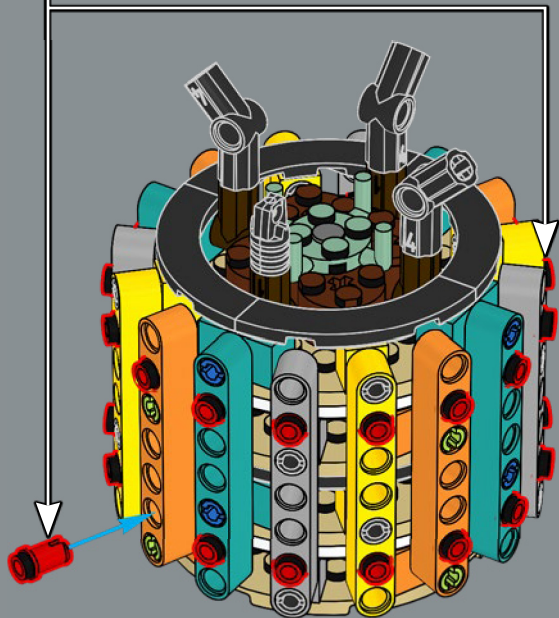

18

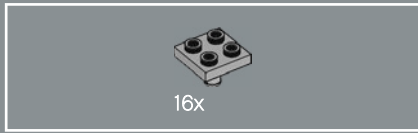

17

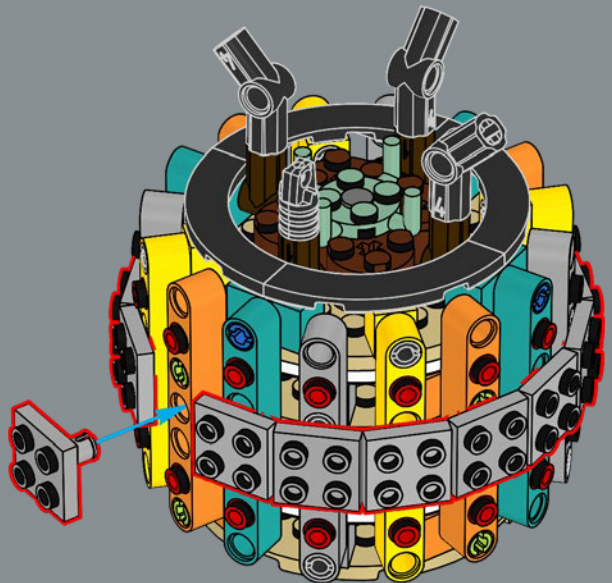

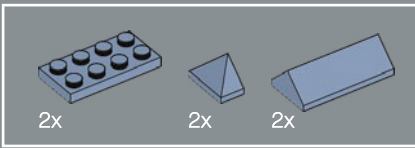

18

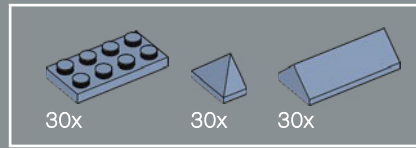
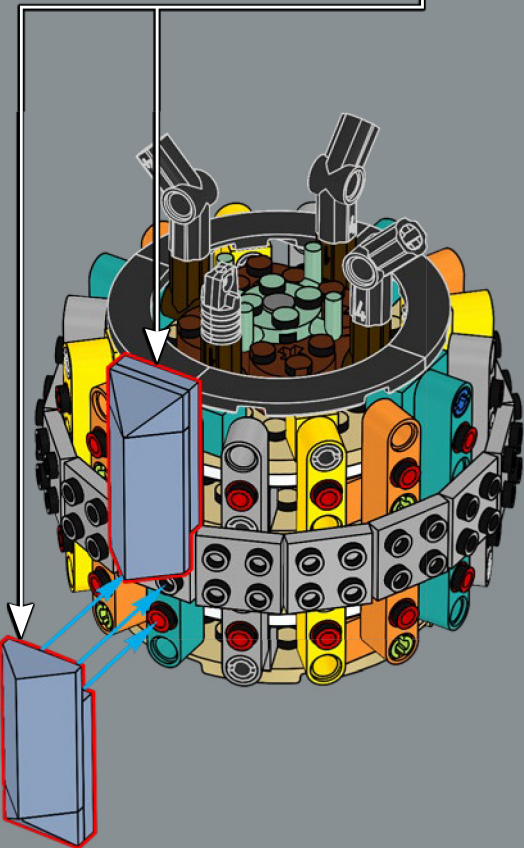
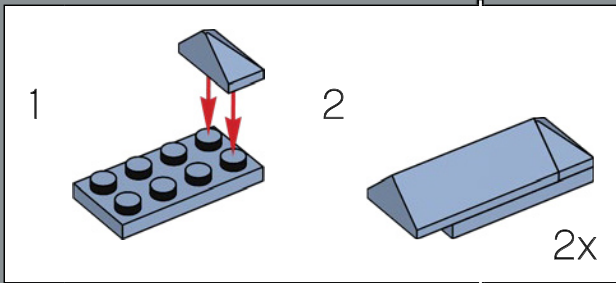

19

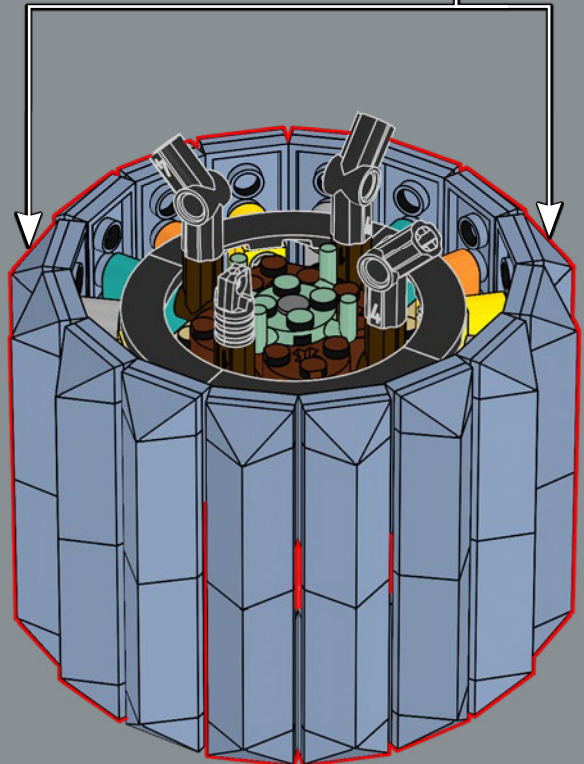
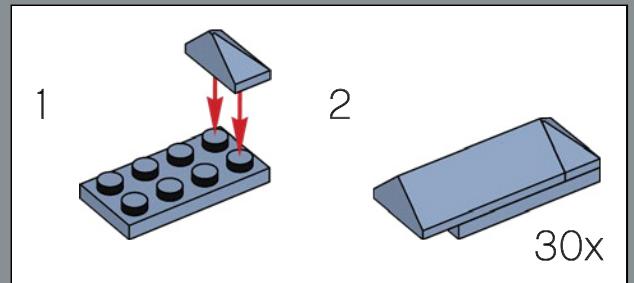

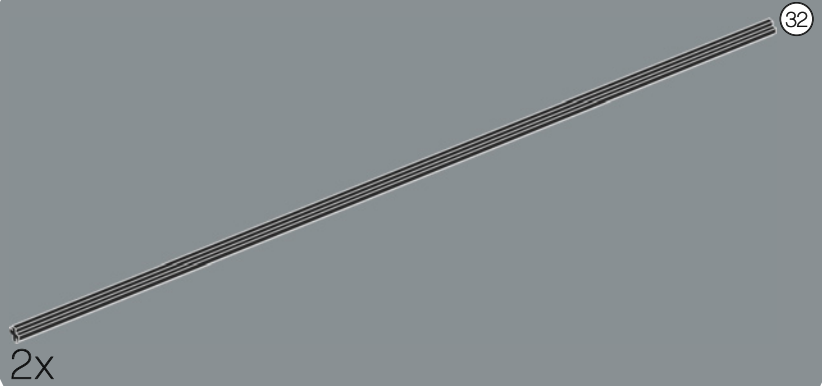
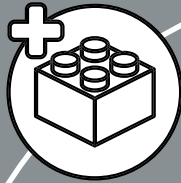



20

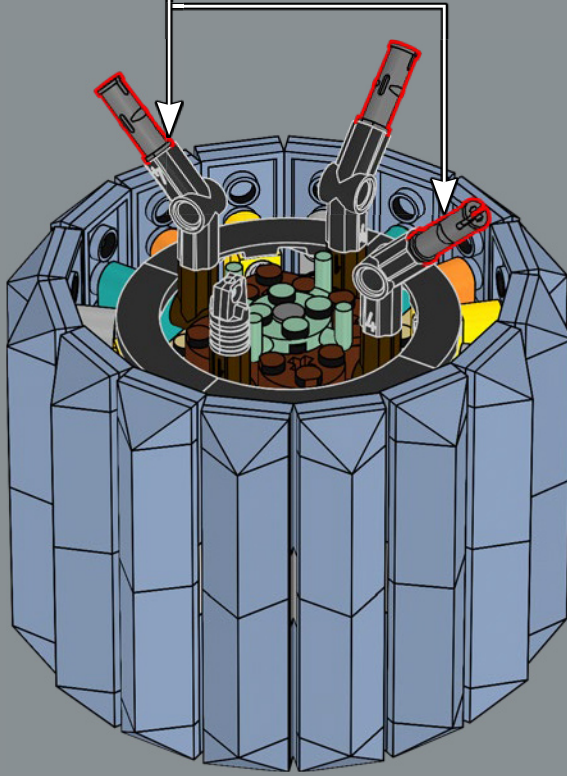
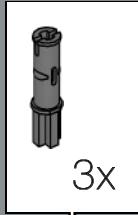

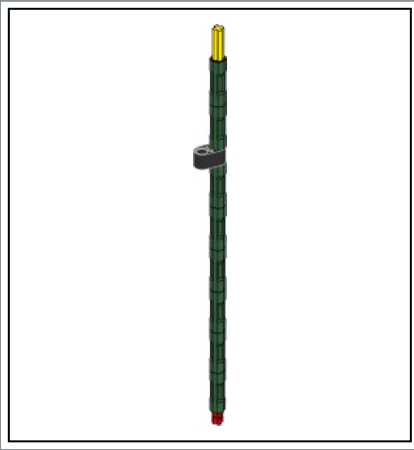

21



22

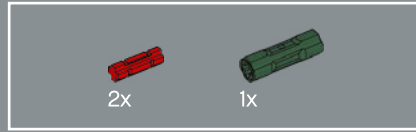
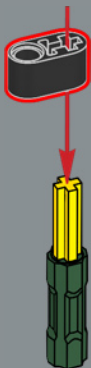

23



24

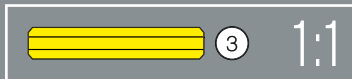

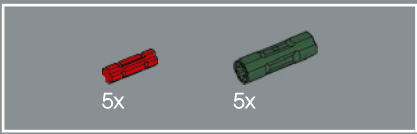

25

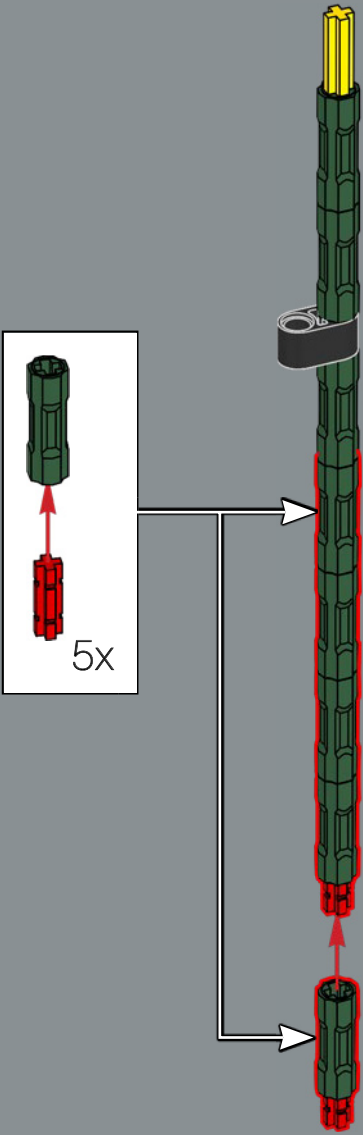

26

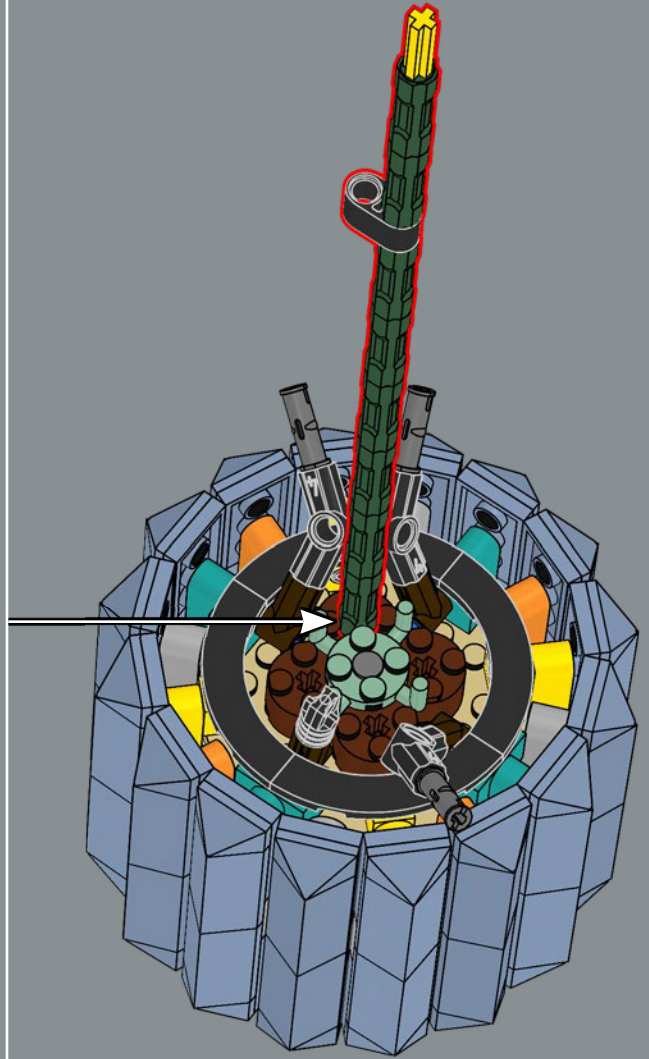

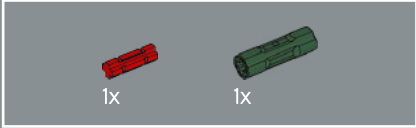
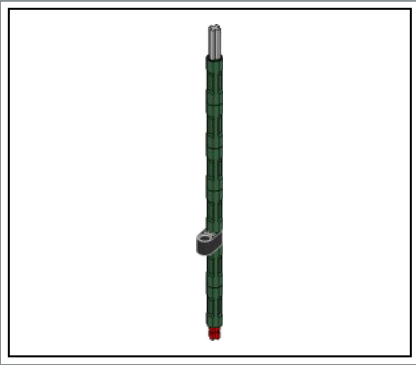

27

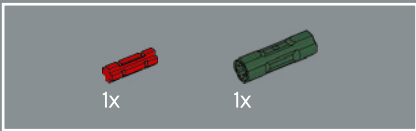
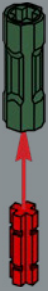

28

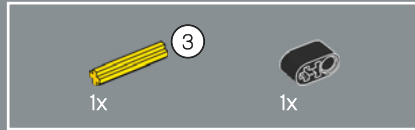

29

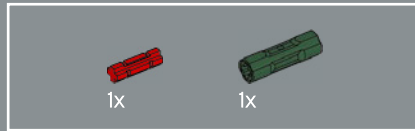
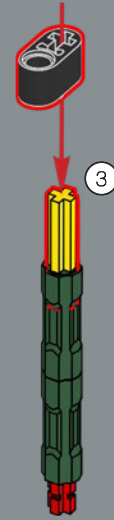

30

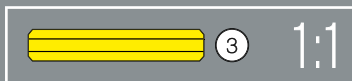

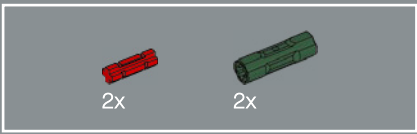

31

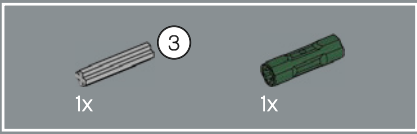
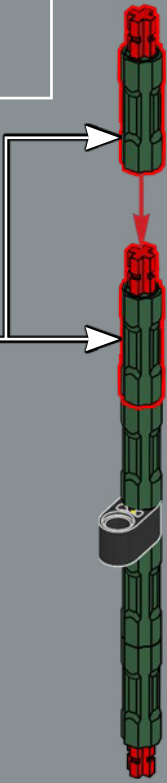
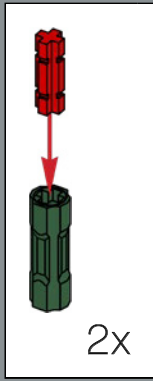

32



33

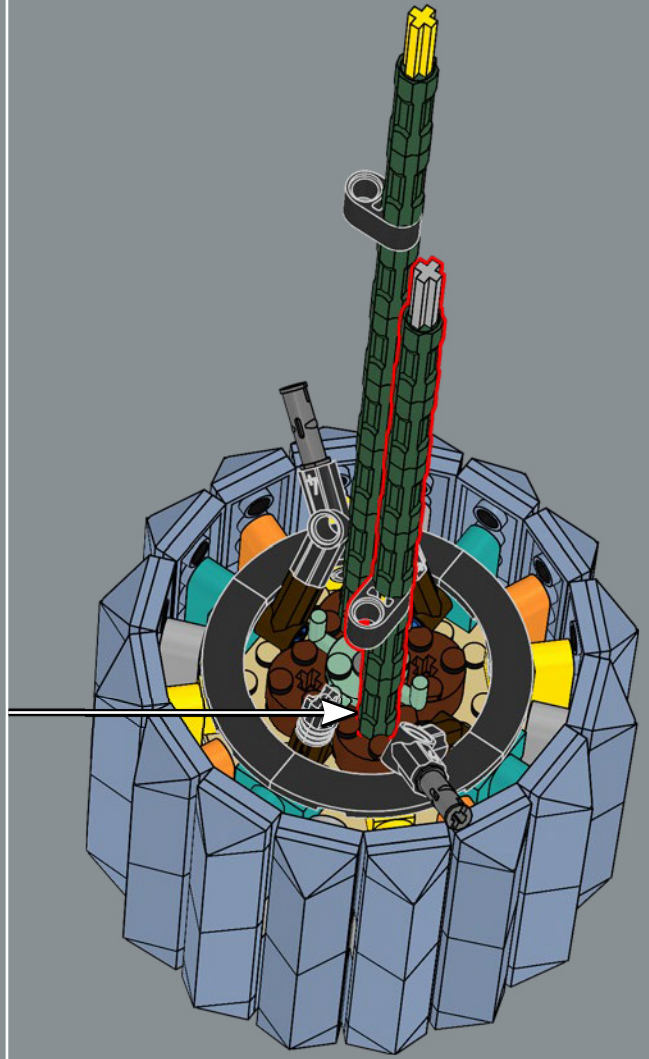

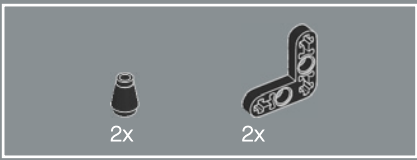

34

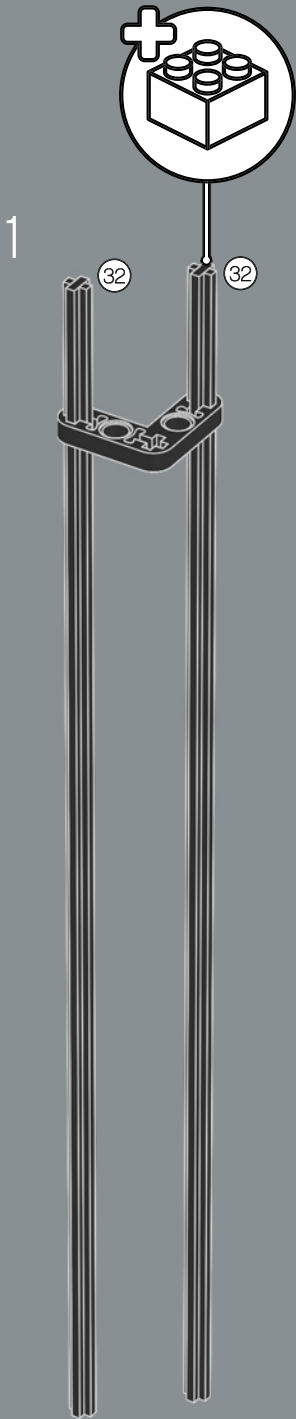

35

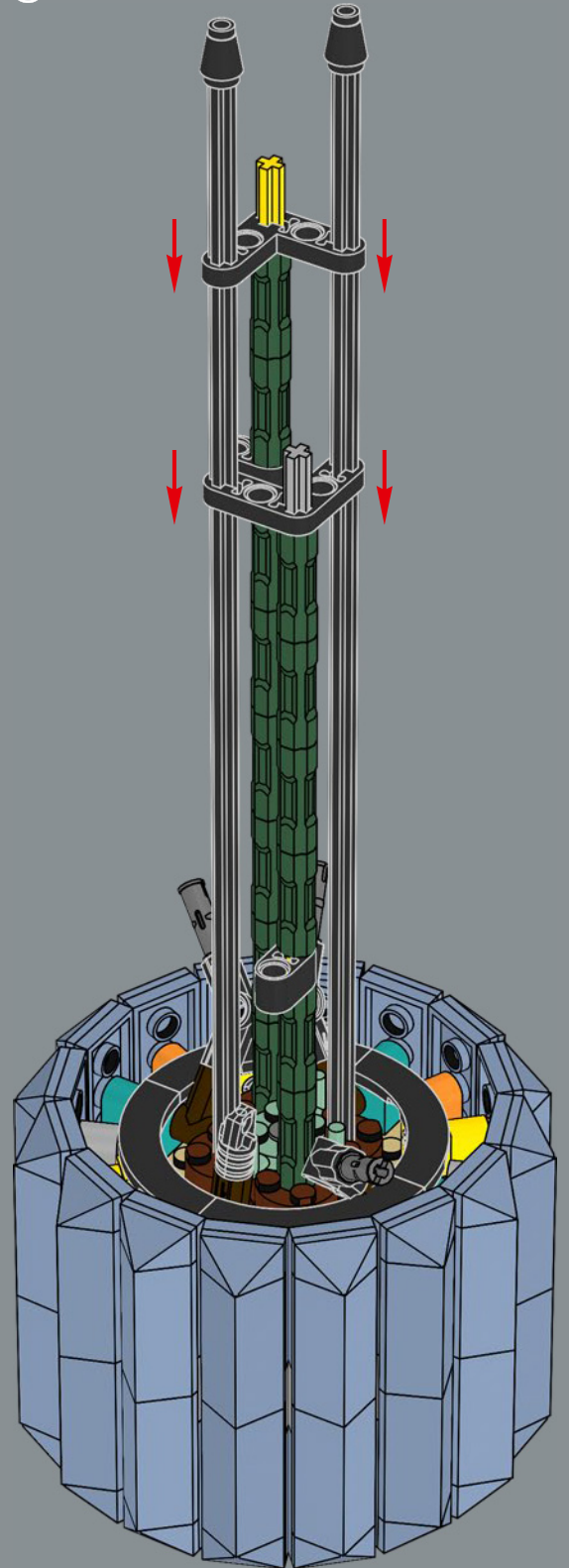
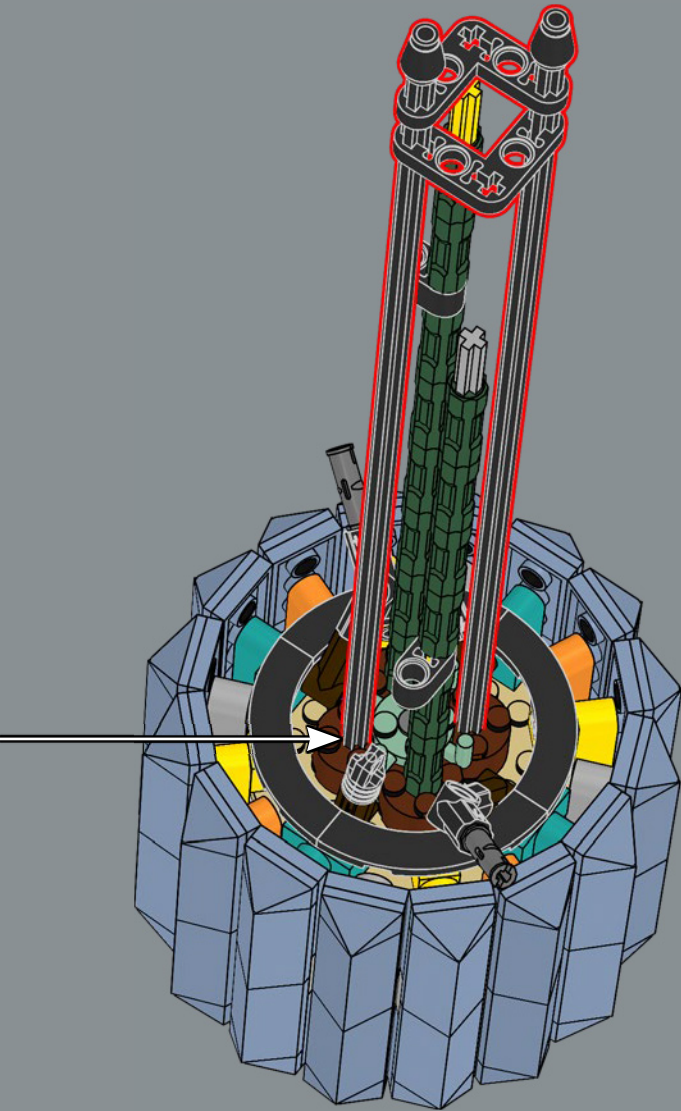



36

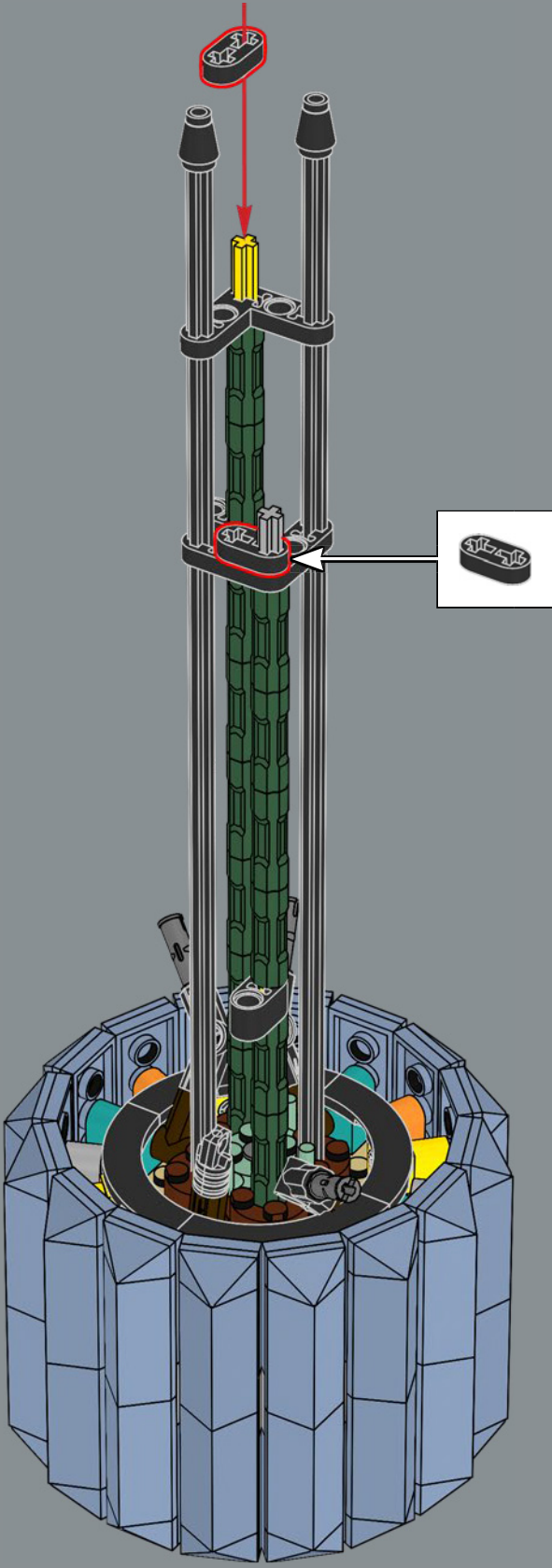

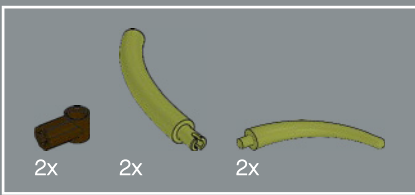

37

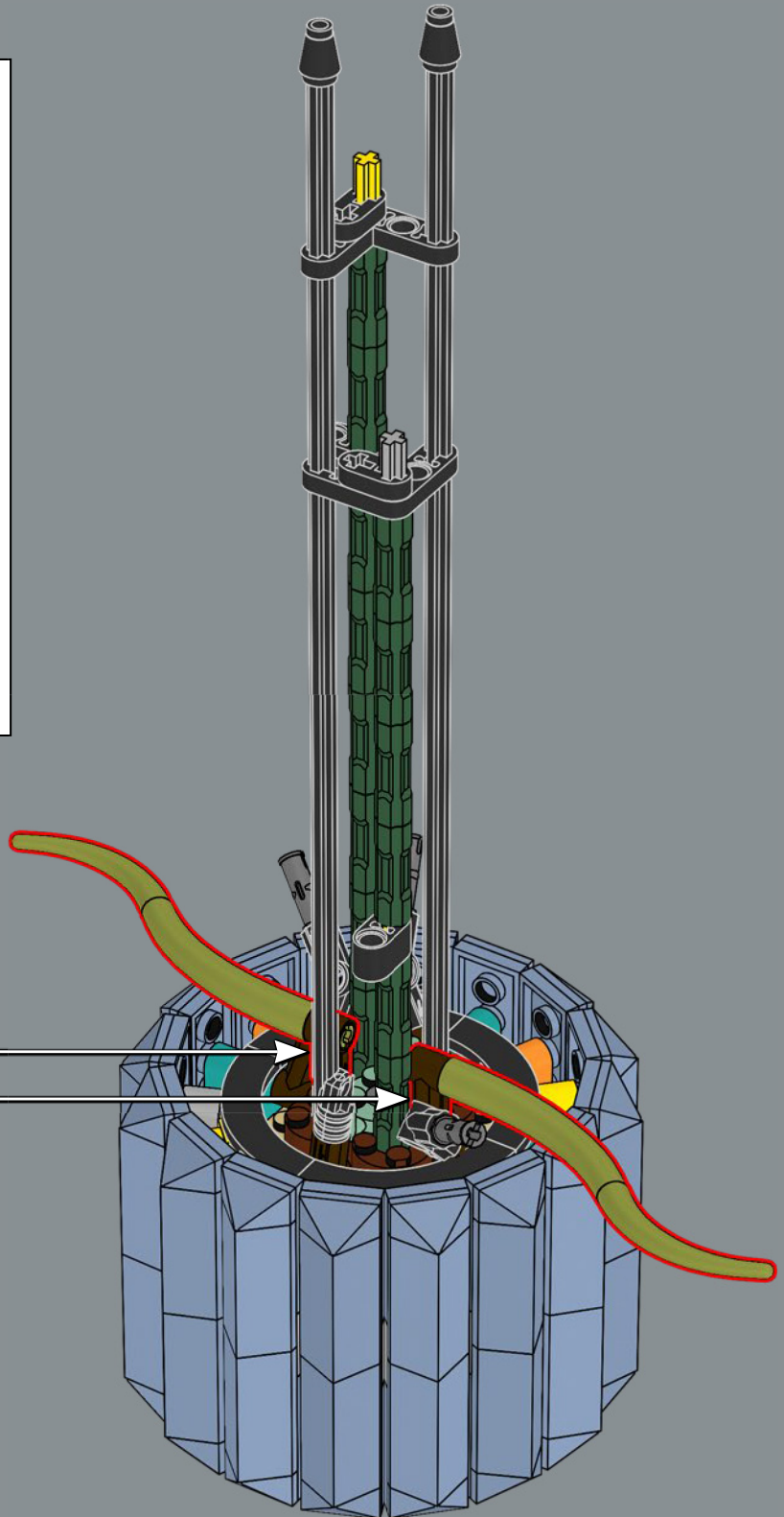
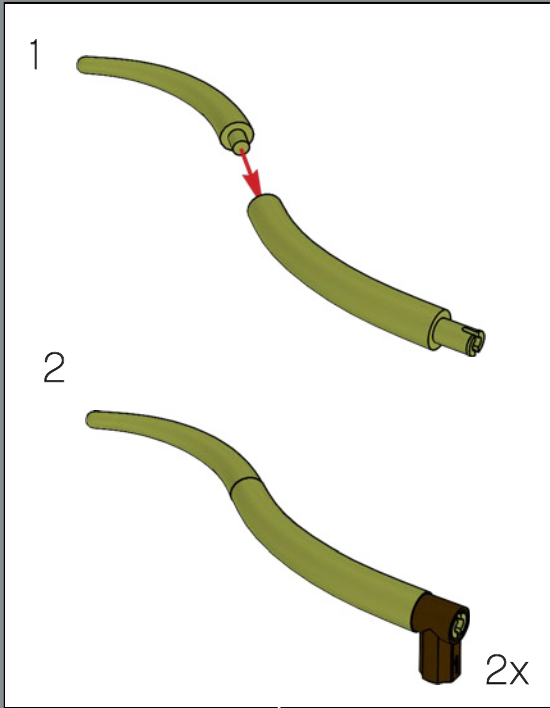

The orchid's air roots are made from dinosaur tail elements - RAWRR!

Les racines aériennes de l'orchidée sont faites à partir d'éléments de queue de dinosaure. RAWRR !

Las raíces aéreas de las Orquídeas están hechas con piezas que representan colas de dinosaurio (iROAAARRR!).

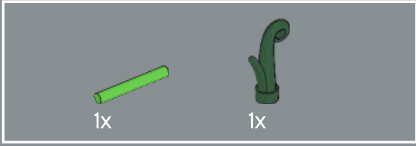
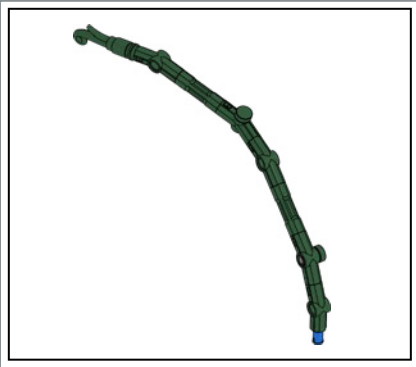

38

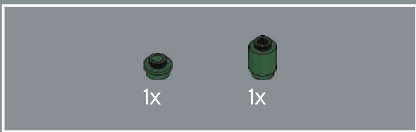
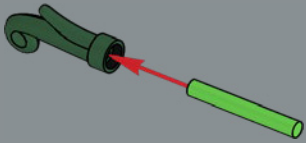

39

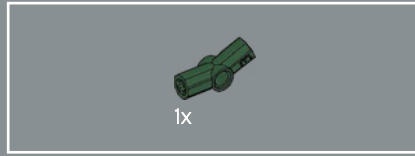
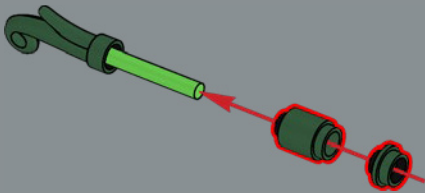

40

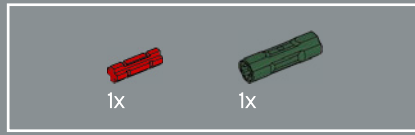
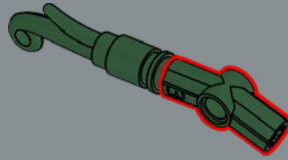

41

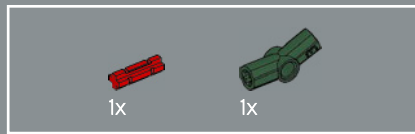
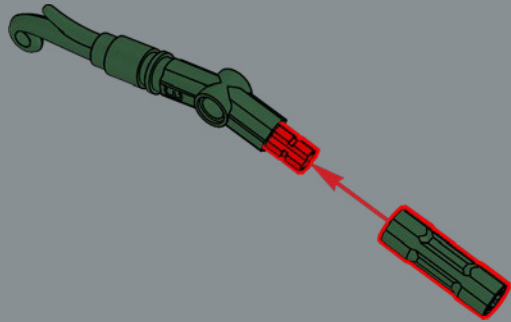

42

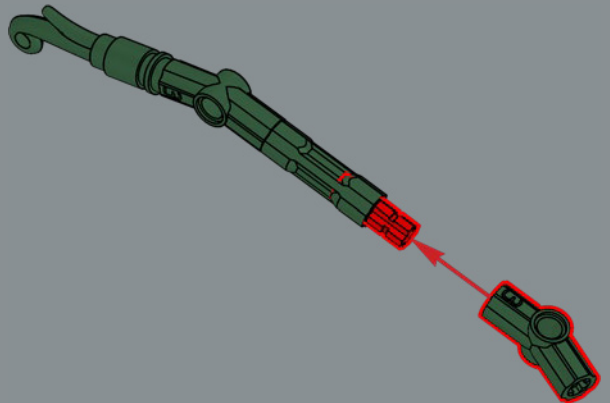

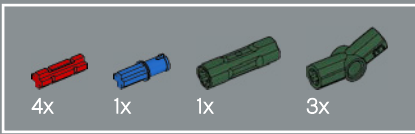

43

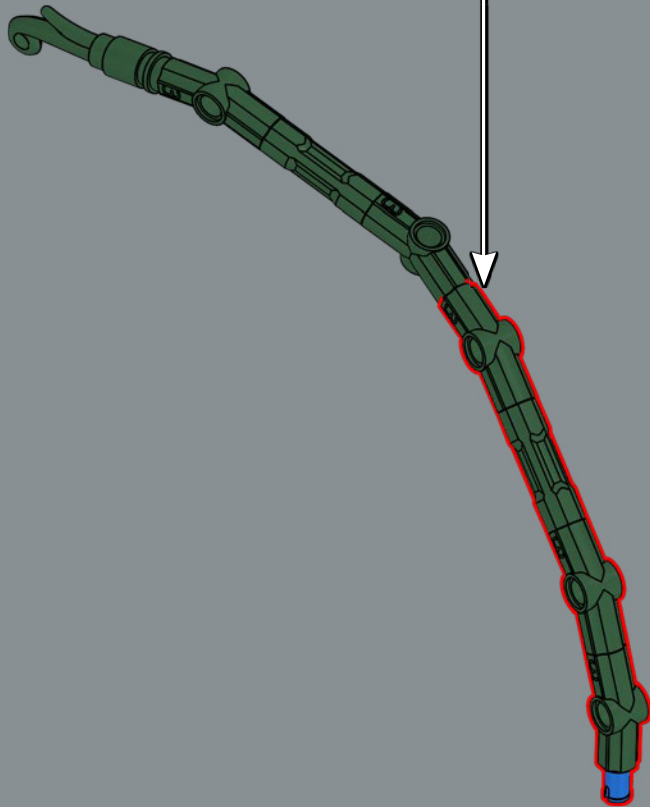
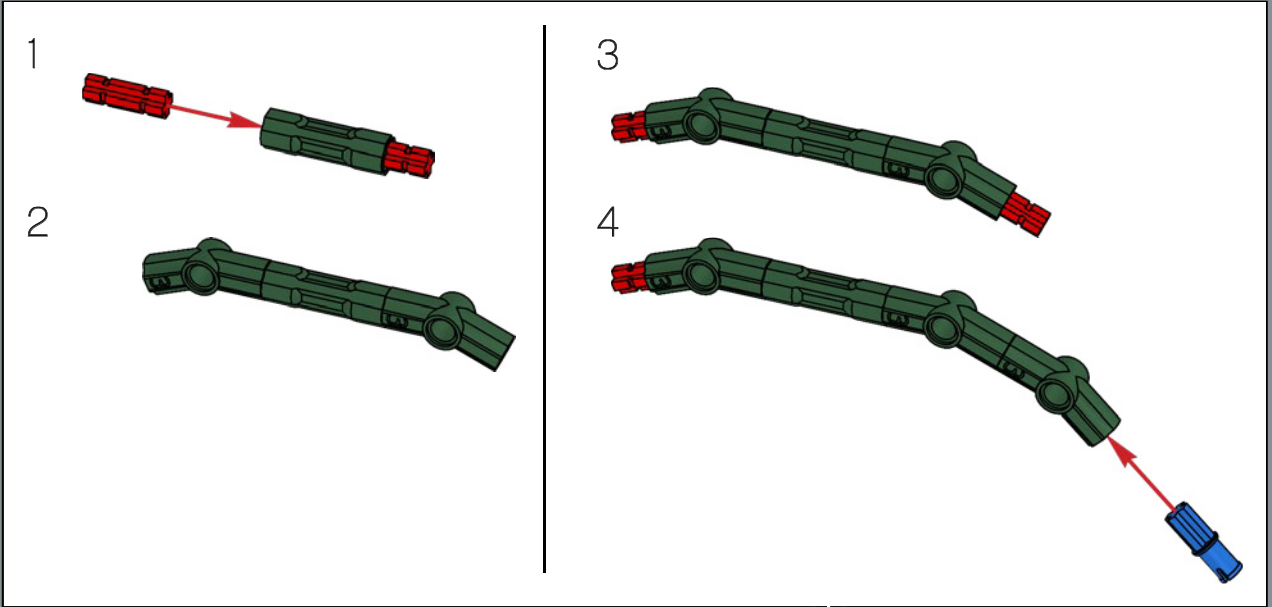



44

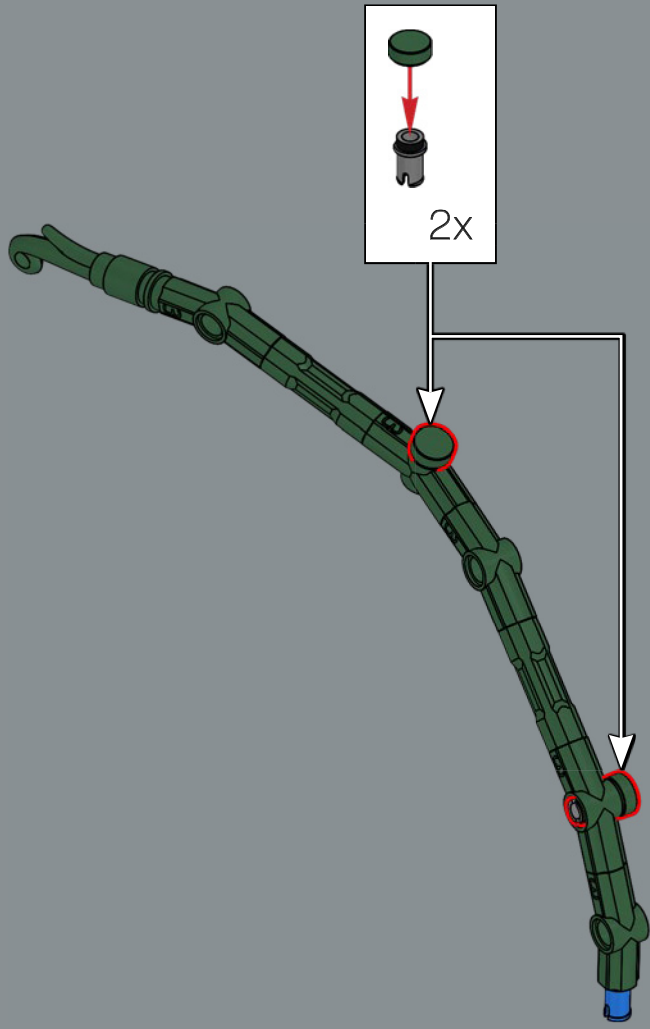

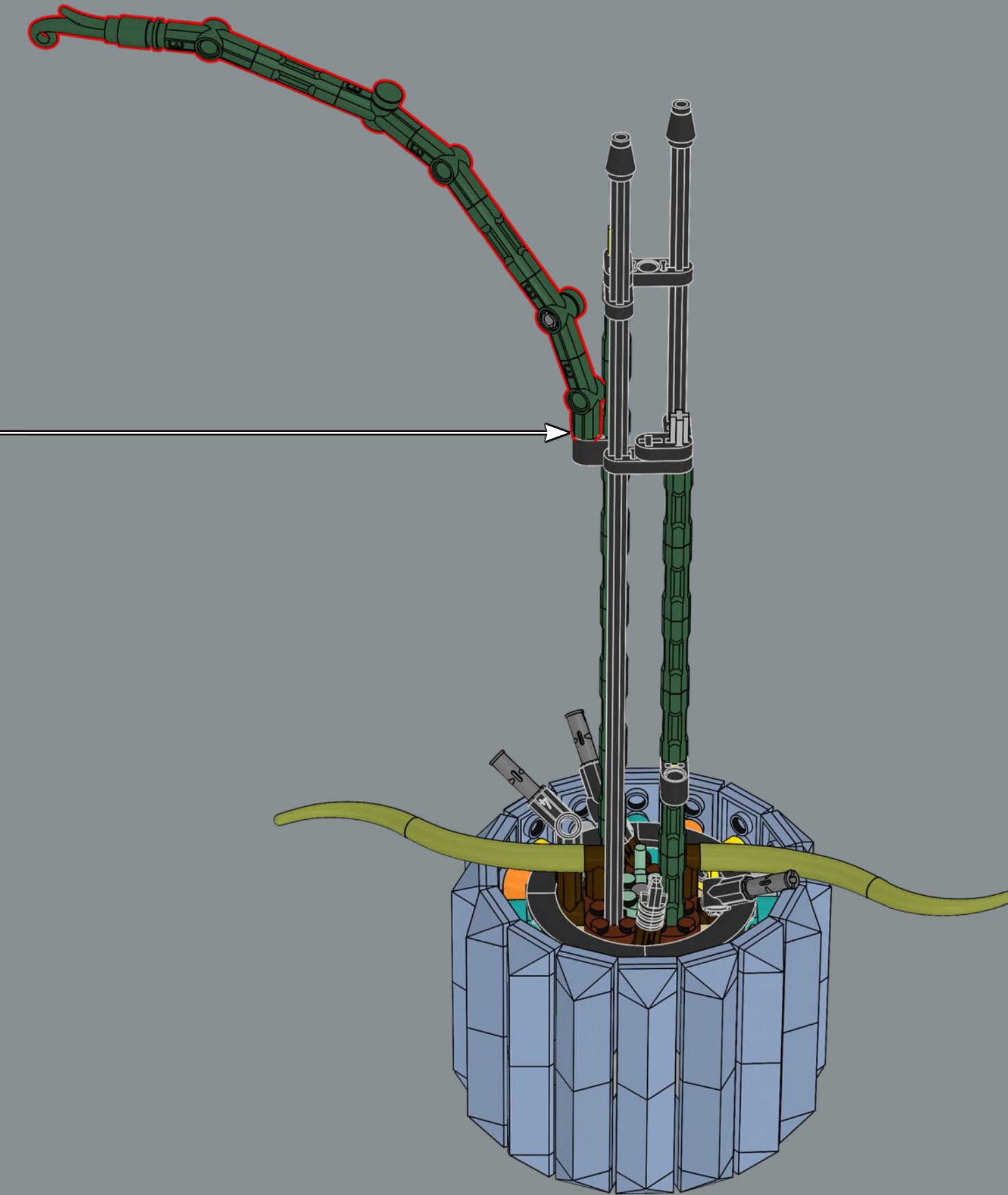

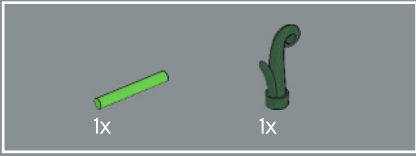
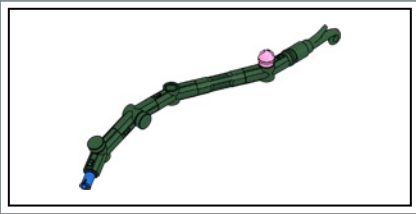

46

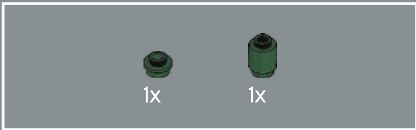
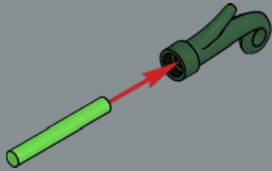

47

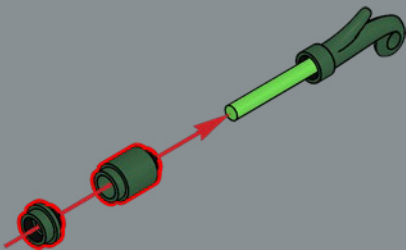

48

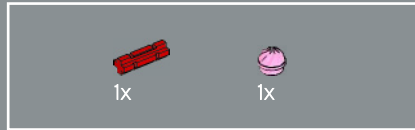
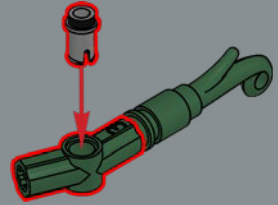

49

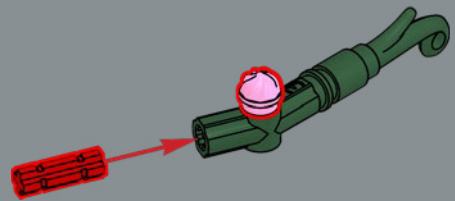

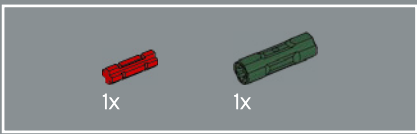

50

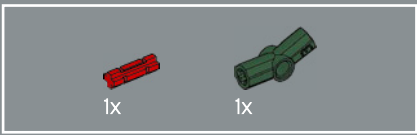
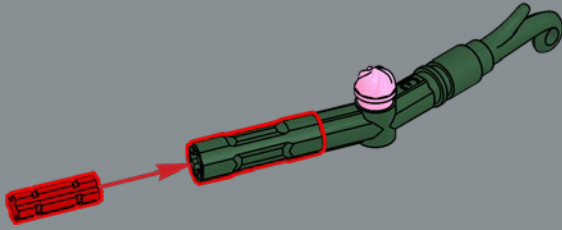

51

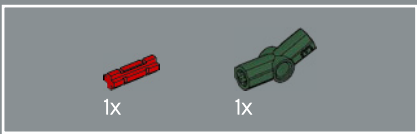
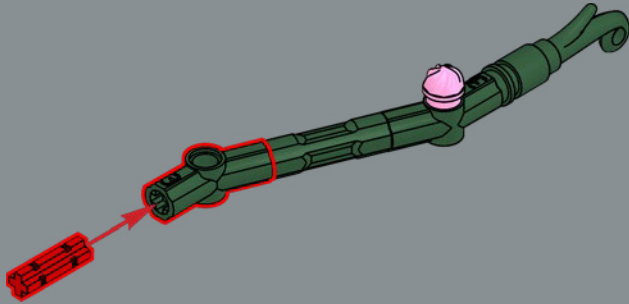

52

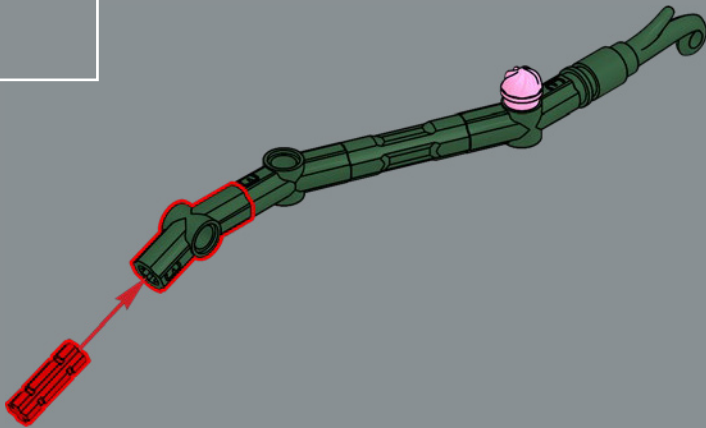

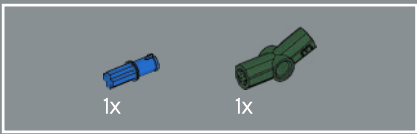

53

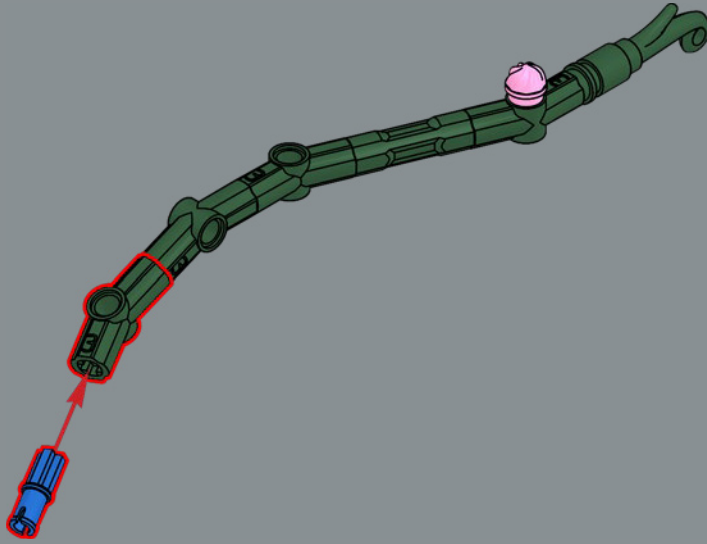

54

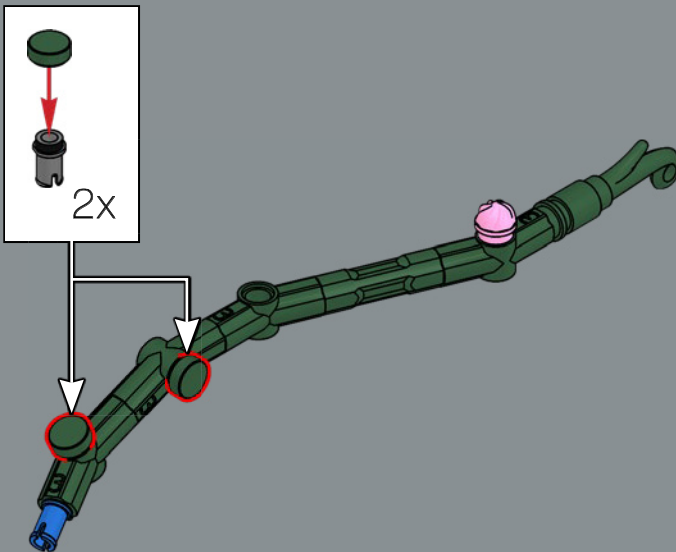



The orchid's stems are built from LEGO® Technic™ elements, making your orchid fully customizable to bloom all year round.

Les tiges des orchidées sont construites à partir d'éléments LEGO® Technic™, ce qui vous permet de personnaliser les orchidées pour qu'elles puissent fleurir toute l'année.

Los tallos de las Orquídeas se construyen a partir de piezas LEGO® Technic™, lo que te da libertad para personalizar la floración de tus ejemplares en cualquier época del año.

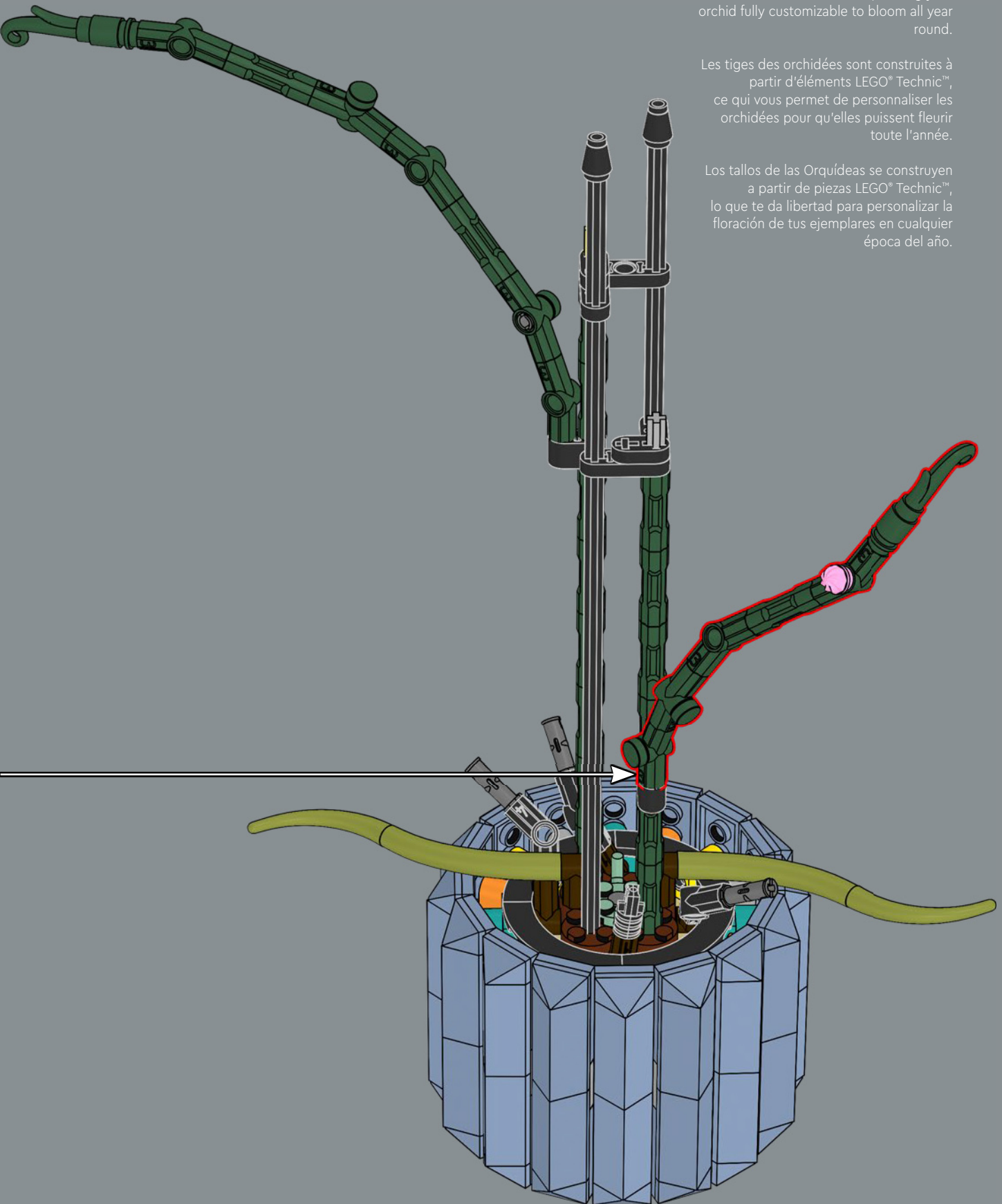

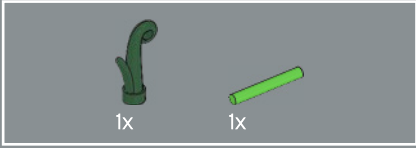
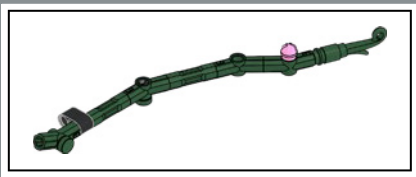

56

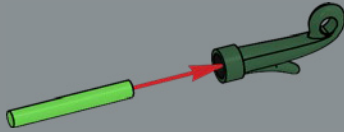

57

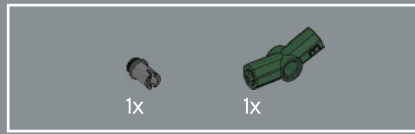
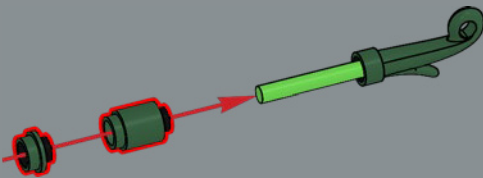

58

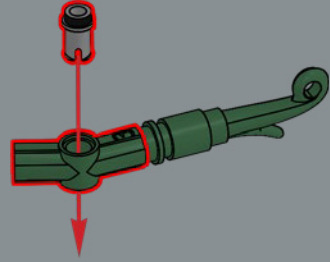

59

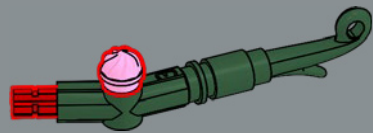

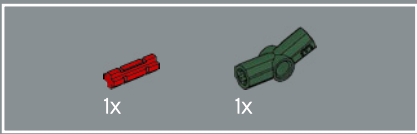

60

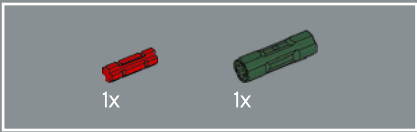
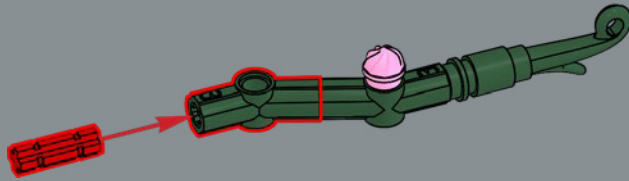

61

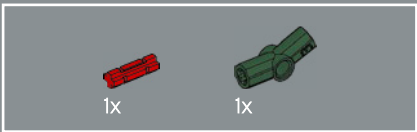
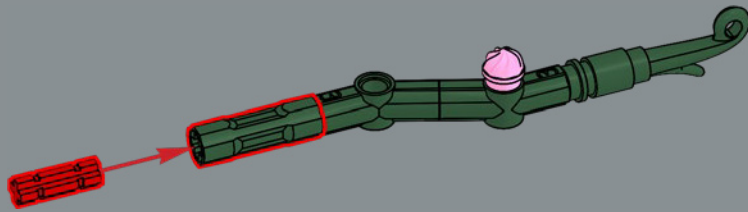

62

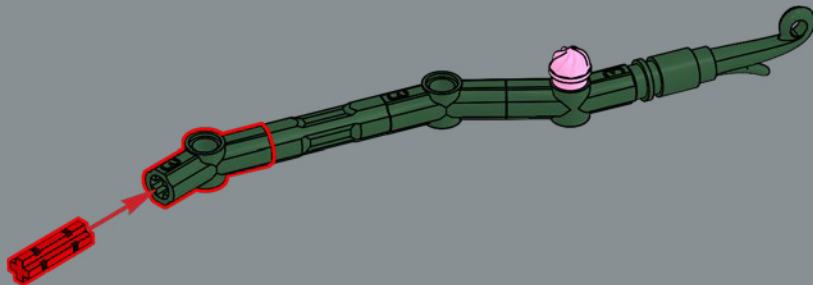

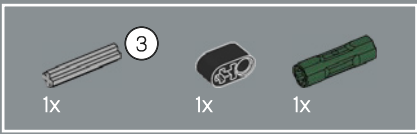

63

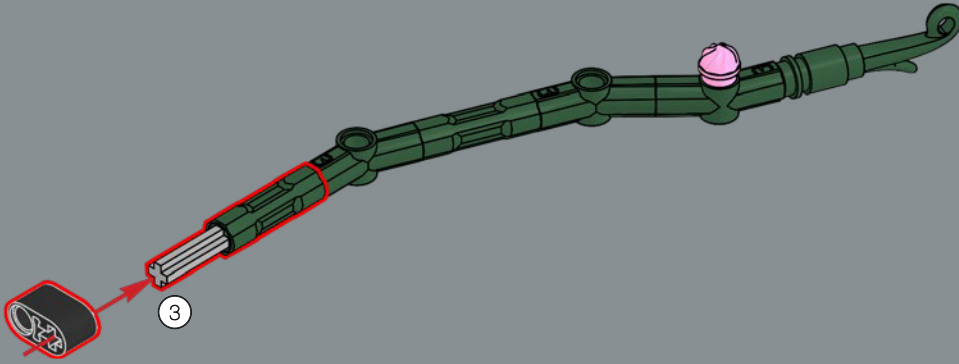

64

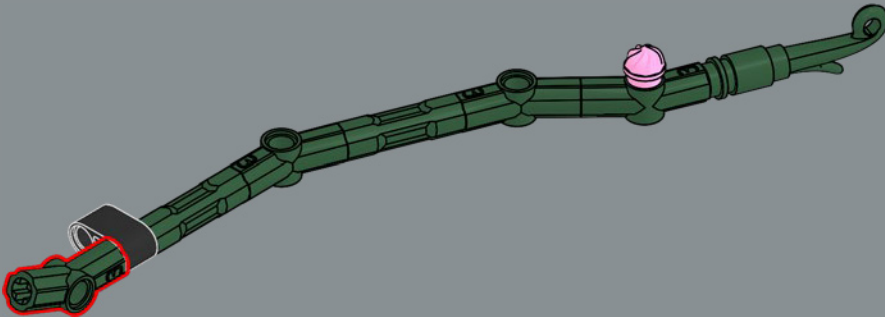

65

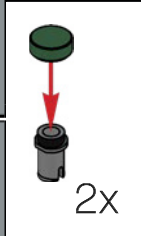
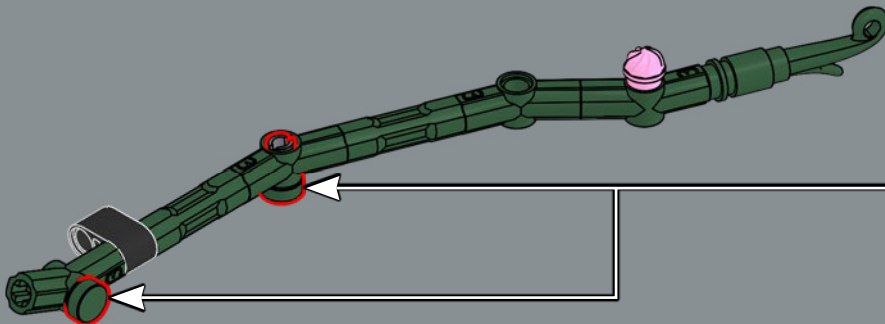

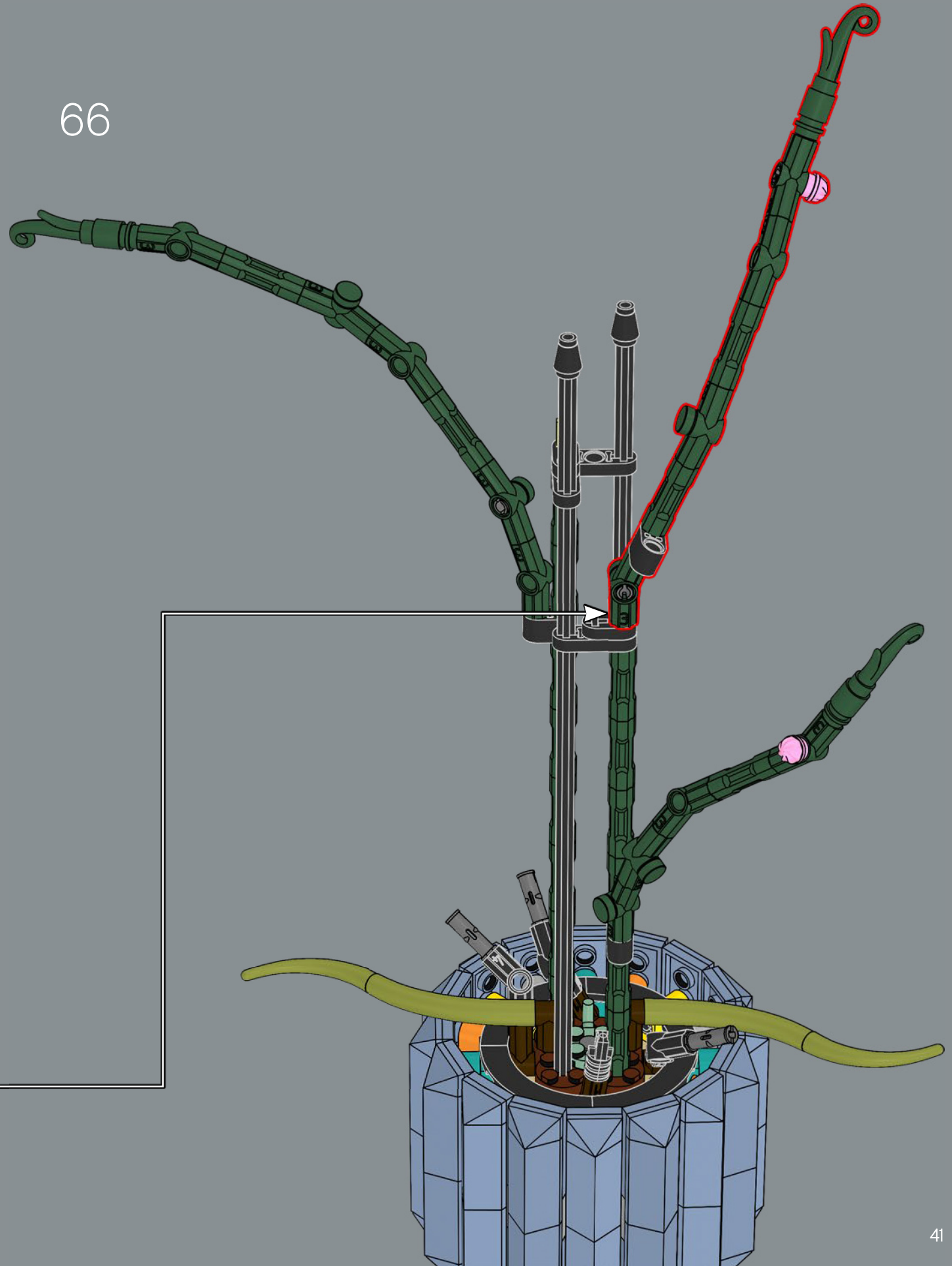

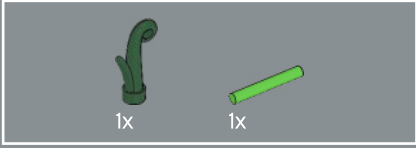
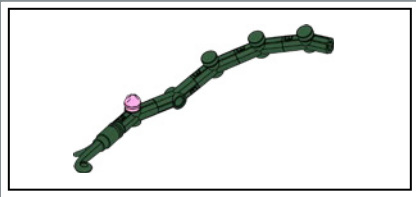

67

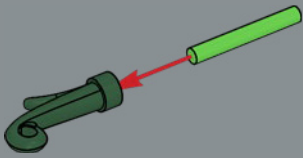

68

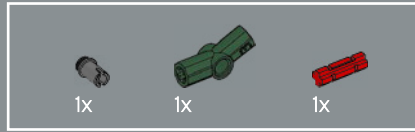
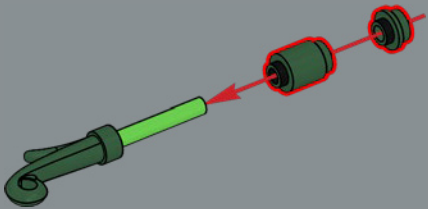

69

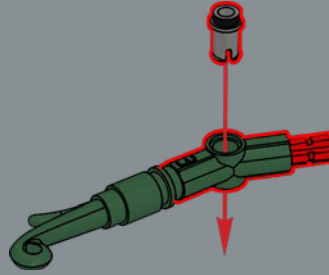

70

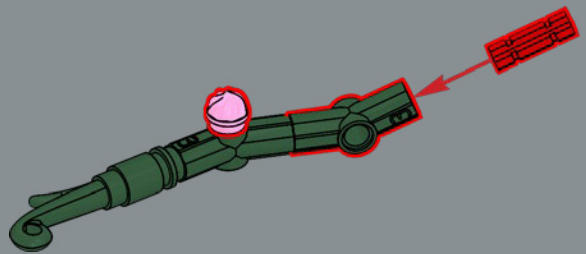

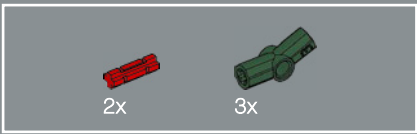

71

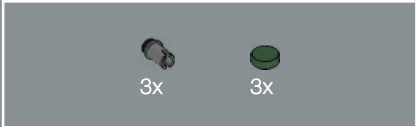
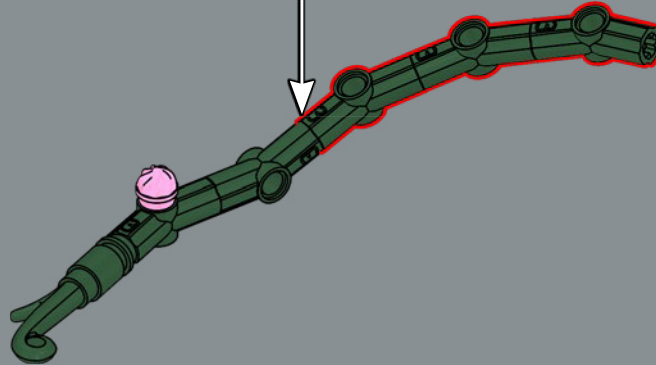
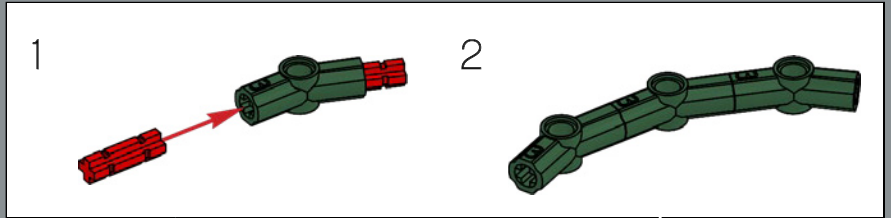

72

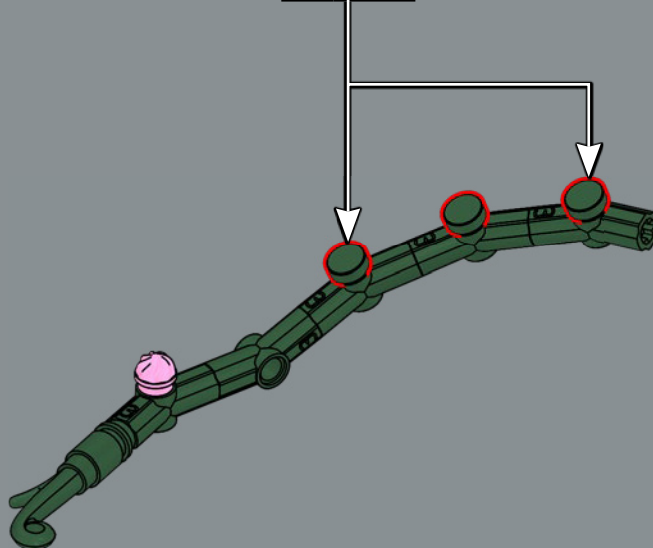
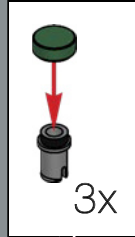

73

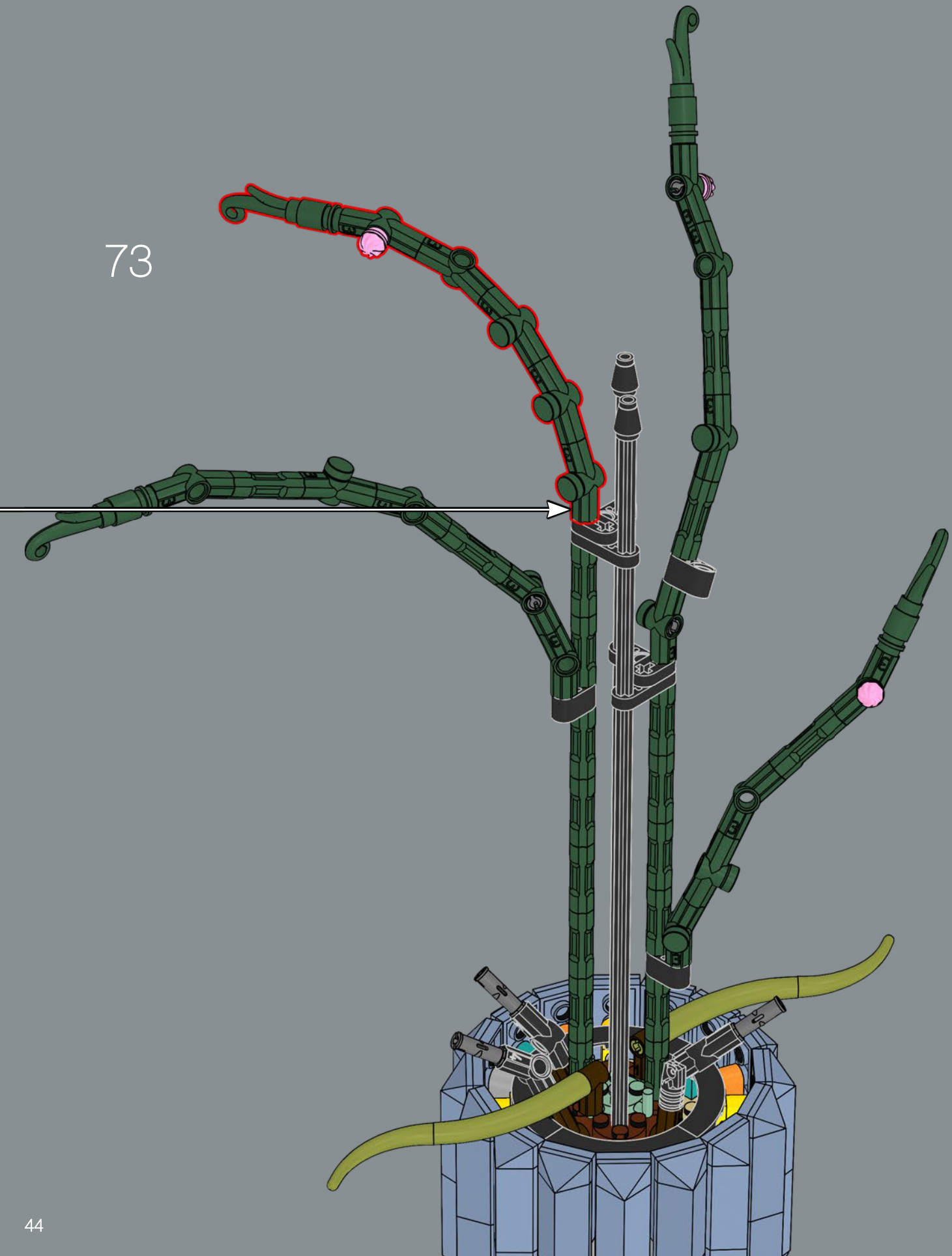

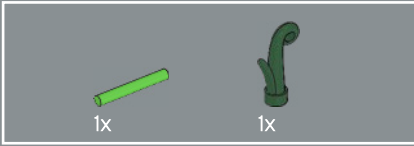
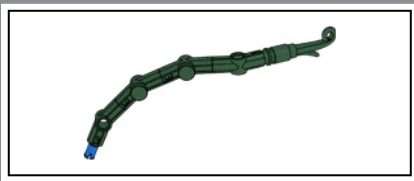

74

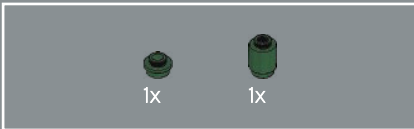
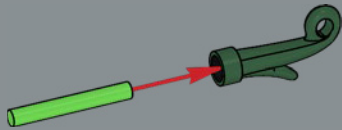

75

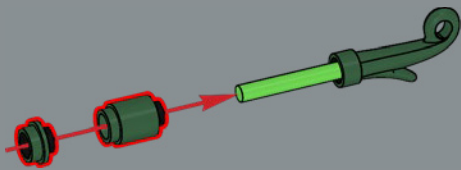

76

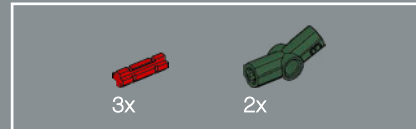
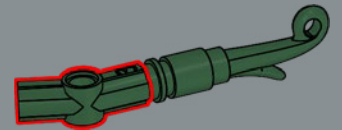

77

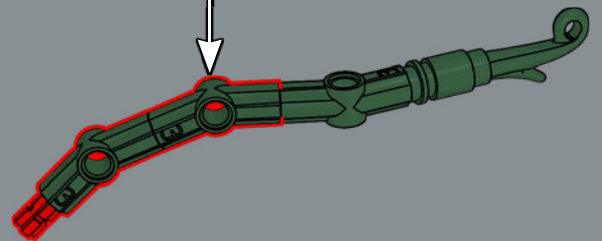
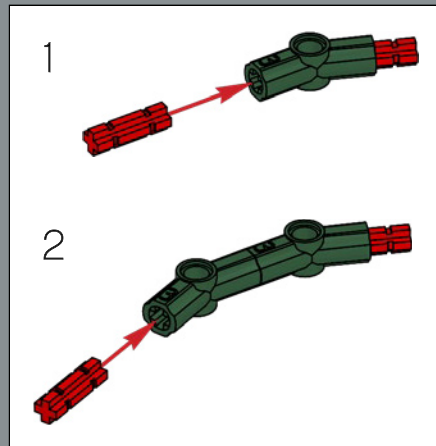

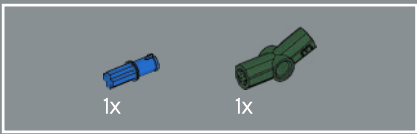

78

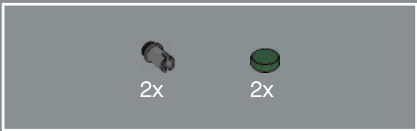
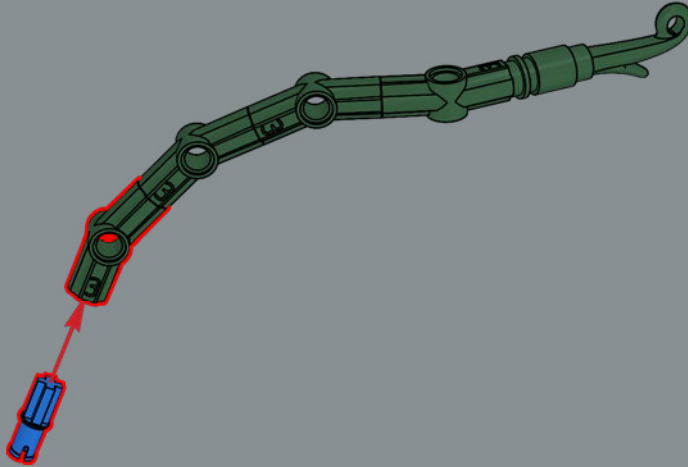

79

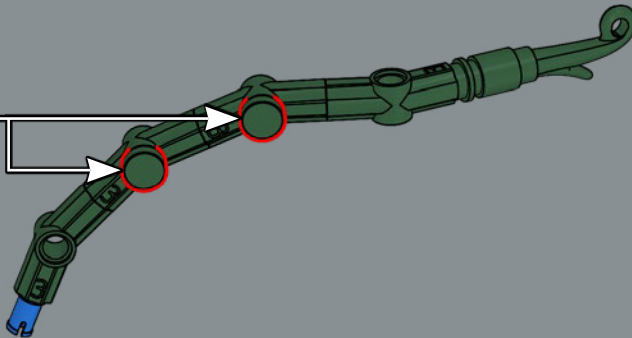
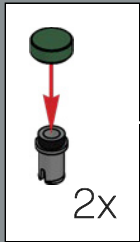

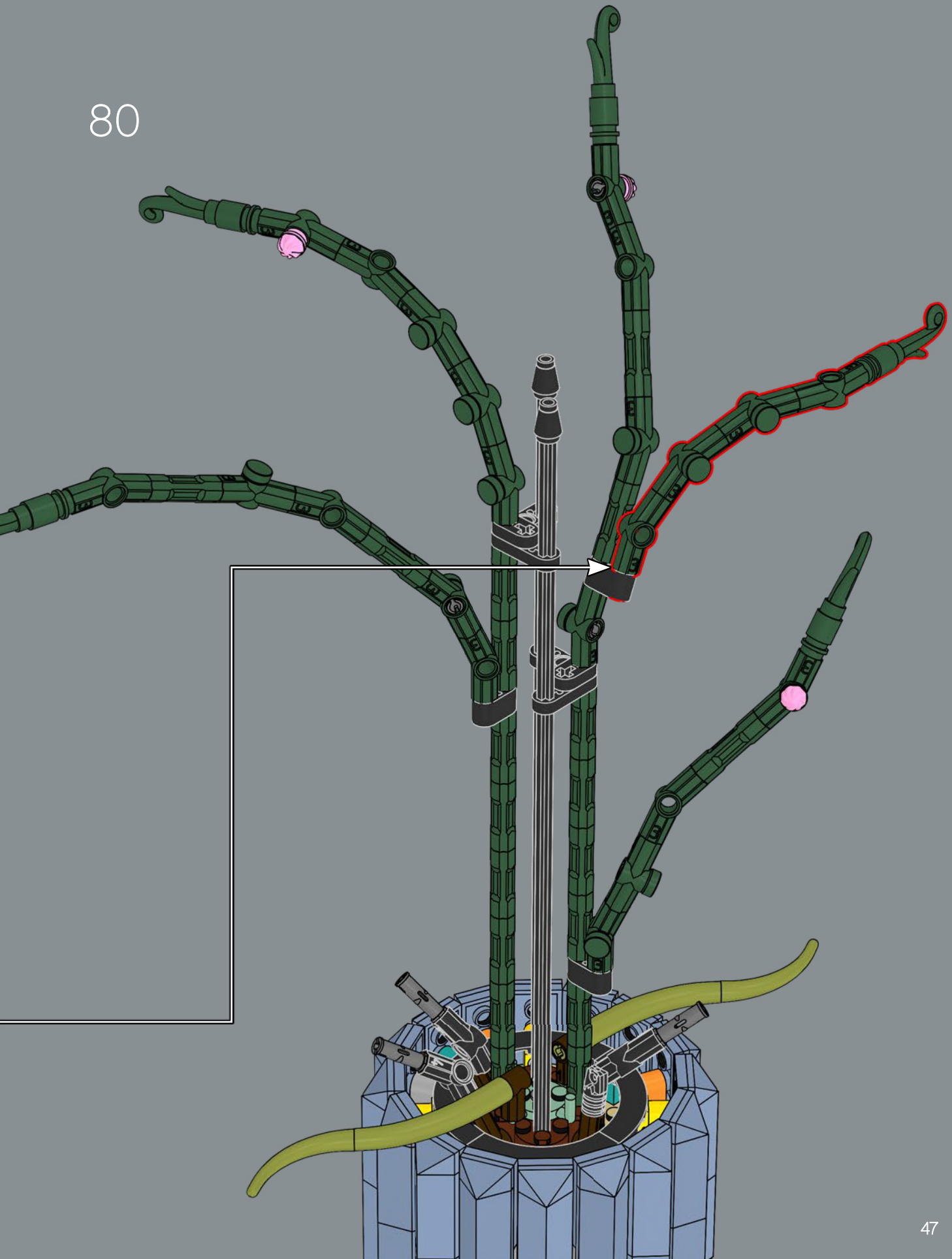



81

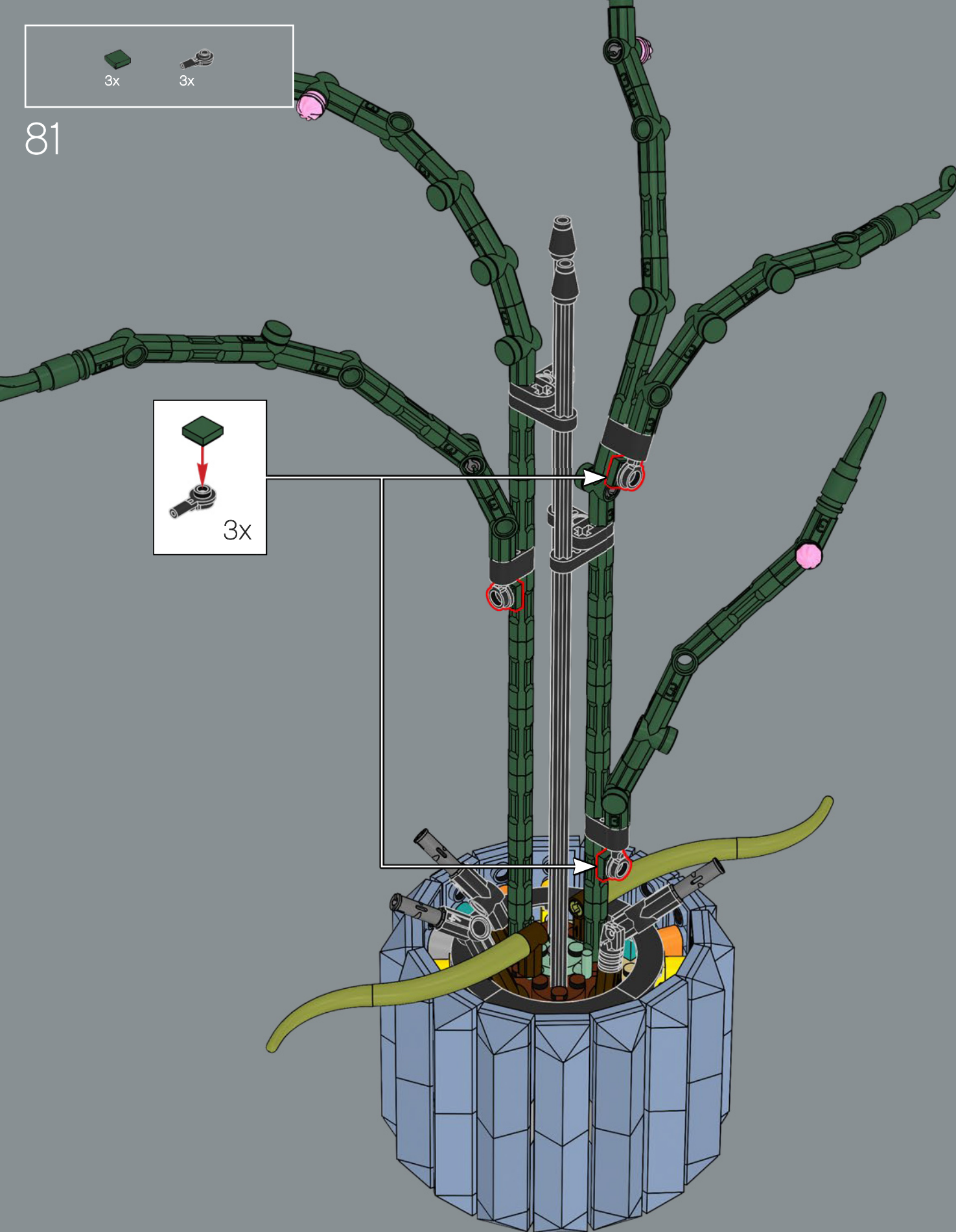
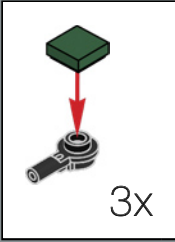

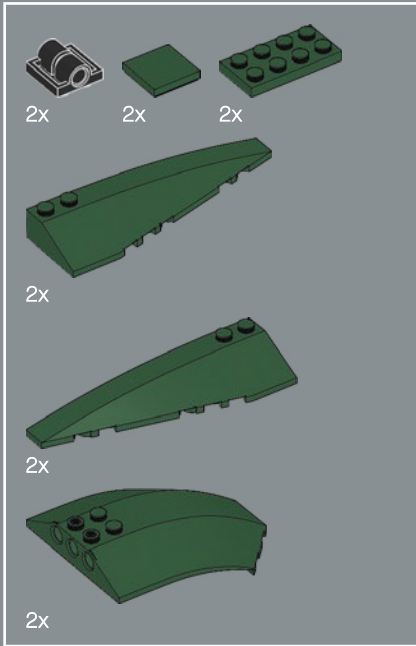
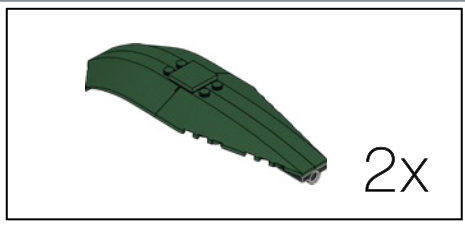

82

1

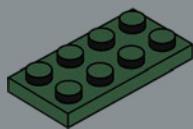

2

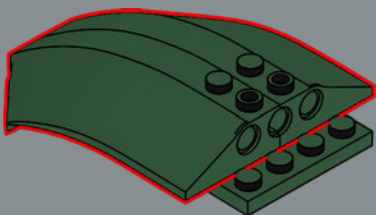

3

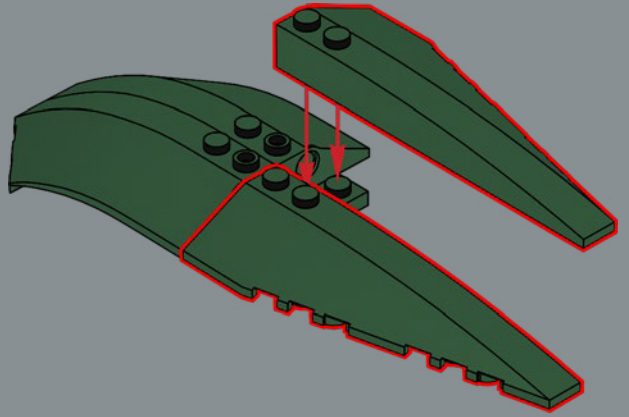

4

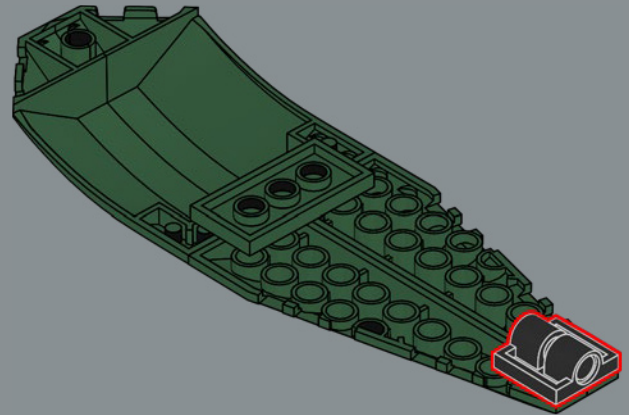

5

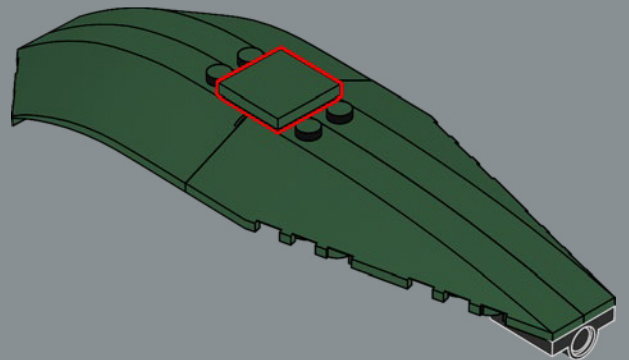

2x

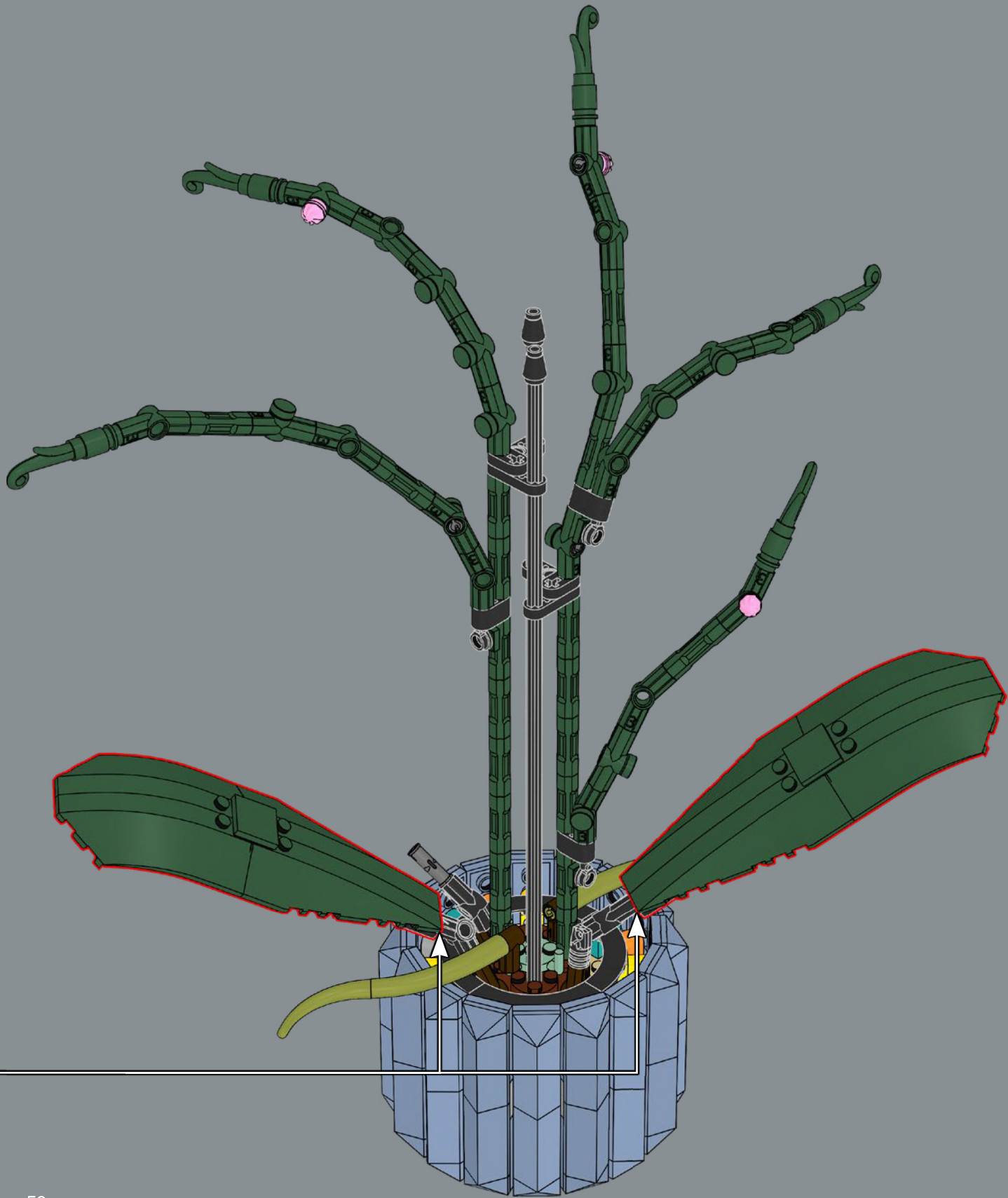

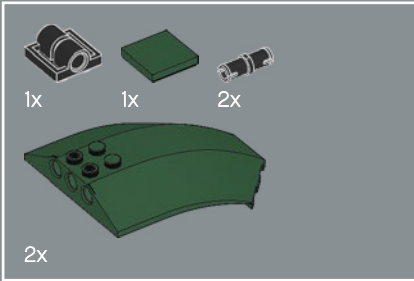
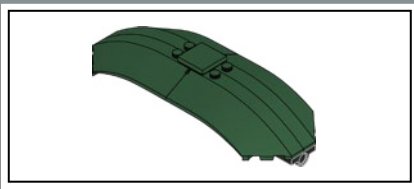

83

1

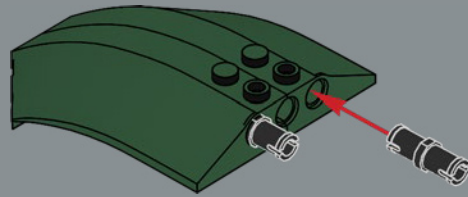

2

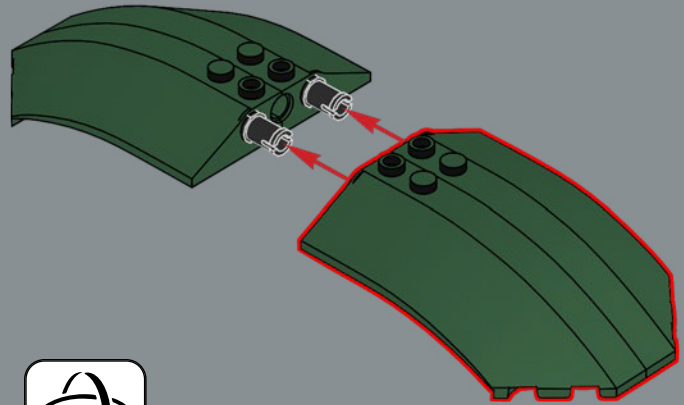

3

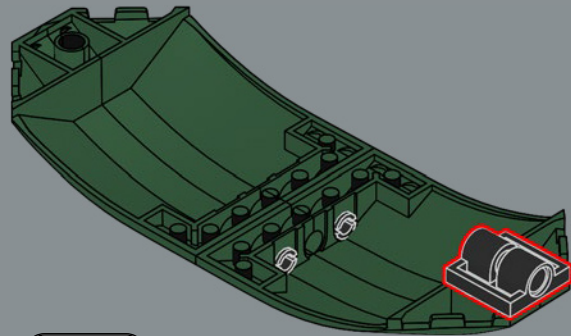

4

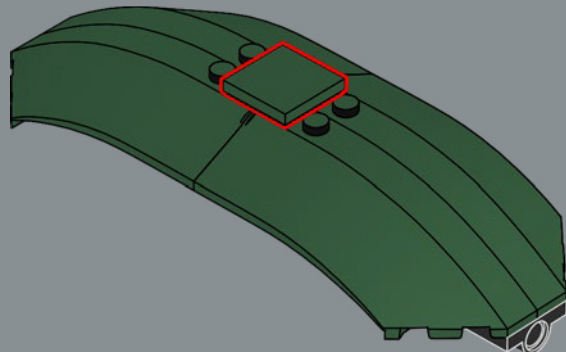

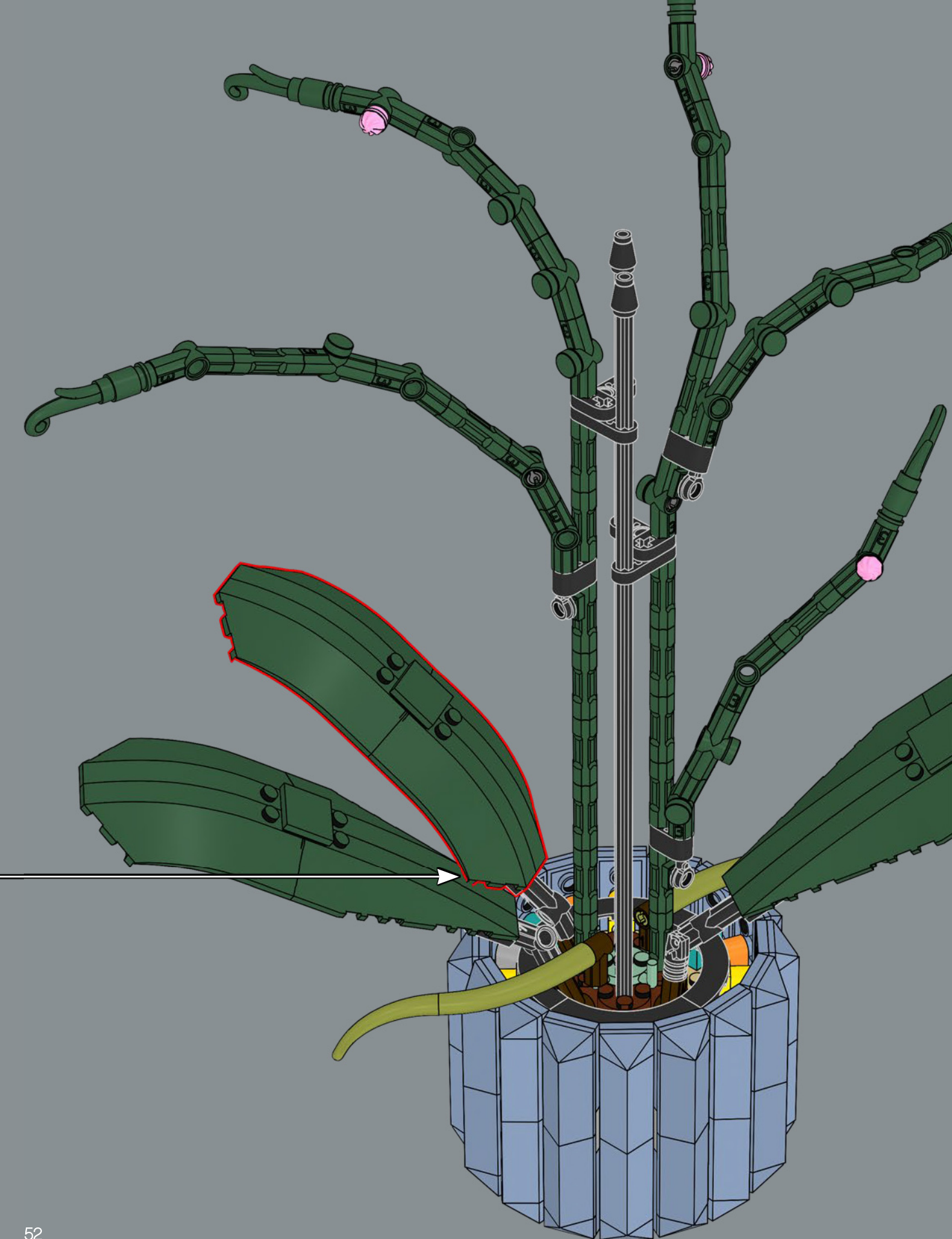

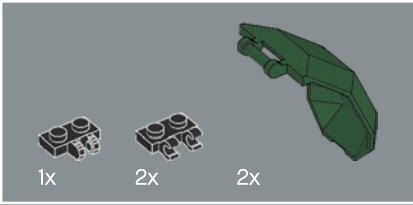

84

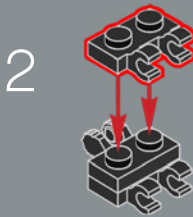
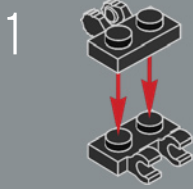

3

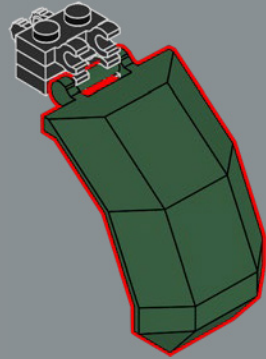

4

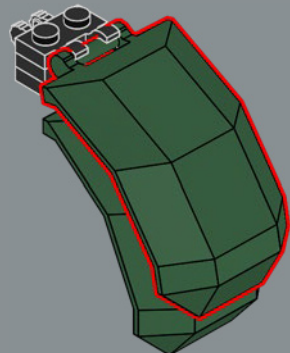

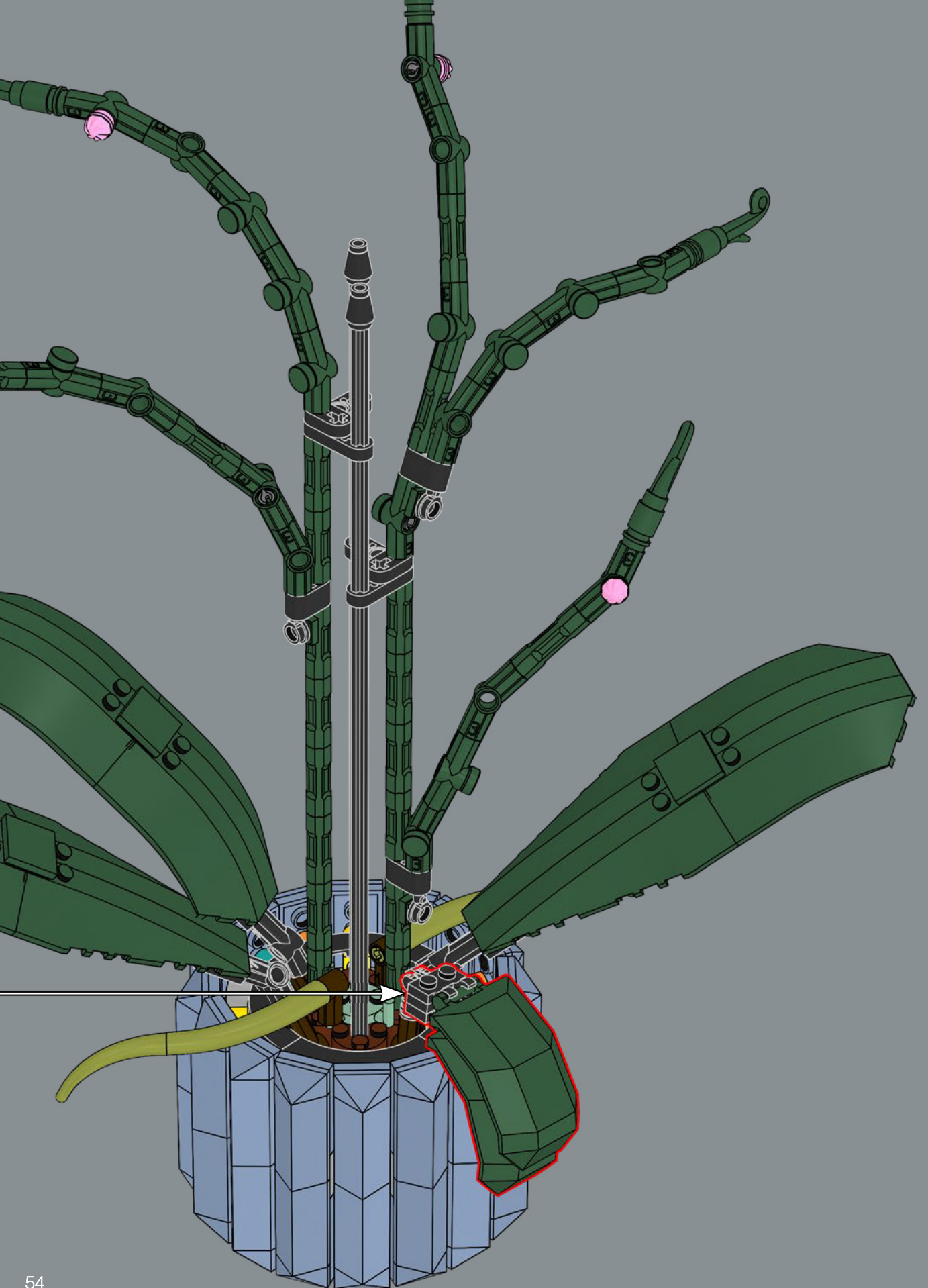



Demogorgon heads from the LEGO® Stranger Things set were used to make the small blossoms in this set.

Les têtes de Démogorgon de l'ensemble LEGO® Stranger Things ont été utilisées pour former les petites fleurs de cet ensemble.

Se utilizaron cabezas de Demogorgon de los sets LEGO® Stranger Things para crear los botones de este set.





85

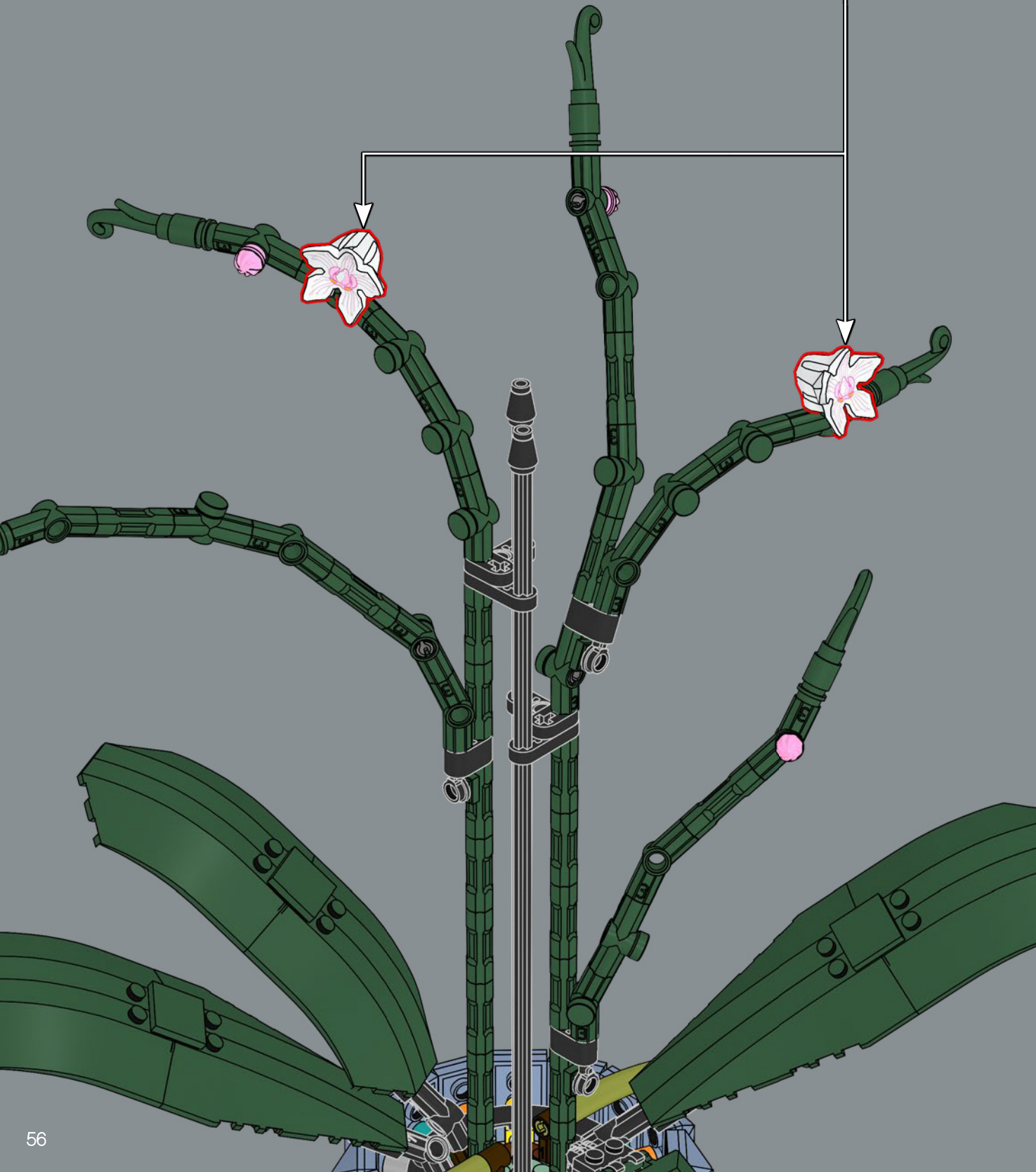
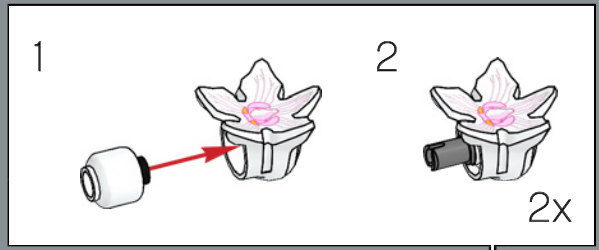

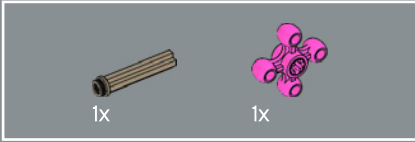

86

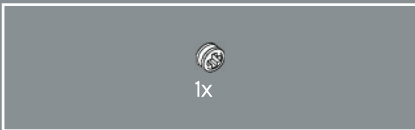
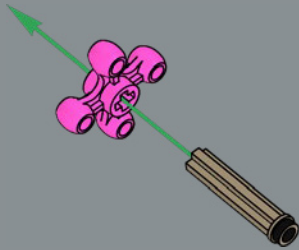

87

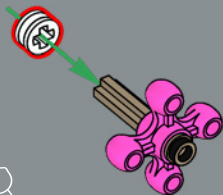

The orchid petals are built with shoulder pad elements from large LEGO® characters.

Les pétales des orchidées sont construits avec des éléments d'épaulettes de grands personnages LEGO®.

Los pétalos de las Orquídeas están hechos con piezas de hombreras de personajes LEGO® de gran tamaño.



88

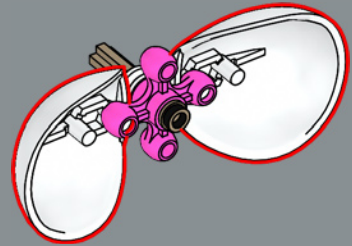

89

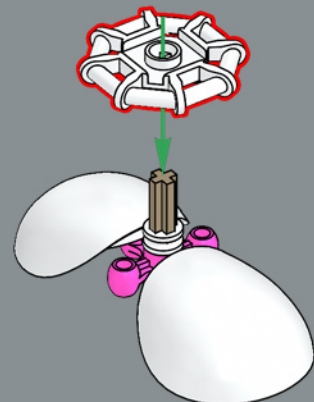

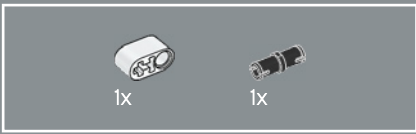

90

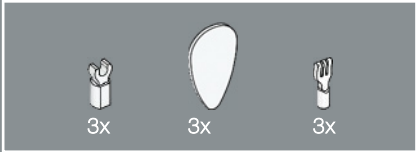
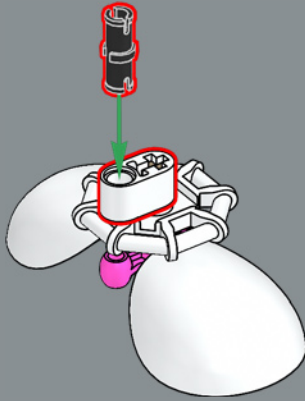

91

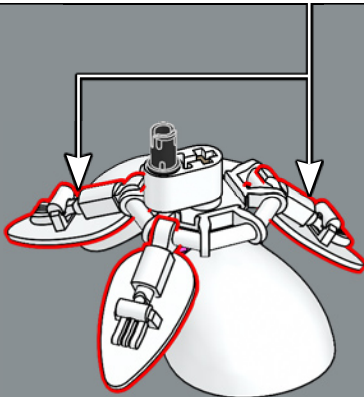
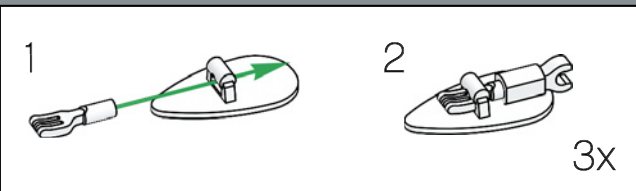

92

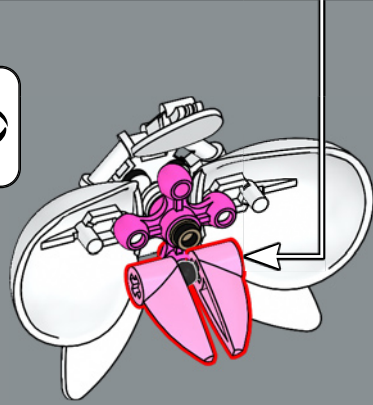
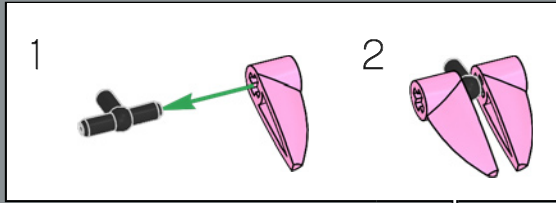

93

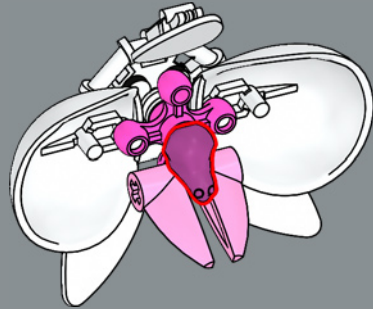

6x



The center of the blossoms feature LEGO® frog elements – an homage to the pink frogs used as blossoms in the LEGO Bonsai Tree set.

Le centre des fleurs présente des éléments de grenouille LEGO®, un hommage aux grenouilles roses utilisées comme fleurs dans l'ensemble Le bonsaï LEGO.

En el centro de las flores hay ranas LEGO® como un homenaje al uso de ranas de color rosa a modo de flores en el set LEGO Bonsaí.

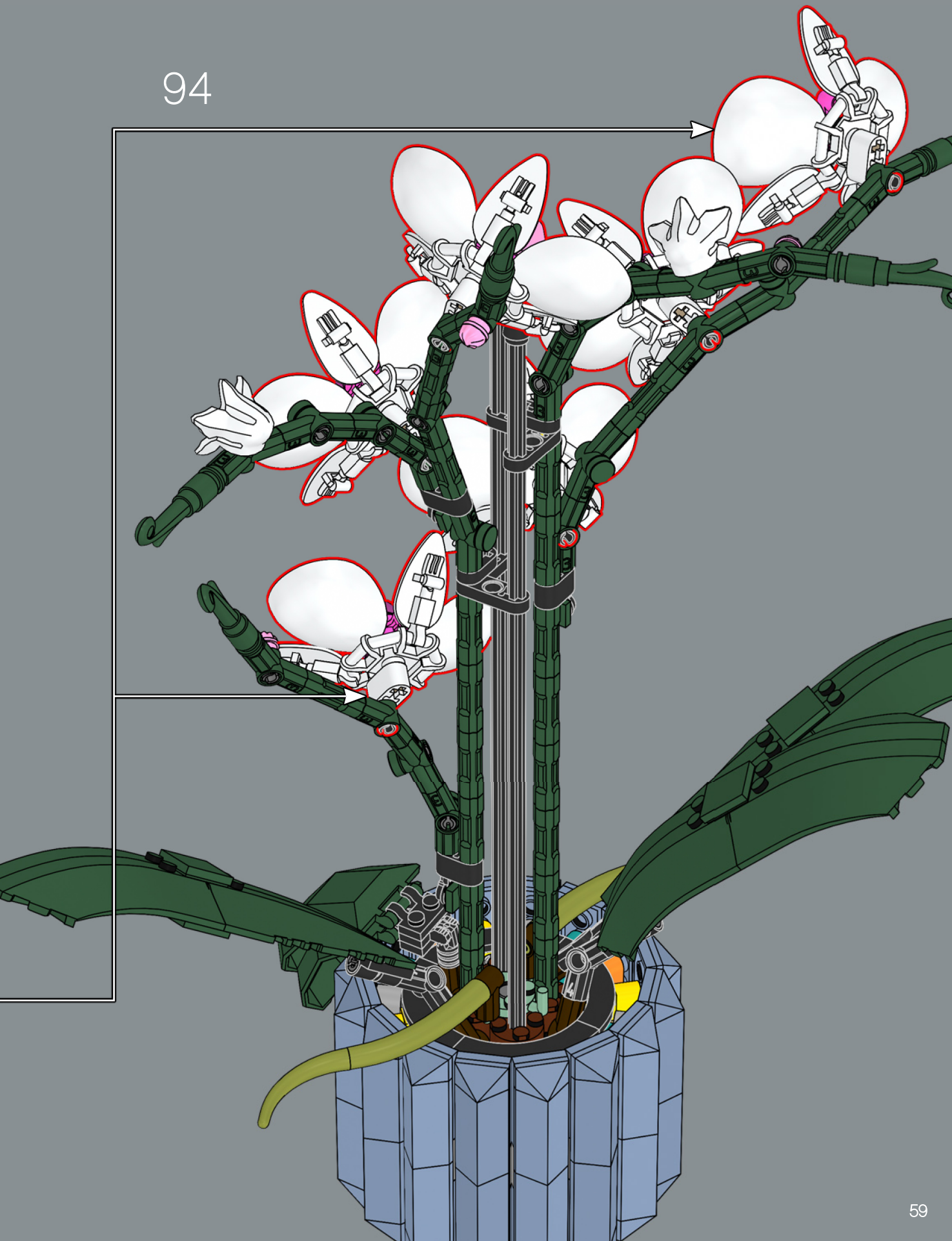

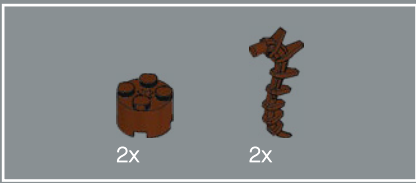

2x

2x

95



Minifigure shields originally developed for the 1995 LEGO® Castle Line make up the sepals of the orchid.

Les boucliers de figurines développés à l'origine pour la série LEGO® Castle de 1995 forment les sépales de l'orchidée.

Los sépalos de la orquídea están conformados por escudos de minifiguras originalmente desarrollados para la serie LEGO® Castle de 1995.

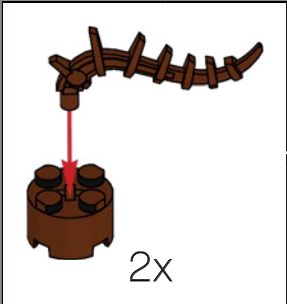
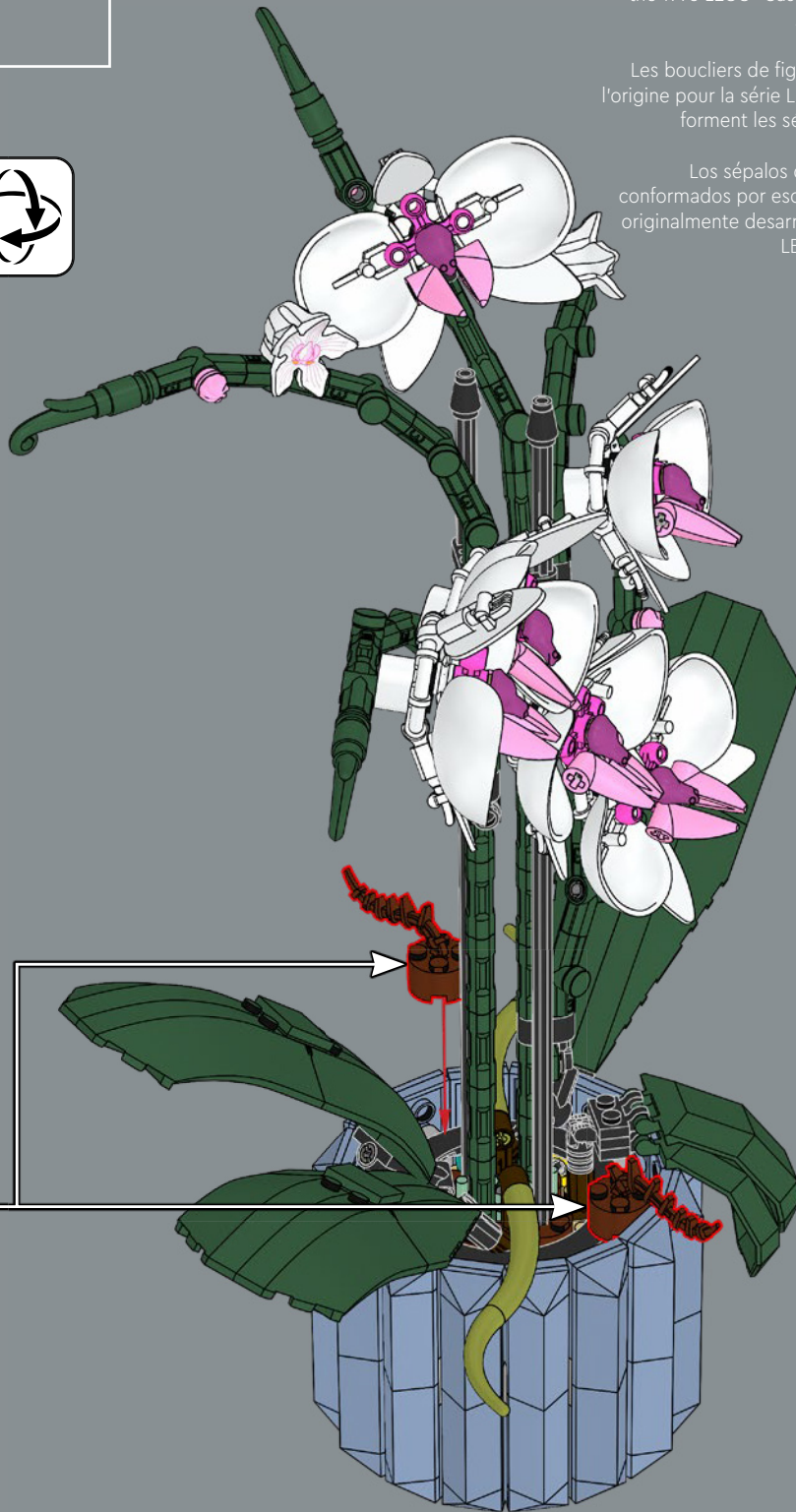

2x



96



Orchids are often potted with mulch to allow air flow and drainage for healthy roots. Here, the mulch is built from claw elements from LEGO® NEXO KNIGHTS sets.

Les orchidées sont souvent mises en pot avec du paillis pour permettre la circulation de l'air et le drainage pour des racines saines. Ici, le paillis est fait à partir d'éléments de griffes des ensembles LEGO® NEXO KNIGHTS.

A veces se coloca un lecho orgánico en las macetas antes de plantar las orquídeas con el fin de que exista una buena circulación de aire y un drenaje adecuado que mantengan sanas las raíces. Aquí, se usaron piezas de los sets LEGO® NEXO KNIGHTS que representan garras para recrear el lecho orgánico.





1x
4558956



6x
6265135



6x
6009016



8x
6195358



2x
362601



2x
6302214



18x
6395857



18x
6395620



12x
6390377



18x
6341465



6x
6360263

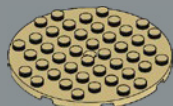

4x
6378358



3x
4206482



8x
6299413



8x
654124

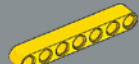

4x
4495934



3x
6130007



2x
4529236



3x
6265091



3x
6196548



1x
6266207



2x
6310268



3x
281726



8x
6171264



2x
6338428



2x
6271810



1x
6265699



24x
6279875



3x
6262897

7

3

7

7



6x
6104209



2x
403228



5x
6161772



8x
6136553



4x
6339024



2x
6030521

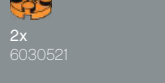

1x
6240515



8x
6345402



4x
6323477

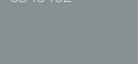

8x
6325515



32x
6392959



32x
6395798



32x
6248957

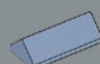

32x
6248957



32x
6248957

3.2

6x
6031821



5x
6253282



4x
6392976

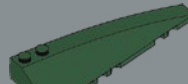

2x
6392970



2x
6392971



3x
6055171



3x
4528778



2x
4586057



11x
6397157



5x
6230571



5x
6396754



2x
6392972



22x
6344177



19x
6330196



1x
6329274



8x
4211535



4x
4495930



16x
6276848



2x
4211815



3x
6045718



16x
6395635



3x
6015356



1x
4499858



6x
6380668



3x
6060795



12x
6395623



2x
6313597



32x
6378120



37x
4142865



6x
6395622

7

3

8



6x
4211166



6x
6075213



2x
6270052



7x
6251403



7x
6353396



6x
6332586



2x
6351430



2x
6351434



2x
6351434



2x
6351434

2x
6351434

2x
6351434

2x
6351434

2x
6351434

2x
6351434

2x
6351434

2x
6351434

2x
6351434

2x
6351434

2x
6351434

2x
6351434

2x
6351434

2x
6351434

2x
6351434

2x
6351434

2x
6351434

2x
6351434

2x
6351434

2x
6351434

2x
6351434



Customer Service

Kundenservice

Service Consommateurs

Servicio Al Consumidor

LEGO.com/service or dial



00800 5346 5555 :



1-800-422-5346 :



2x
6210821

32



FEEDBACK AND WIN

FEEDBACK AND WIN

Your feedback will help shape the future development of this product series.

Please visit:

FEEDBACK UND GEWINNEN

Dein Feedback trägt zur Weiterentwicklung dieser Produktreihe bei.

Geh auf:

COMMENTEZ ET GAGNEZ

Vos commentaires nous aideront à concevoir les futurs produits de cette gamme.

Rendez-vous sur :

COMENTA Y GANA

Tu opinión nos ayudará a dar forma al desarrollo de esta serie de productos en el futuro.

Visita:

反馈有奖

您的反馈将有助于我们在今后改进本系列产品。

请访问：

[LEGO.com/productfeedback](https://www.lego.com/productfeedback)

By completing, you will automatically enter a drawing to win a LEGO® set.

Terms & Conditions apply.

Durch Ausfüllen nimmst du automatisch an der Verlosung eines LEGO® Preises teil.

Es gelten die Teilnahmebedingungen.

En envoyant vos commentaires, vous serez automatiquement inscrit(e) à un tirage au sort qui vous permettra de remporter un prix LEGO®.

Offre soumise à conditions.

Al contestar, participarás automáticamente en el sorteo y podrás ganar un set LEGO®.

Sujeto a Términos y Condiciones.

完成我们的反馈调查，即可自动进入抽奖环节，赢取乐高®套装。

适用《条款和条件》。

