

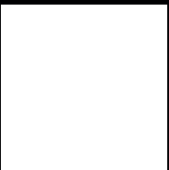

# Camaro Z/28 1969



Booklet available in English on  
Livret disponible en français sur  
Folleto disponible en español en



**We've got a mean streak.**

**Z/28 Camaro.**

The '69 Z/28: So ominous it goes by its code name. Cubic inches: 302. Standard equipment: mechanical lifters, high-performance cam strings and heavy-duty shocks. New 300 HP are special white under a massive Rally 4 barrel. Underneath: multi-leaf rear springs and heavy-duty shocks. New 300 HP are special white belted tires on 15 x 7-inch wide wheels and a Hurst shifter for the 4-speed. To complete the setup, just add the new 'Vette-type 4-wheel power disc brakes. By now you know the mean streak isn't just painted on—it's built in. One more thing. People are bound to ask what the Z stands for. Tell them "Zaps" **CHEVROLET** Putting you first, keeps us first.

## THE SPORTING COUPE

Affordable, sporty and stylish, "Pony Cars" revolutionized the auto industry when they first appeared in the mid-1960s. A new, younger generation of drivers were instantly attracted to the streamlined body lines with long hoods and powerful engines. Though almost all car manufacturers would introduce their own interpretation of the pony car, few would have as much success as Chevrolet with the iconic Camaro.

## LE COUPÉ SPORTIF

Abordables, sportives et élégantes, les voitures compactes ont révolutionné l'industrie automobile à leur arrivée au milieu des années 1960. Une nouvelle génération de jeunes conducteurs a été immédiatement séduite par les silhouettes aérodynamiques, les longs capots et les moteurs puissants. Bien que presque tous les fabricants de voitures aient créé leur propre voiture compacte, peu ont eu autant de succès que Chevrolet avec l'emblématique Camaro.

**The skier's skier with the Camaro's Camaro.**

**Z/28**

There are skiers. And then there are skiers. The Camaro Z/28 is one of the better. The Camaro Z/28 is a great example of a car that's not just a car, it's a lifestyle. It's got the power windows, the power locks, the power windows, the power locks, the power windows, the power locks. Add four on the floor with a 110-hp engine and you've got the ultimate thing in a "Vette yet. Z/28. It's not just a car, it's a lifestyle. It's got the power windows, the power locks, the power windows, the power locks. Putting you first, keeps us first.

**Z-28**

Competition's newest nightmare!

## EL COUPÉ DEPORTIVO

Accesibles, deportivos y elegantes, los *pony cars* revolucionaron la industria del automóvil cuando aparecieron a mediados de la década de 1960. Una nueva generación de conductores más jóvenes se sintió inmediatamente atraída por las aerodinámicas líneas de sus carrocerías, con largos cofres y potentes motores. Aunque casi todos los fabricantes de automóviles presentarían su propia interpretación del *pony car*, pocos tendrían tanto éxito como Chevrolet con su emblemático Camaro.

## A ROARING SUCCESS

The second-generation Chevrolet Camaro Z28 remains the essence of the perfect Muscle Car. Launched in 1969, the signature "cowl induction" power bulge hood and speed lines stamped into the fenders and doors ensured it was original and distinctive. It refused to borrow from any other auto designs at the time and over 50 years later, it still looks both fresh & bold.

## UN SUCCÈS RETENTISSANT

La Chevrolet Camaro Z28 de deuxième génération demeure la puissante voiture par excellence. Lancée en 1969, cette voiture se distingue par son capot bombé caractéristique et ses lignes de vitesse imprimées sur les ailes et les portes. Elle n'a jamais rien emprunté à d'autres modèles automobiles de l'époque et, plus de 50 ans plus tard, elle est toujours aussi originale et audacieuse.

## UN ÉXITO INDISCUTIBLE

El Chevrolet Camaro Z28 de segunda generación sigue siendo el mejor representante de los autos deportivos de gran potencia. Lanzado al mercado en 1969, el característico cofre *power bulge* de inducción de aire y las líneas de velocidad modeladas en las defensas y las puertas garantizaban que fuera original y diferente de cualquier otro auto. Rehusó adoptar el diseño de otros vehículo de la época y, más de 50 años después, su aspecto sigue revistiendo frescura y audacia.



camaro

Camaro

CAMARO



1967 – 1969

1970 – 1981

1982 – 1992

### A MOTORING ICON

Though it's 55 years since the first Chevrolet Camaro launched, this famous marque is still very much alive and relevant, with the sixth generation of this iconic vehicle in production today. It's a brand and a name that continues to reach across different generations, beloved by hard-core Muscle Car enthusiasts and featured in countless Video Games, TV shows, Movies and pop culture.

### UNE ICÔNE AUTOMOBILE

Bien qu'il se soit écoulé 55 ans depuis le lancement de la première Chevrolet Camaro, ce célèbre véhicule est toujours aussi important, et sa sixième génération est en production à l'heure actuelle. C'est un emblème qui continue de toucher différentes générations, qui est adoré par les mordus de puissantes voitures et qui apparaît dans d'innombrables jeux vidéo, séries télévisées, films et autres éléments de la culture populaire.

CAMARO

CAMARO



1993 – 2002

2010 – 2015

2016 –

## UN ÍCONO DE LOS MOTORES

Si bien han pasado 55 años desde el lanzamiento del primer Chevrolet Camaro, la célebre marca está más viva y es más relevante que nunca, fabricando en la actualidad la sexta generación del inconfundible vehículo. La marca y el nombre siguen fascinando a diferentes generaciones, cuentan con el aprecio de los mayores entusiastas de los autos deportivos de gran potencia y aparecen en innumerables videojuegos, programas de televisión y películas como parte fundamental de la cultura pop.



## FROM THE DESIGN TEAM

*"I grew up with a strong passion for cars and started flipping through hot rod magazines at a very early age, so being able to work on this LEGO® model with real Chevrolet car designers was a dream come true. One thing was getting the overall styling and stance right, but we also wanted to add in those fun but essential details like functioning doors and working steering. It was also great to be able to offer some customization options just like the original Camaro did back in the day."*

**Sven Franic, LEGO® Designer**

## UN MOT DE L'ÉQUIPE DE CONCEPTION

*« J'ai grandi avec une profonde passion pour les voitures et j'ai commencé à feuilleter les magazines de bolides à un très jeune âge, alors pouvoir travailler sur ce modèle LEGO® avec de vrais concepteurs de voitures Chevrolet était un rêve devenu réalité. Il fallait d'abord veiller à respecter le caractère et l'allure, mais nous voulions aussi ajouter des détails amusants, mais essentiels, comme des portes et une direction fonctionnelles. Il était également formidable de pouvoir proposer des options de personnalisation, tout comme c'était le cas pour la Camaro originale à l'époque. »*

**Sven Franic, concepteur LEGO®**

## IMPRESIONES DEL EQUIPO DE DISEÑO

*"Crecí sintiendo una profunda pasión por los automóviles y empecé a hojear revistas de autos deportivos cuando era muy chico, así que poder trabajar en este modelo LEGO® con verdaderos diseñadores de autos Chevrolet fue un sueño hecho realidad. Queríamos acertar con el estilo y el porte en general, pero también era importante incluir funciones y detalles divertidos aunque esenciales, por ejemplo, haciendo que las puertas funcionaran e incluyendo el mecanismo de dirección. También fue genial poder ofrecer algunas opciones de personalización, tal como las ofrecía el Camaro original en su día".*

**Sven Franic, diseñador de LEGO®**



## YOUR MODEL. YOUR CHOICE.

One of the most popular features of the original Camaro was the offer of a wide range of personalization options and high-performance engines. Likewise, it's up to you to decide how you want to style your LEGO® version of the car: should it be a hardtop Coupe or a cool Convertible? And what about the striping? Classic white, subtle gray or a stand-out red? There are also optional covers for the headlights and two license plates to choose from.

## VOTRE MODÈLE. VOTRE CHOIX.

L'une des caractéristiques les plus populaires de la Camaro originale était de proposer un large éventail d'options de personnalisation et de moteurs à haute performance. De même, il vous revient de décider du style de votre version LEGO® de la voiture : devrait-elle être un faux-cabriolet (coupé) ou un cabriolet ? Et qu'en est-il des rayures ? Un blanc classique, un gris subtil ou un rouge éclatant ? Des couvre-phares optionnels et deux plaques d'immatriculation sont également inclus.



The three models cannot be built simultaneously.

You can find the instructions to these alternate models online at:  
[LEGO.com/buildinginstructions](https://www.lego.com/buildinginstructions)



## TU MODELO. TUS PREFERENCIAS.

Una de las características más populares del Camaro original era su amplia gama de opciones en cuanto a personalización y motores de alto desempeño. Del mismo modo, te ofrecemos la oportunidad de elegir como quieras el estilo de tu versión LEGO® del auto: ¿debería ser un coupé de techo rígido o un genial convertible? ¿Y las franjas? ¿Clásicas en blanco, en un discreto gris o en un llamativo rojo? También encontrarás cubiertas opcionales para los faros delanteros y dos placas de circulación para elegir.

Les trois modèles ne peuvent pas être construits simultanément.

Vous trouverez les instructions pour ces modèles alternatifs en ligne à l'adresse suivante : [LEGO.com/buildinginstructions](https://LEGO.com/buildinginstructions)

No es posible construir simultáneamente los tres modelos.

Las instrucciones de estos modelos alternos están disponibles en línea en: [LEGO.com/buildinginstructions](https://LEGO.com/buildinginstructions)



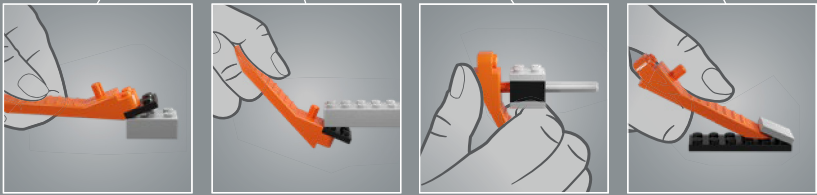
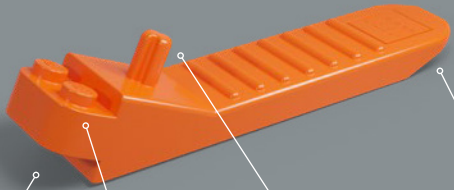
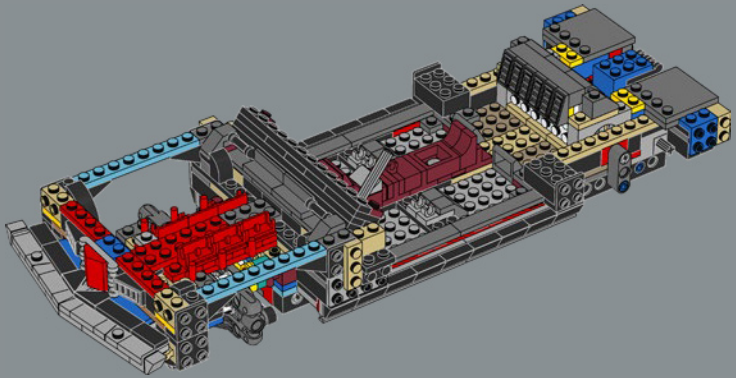
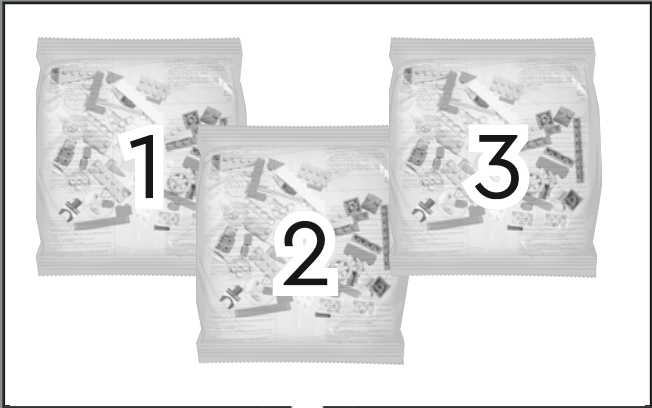

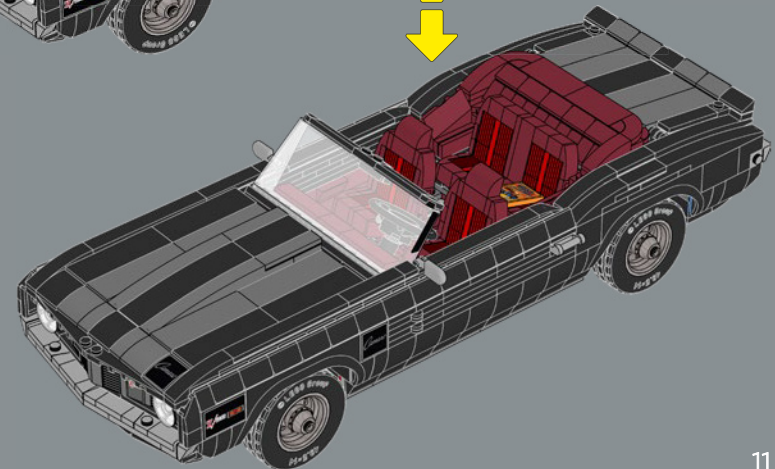
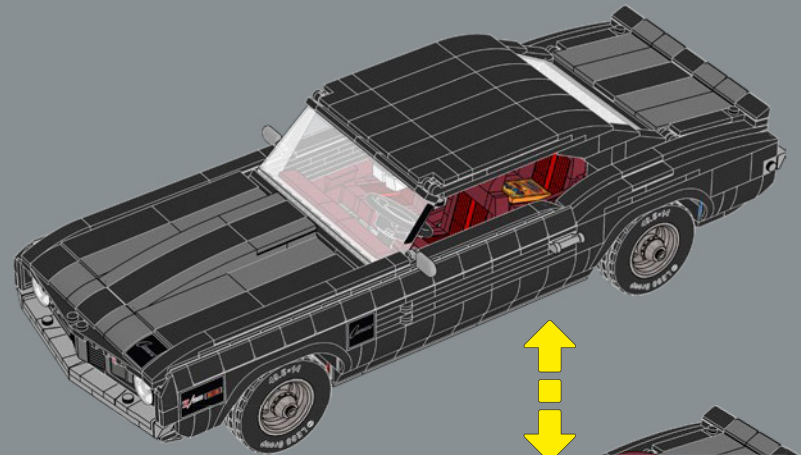
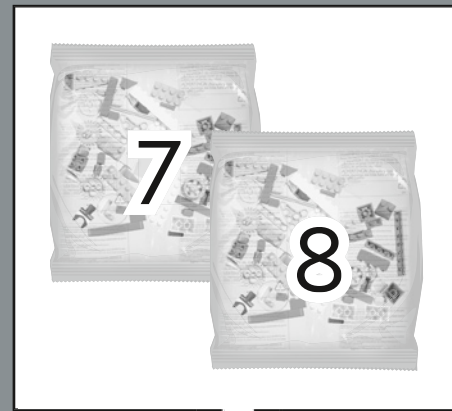
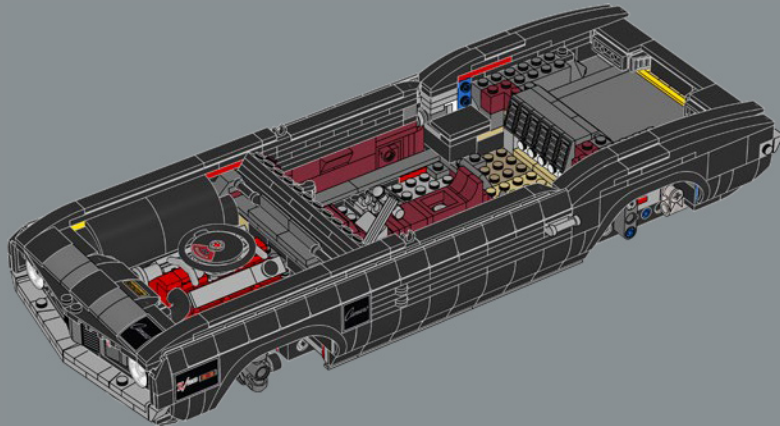
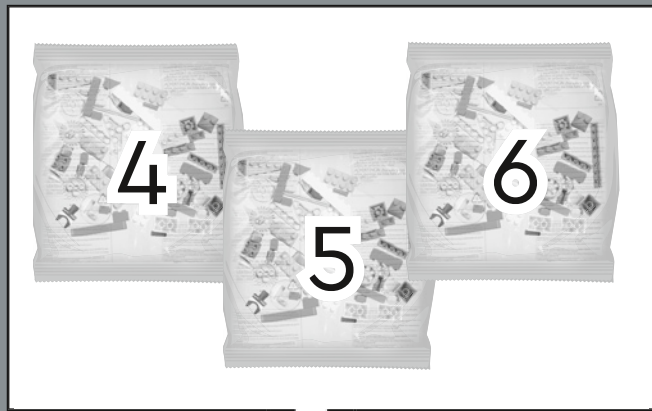

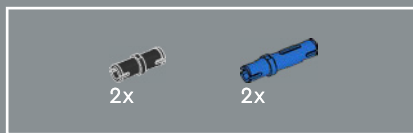
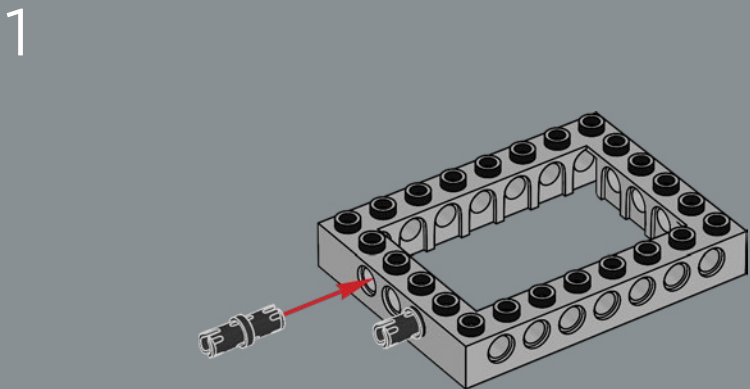
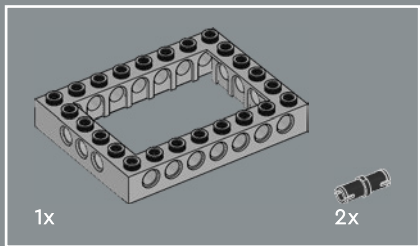

2

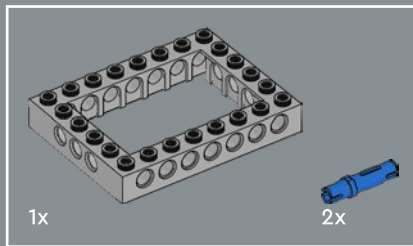
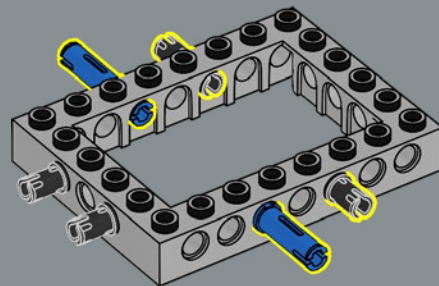

3

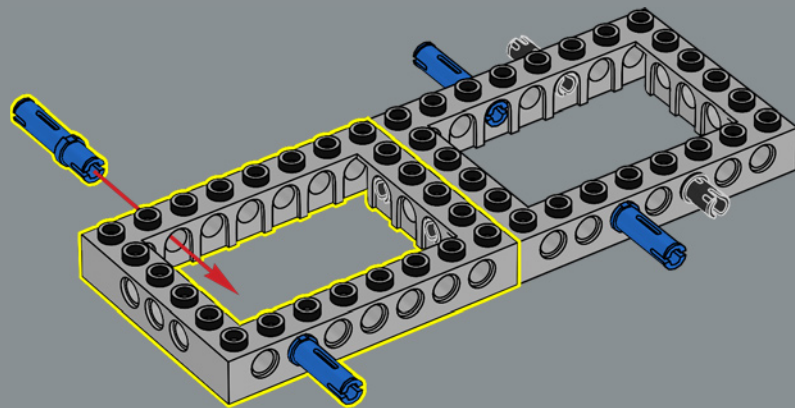

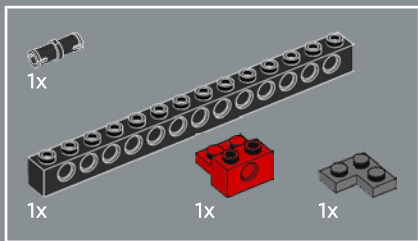

4

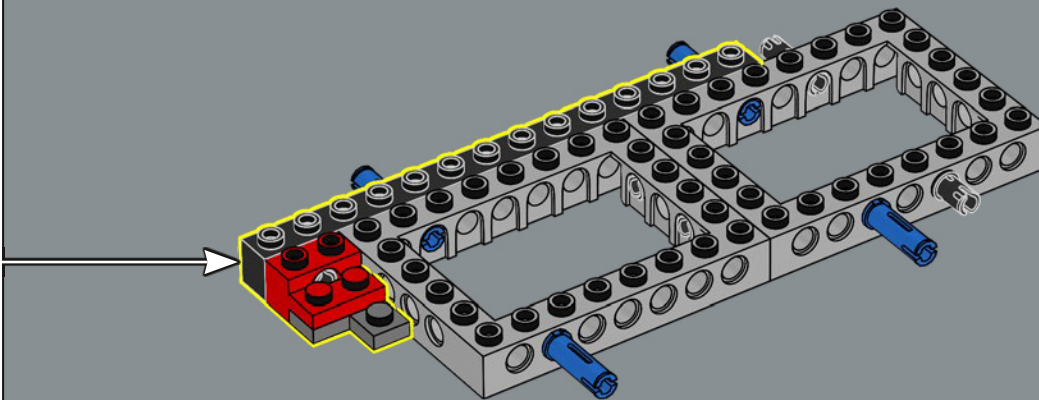
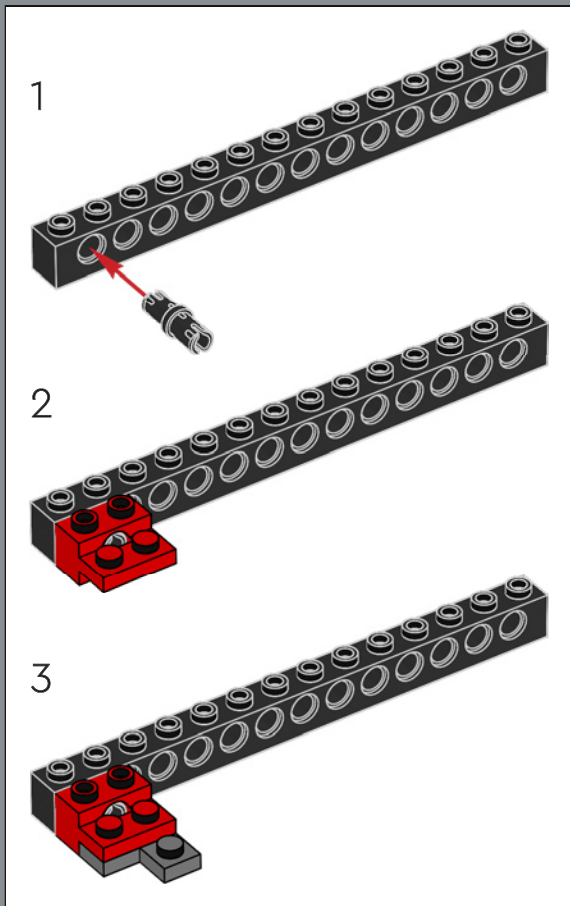

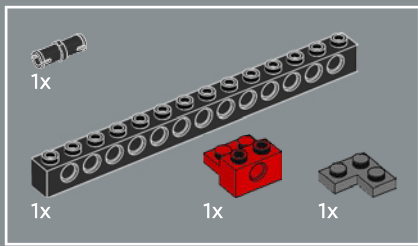

5

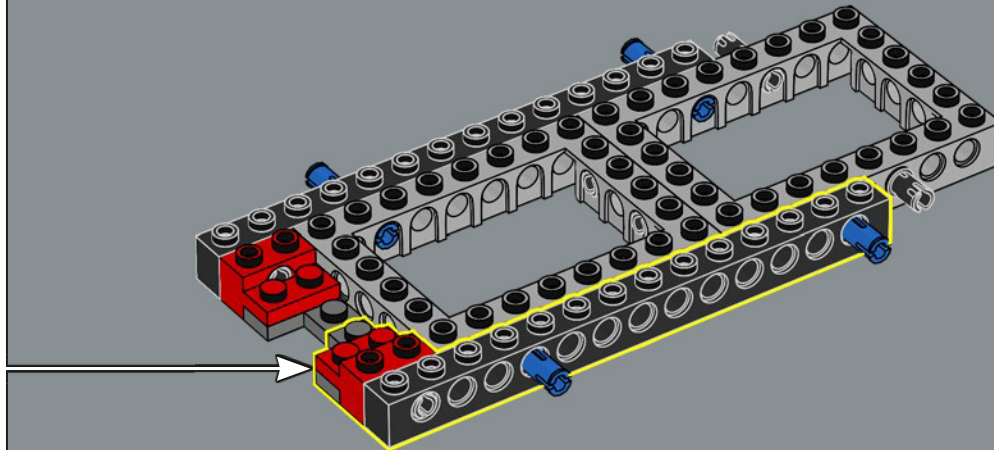
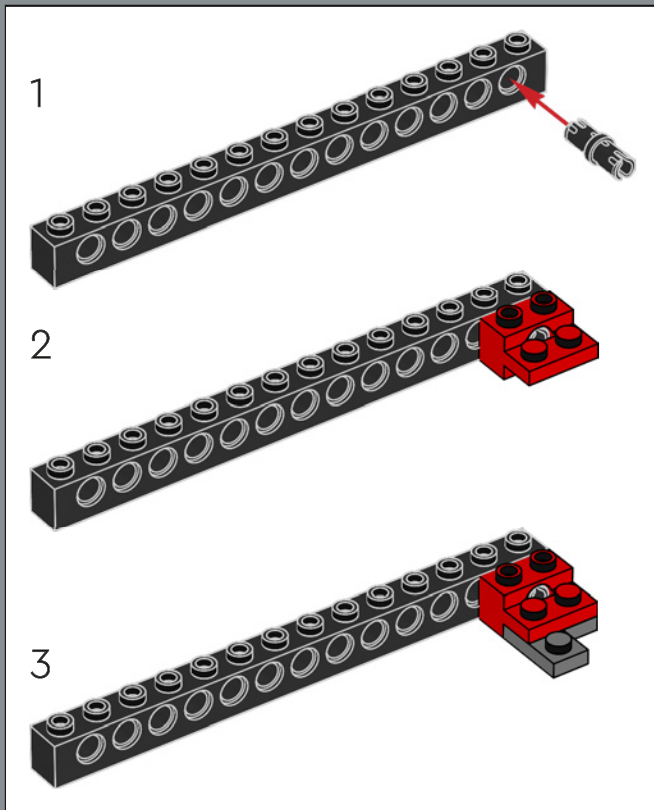

The Camaro name fits with the Chevrolet tradition of starting most of their models with the letter 'C' (Corvaire, Corvette, Chevelle, etc.).

La dénomination Camaro perpétue la tradition de Chevrolet de désigner la plupart de ses modèles par un nom commençant par la lettre « C » (Corvaire, Corvette, Chevelle, etc.).

El nombre Camaro encaja en la tradición de Chevrolet de elegir nombres que comenzaran por la letra "C" para sus modelos (como Corvaire, Corvette, Chevelle, etc.).

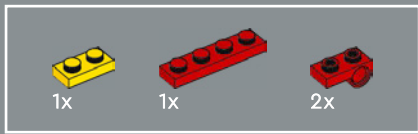

6

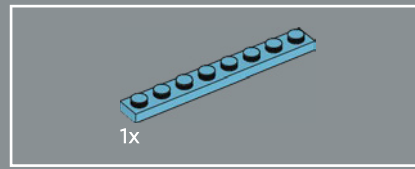
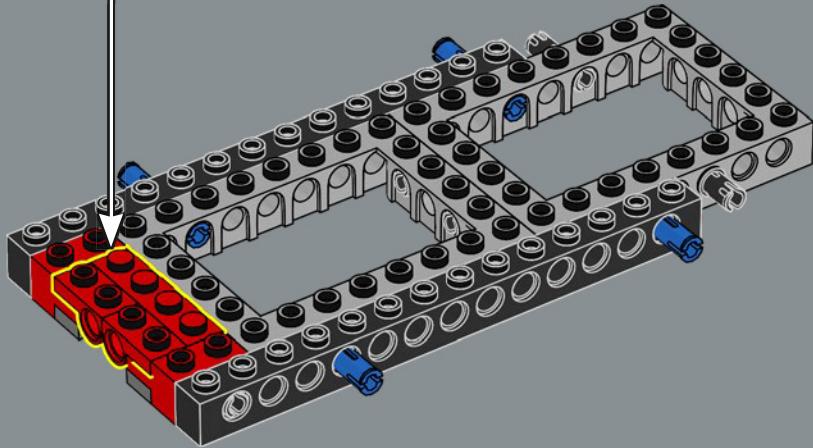
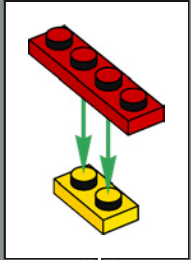

7

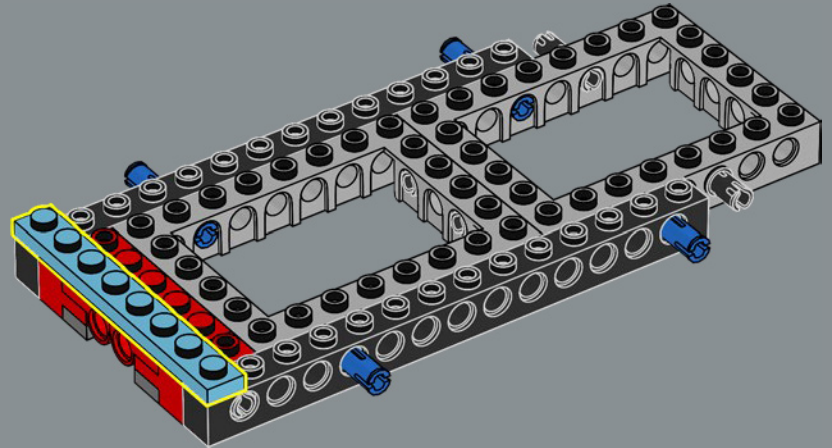

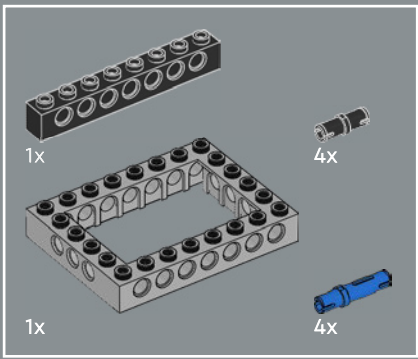

8

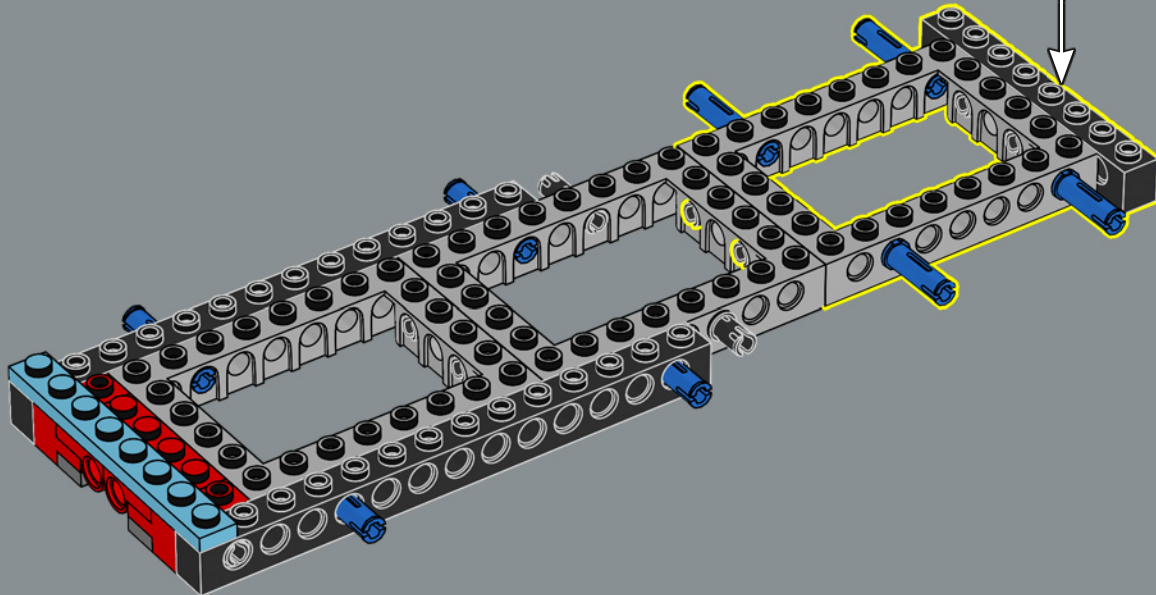
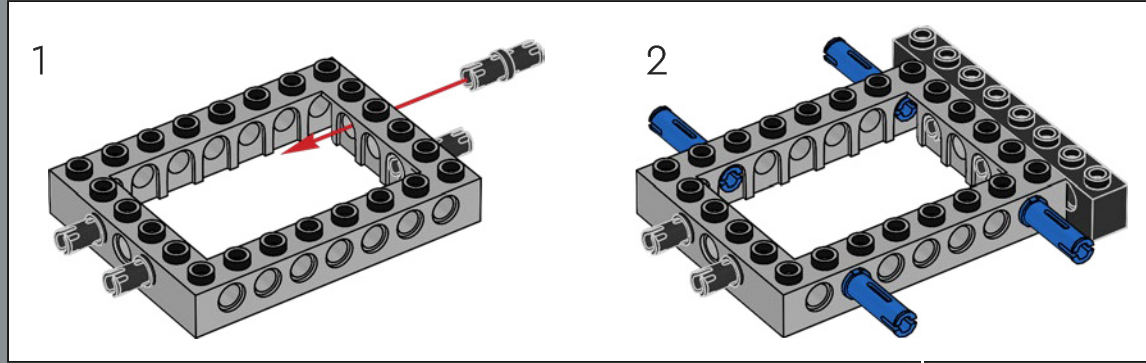



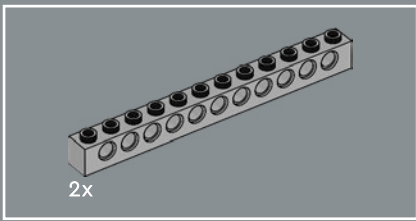

9

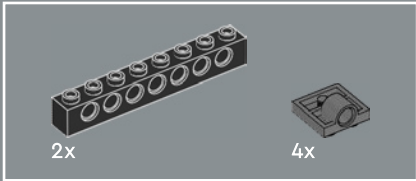
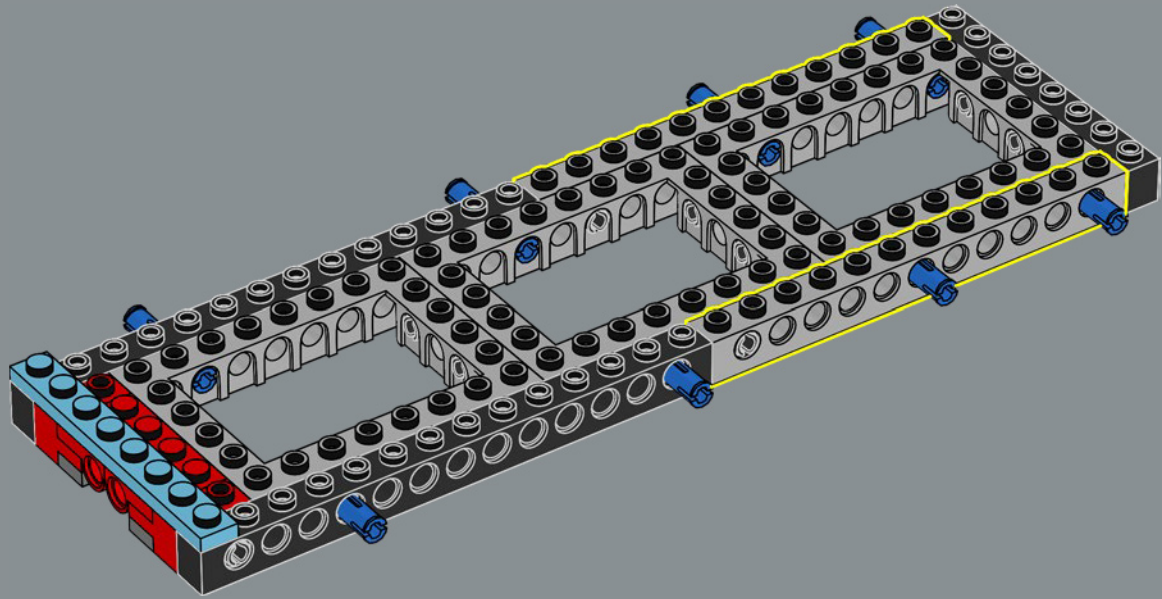

10

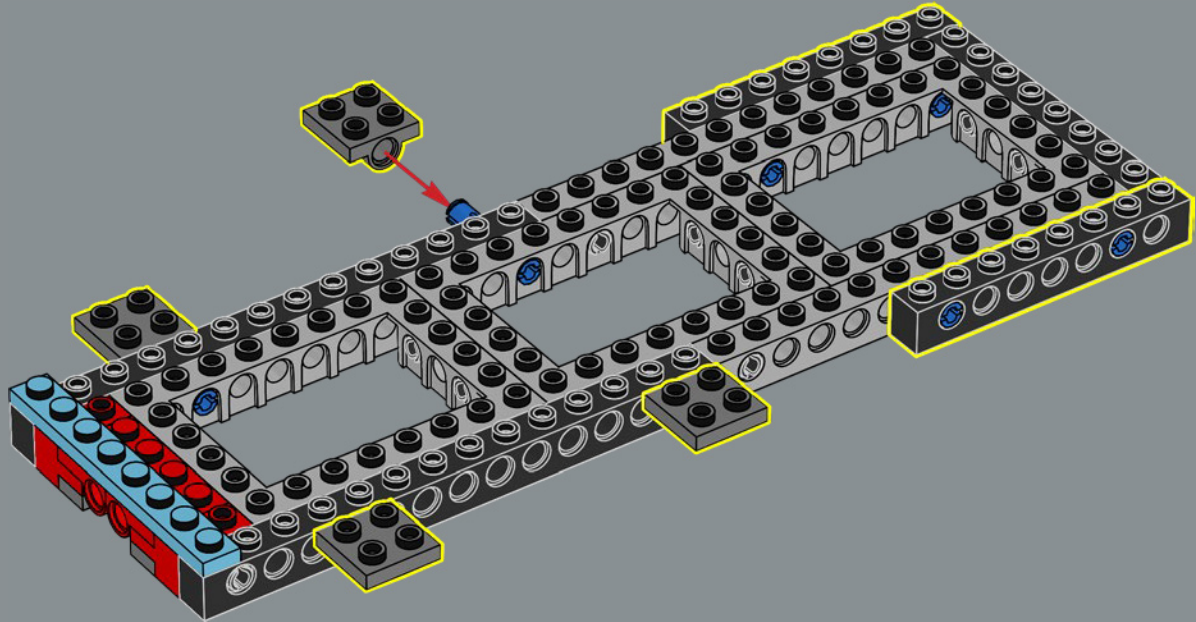

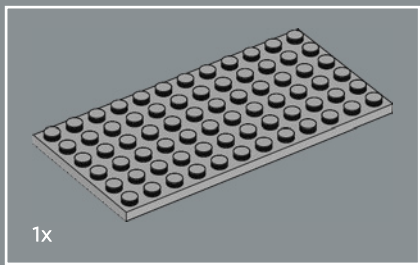

11

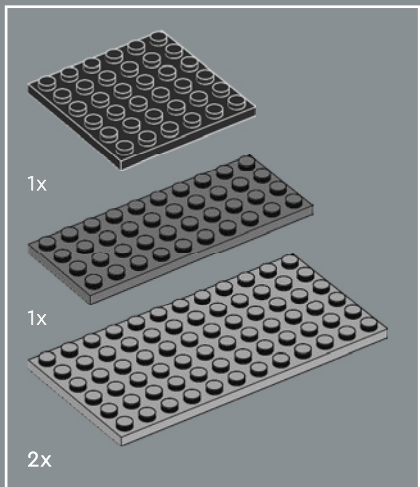
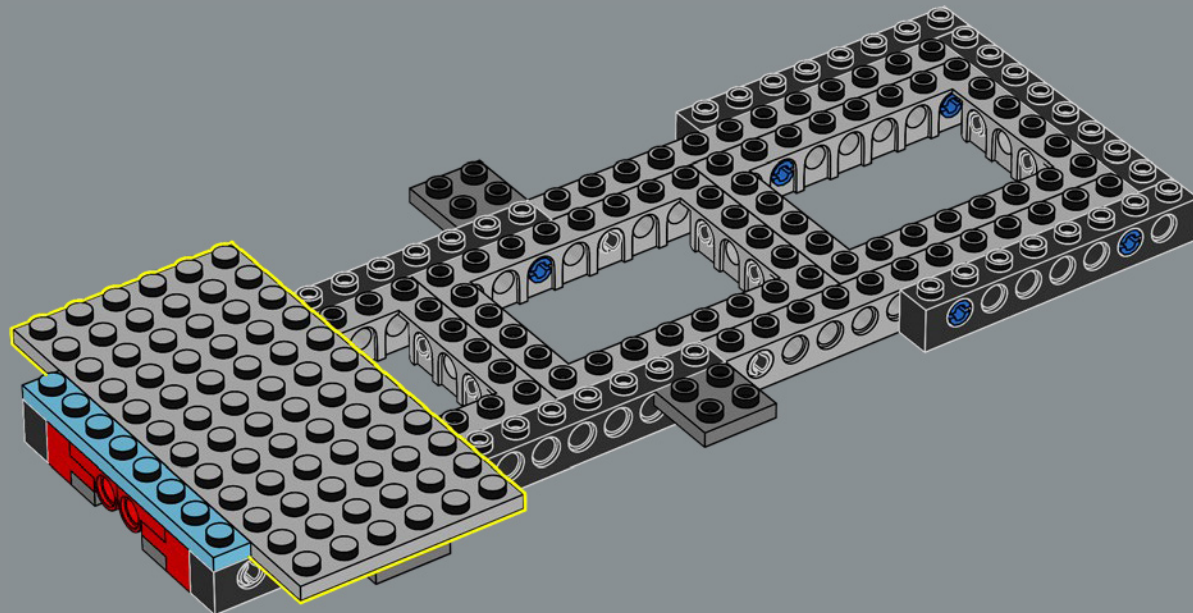

12

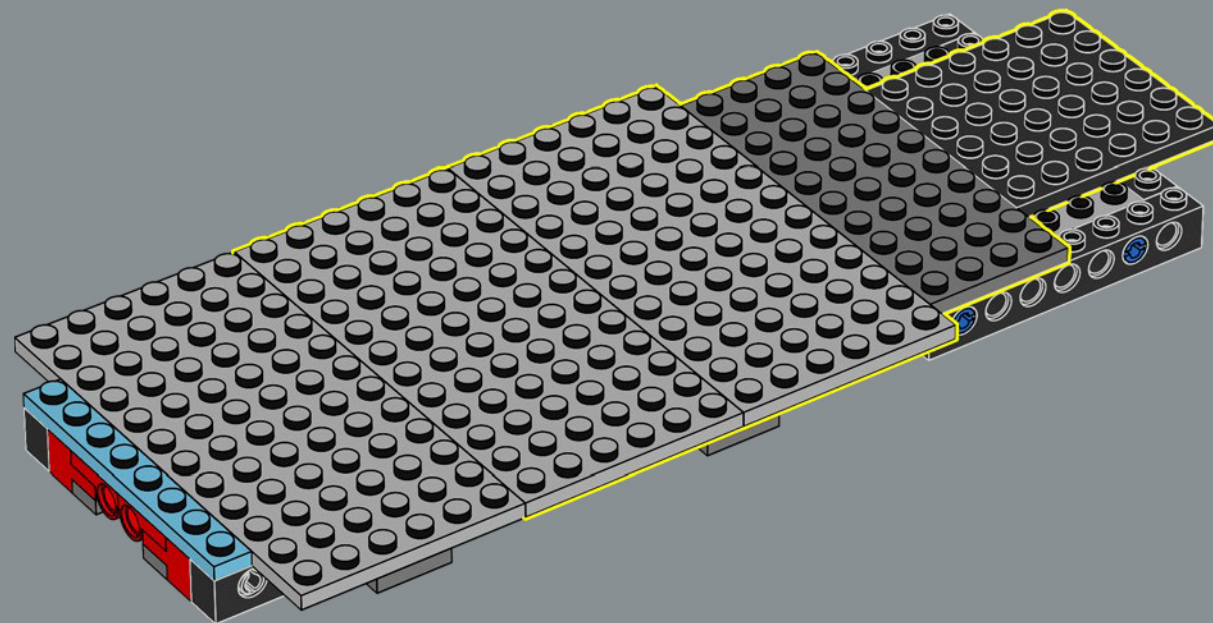



13

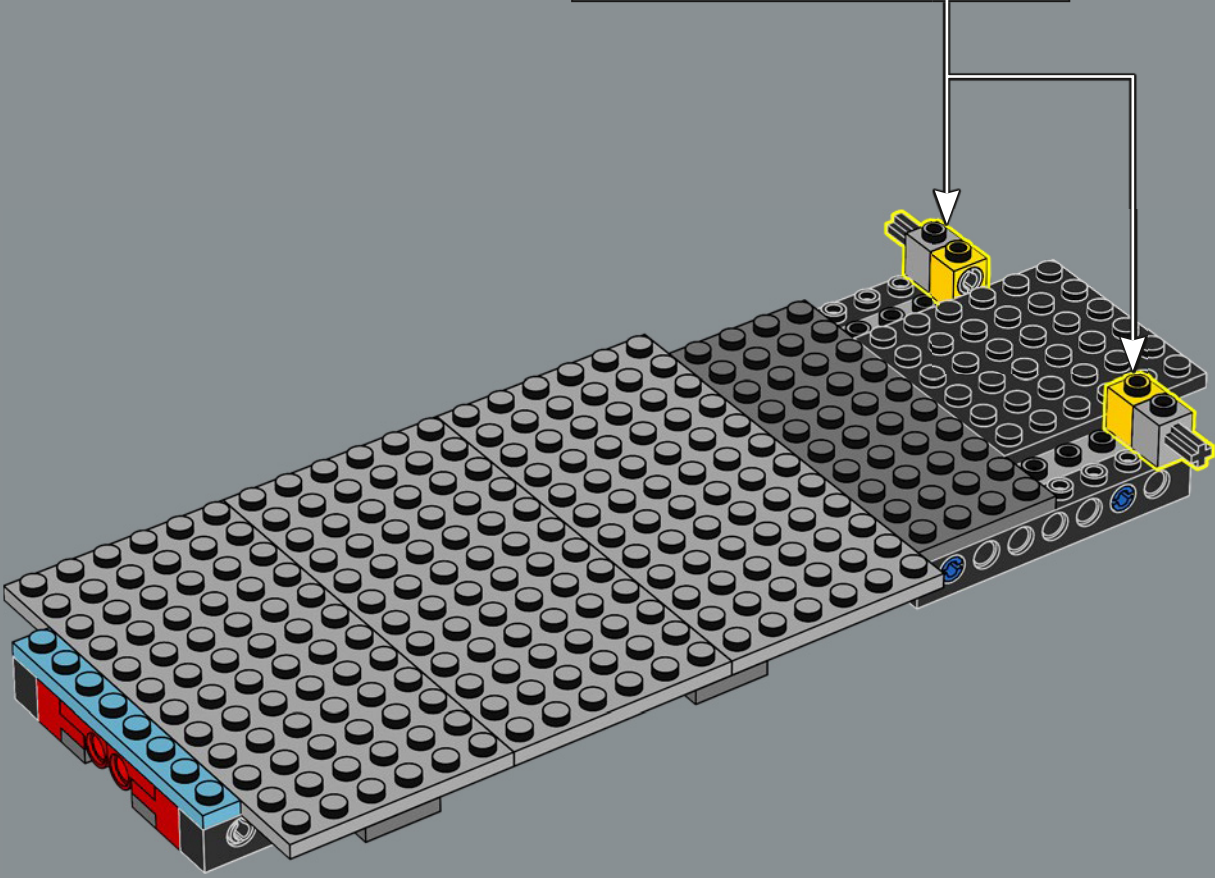
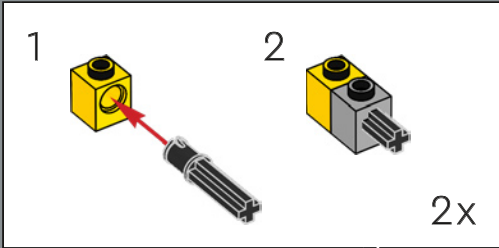

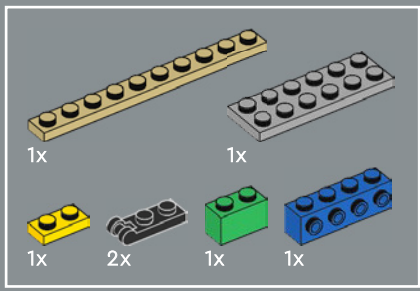

14

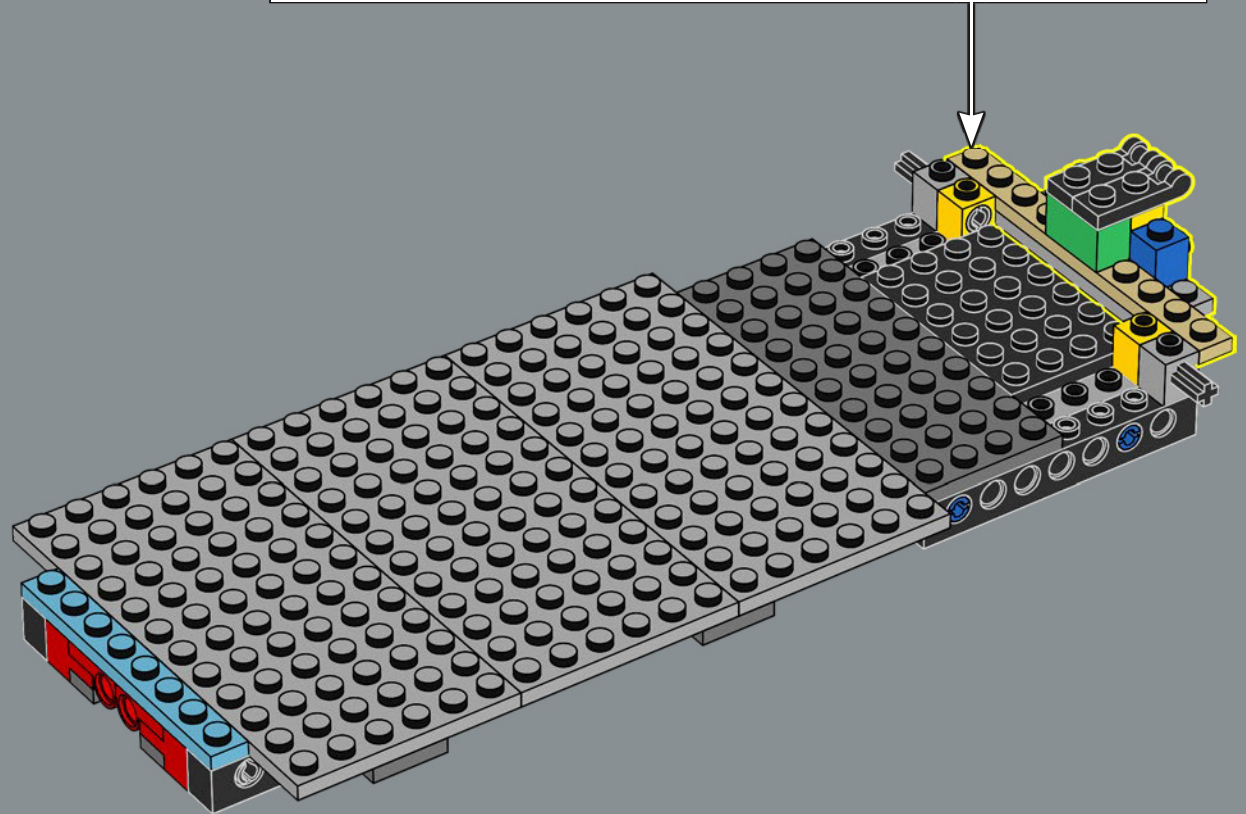
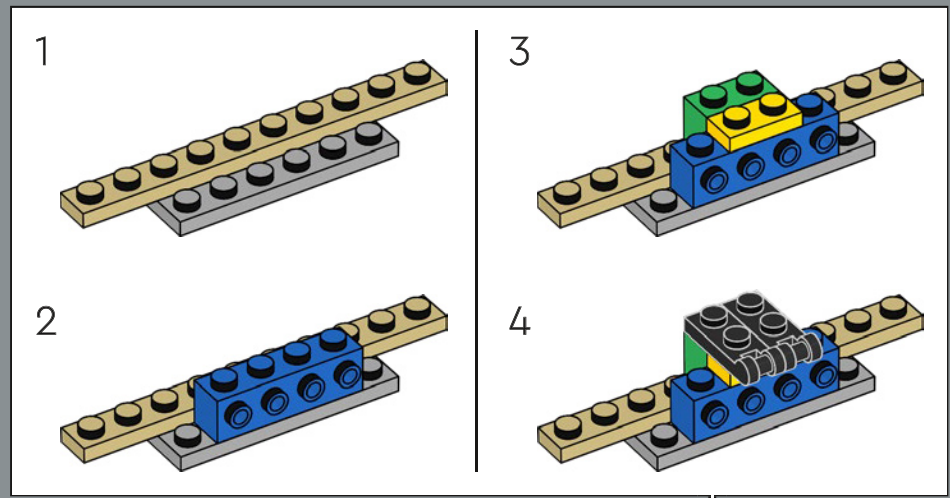

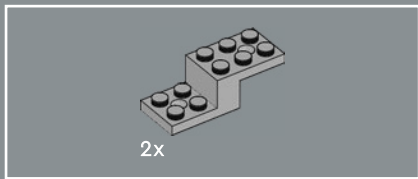

15

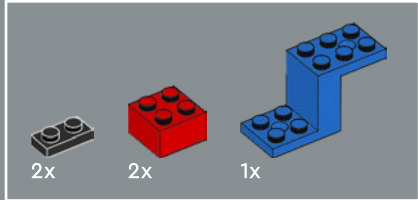
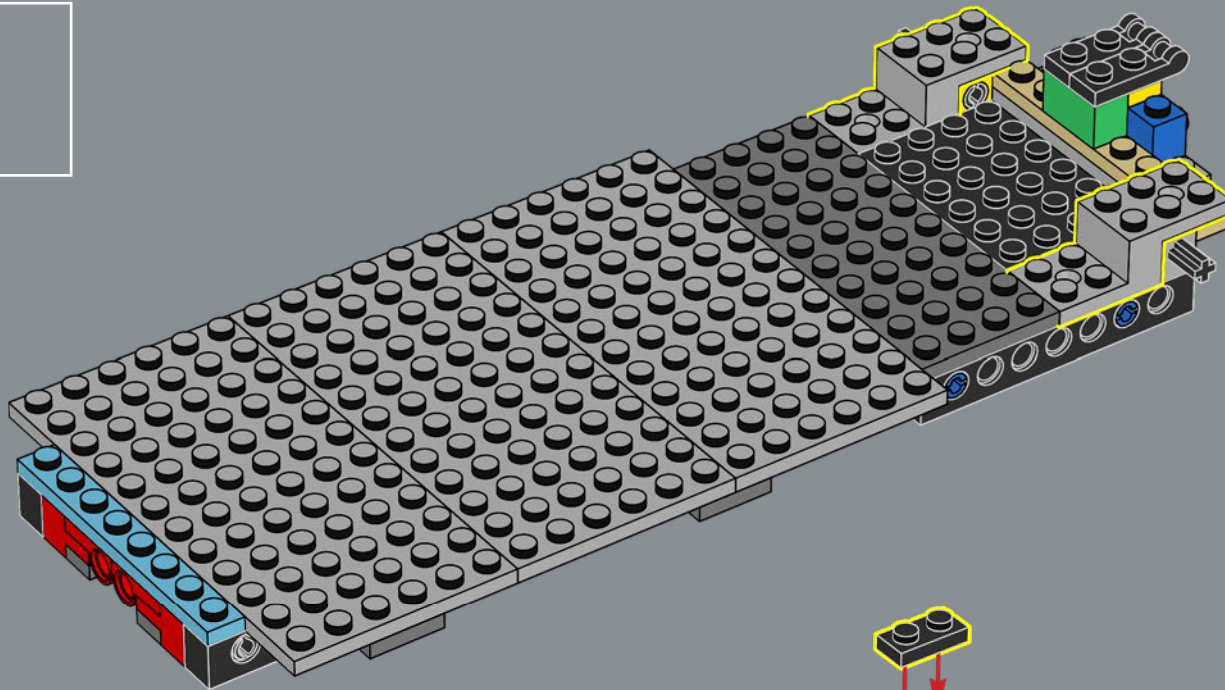

16

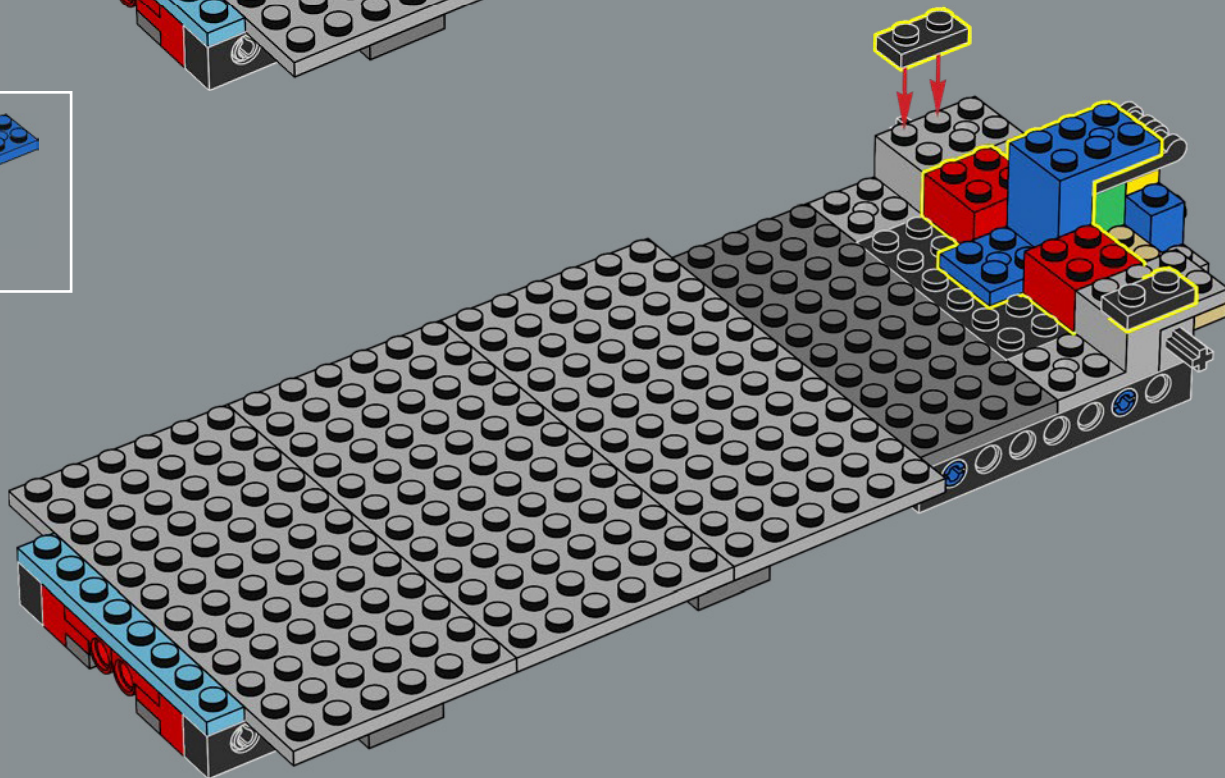

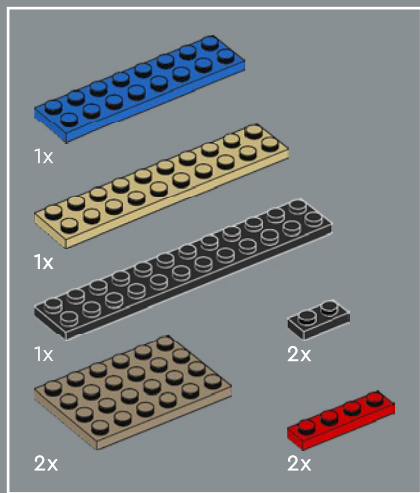

17

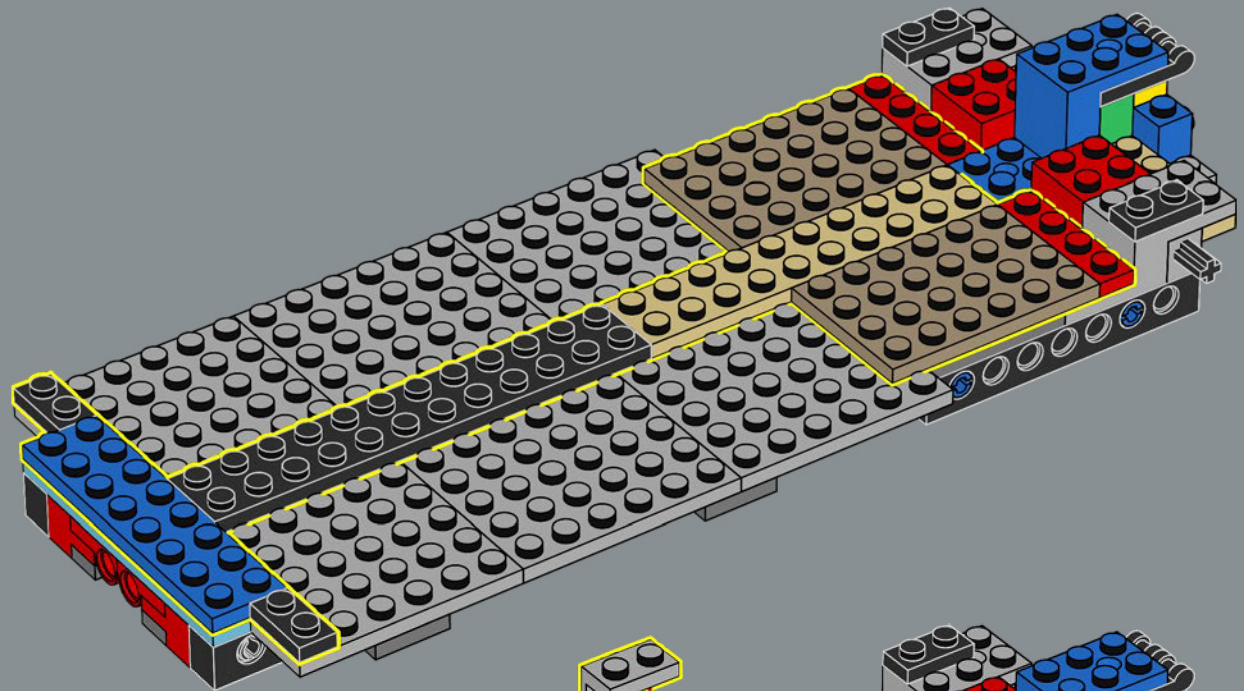

18

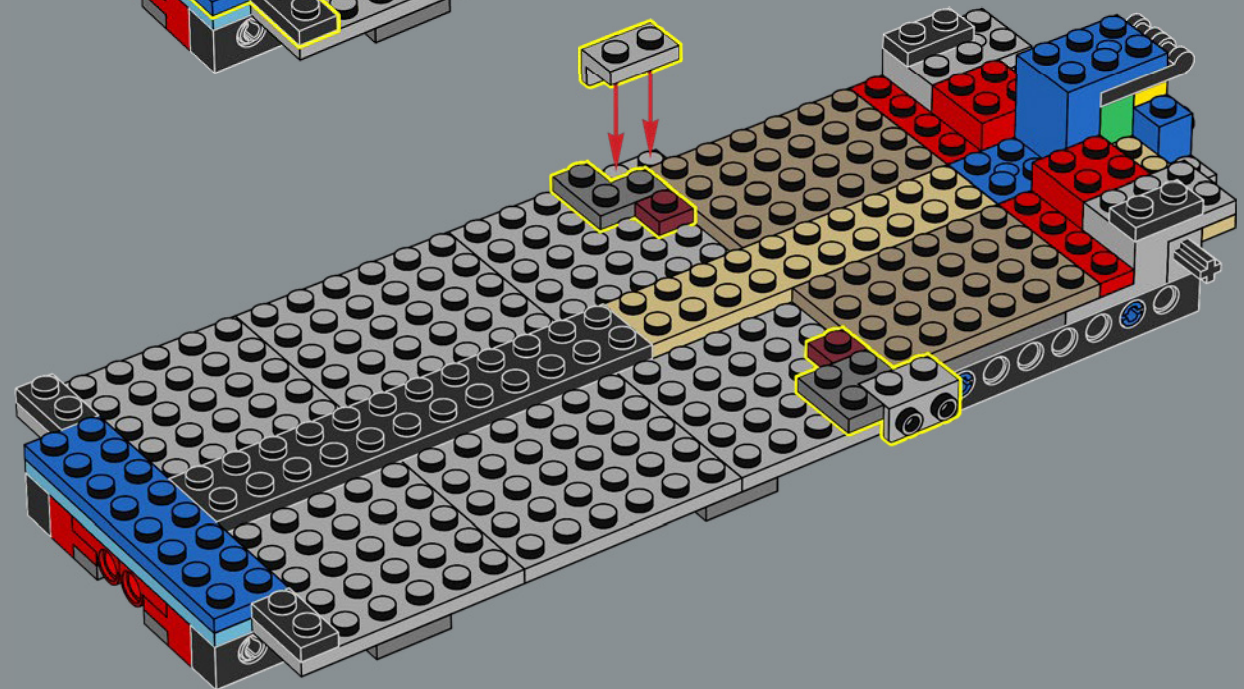

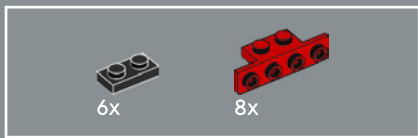

19

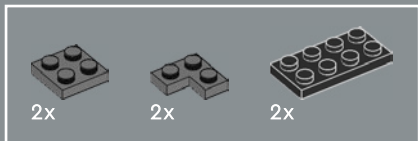
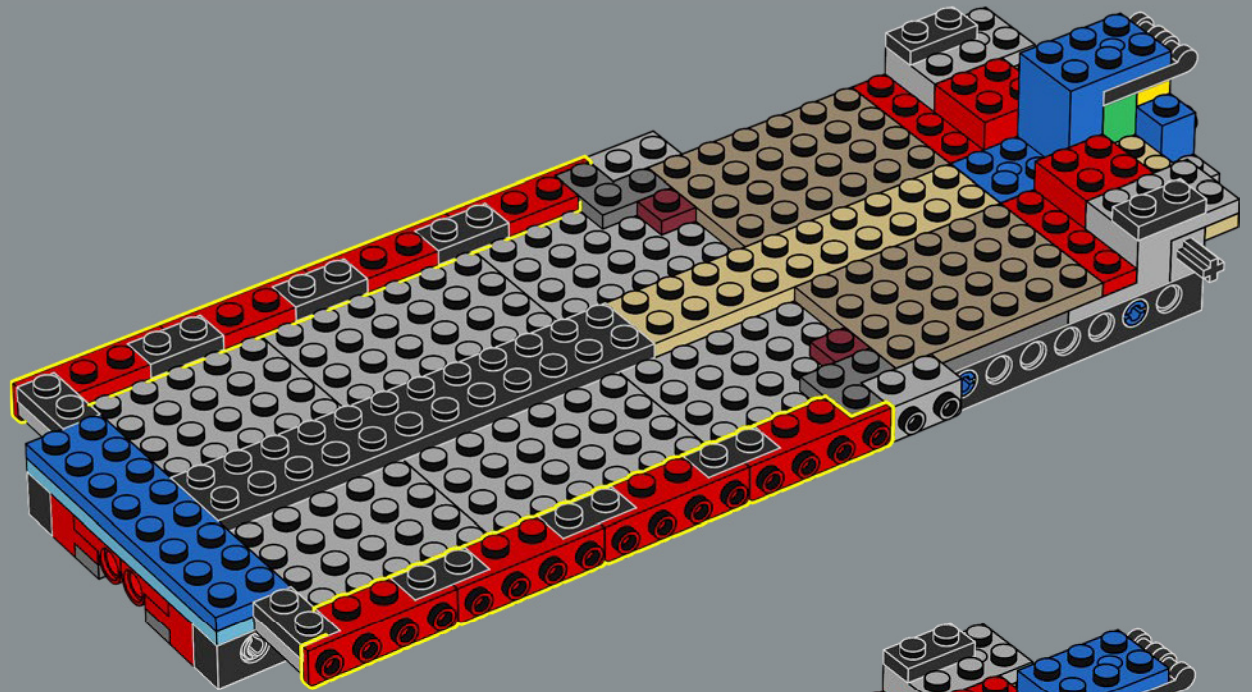

20

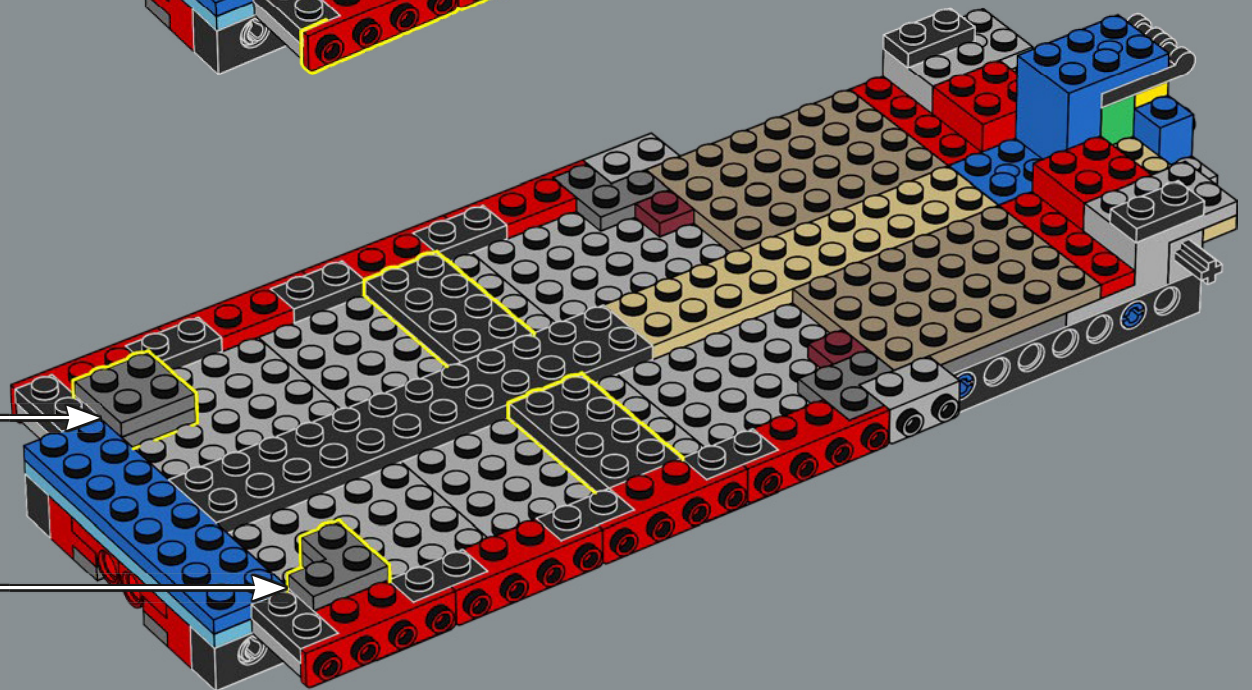
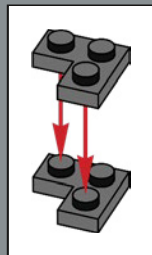
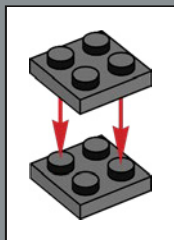

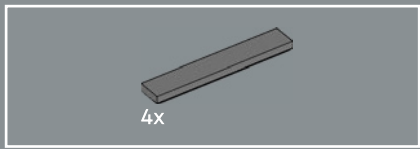

21

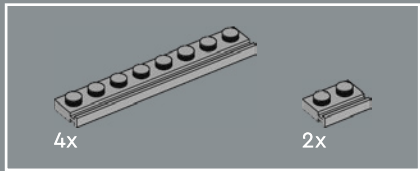
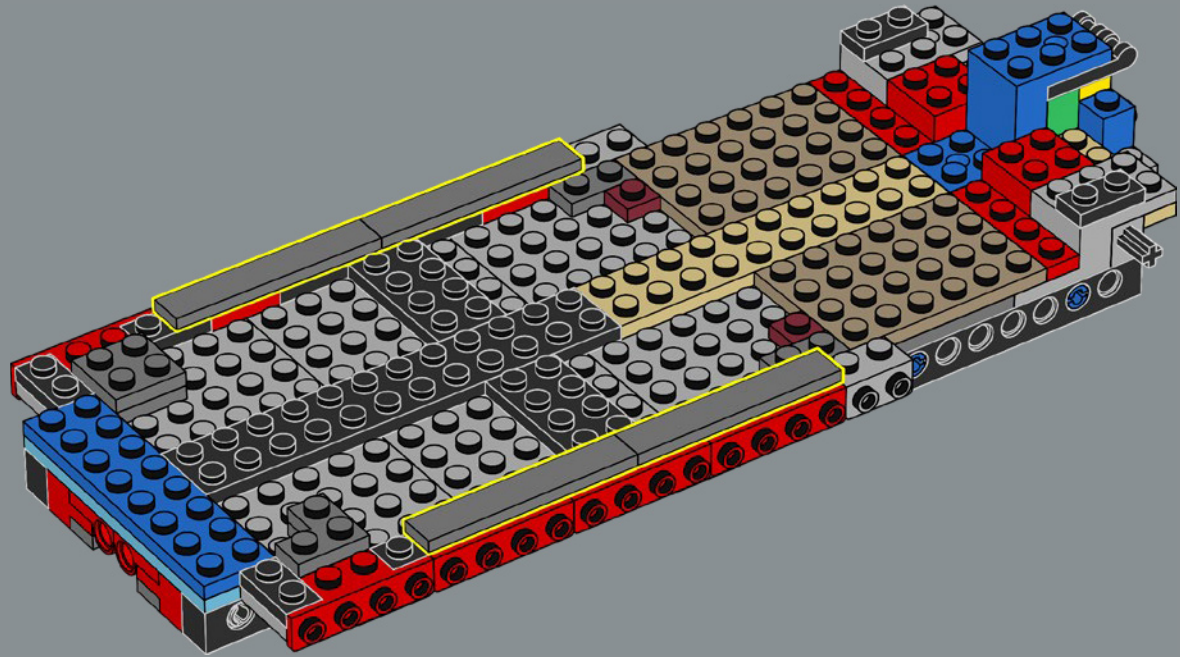

22

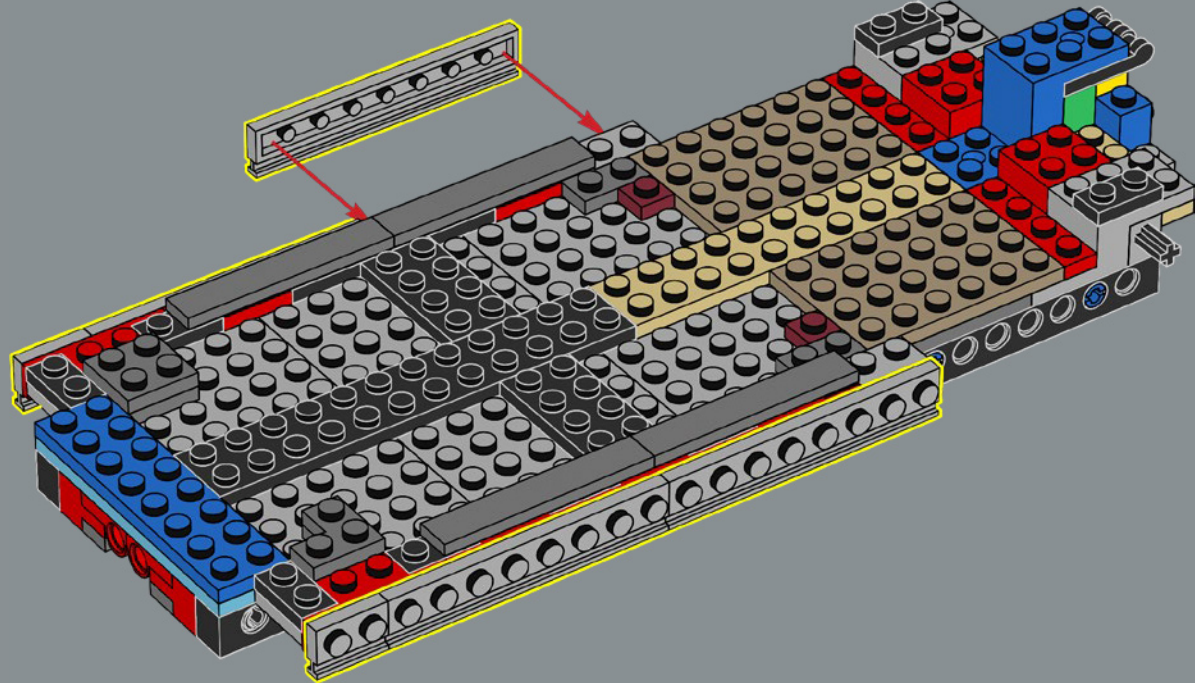





23

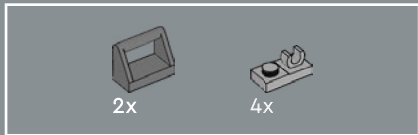
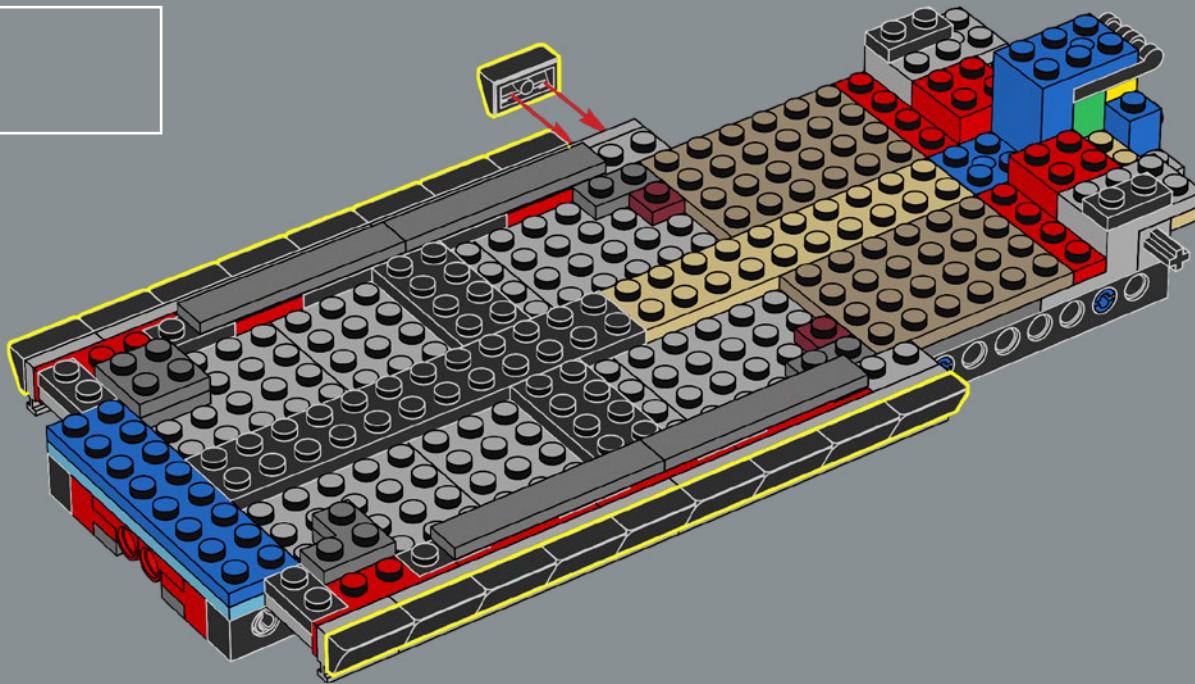

24

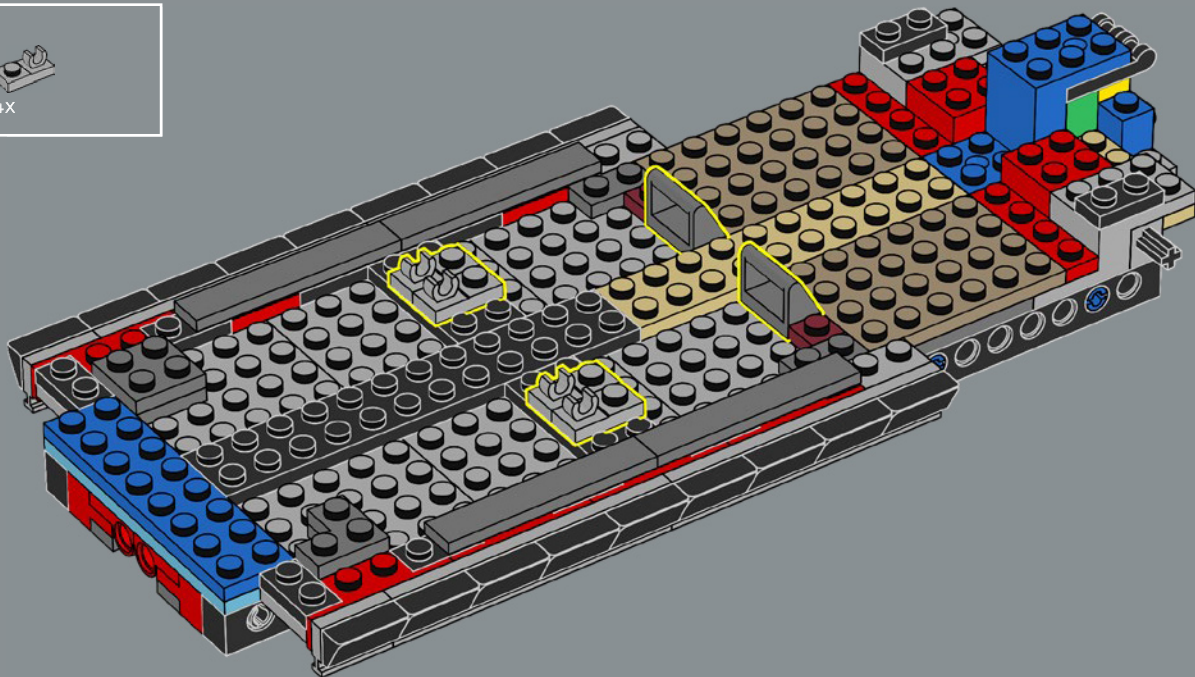



4x

25

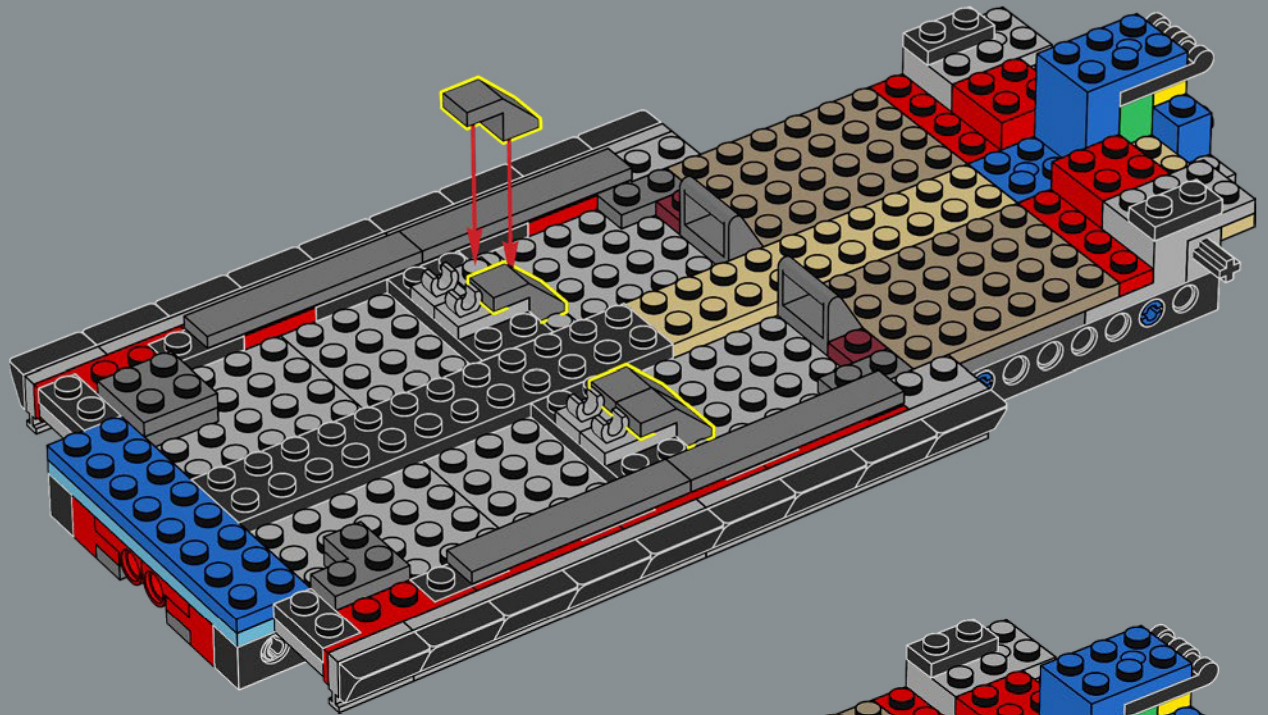

1x



1x



1x

26

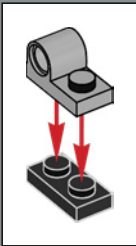
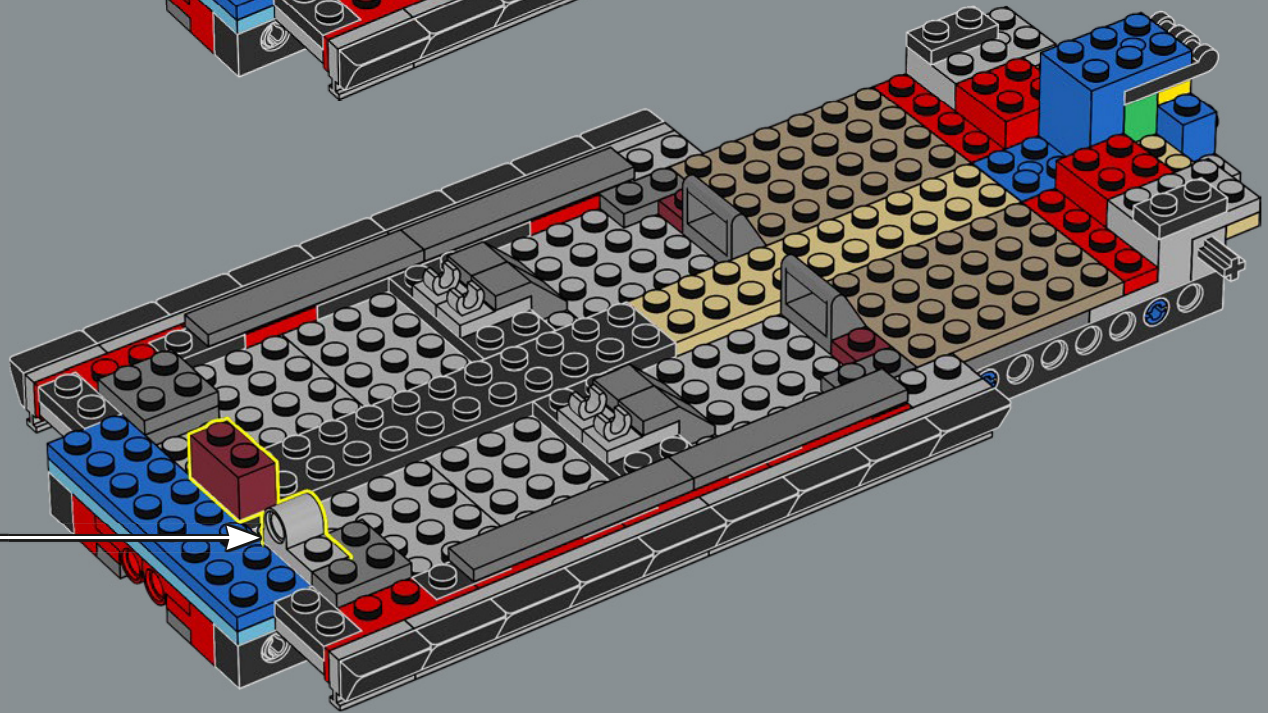

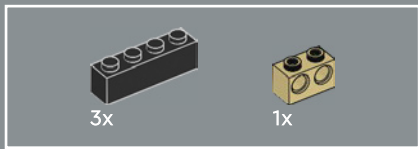

27

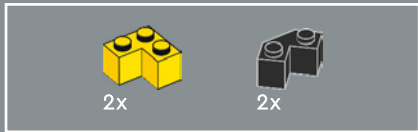
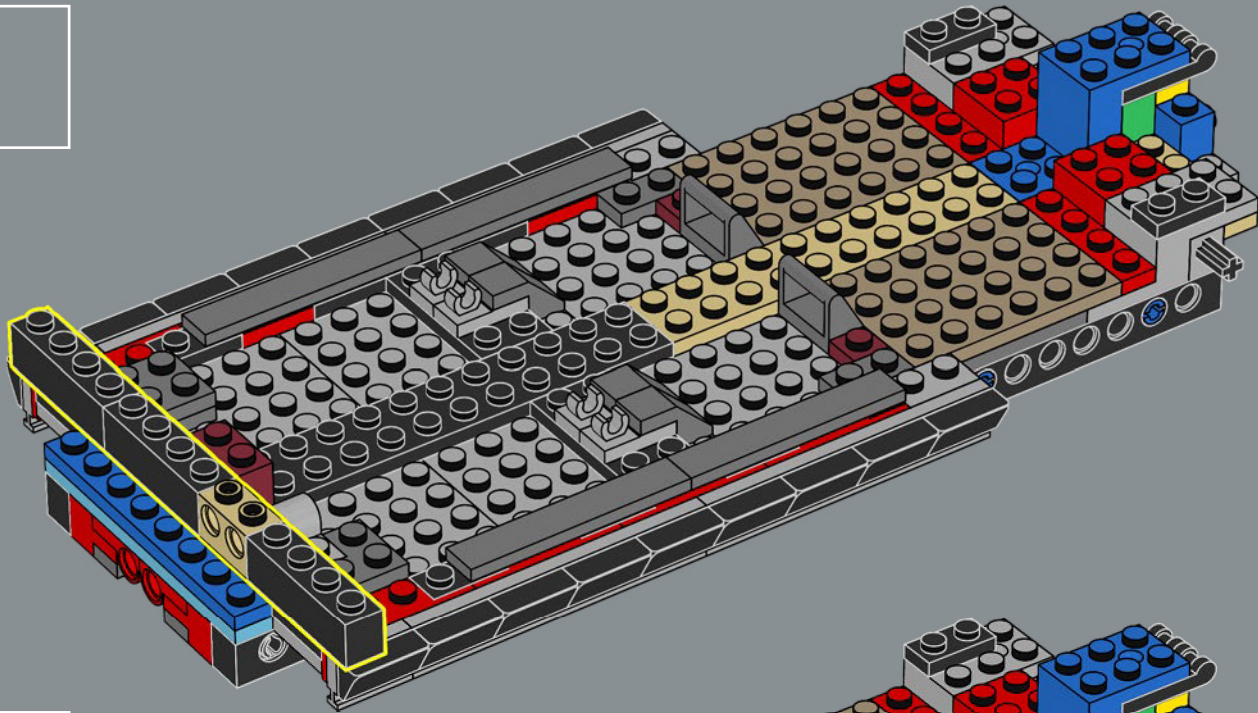

28

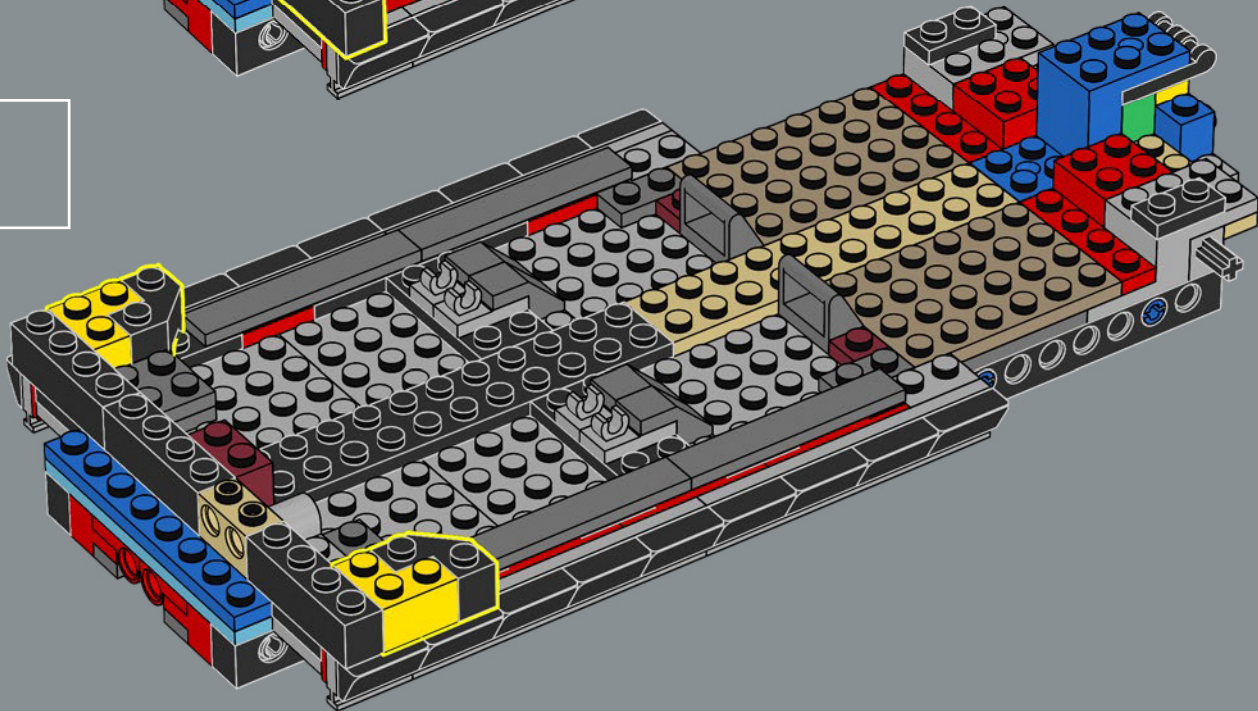



29

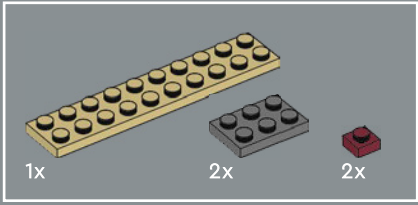
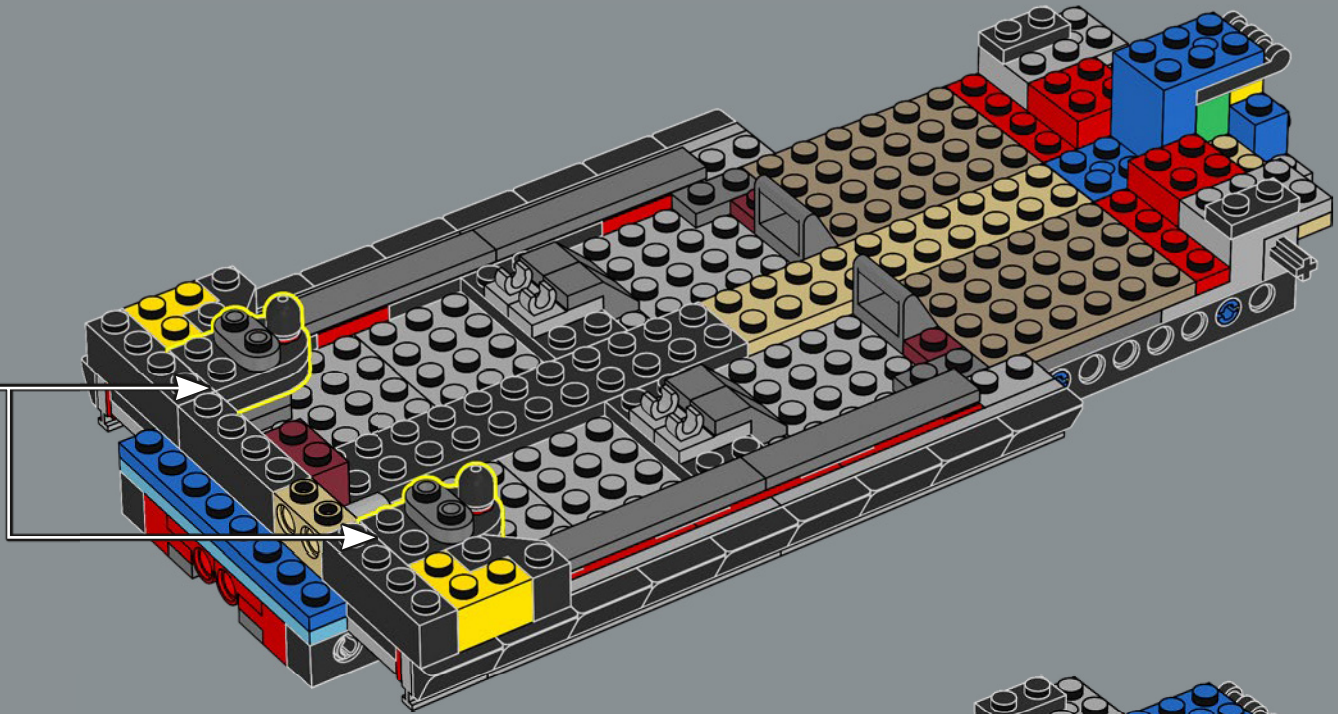
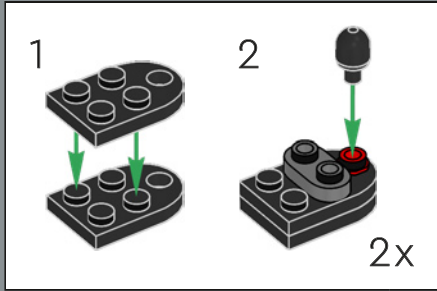

30

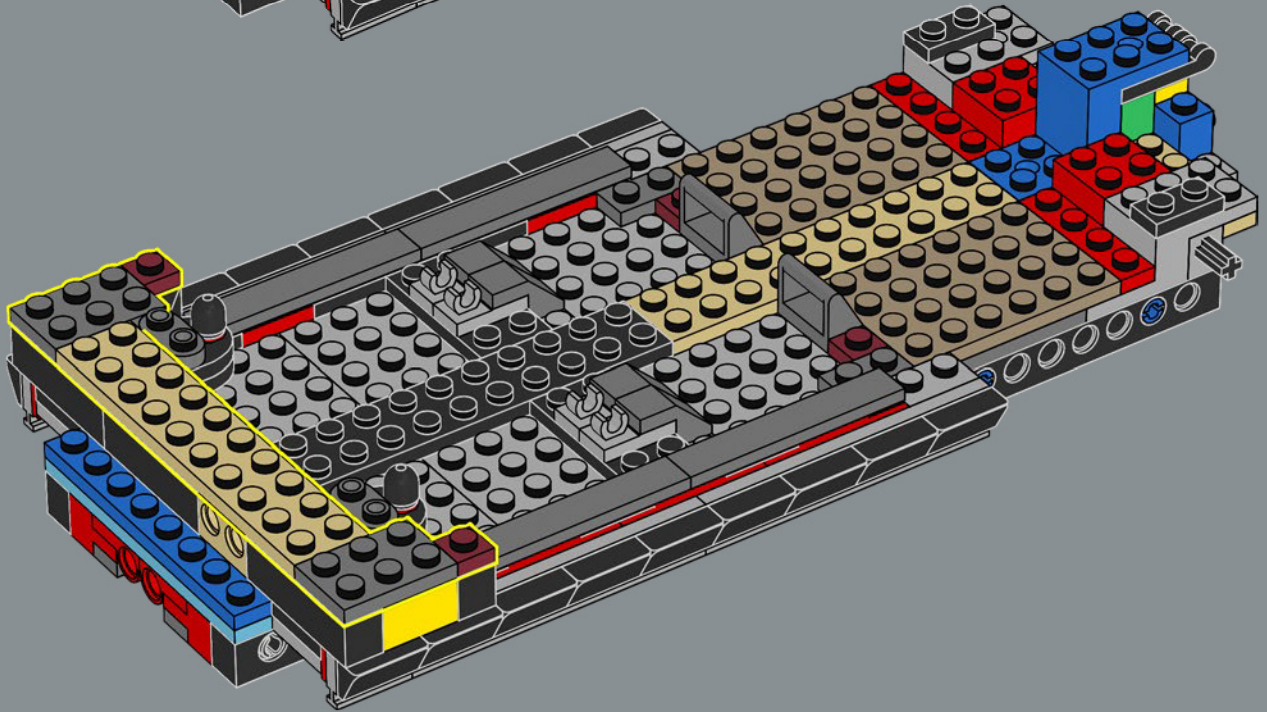

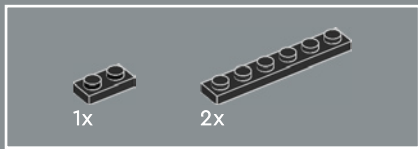

31

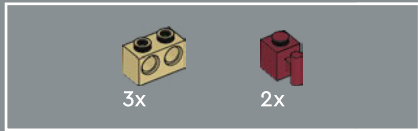
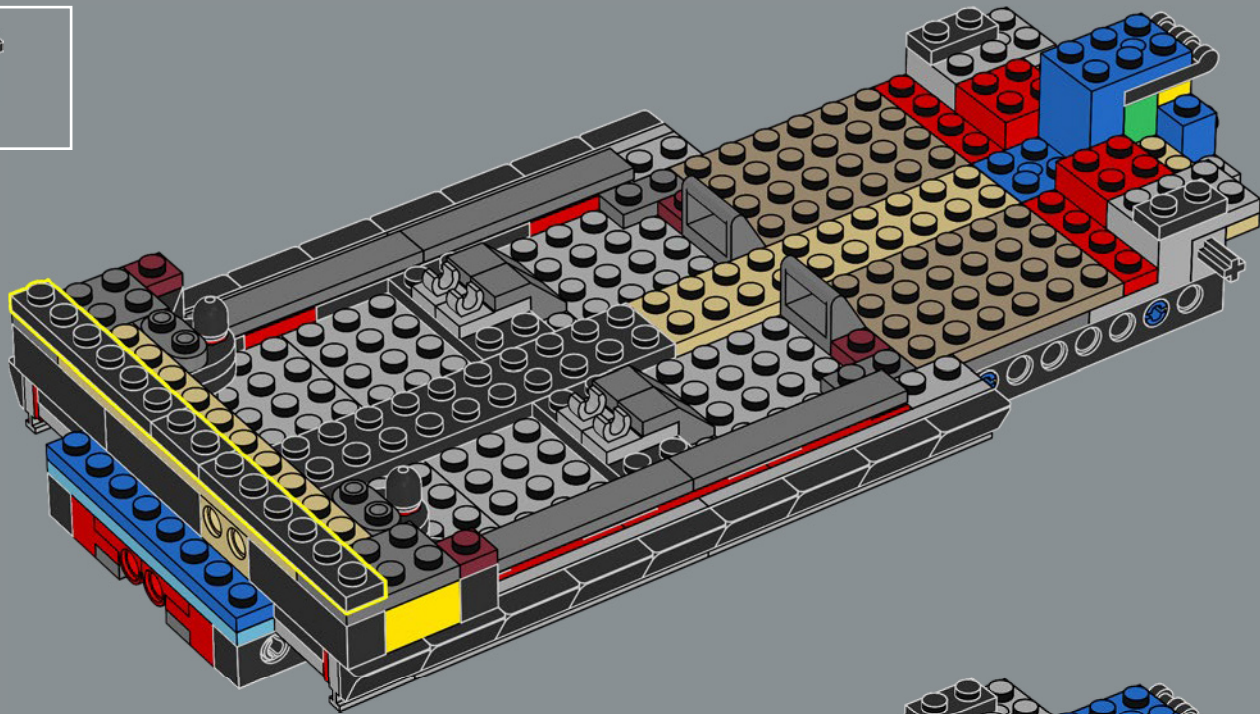

32

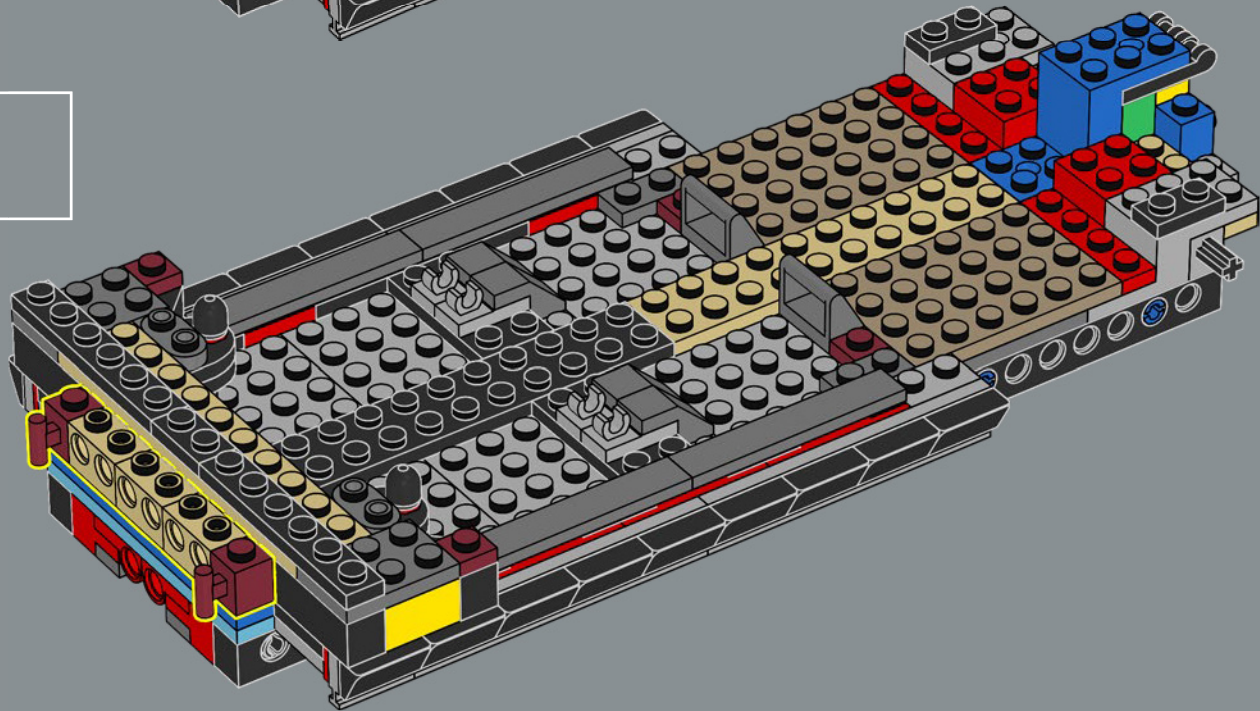

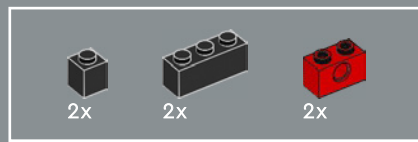

33

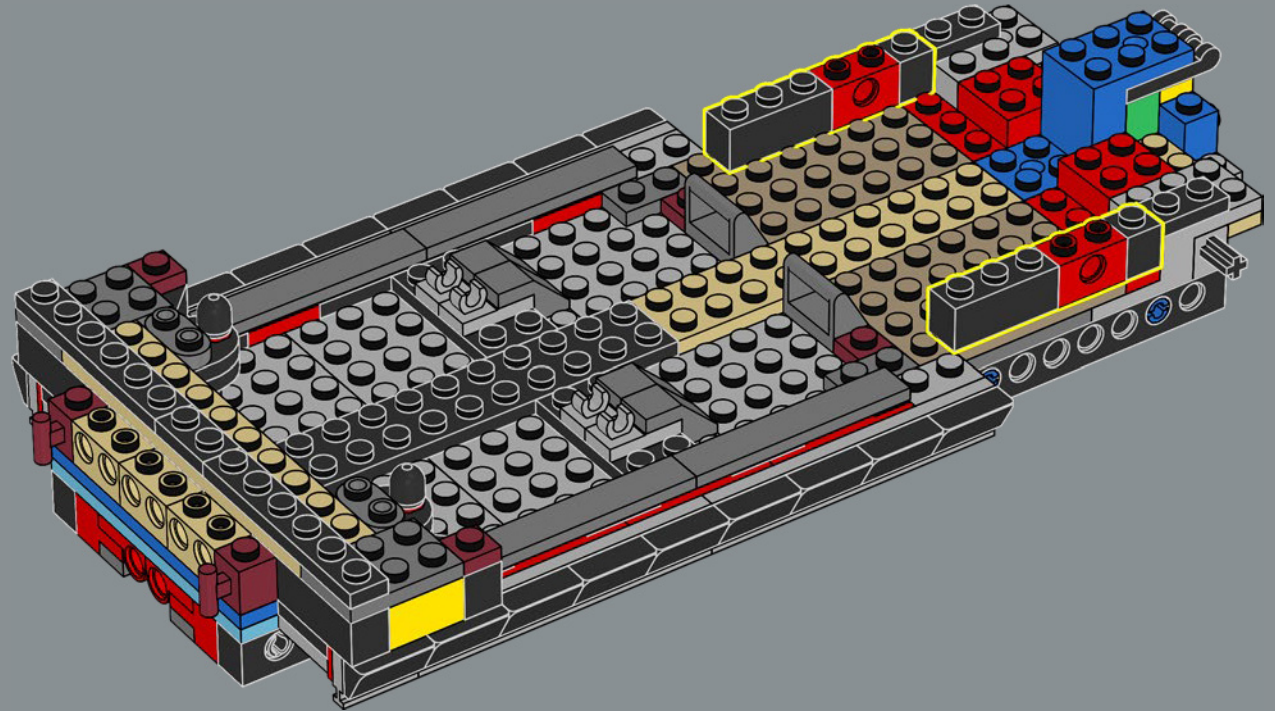

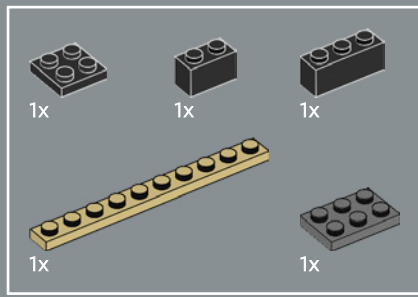

34

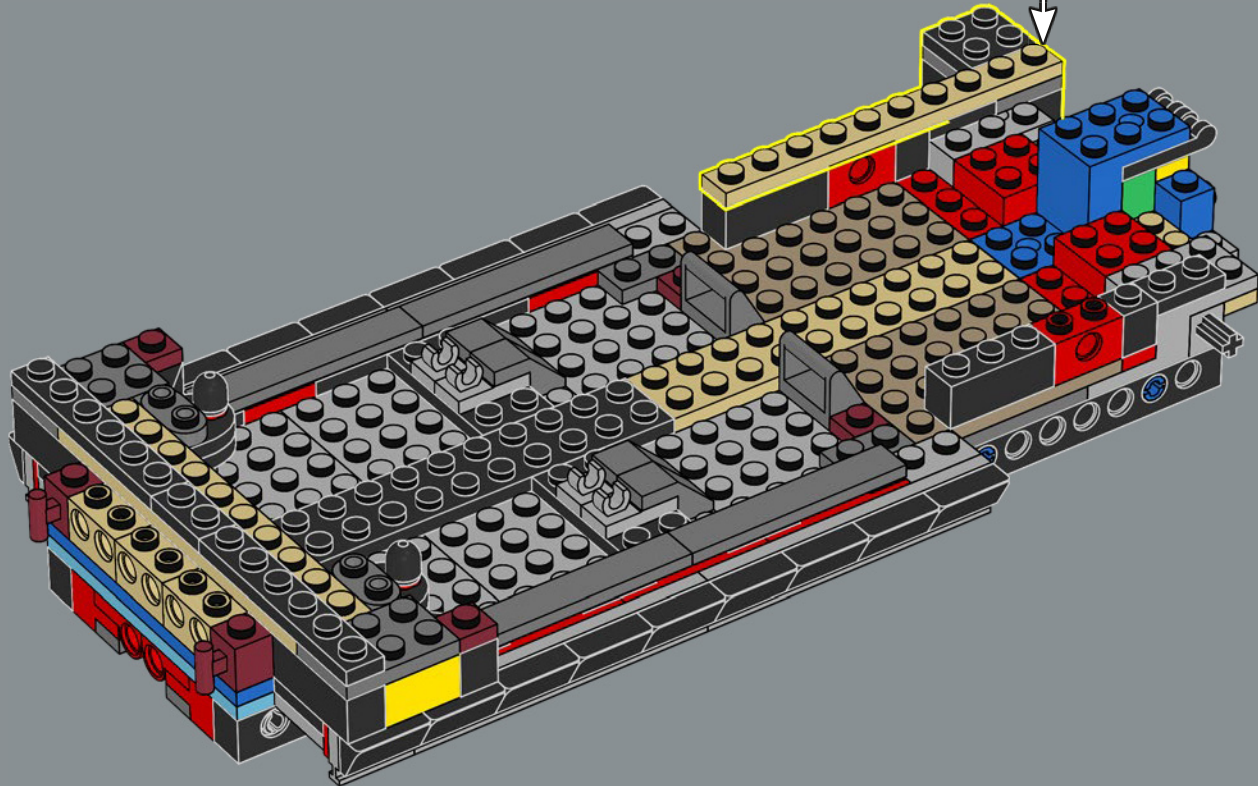
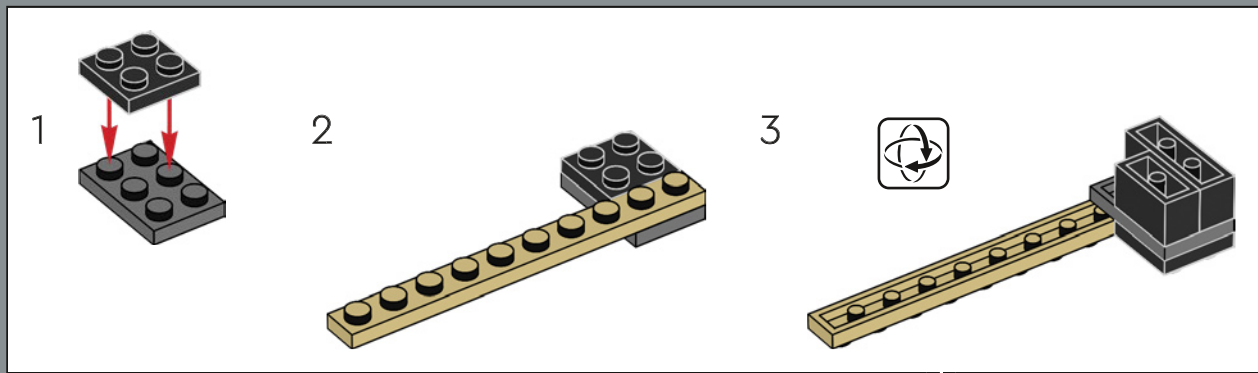

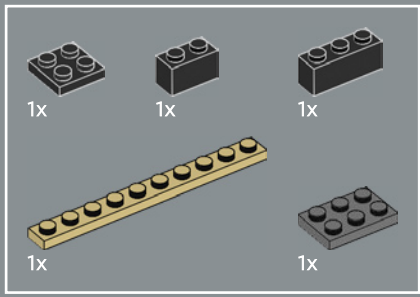

35

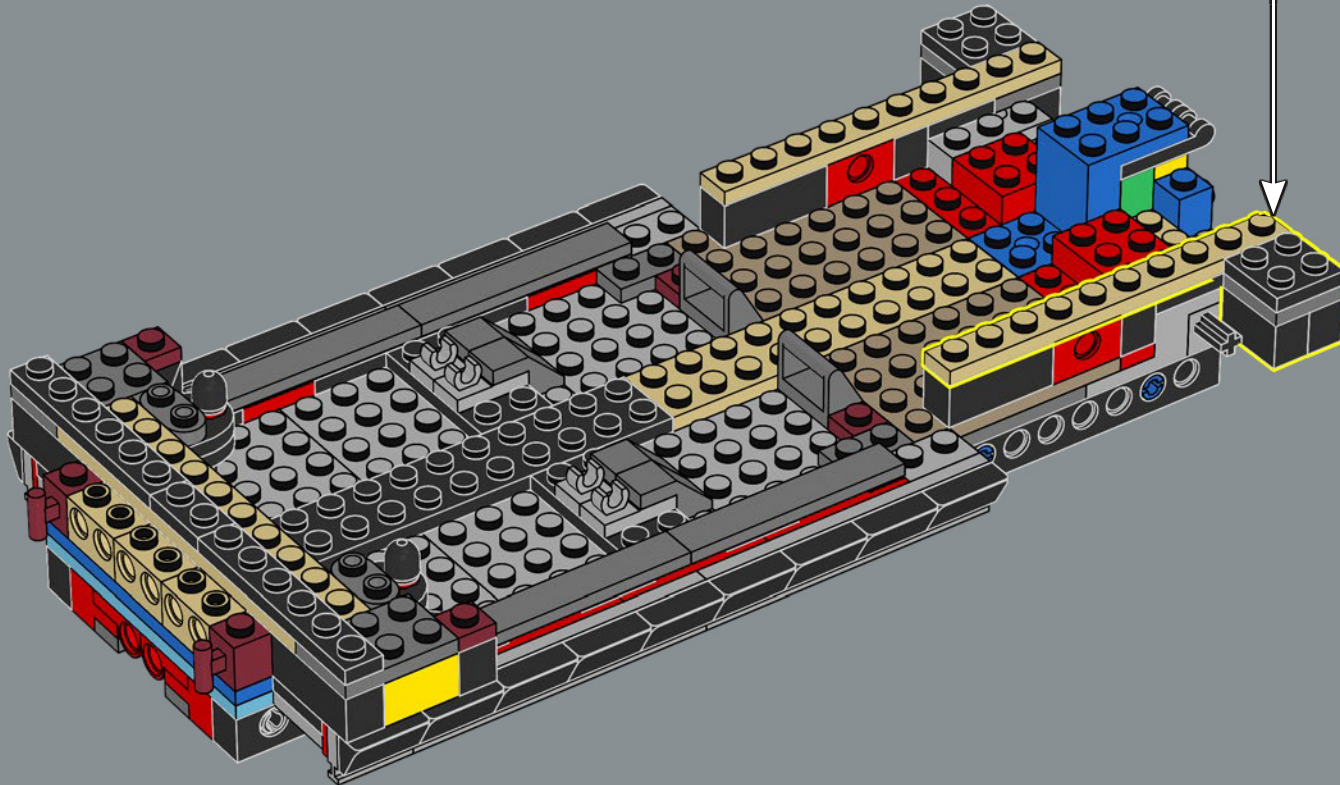
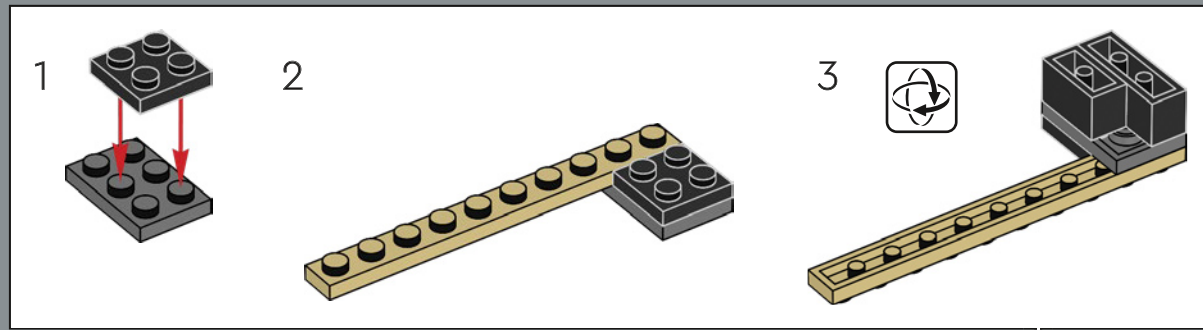



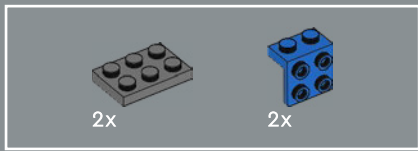

36

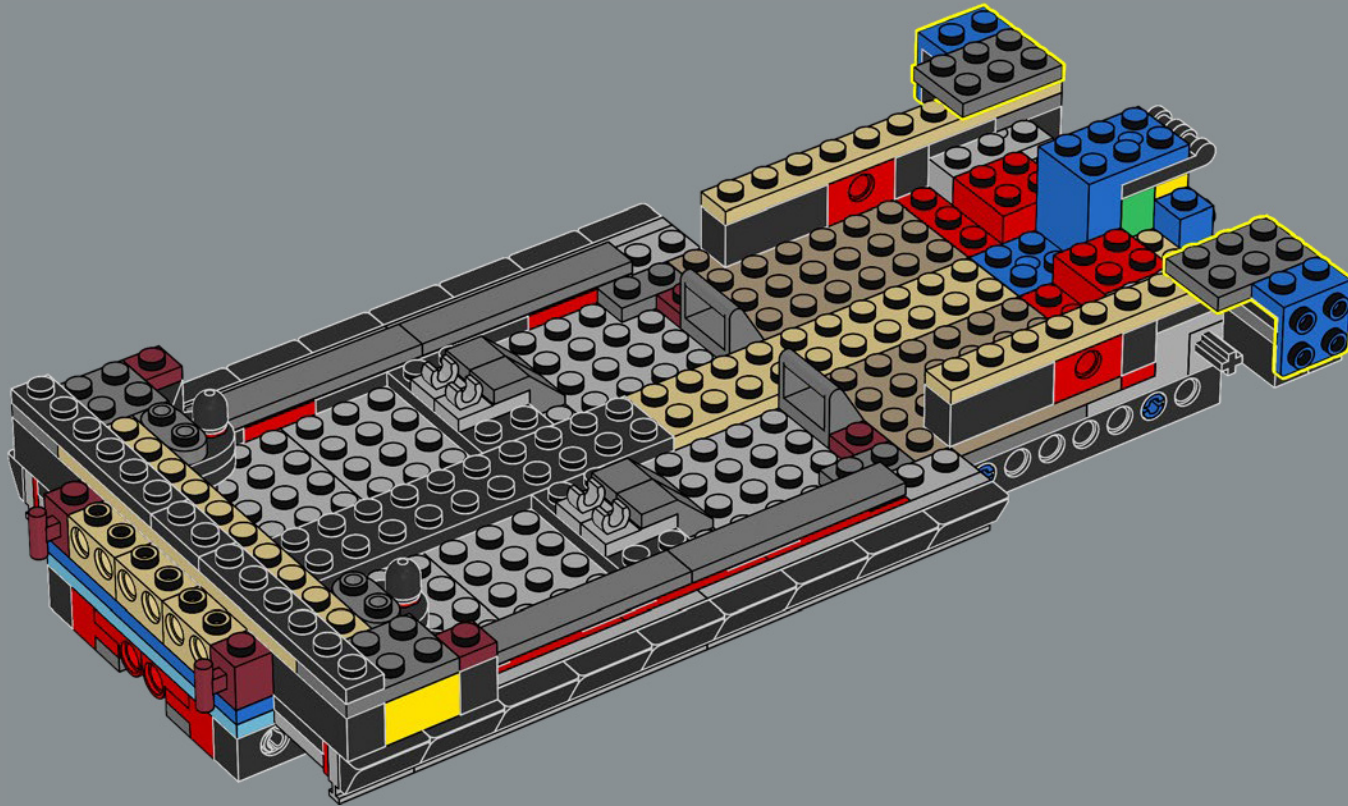

The code-name for the Camaro before it launched was "Panther."

Avant son lancement, la Camaro portait le nom de code « Panther ».

Antes de su lanzamiento, el nombre en clave del Camaro era Panther.

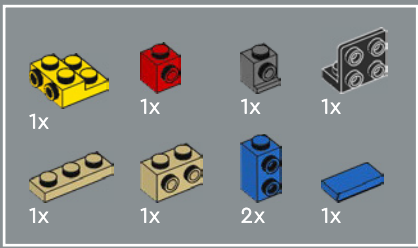

37

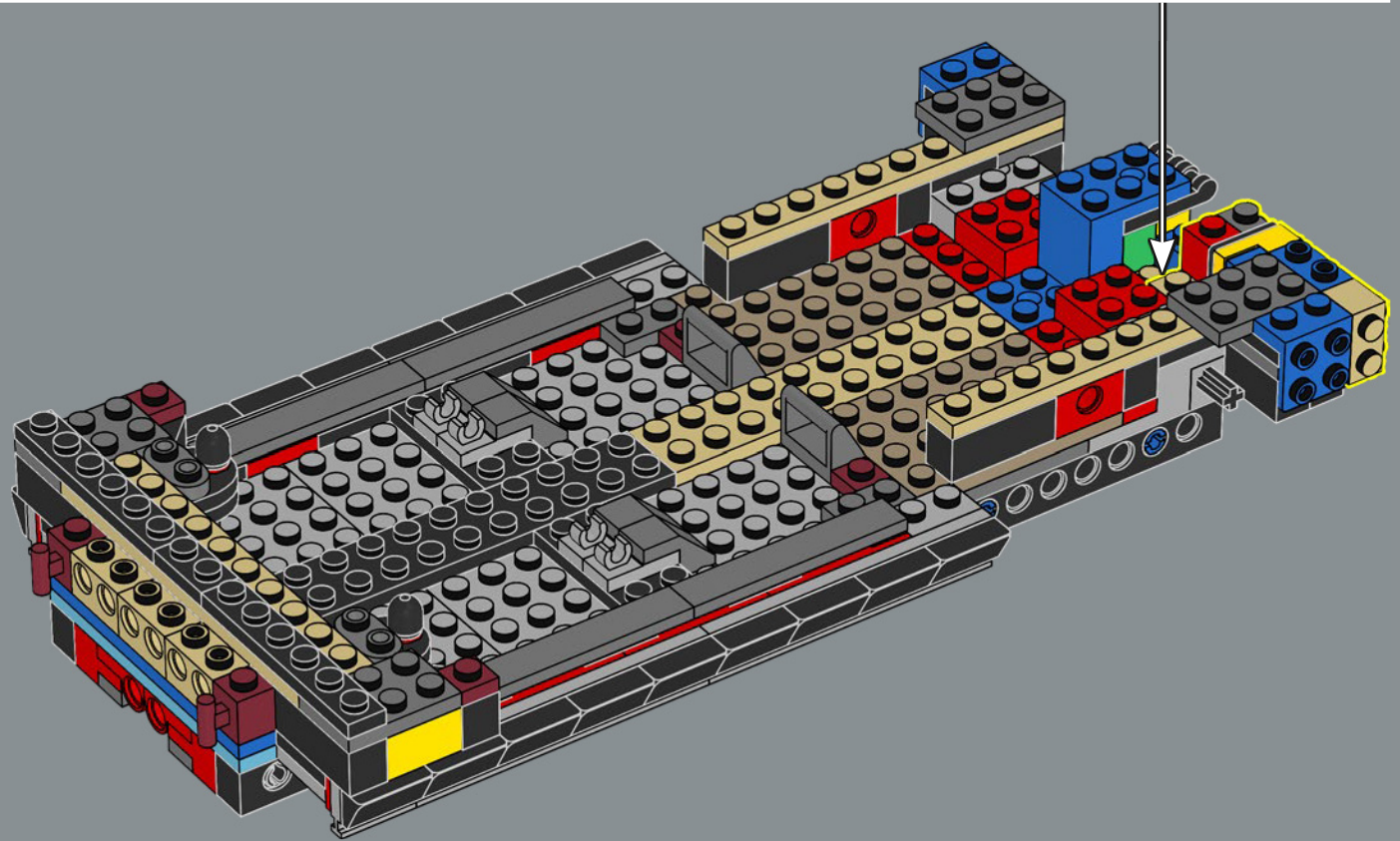
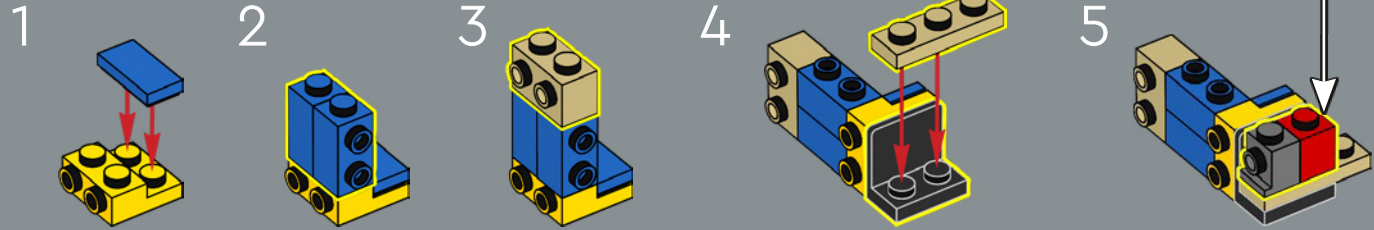

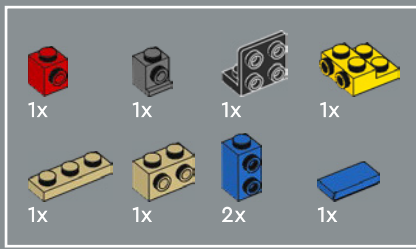

38

1

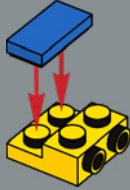

2

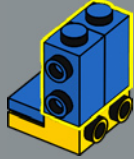

3



4

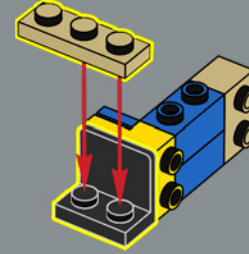

5

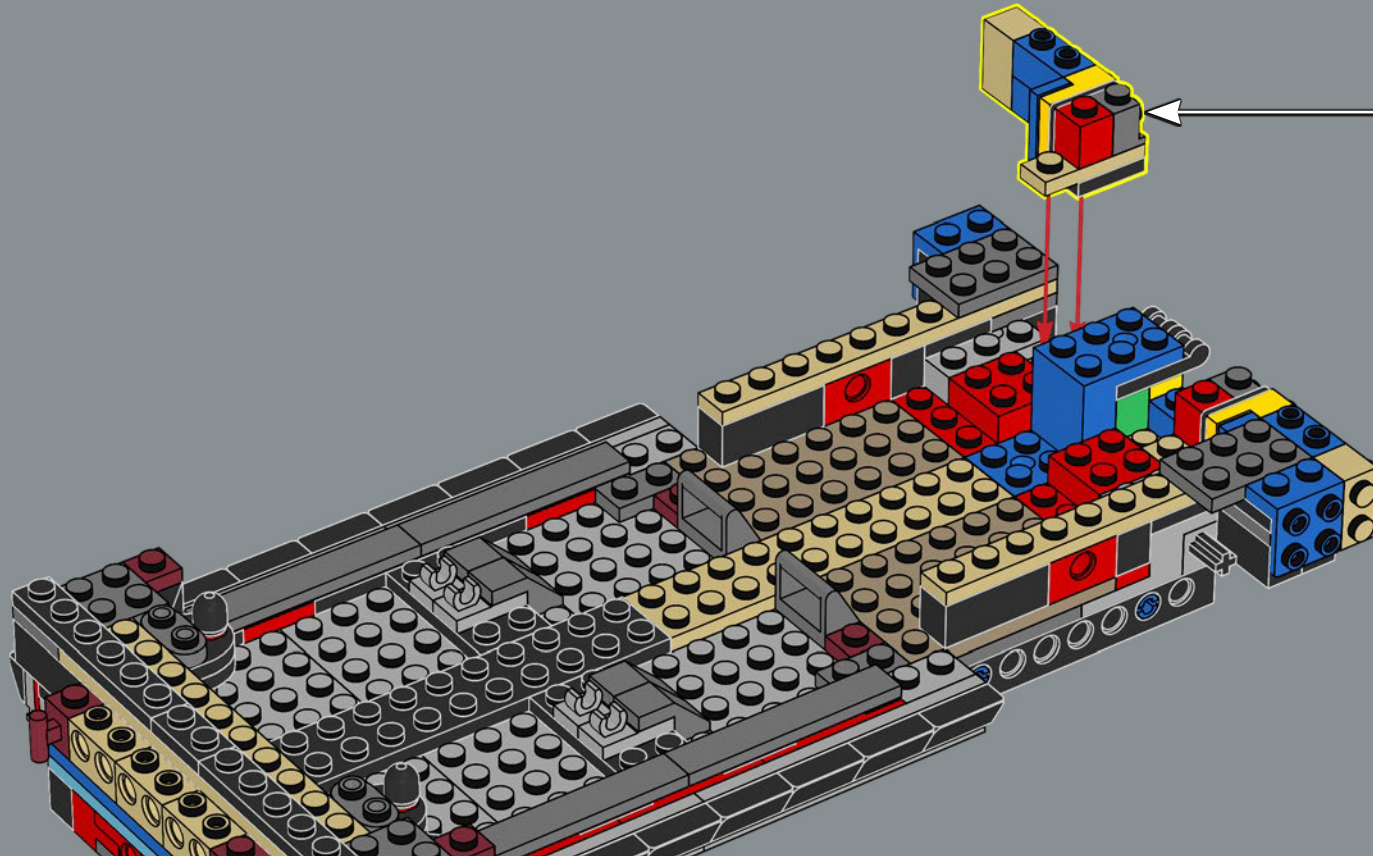
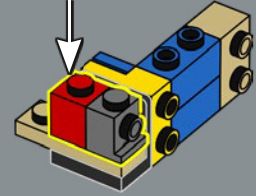
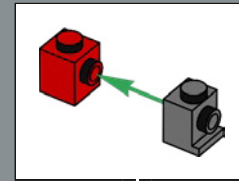

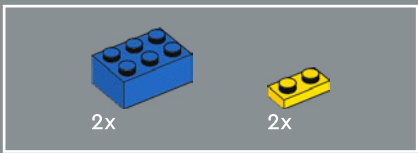

39

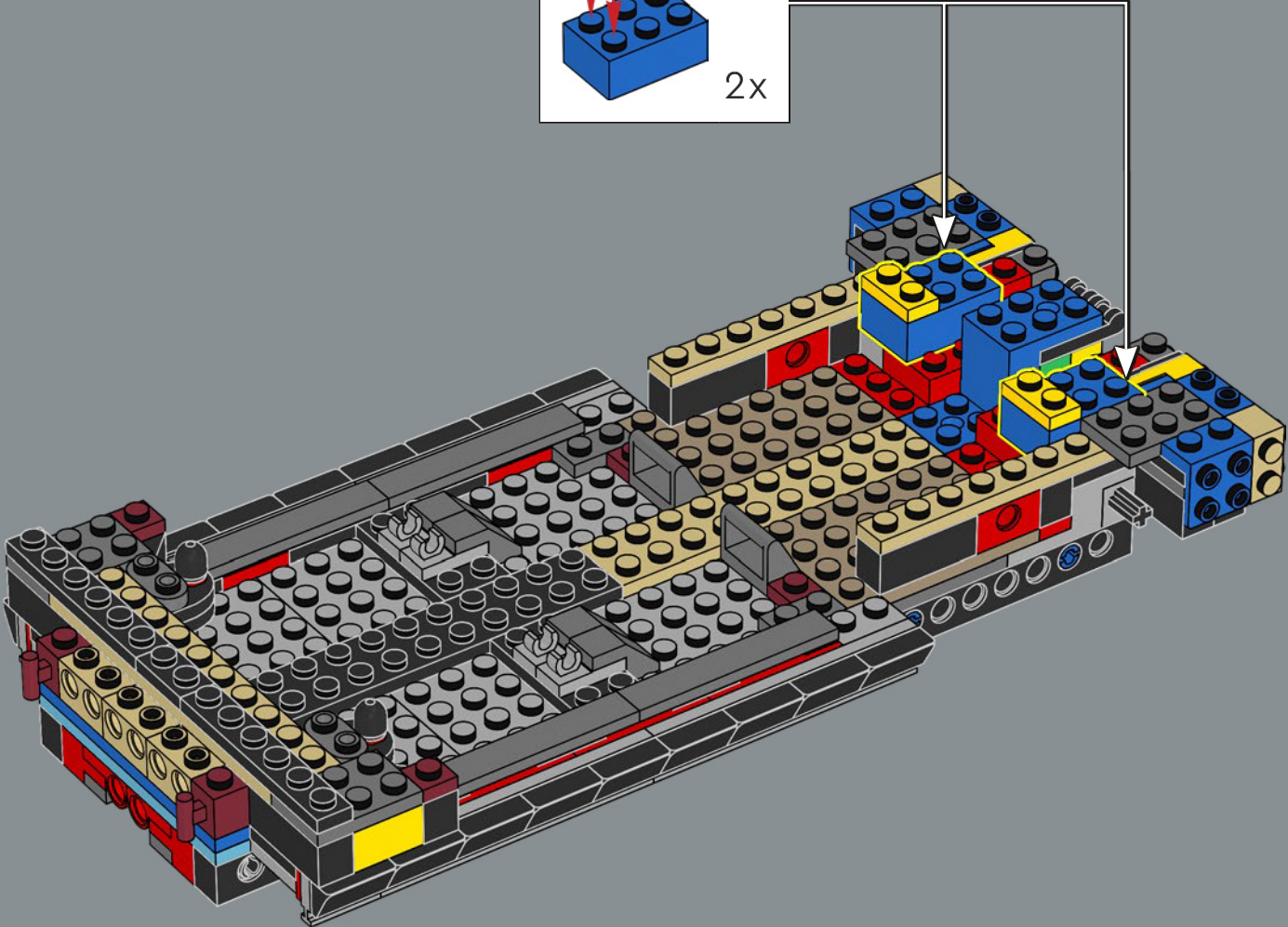
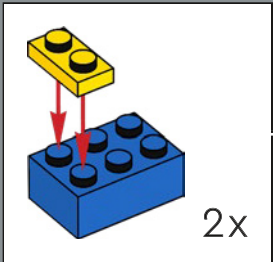

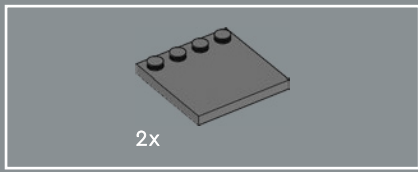

40

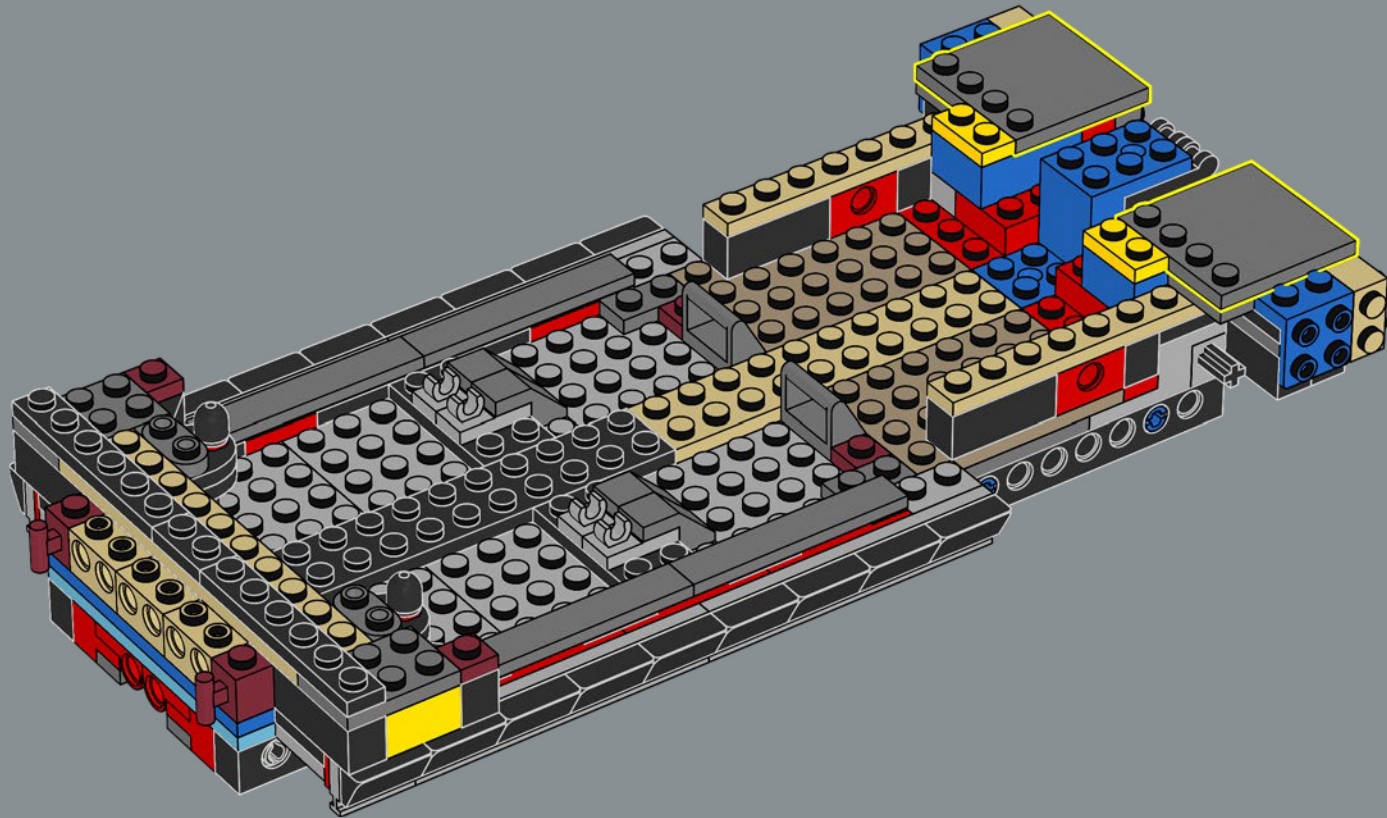



41

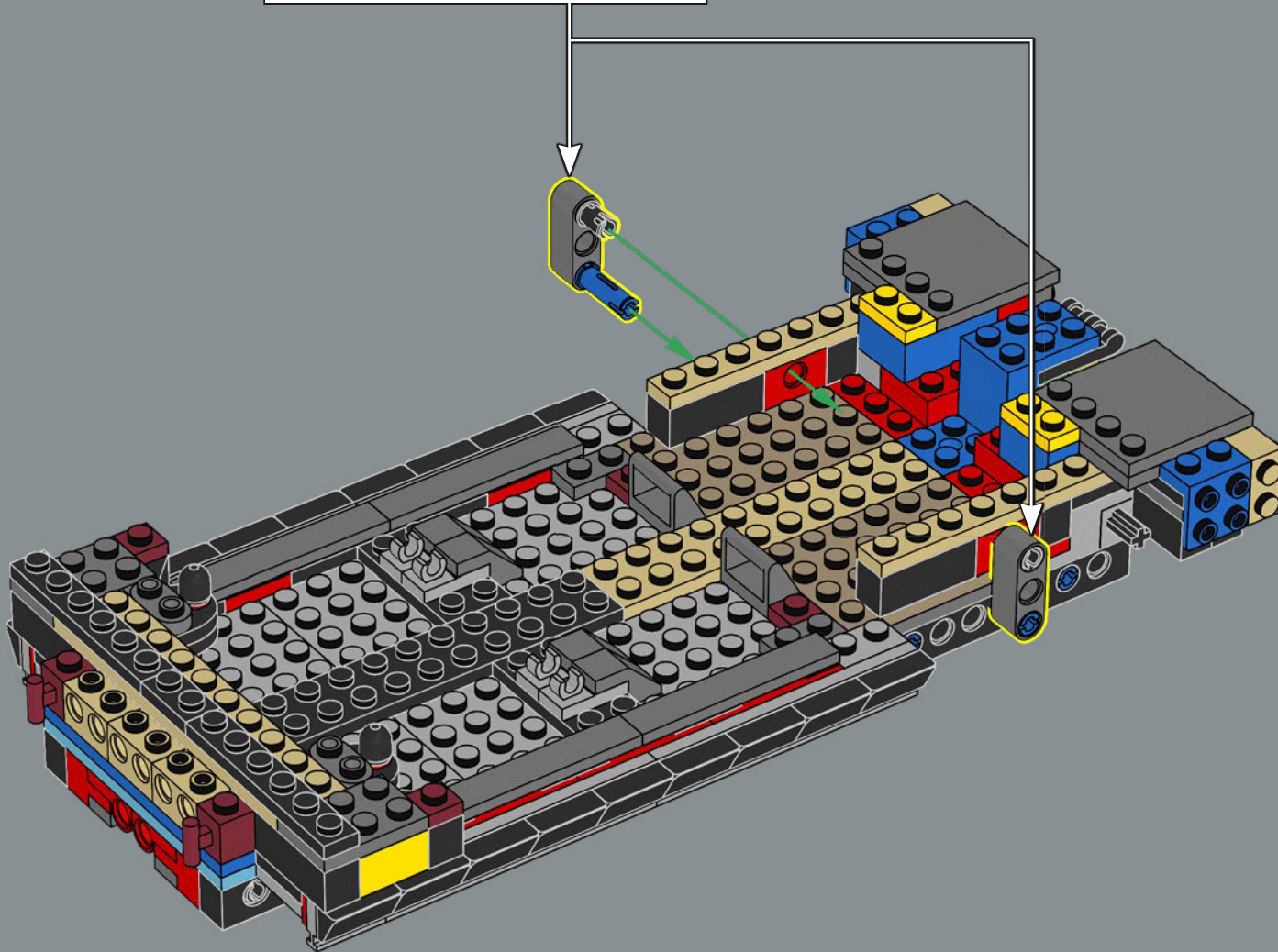
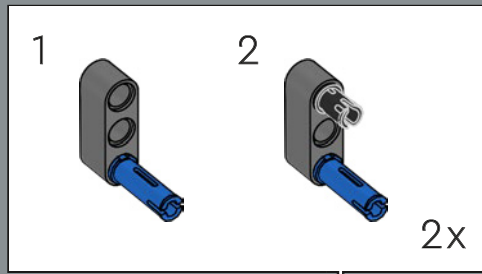

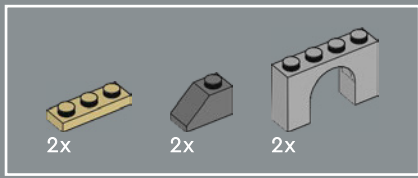

42

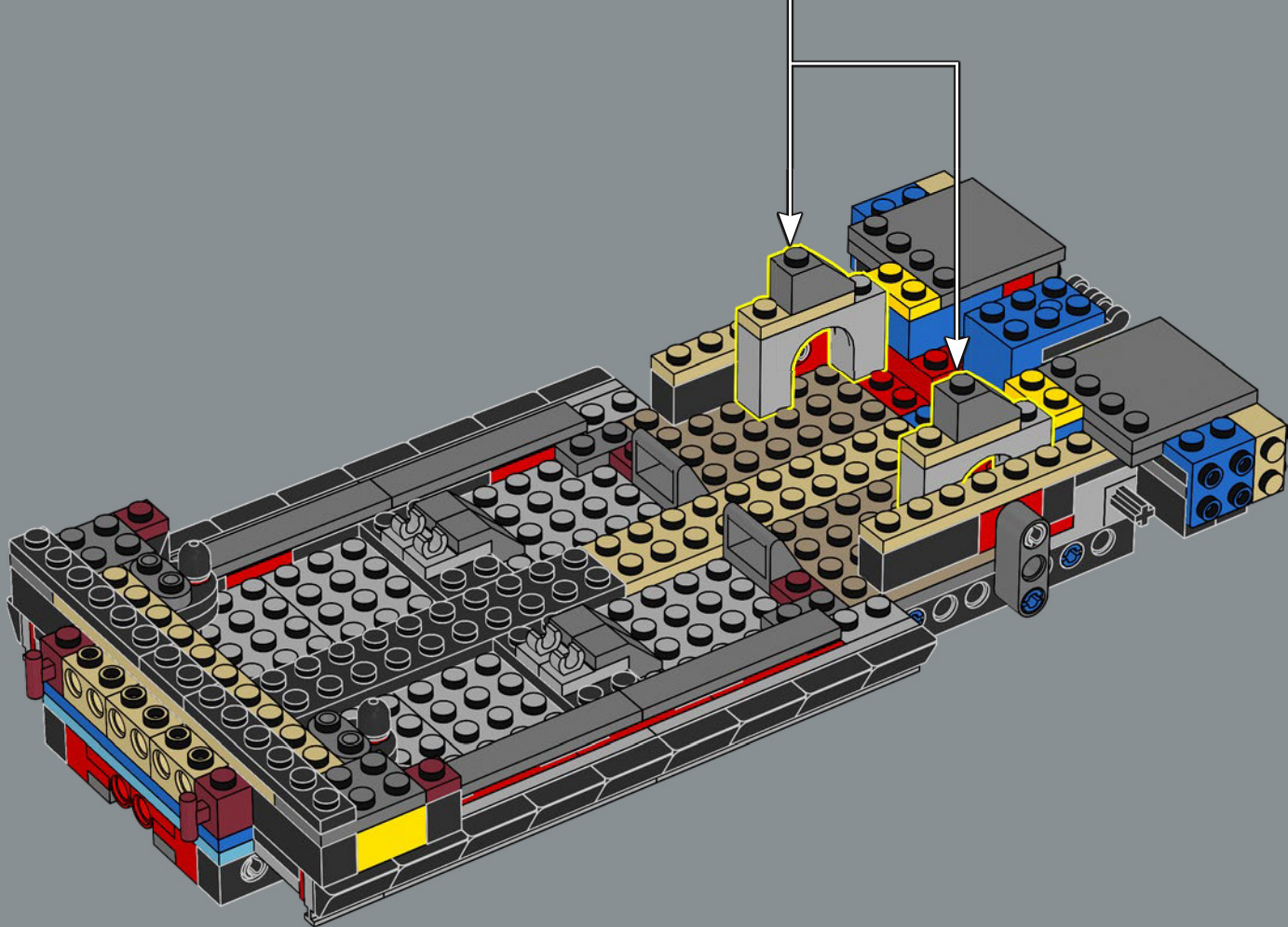
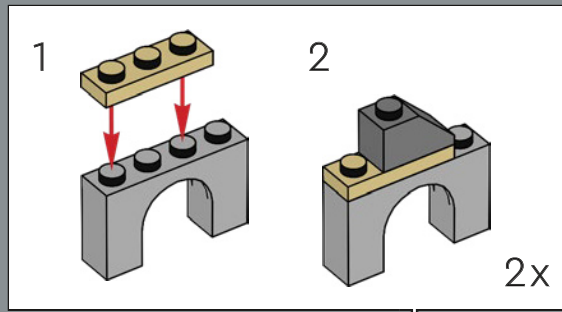

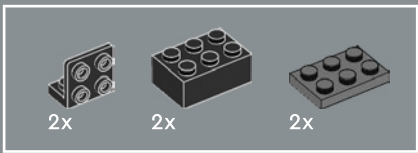

43

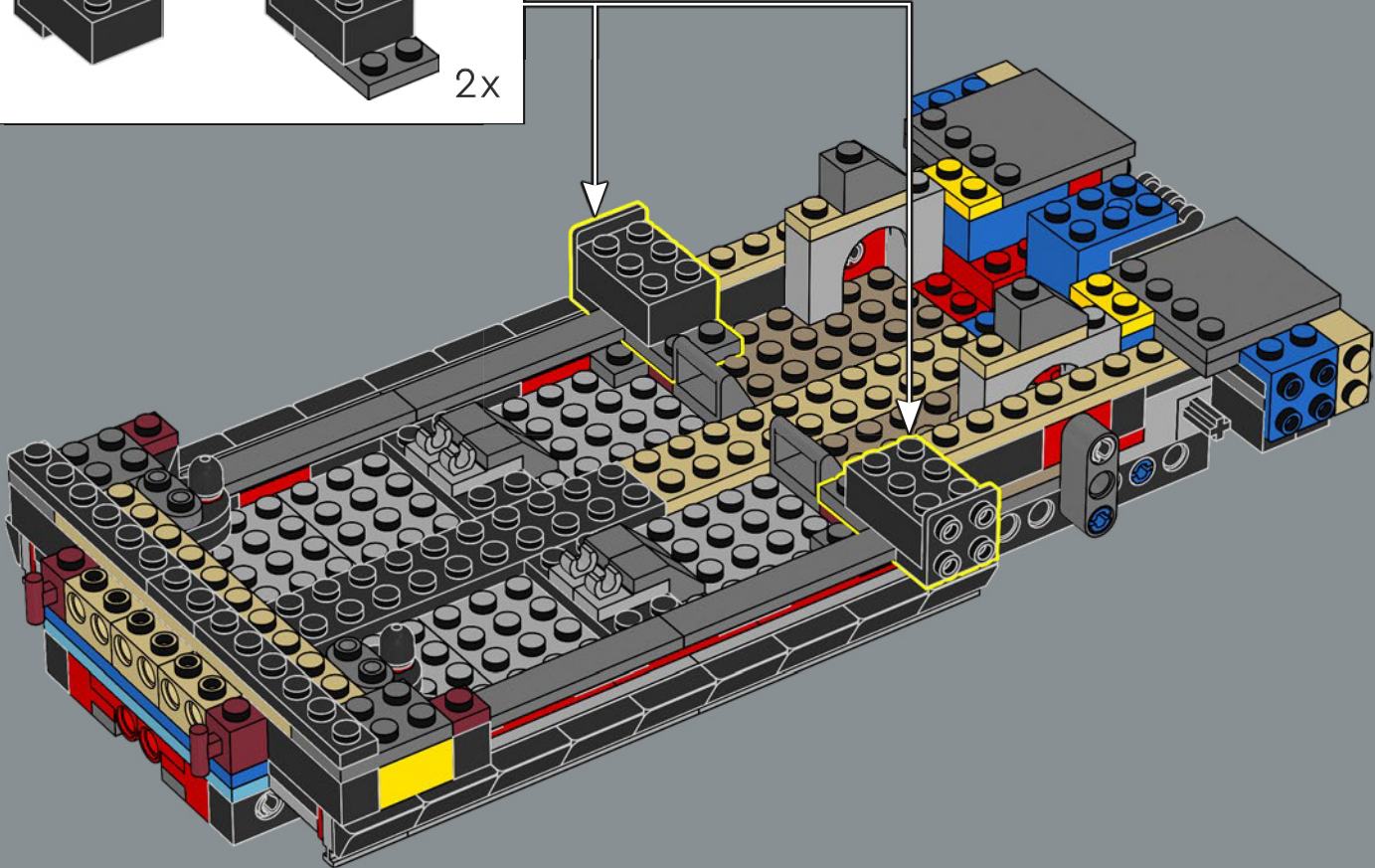
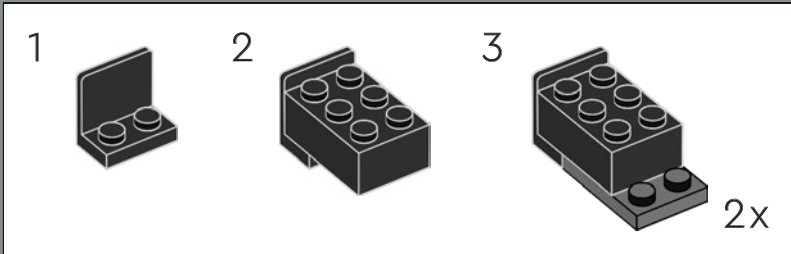



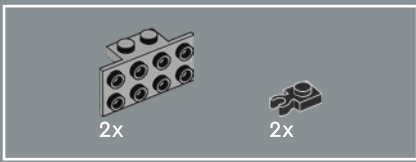

44

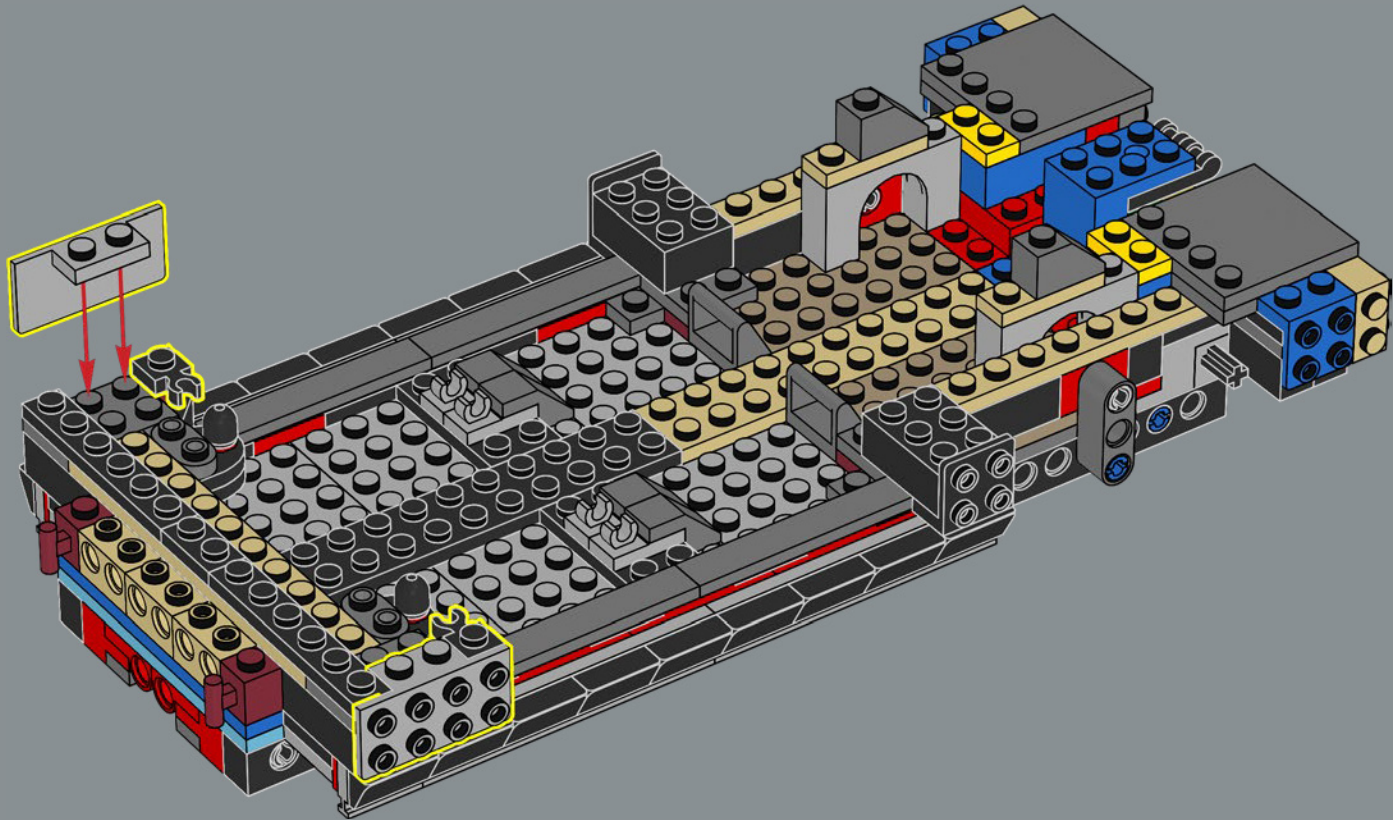

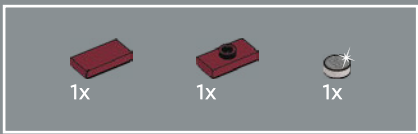

45

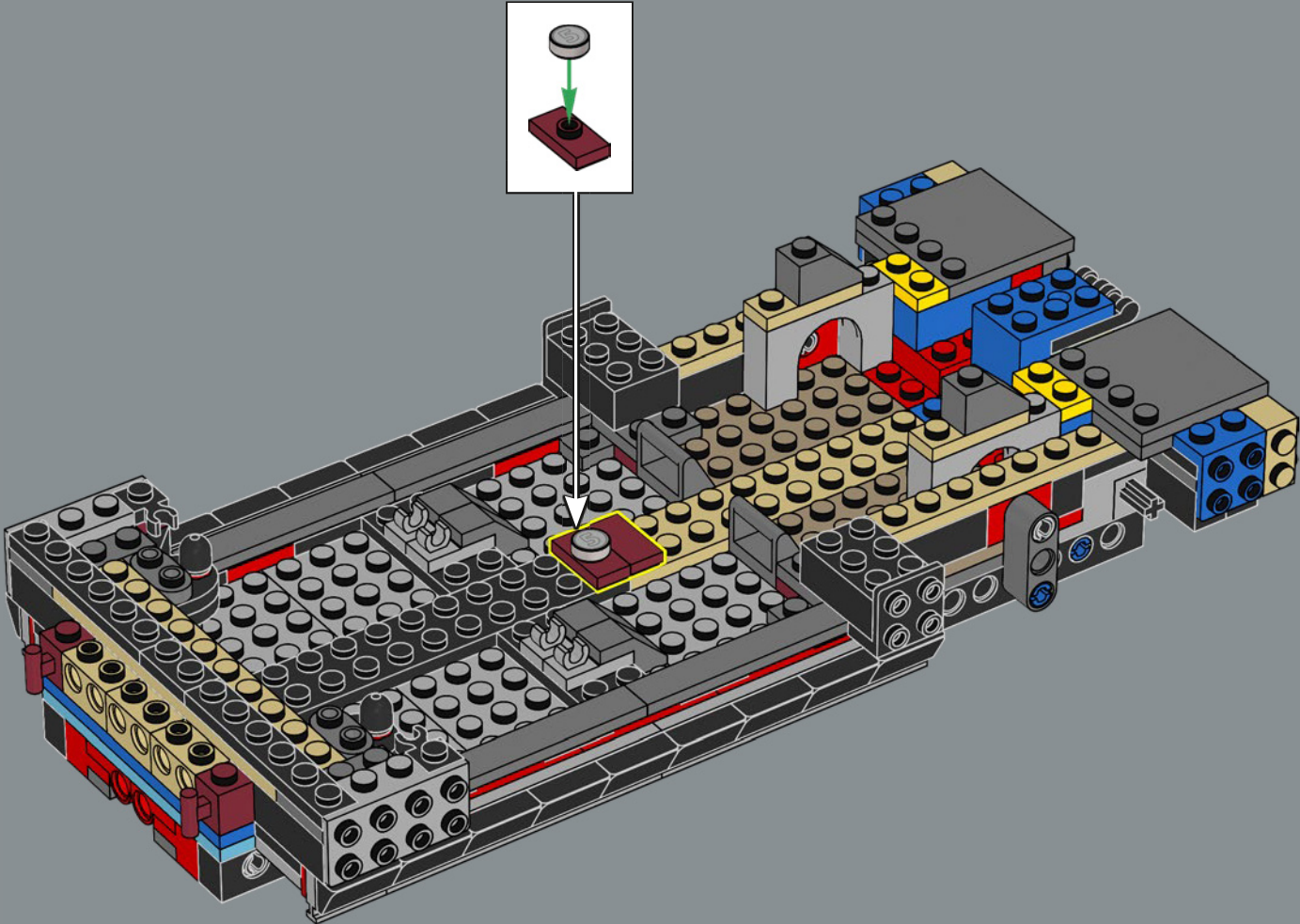

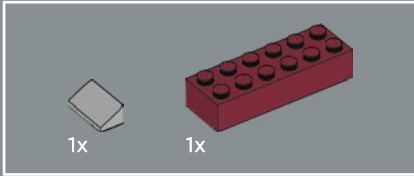
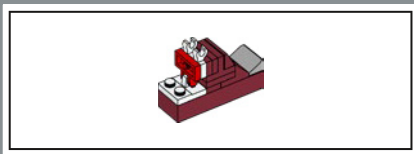

46

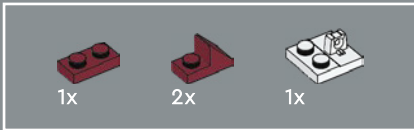
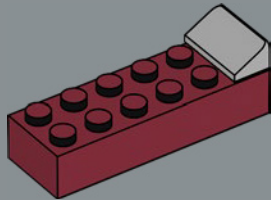

47

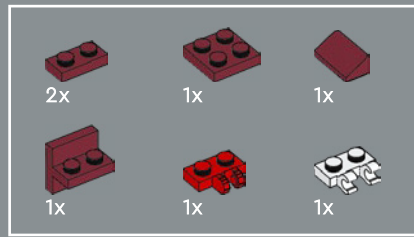
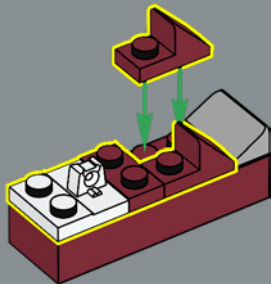

48

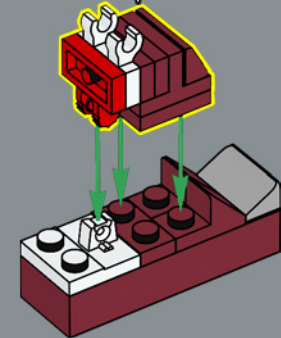
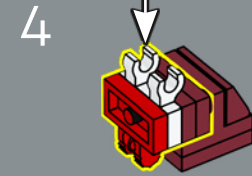
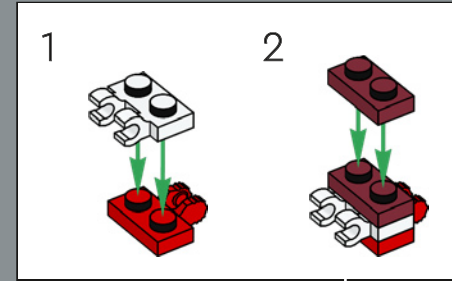
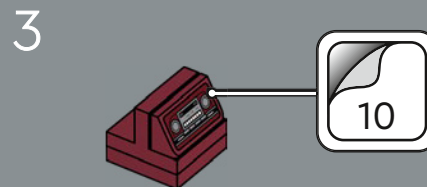
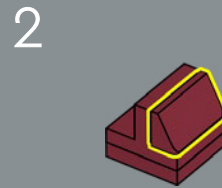
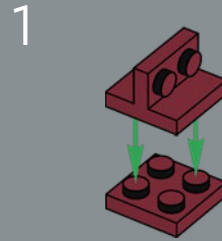

The first pilot prototype Camaro ever built, Chassis no. 10001 still exists and is listed in the National Historic Vehicle Register.

Le premier prototype pilote de Camaro jamais construit, le châssis no 10001, existe toujours et est inscrit au registre national des véhicules historiques.

El primer prototipo del Camaro que se construyó, con número de chasis 10001, existe todavía y está inscrito en el Registro Nacional de Vehículos Históricos de los EE. UU.

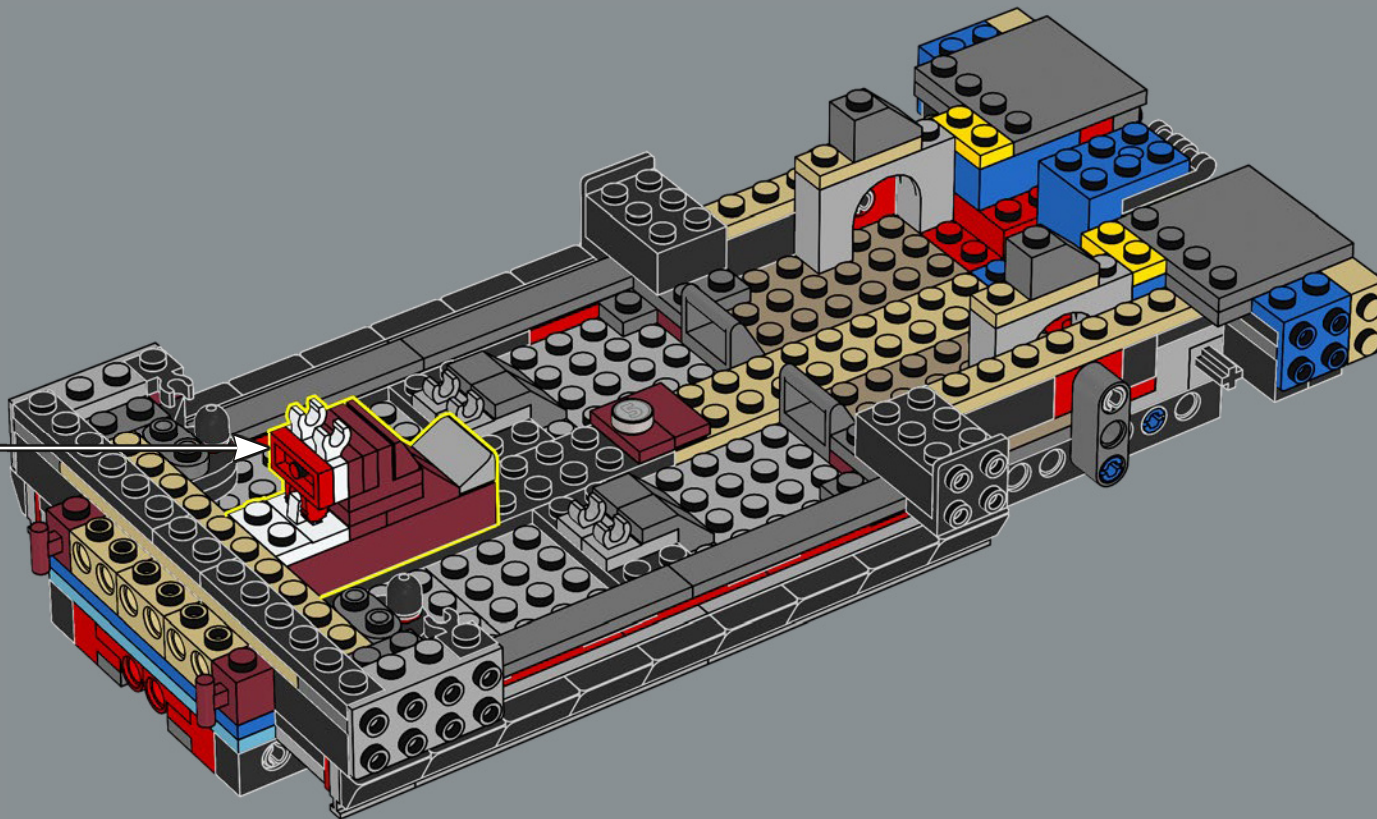

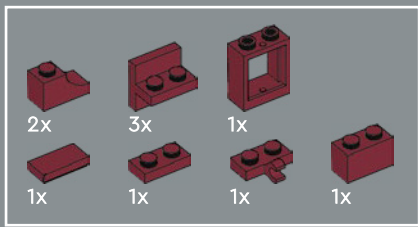

50

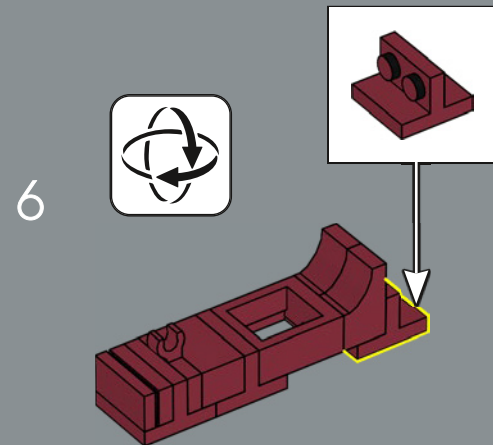
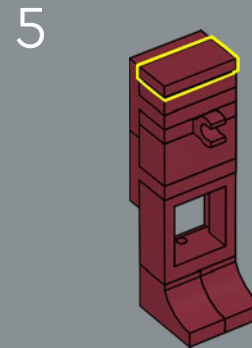
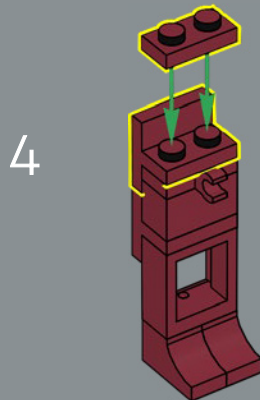
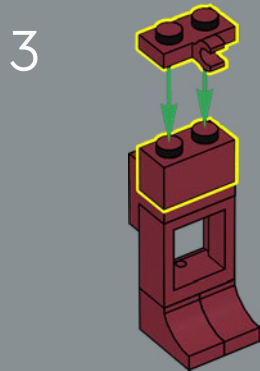
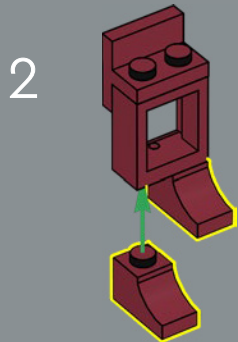
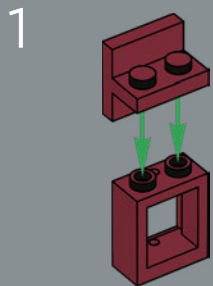

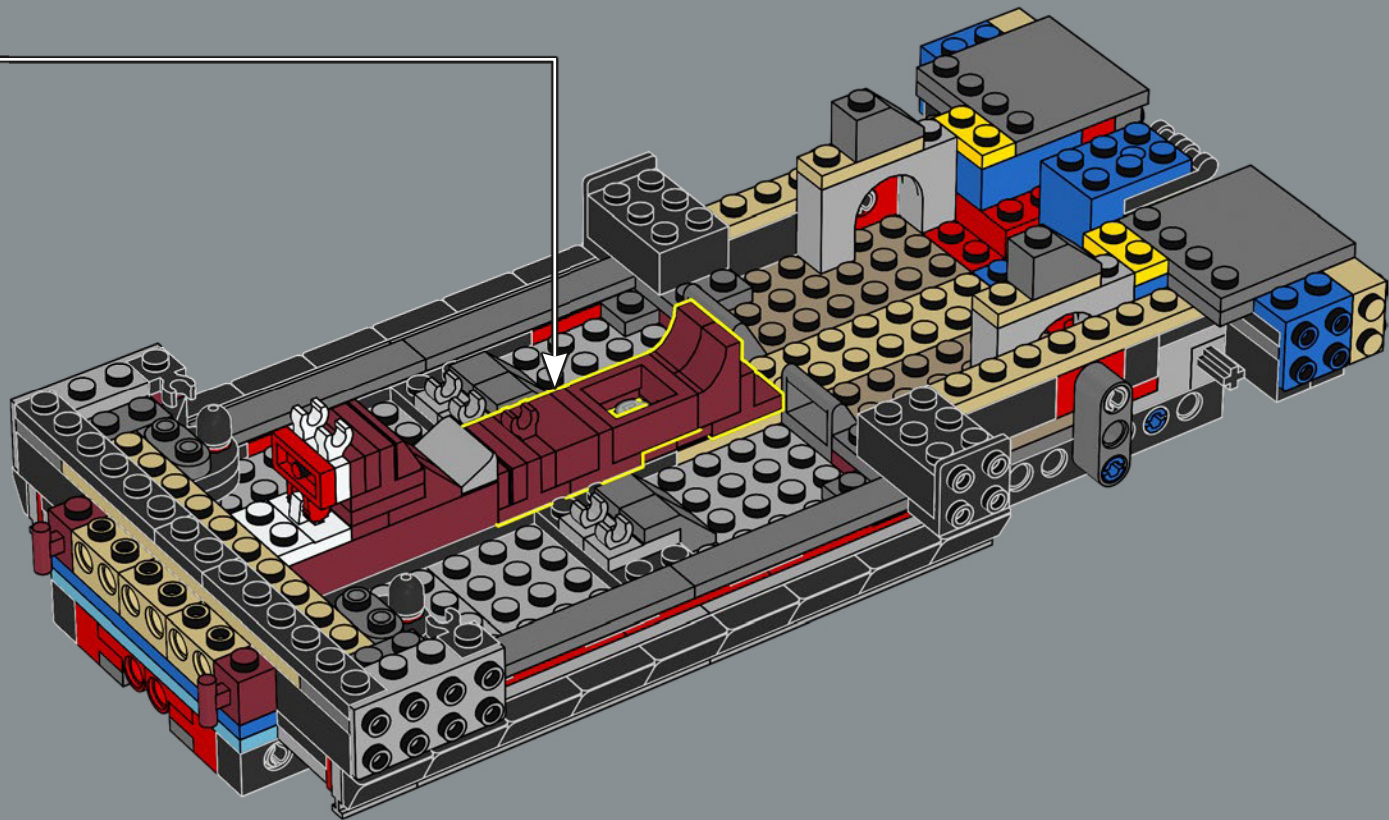

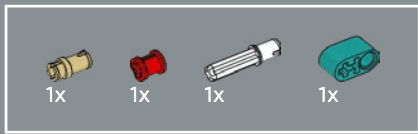

51

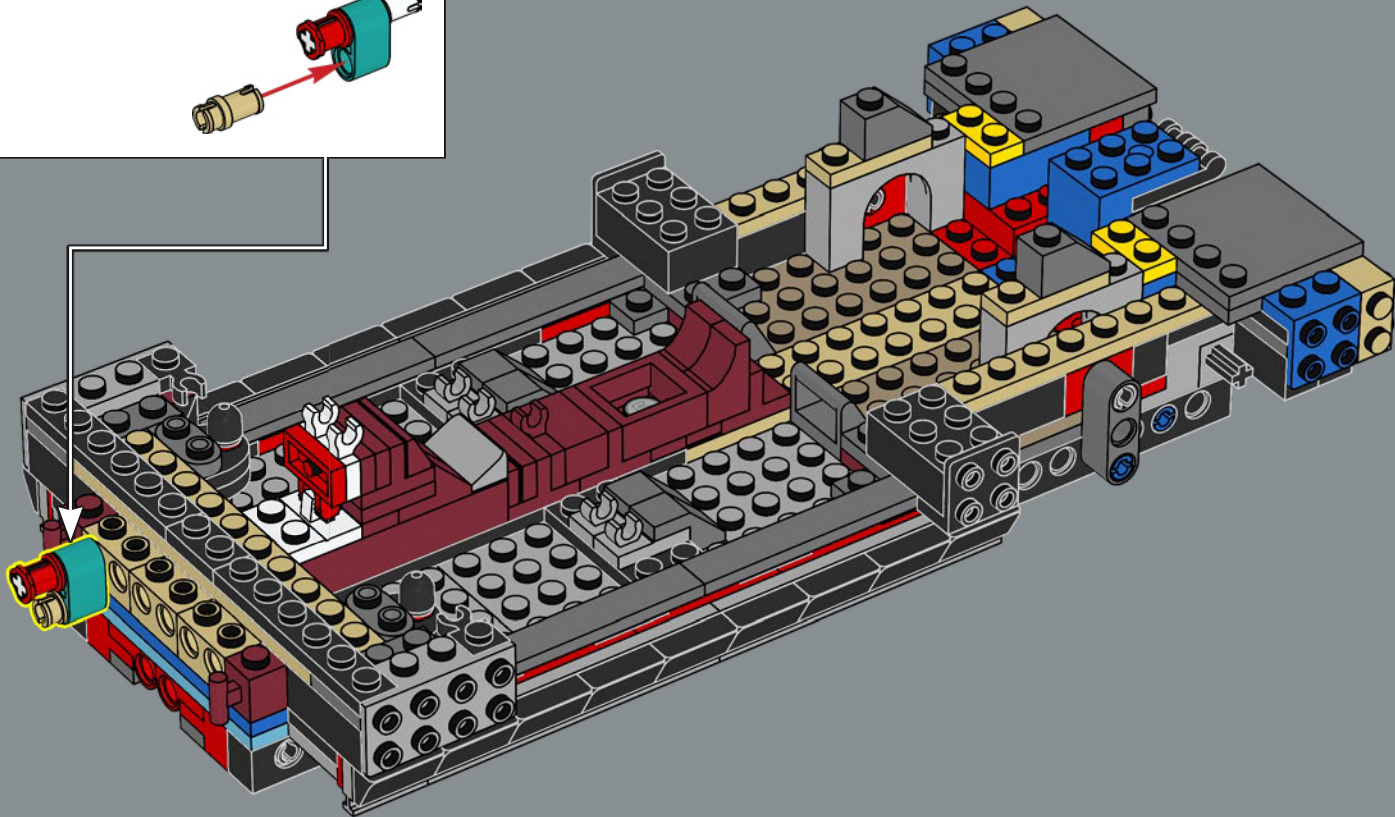
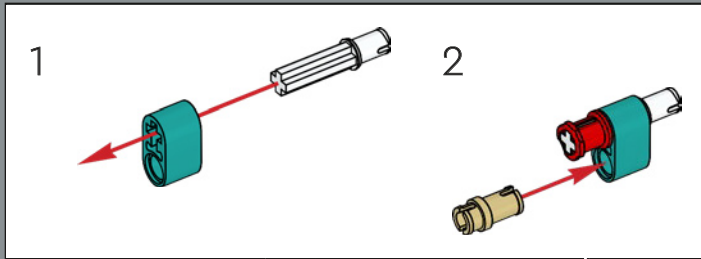

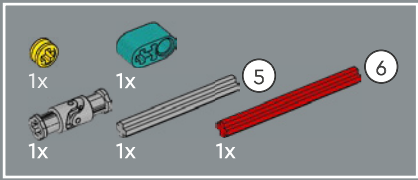

52

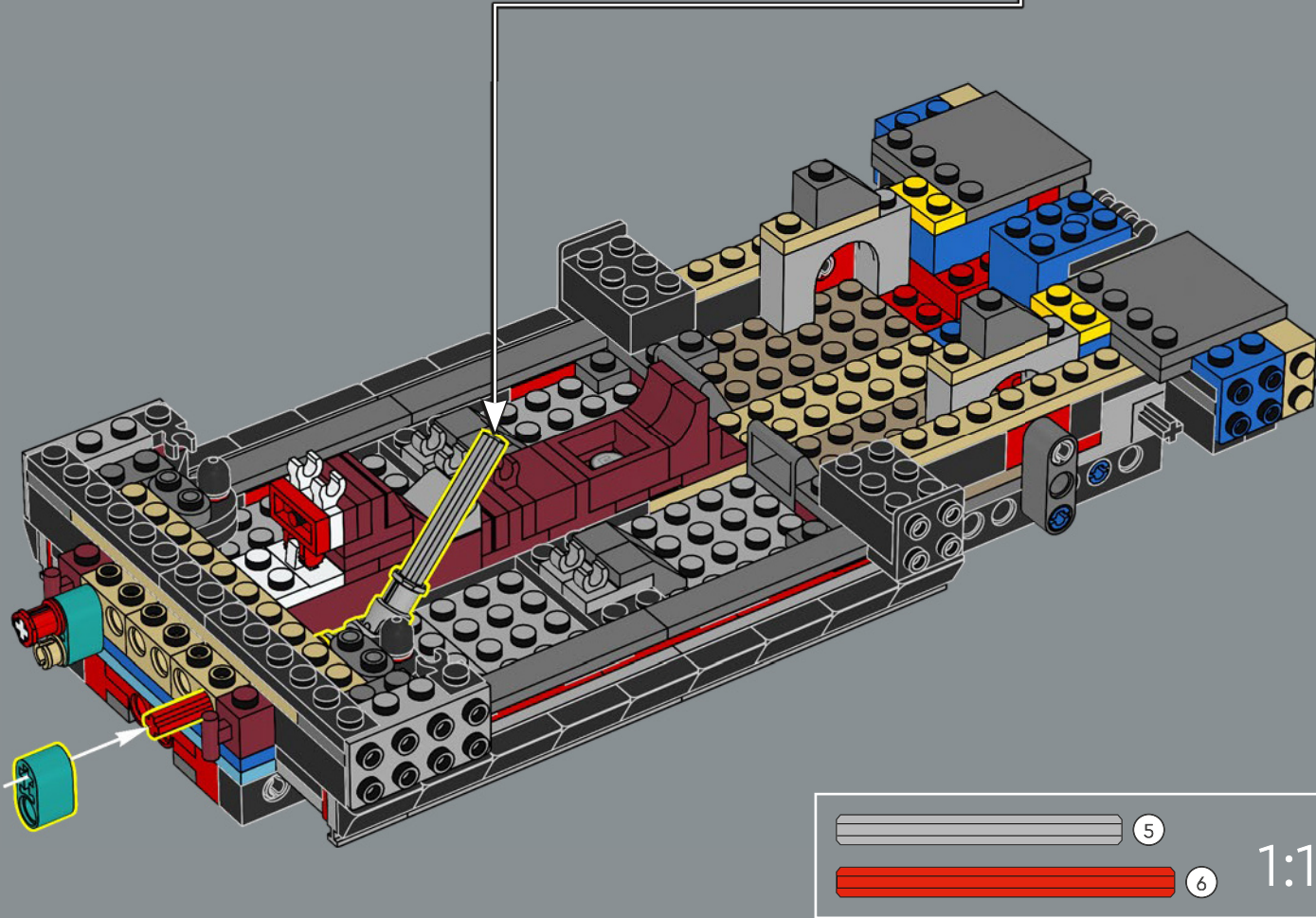
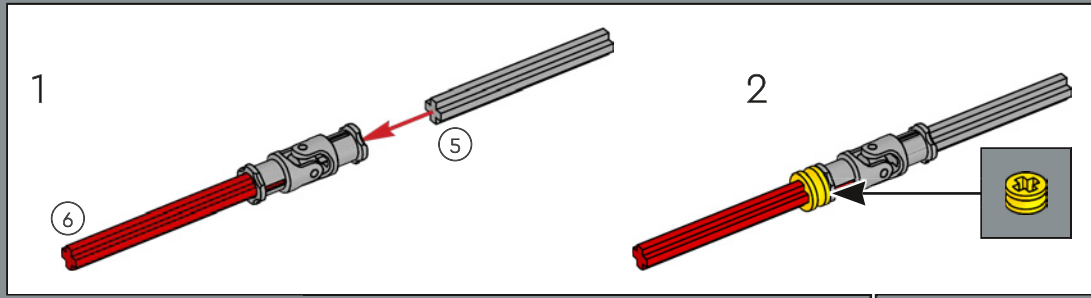





53

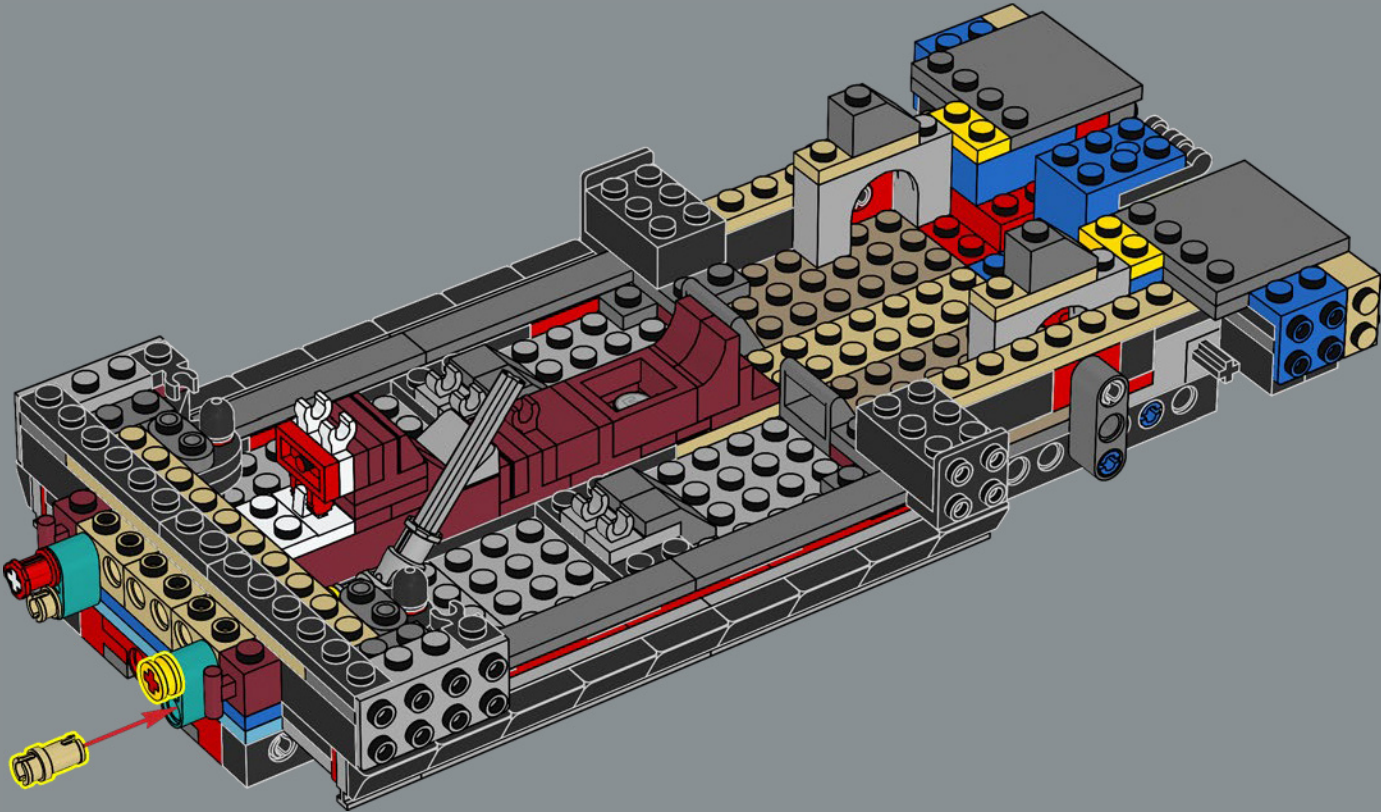

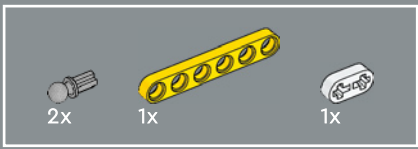

54

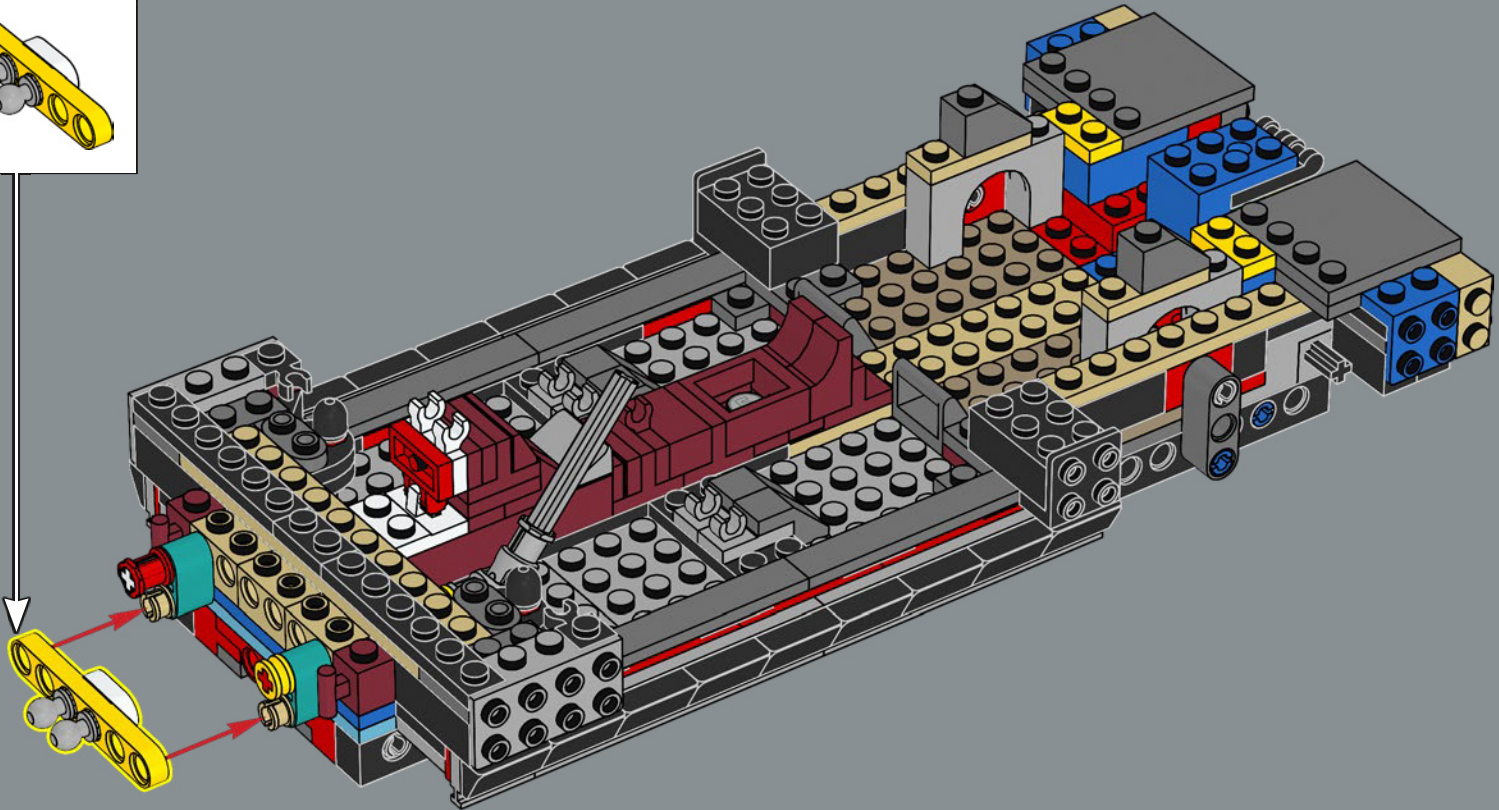
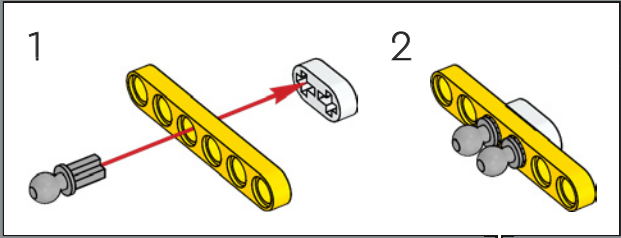

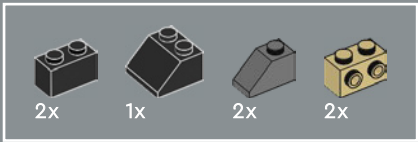

55

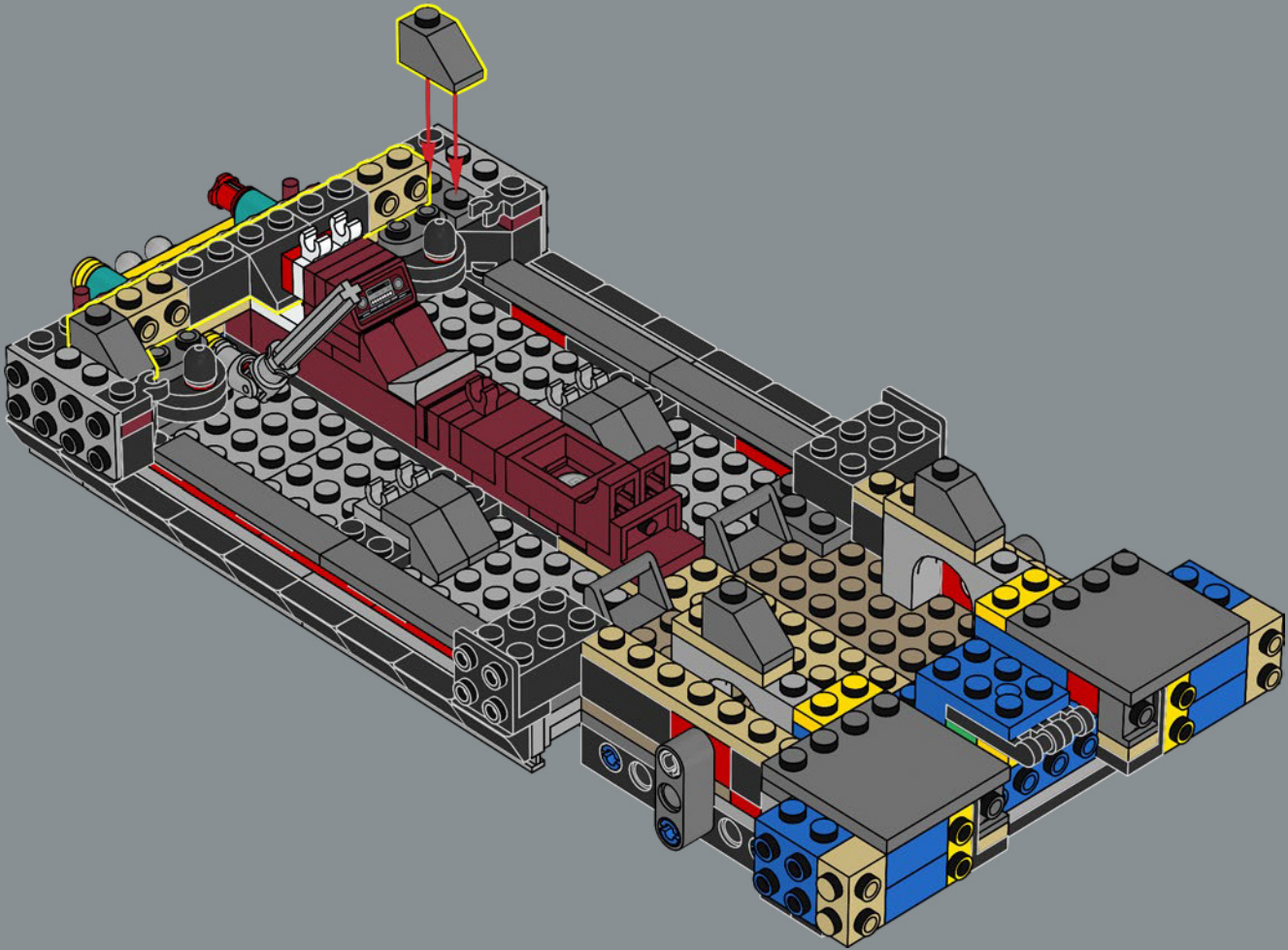

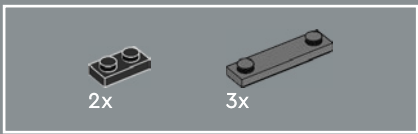

56

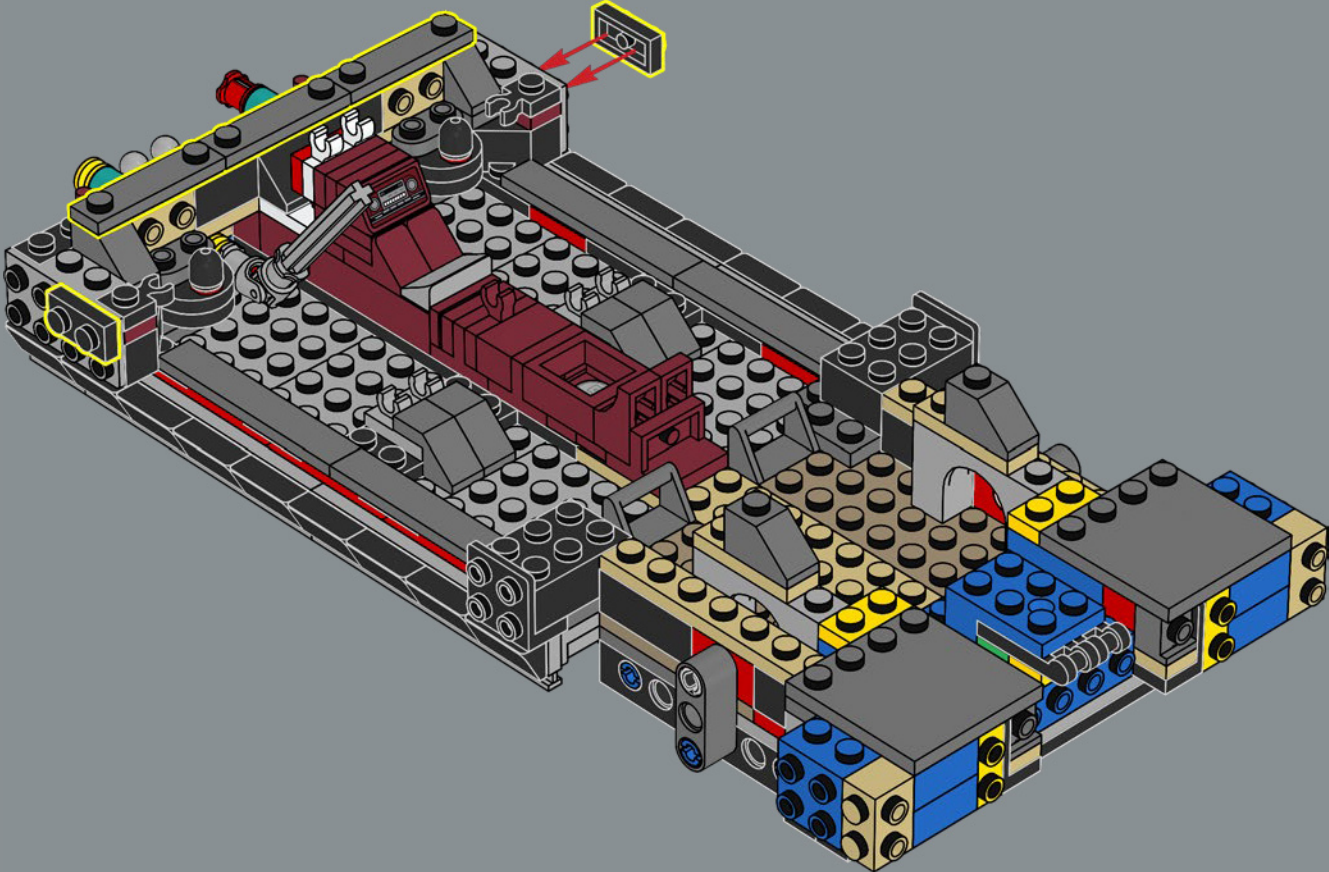

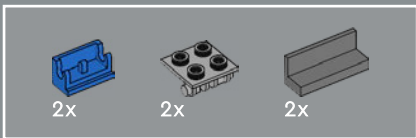

57

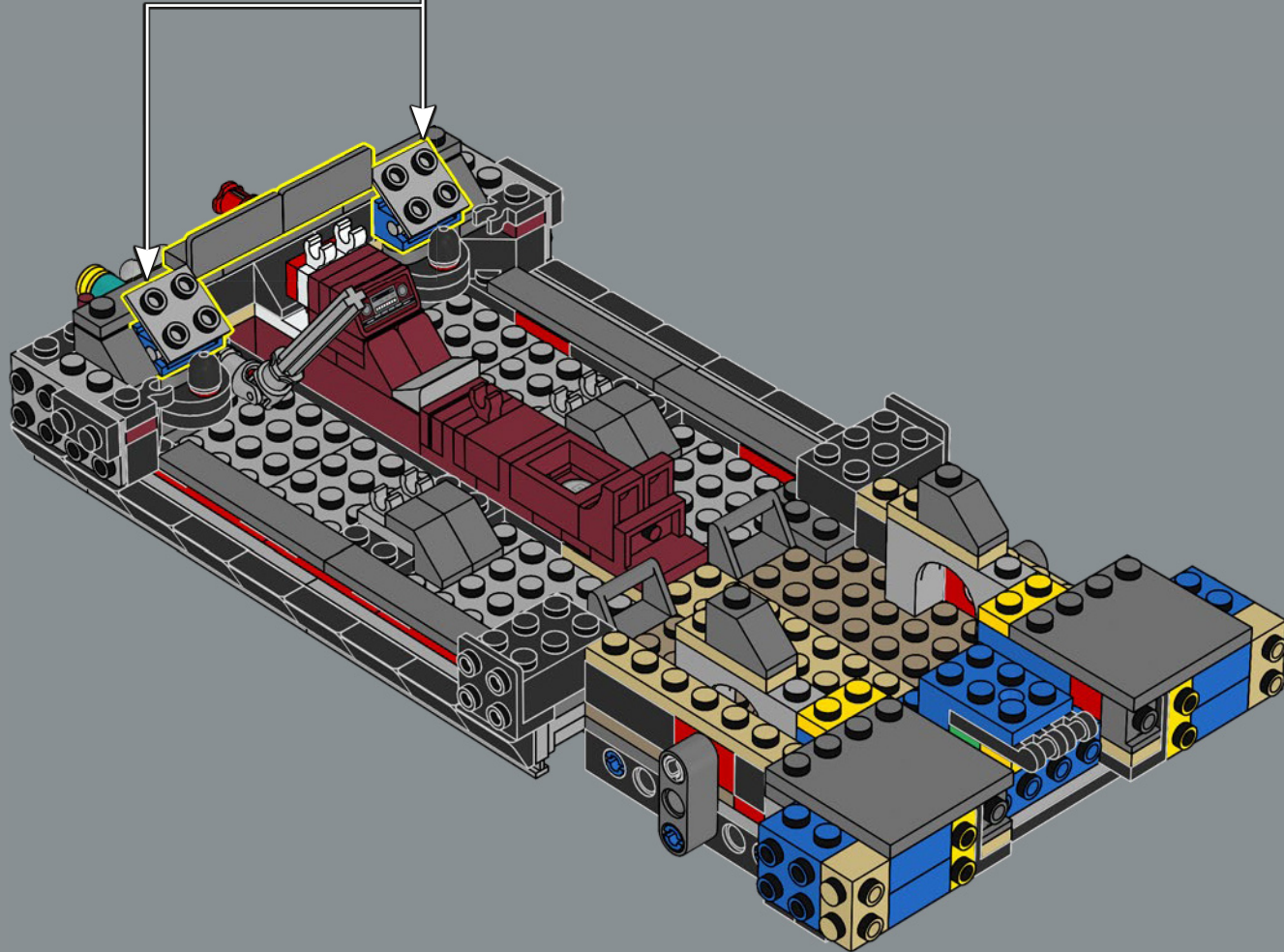
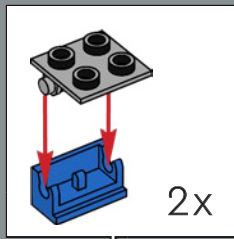

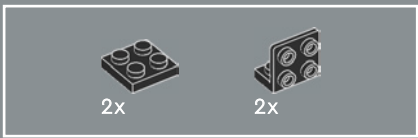

58

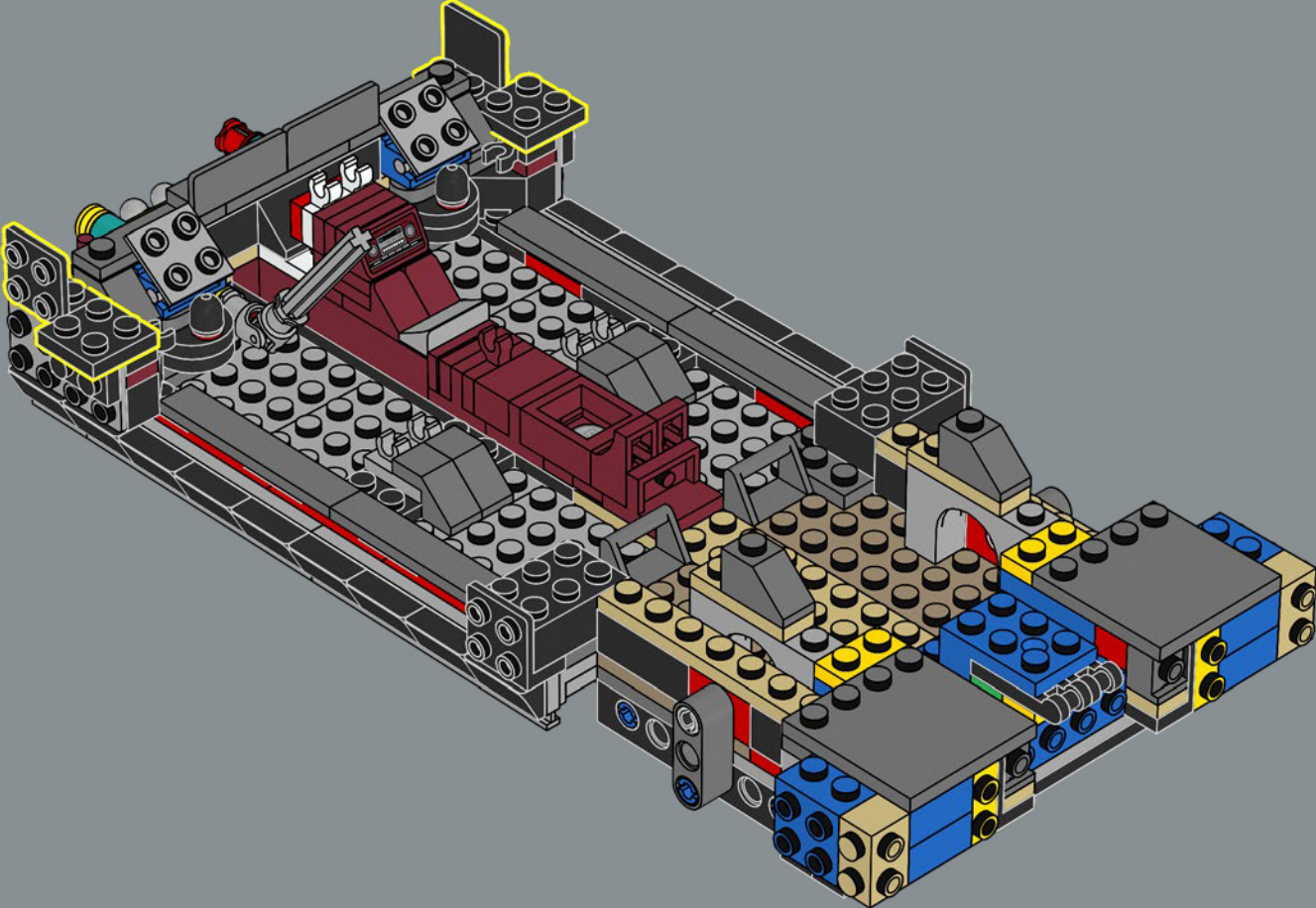

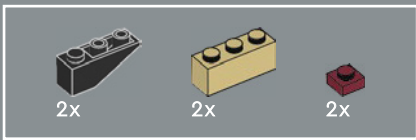

59

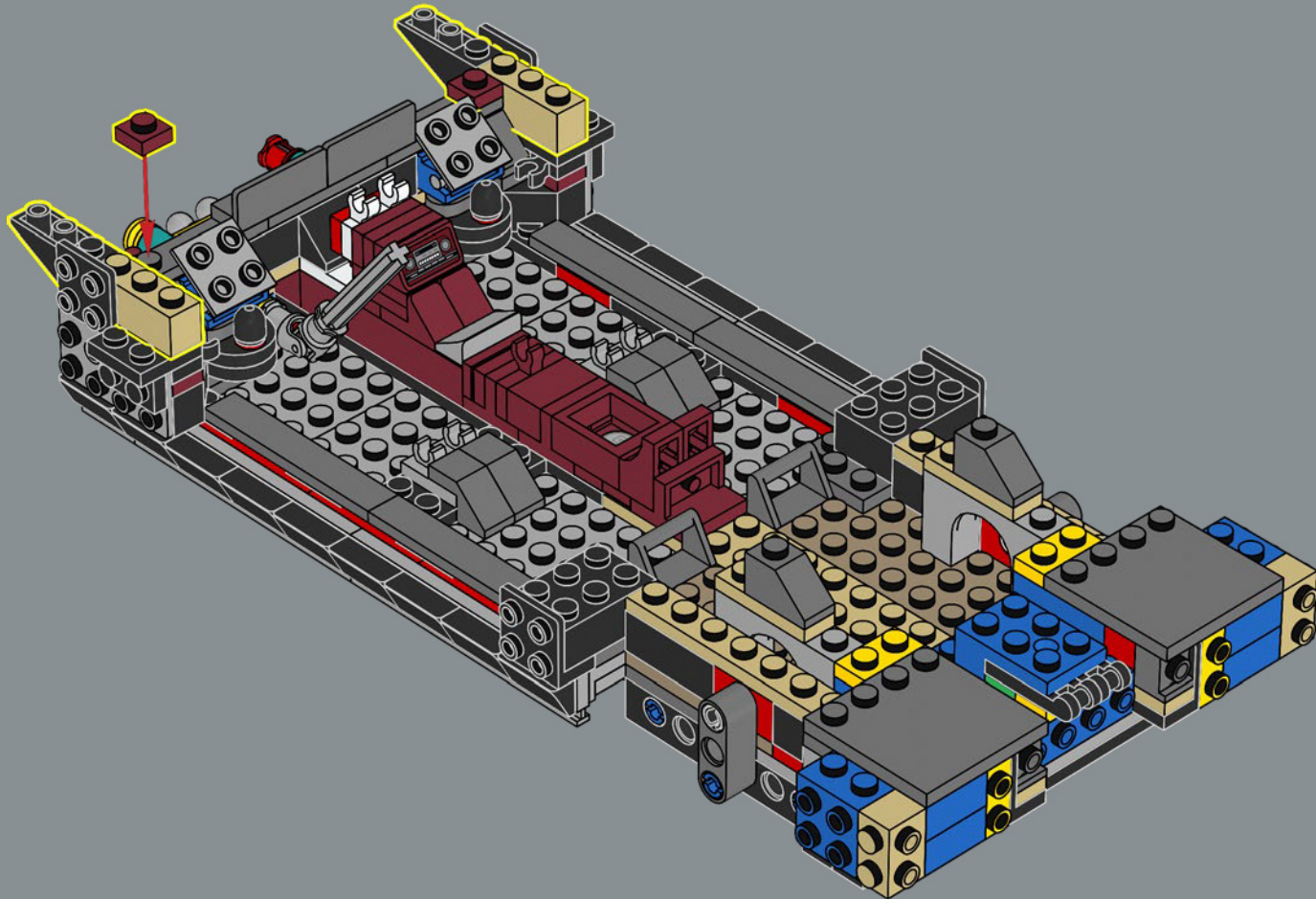



60

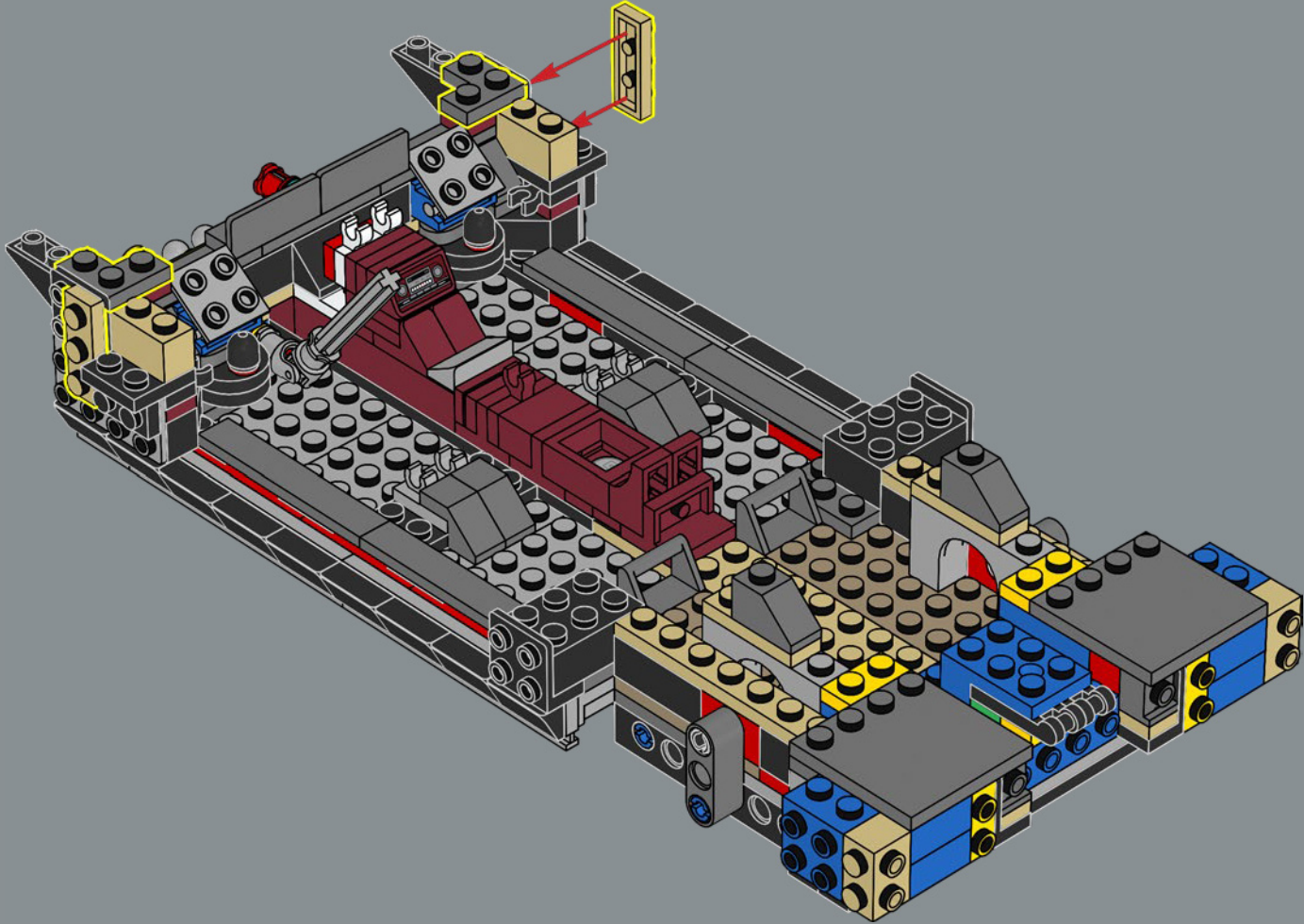





61

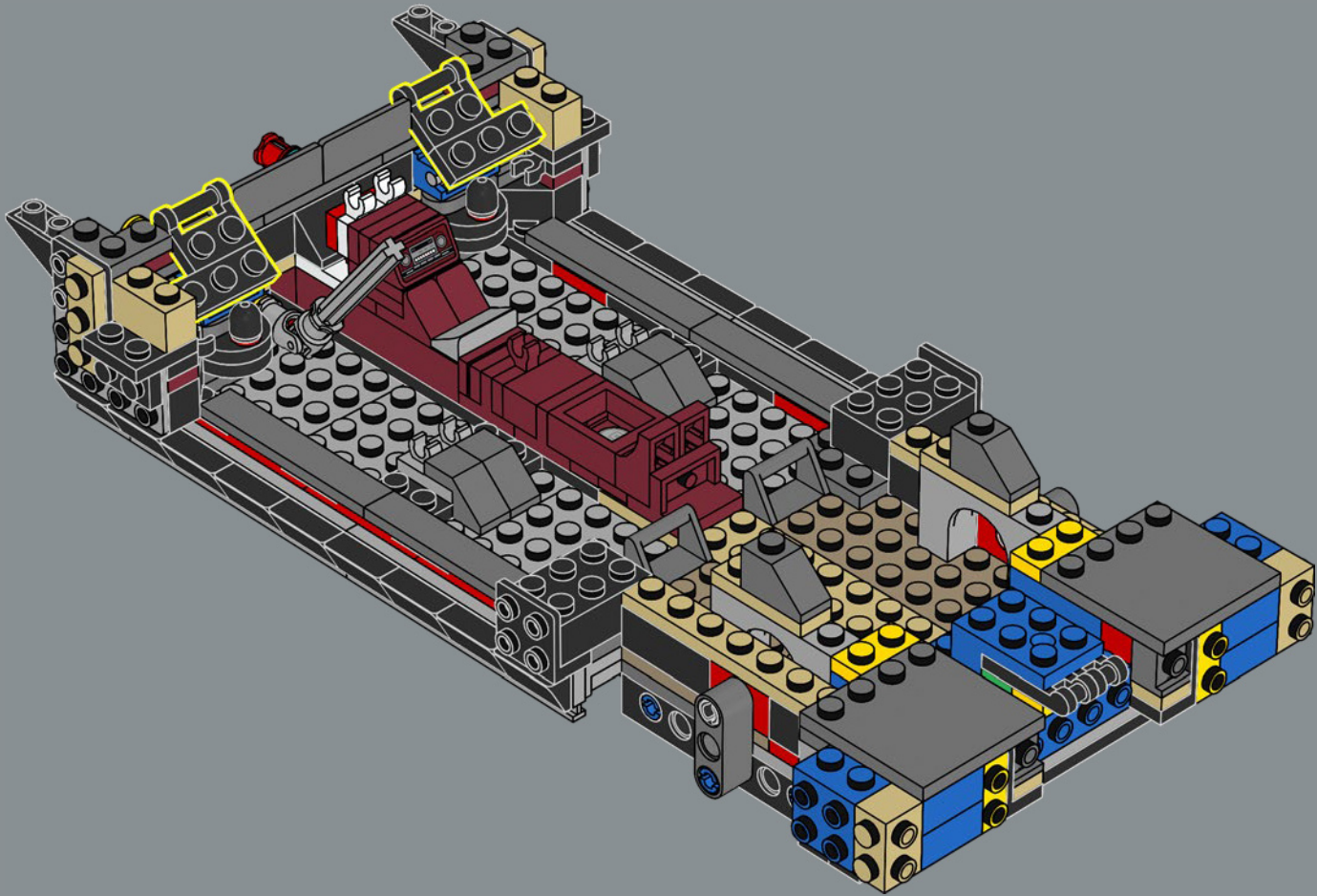

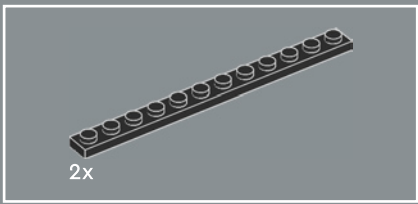

62

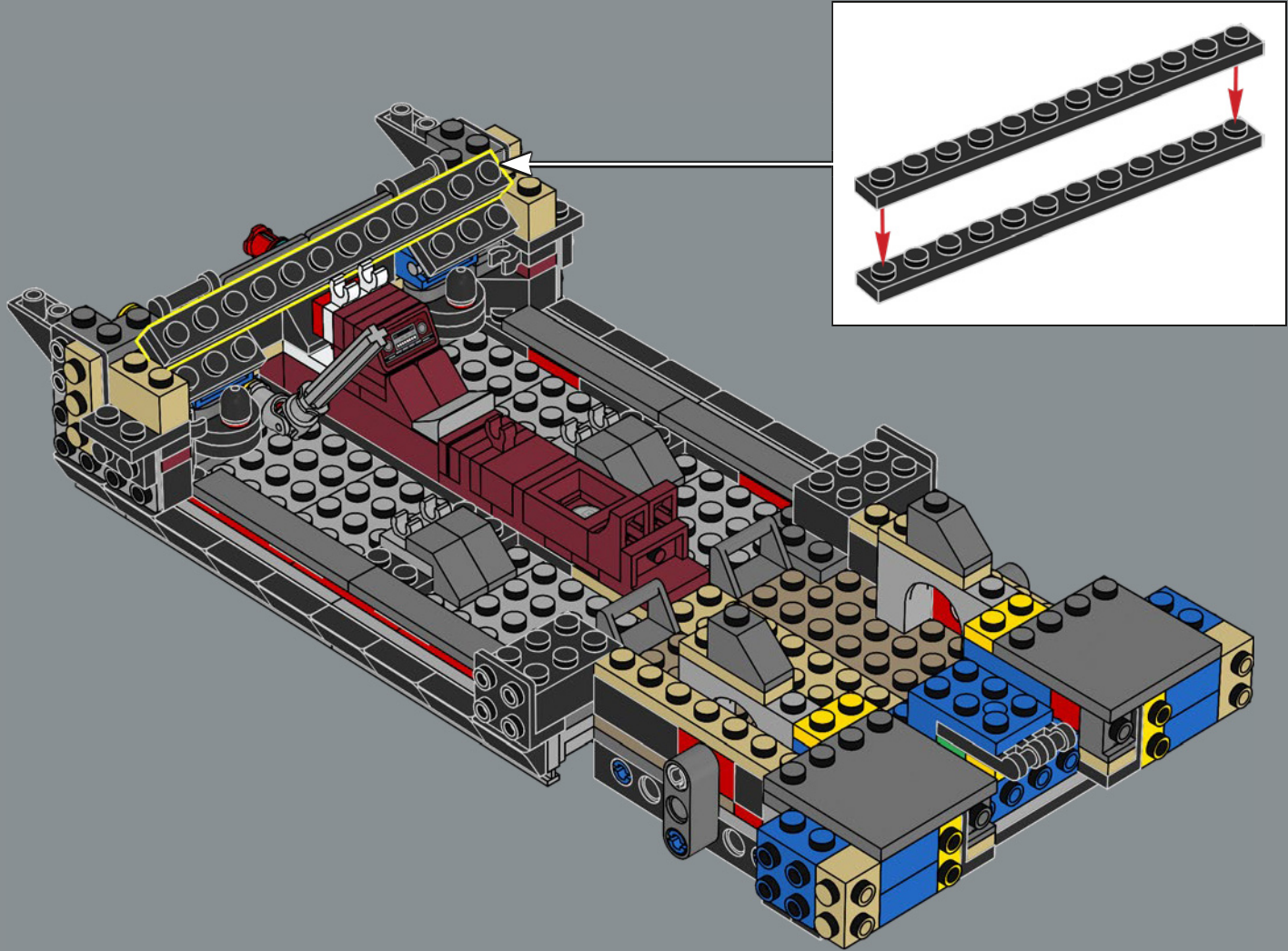

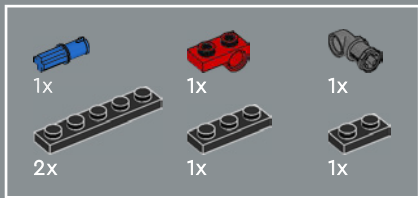

63

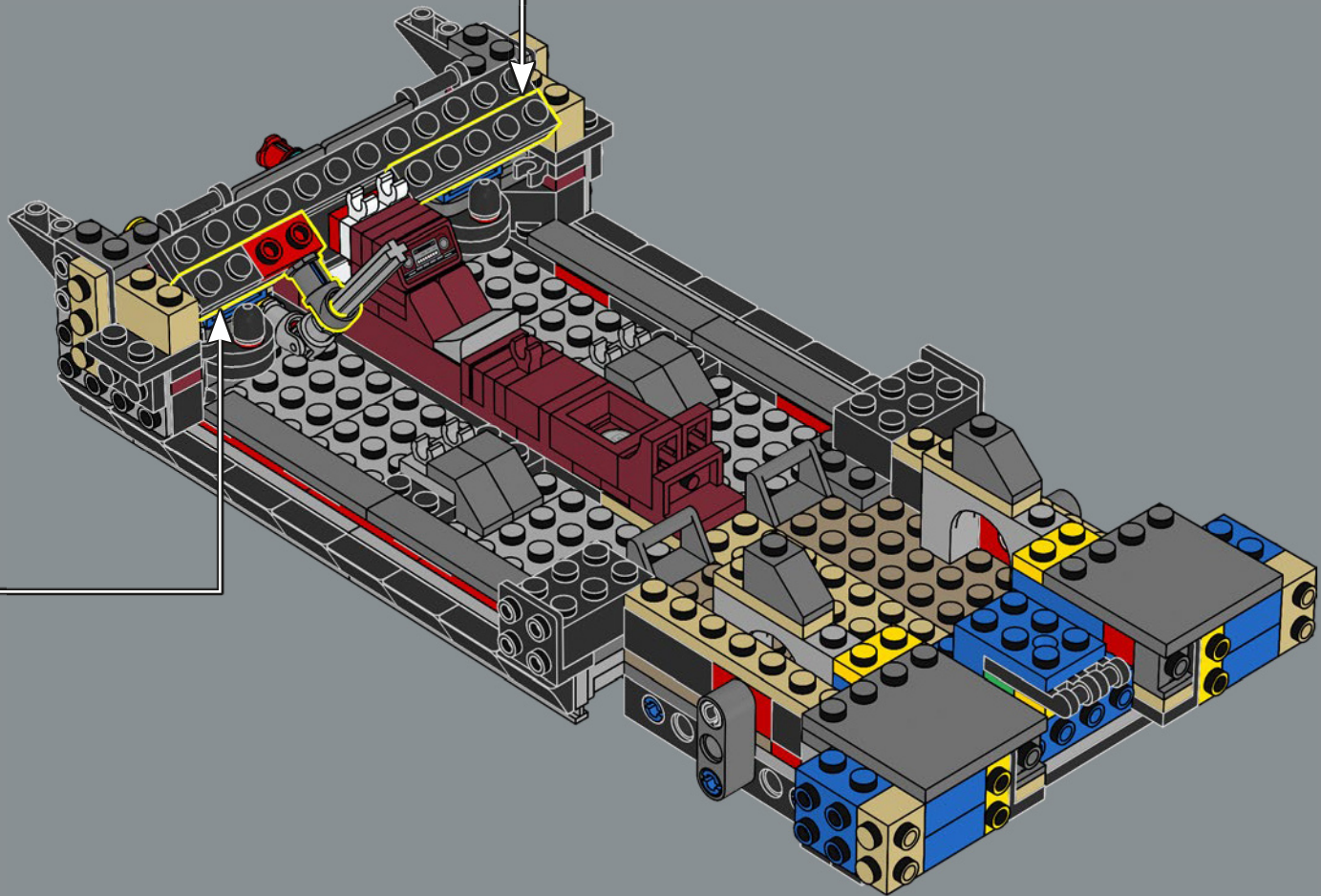
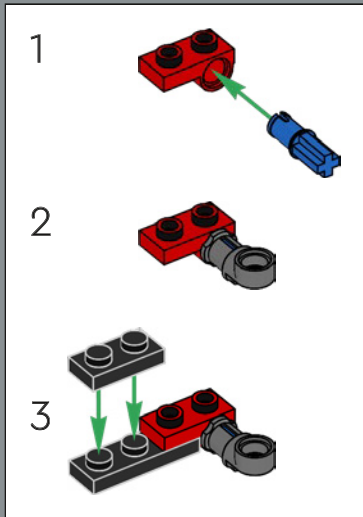
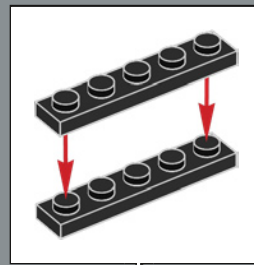

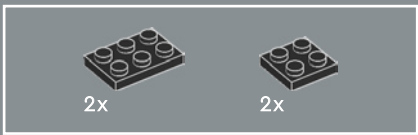

64

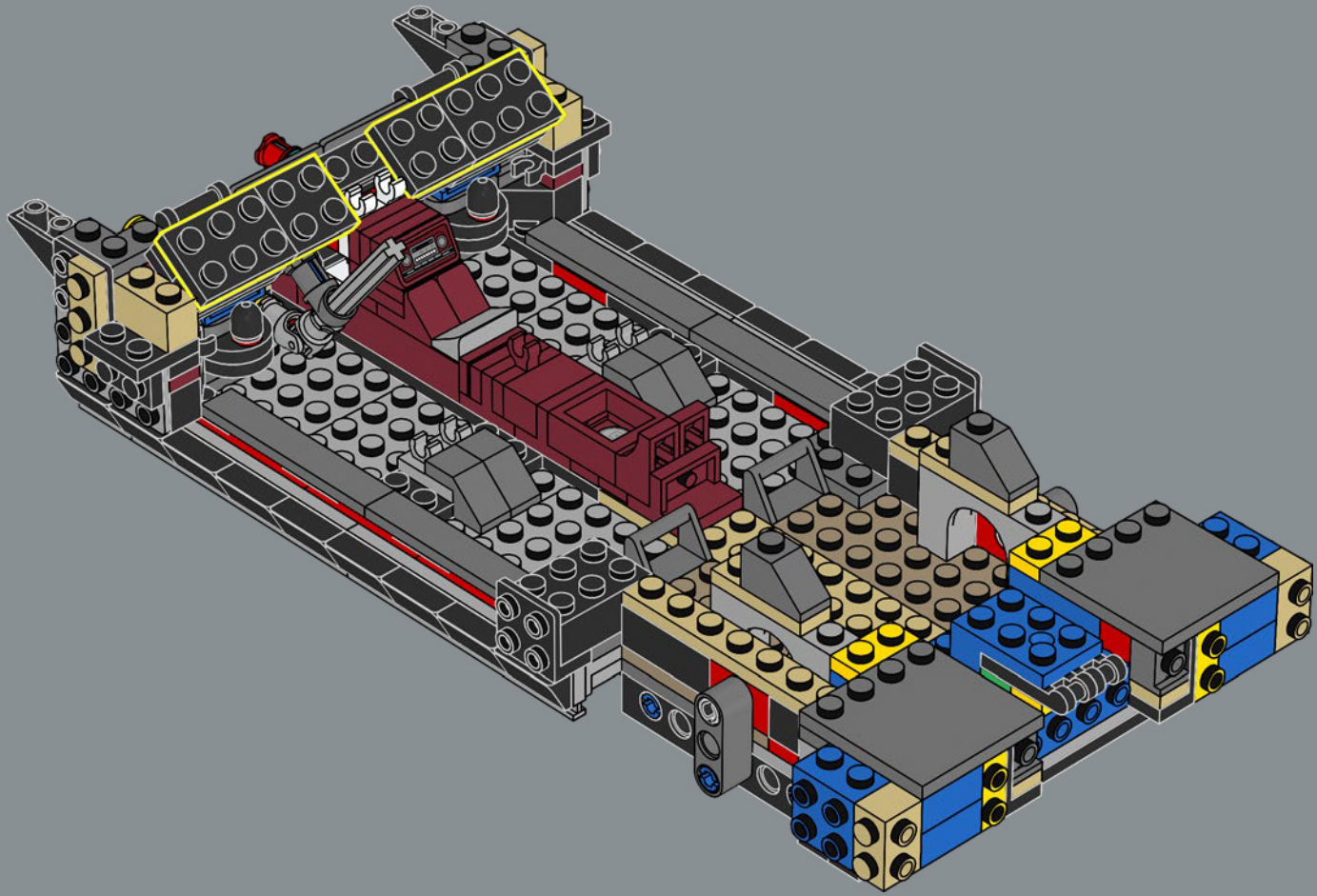



65

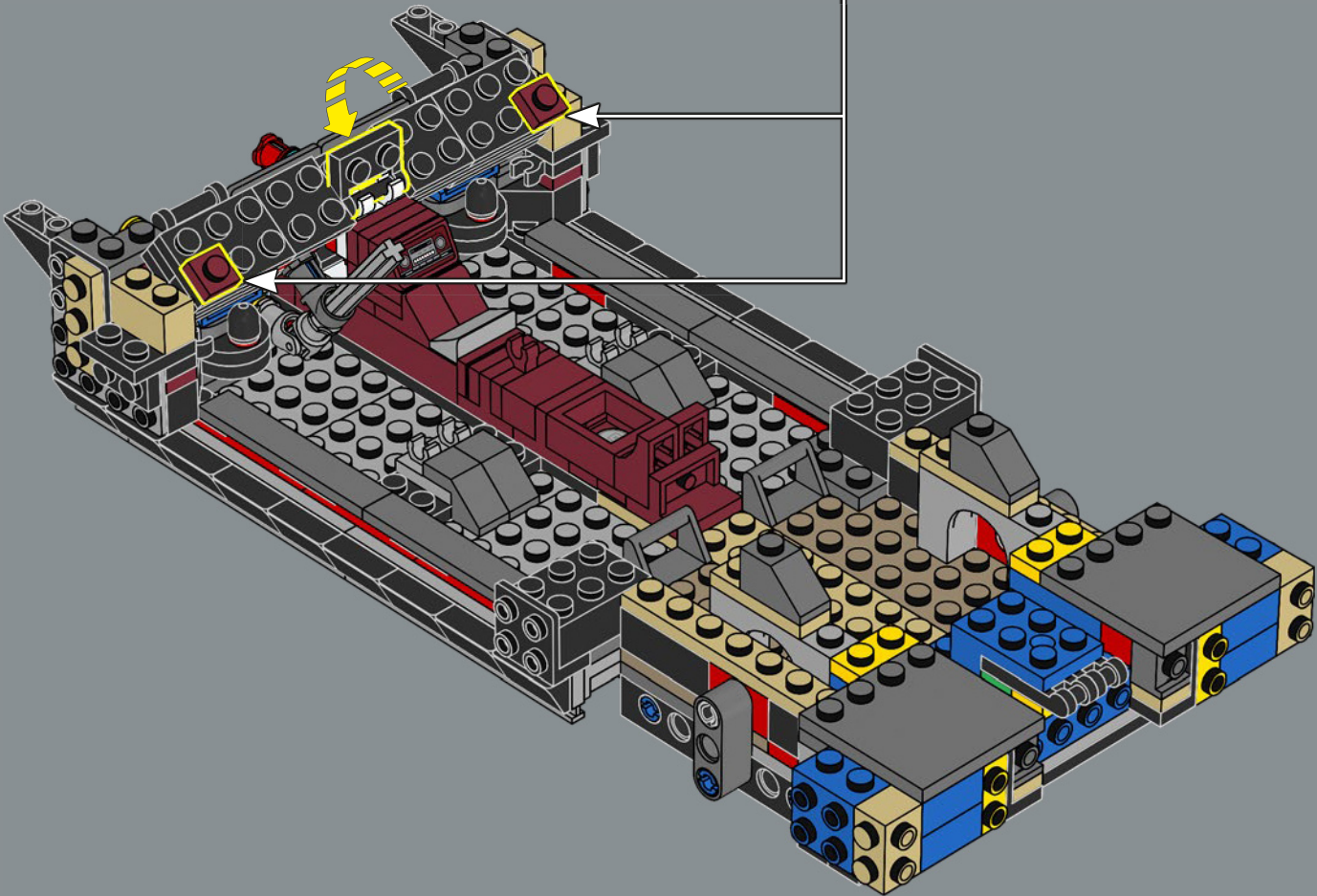
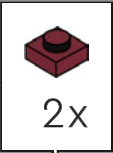

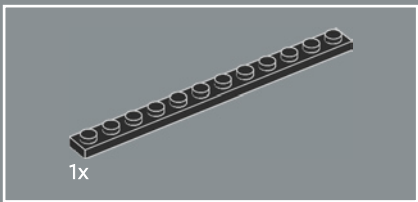

66

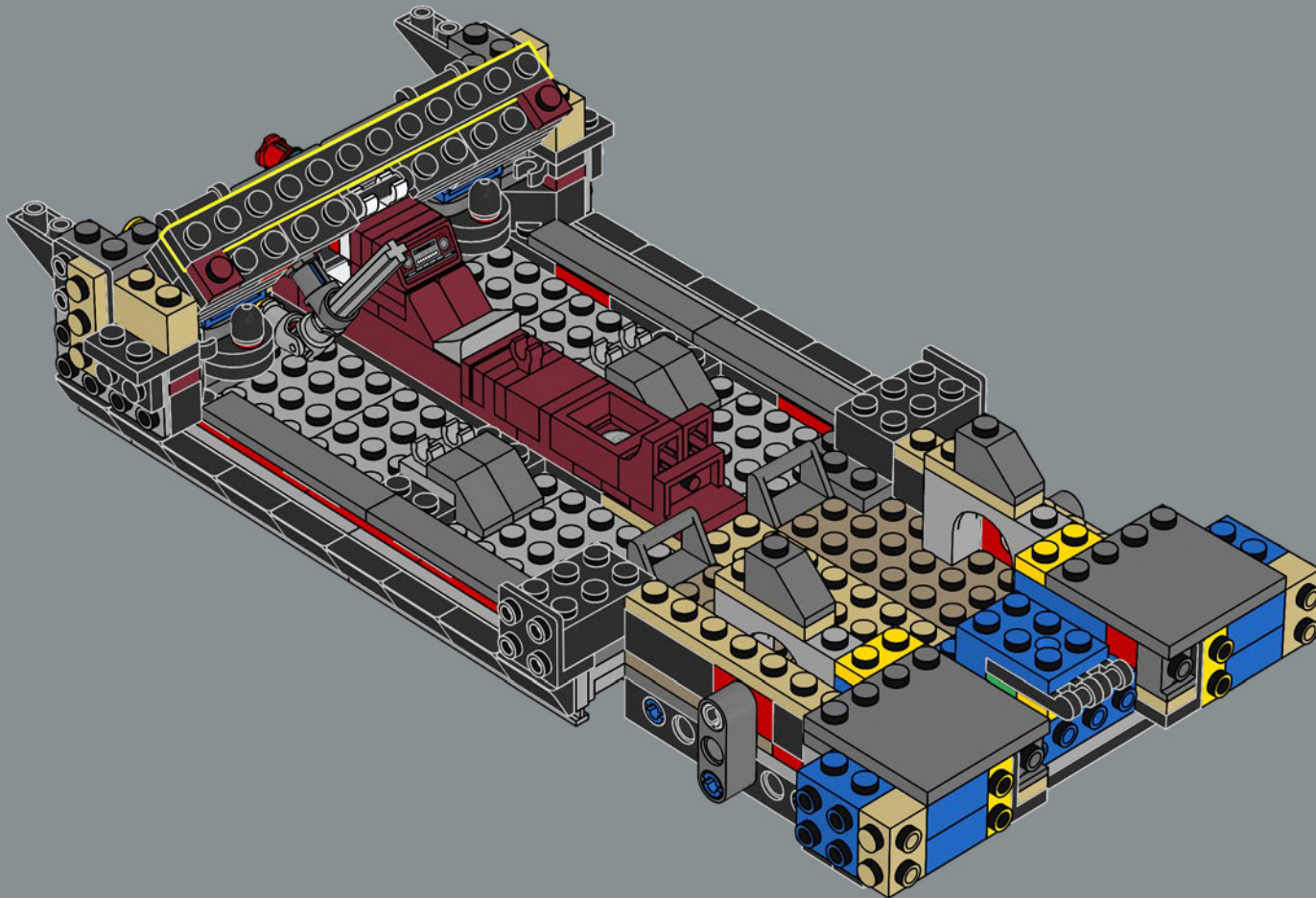

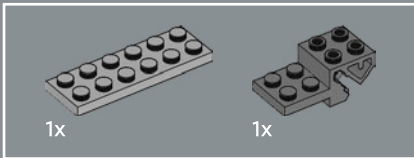
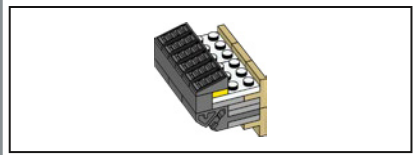

67

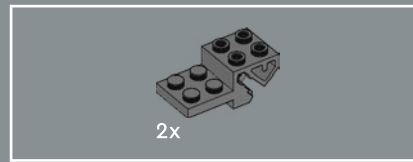
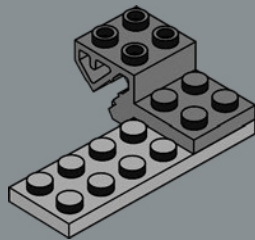

68

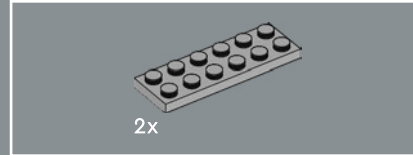
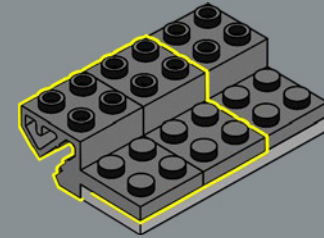

69

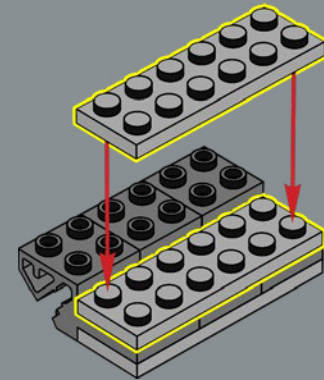

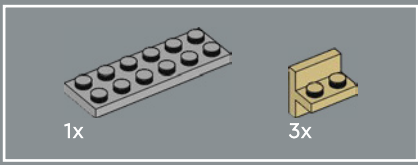

70

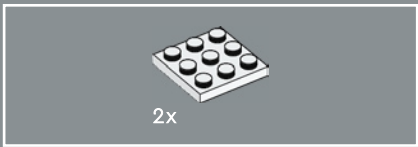
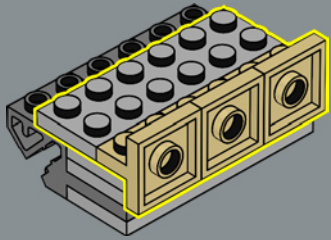

71

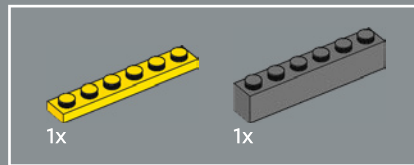
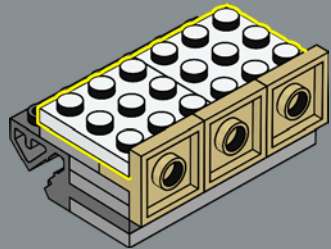

72

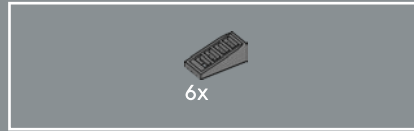
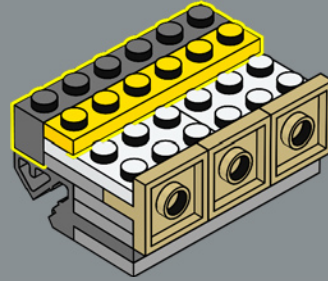

73

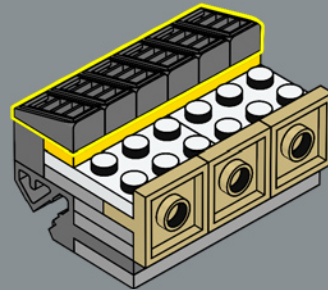

74

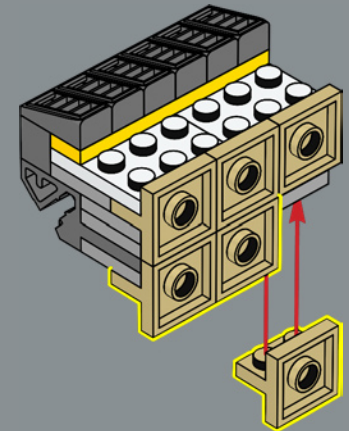



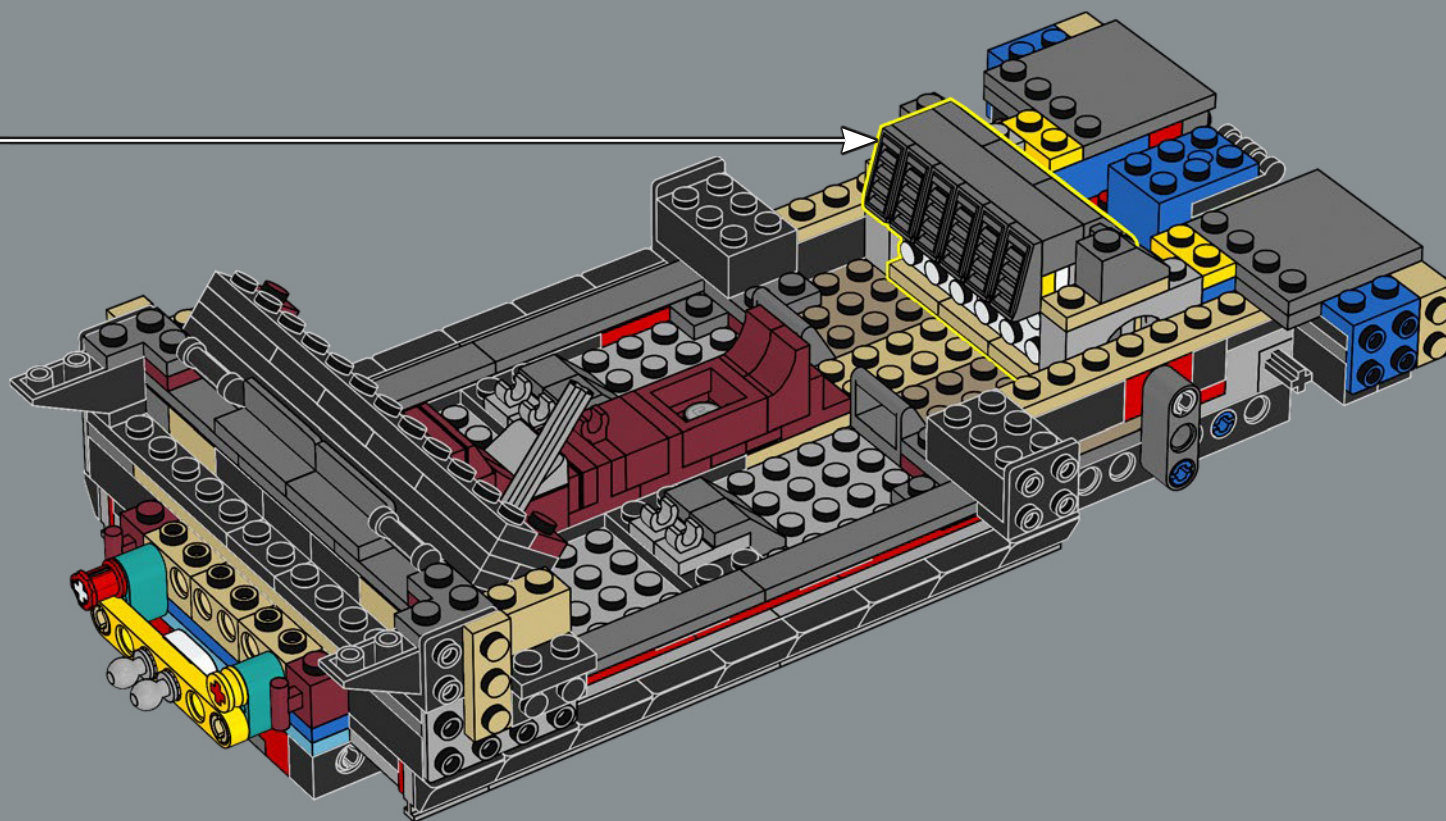

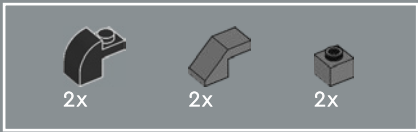

76

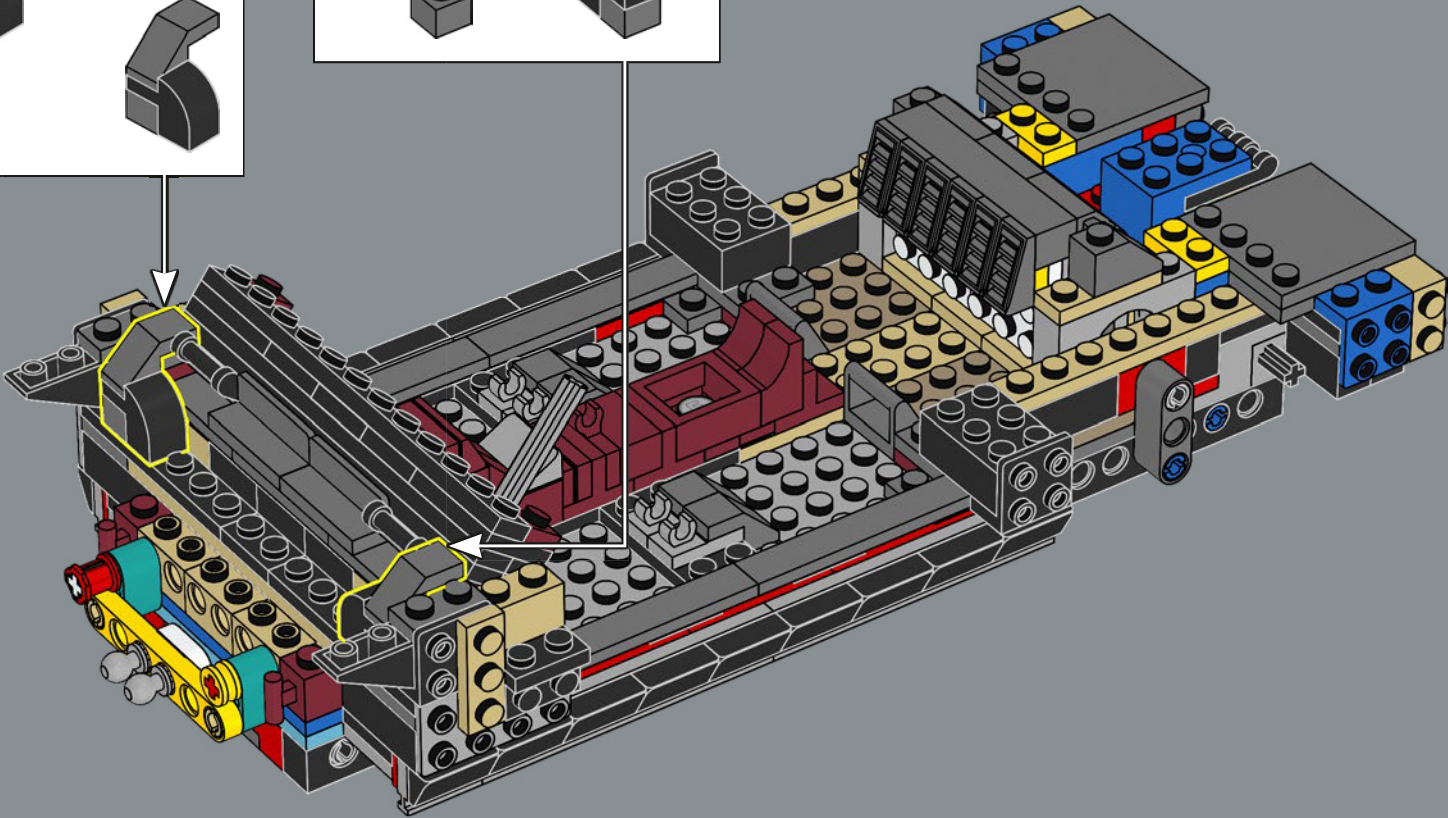
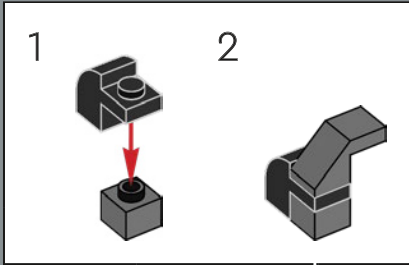
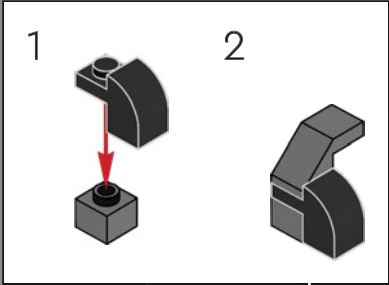

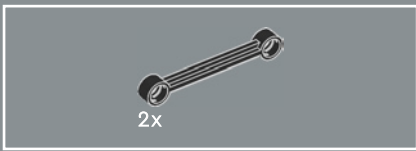

77

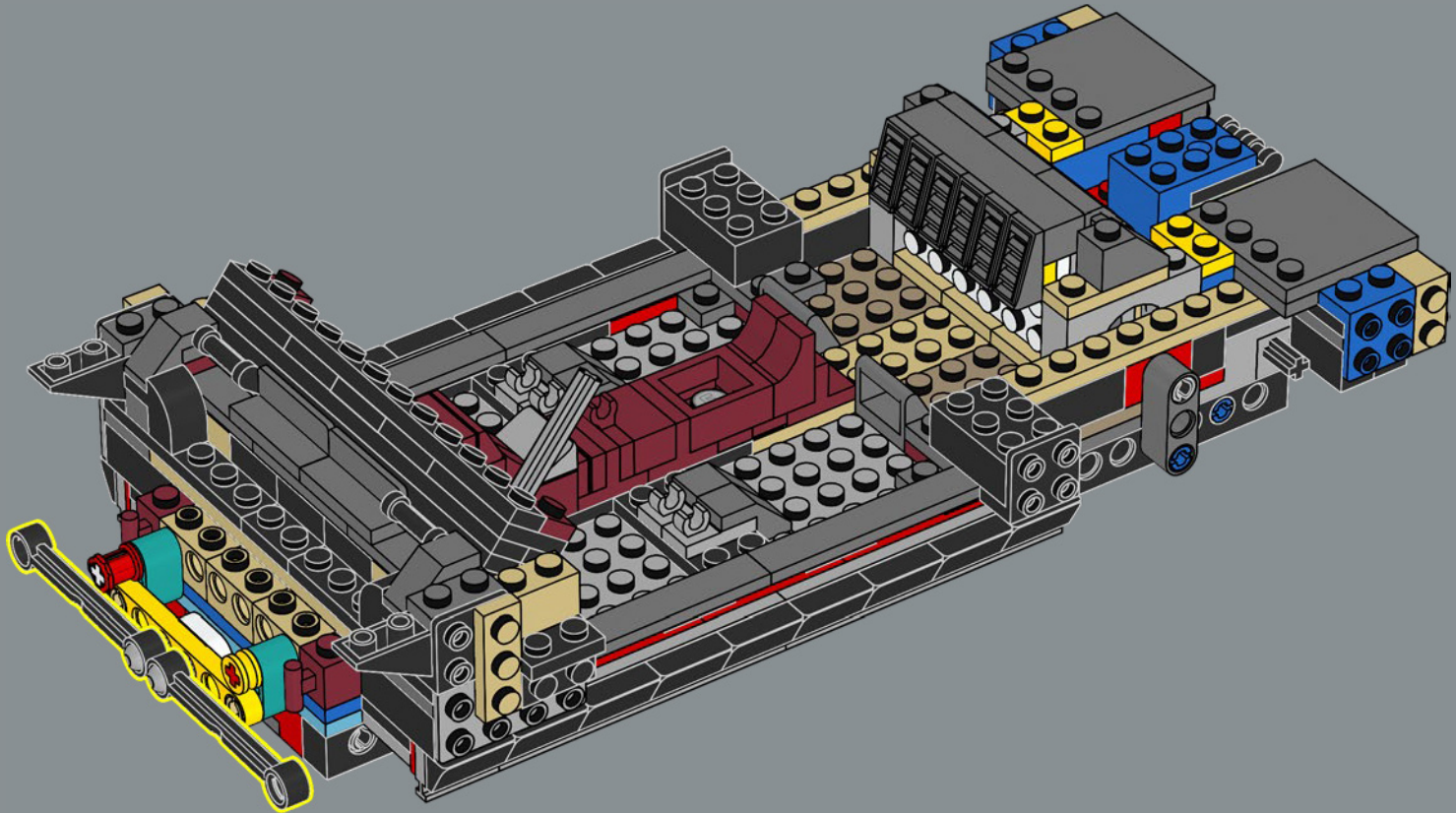

A special Convertible Camaro Z11 served as the official Indianapolis 500 pace car in 1969.

Une Camaro Z11 décapotable spéciale a servi de voiture pilote officielle pour l'Indianapolis 500 en 1969.

Se usó un Camaro Z11 convertible especial como auto de seguridad oficial en las 500 Millas de Indianápolis de 1969.

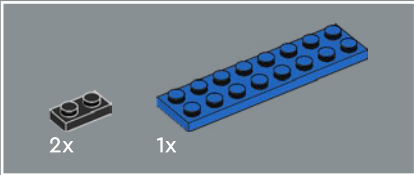
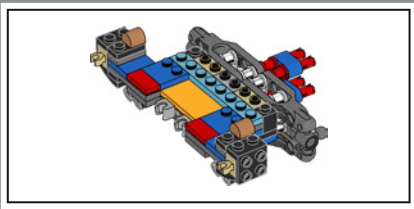

78

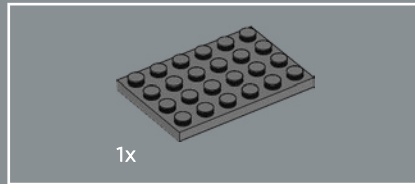
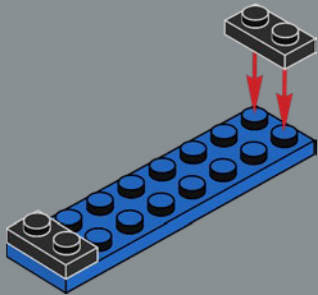

79

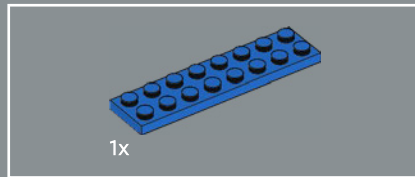
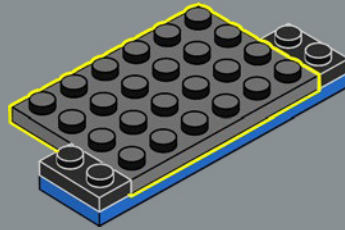

80

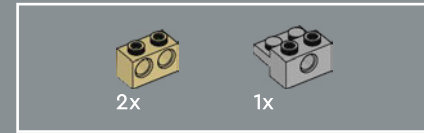
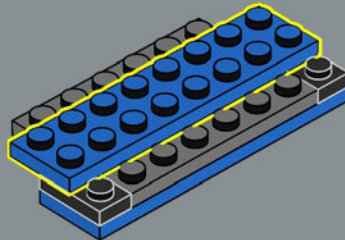

81

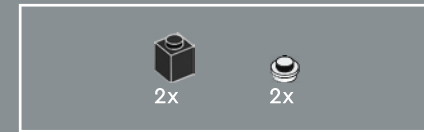
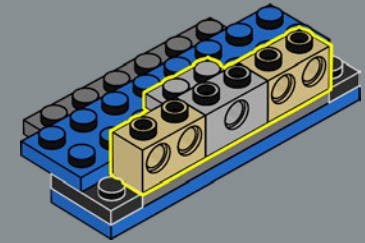

82

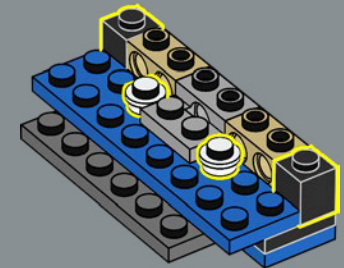



83

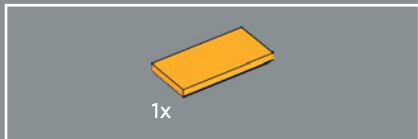
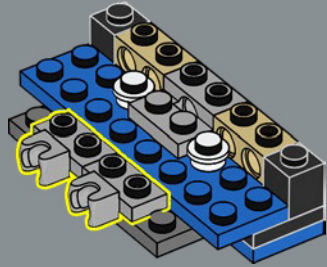

84

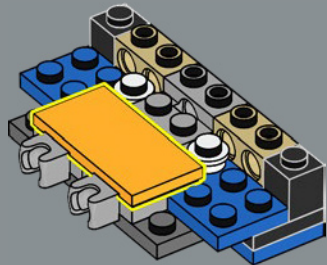

85

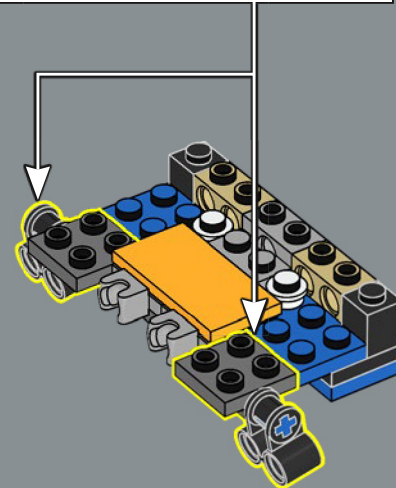
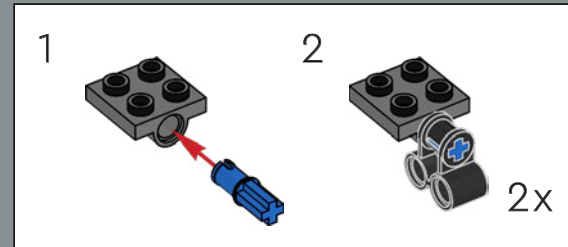

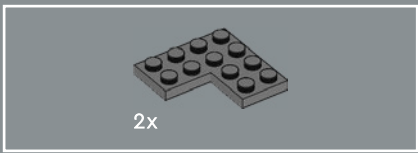

86

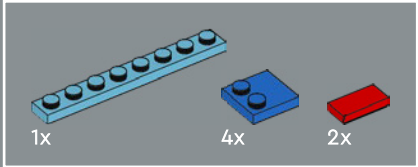
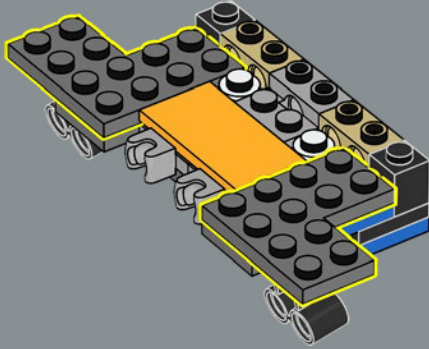

87

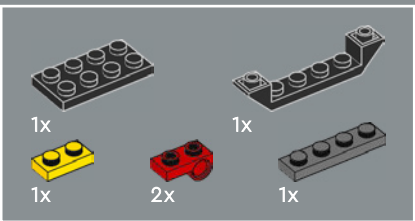
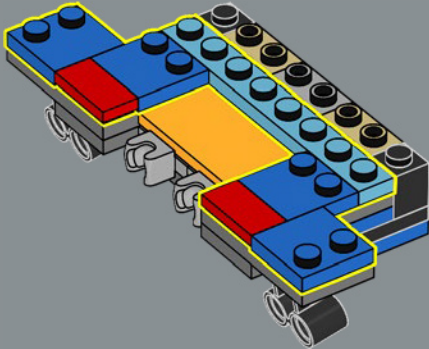

88

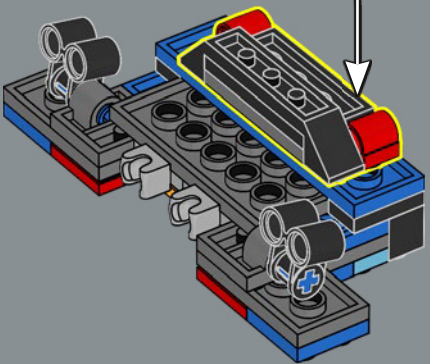
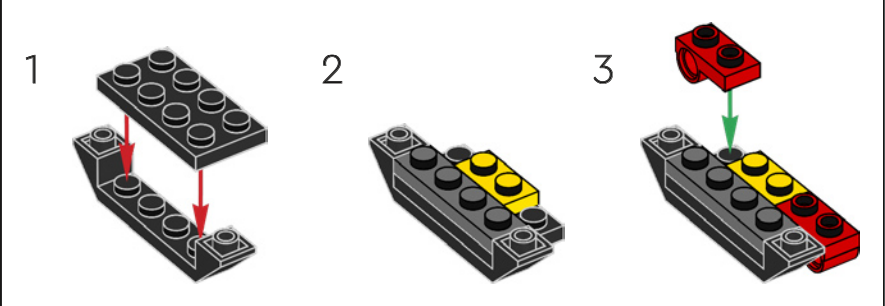

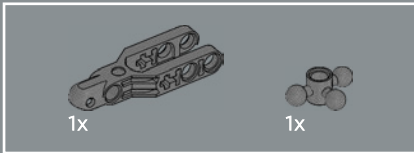
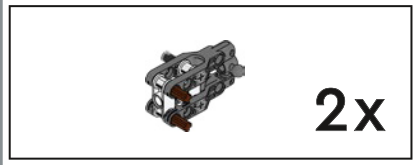
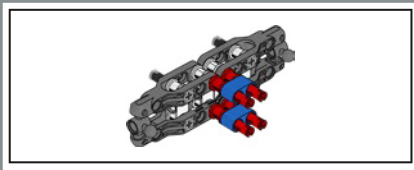

89

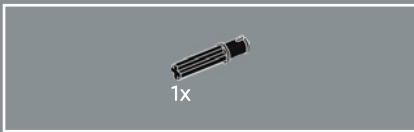
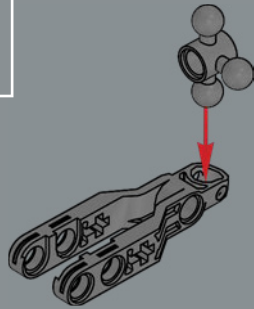

90

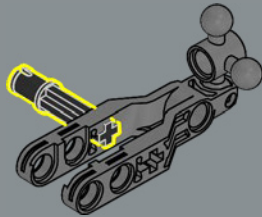

91

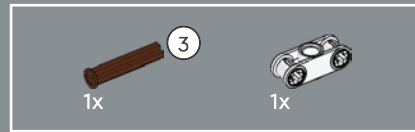
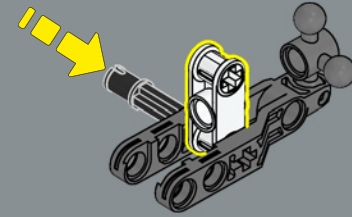

92

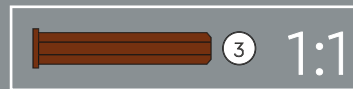
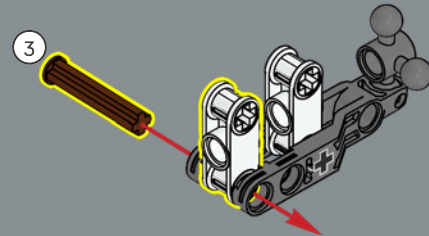



93

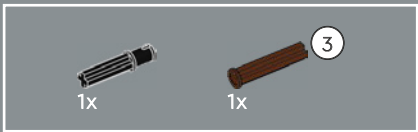
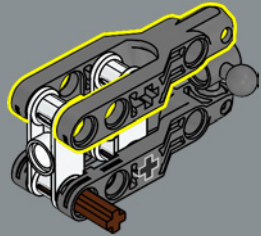

94

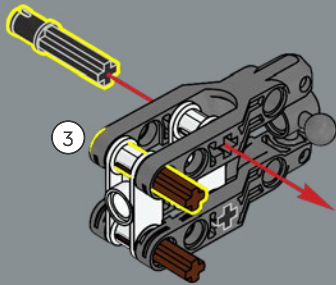

2x

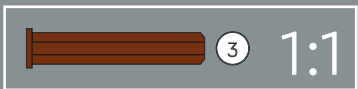

95

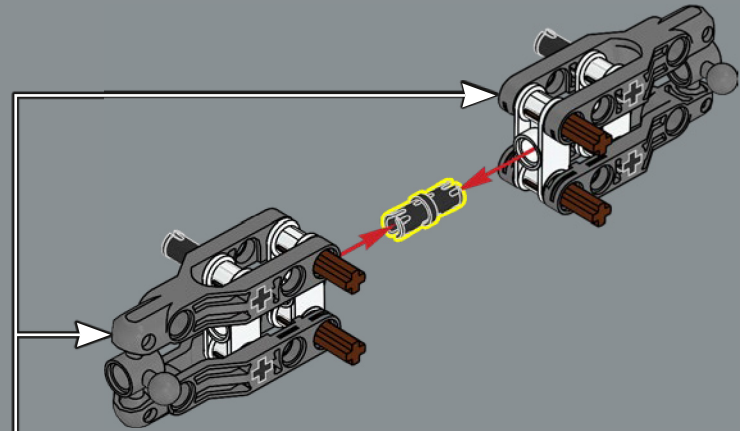





96

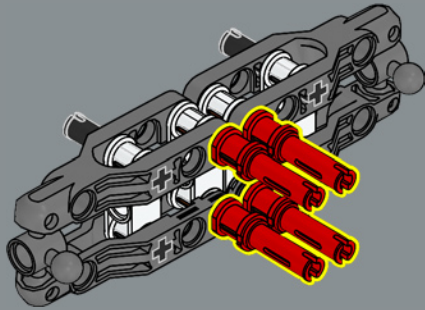

97

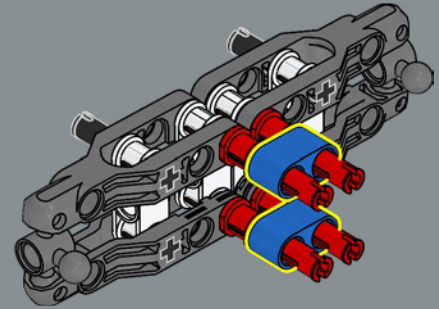

98

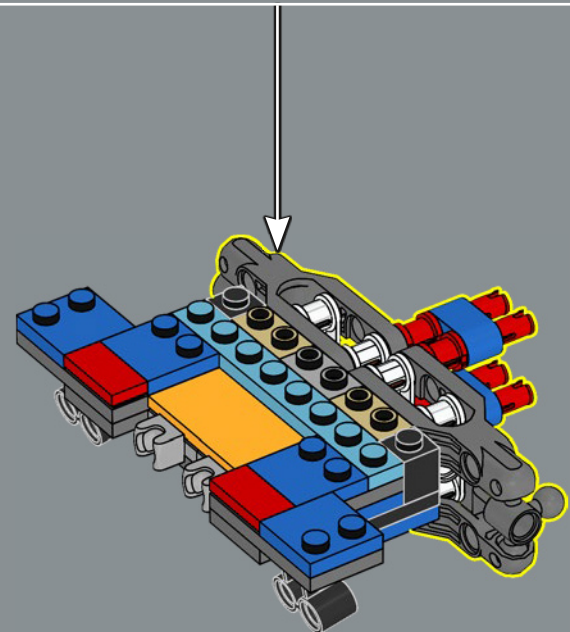

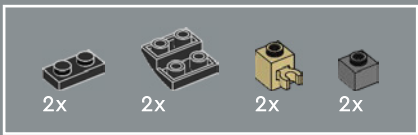

99

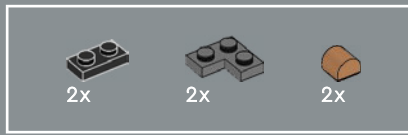
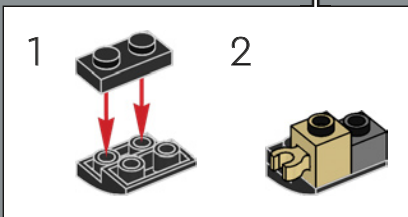
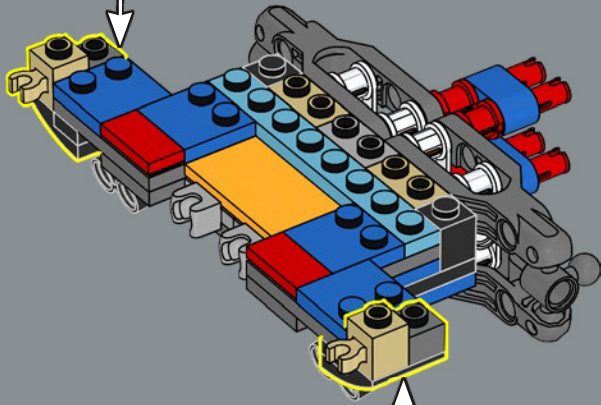
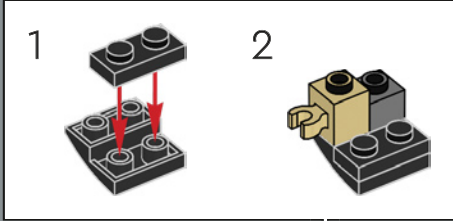

100

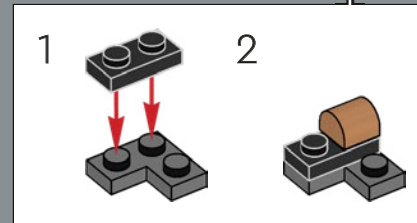
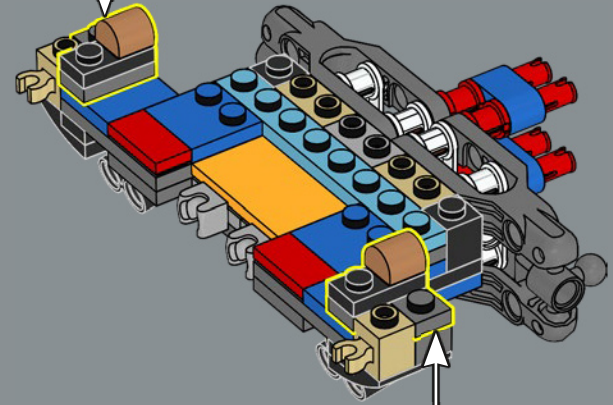
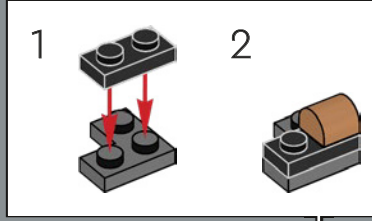

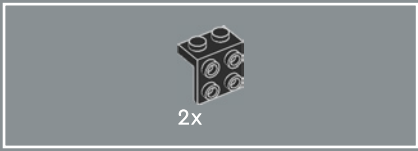

101

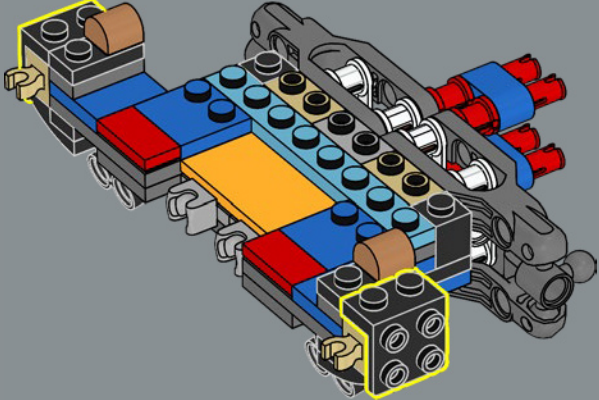

102

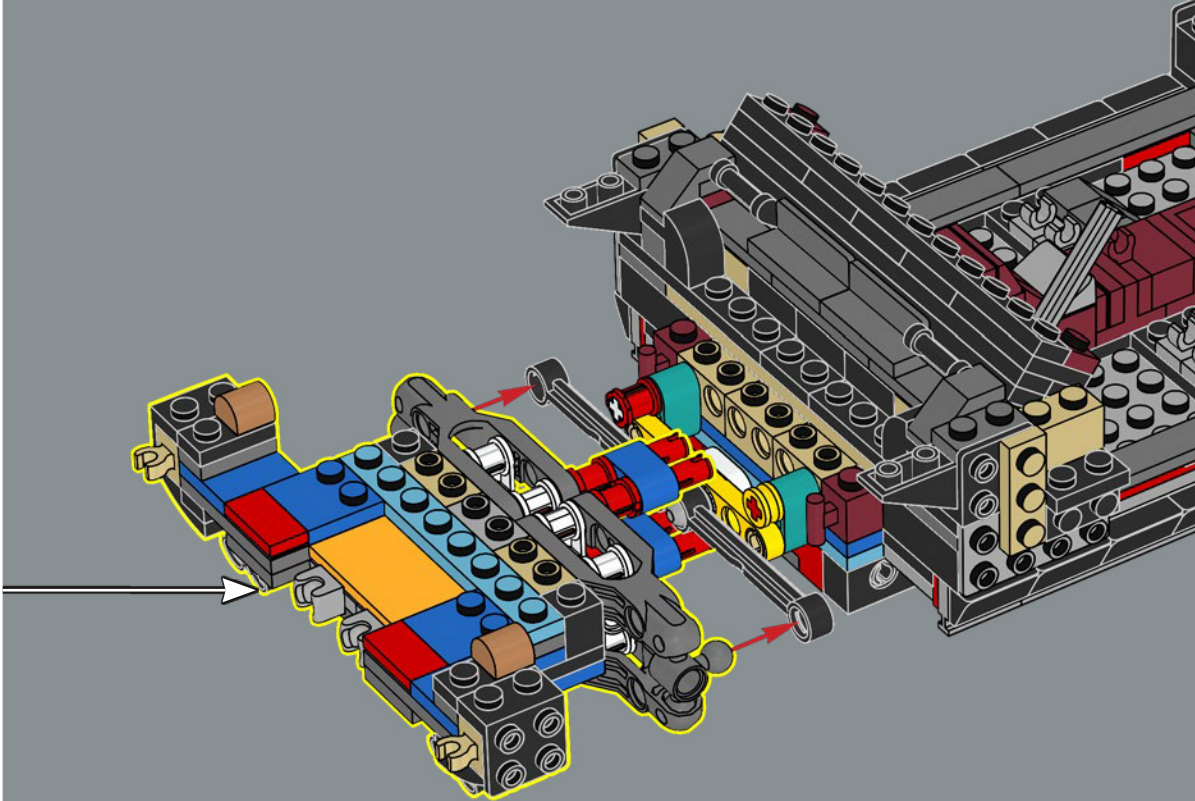

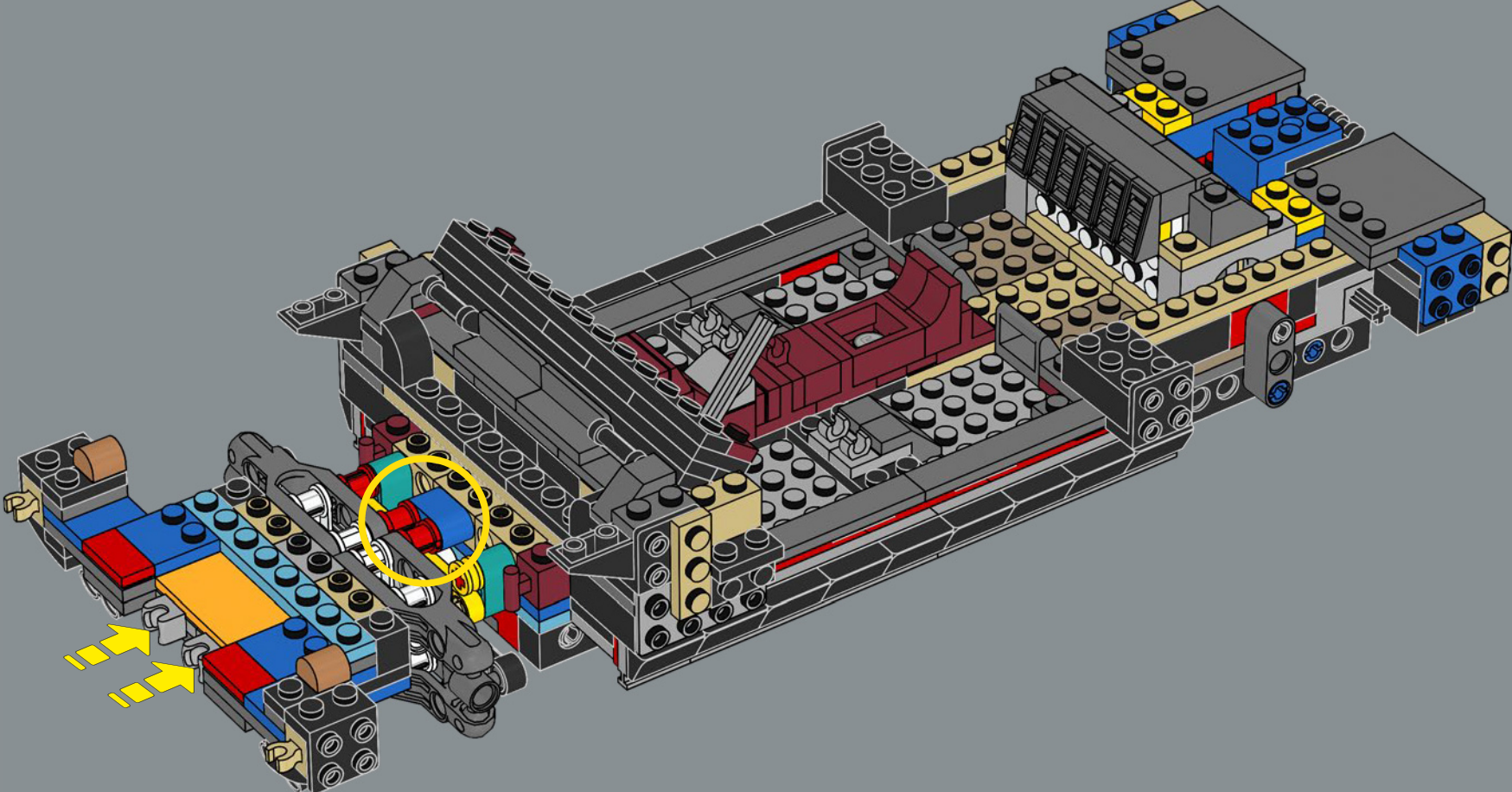

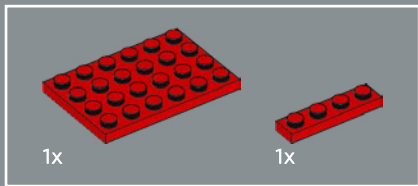

104

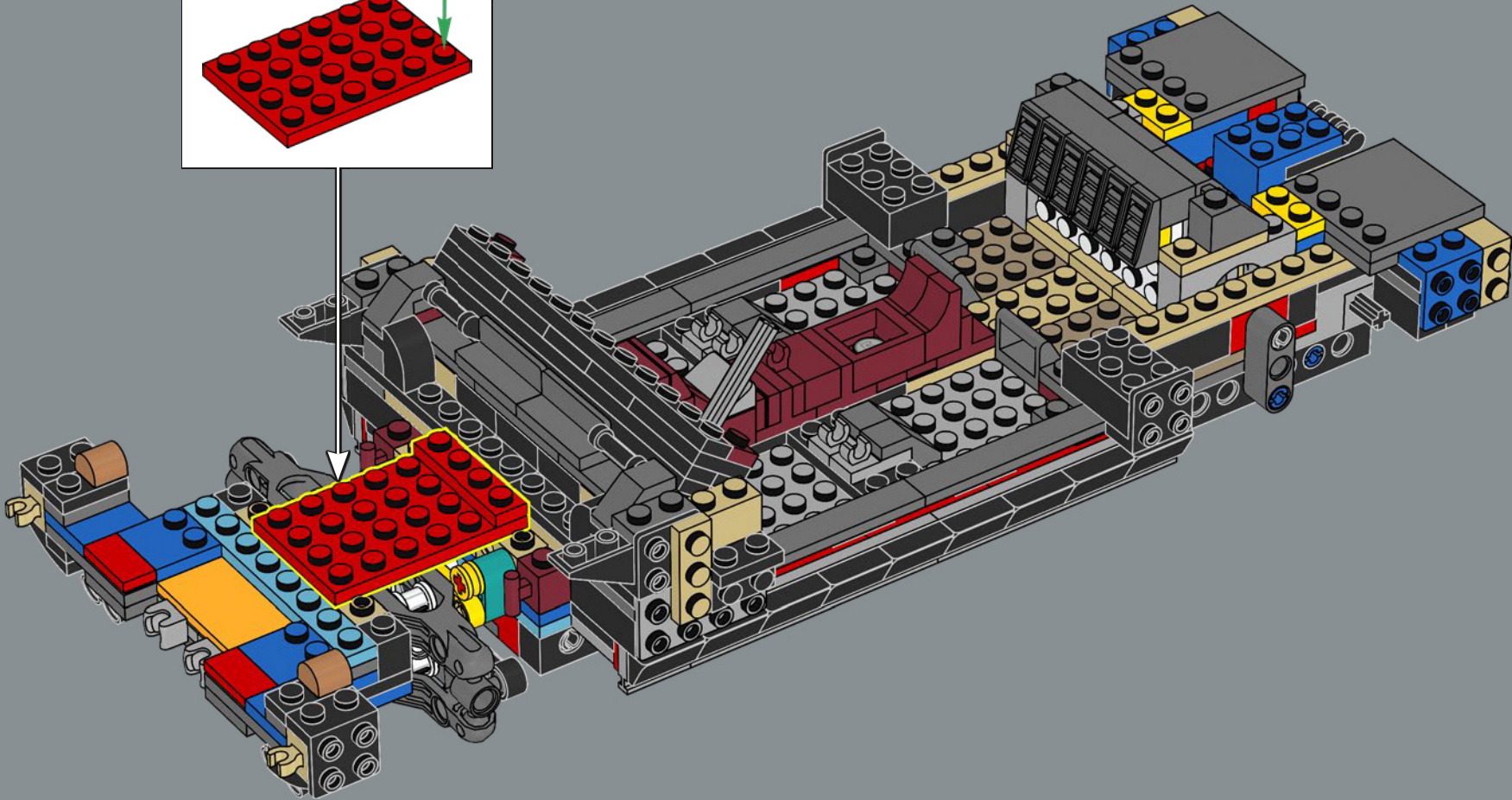
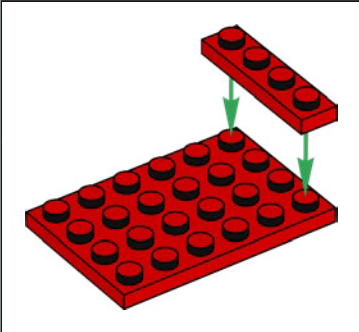

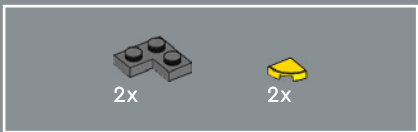

105

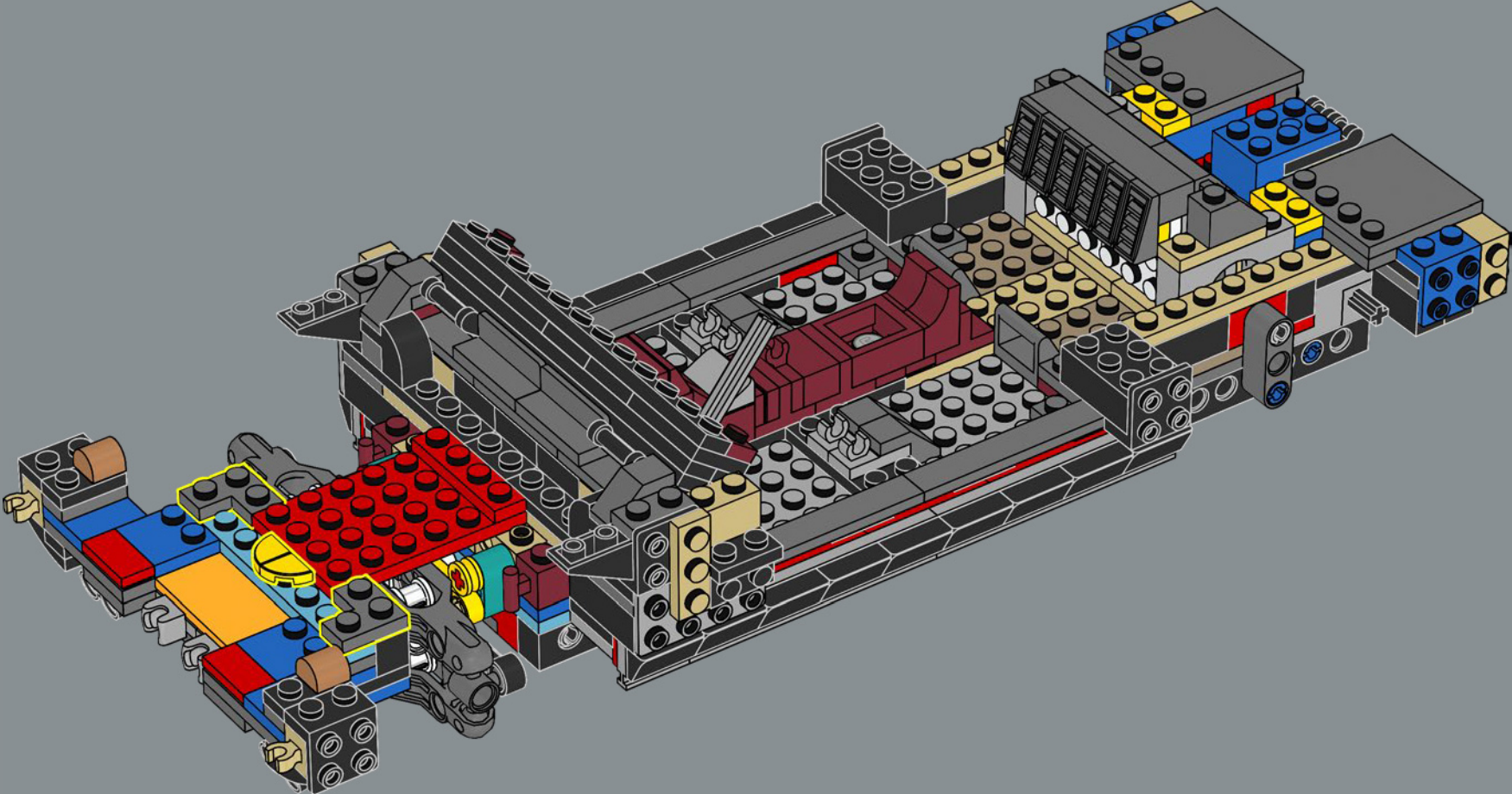

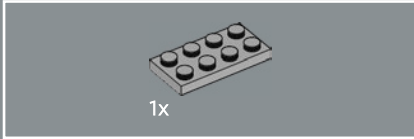
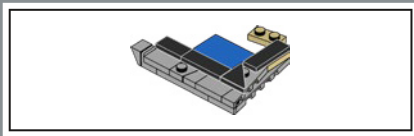

106

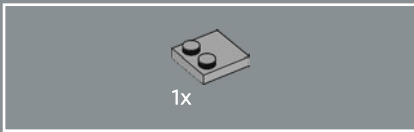
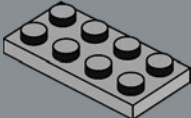

107

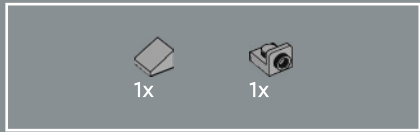
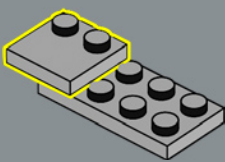

108

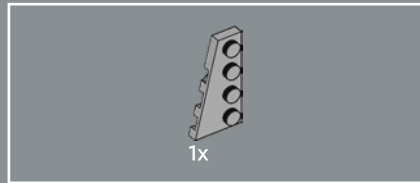
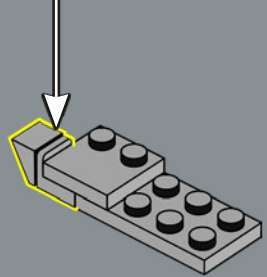
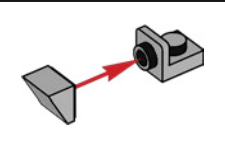

109

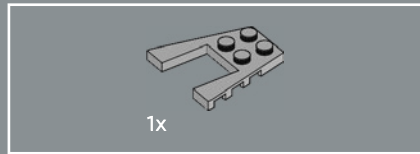
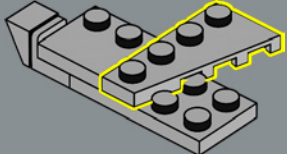

110

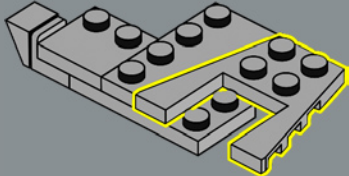

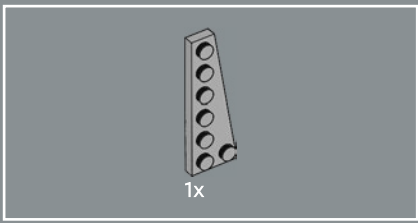

111

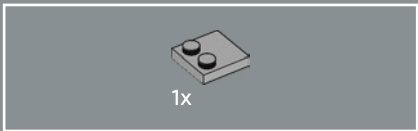
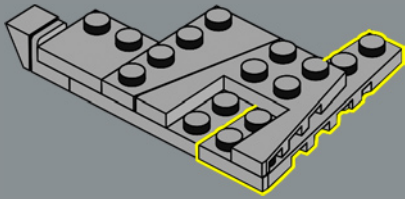

112

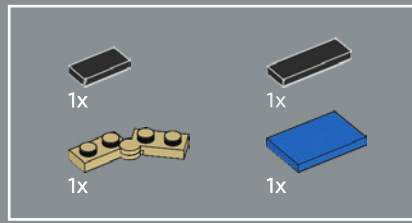
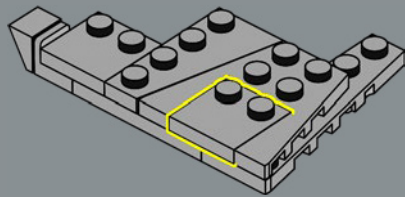

113

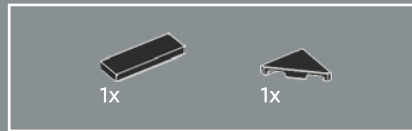
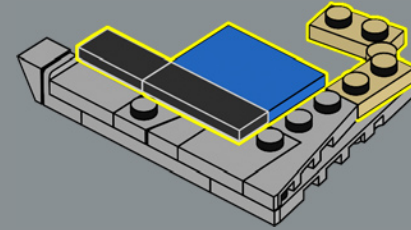

114

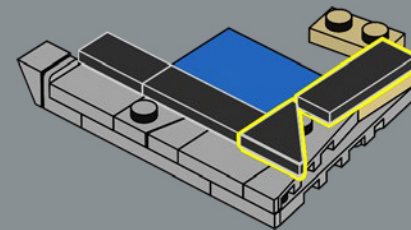



115

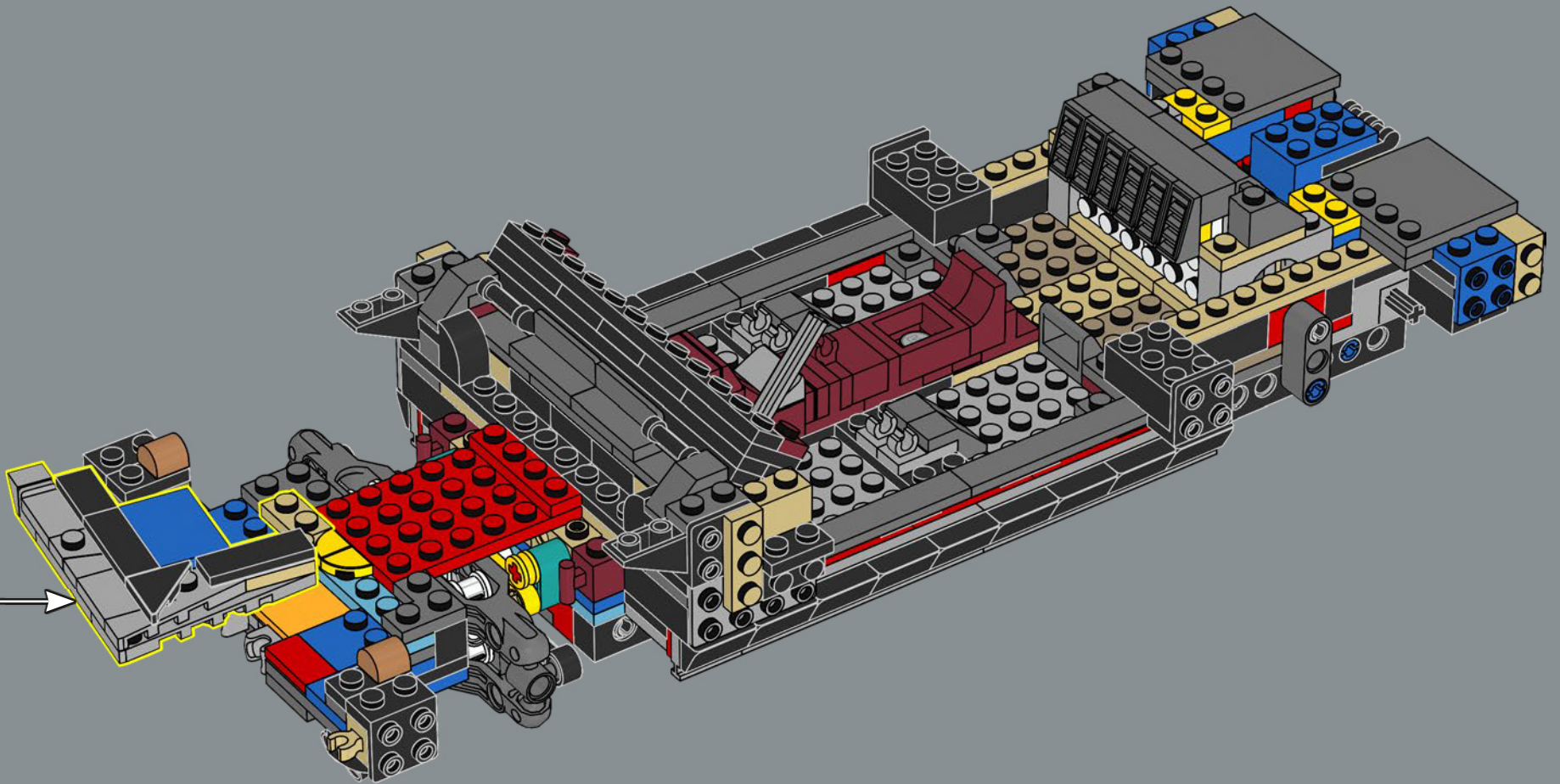

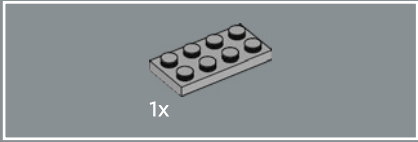
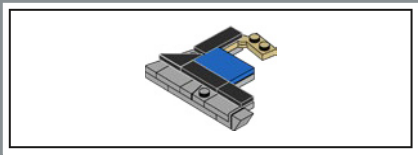

1x

116

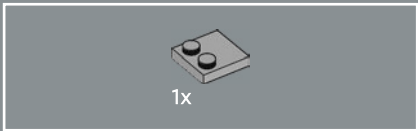
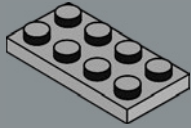

1x

117

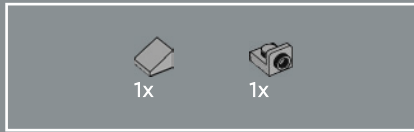
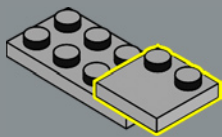

1x

1x

118

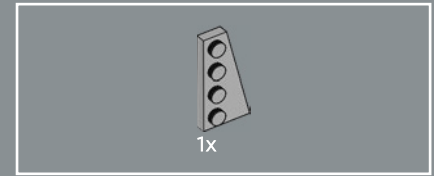
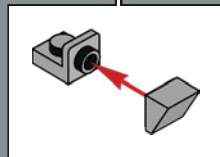
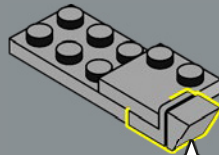

1x

119

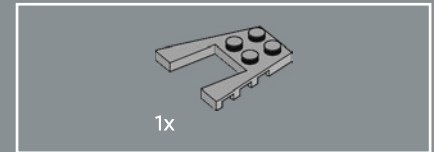
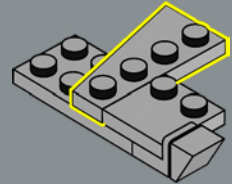

1x

120

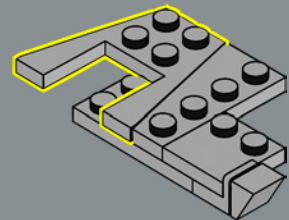

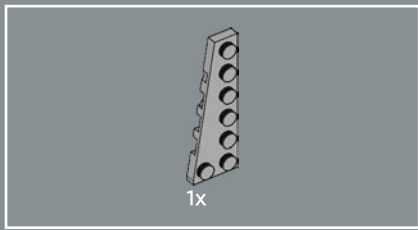

121

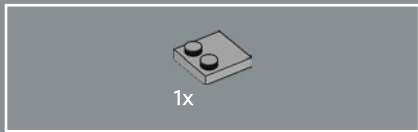
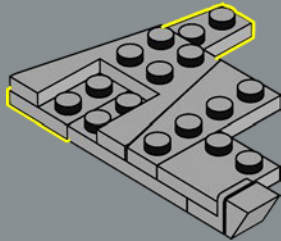

122

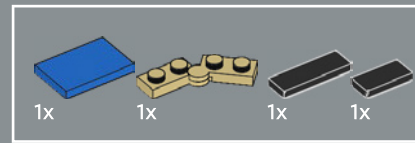
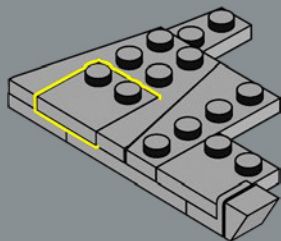

123

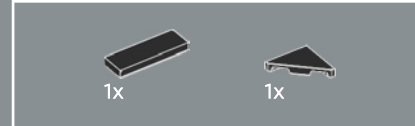
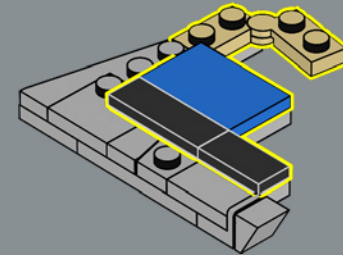

124

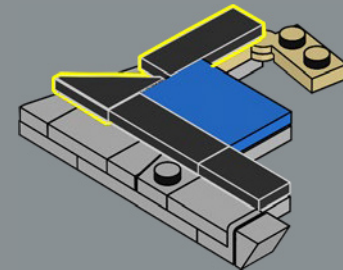

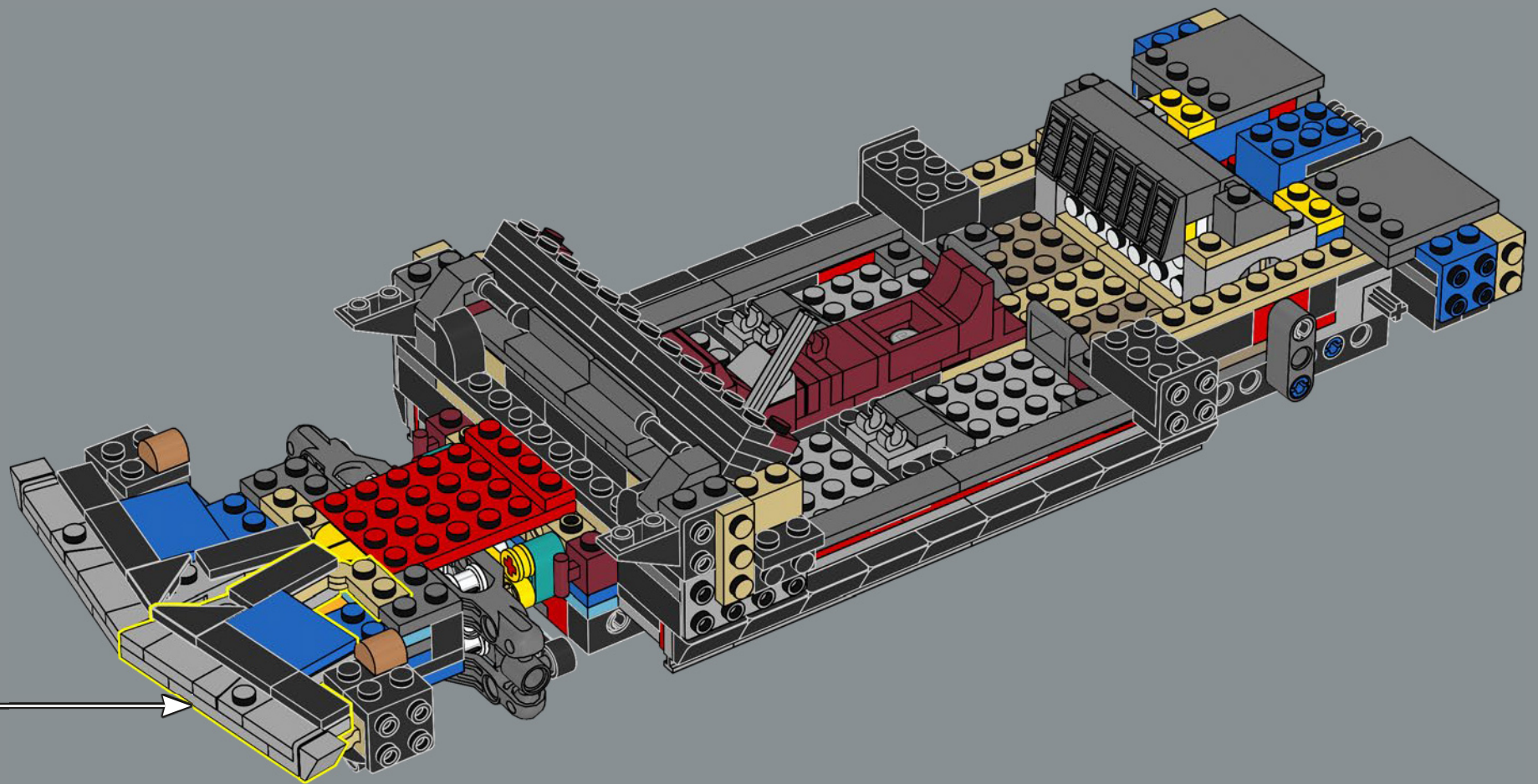

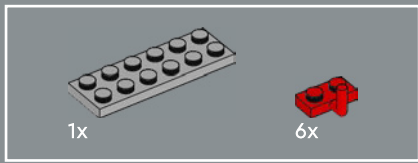

126

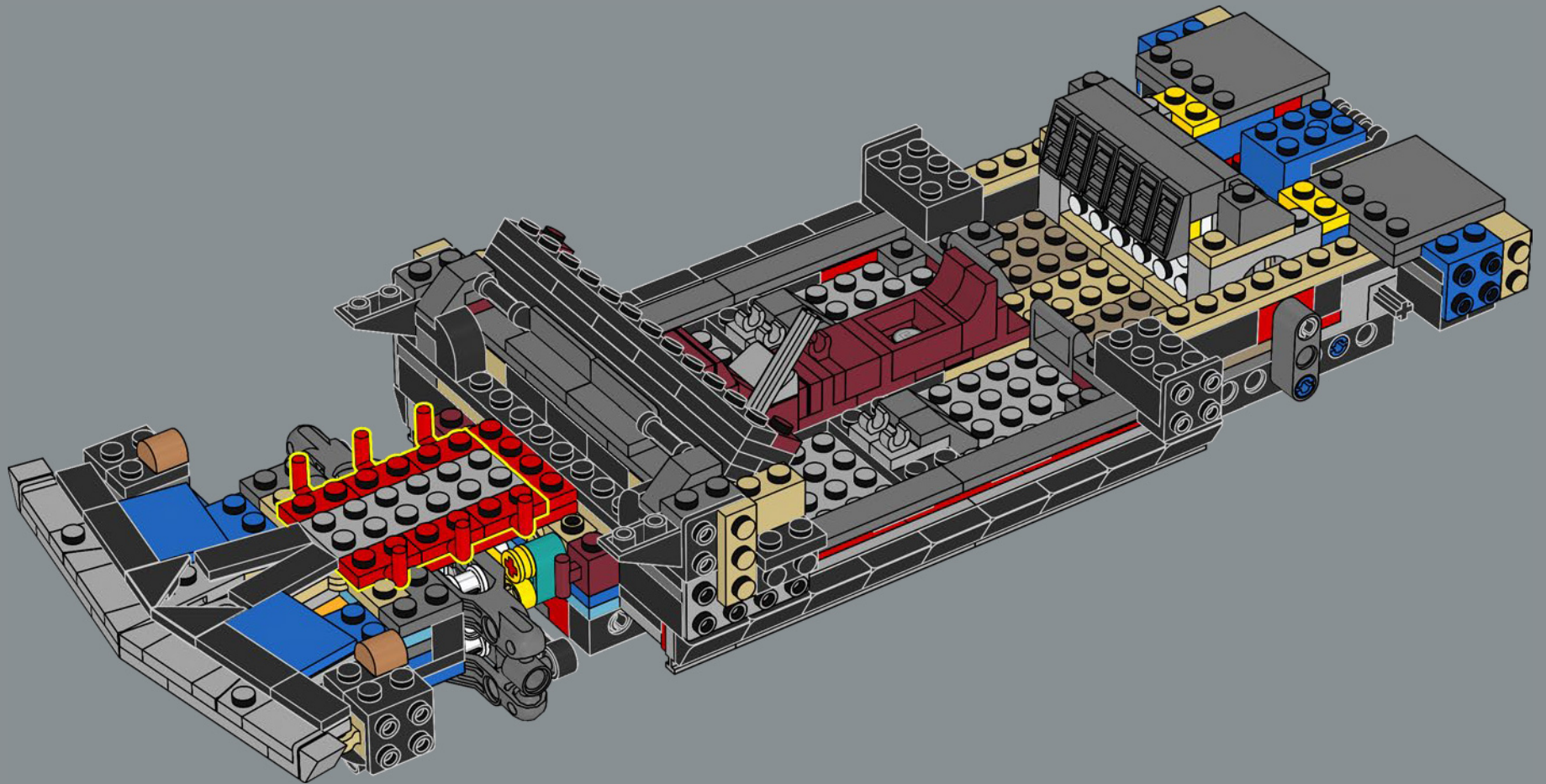

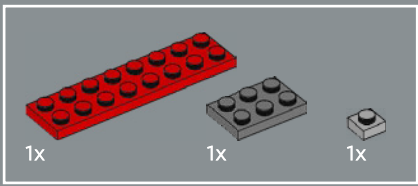

127

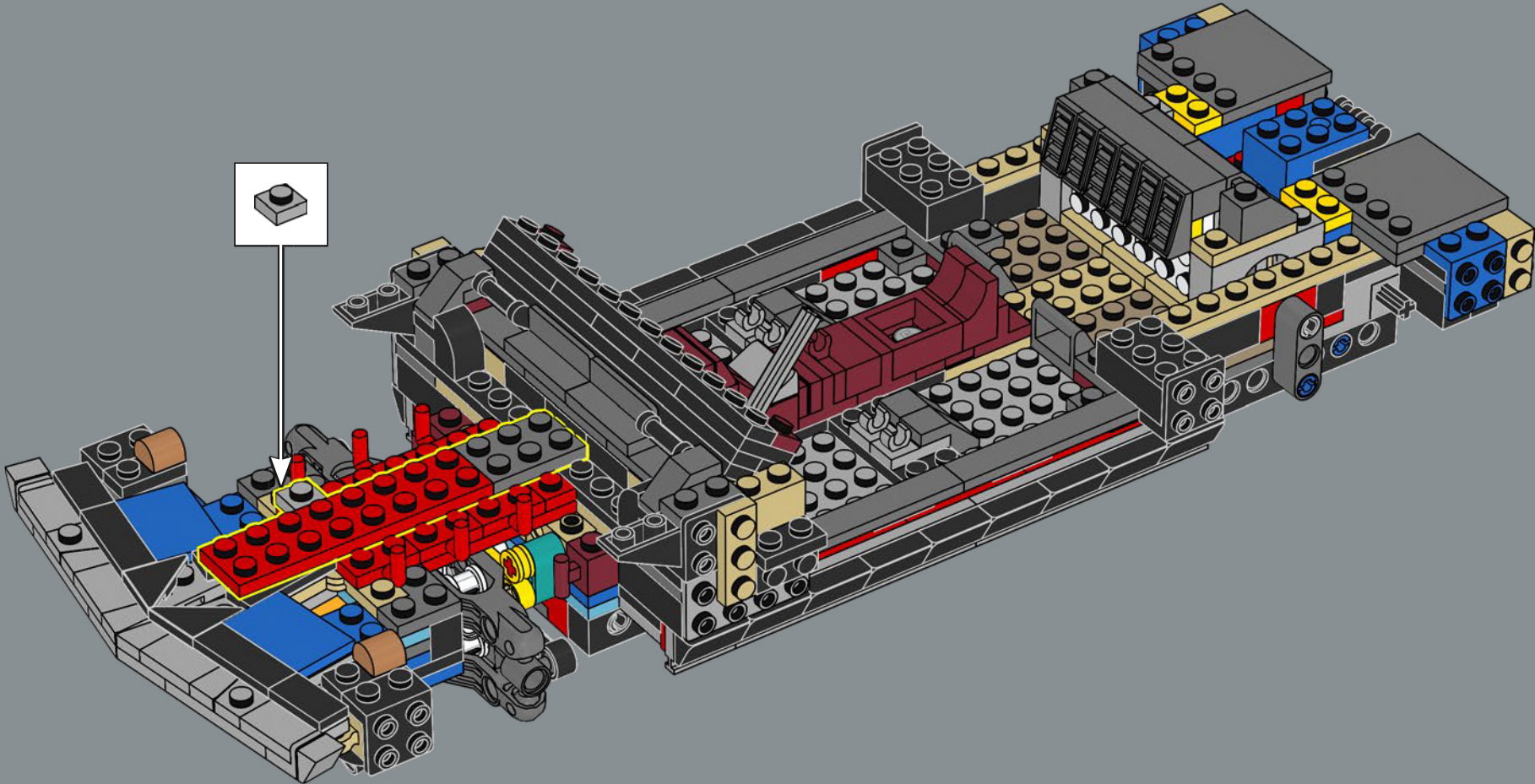

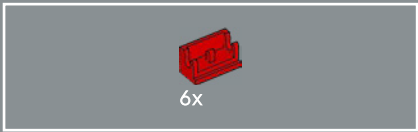

128

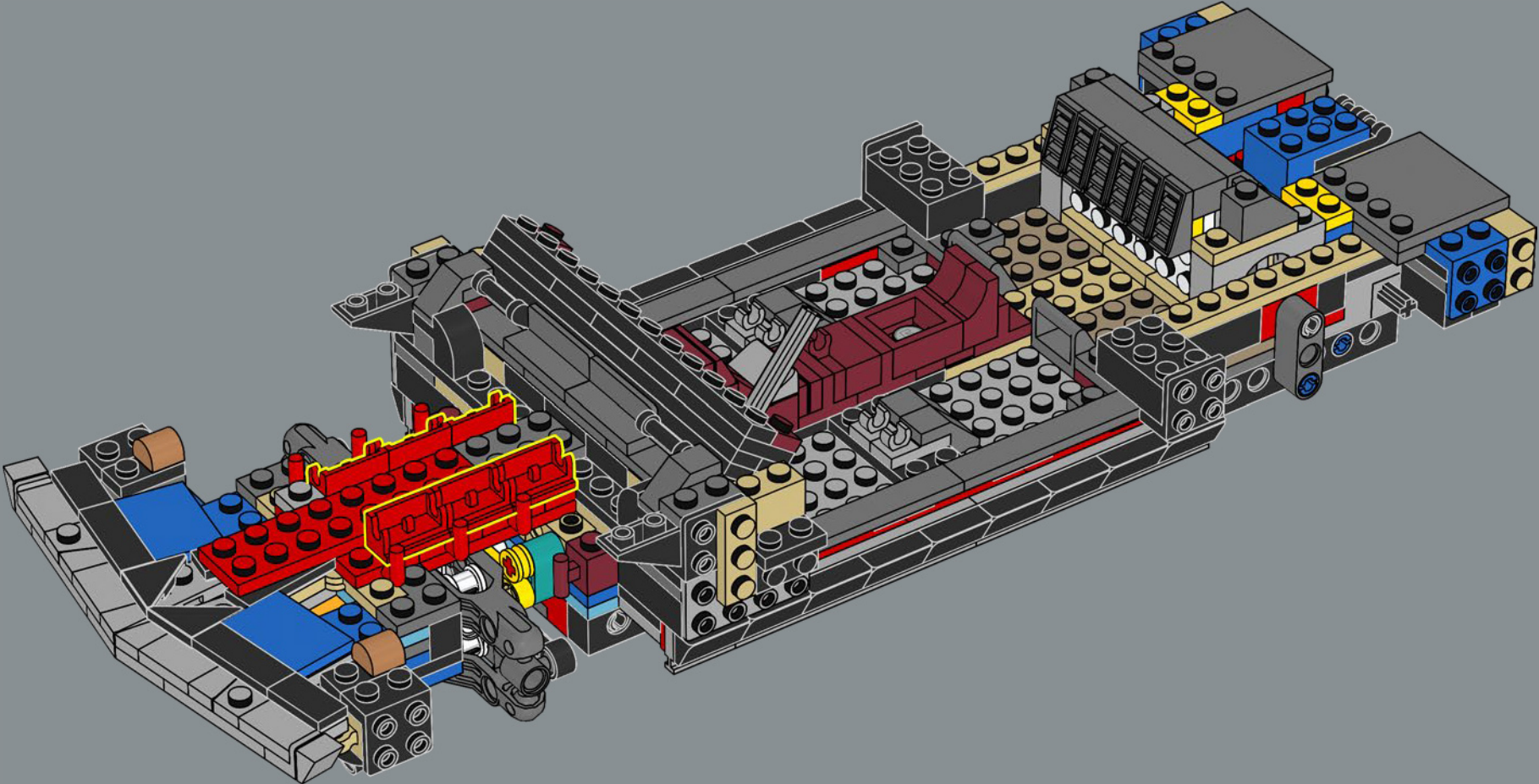

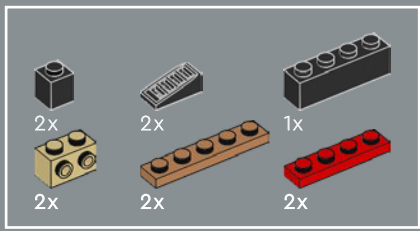

129

1

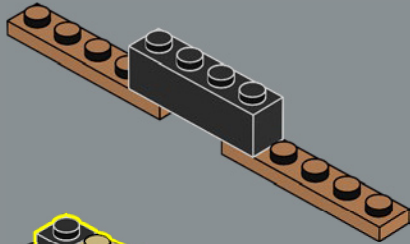

2

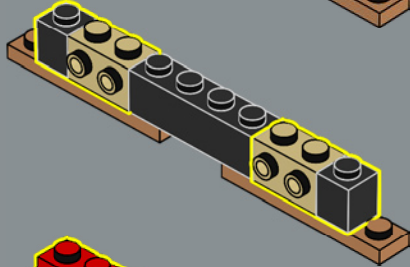

3

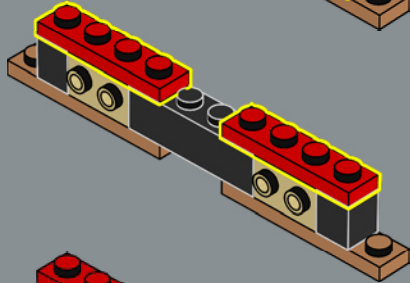

4

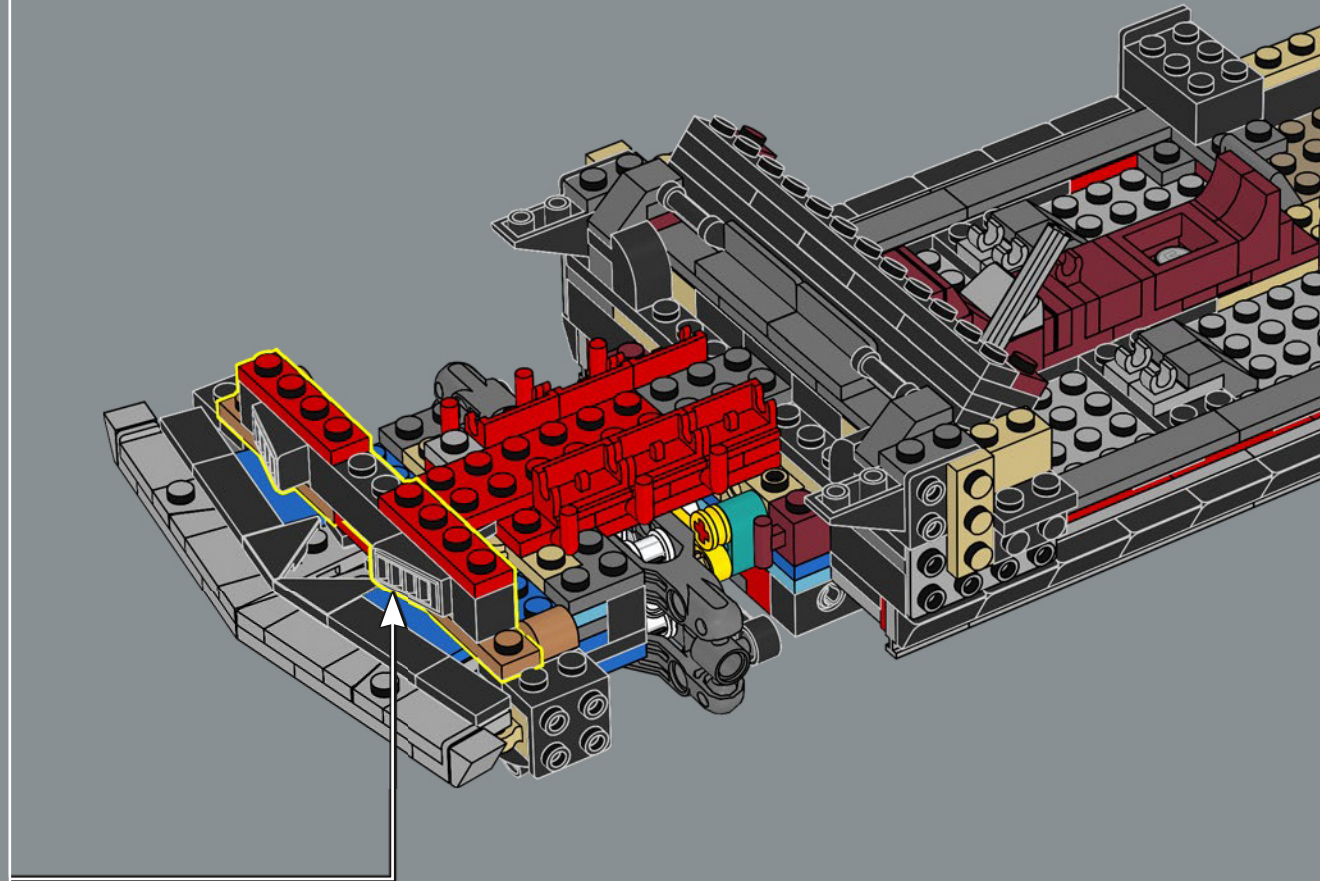
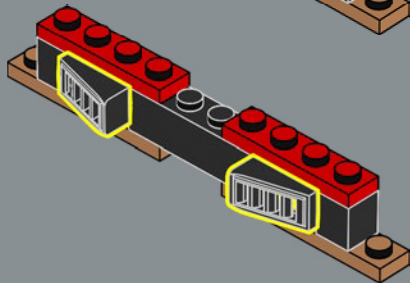



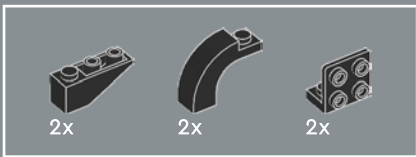

130

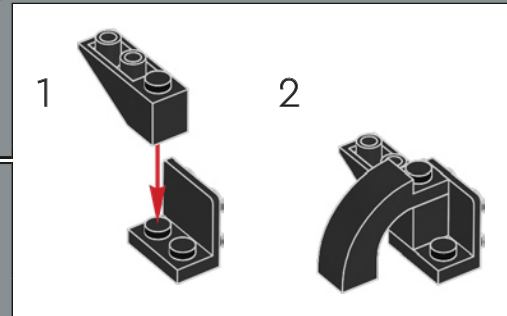
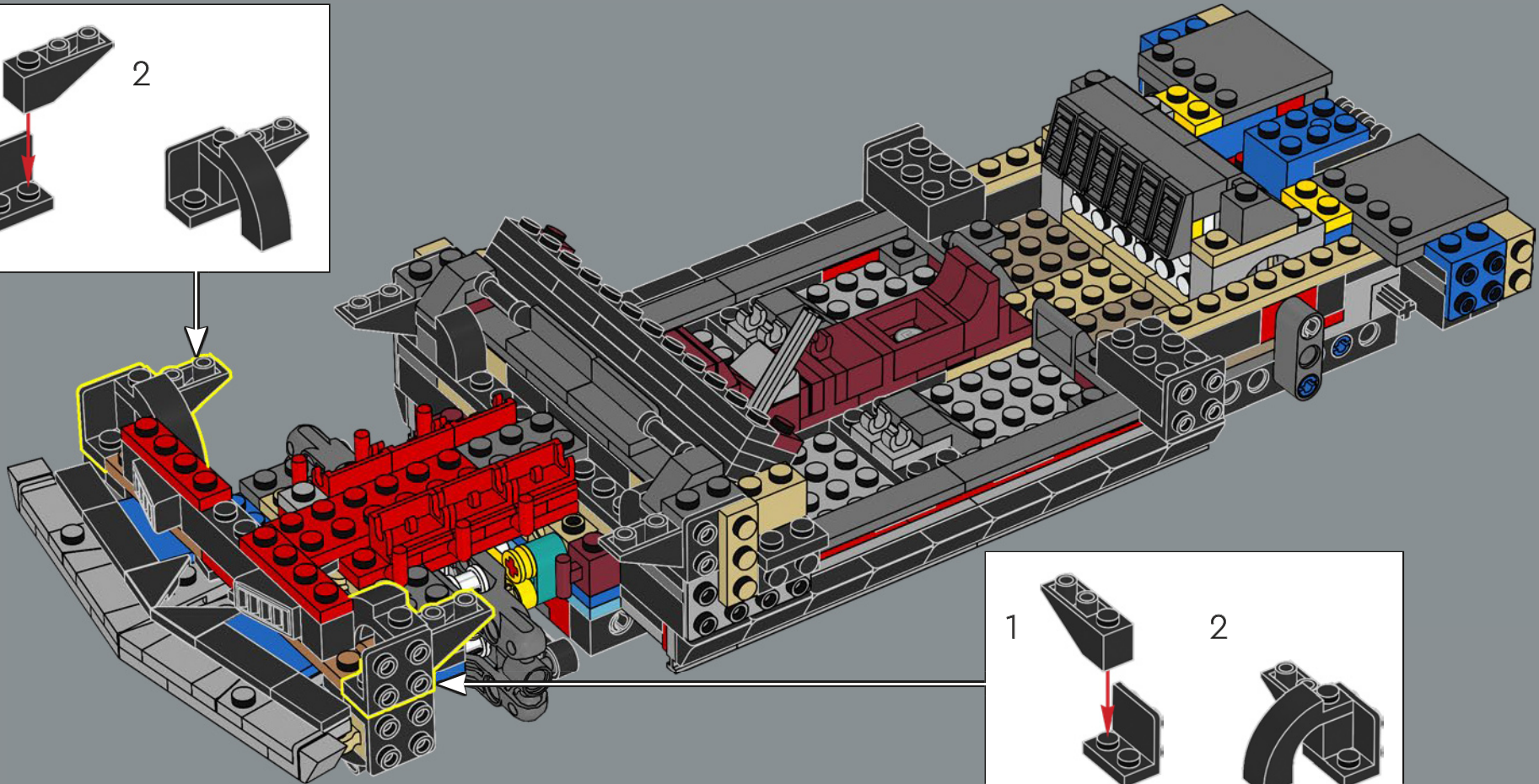
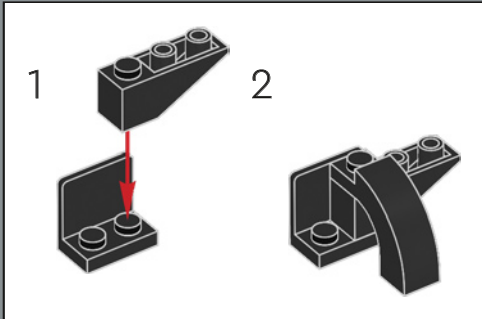

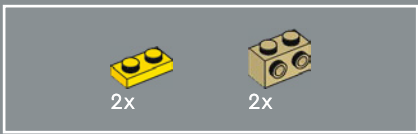

131

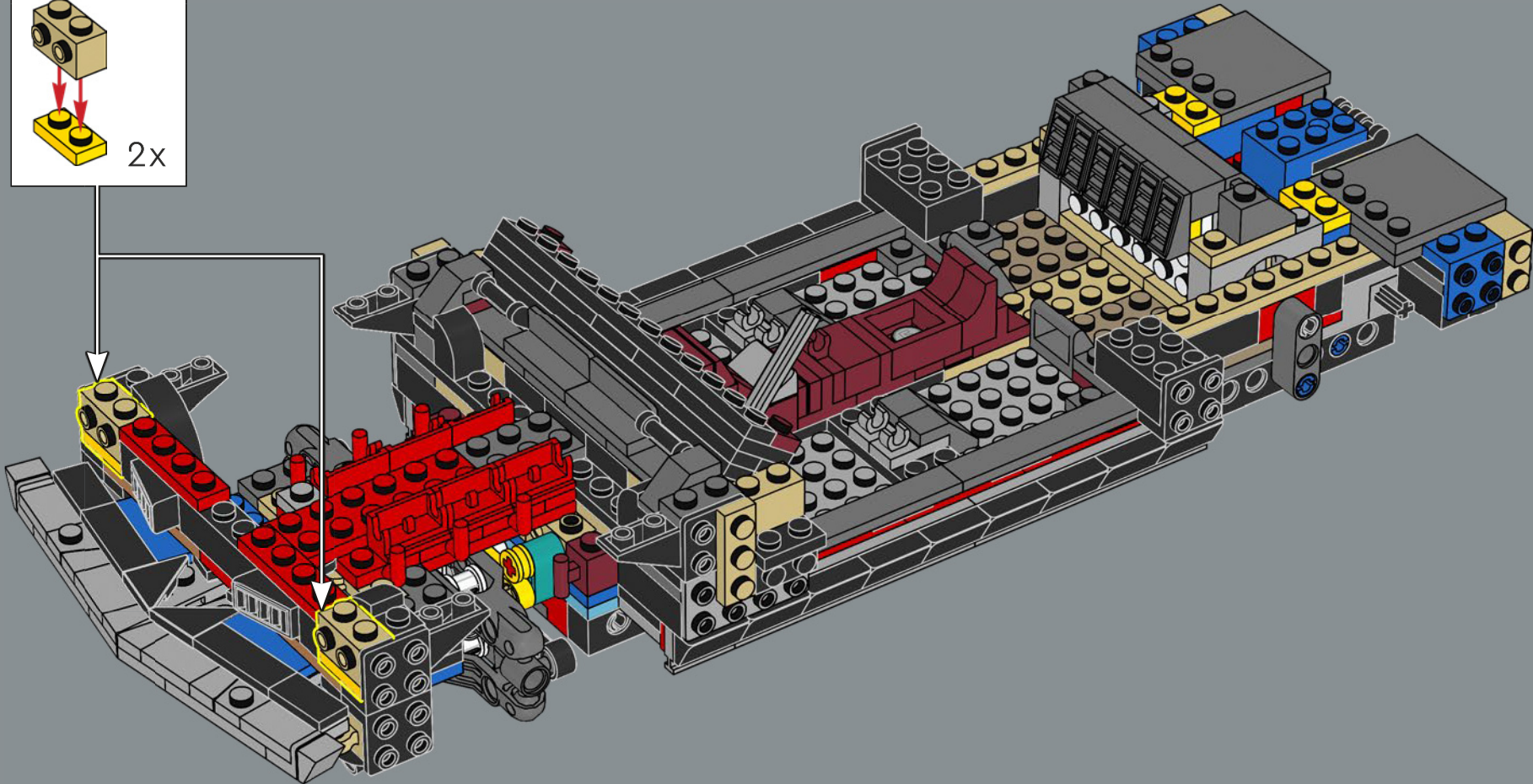
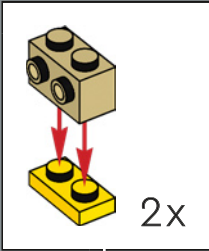

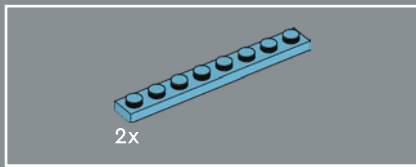

132

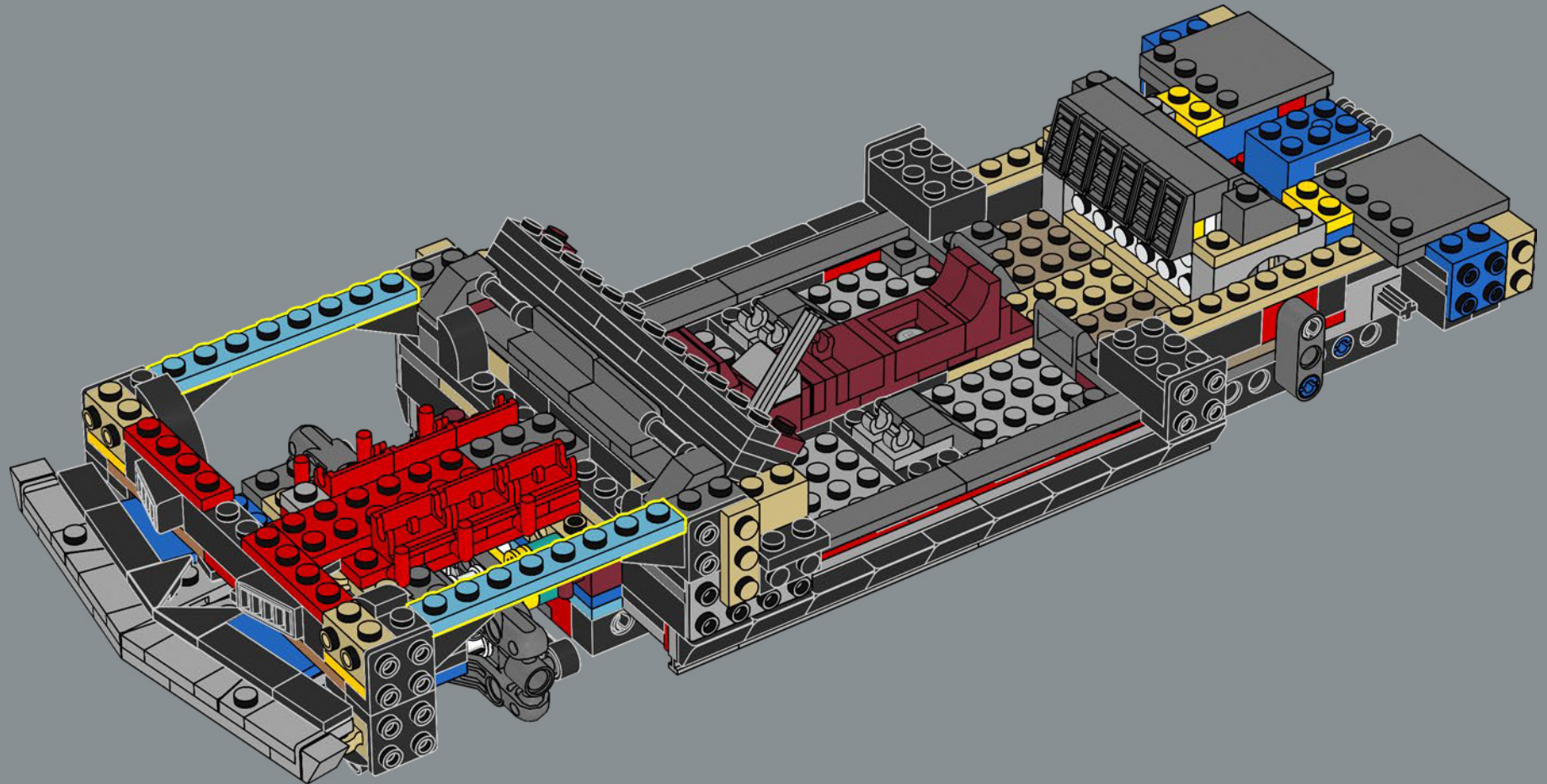

The unveiling of the Chevrolet Camaro to the press in 1966 was the world's first large-scale teleconference, with over 200 journalists joining from 14 US cities.

Le dévoilement de la Chevrolet Camaro à la presse en 1966 a marqué la première téléconférence à grande échelle au monde, avec plus de 200 journalistes venus de 14 villes américaines.

La presentación del Chevrolet Camaro ante la prensa en 1966 fue la primera teleconferencia a gran escala del mundo. Más de 200 periodistas de 14 ciudades estadounidenses participaron en ella.



133

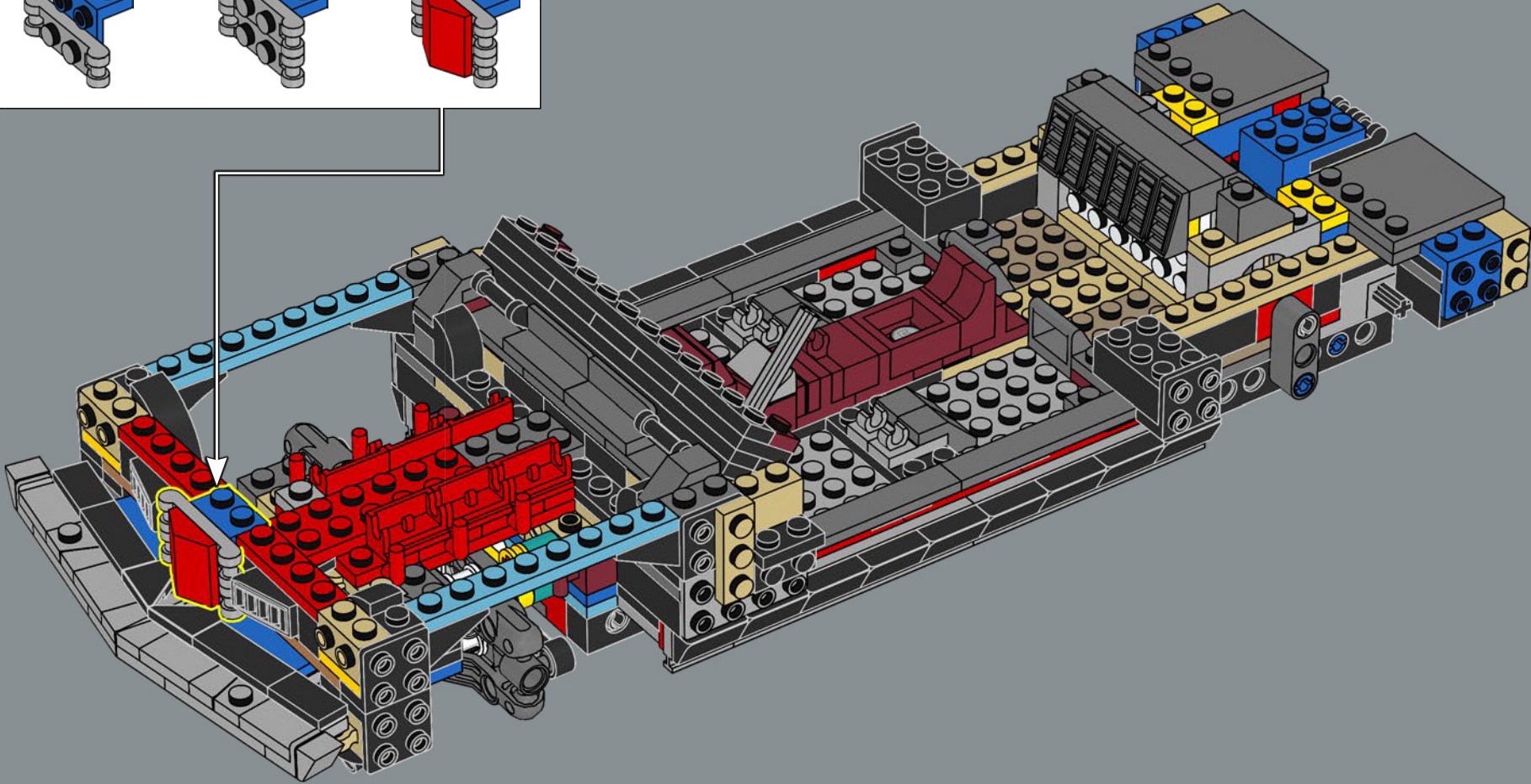
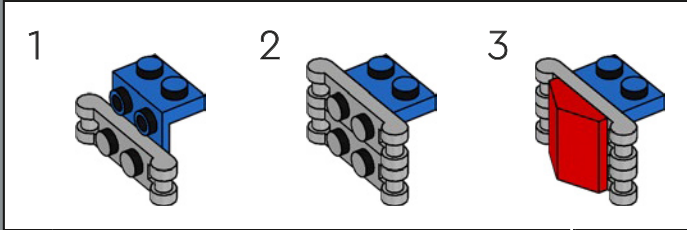



134

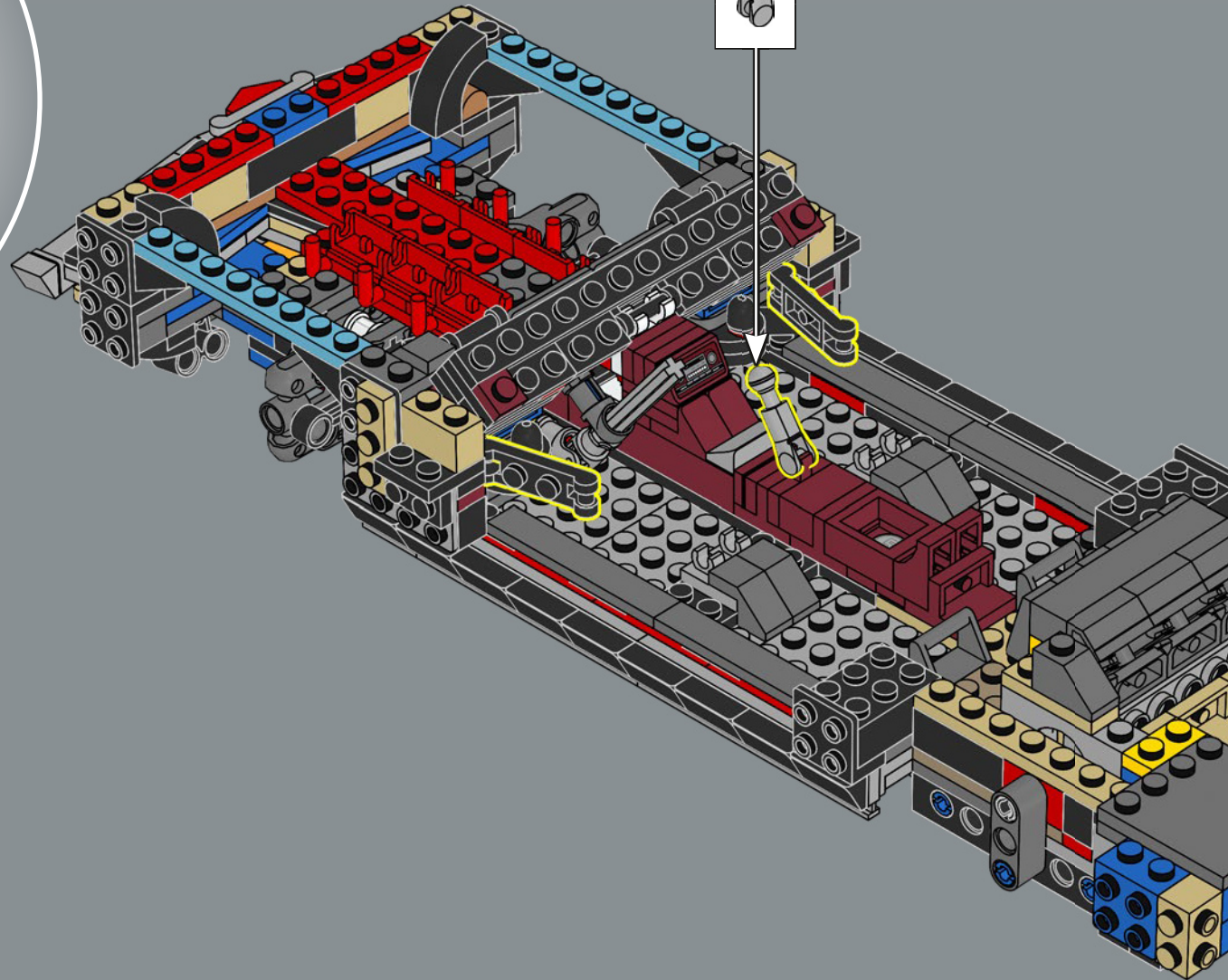
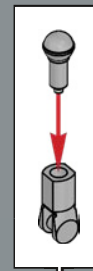

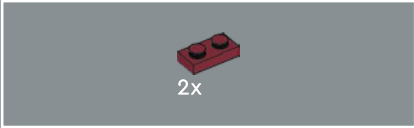
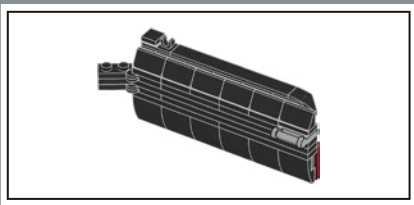

135

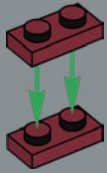

136

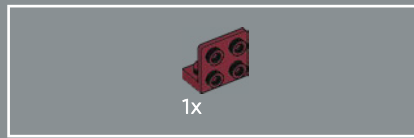

137

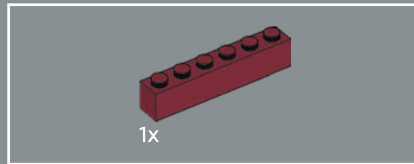
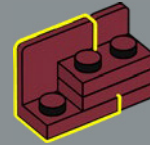

138

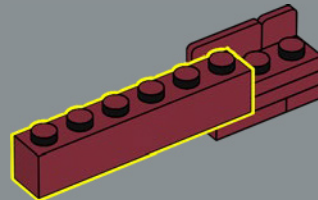

139

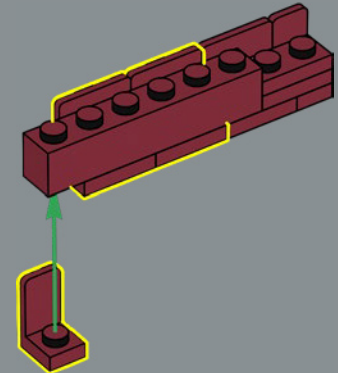



140

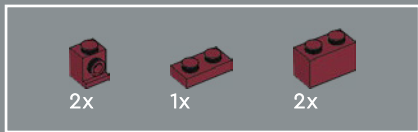
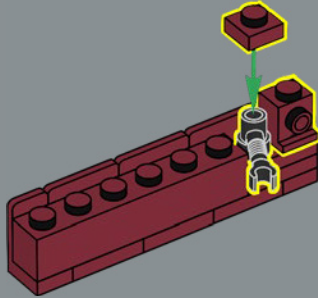

141

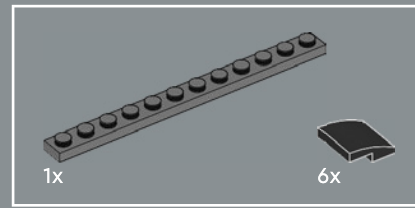
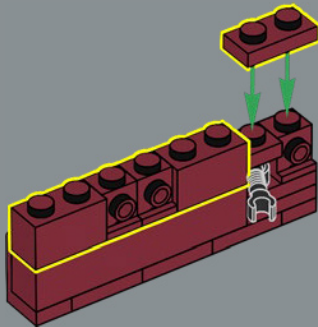

142

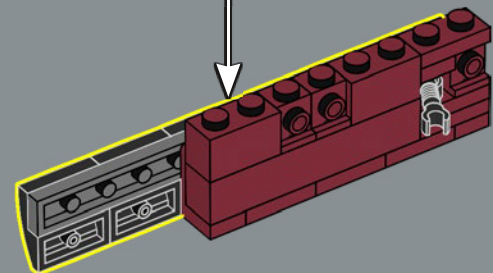
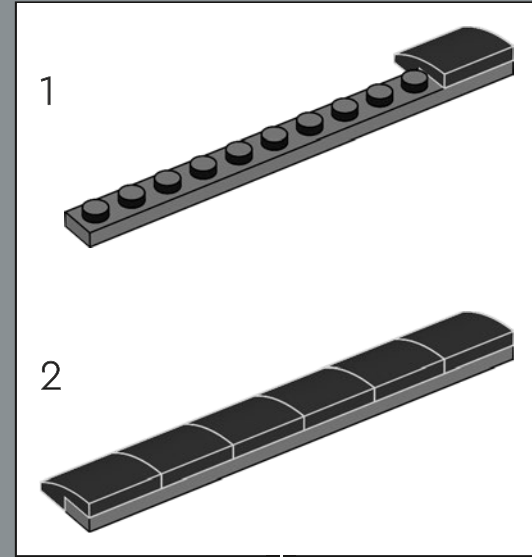

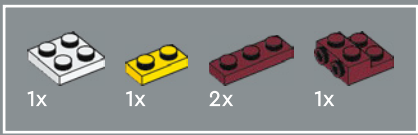

143

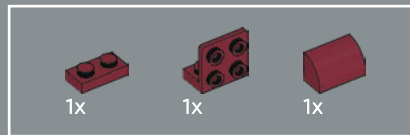
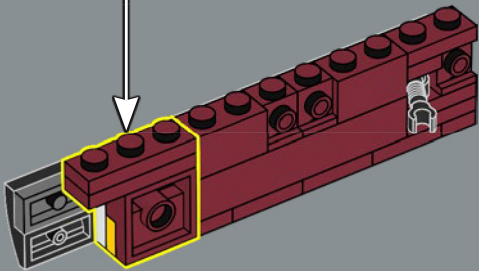
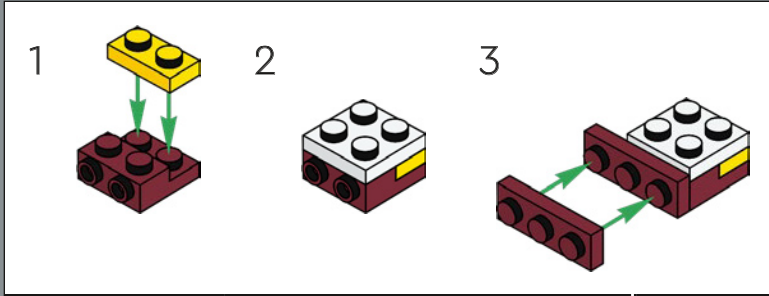

144

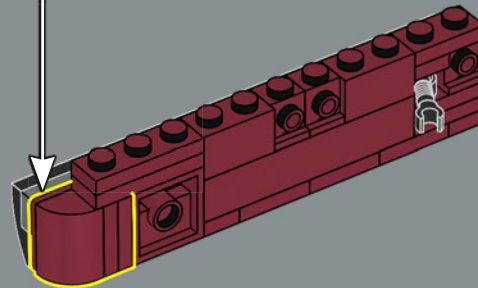
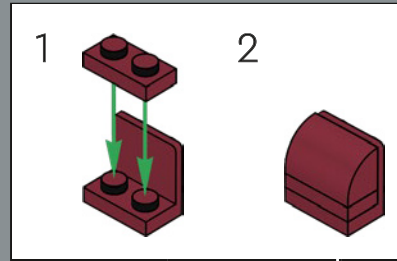



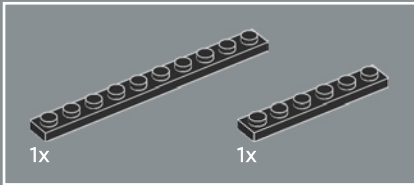
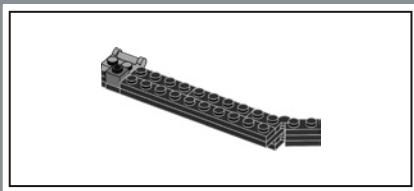

145

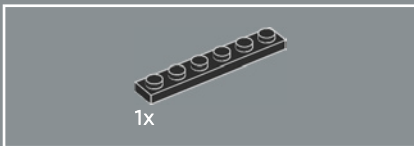
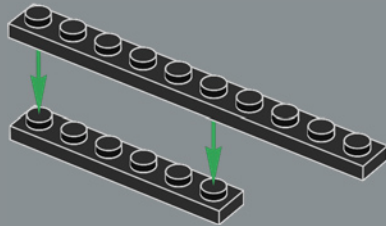

146

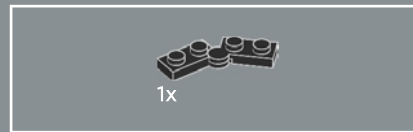
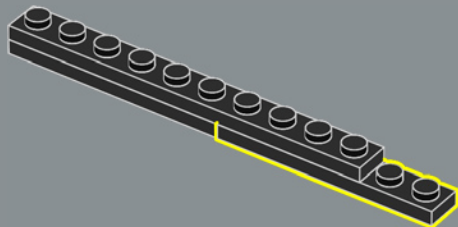

147

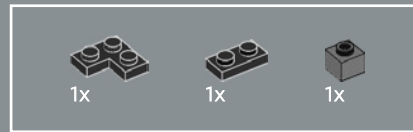
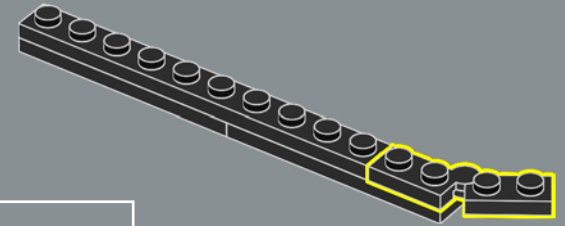

148

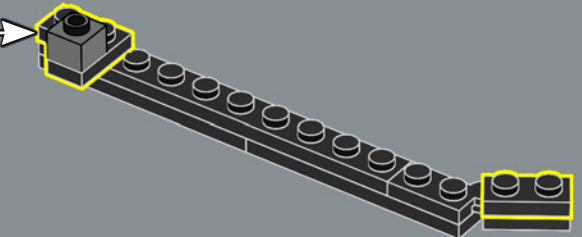
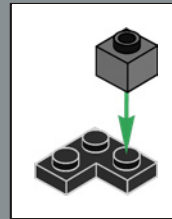

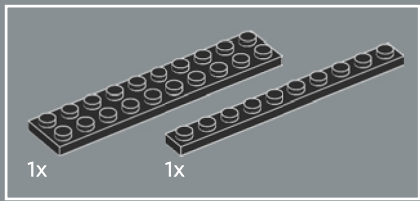

149

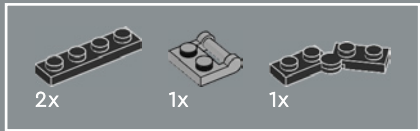
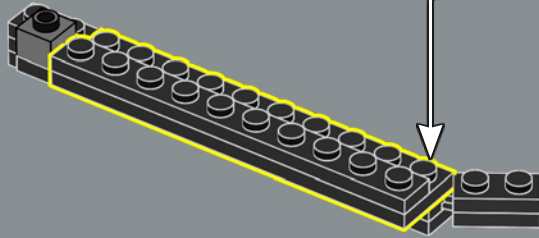
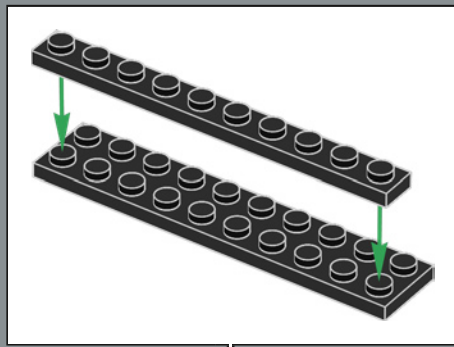

150

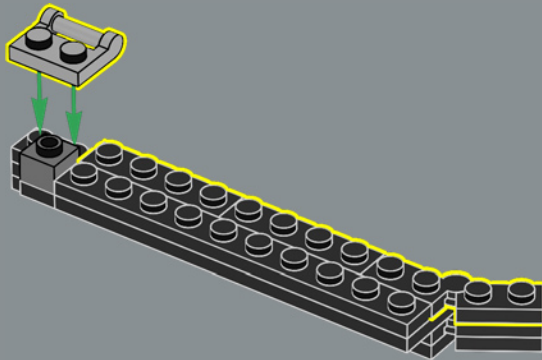

151

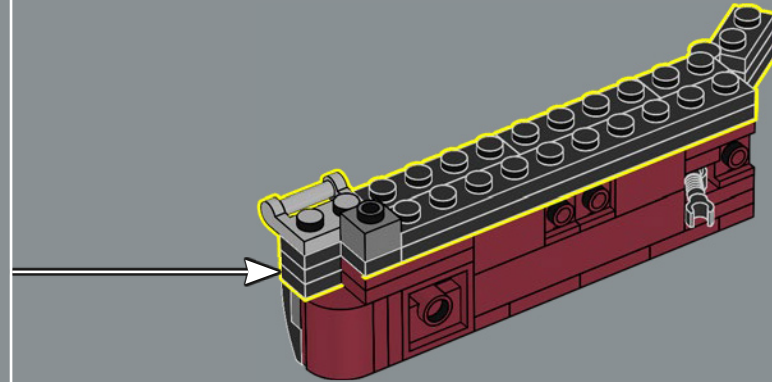



152

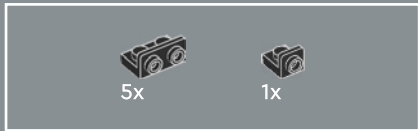
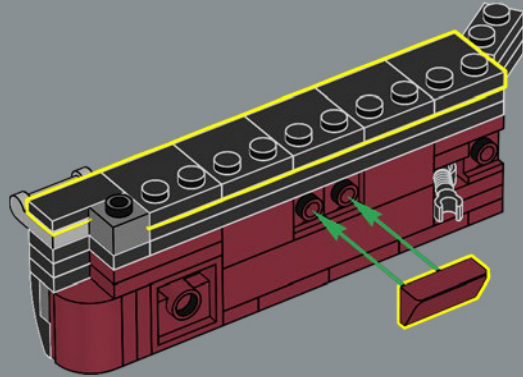

153

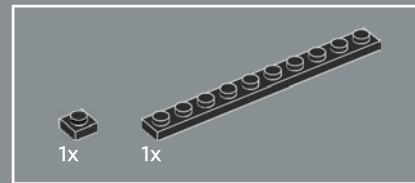
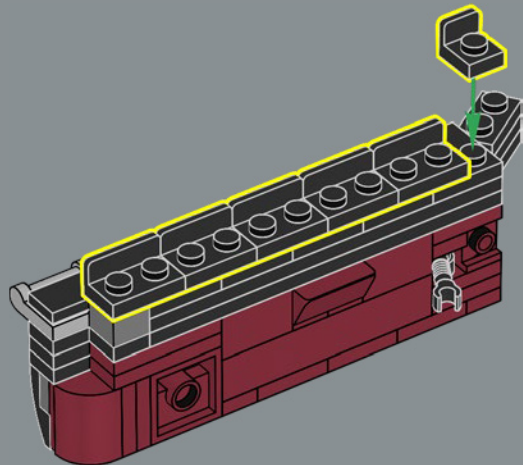

154

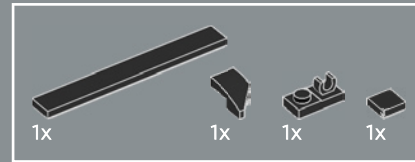
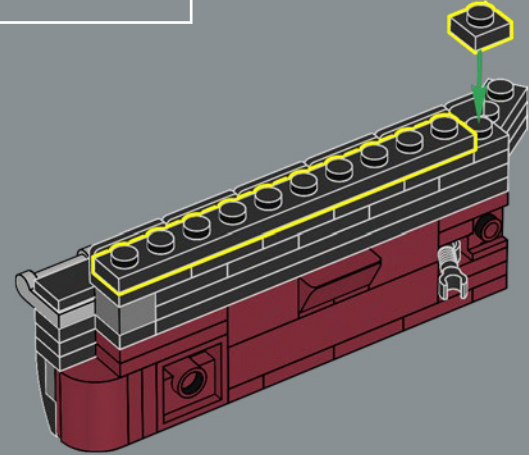

155

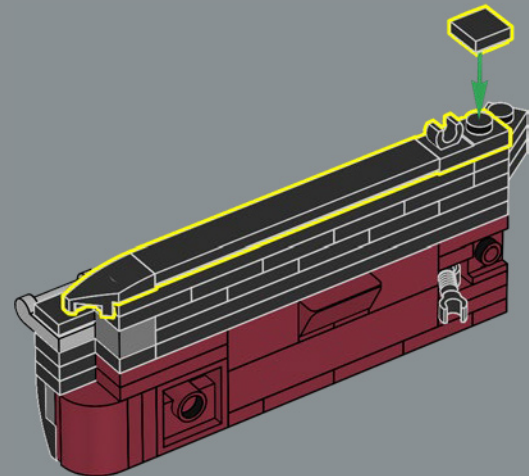



6x

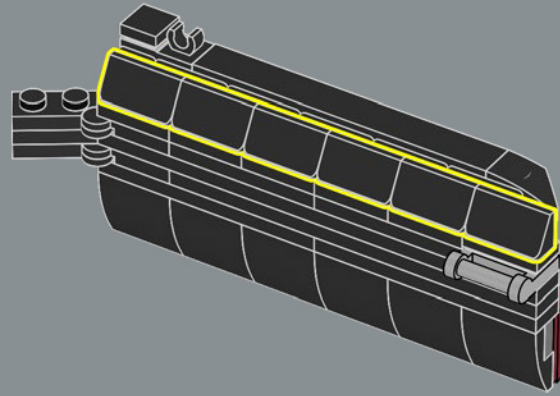

156

157

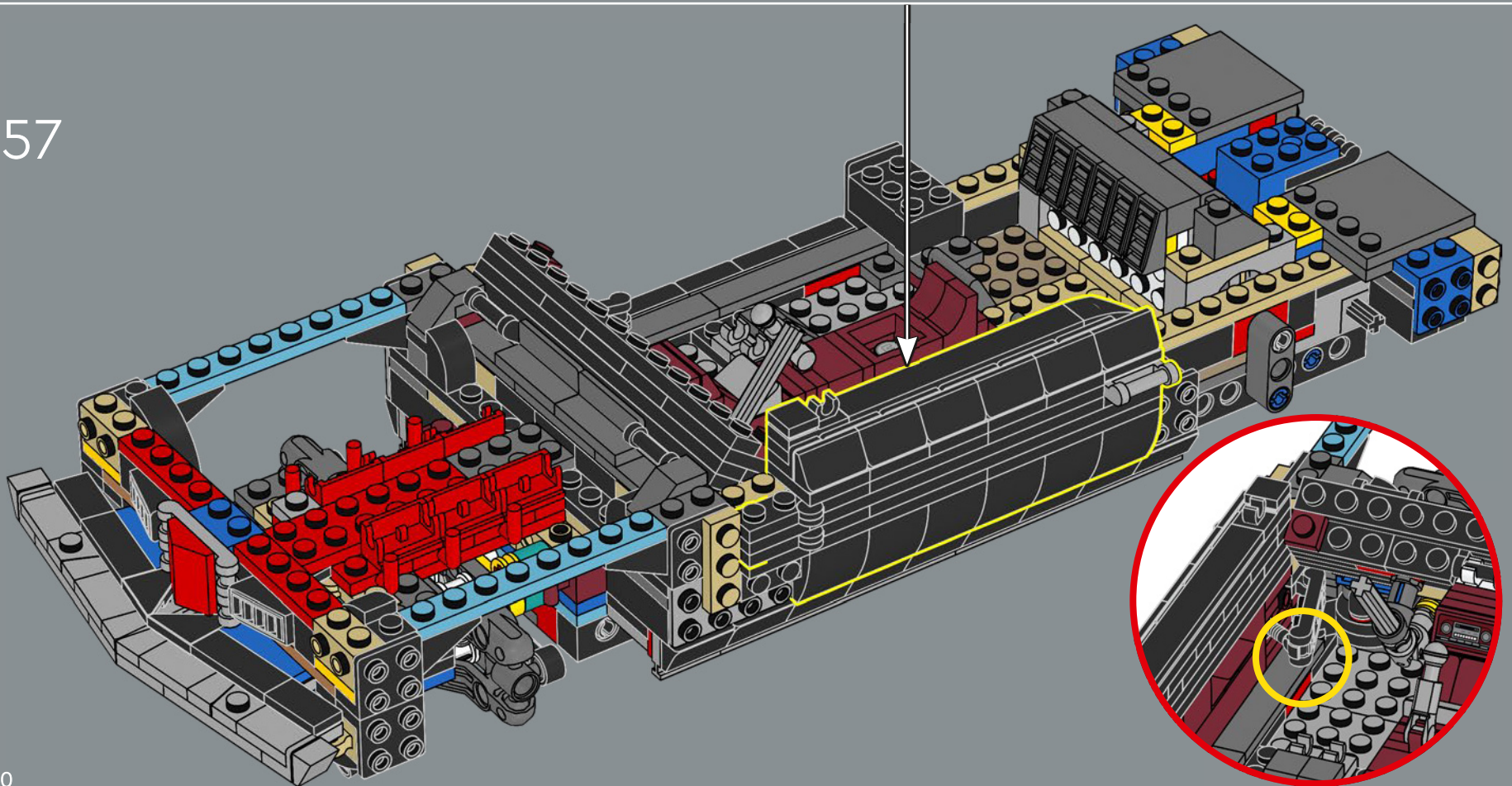



158

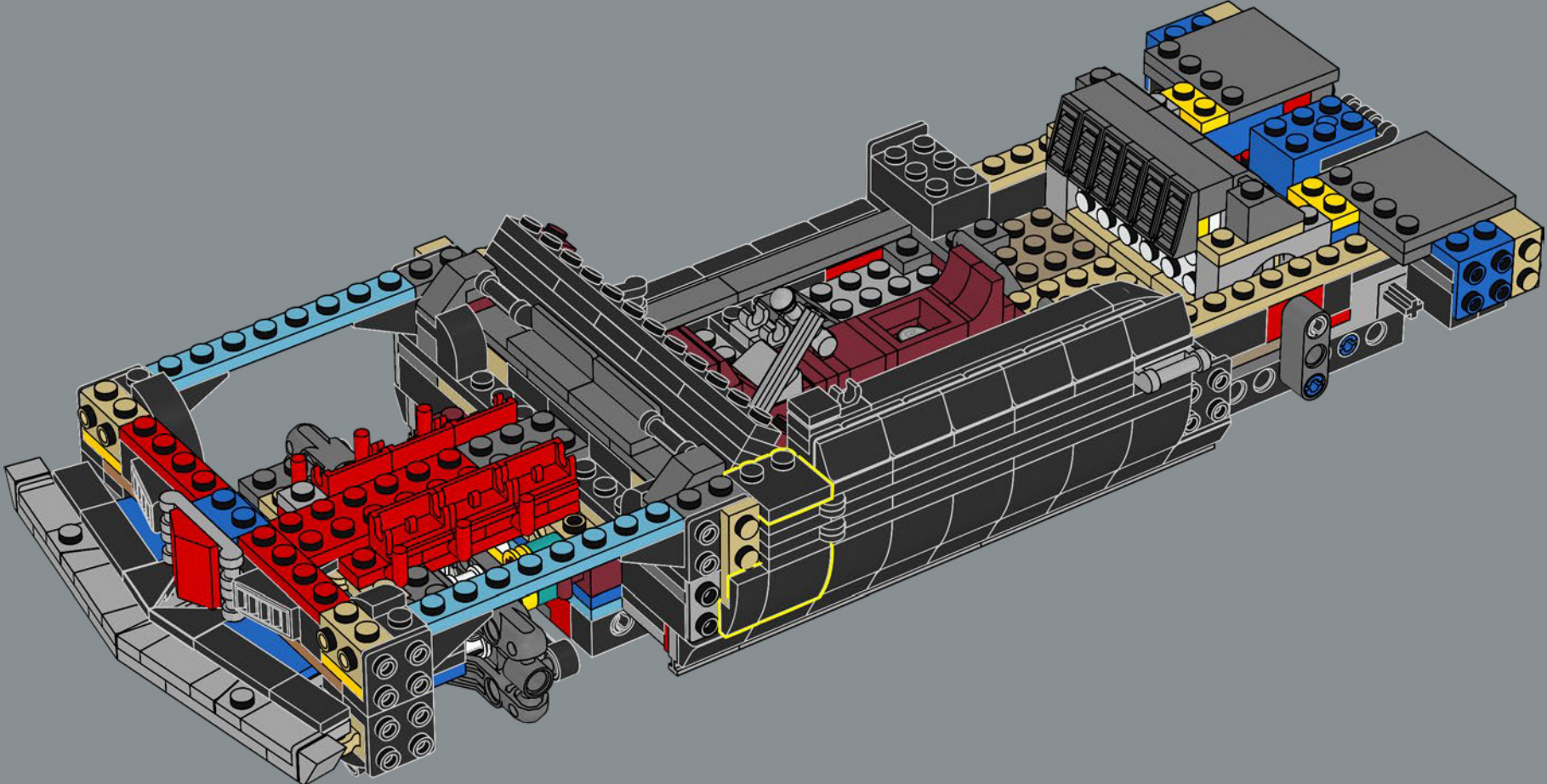

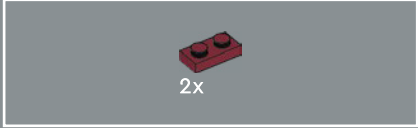
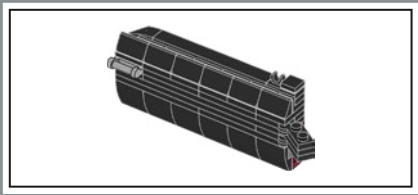

159

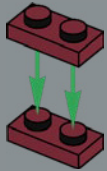

160

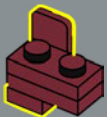

161

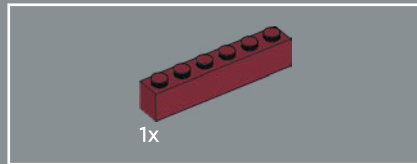
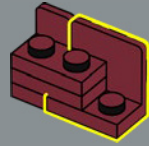

162

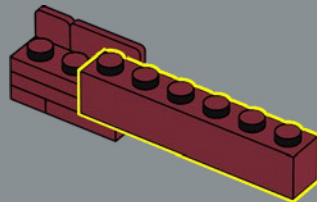

163

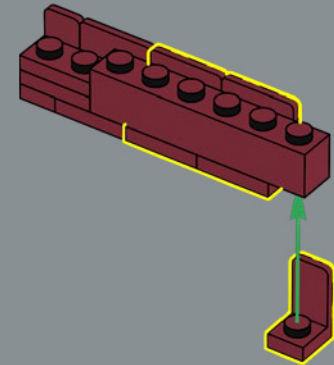



164

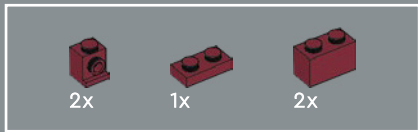
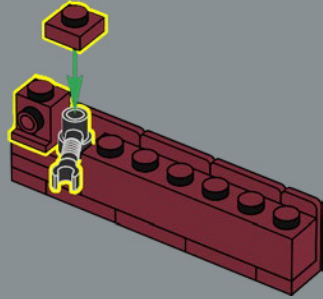

165

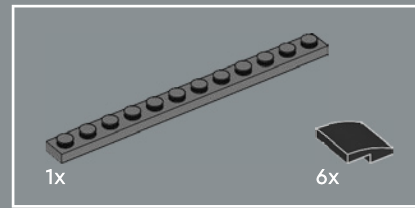
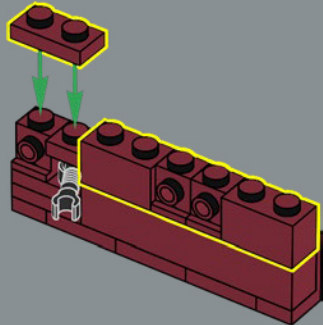

166

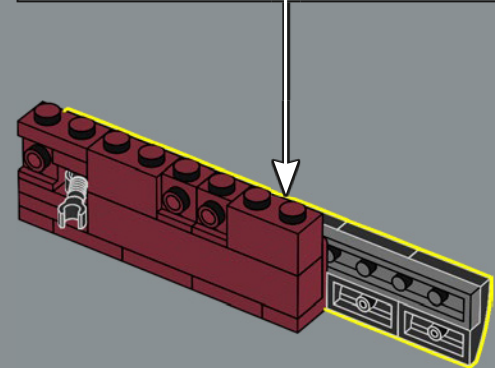
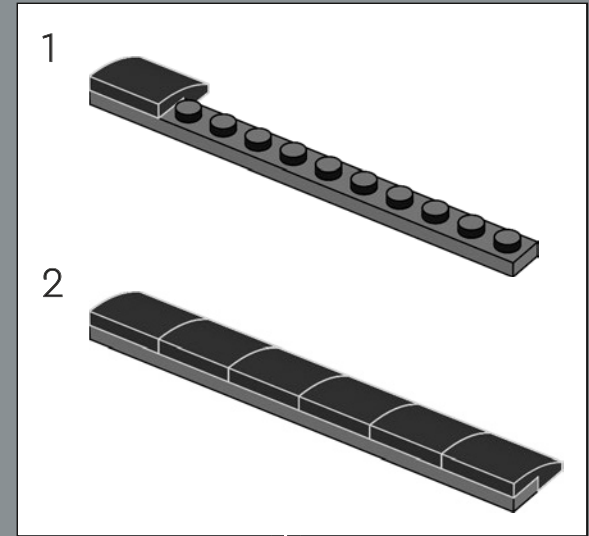

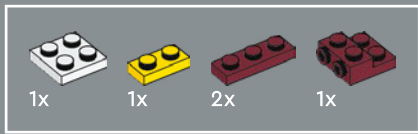

167

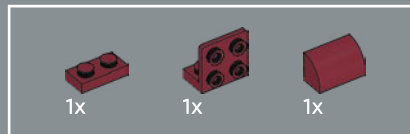
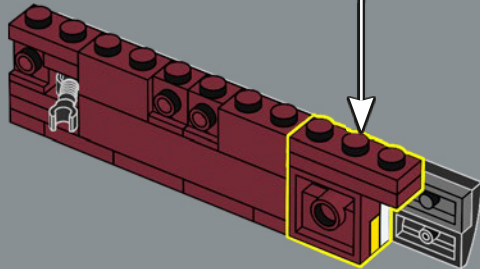
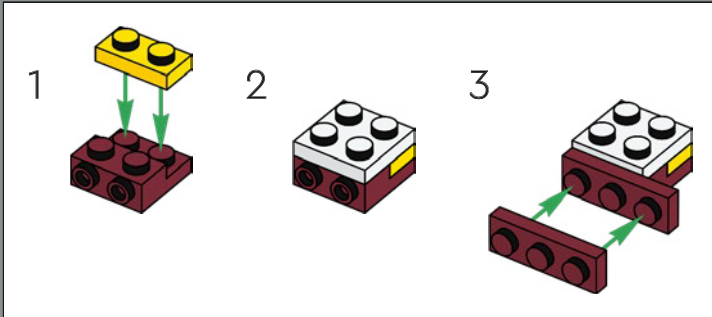

168

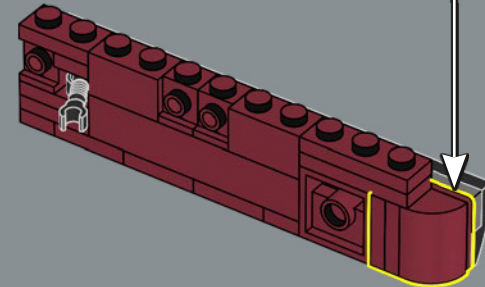
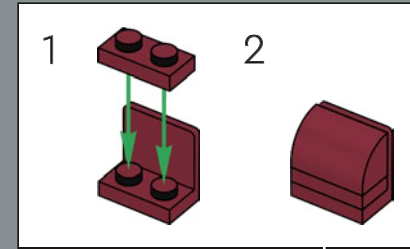



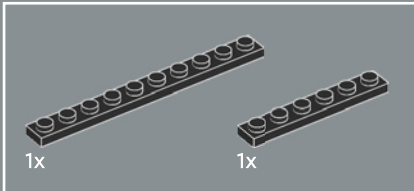
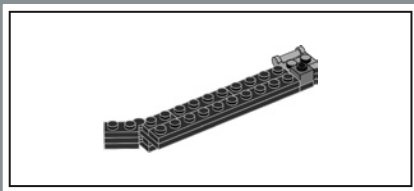

169

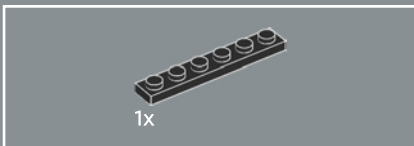
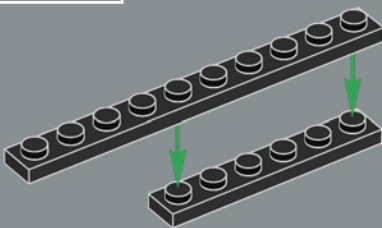

170

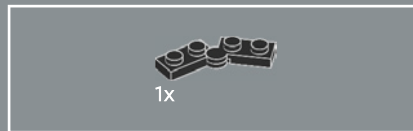
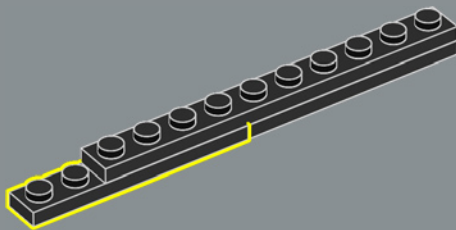

171

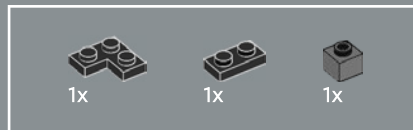
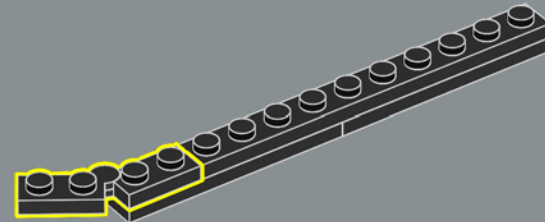

172

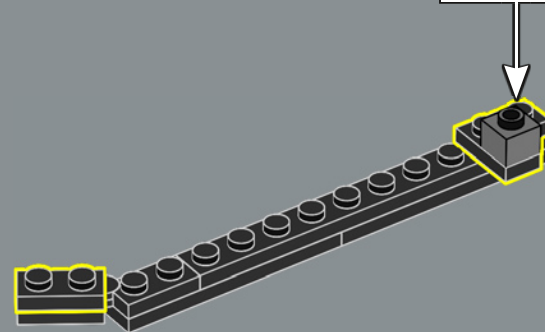
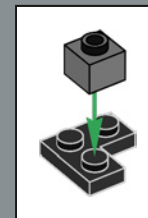

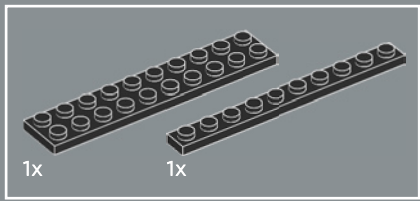

173

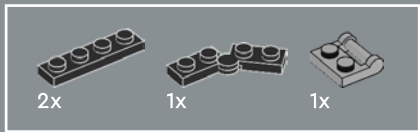
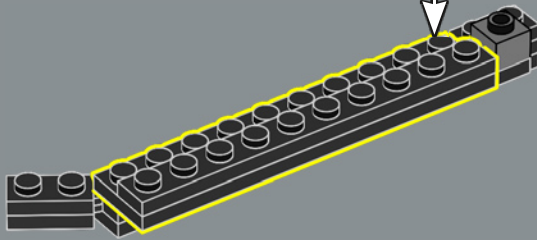
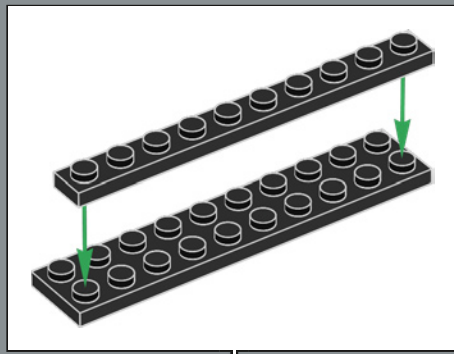

174

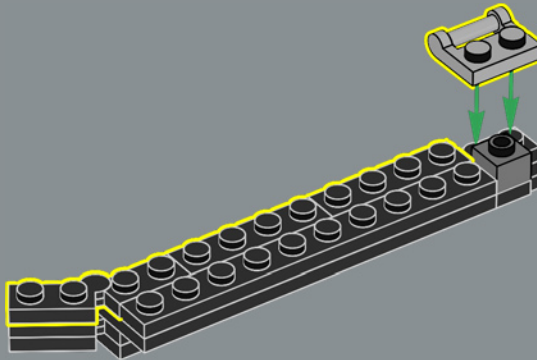

175

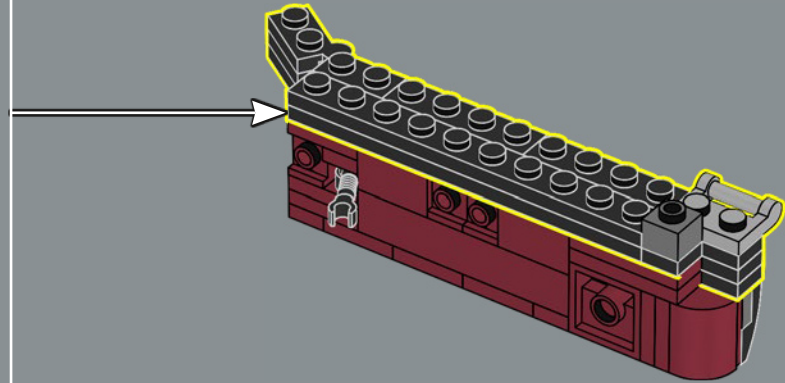

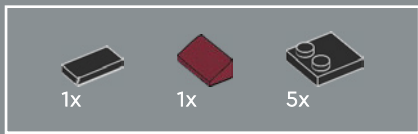

176

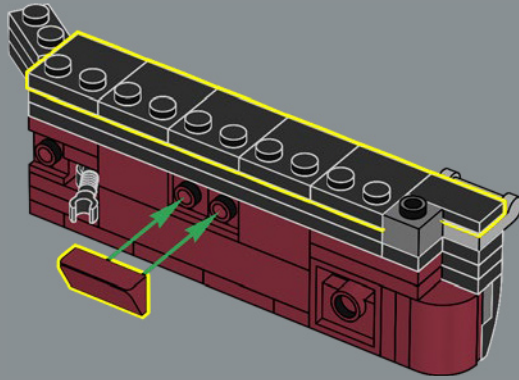

177

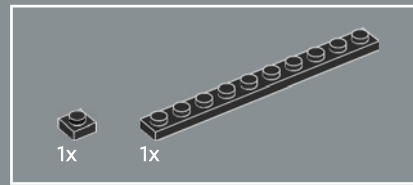
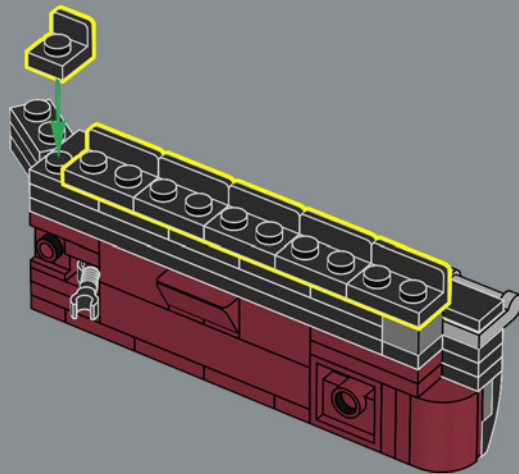

178

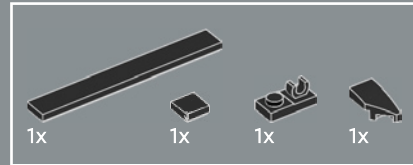
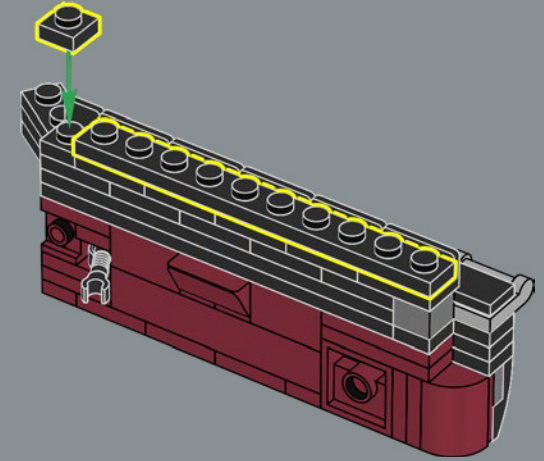

179

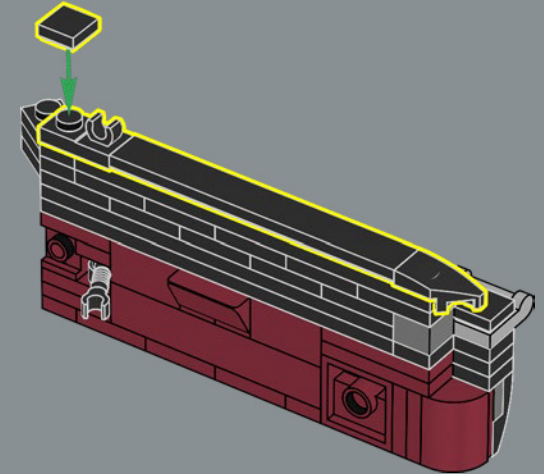



6x

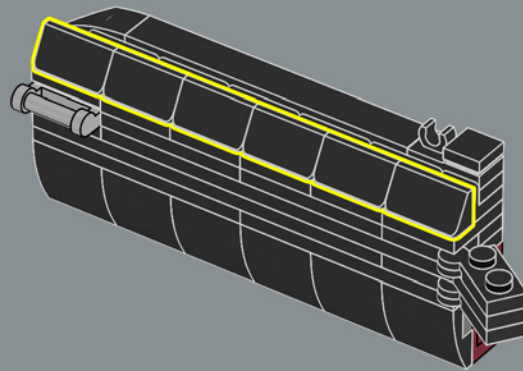

180

181

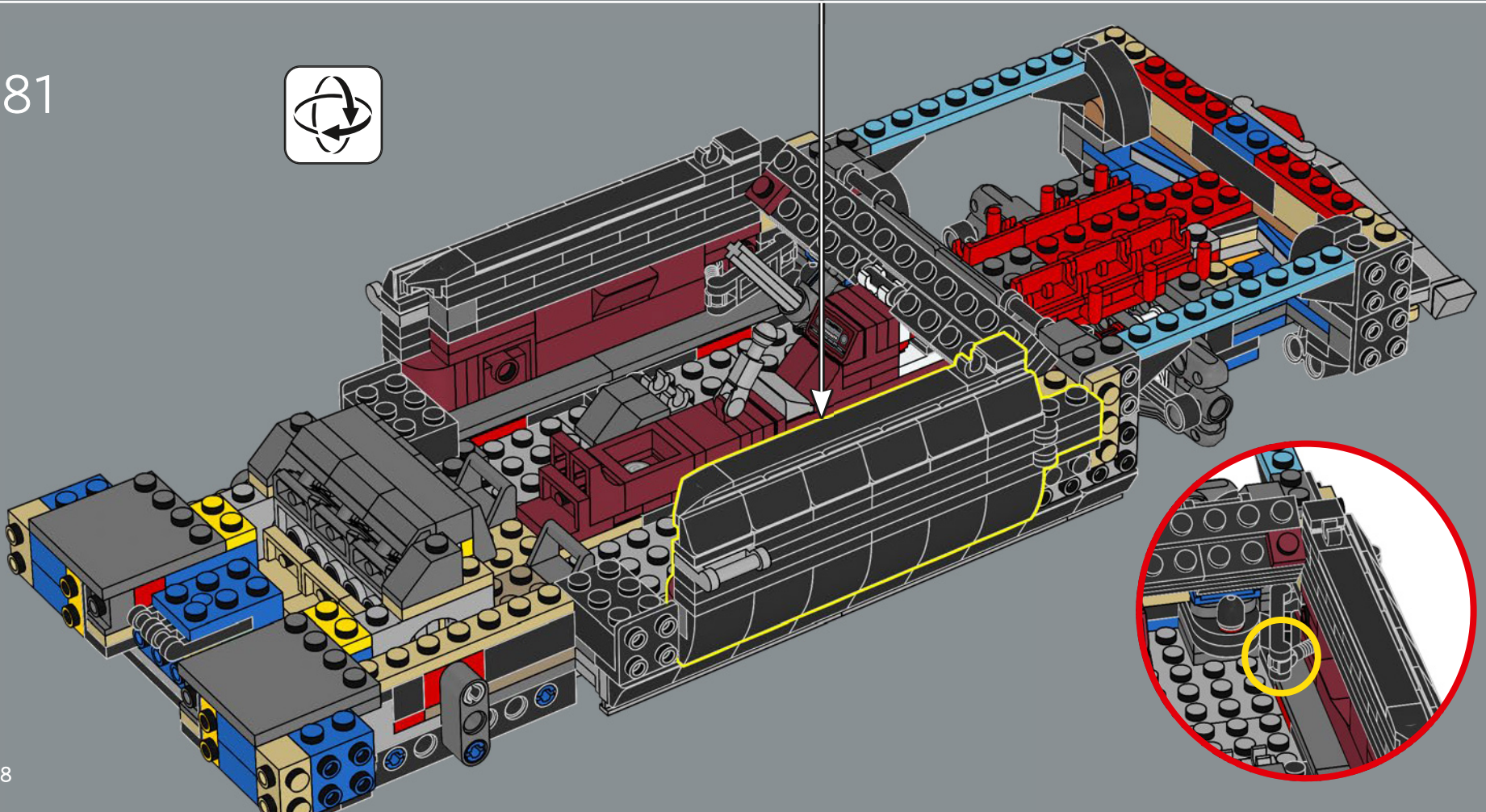



182

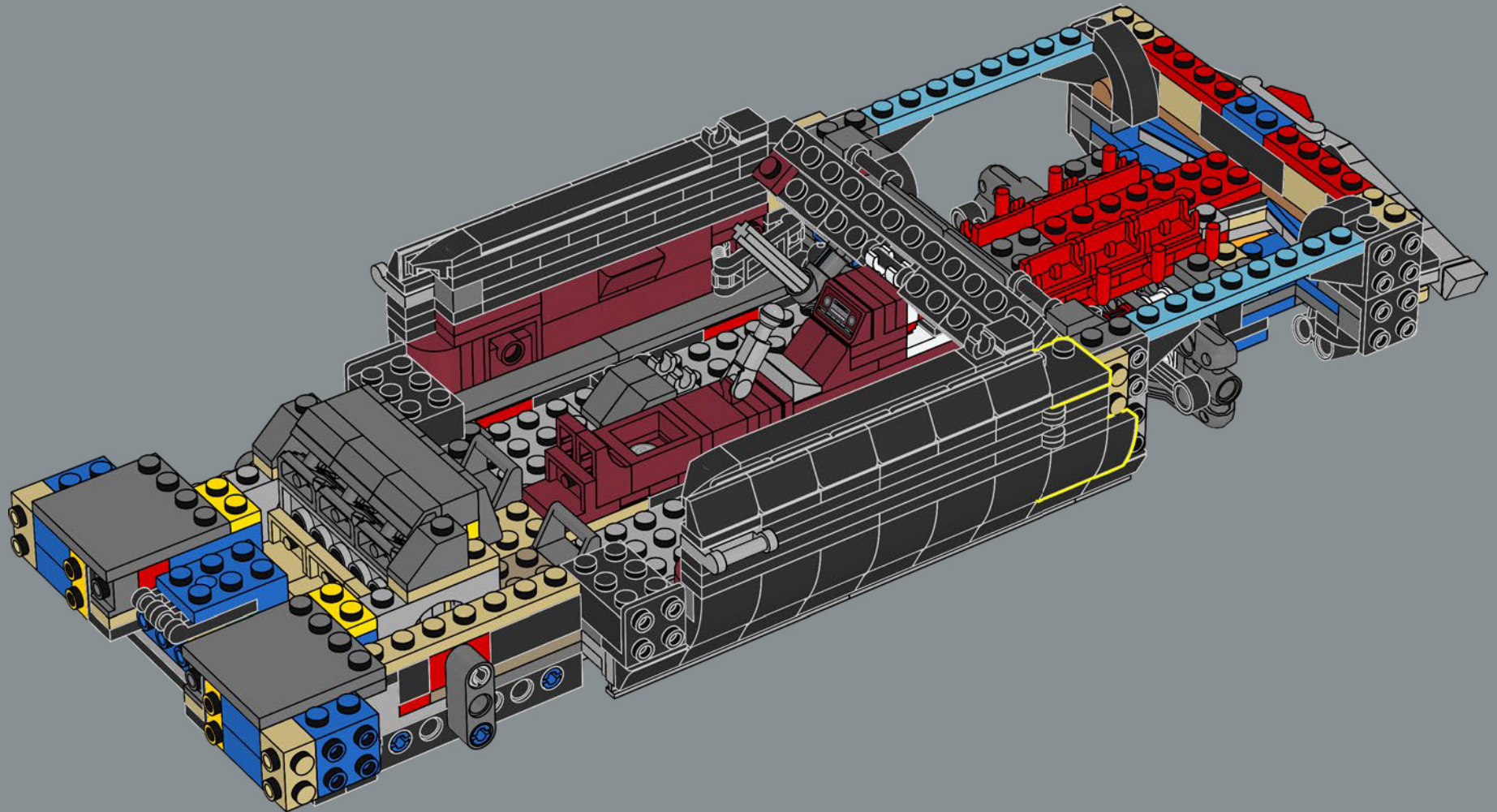

Between all the models and packages, original Camaro buyers had 80 different factory options to choose from.

Avec tous les modèles et les compléments, la Camaro d'origine proposait aux acheteurs 80 options d'usine différentes.

Sumando todos los modelos y paquetes, los compradores del Camaro original podían elegir entre 80 opciones de fábrica diferentes.

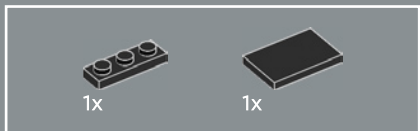

183

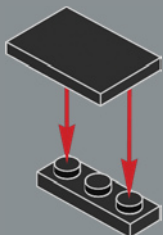

184

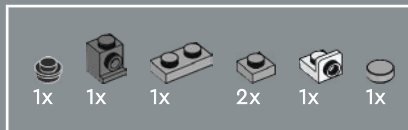
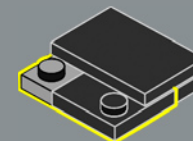

185

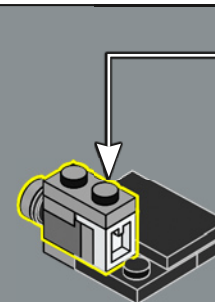
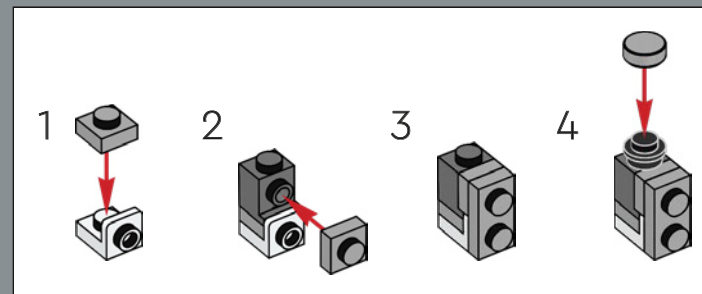

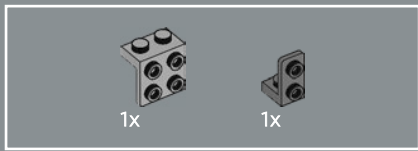

186

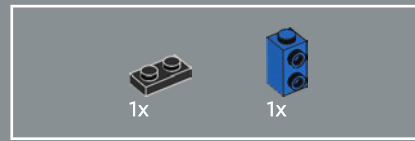
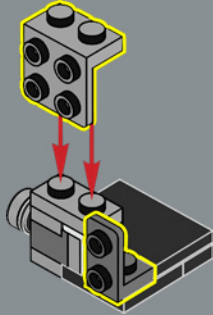

187

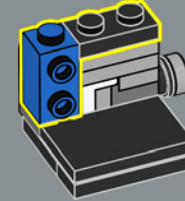

188

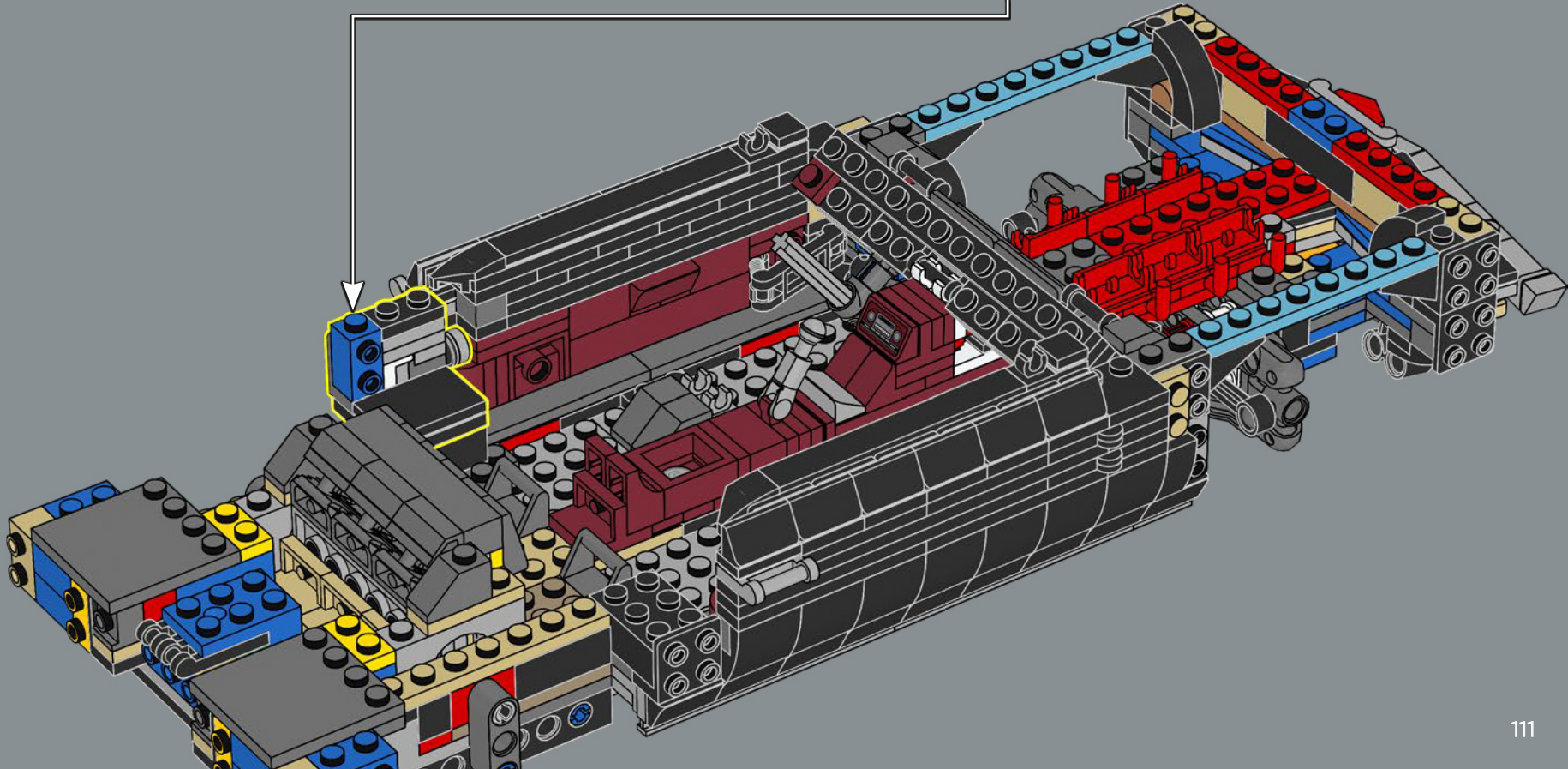

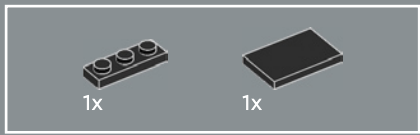

189

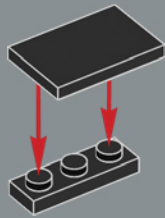

190

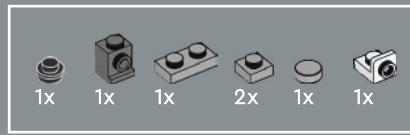
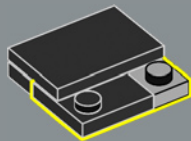

191

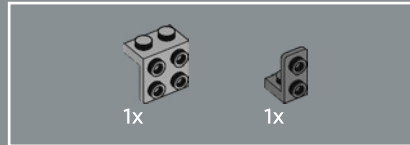
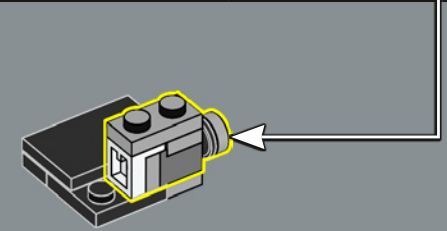
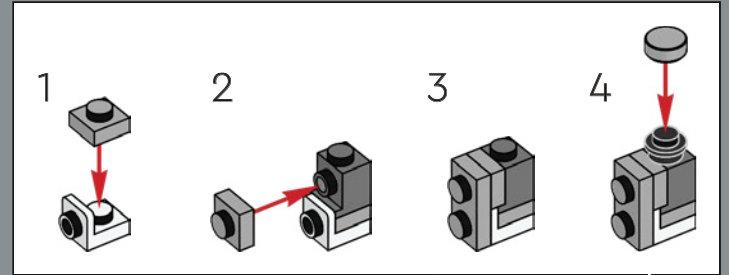

192

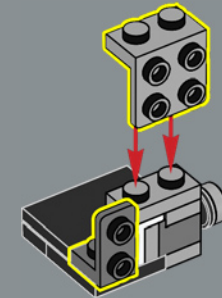



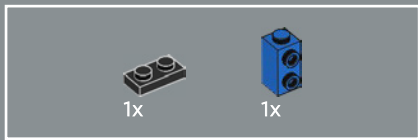

193

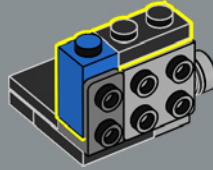

194

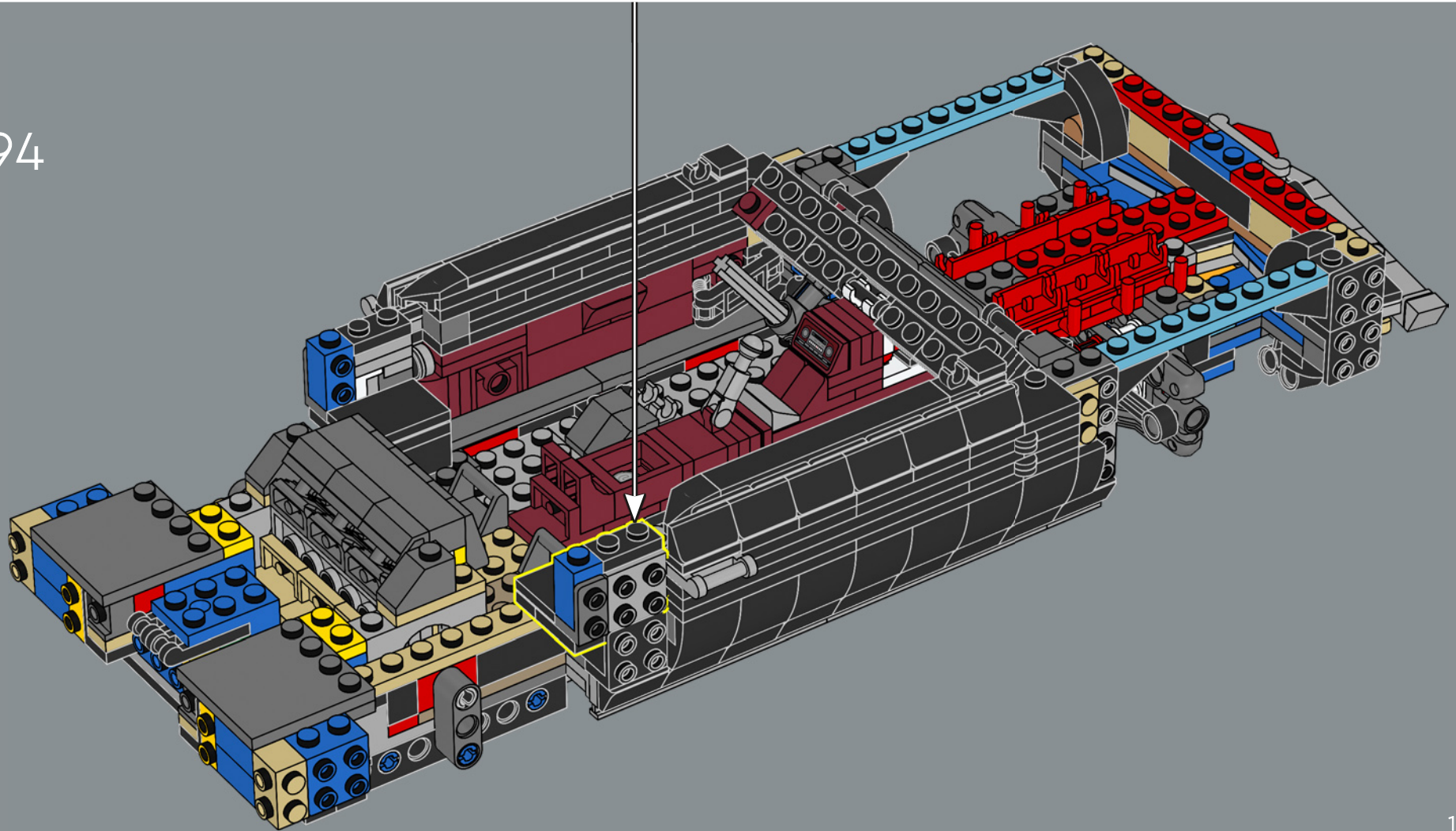

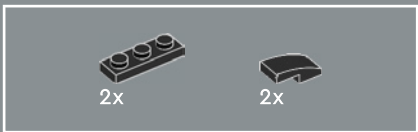

195

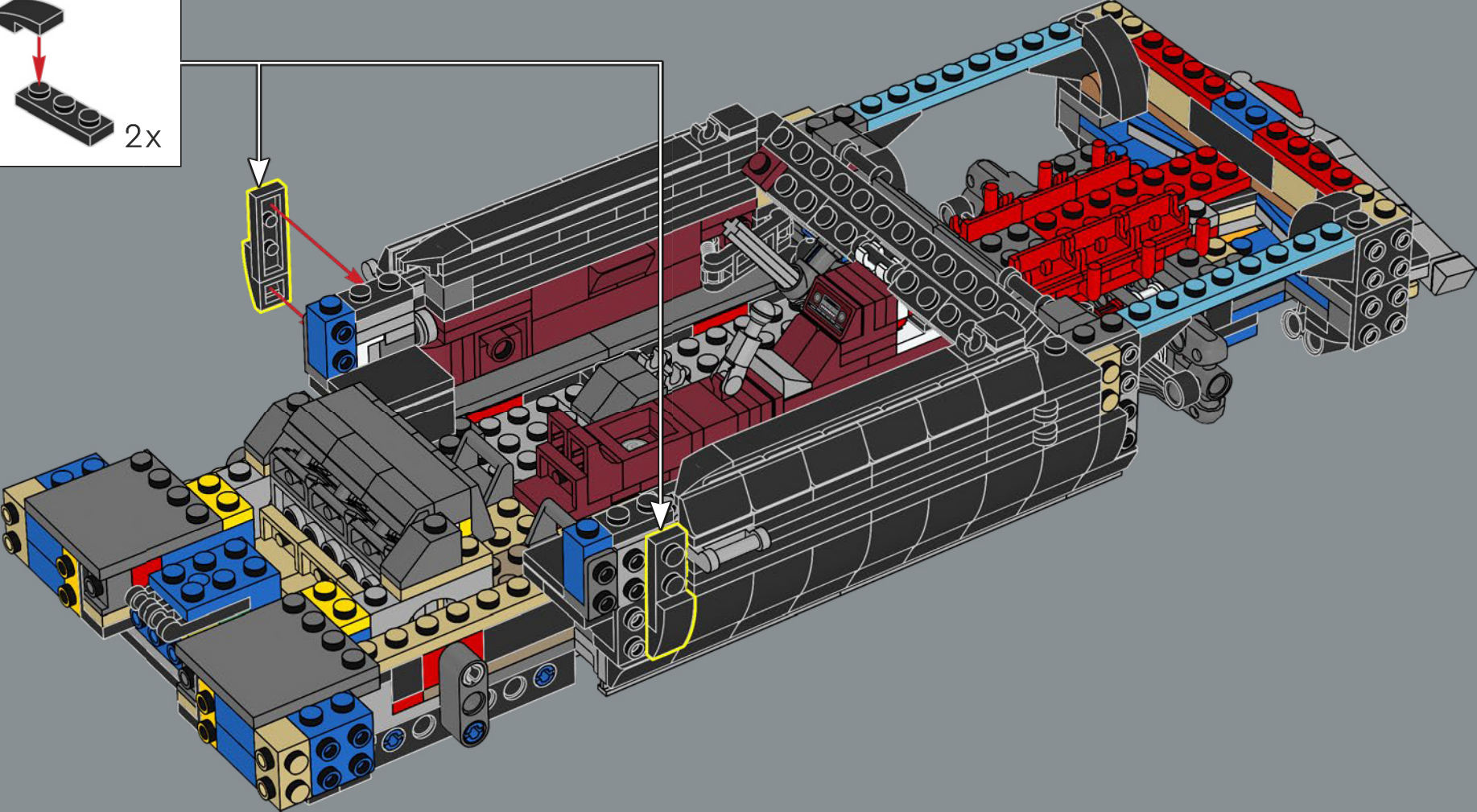
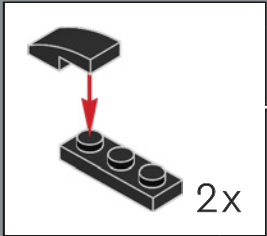

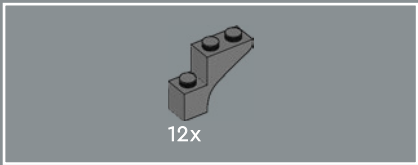

196

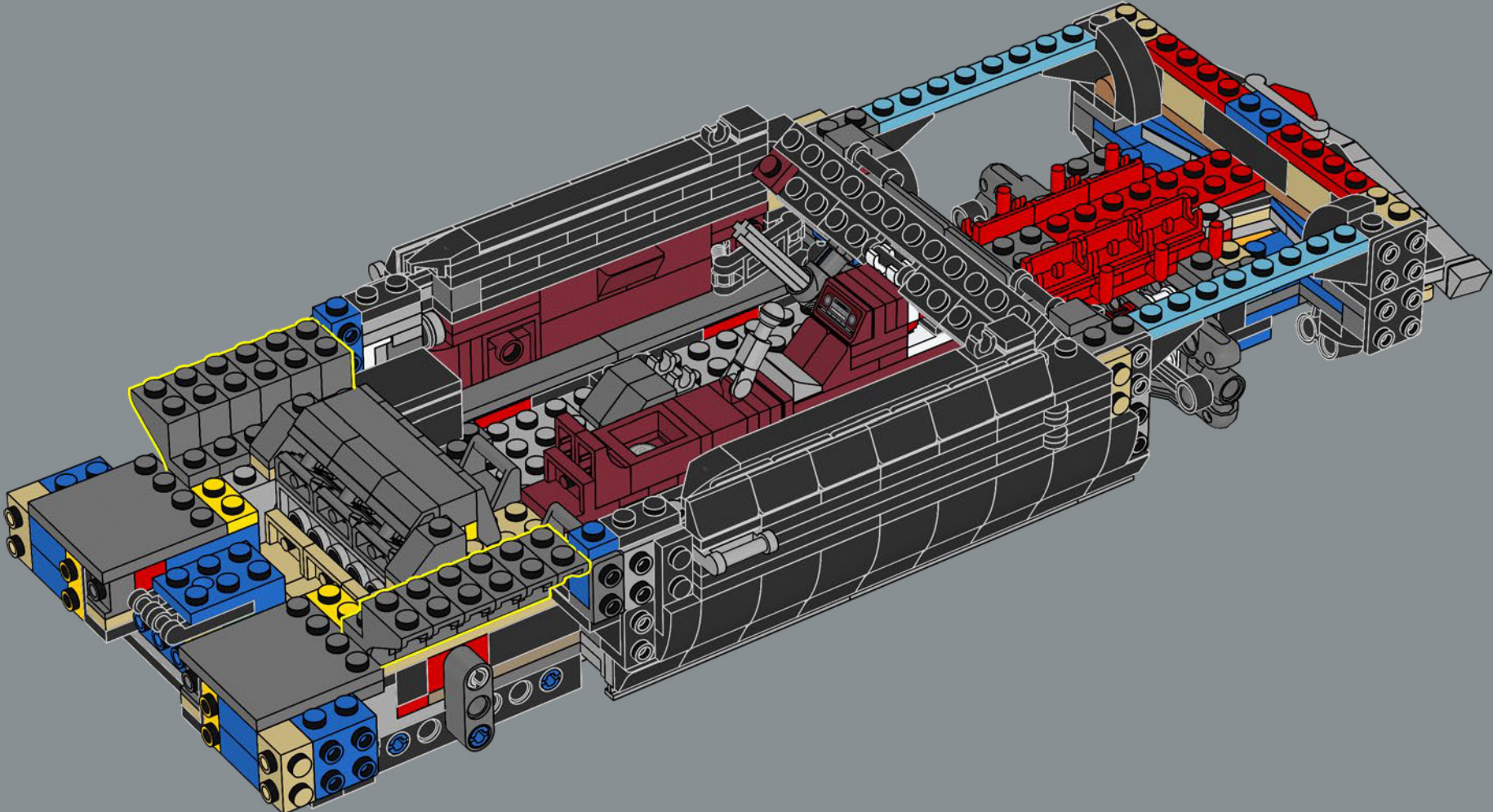

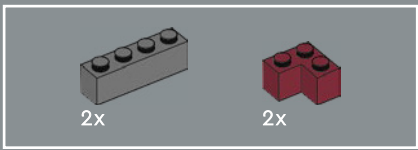

197

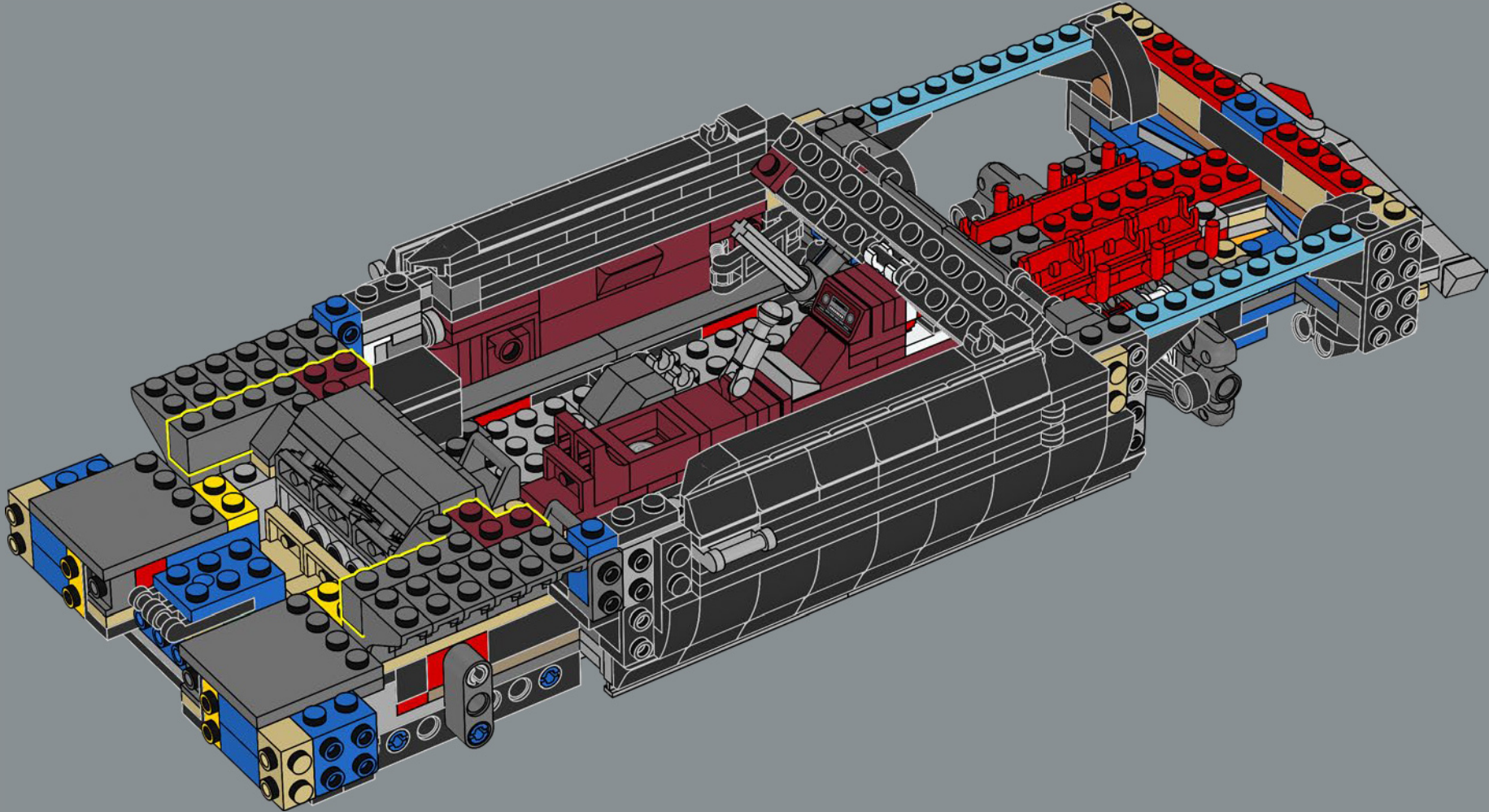

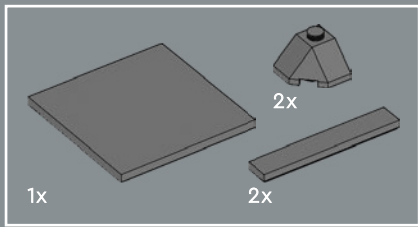

198

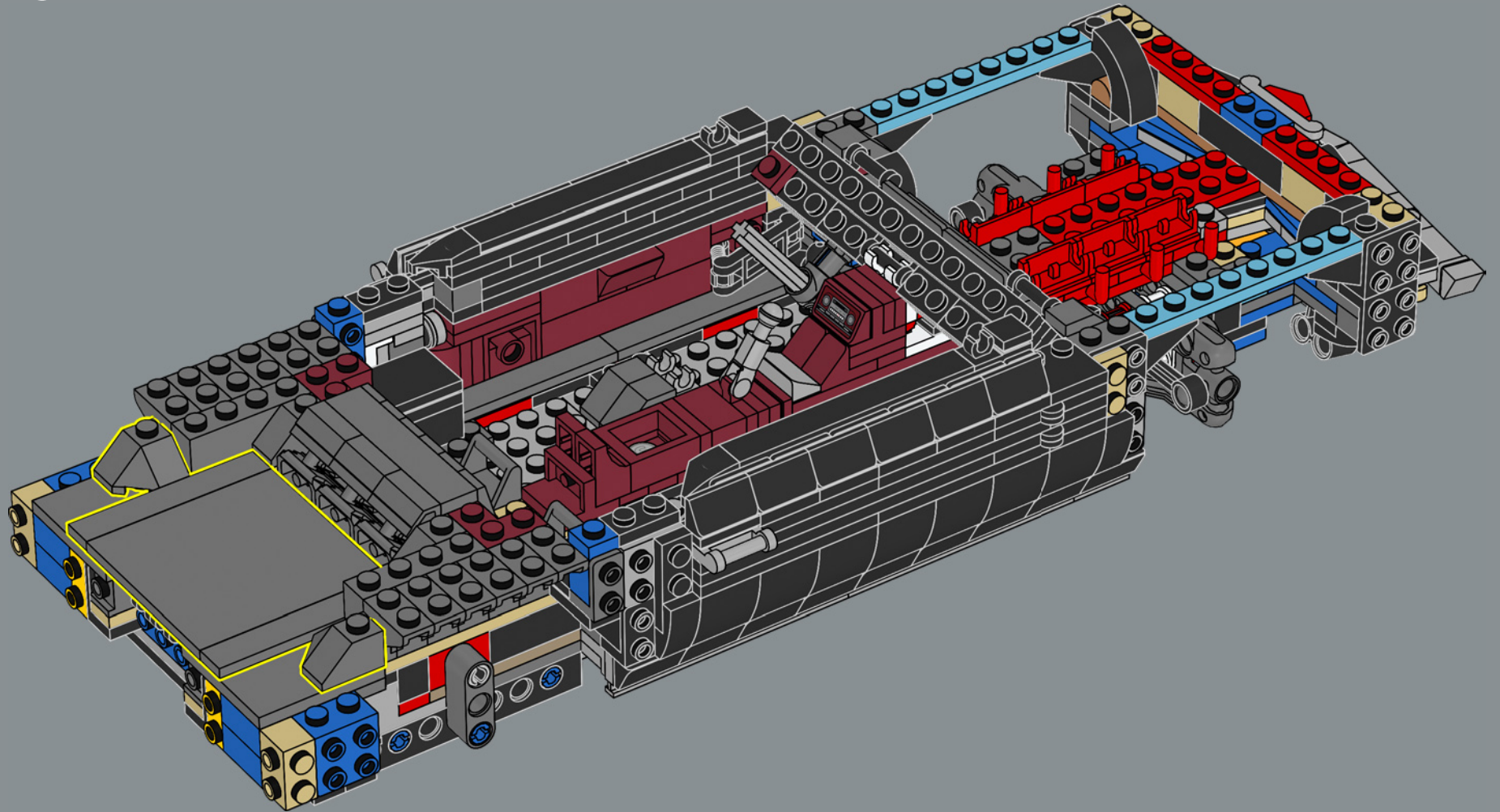

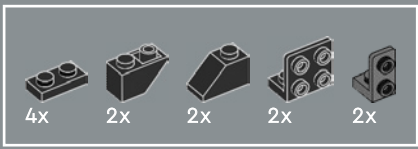

199

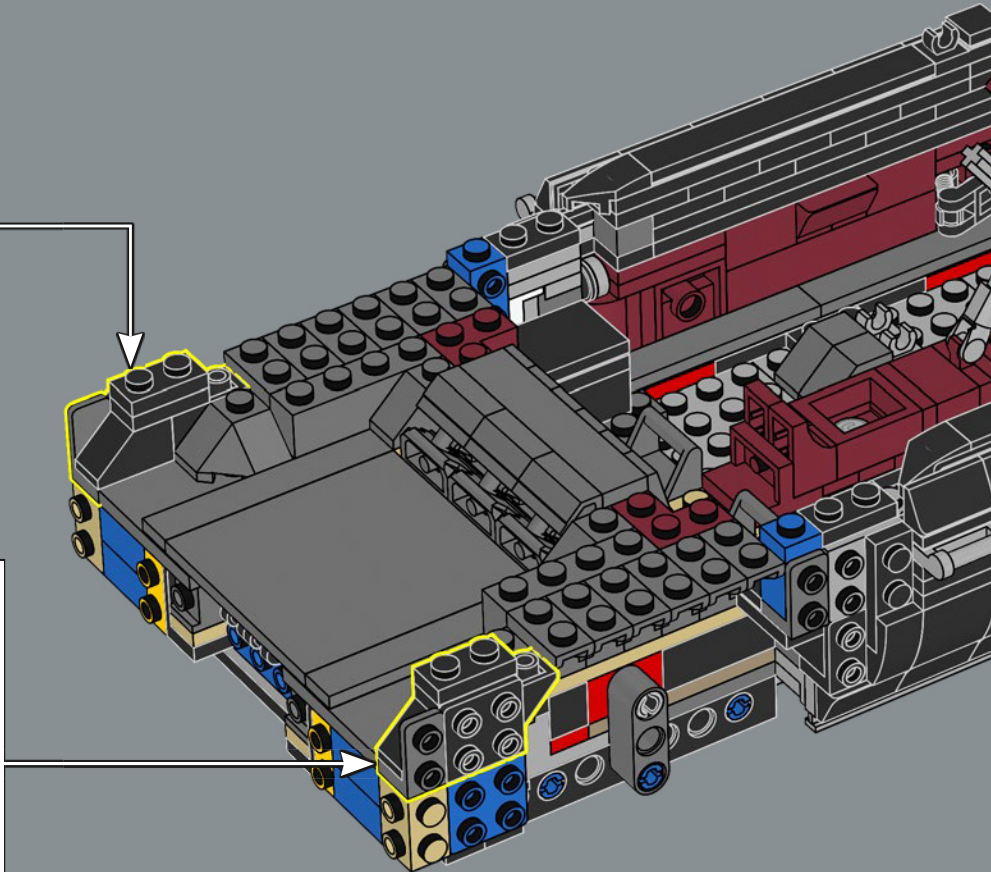
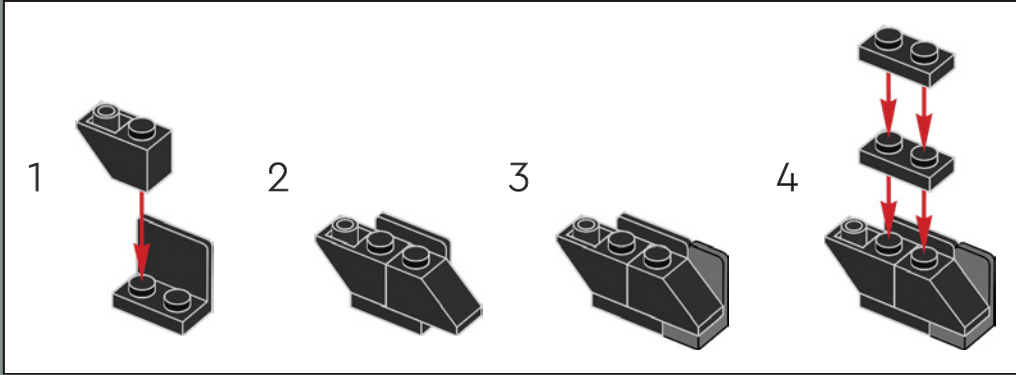
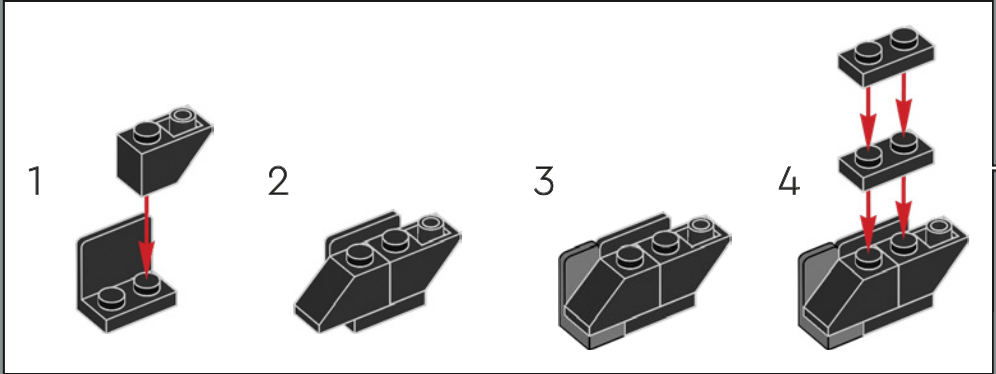



200

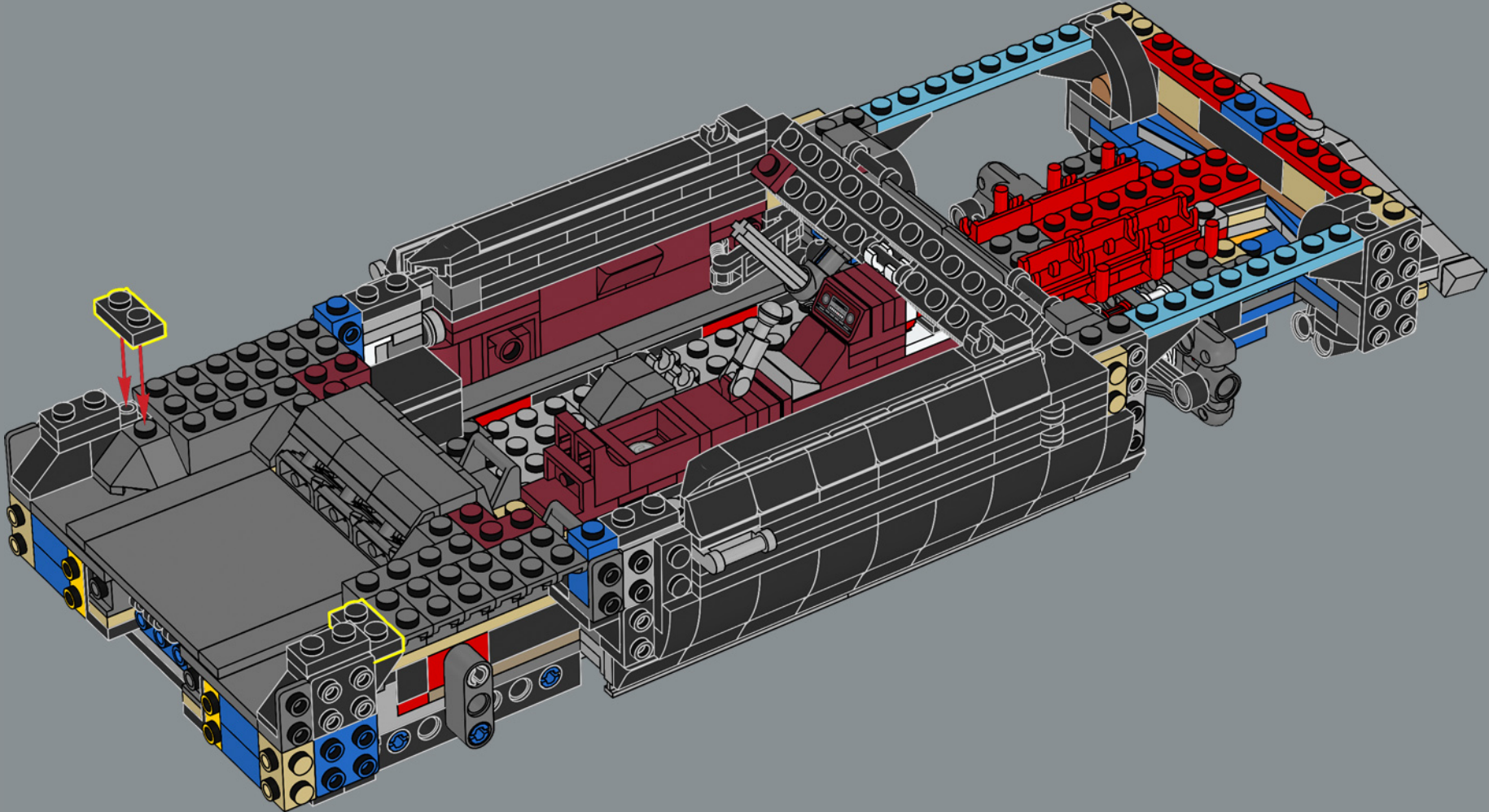



2x

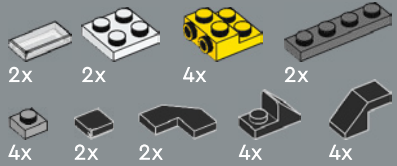

201

1

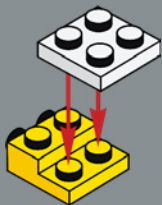

2

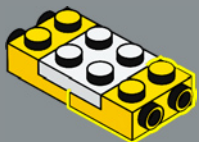

3

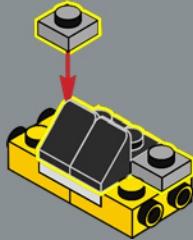

4

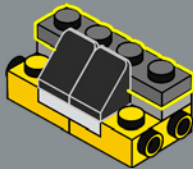

5

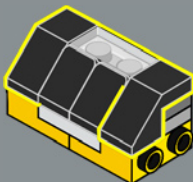

2x

6

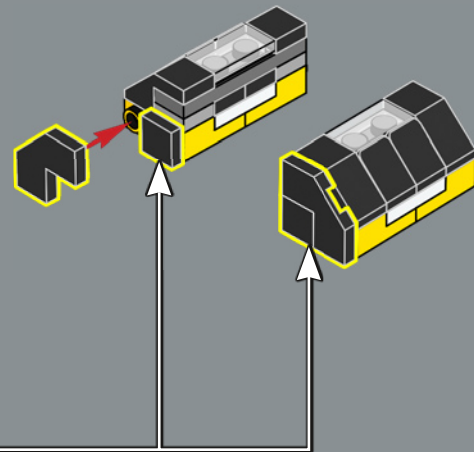



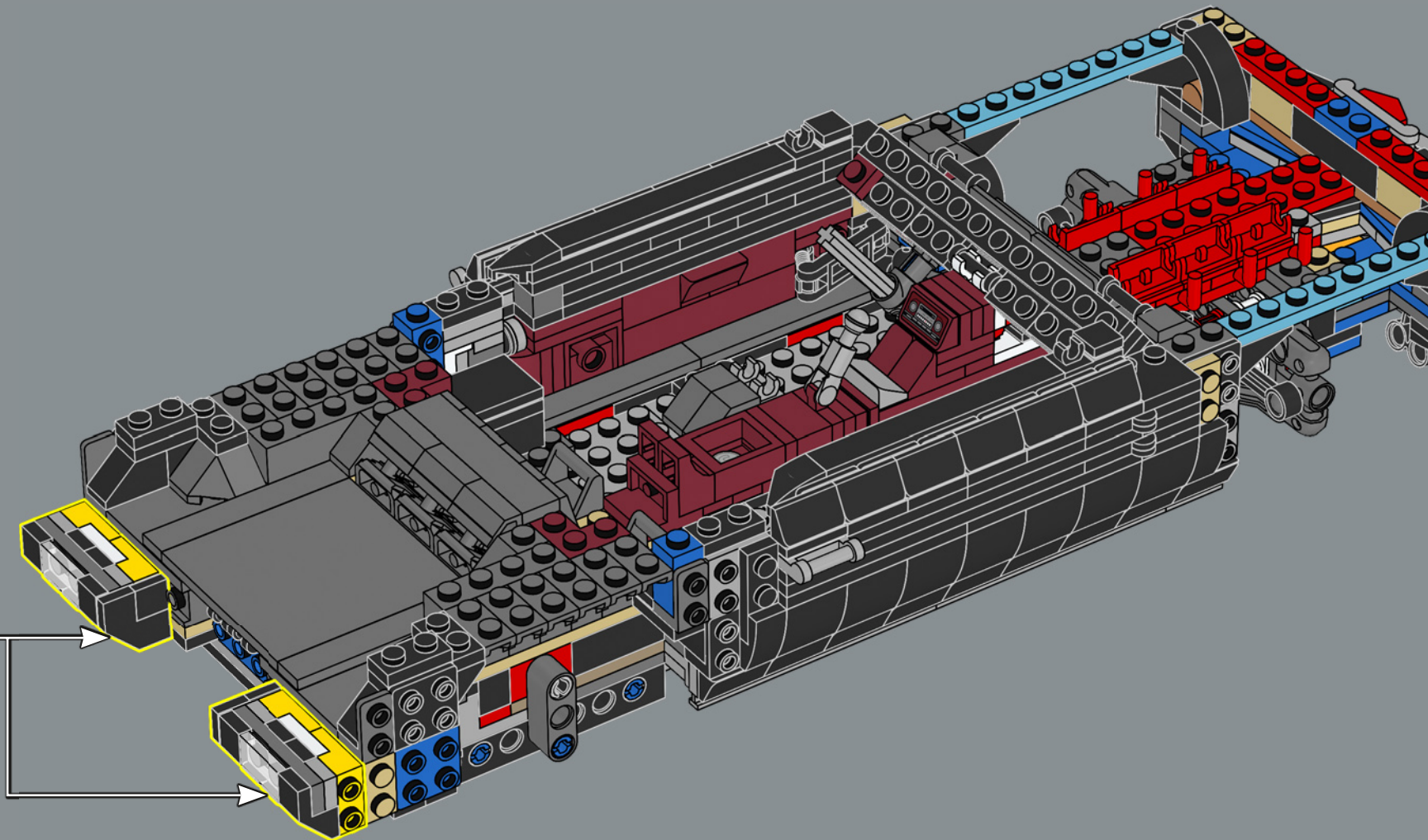



202

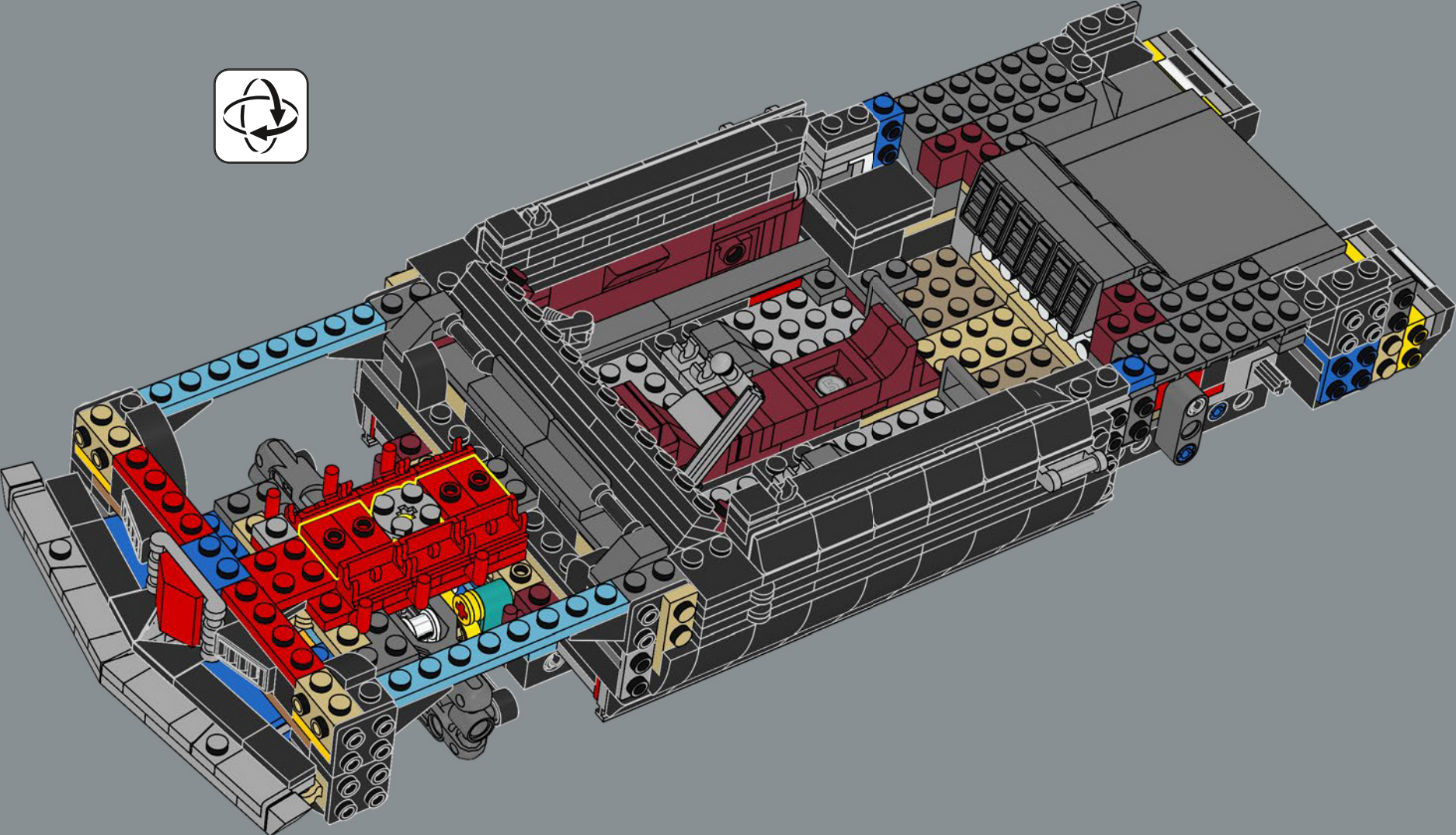

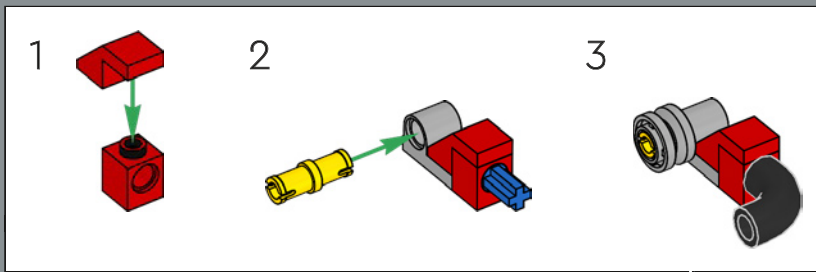
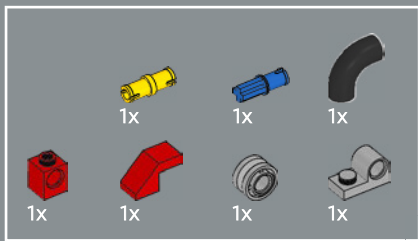

203

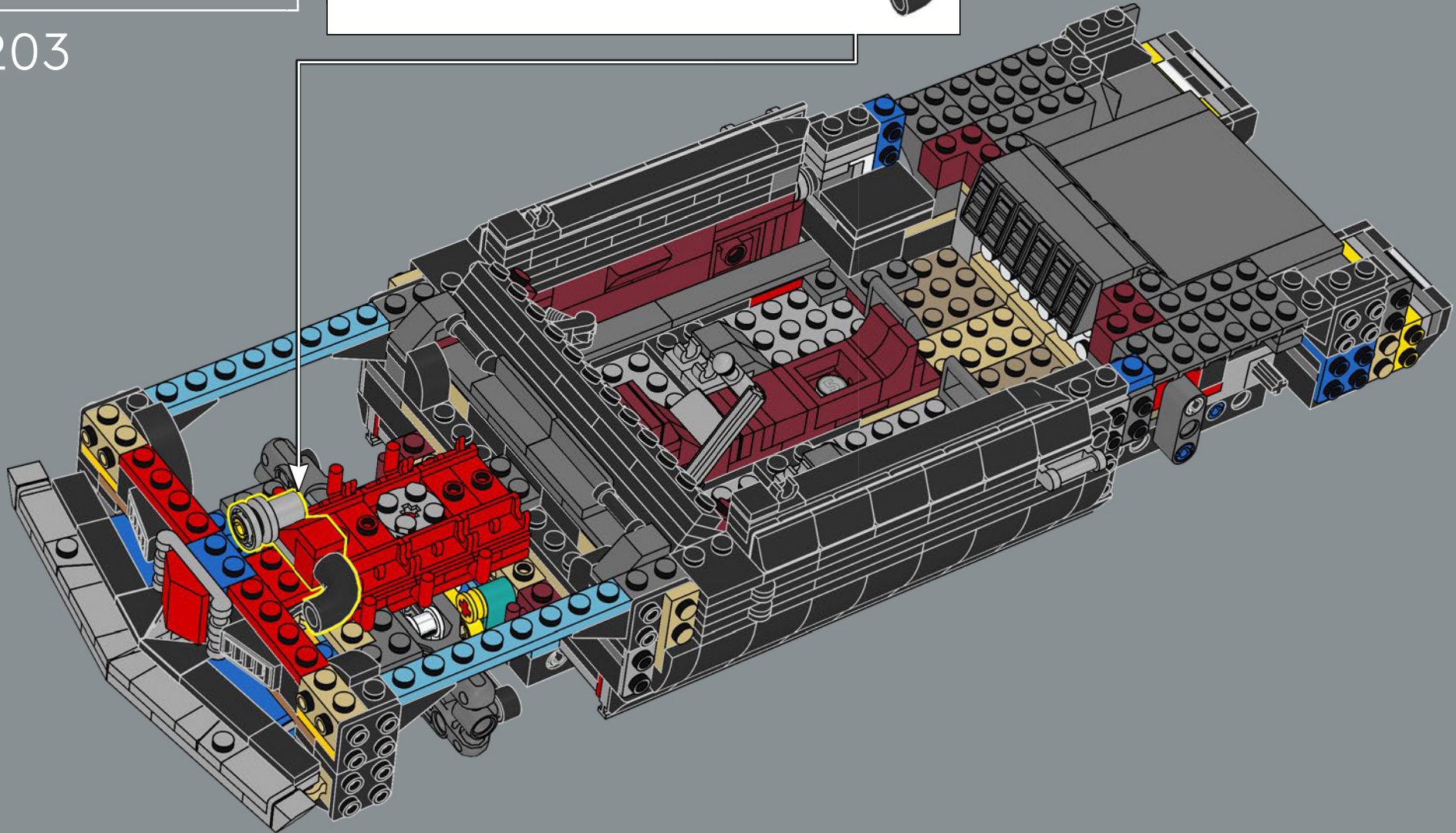

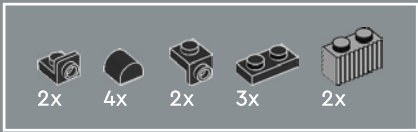

# 204

1

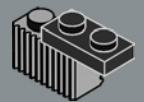

2

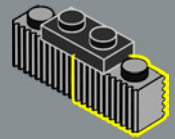

3

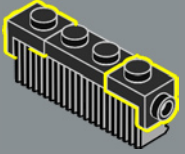

4

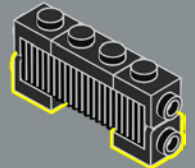

5

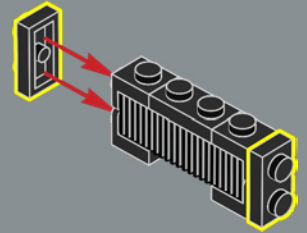

6

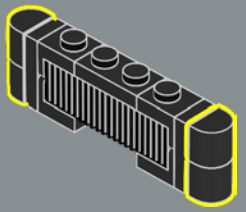

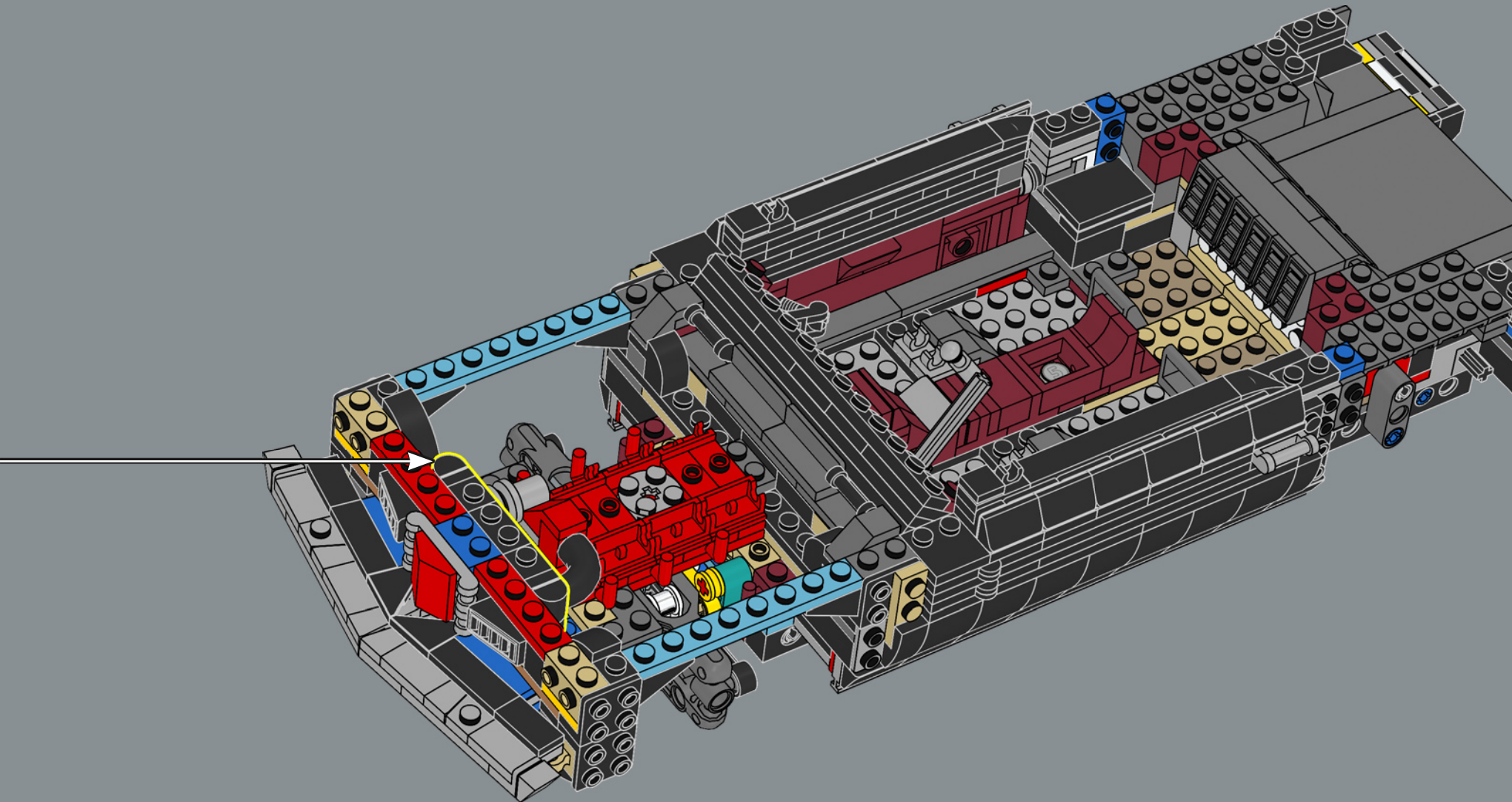

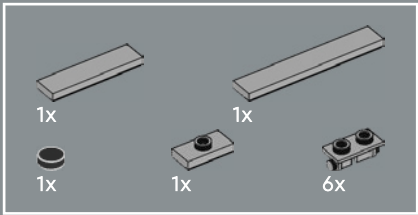

205

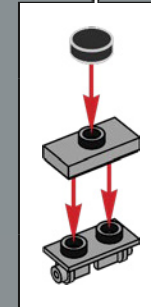
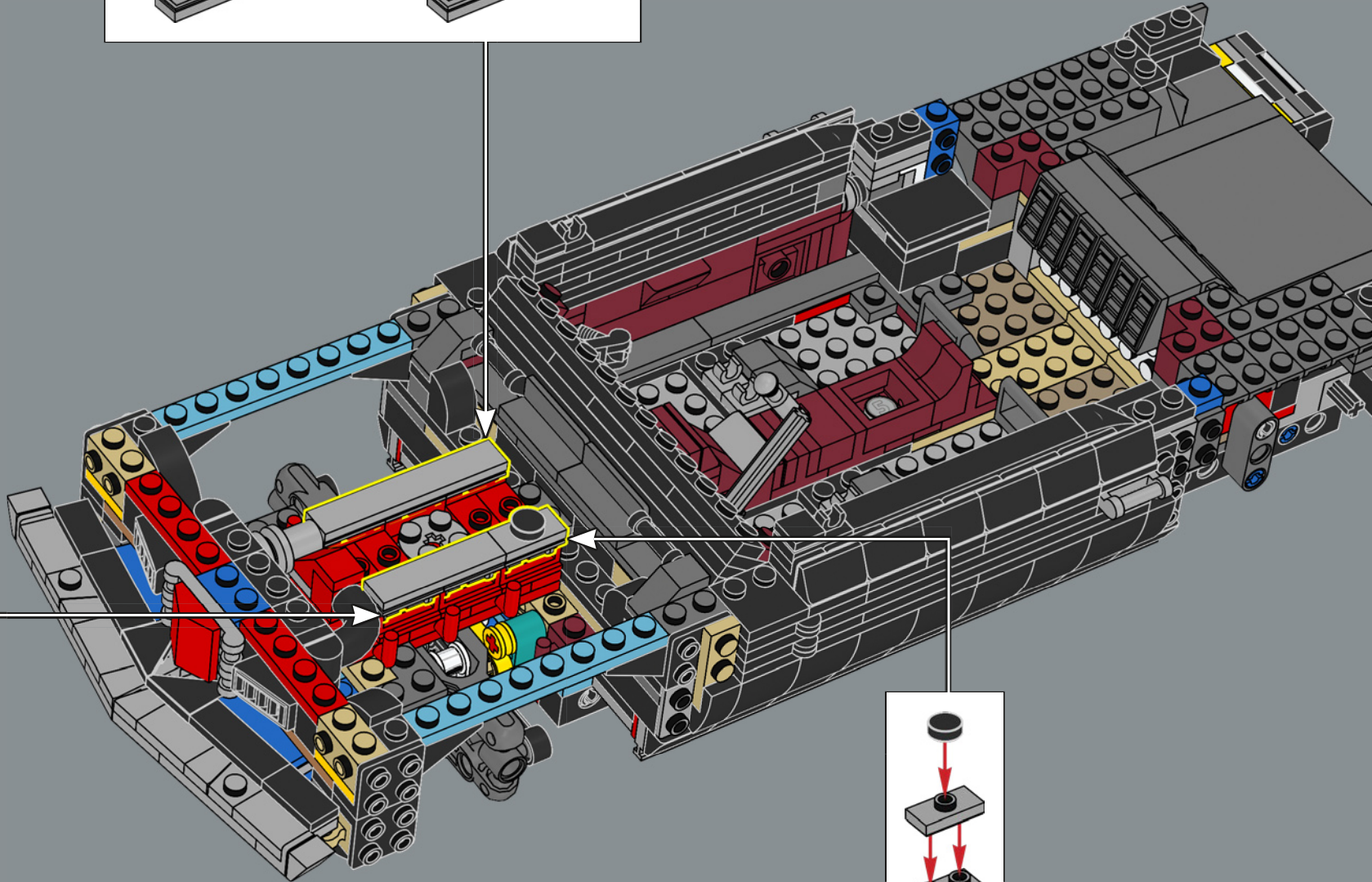
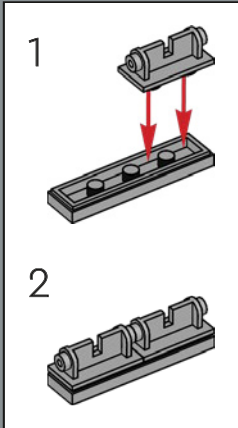
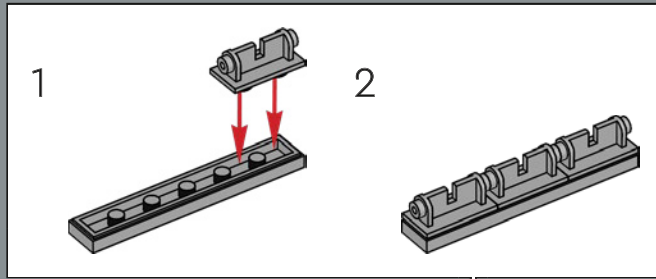



206

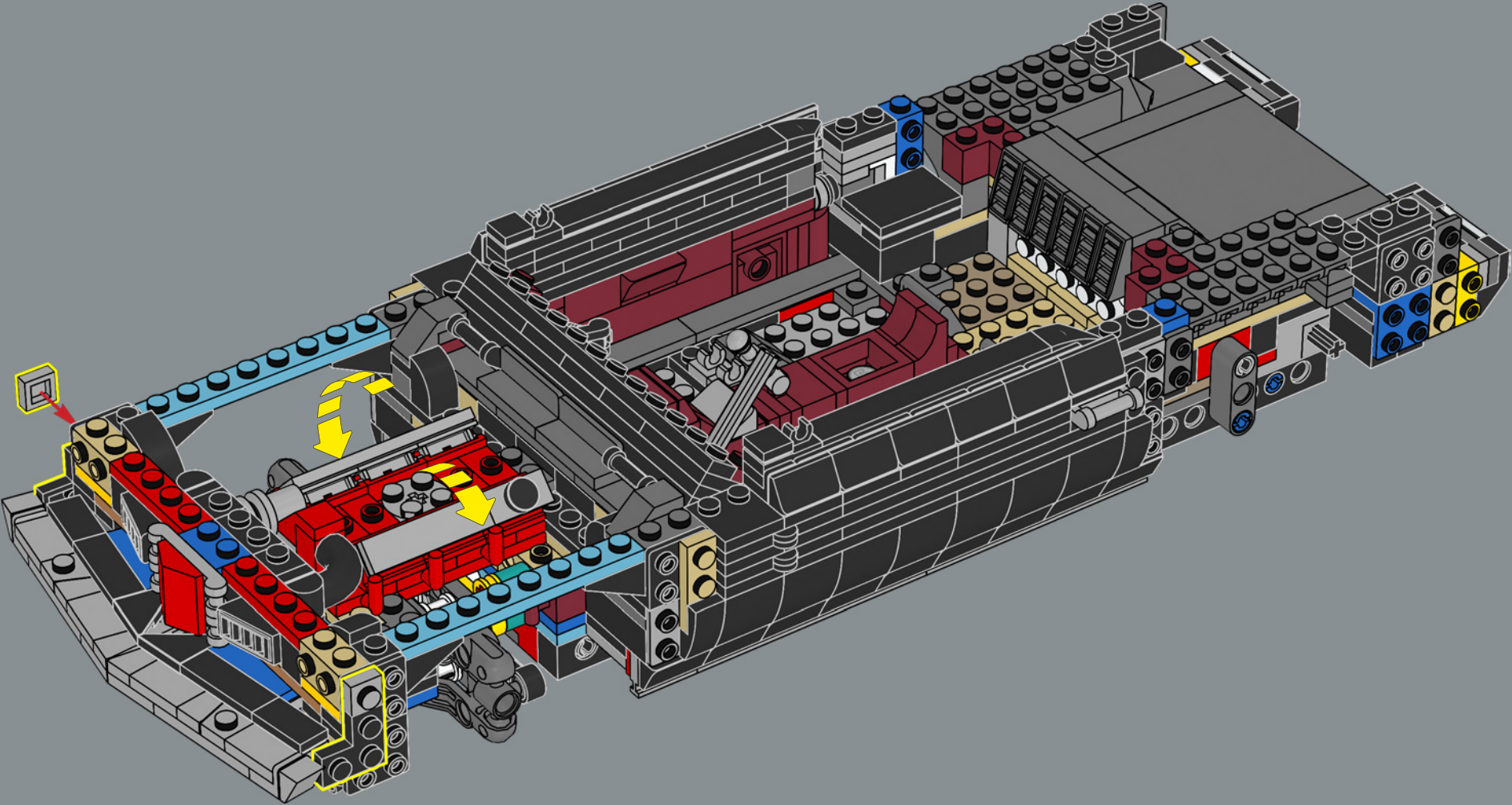



207

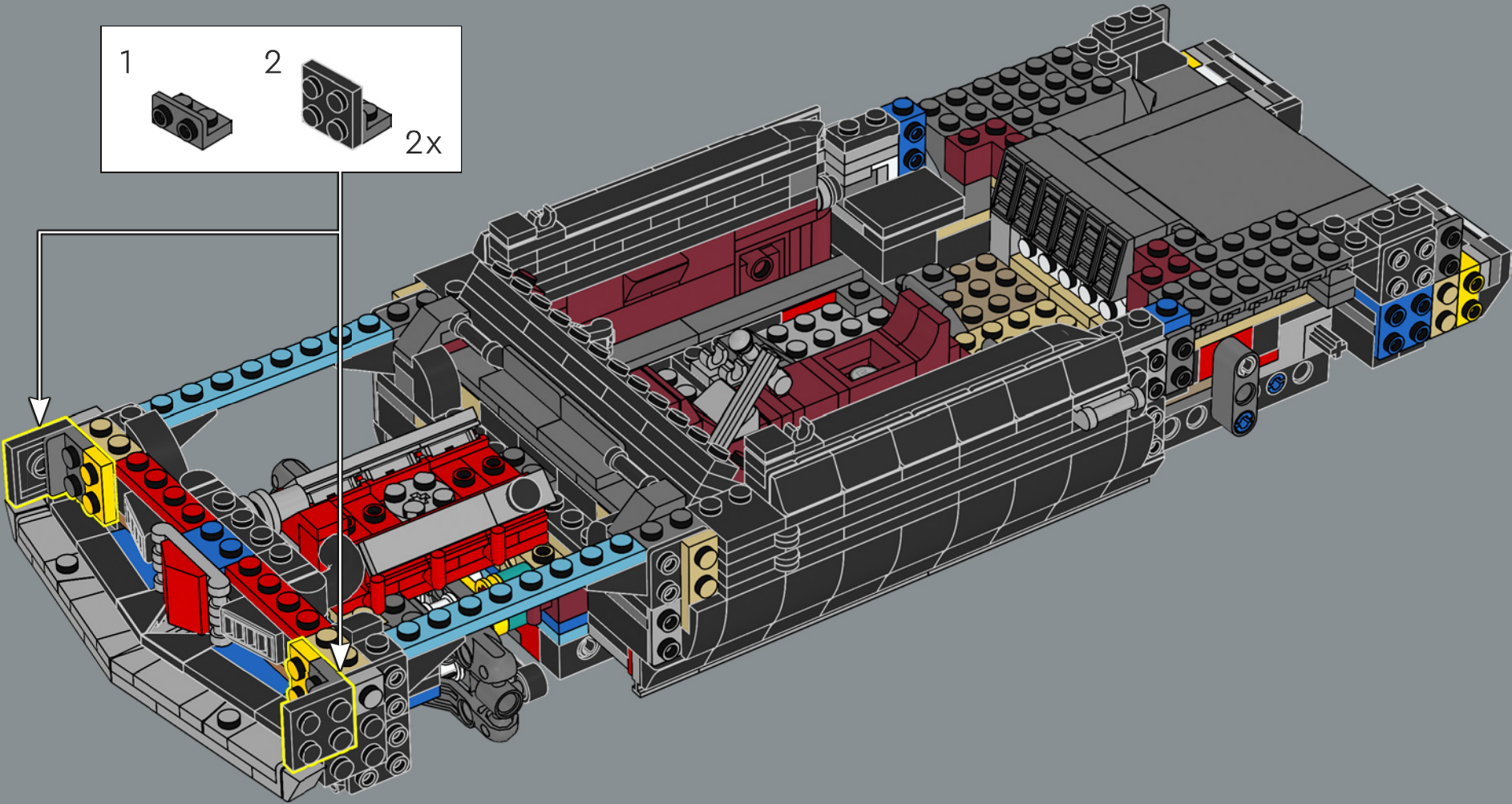
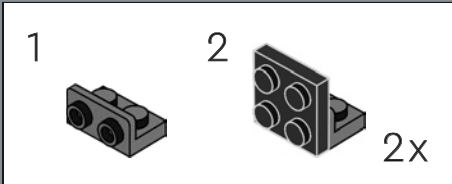



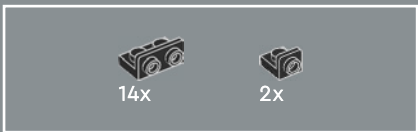

208

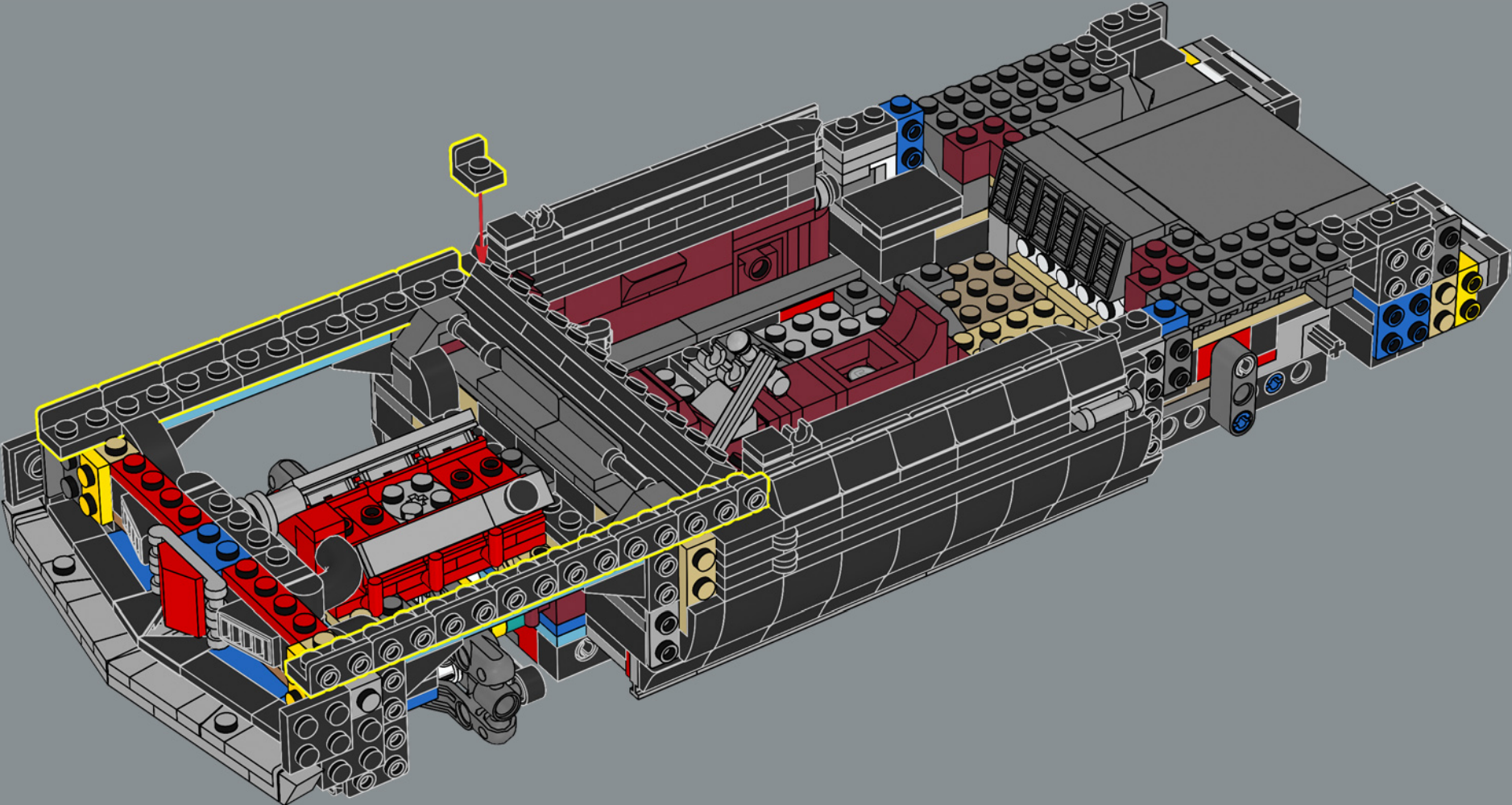

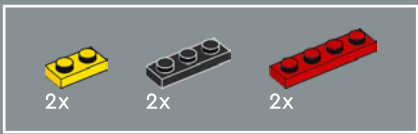

209

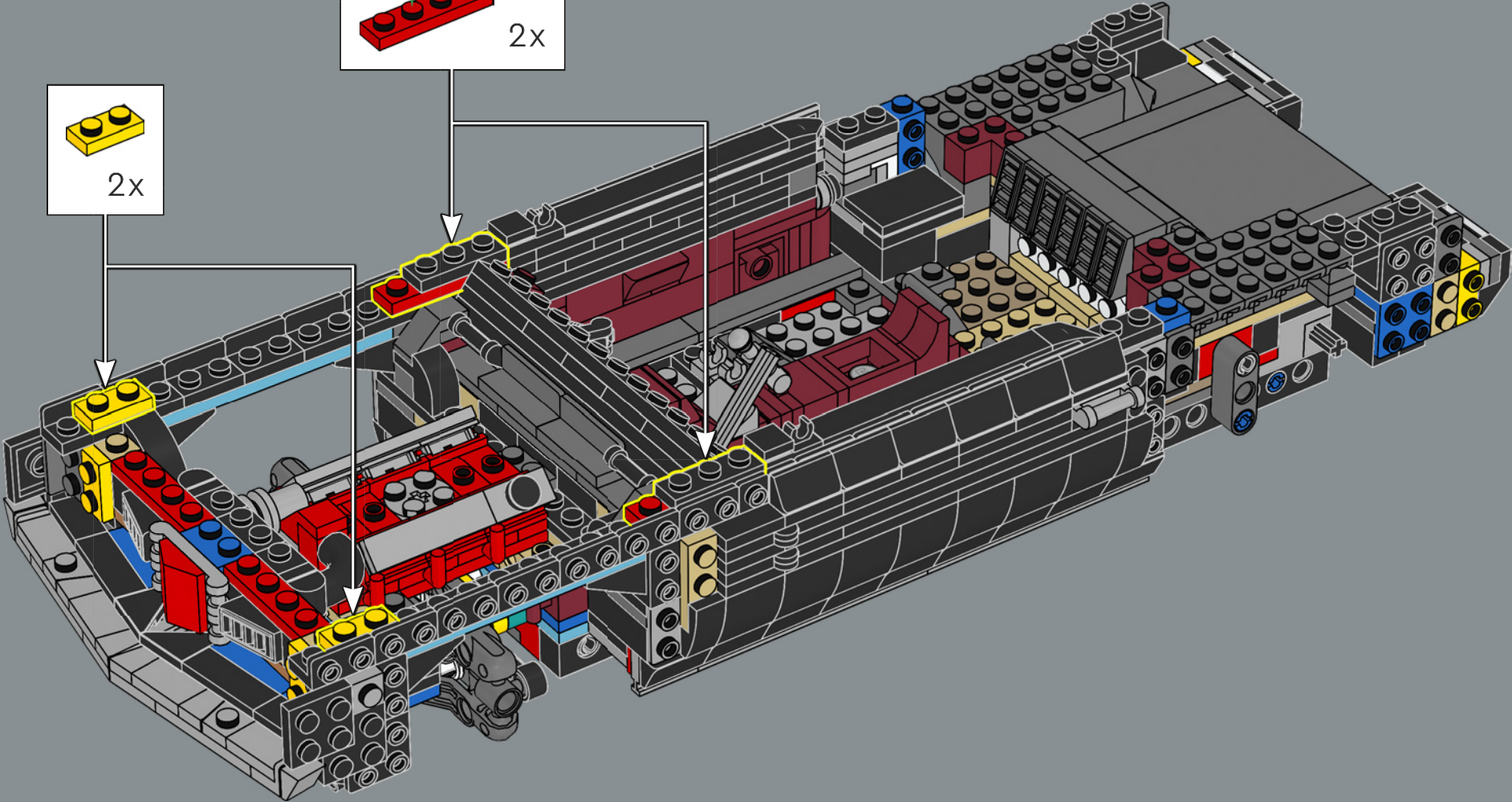
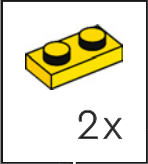
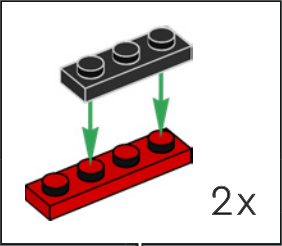



210

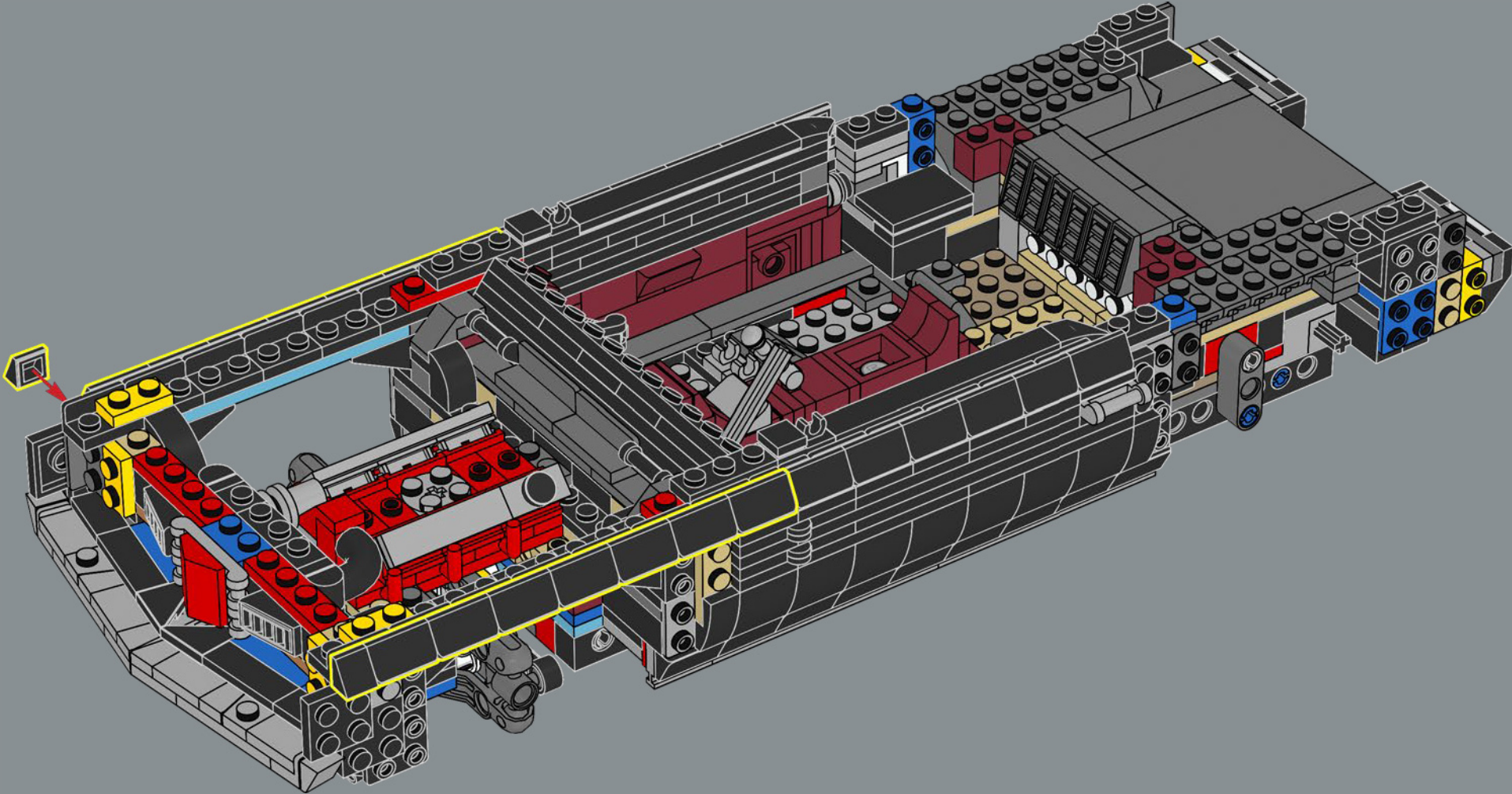

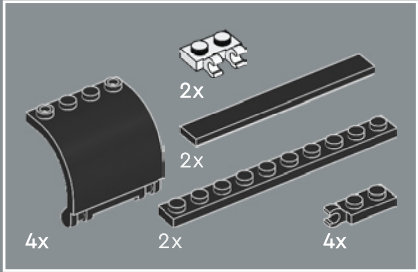
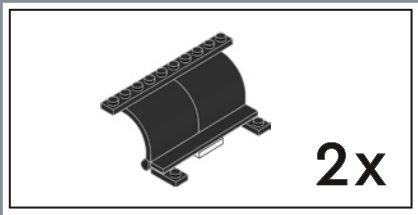

211

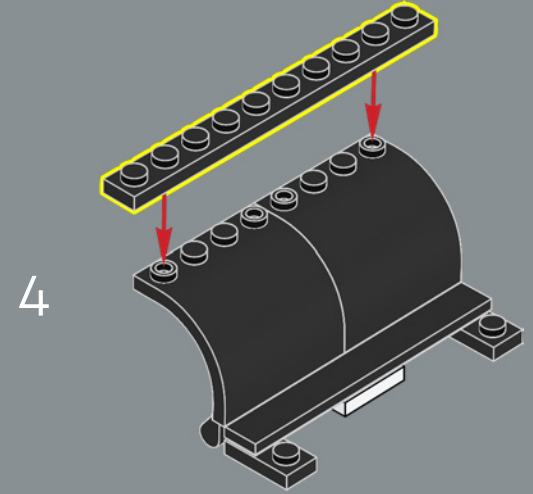
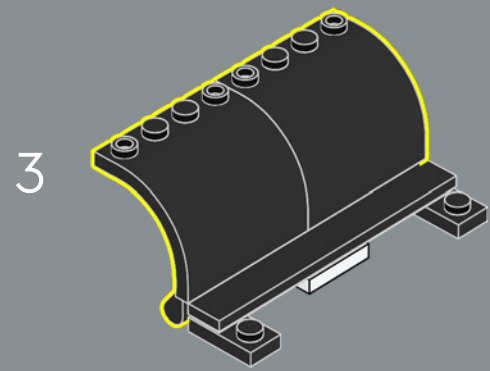
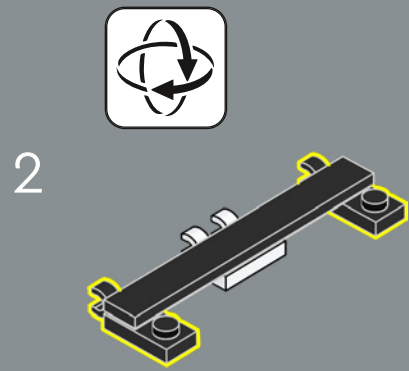
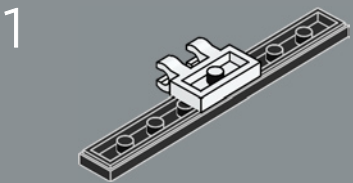

2x

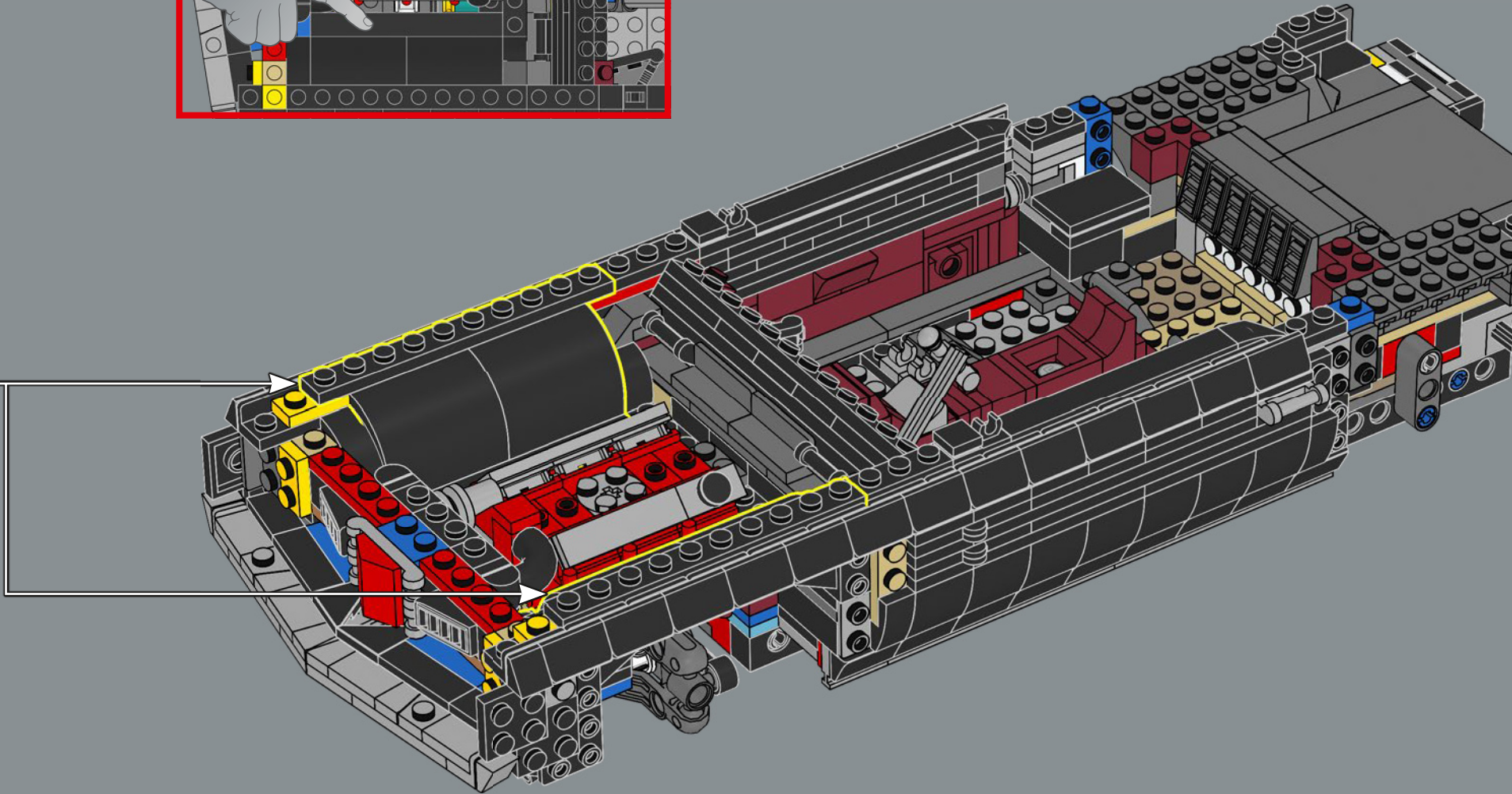
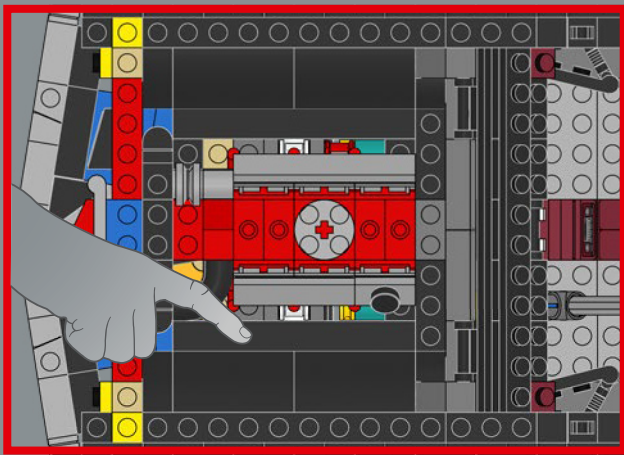

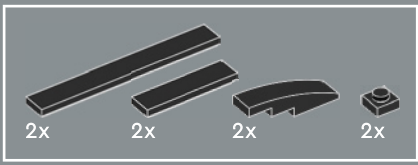

212

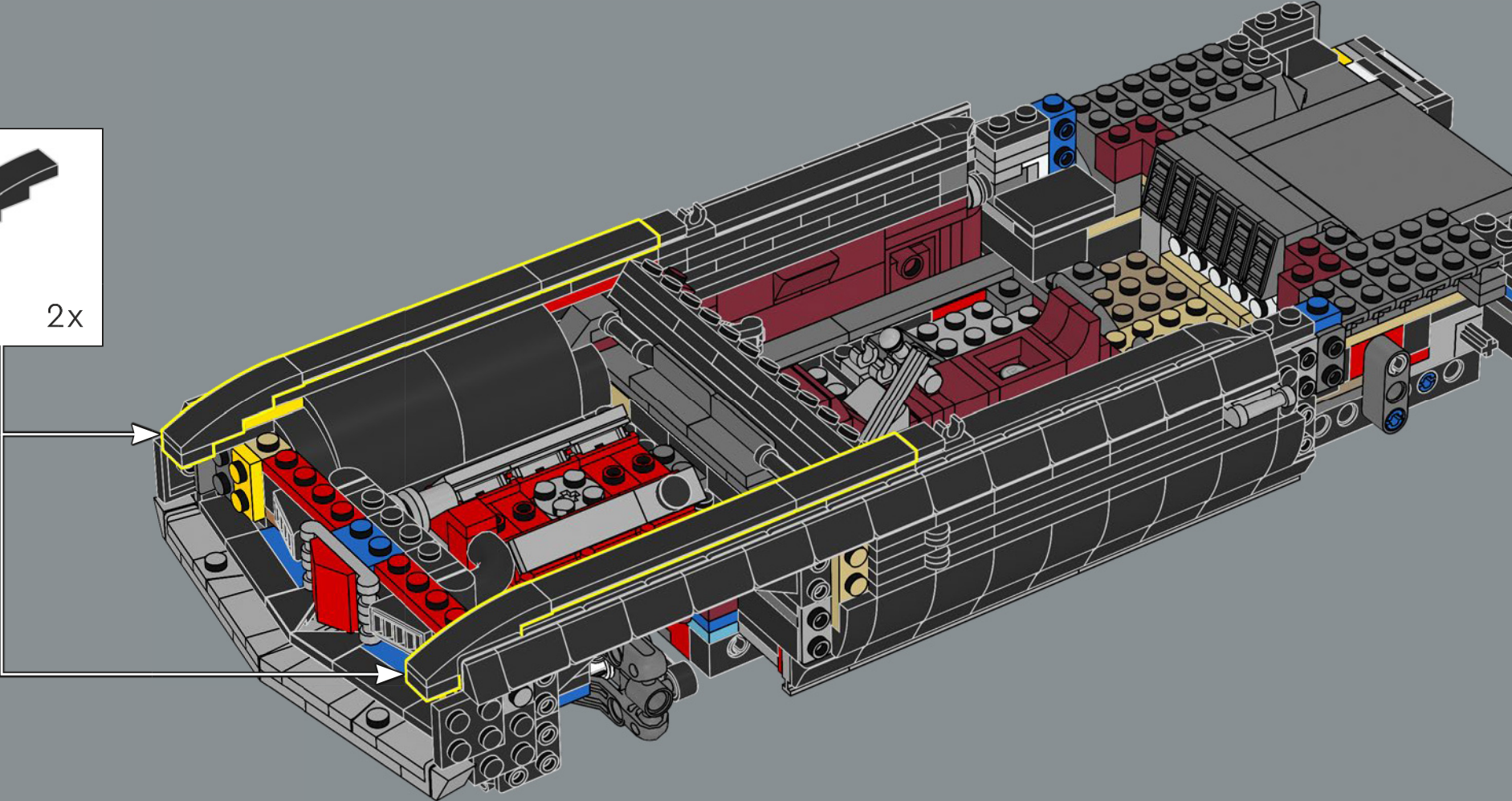
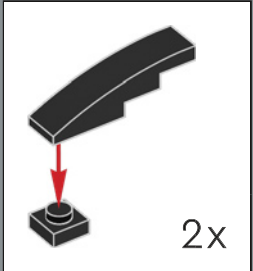

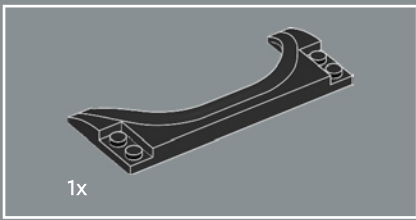

213

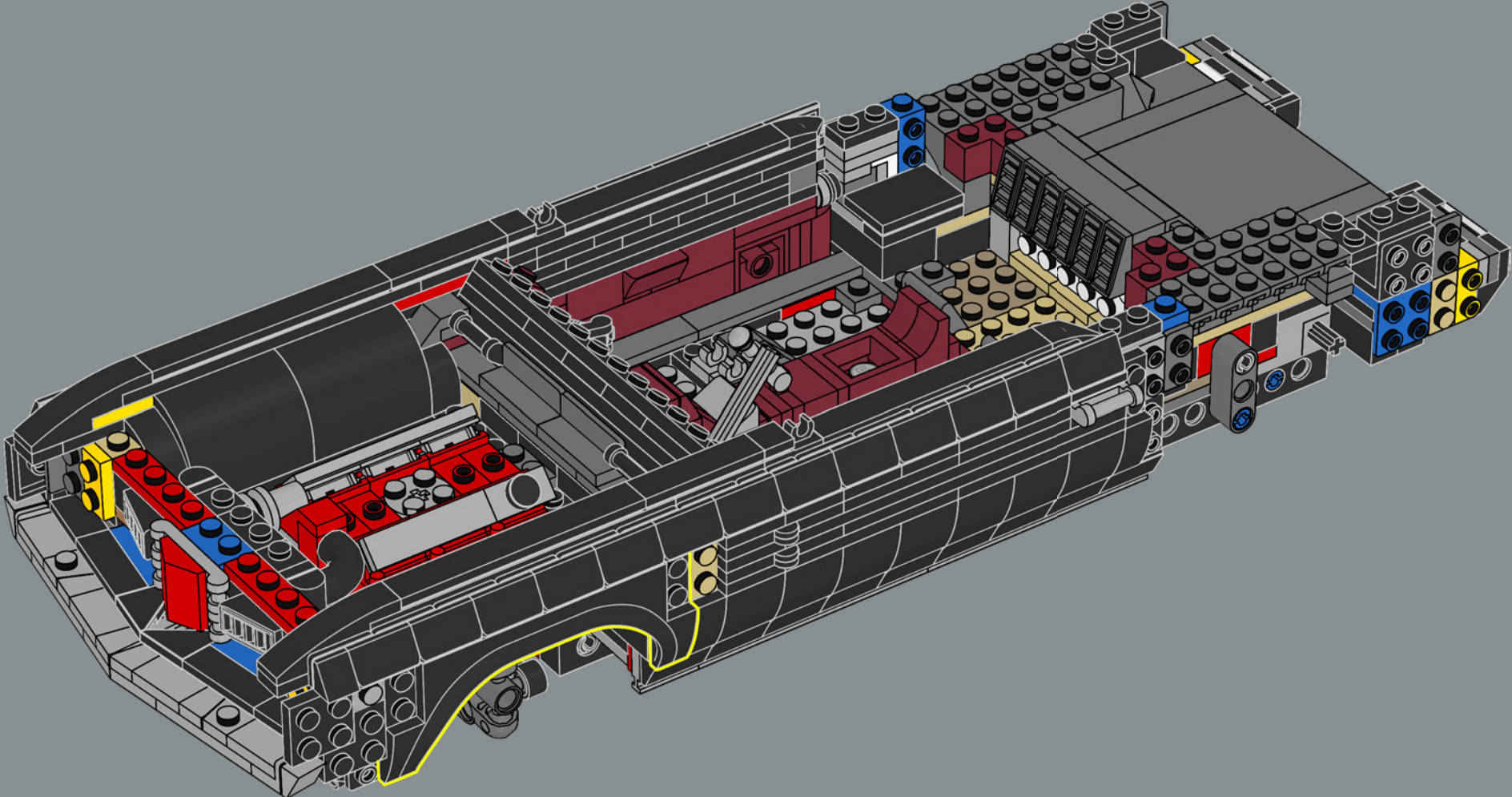

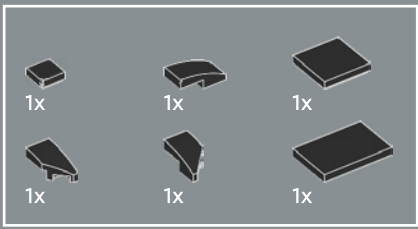

214

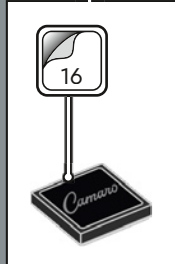
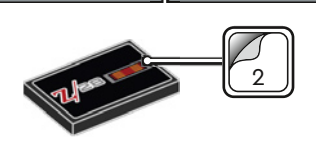
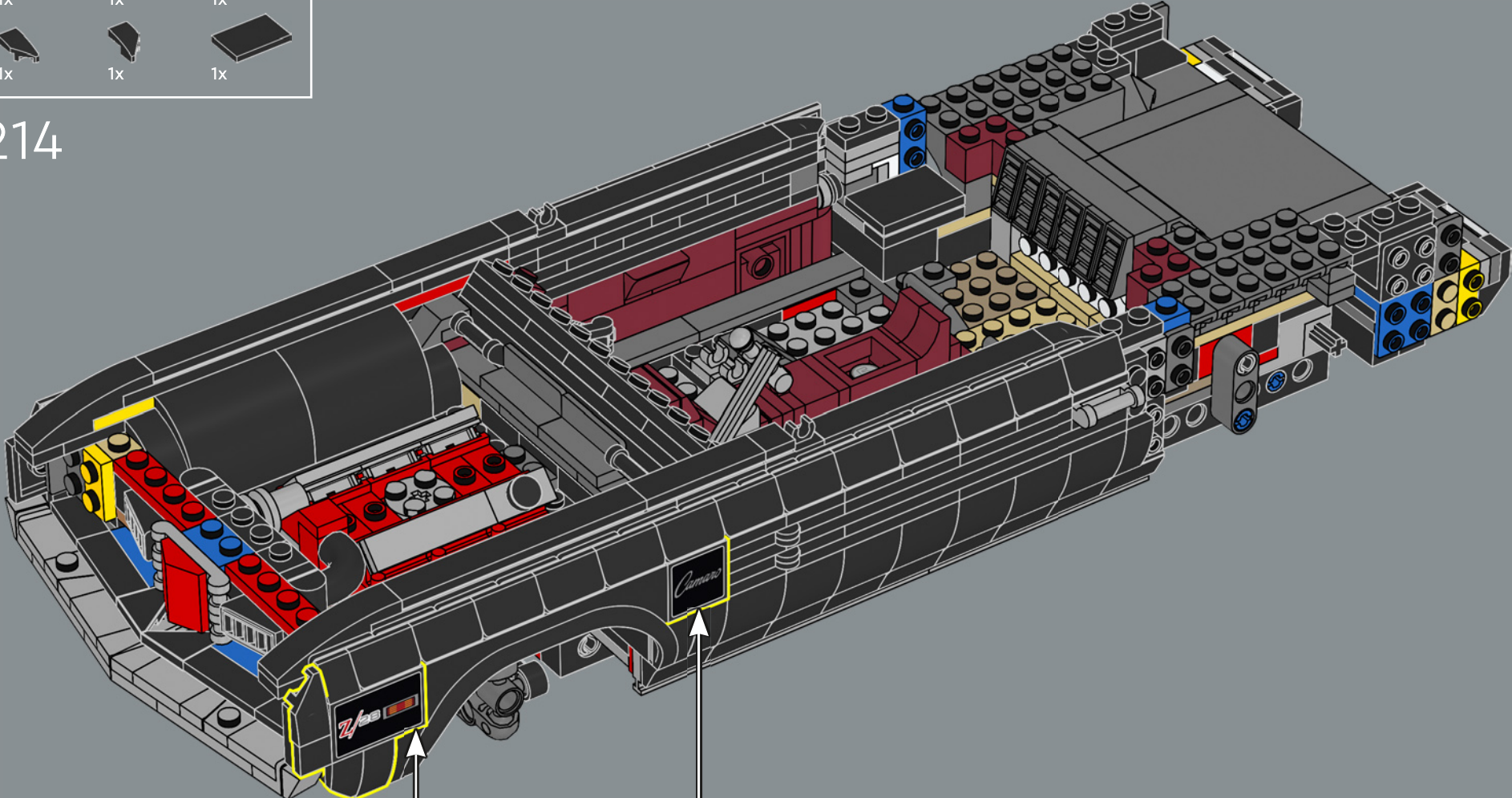



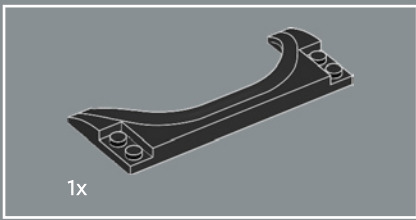

215

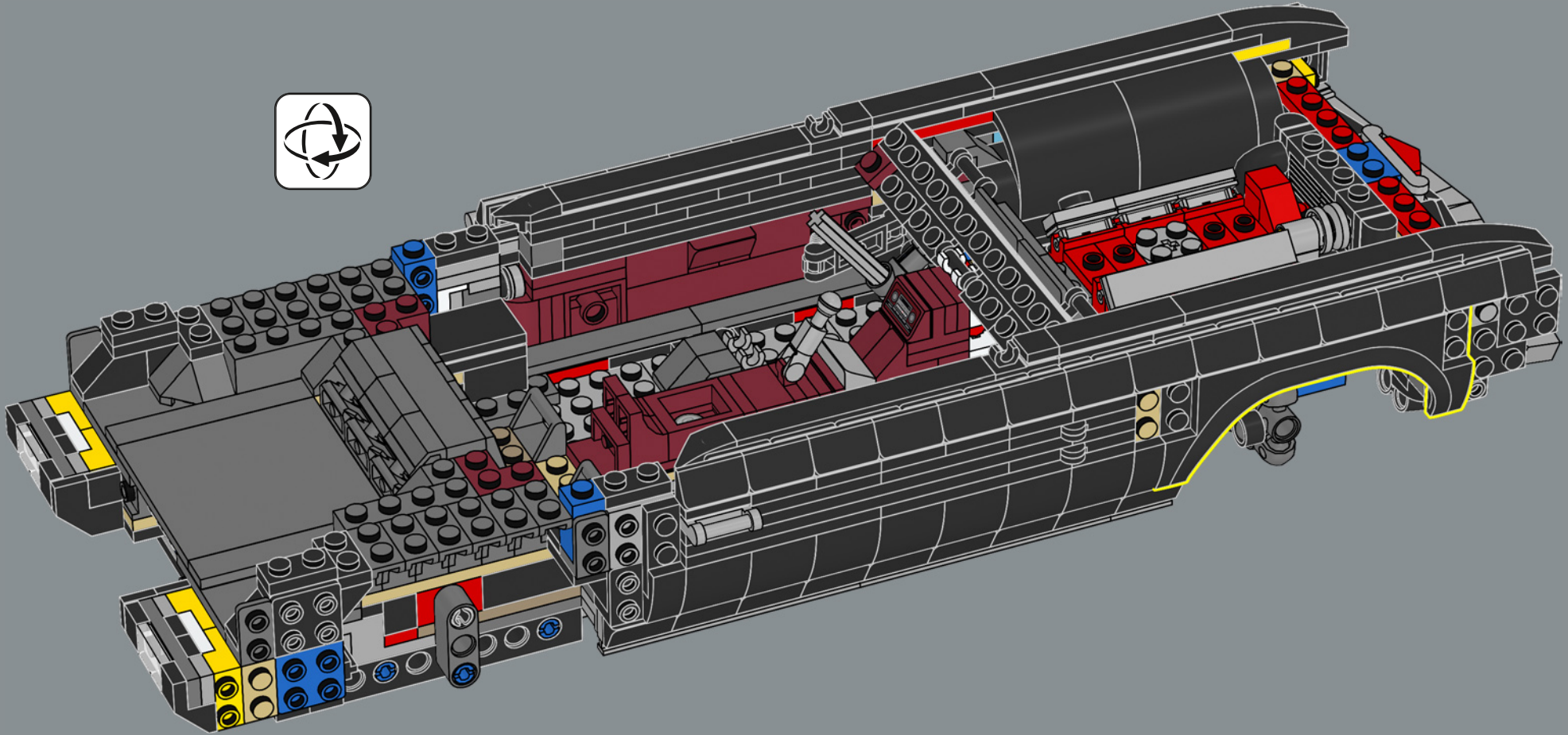

Chevrolet originally also considered producing a station wagon version of the Camaro.

Initialement, Chevrolet envisageait également de produire une version familiale de la Camaro.

En un principio, Chevrolet consideró también la posibilidad de fabricar una versión *station wagon* del Camaro.

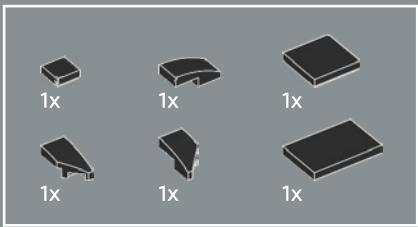

216

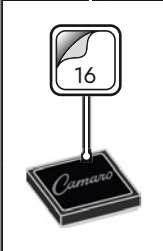
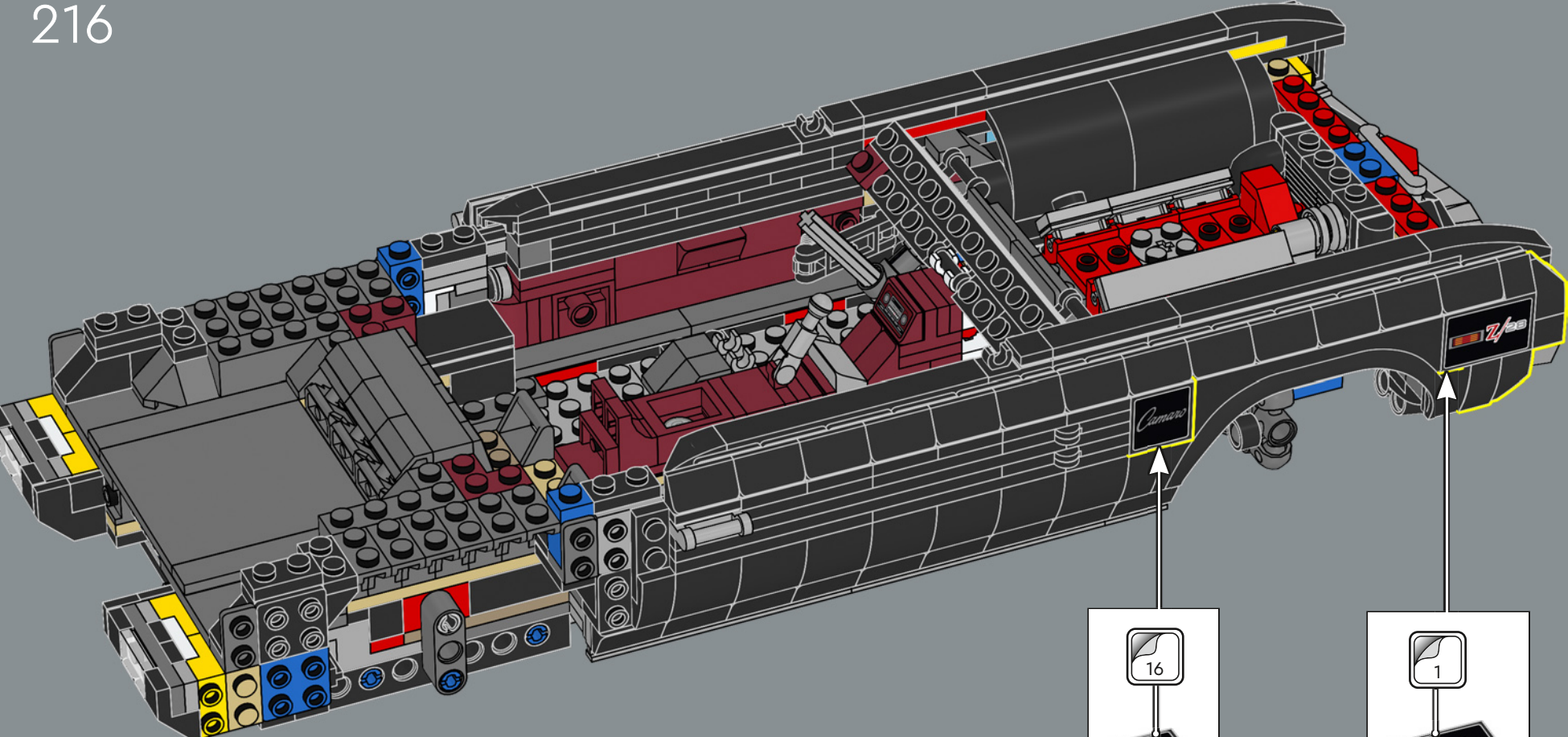



217

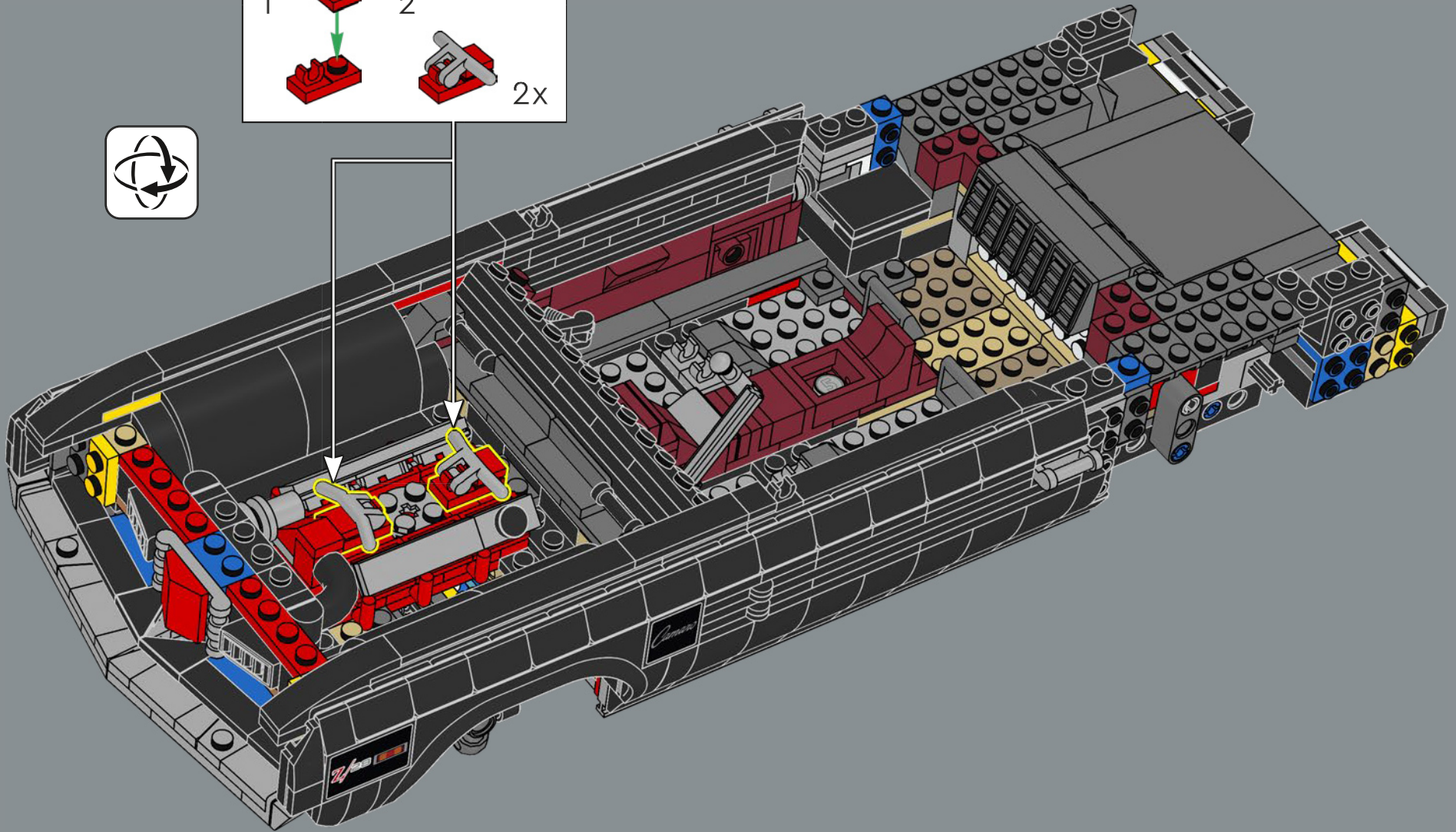
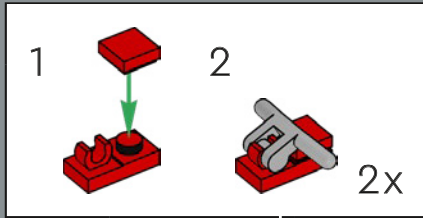

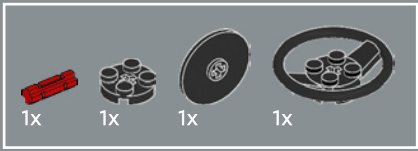

218

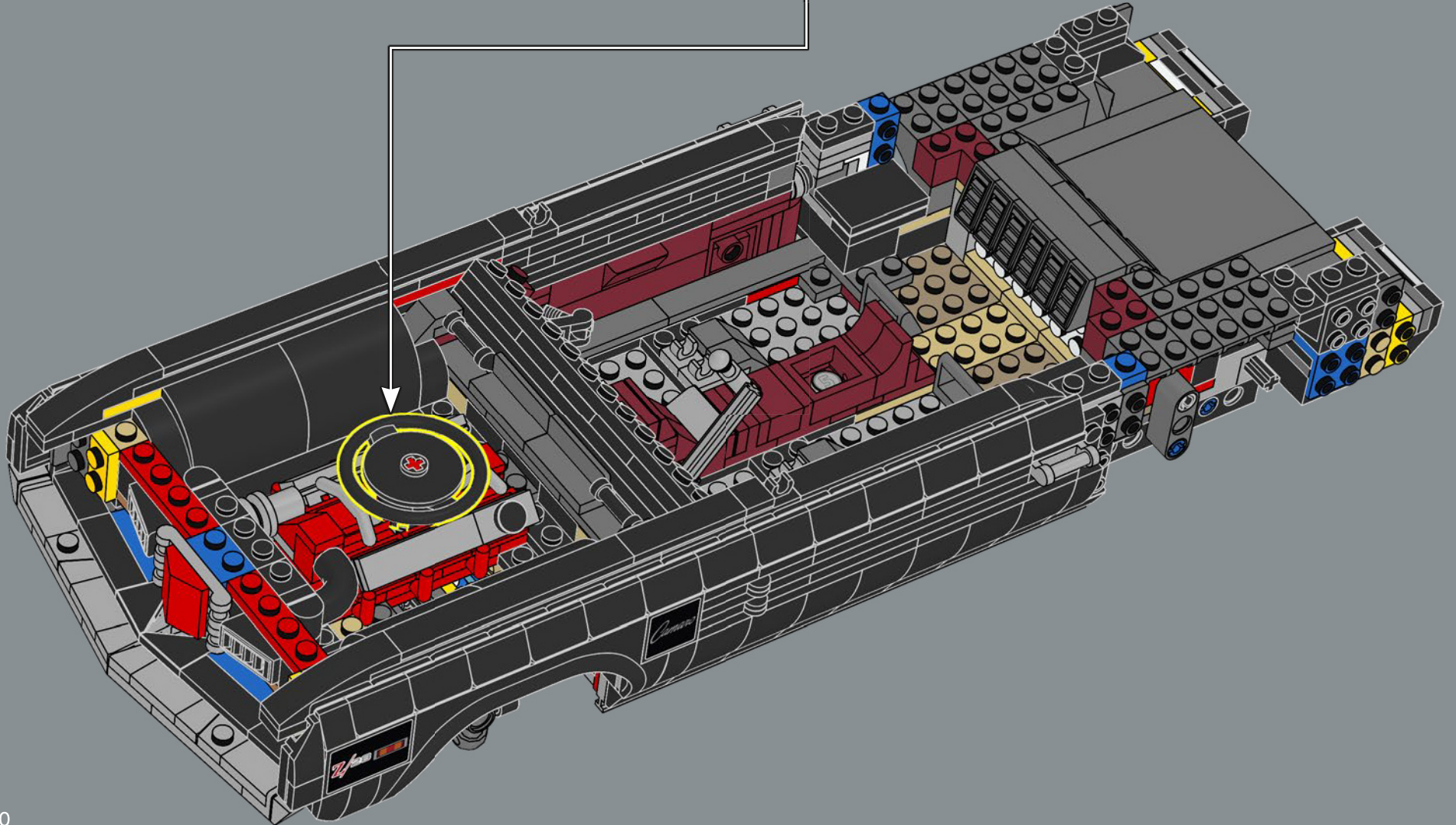
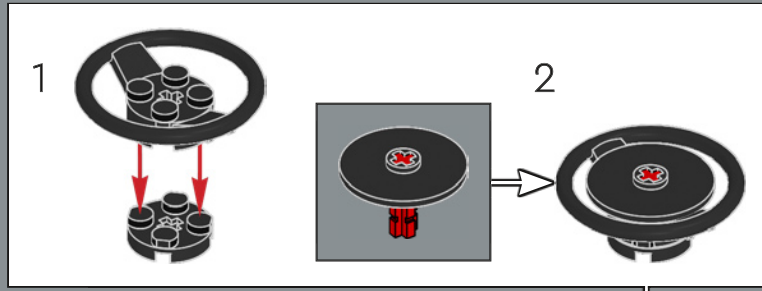

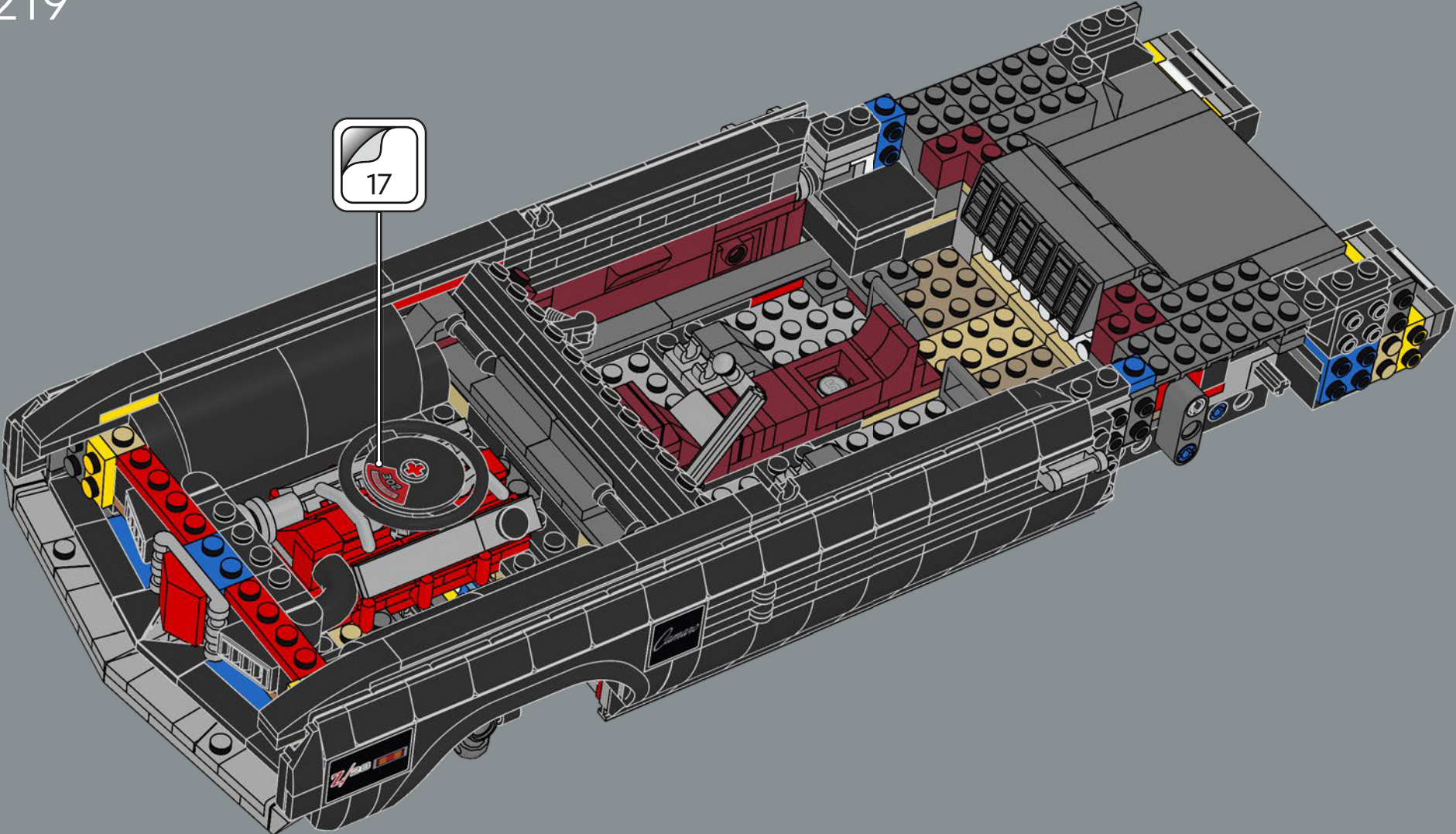

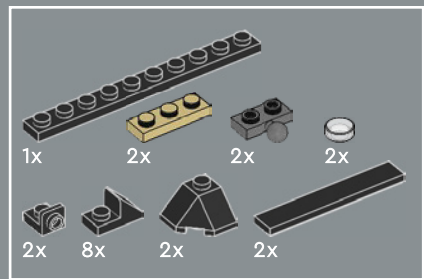

220

1

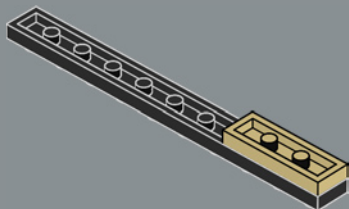

2

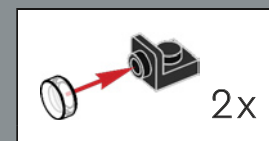
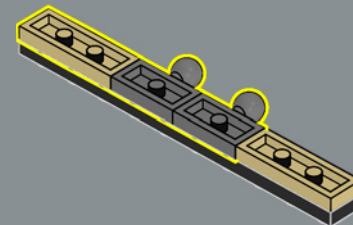

3

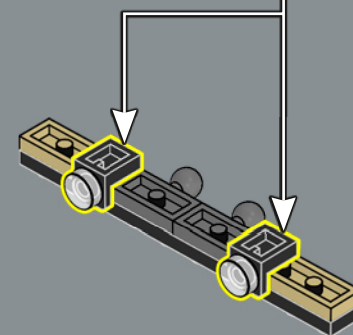

4

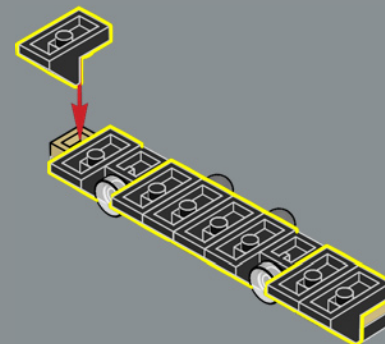

5

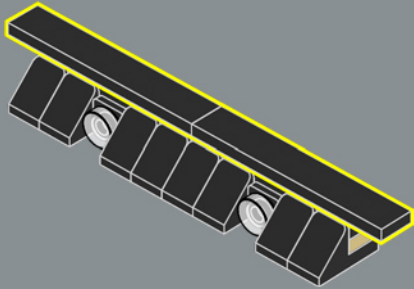

6

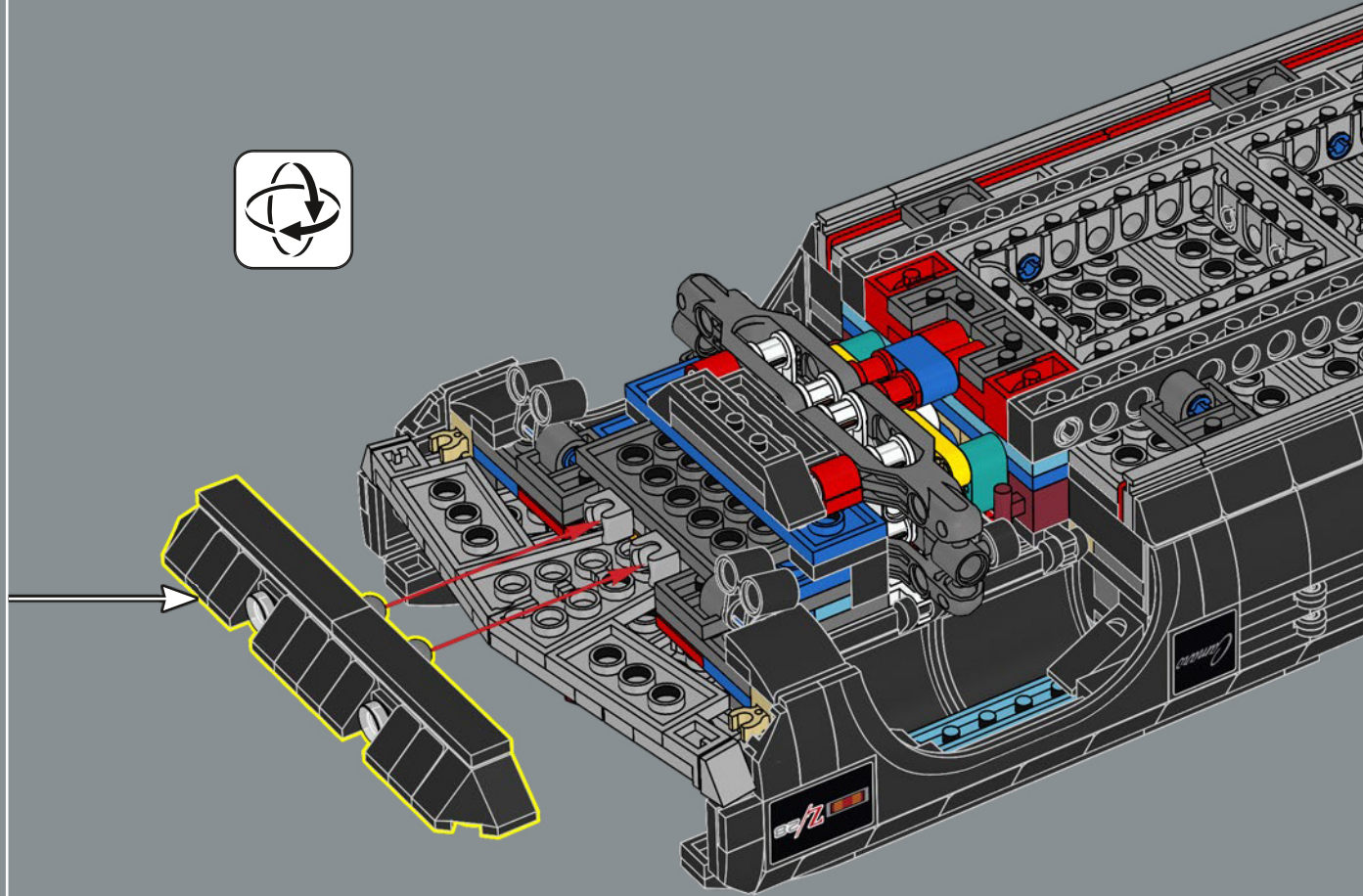
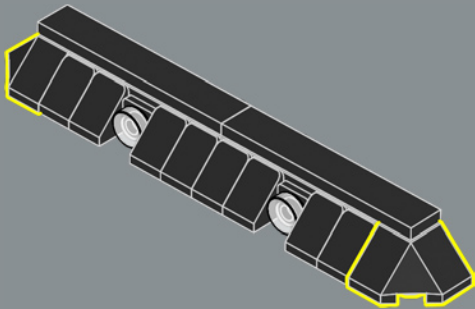

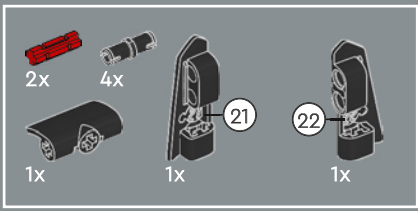

# 221

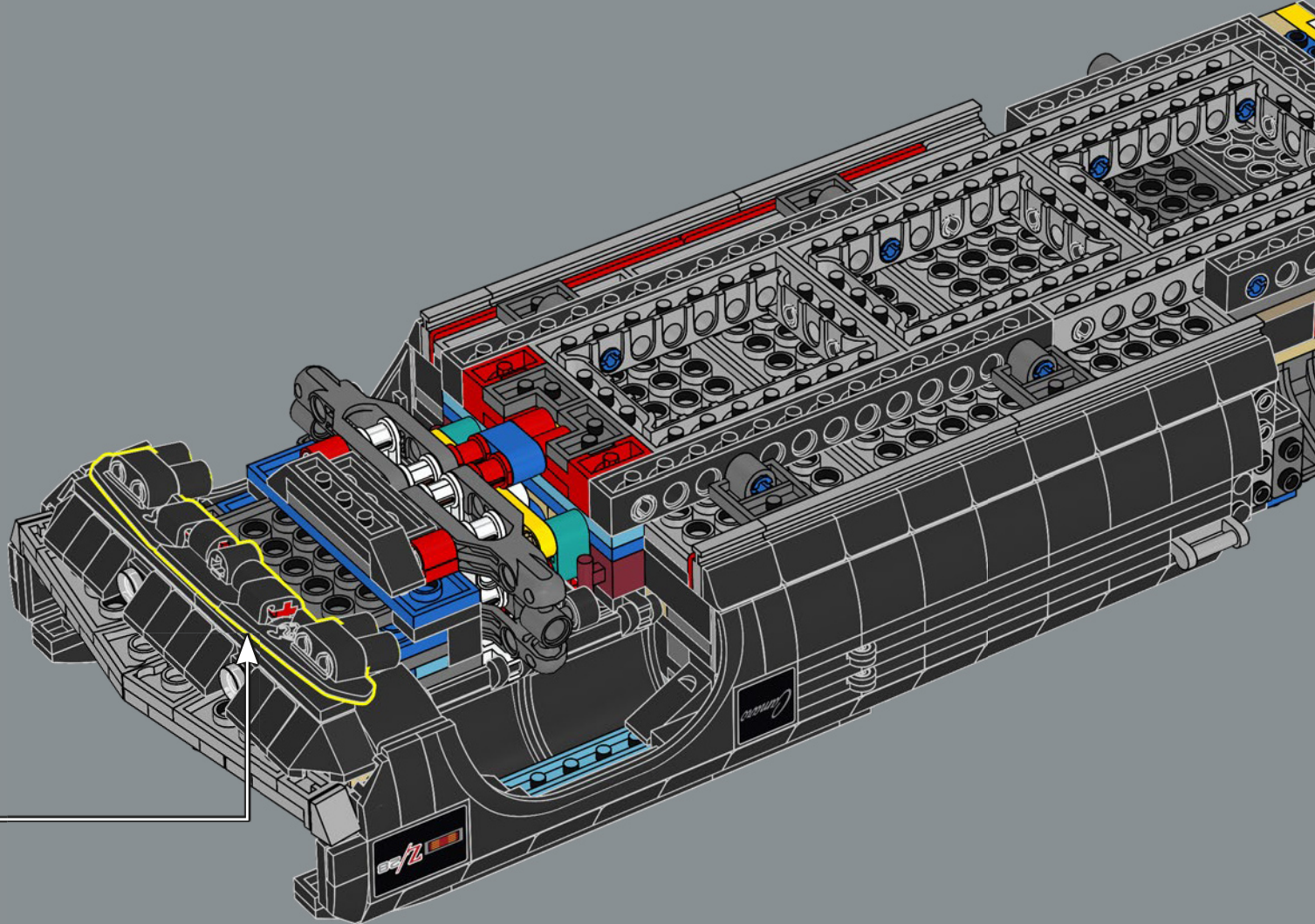
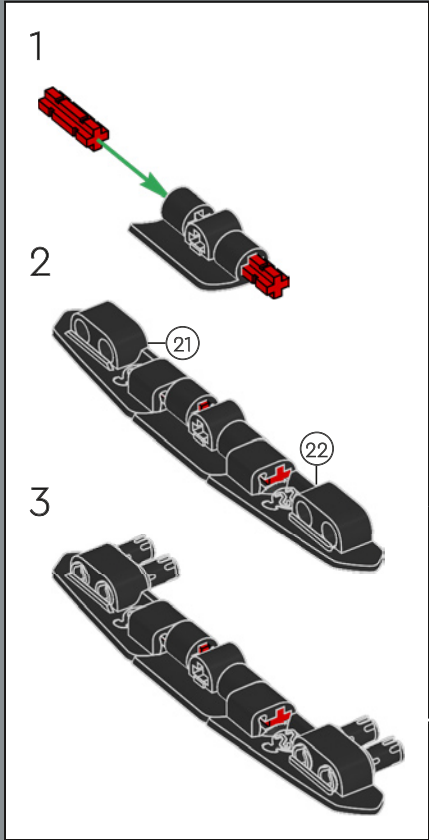





222

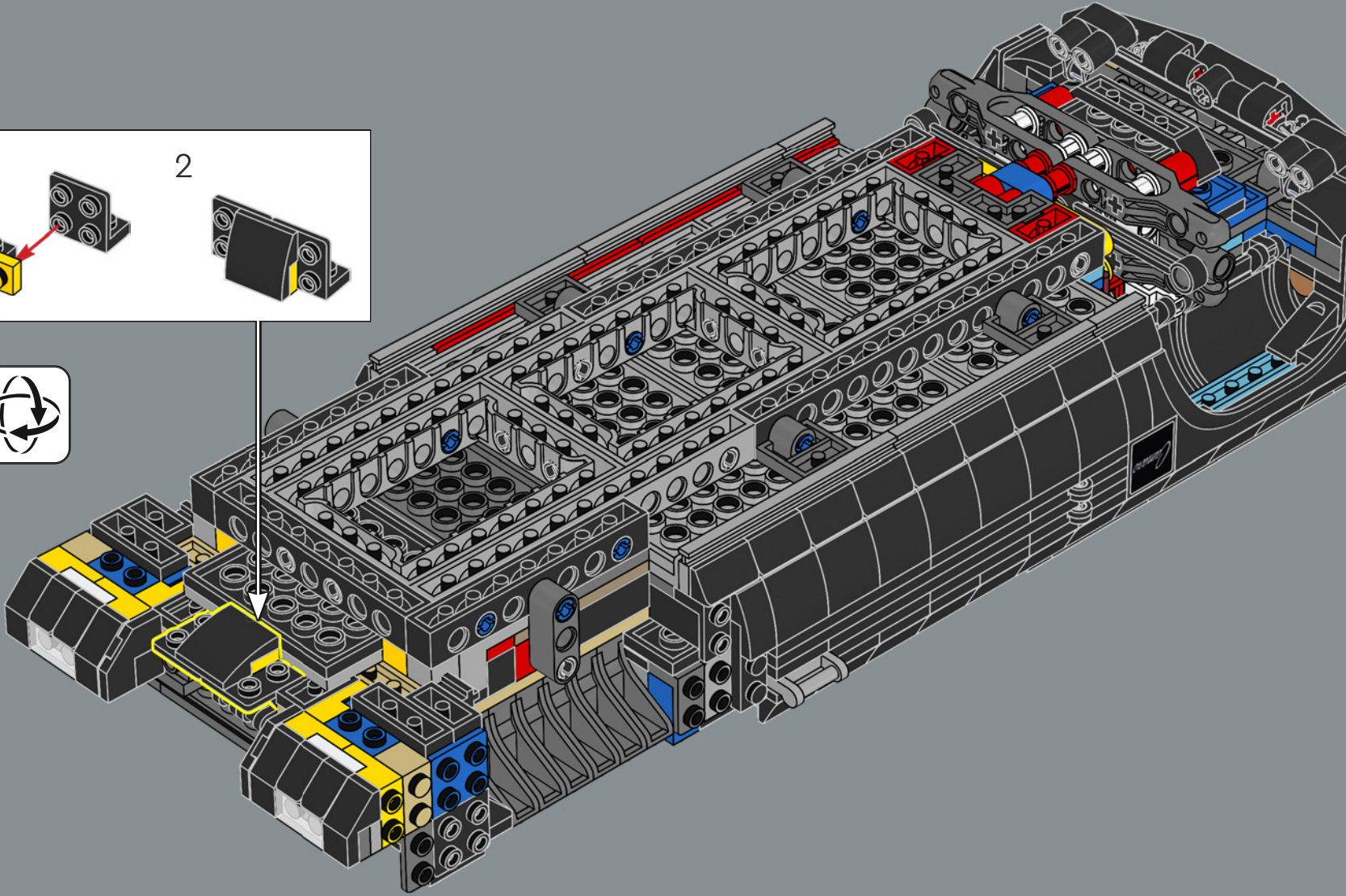
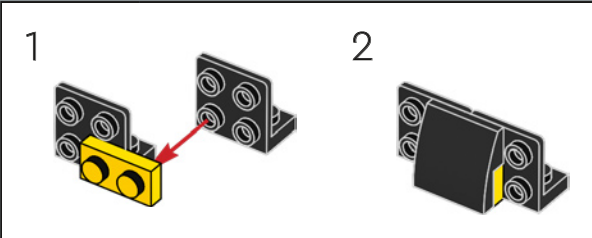

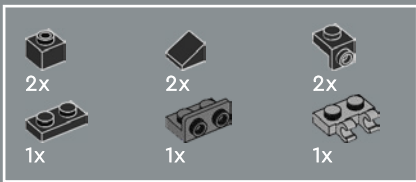

# 223

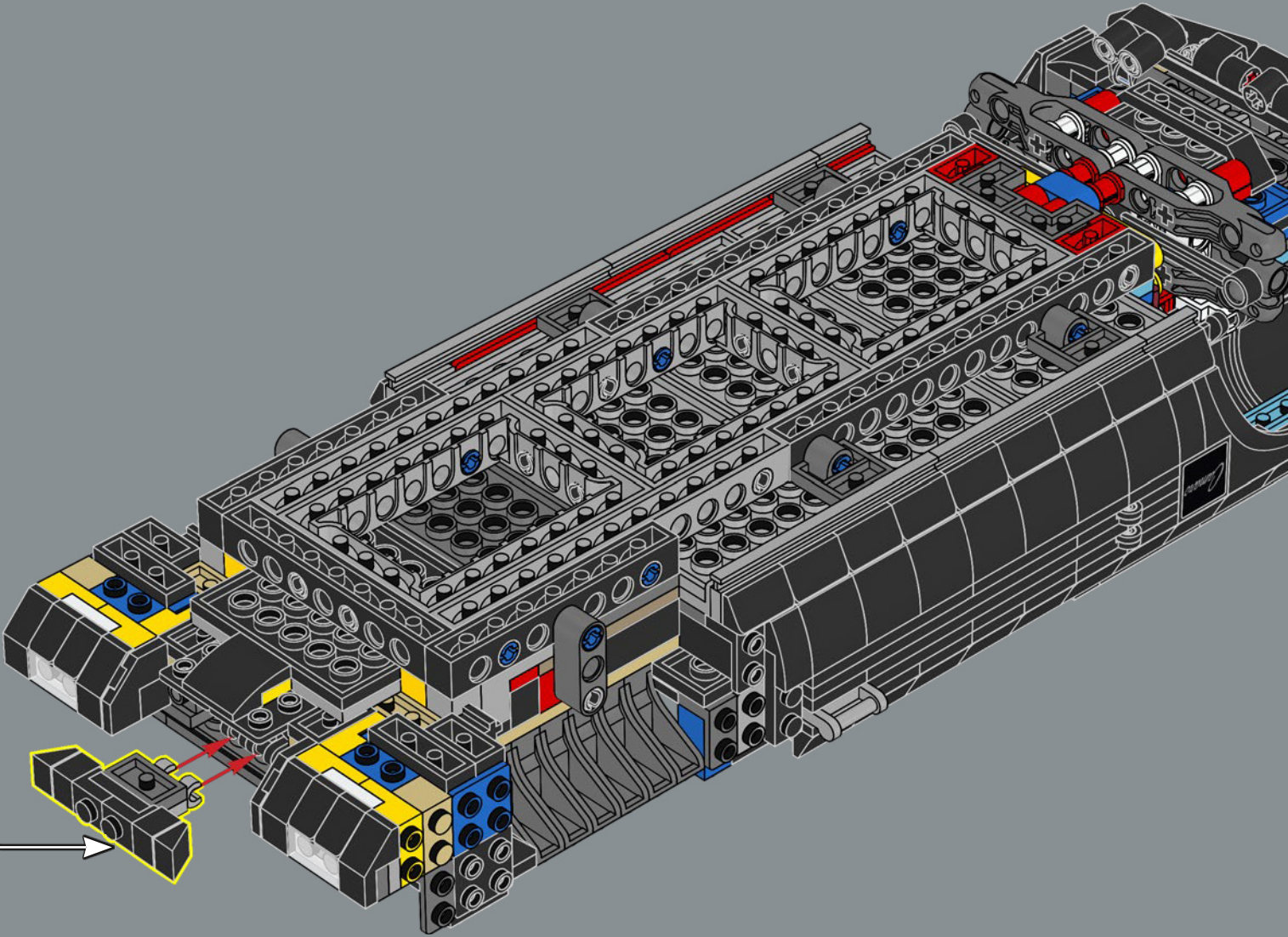
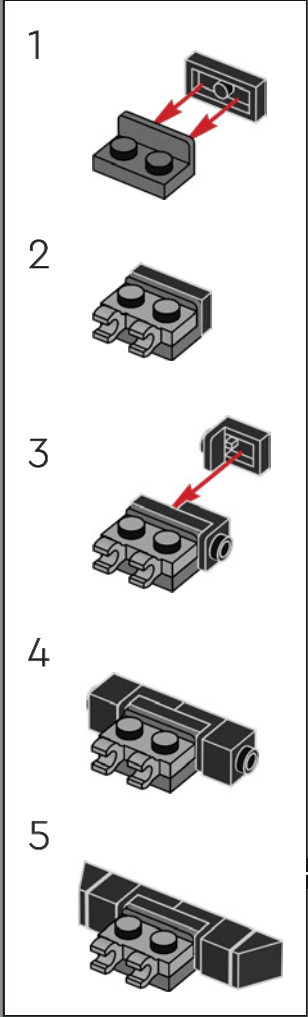

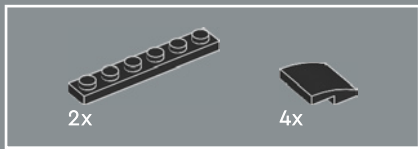

224

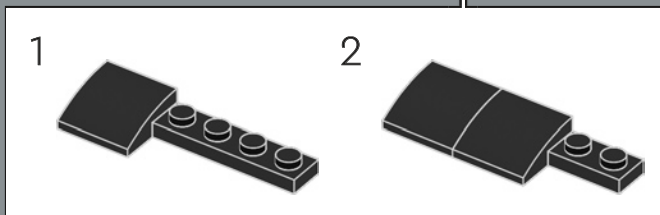
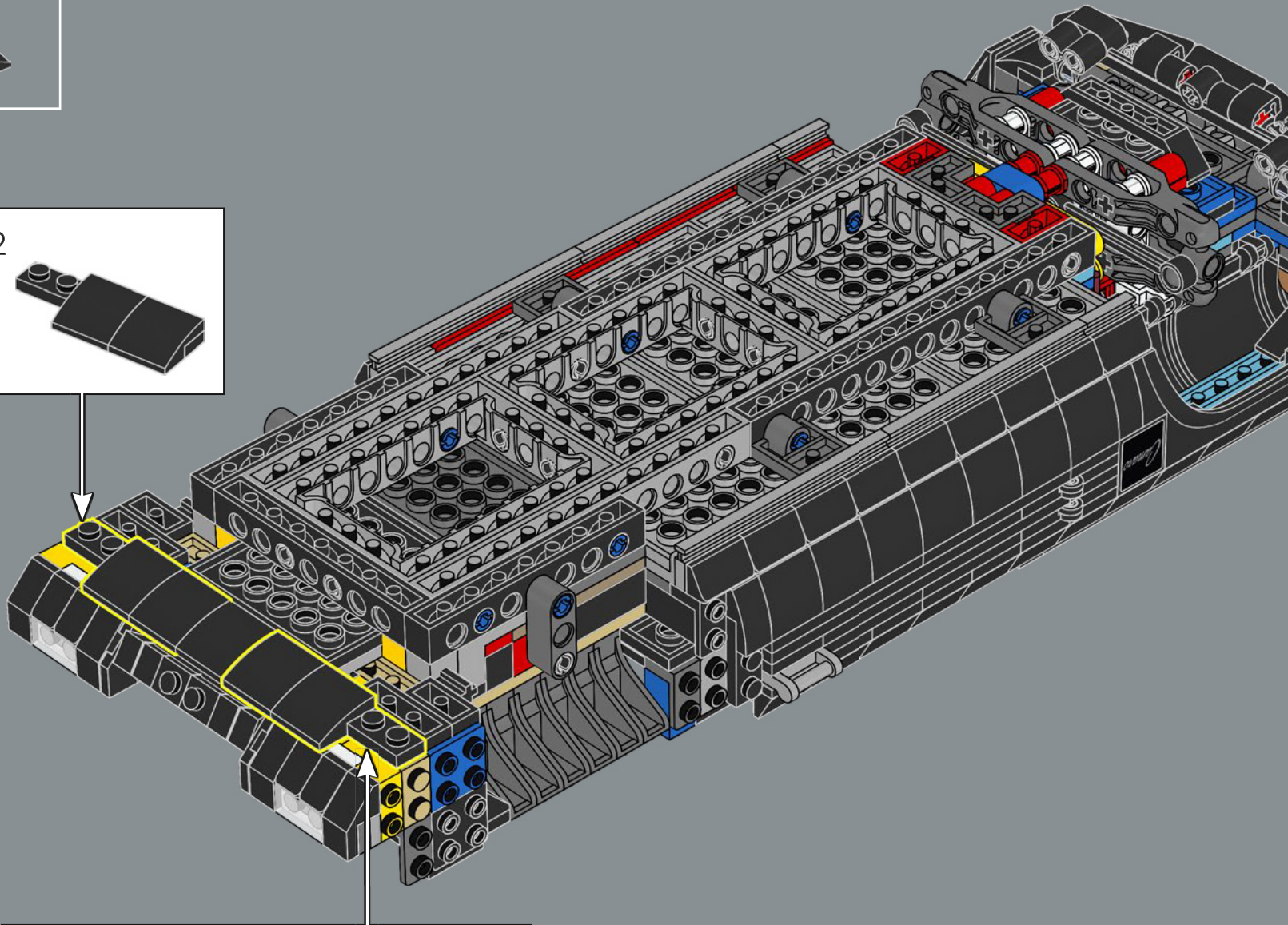
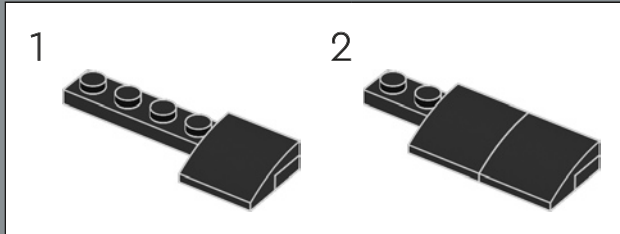



225

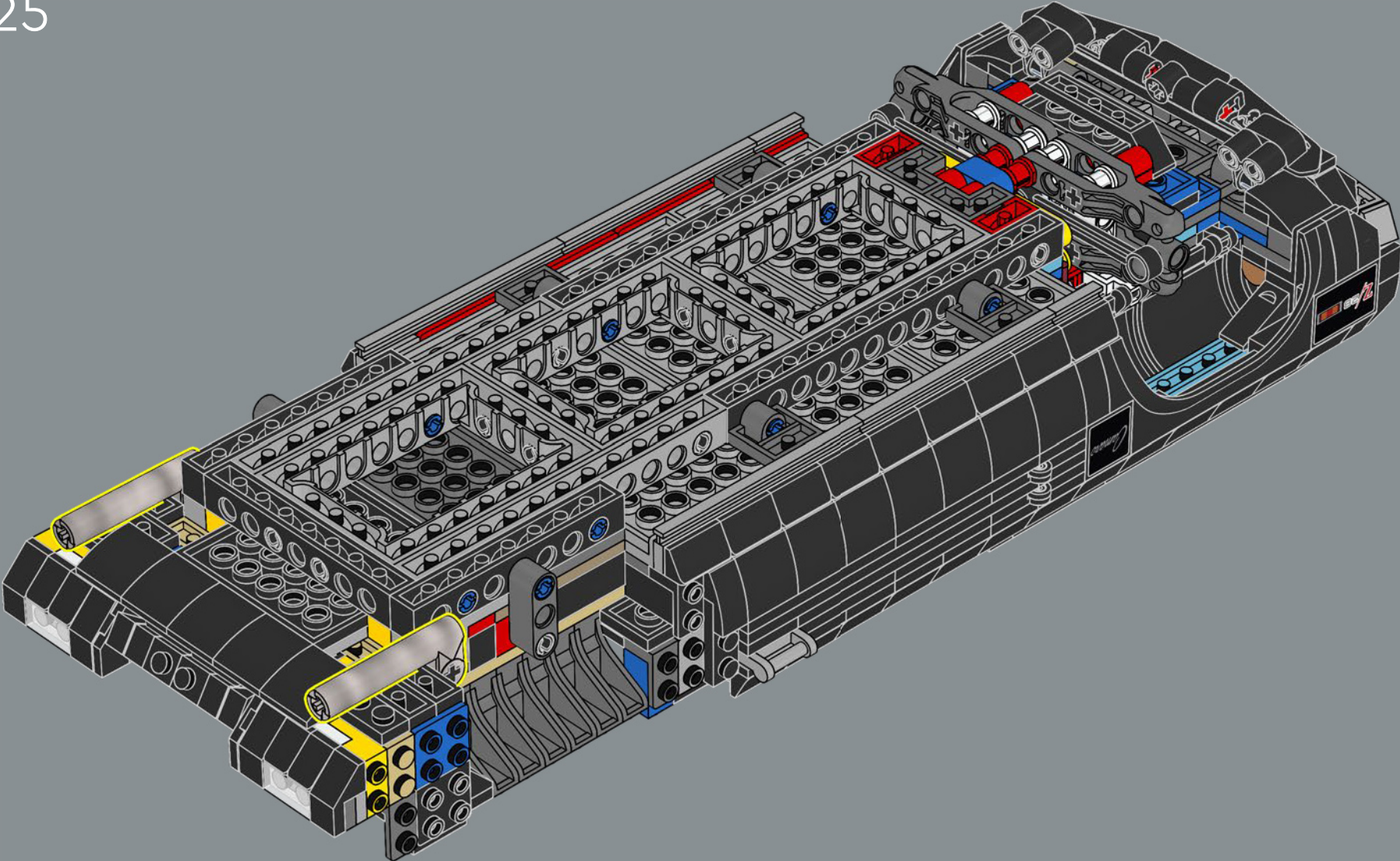

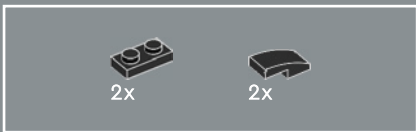

226

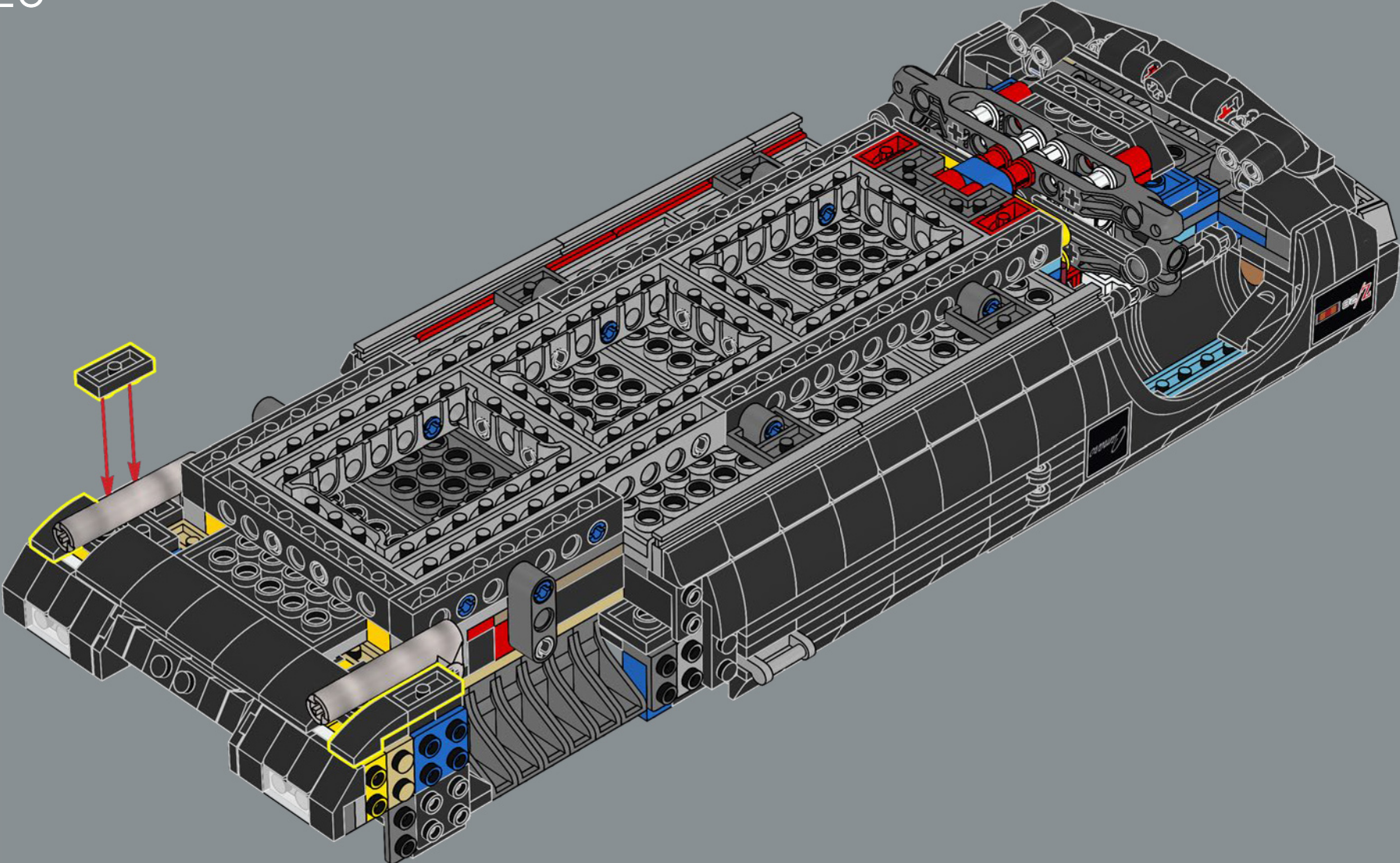

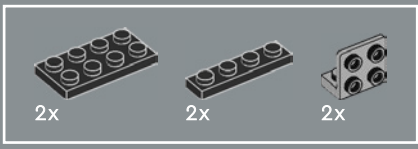

227

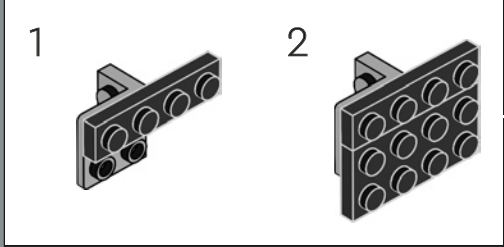
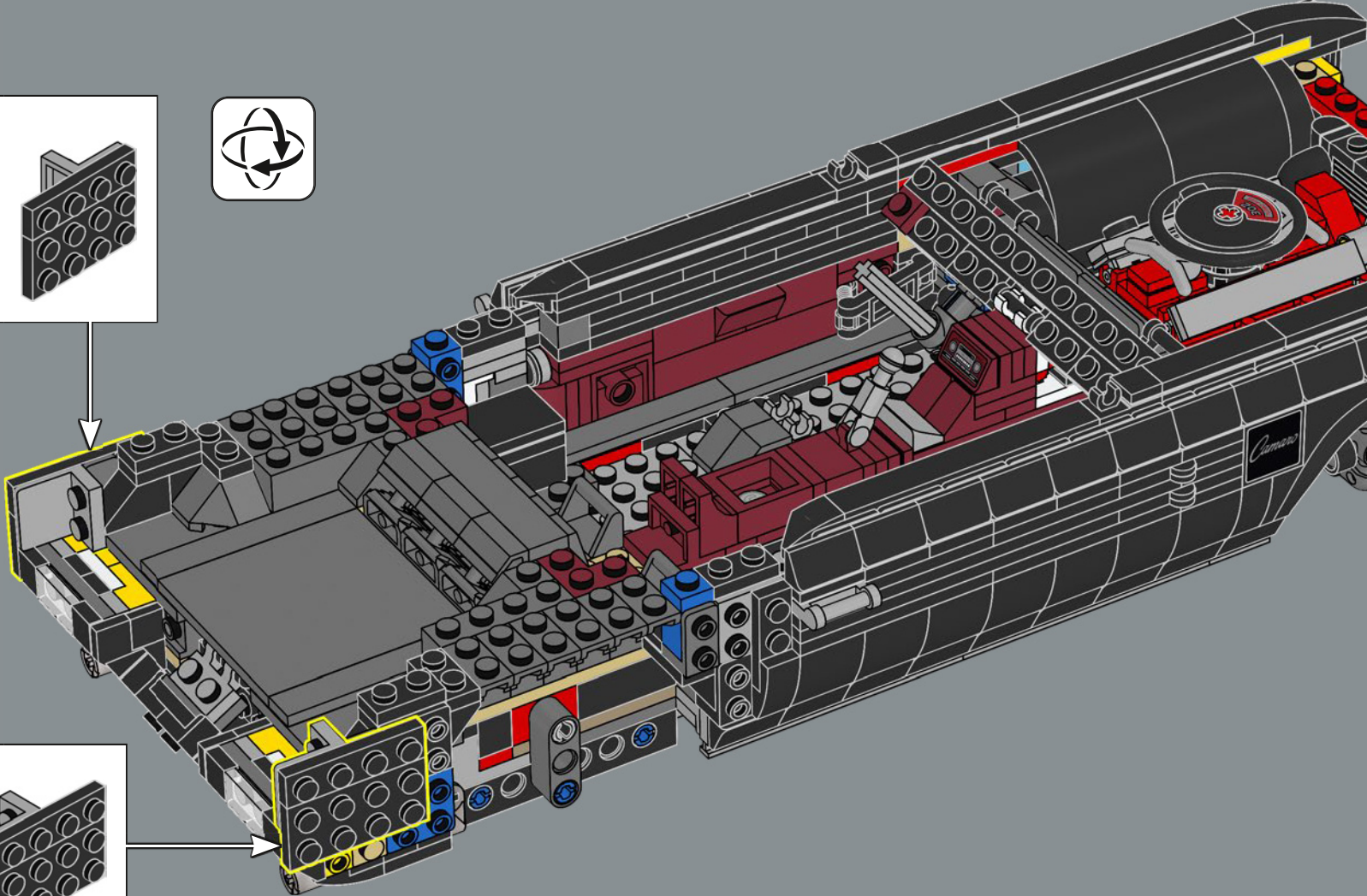
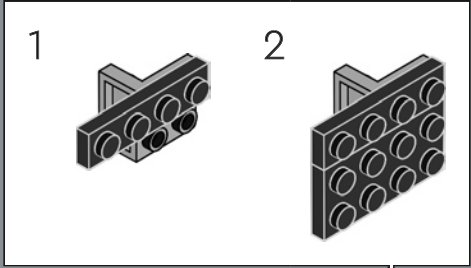

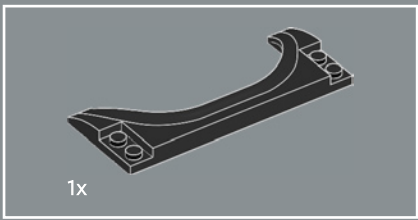

228

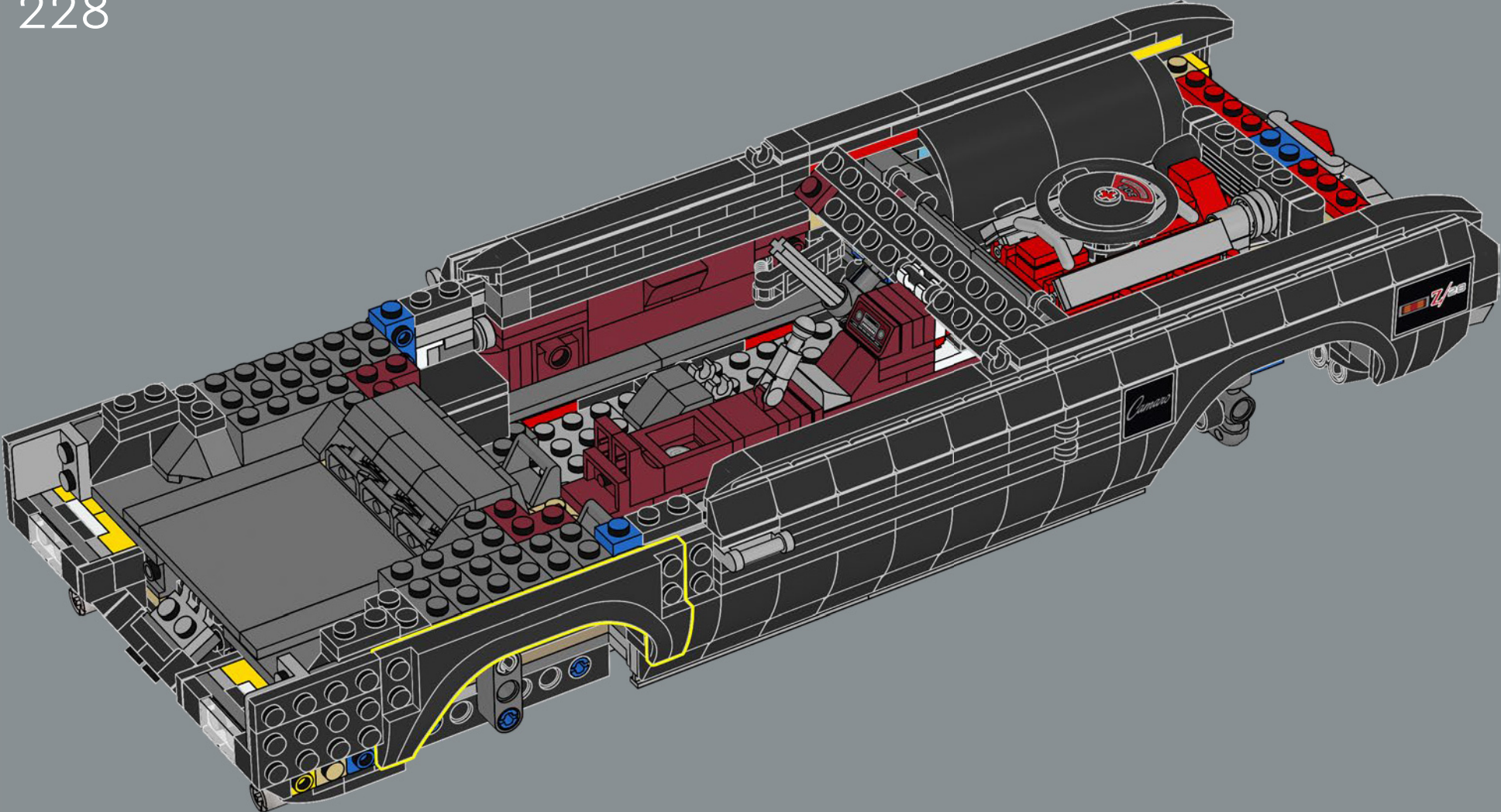

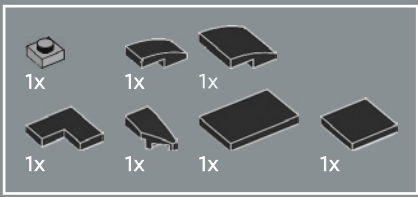

229

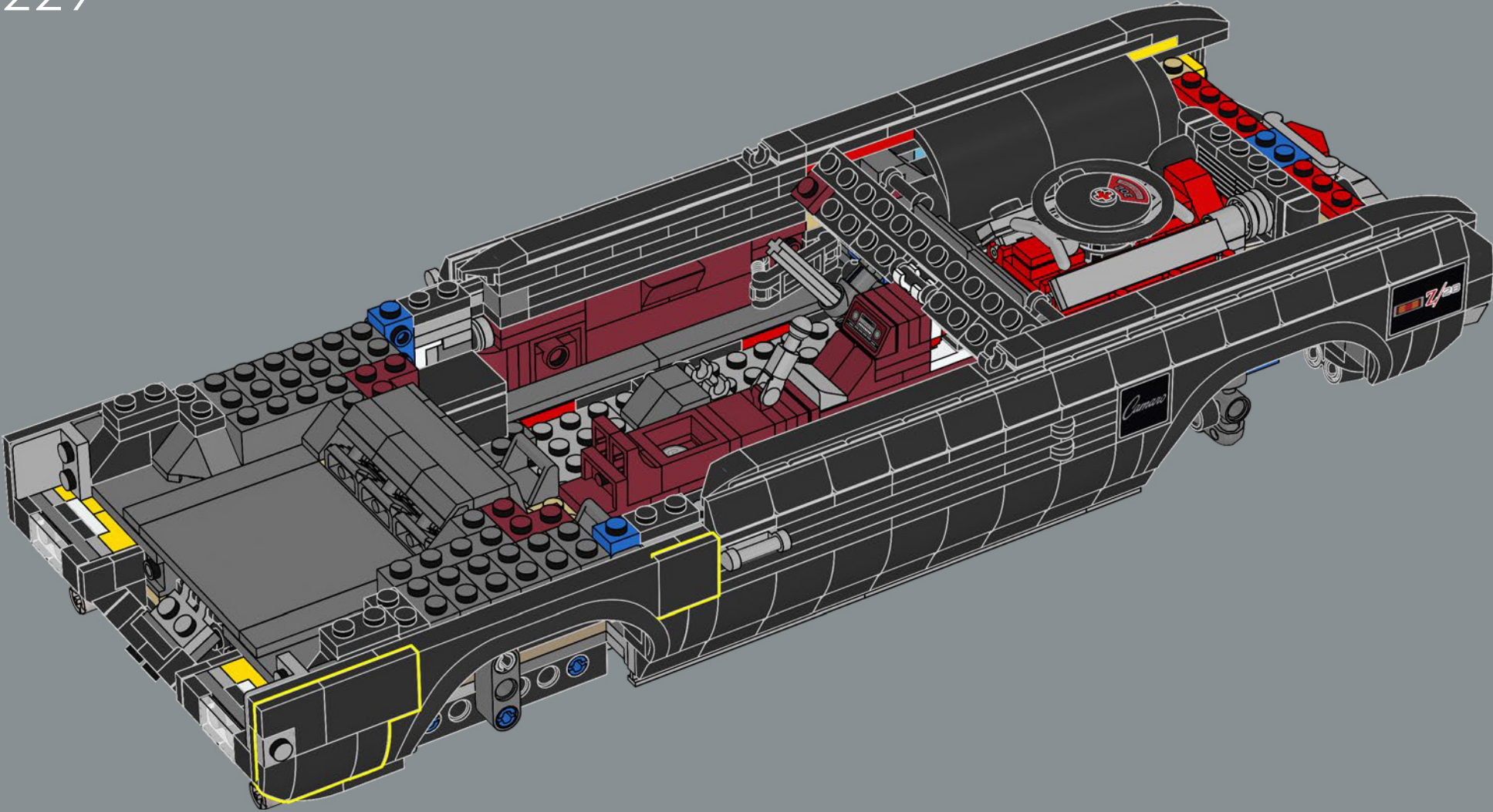



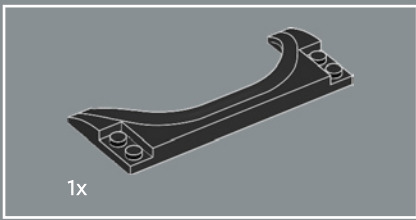

230

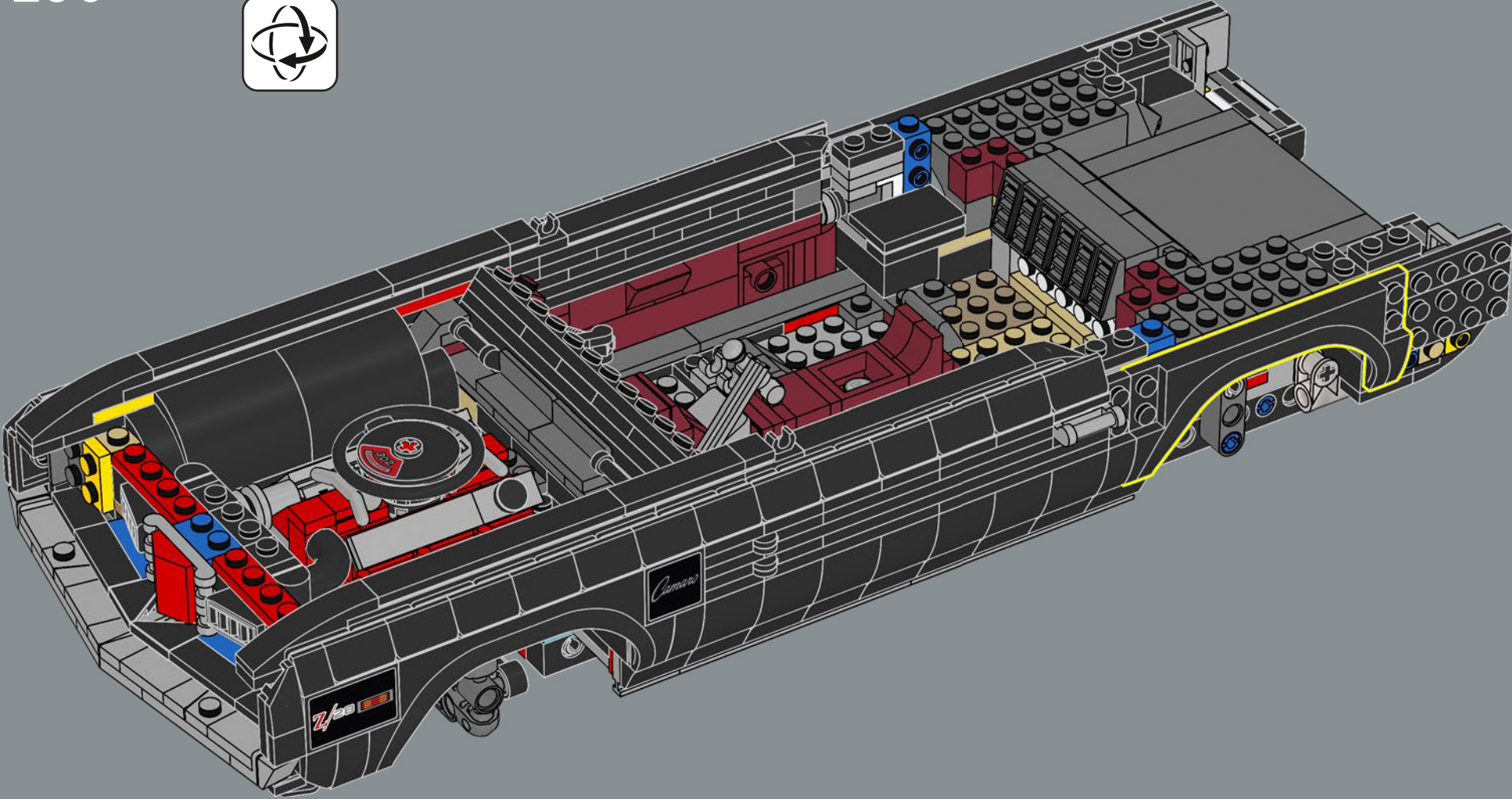

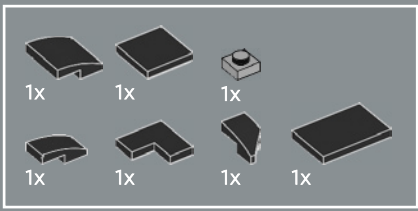

231

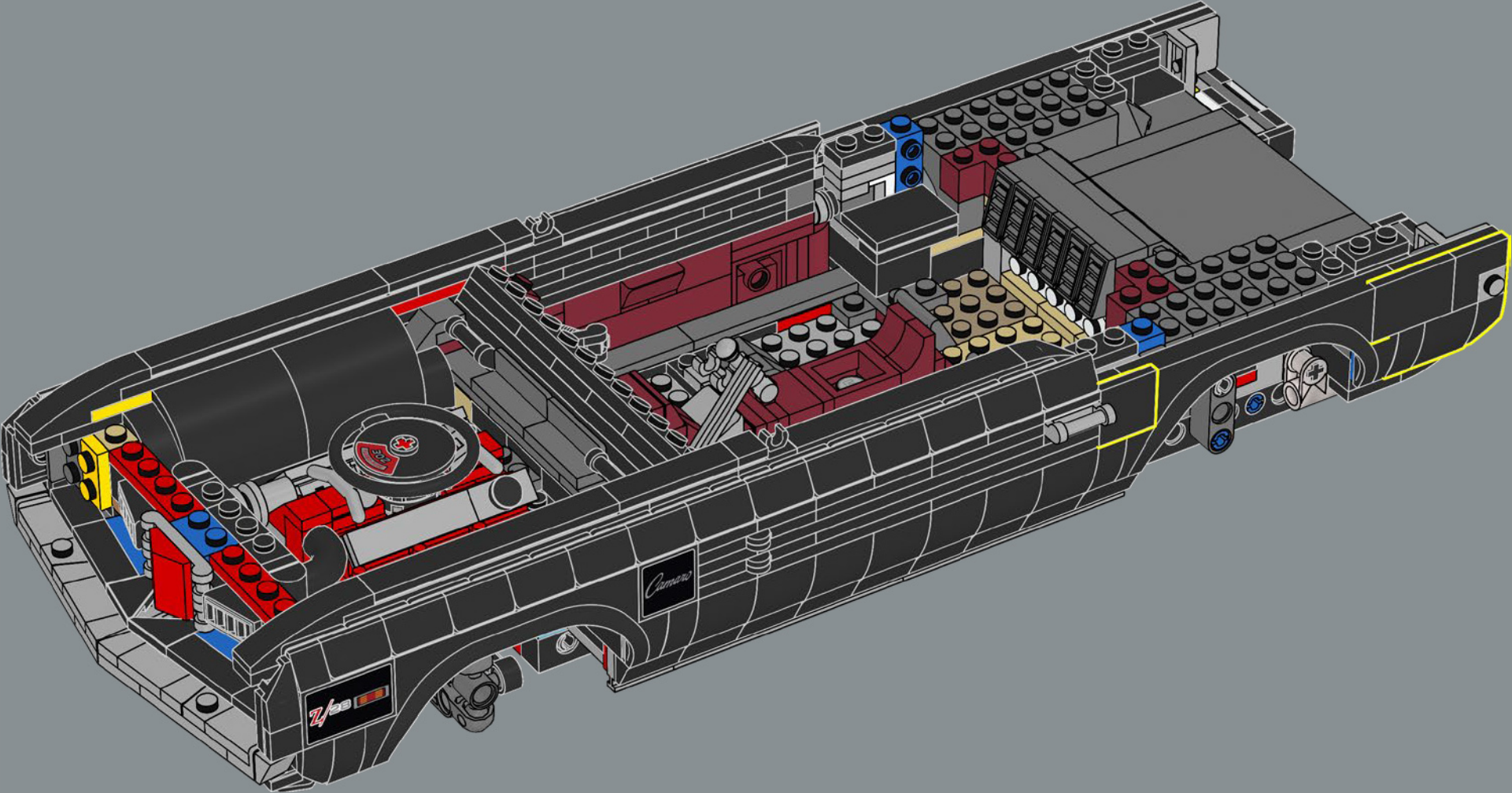

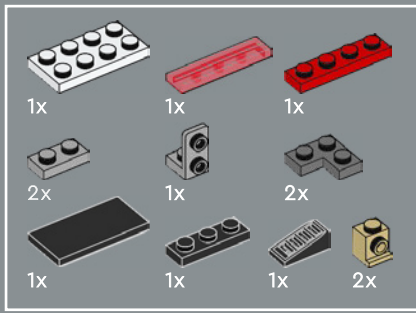

232

1



2



3

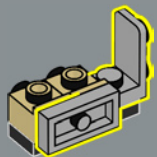

4

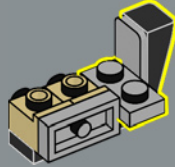

5

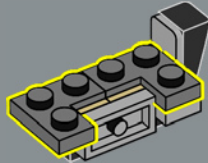

6

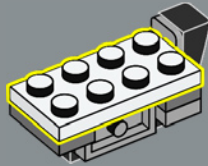

7

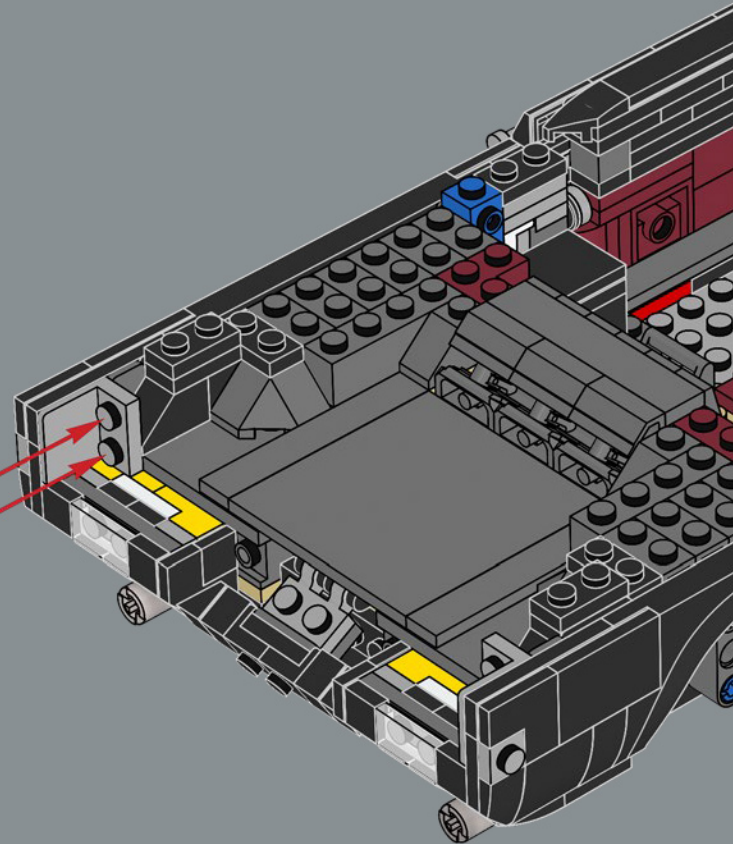
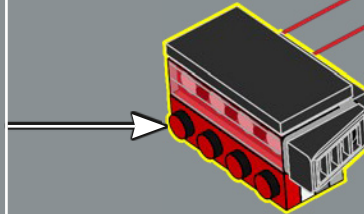
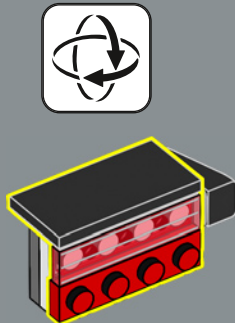

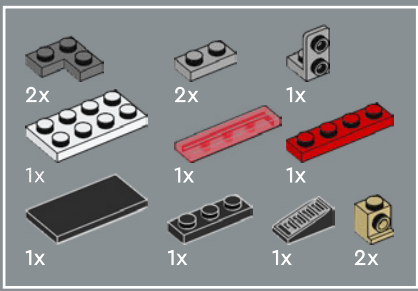

# 233

1



2

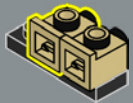

3

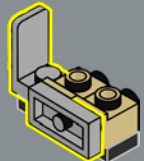

4

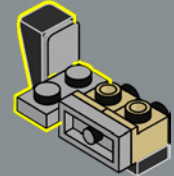

5

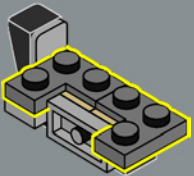

6

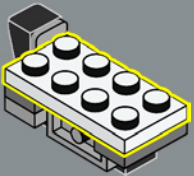

7

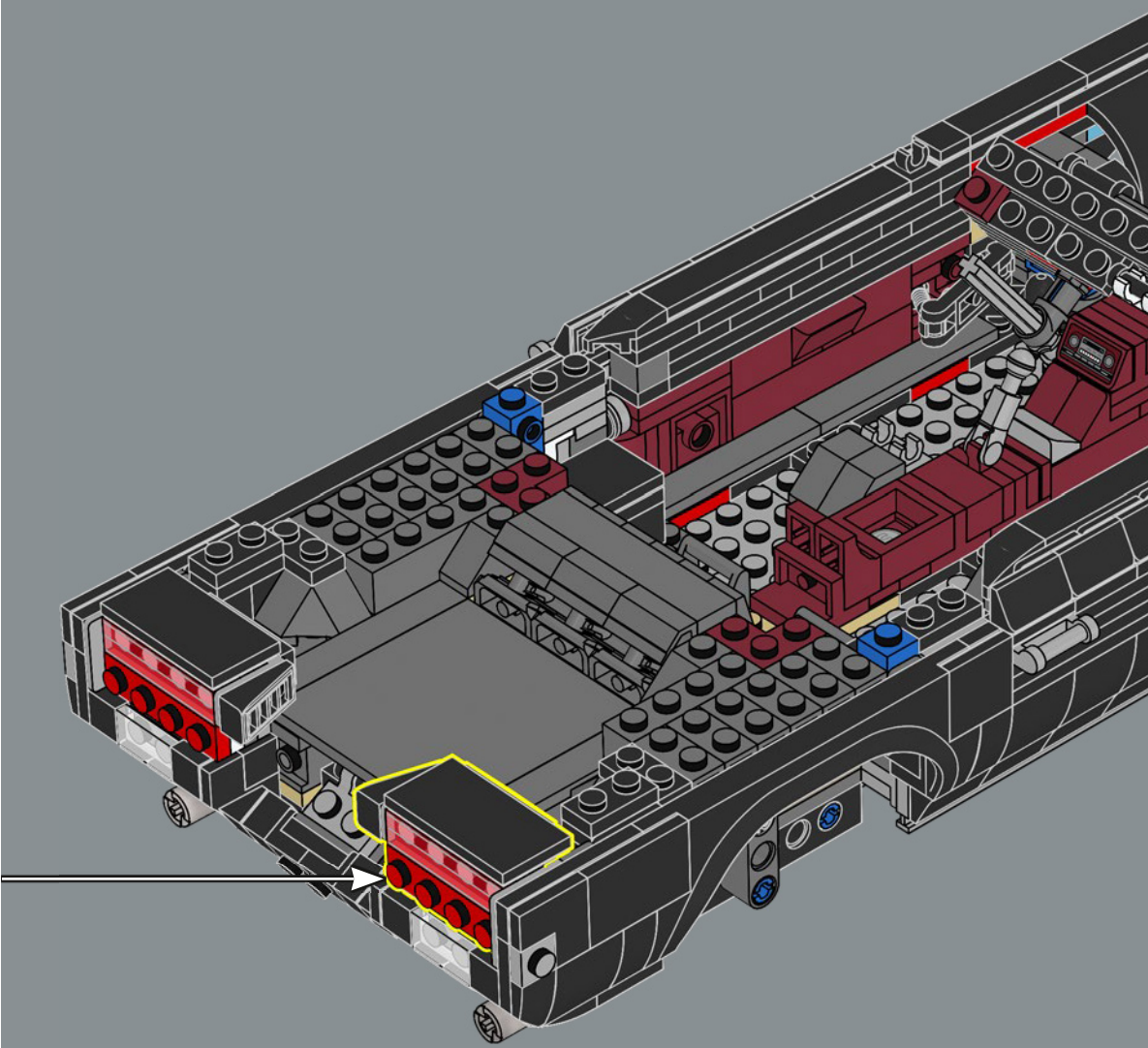
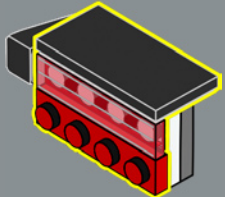

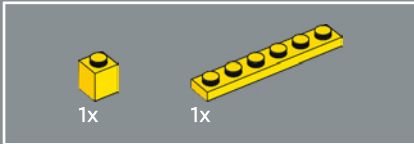
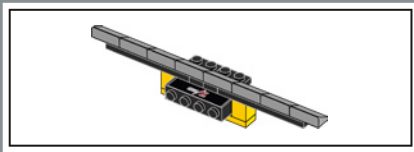

234

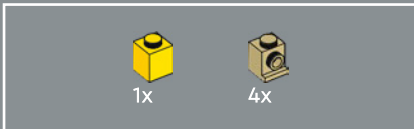
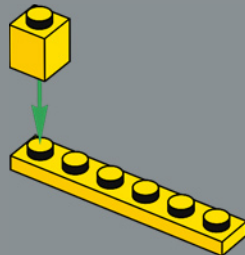

235

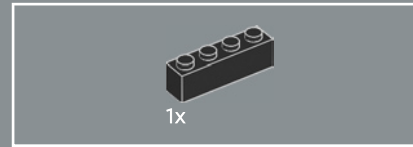
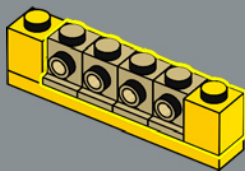

236

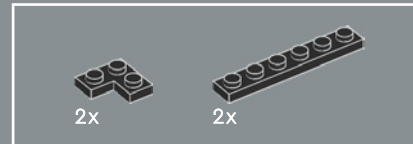
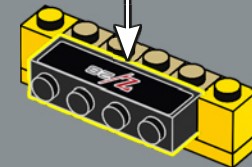
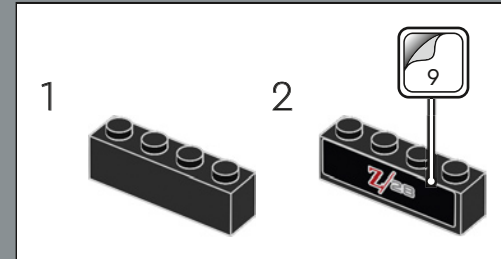

237

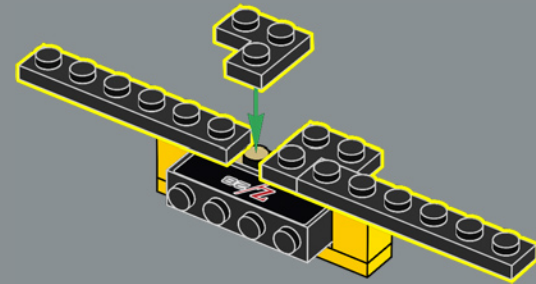



2x

238

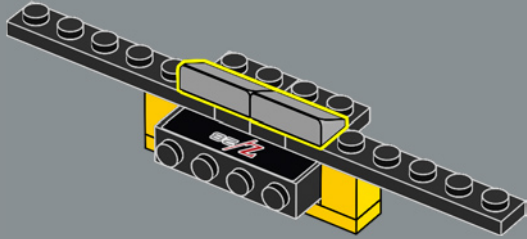

6x

239

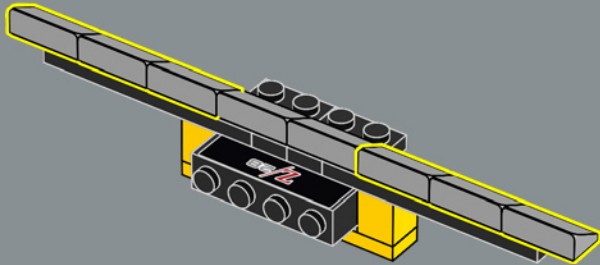

240

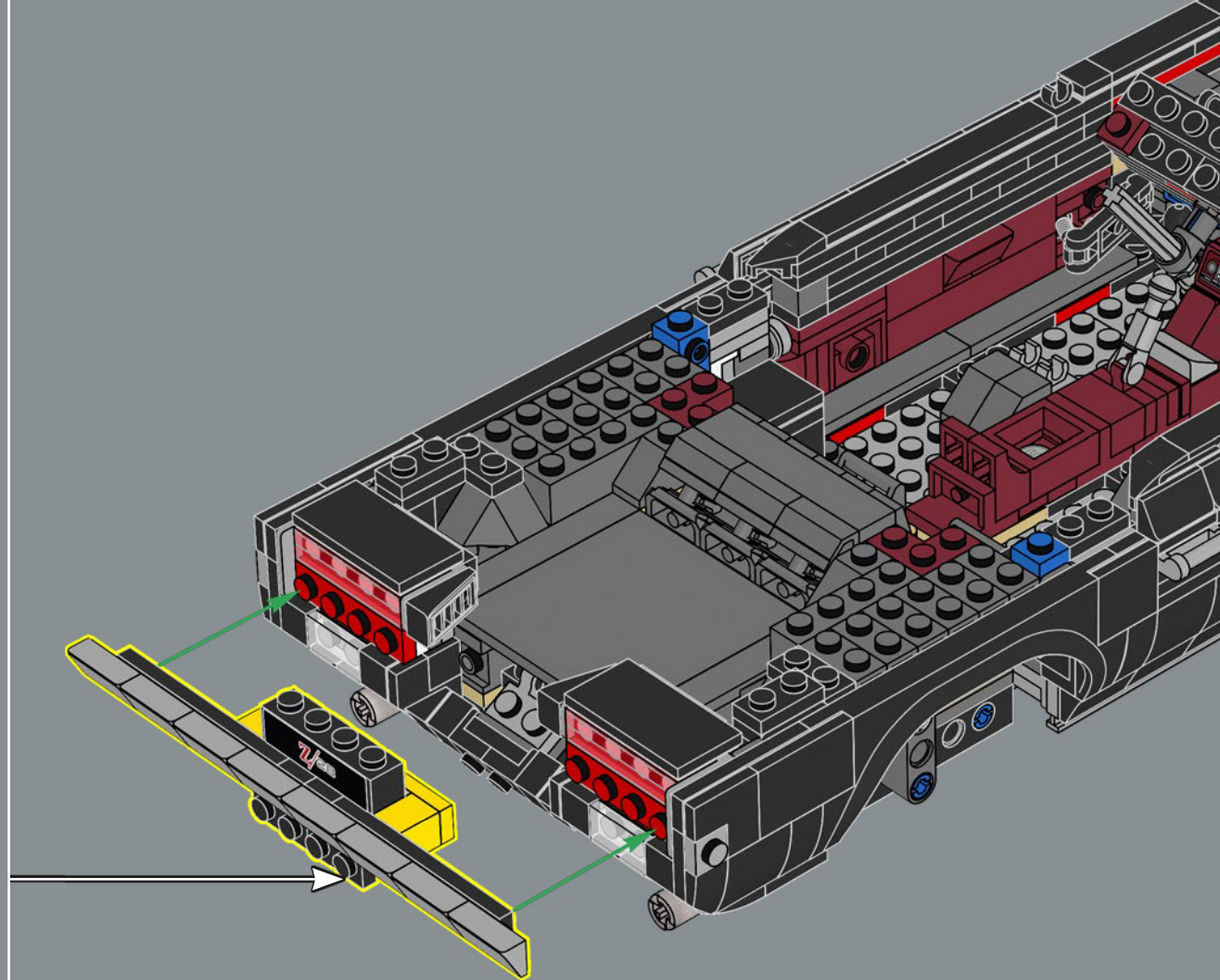

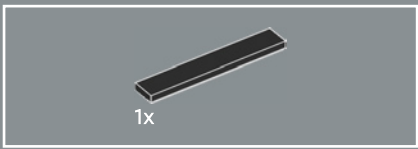

241

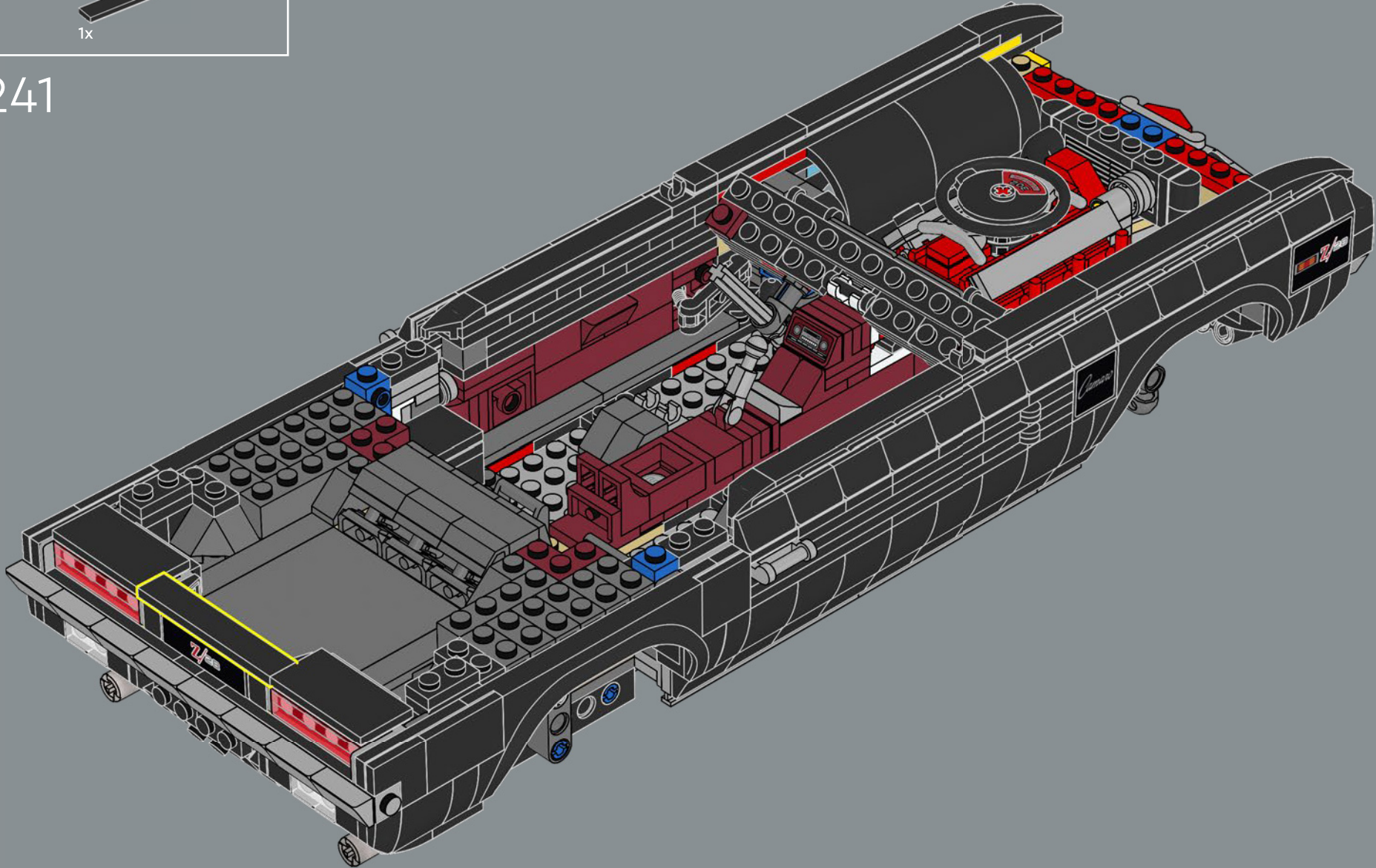



242

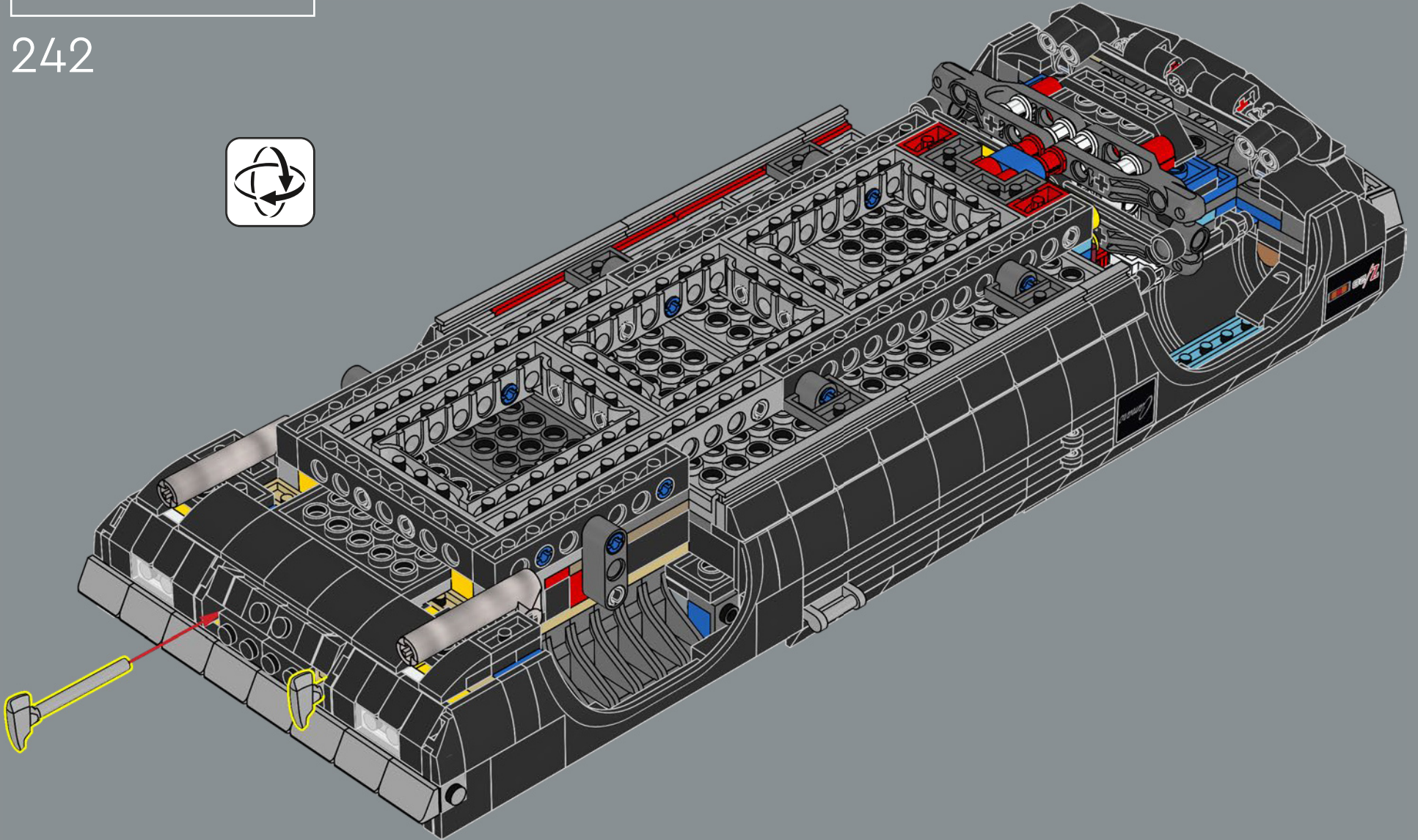



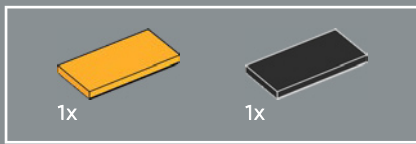

243

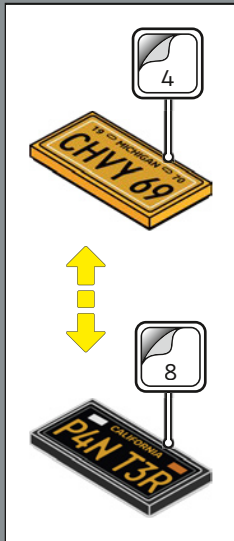

Unlike most Chevrolets, the first 3 generation Camaros weren't built in Detroit, they were manufactured in the Norwood, Ohio and Van Nuys, California plants.

Contrairement à la plupart des Chevrolet, les Camaro de la troisième génération n'ont pas été fabriquées à Détroit, mais dans les usines de Norwood, Ohio et de Van Nuys, Californie.

A diferencia de la mayoría de los autos Chevrolet, las 3 primeras generaciones del Camaro no se fabricaron en Detroit, sino en las plantas de Norwood (Ohio) y Van Nuys (California).

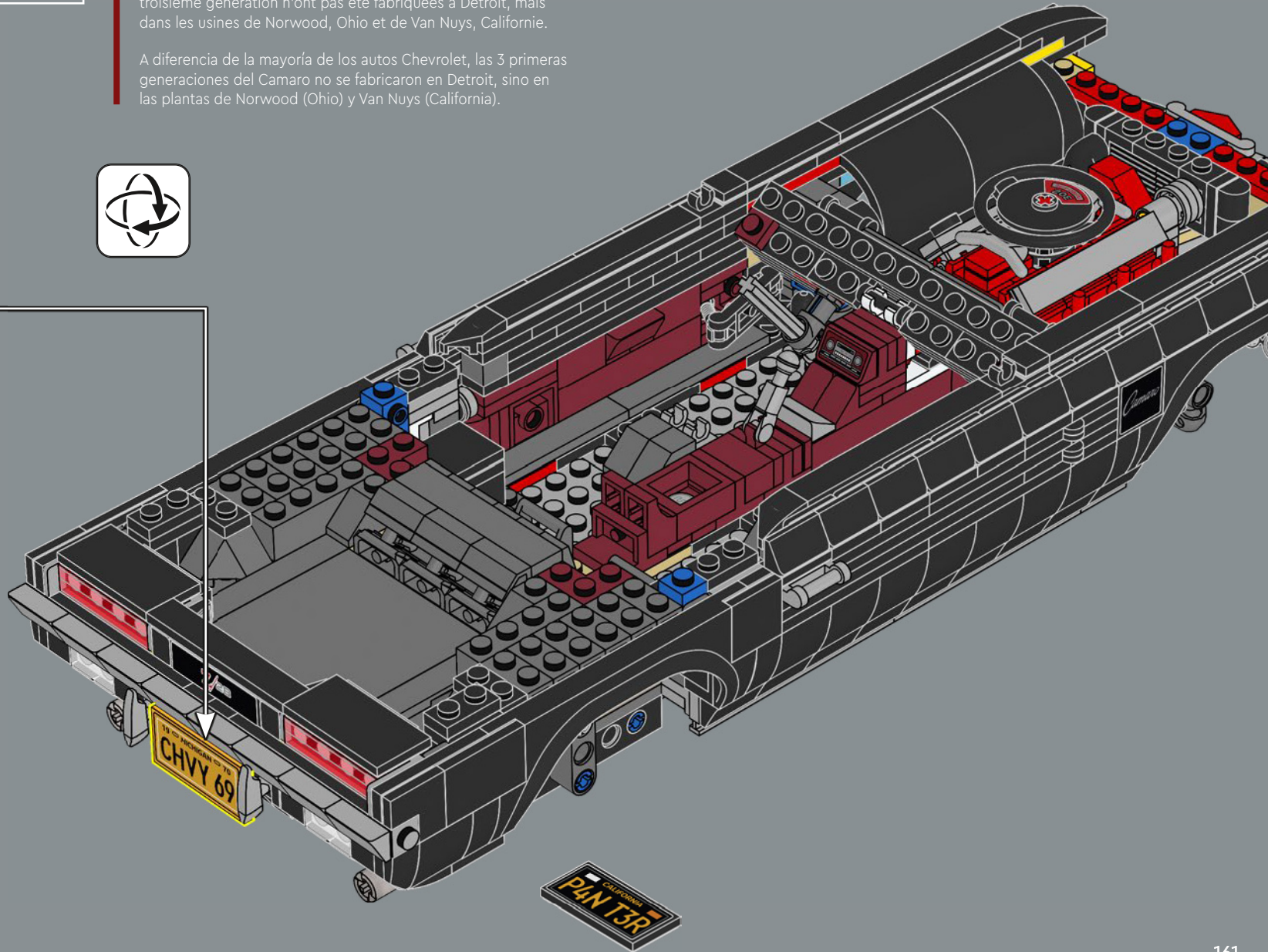

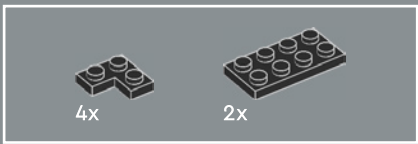

244

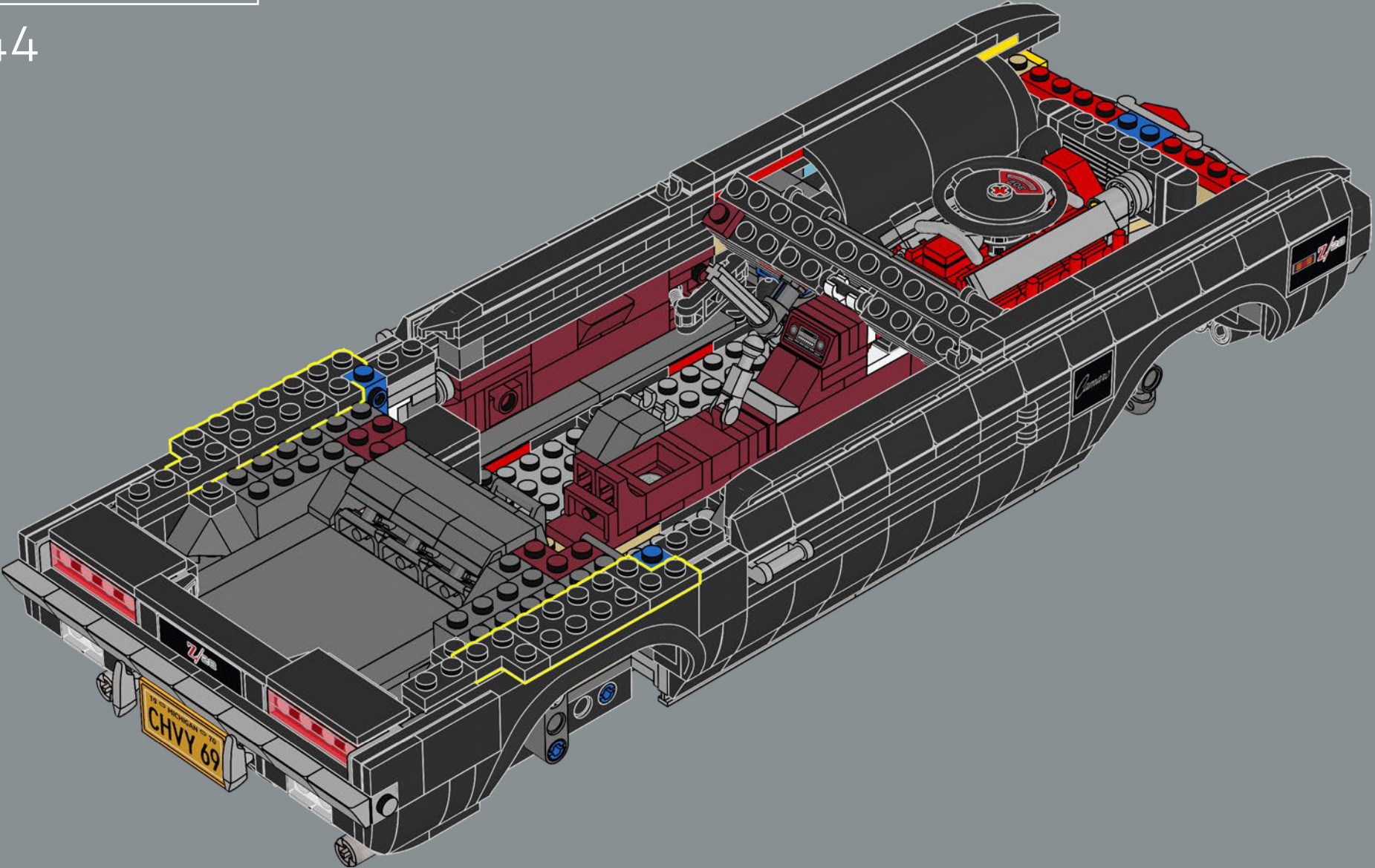

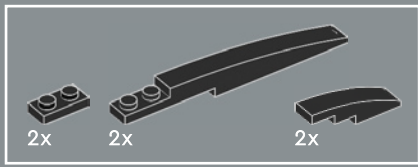

245

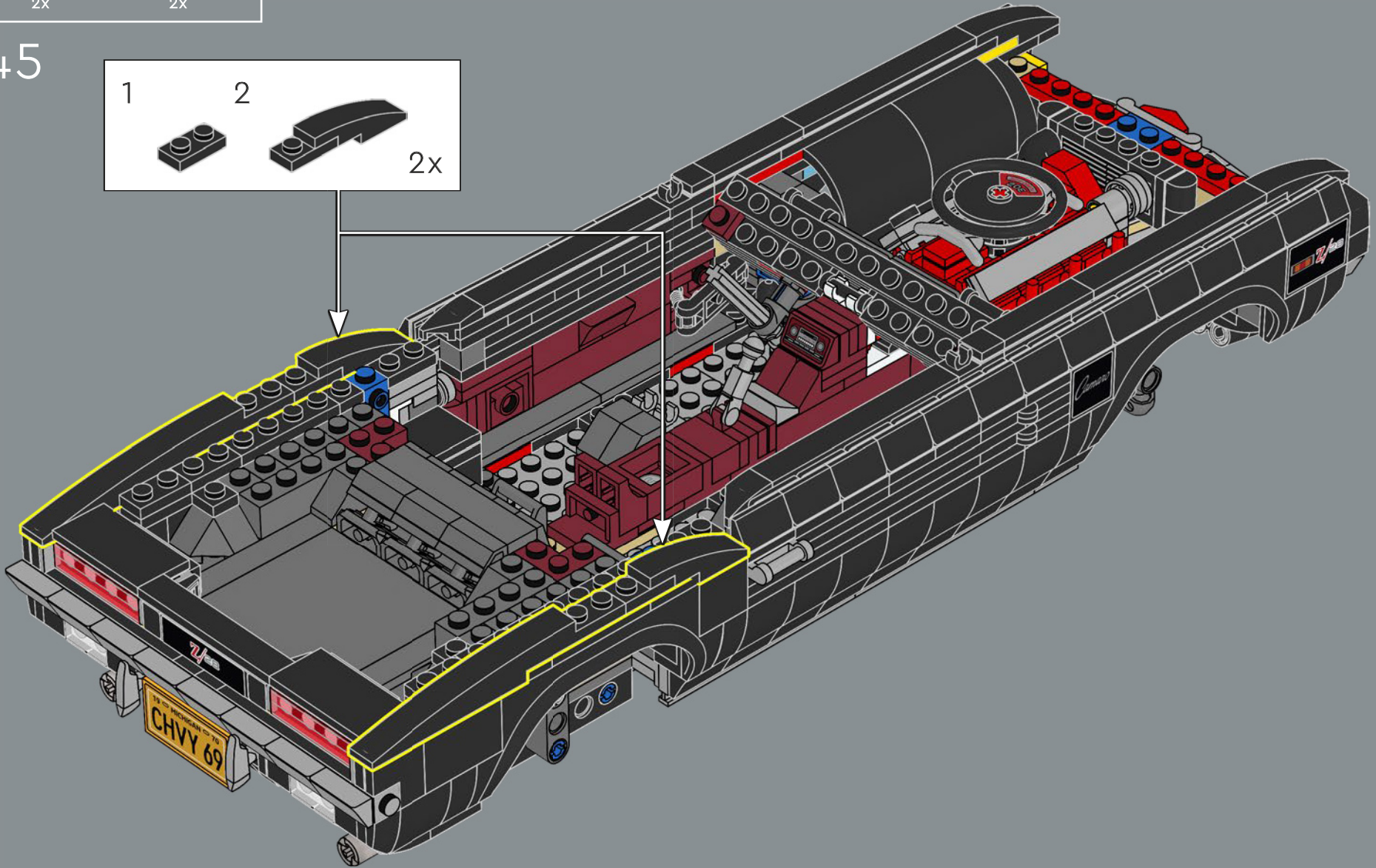
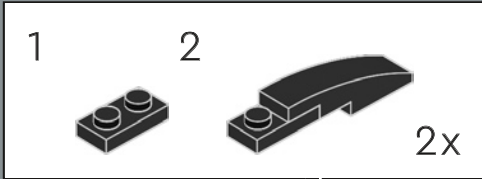

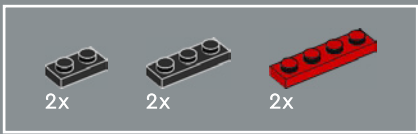

246

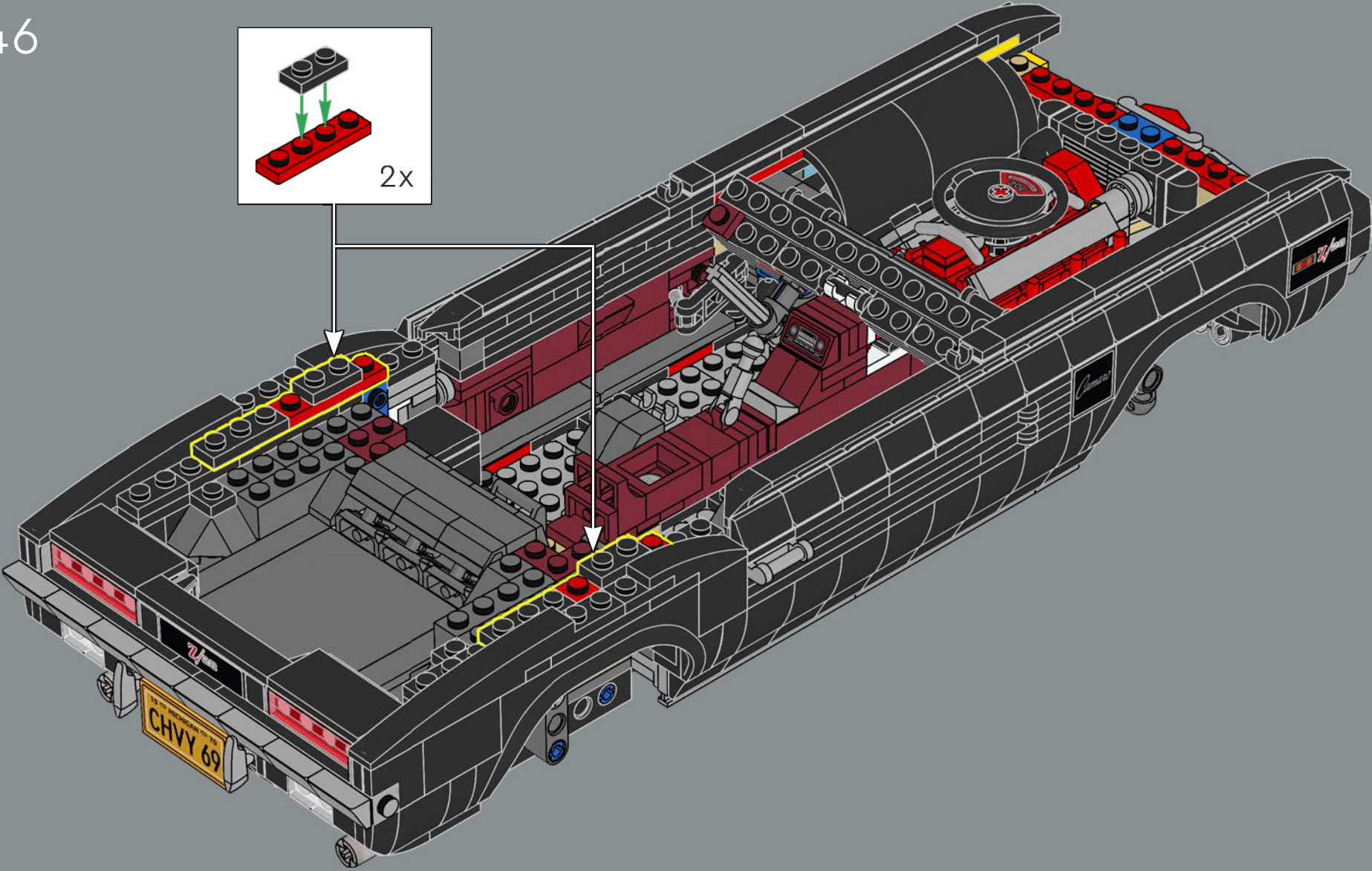
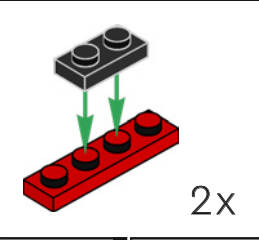

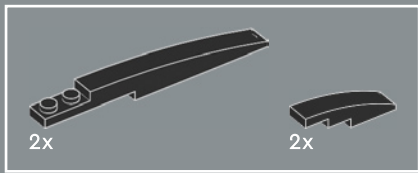

247

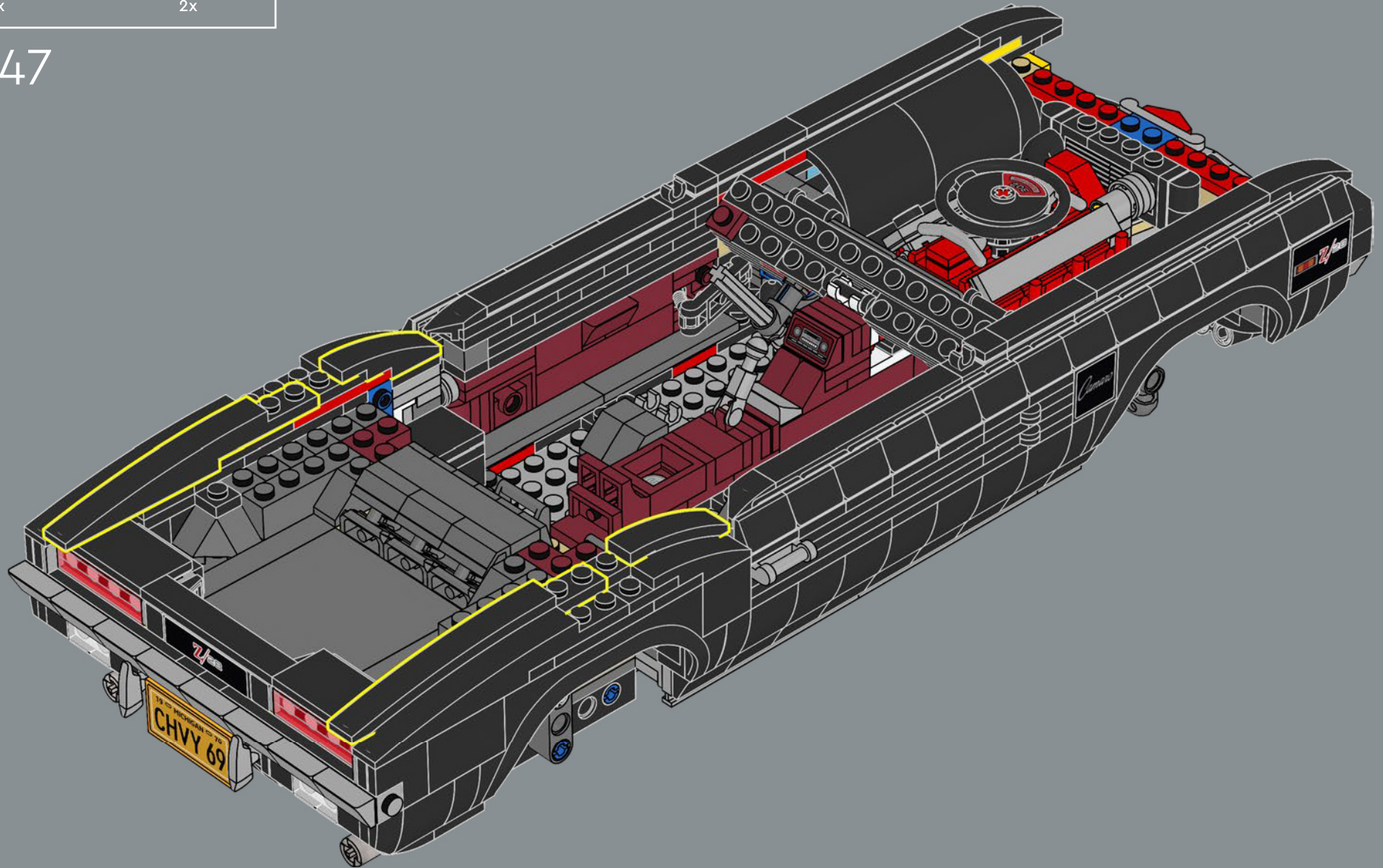

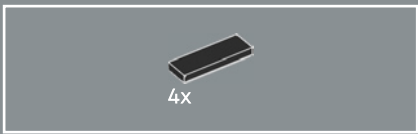

248

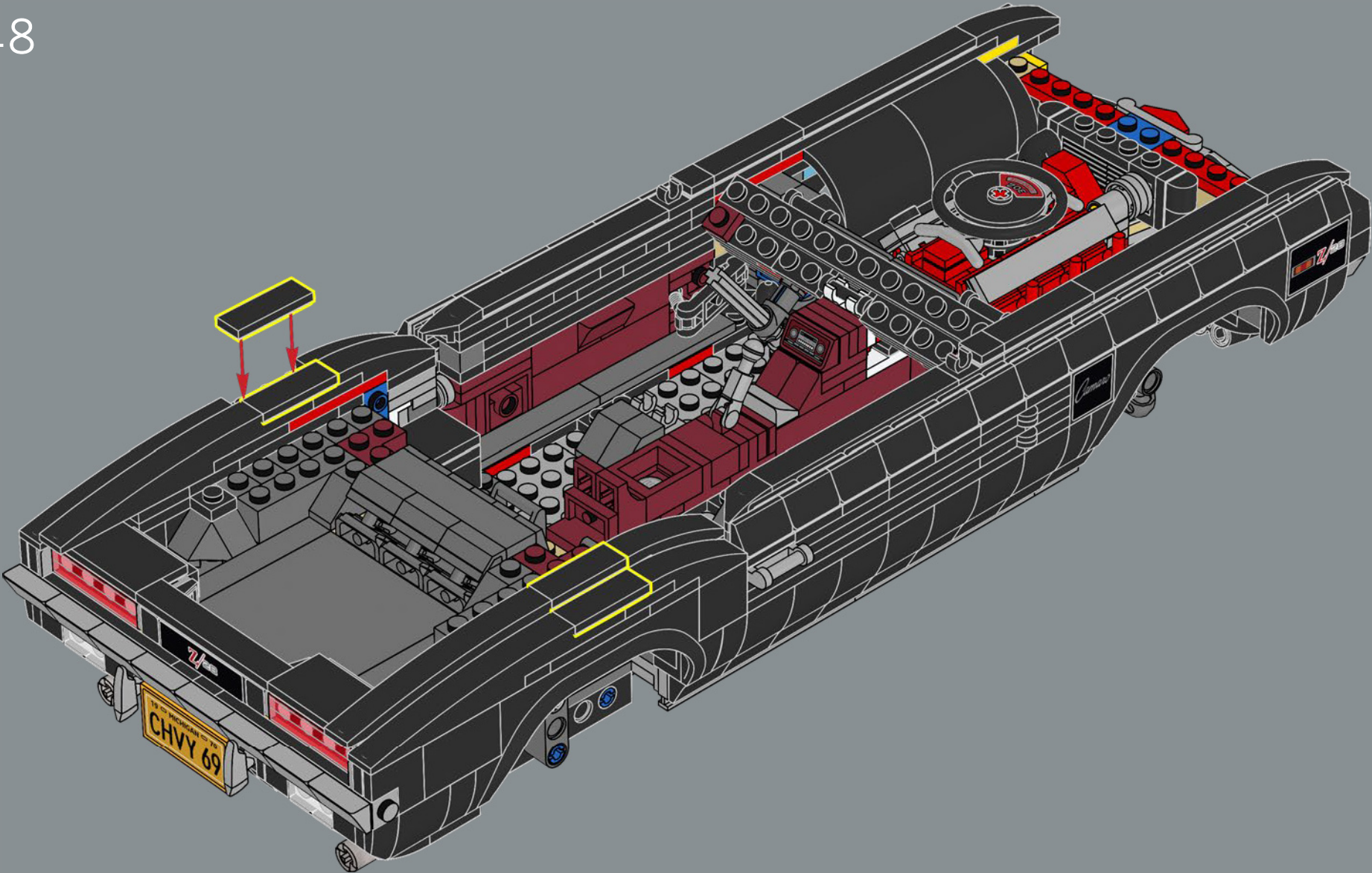

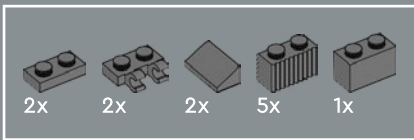

249

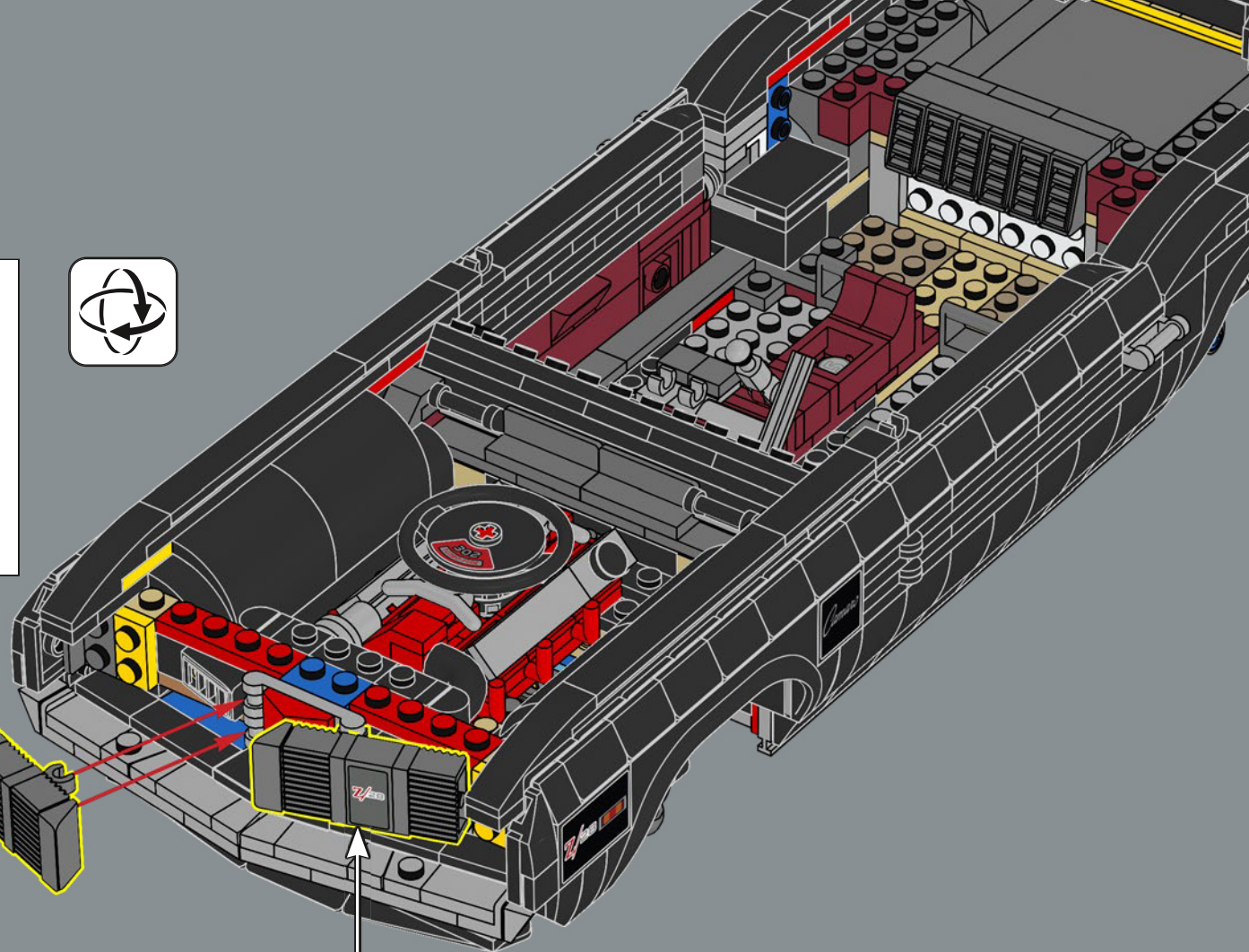
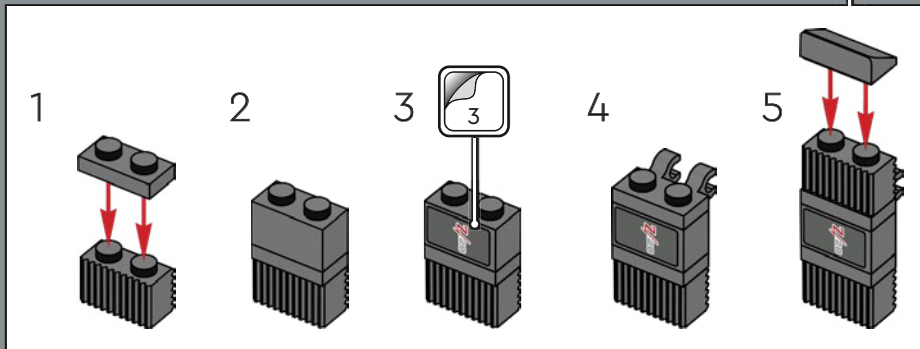
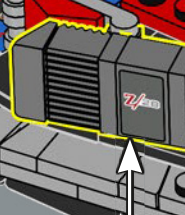
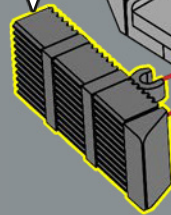
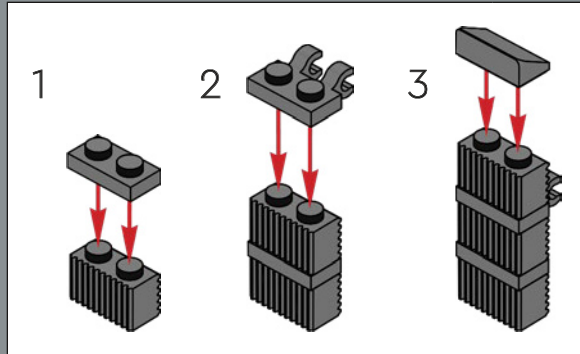

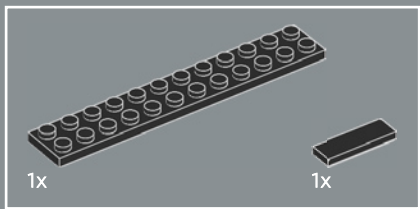

250

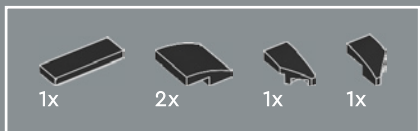
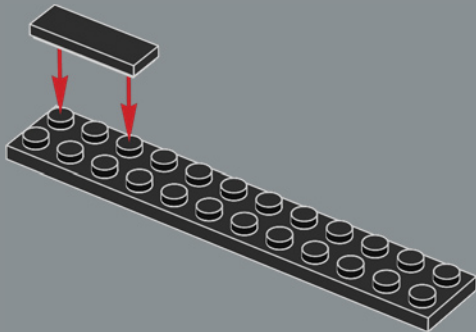

251

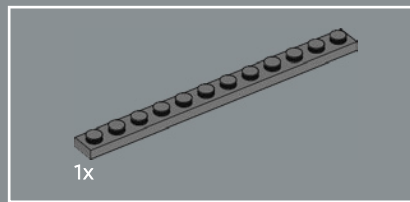
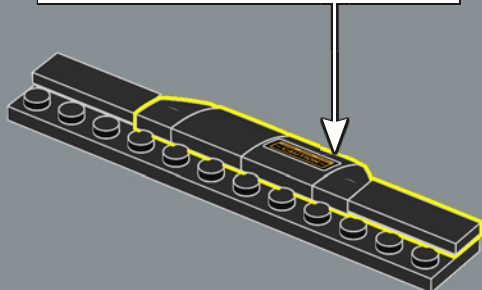
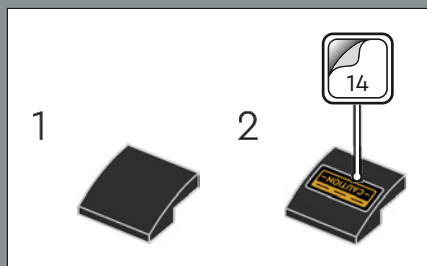

252

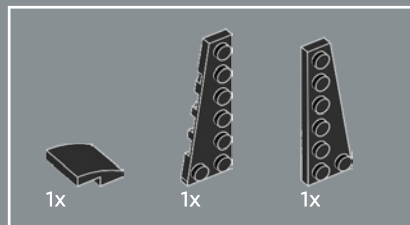
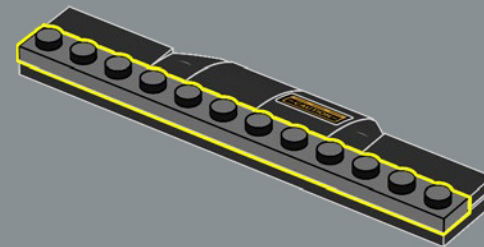

253

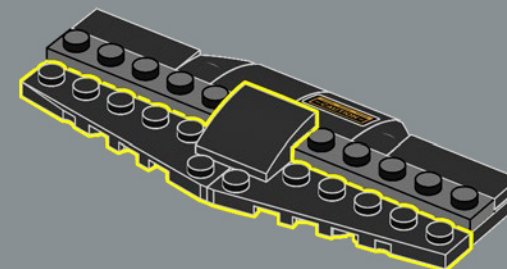





254

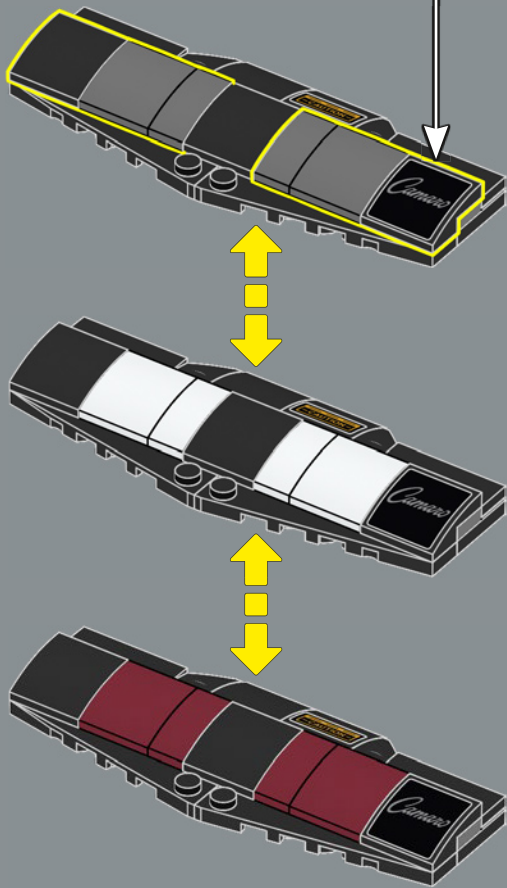
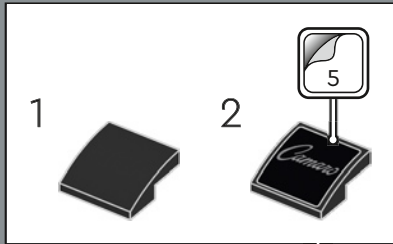

255

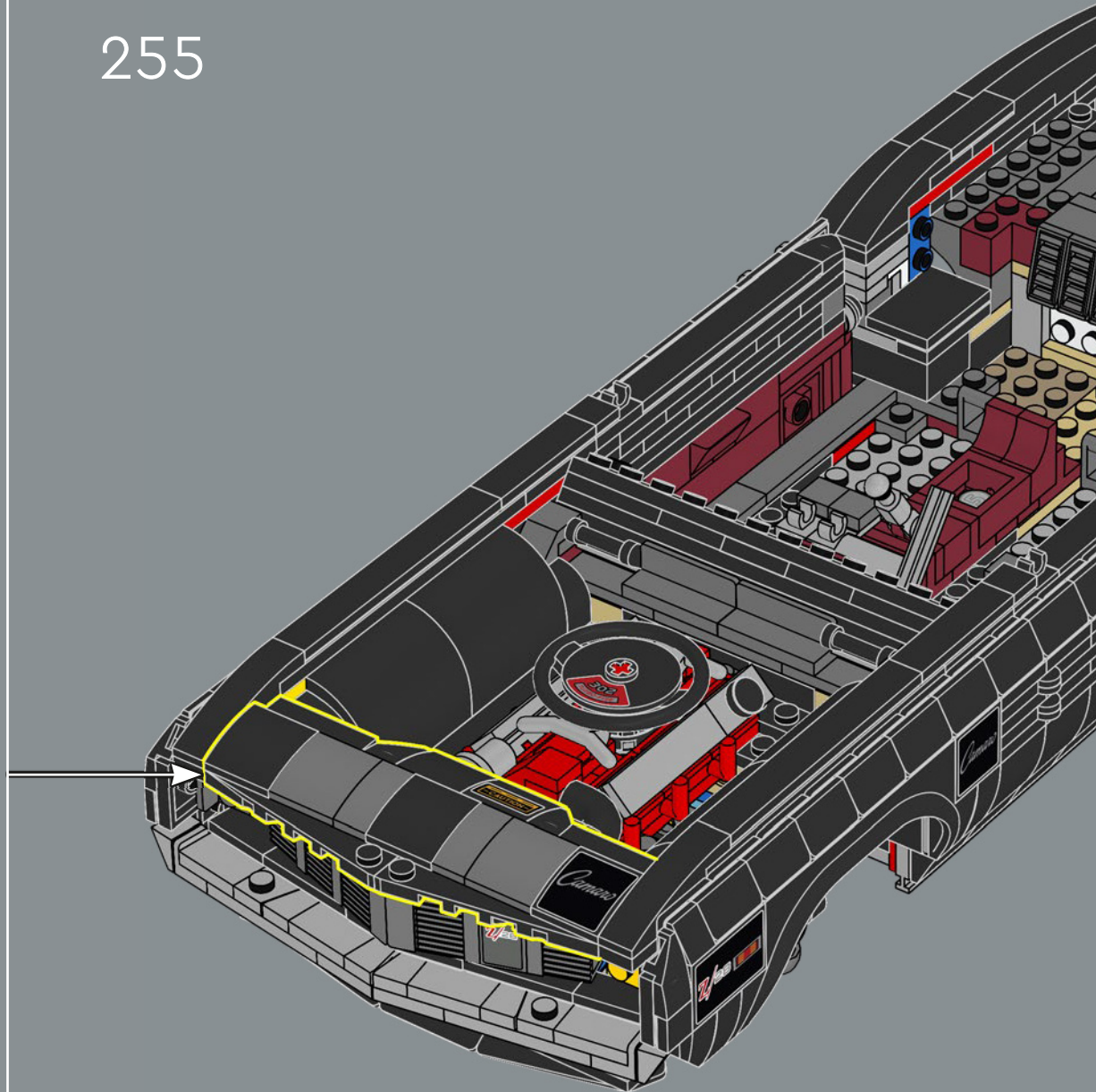

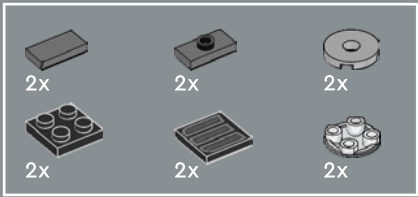

# 256

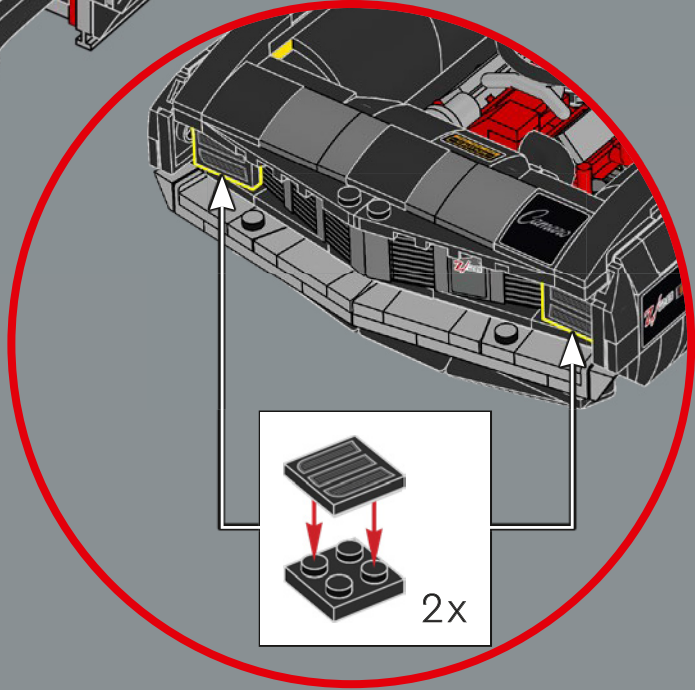
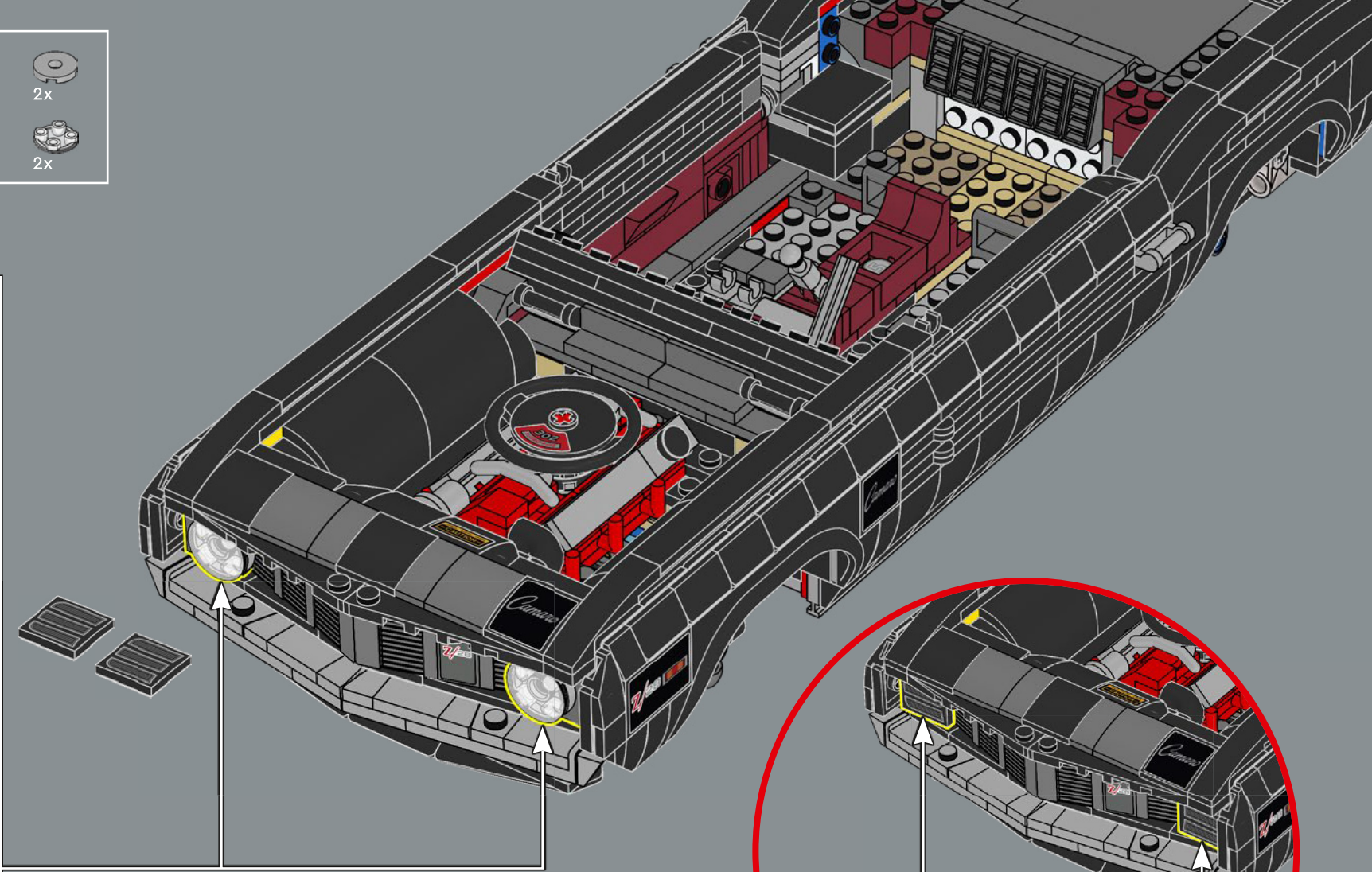
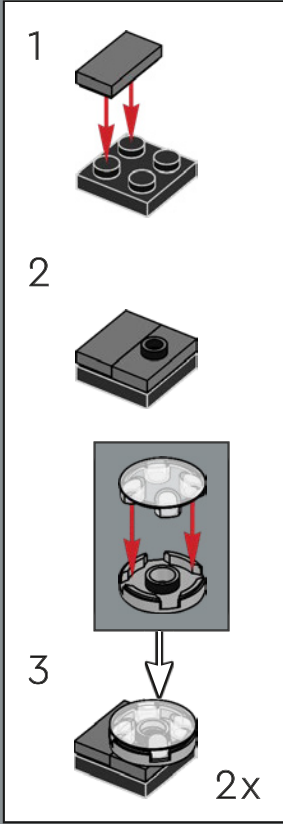

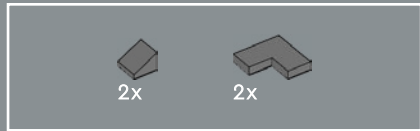

257

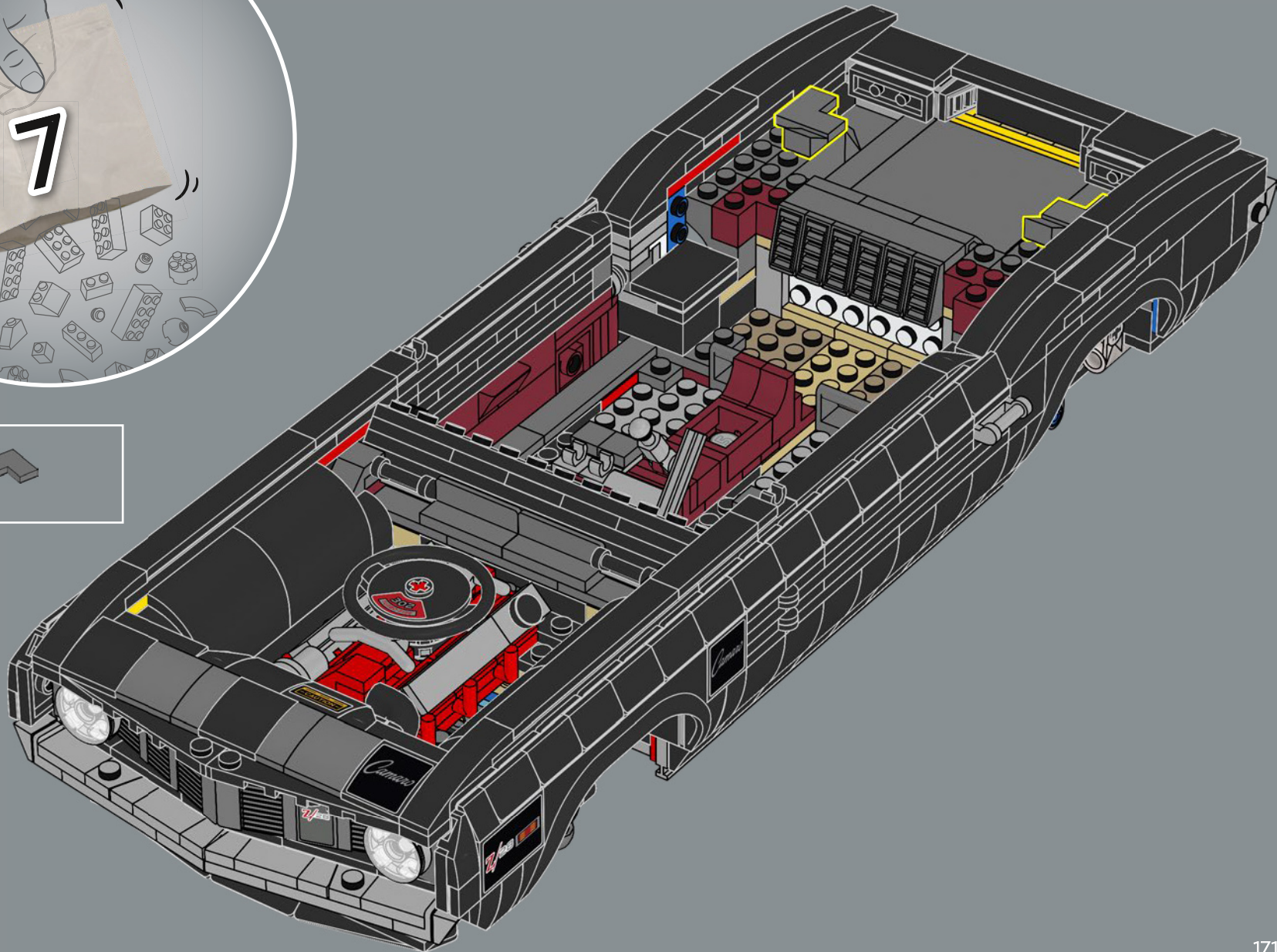

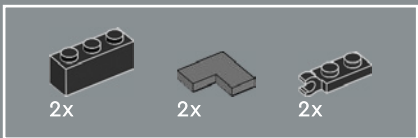

258

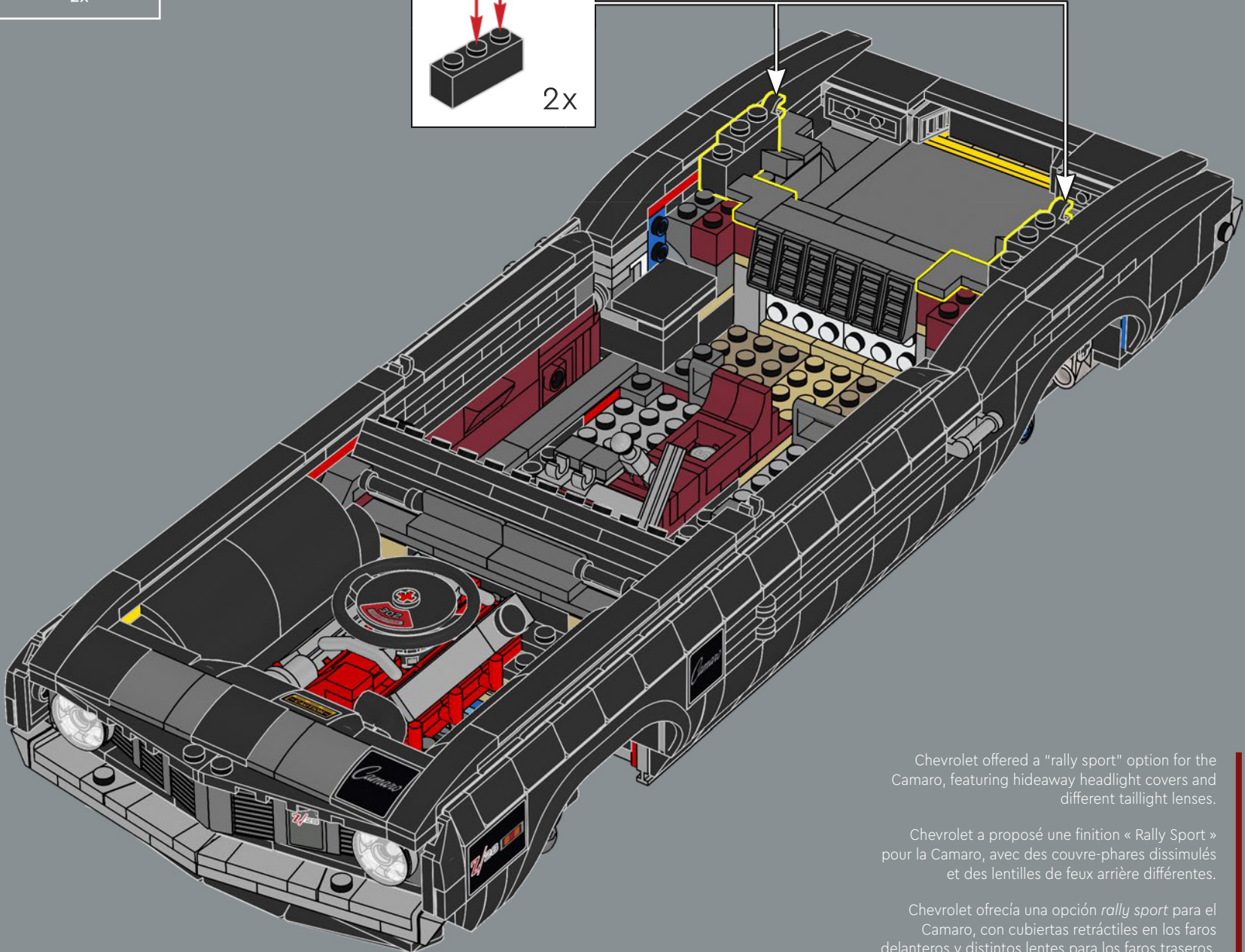
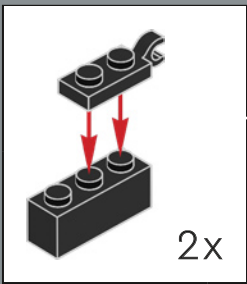

Chevrolet offered a "rally sport" option for the Camaro, featuring hideaway headlight covers and different taillight lenses.

Chevrolet a proposé une finition « Rally Sport » pour la Camaro, avec des couvre-phares dissimulés et des lentilles de feux arrière différentes.

Chevrolet ofrecía una opción *rally sport* para el Camaro, con cubiertas retráctiles en los faros delanteros y distintos lentes para los faros traseros.

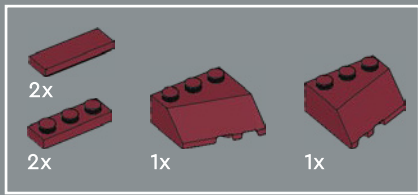

259

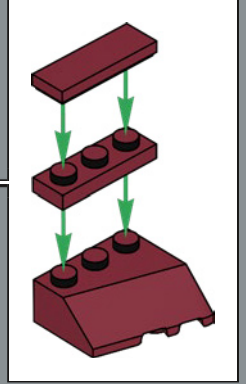
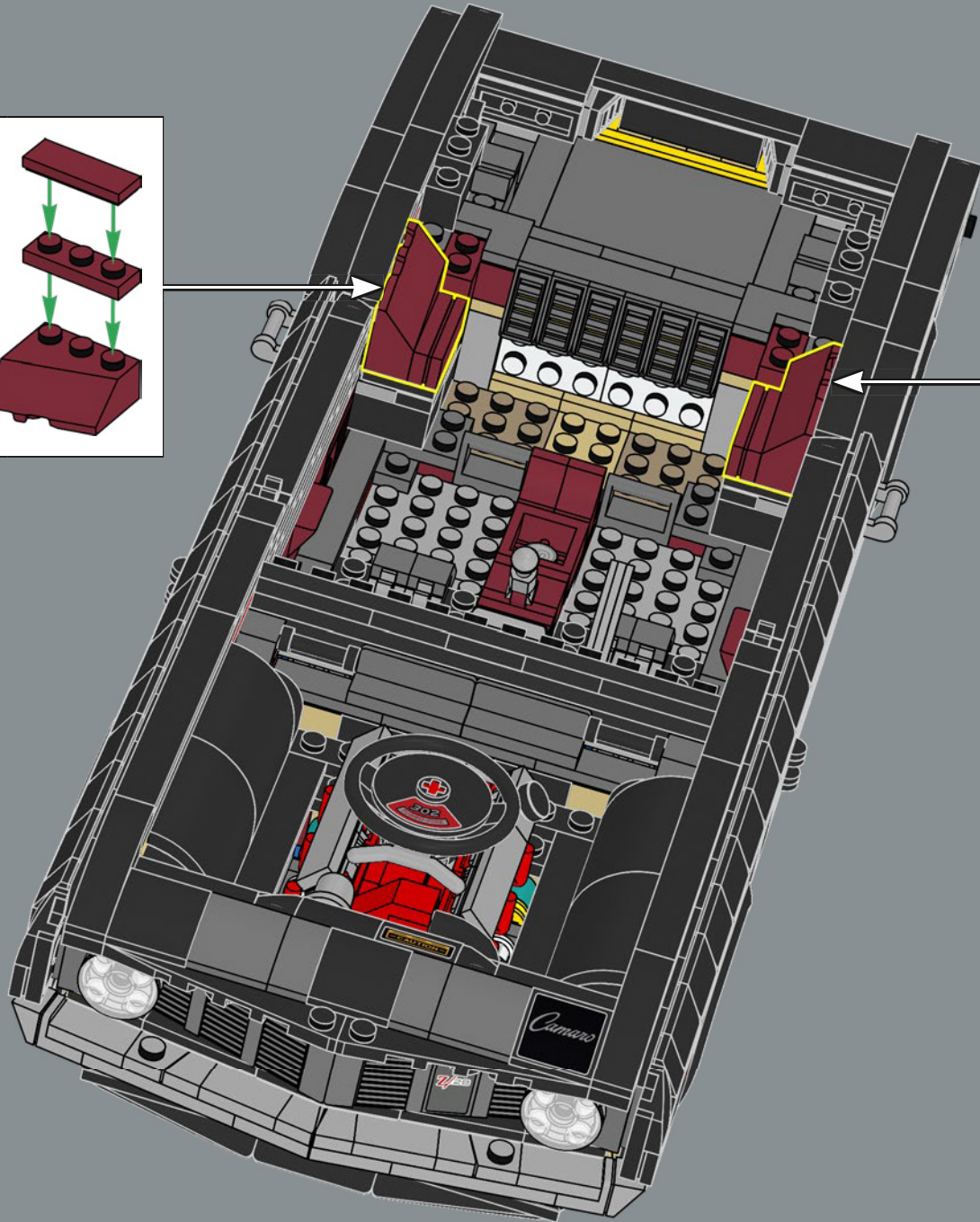
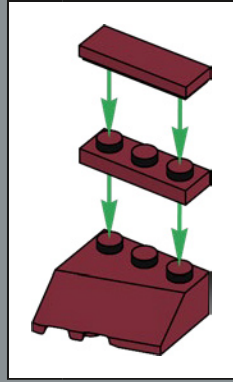

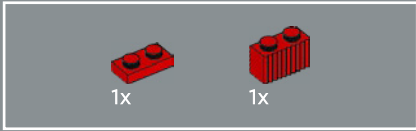

260



261

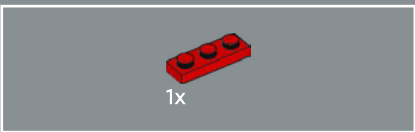
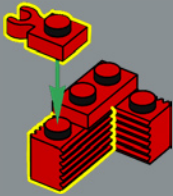

262

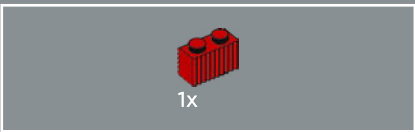
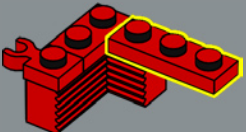

263

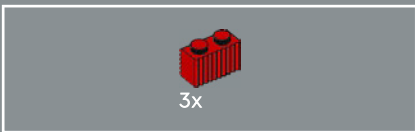
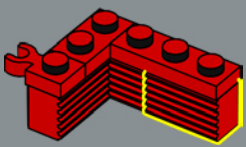

264

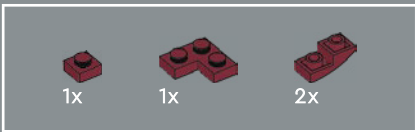
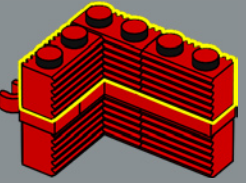

265

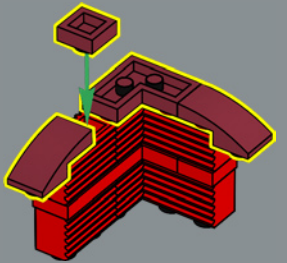

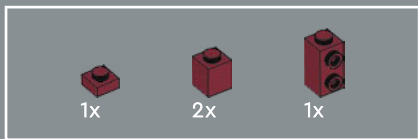

266

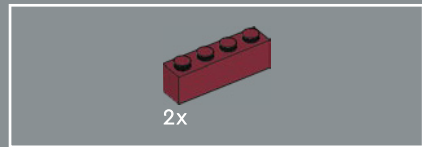
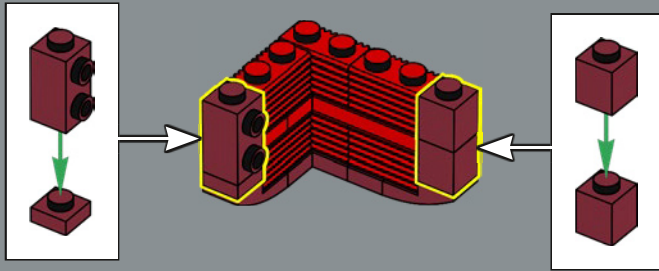

267

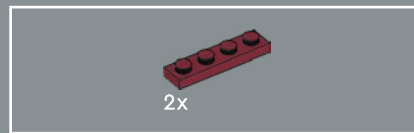
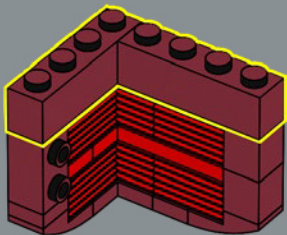

268

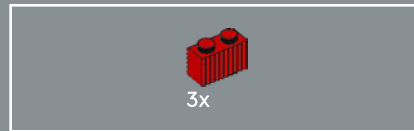
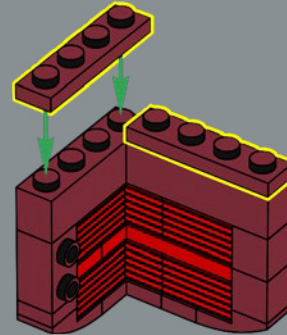

269

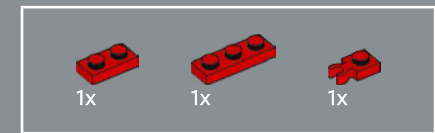
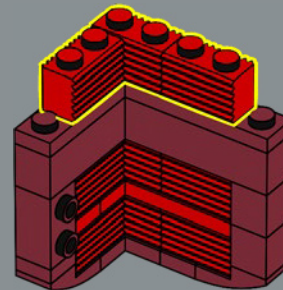

270

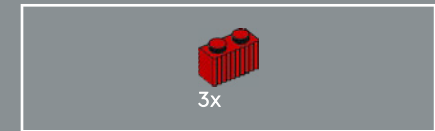
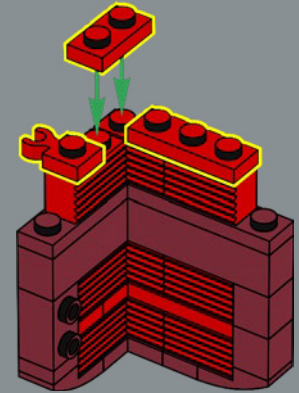

271

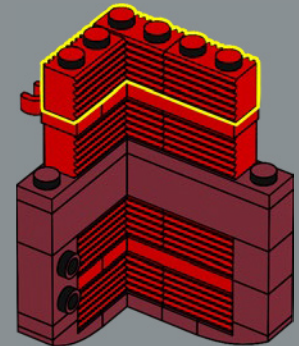



4x

272

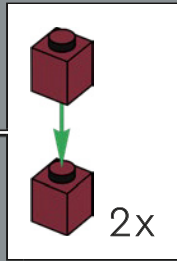
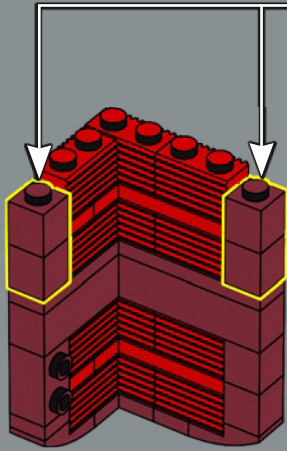

2x

1x

2x

1x

273

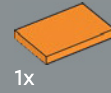
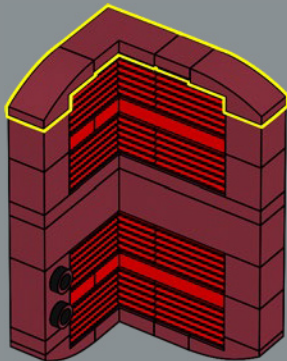

1x

274



15

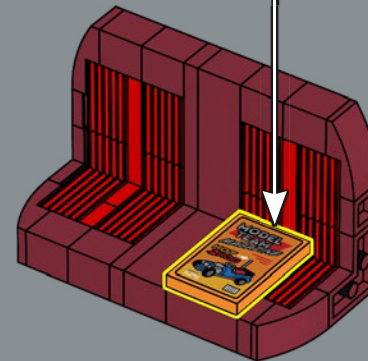



275

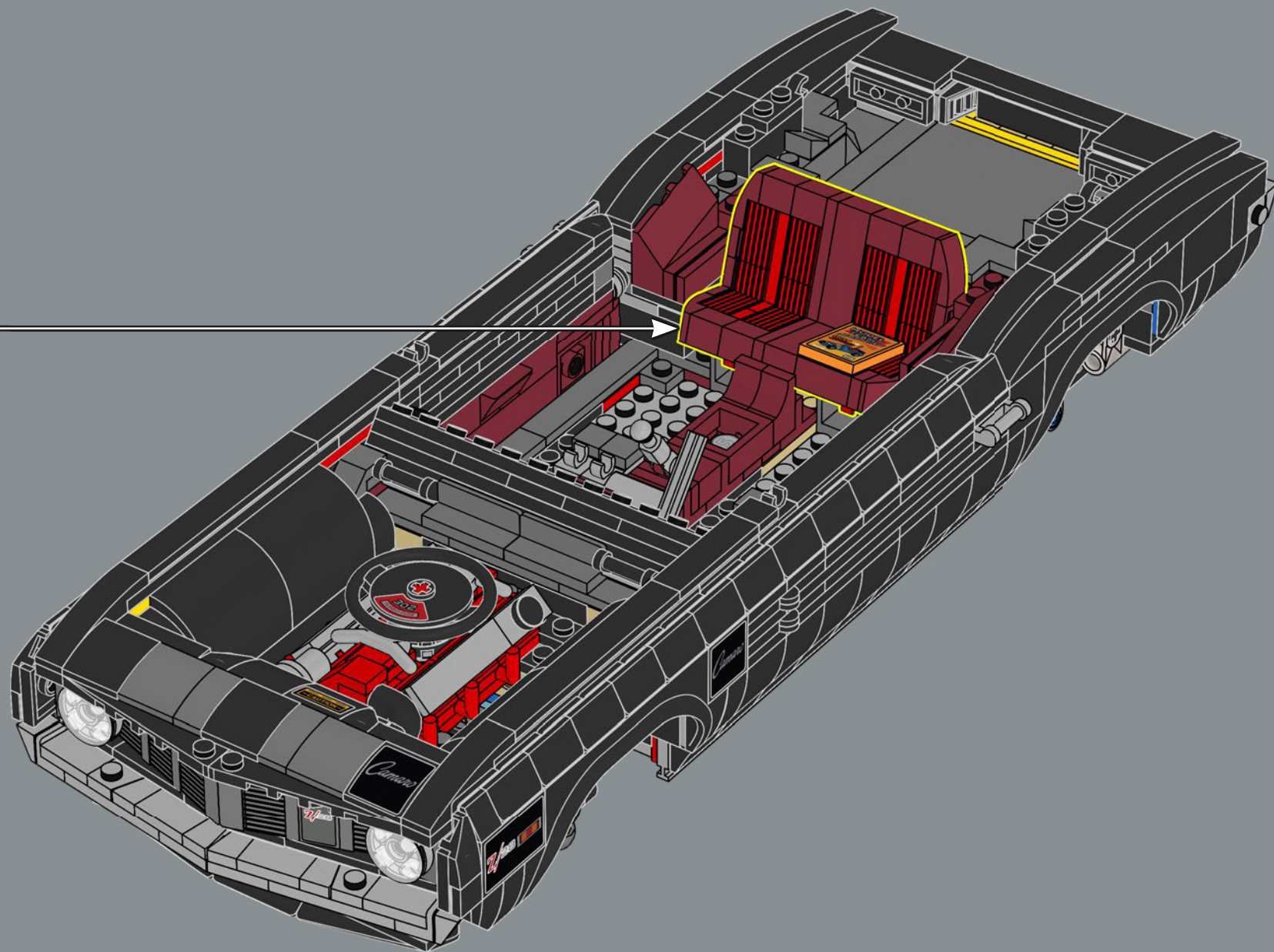

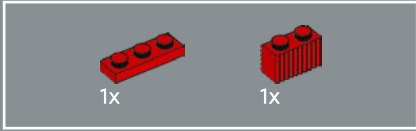

276

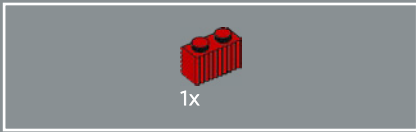
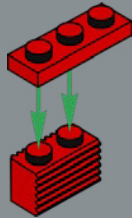

277

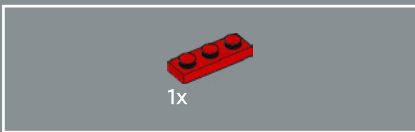
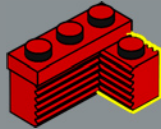

278

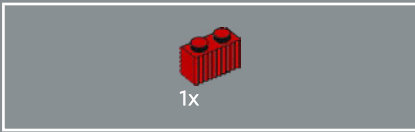
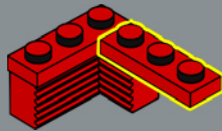

279

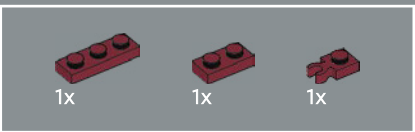
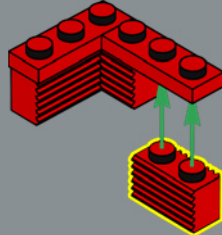

280

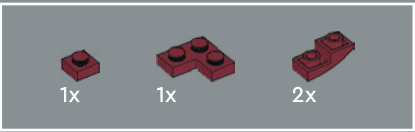
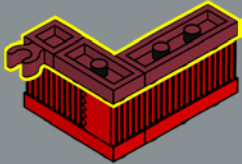

281

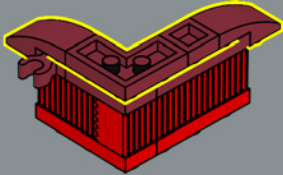



282

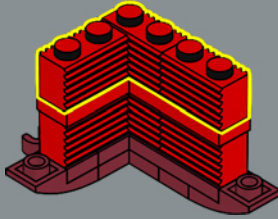

283

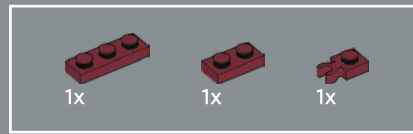
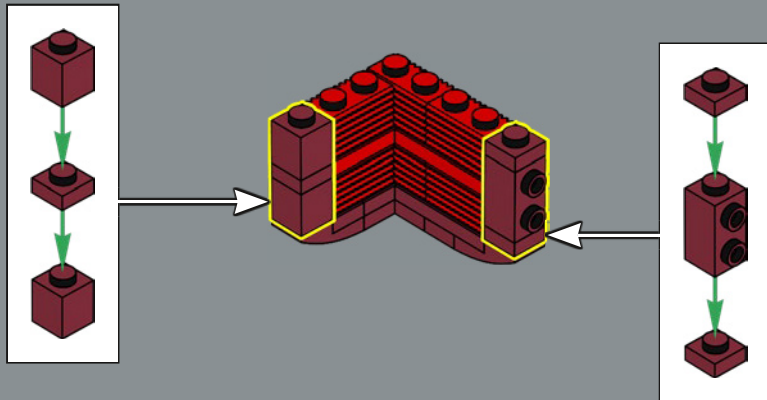

284

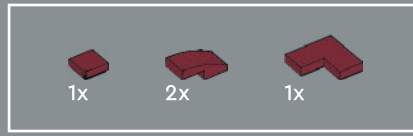
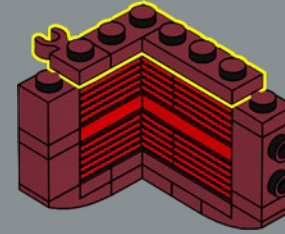

285

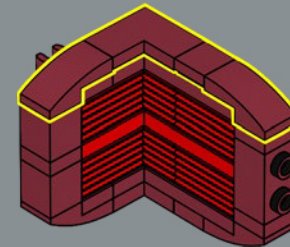



1x

286

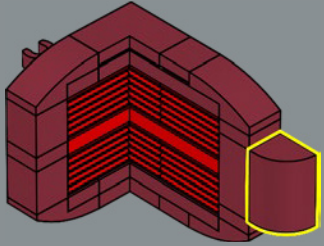

1x

287

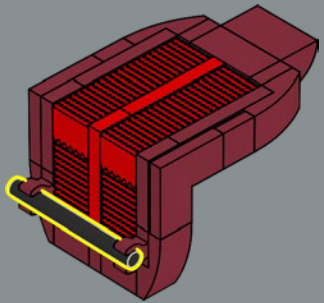

288

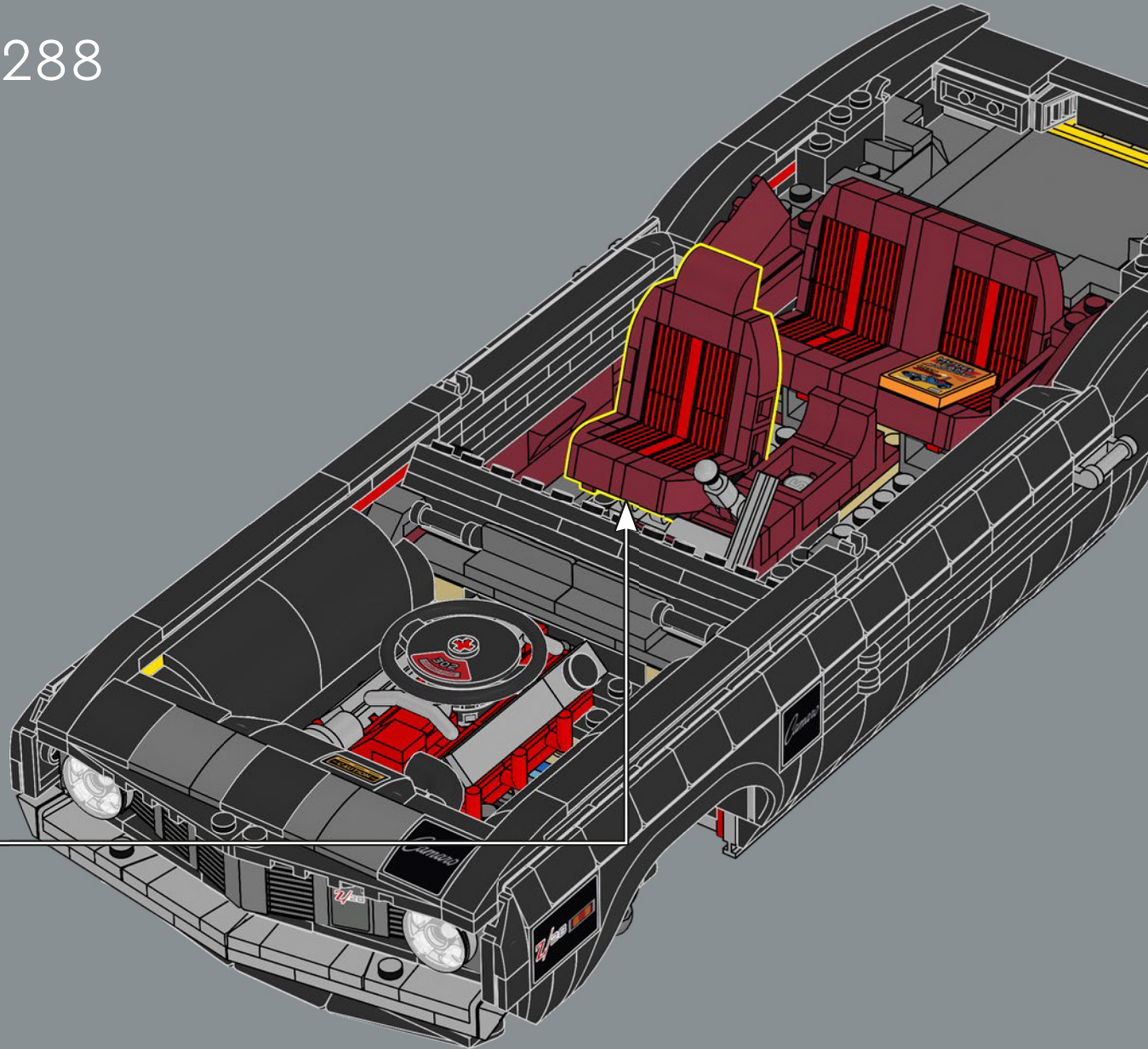

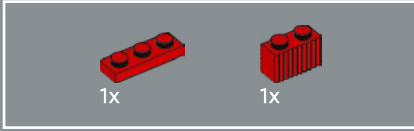
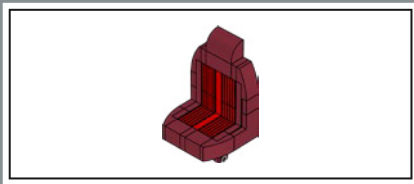

289

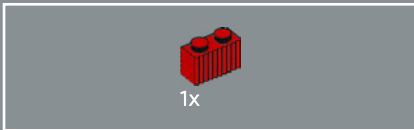
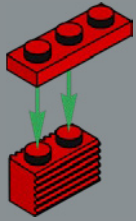

290

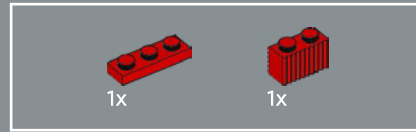
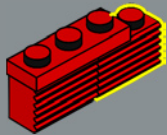

291

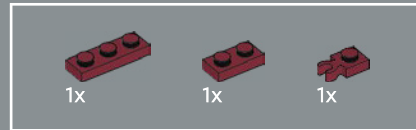
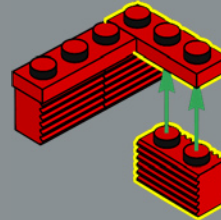

292

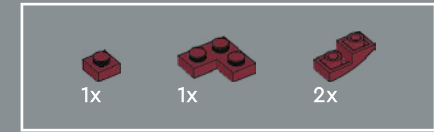
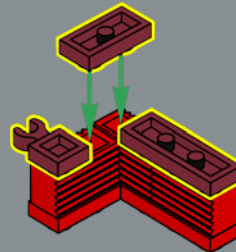

293

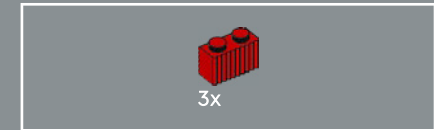
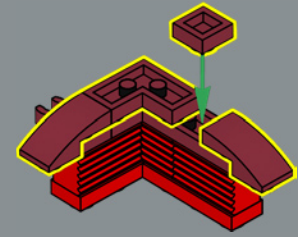

294

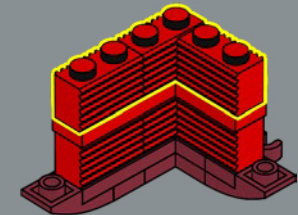



295

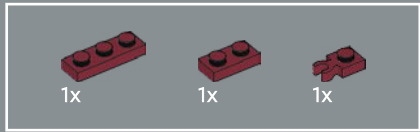
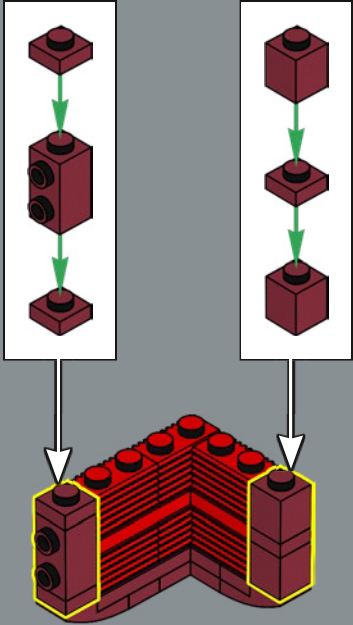

296

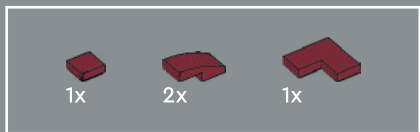
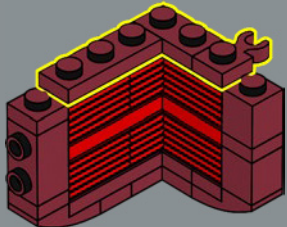

297

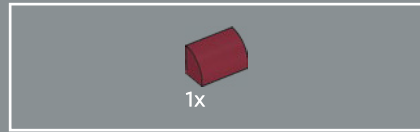
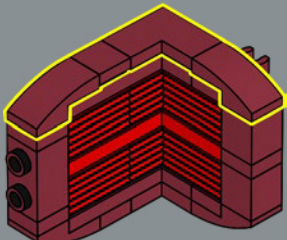

298

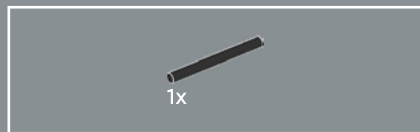
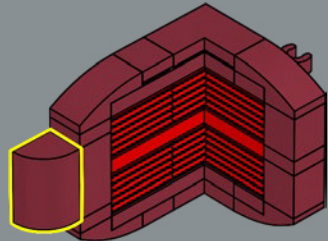

299

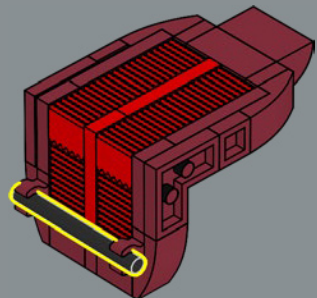

300

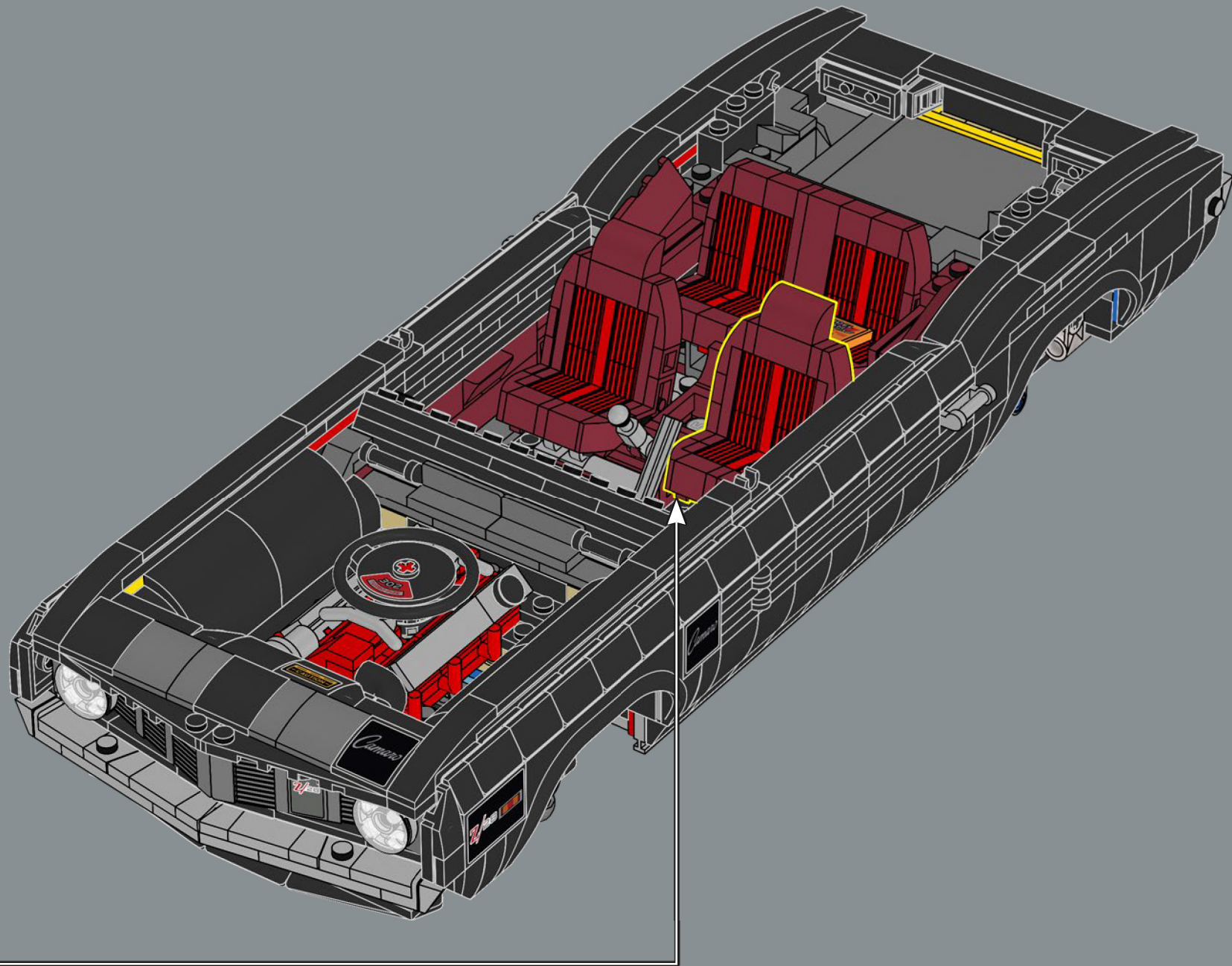

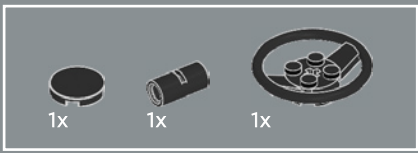

301

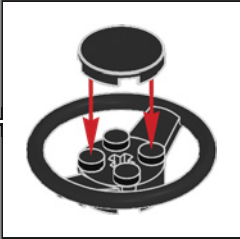
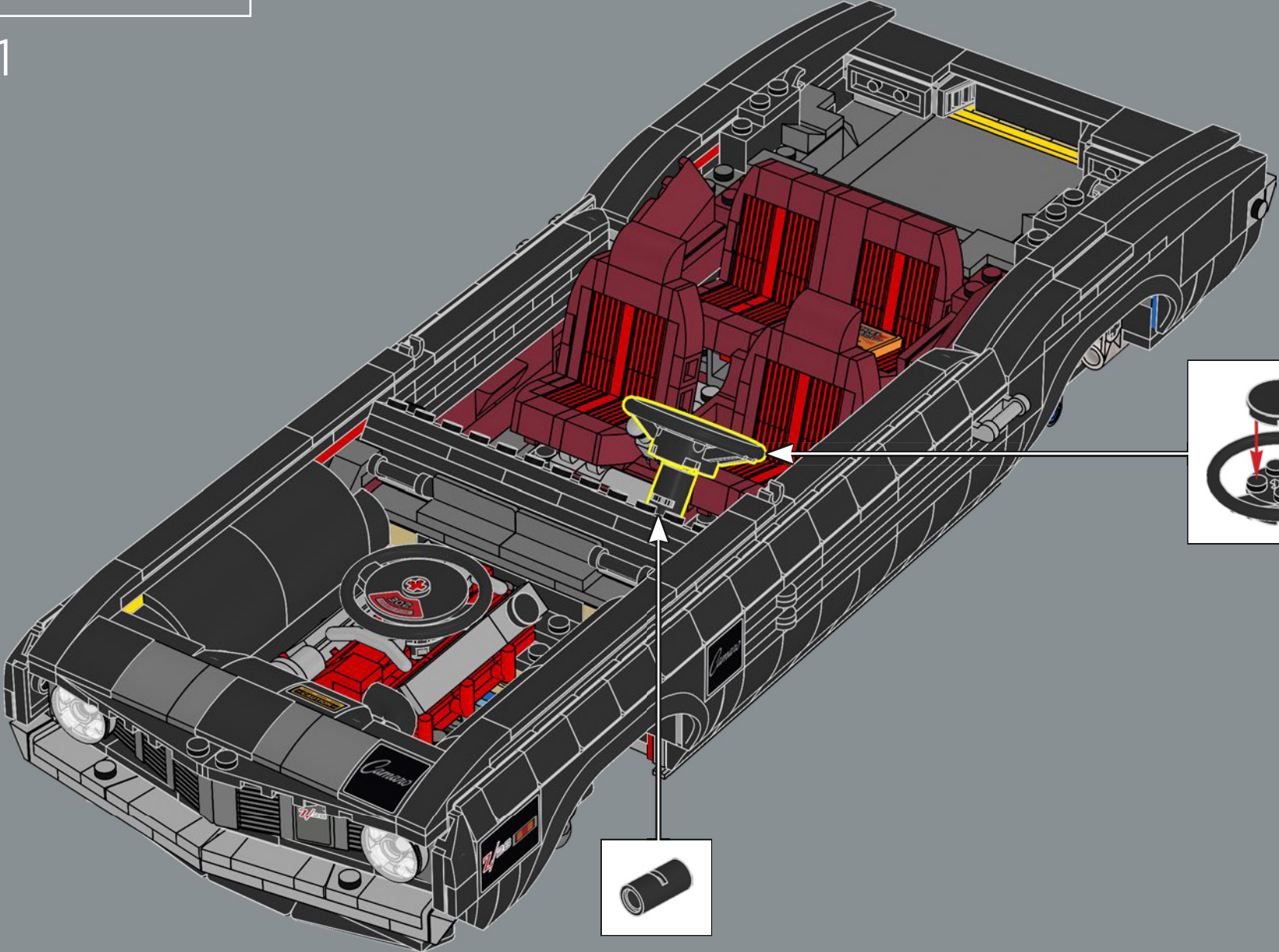



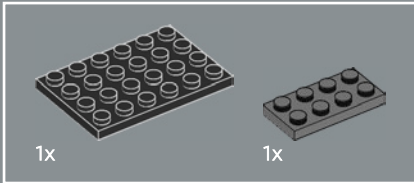
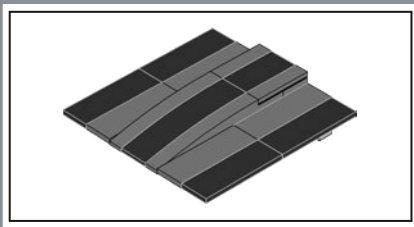

302

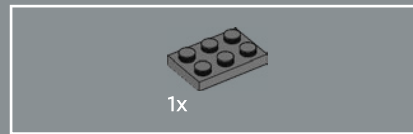
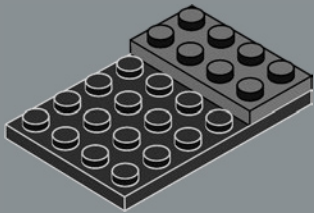

303

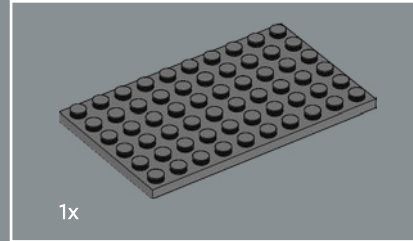
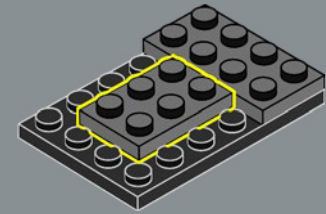

304

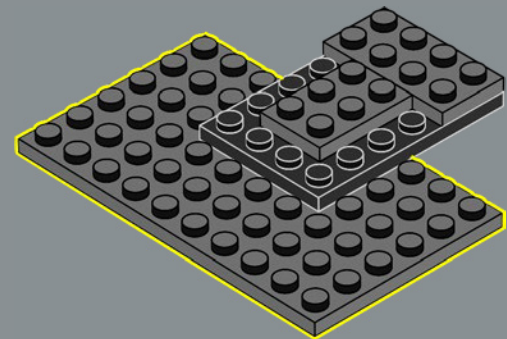

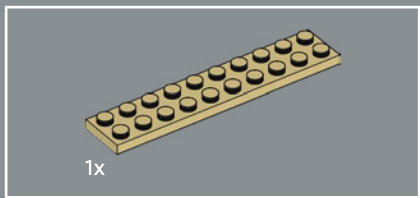

305

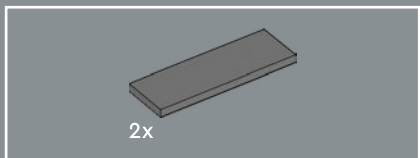
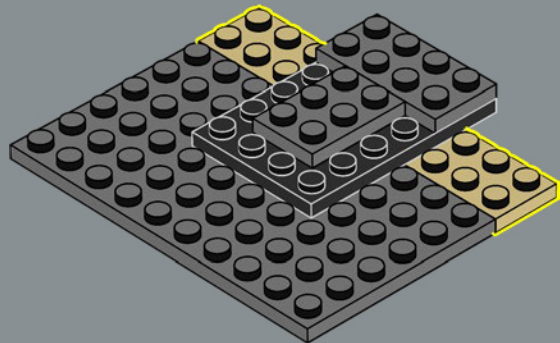

306

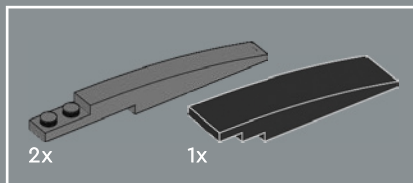
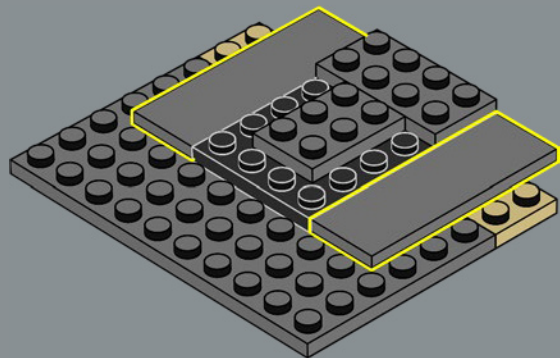

307

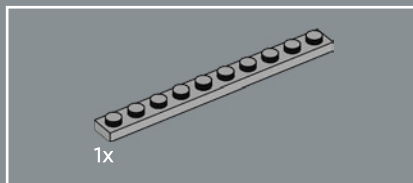
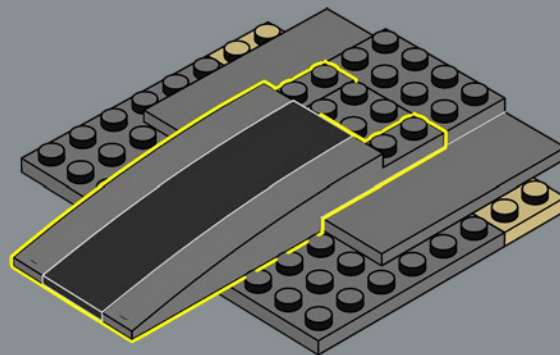

308

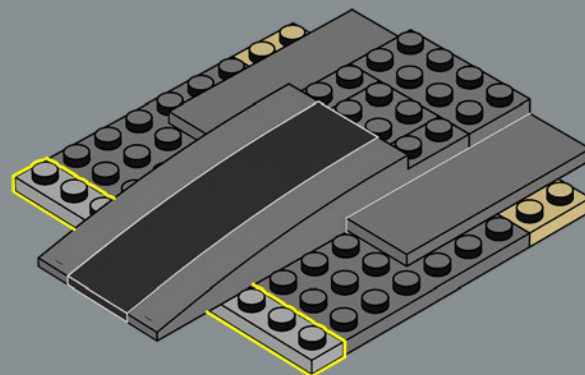

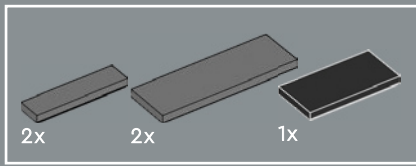

309

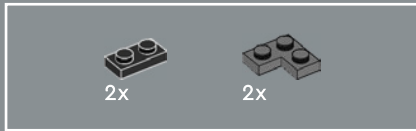
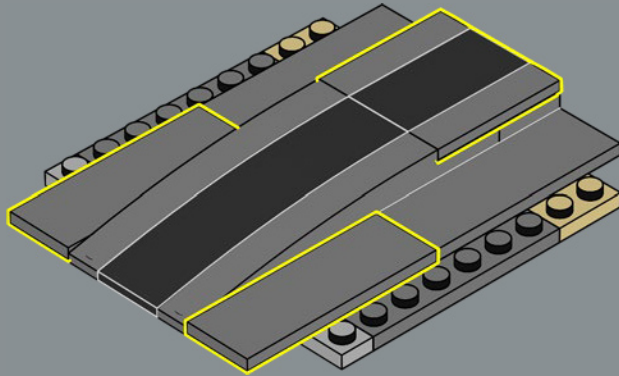

310

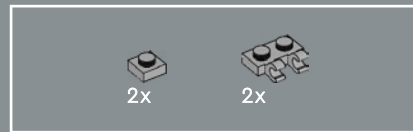
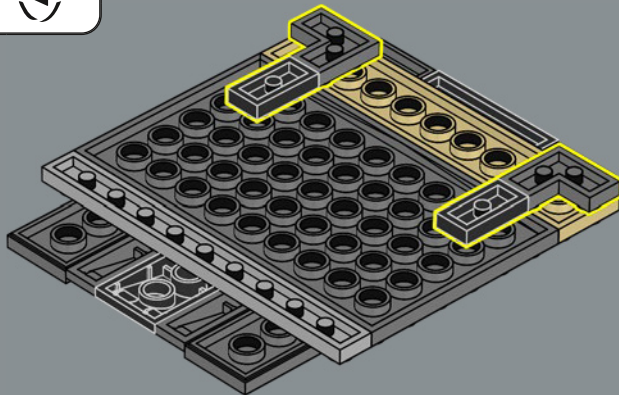

311

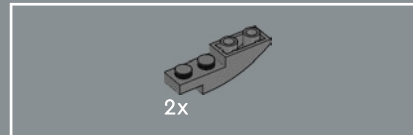
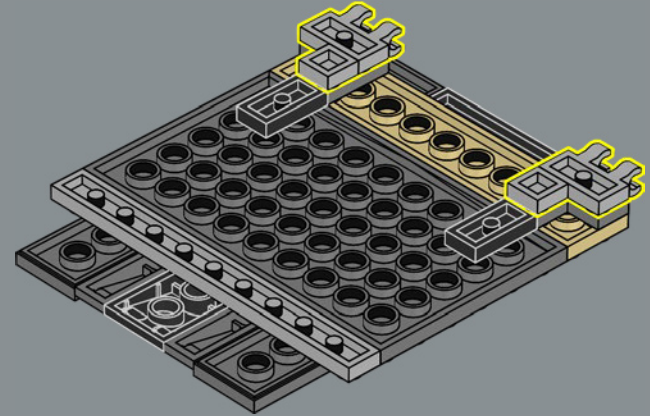

312

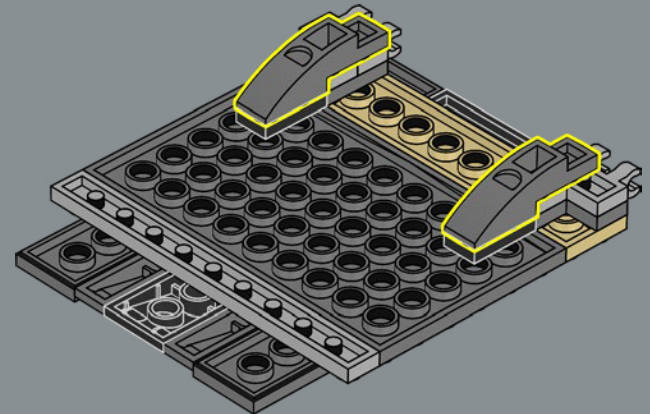

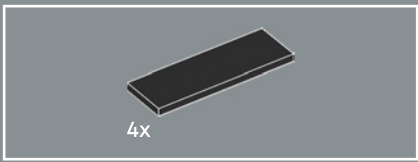

313

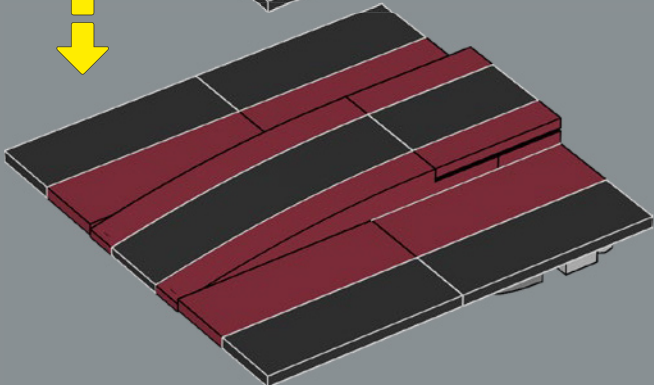
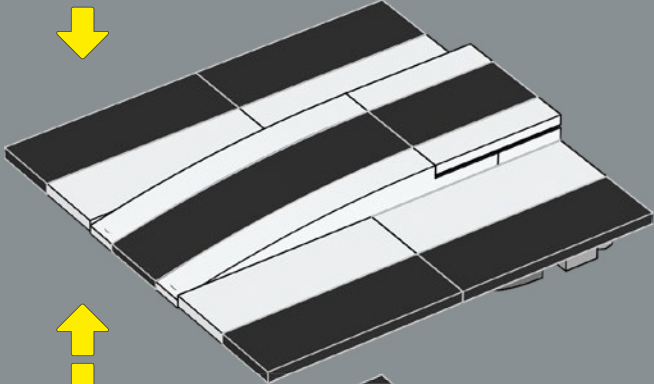
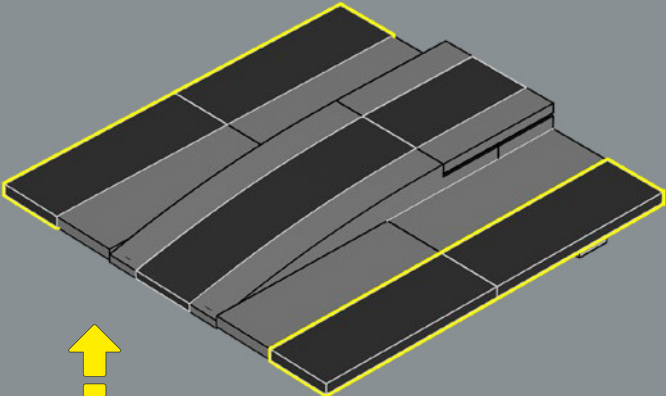

314

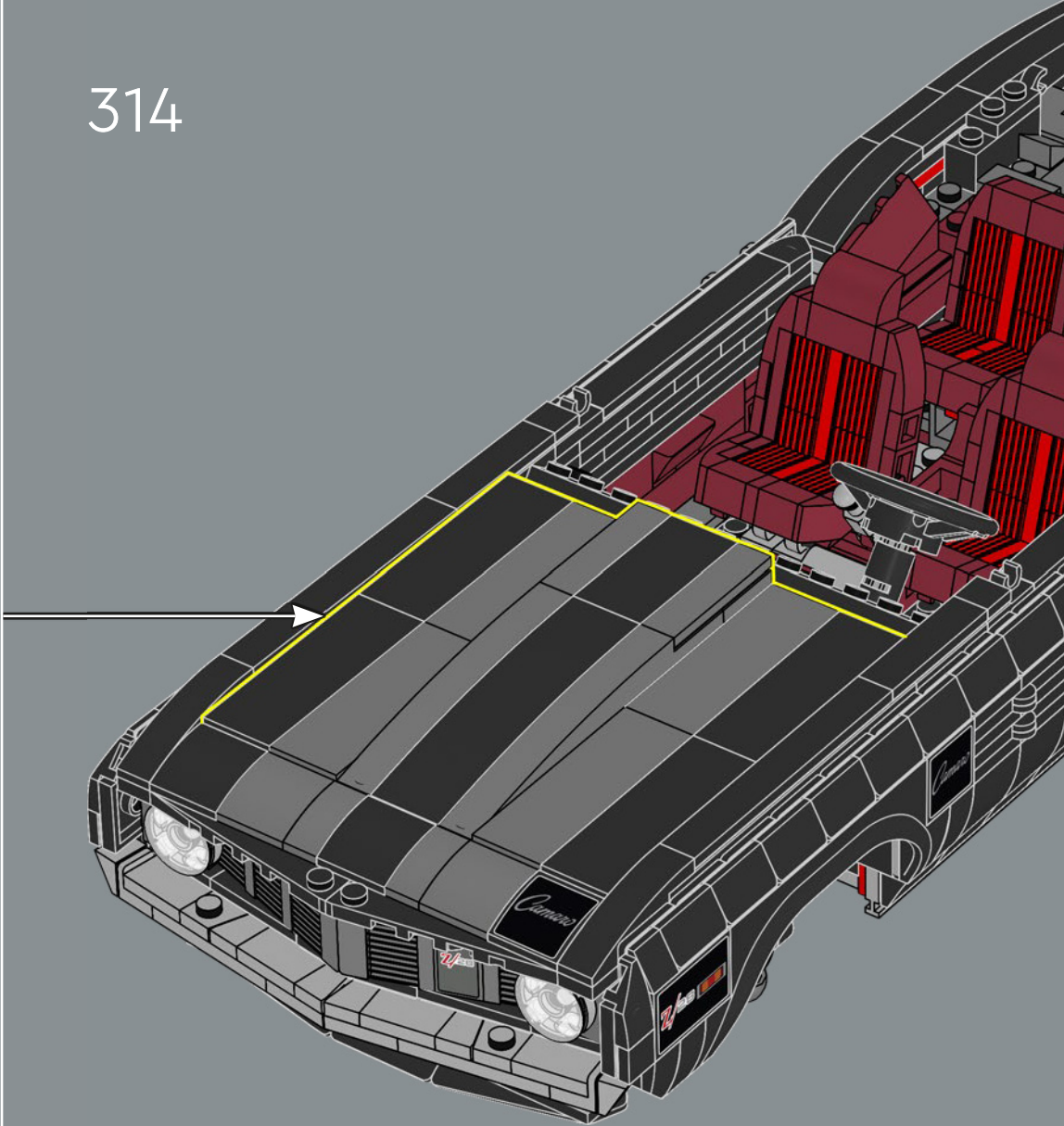

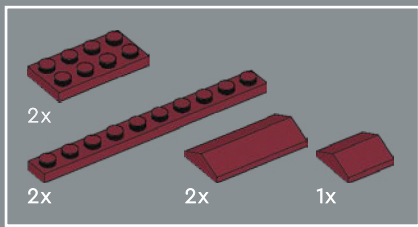

315

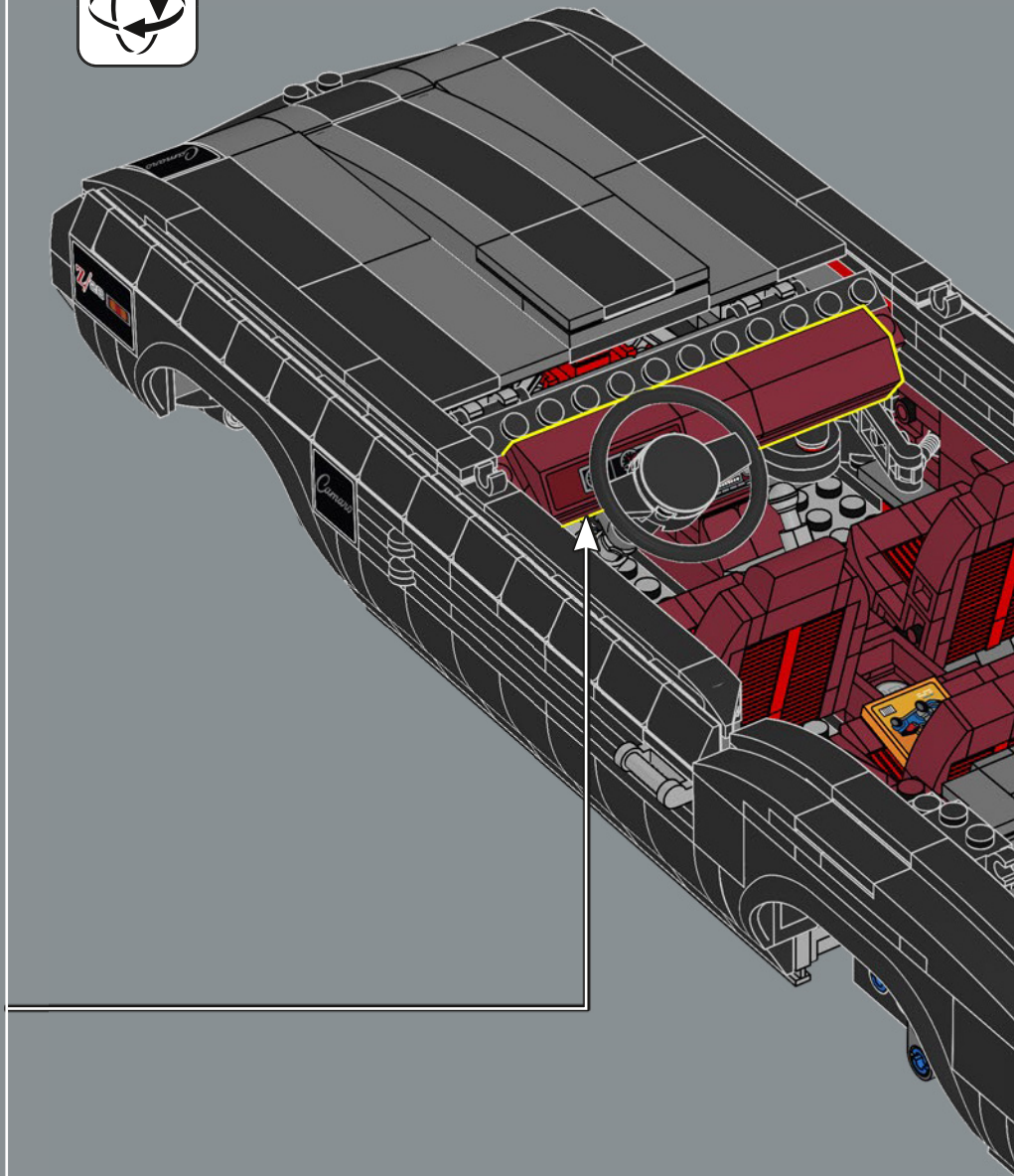
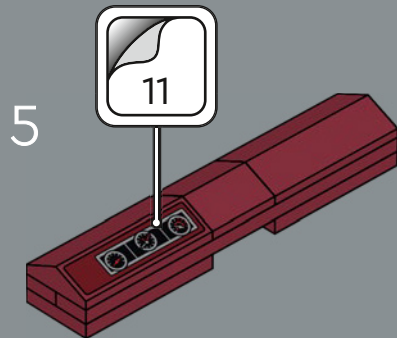
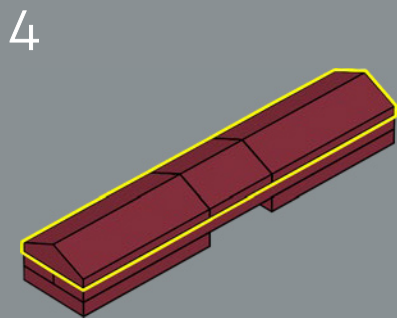
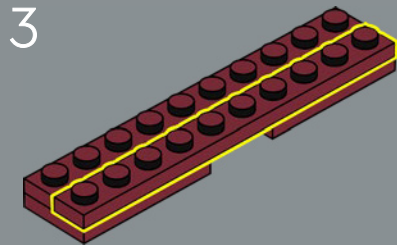
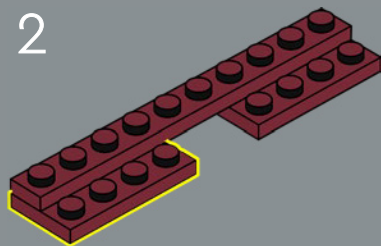
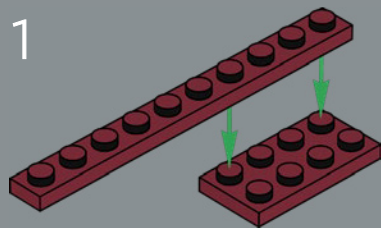

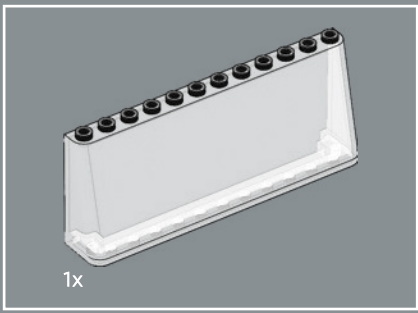

316

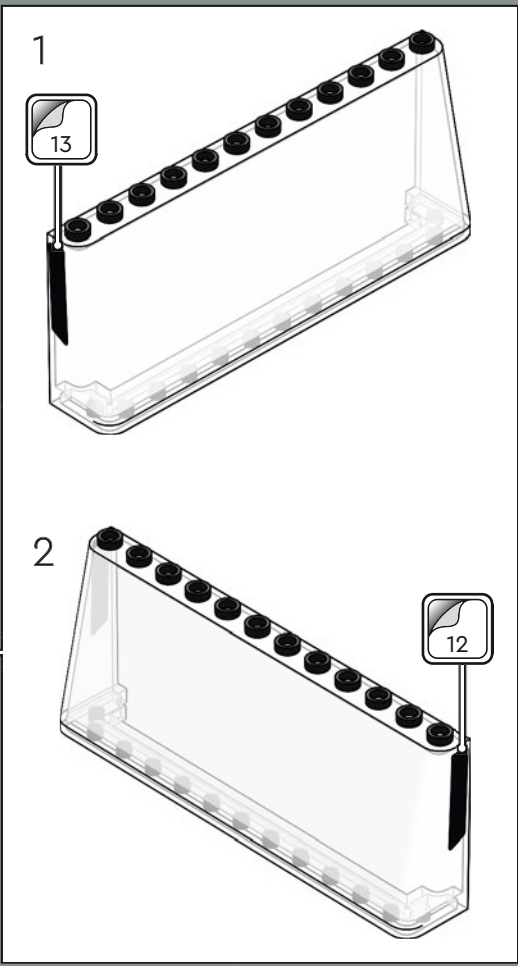
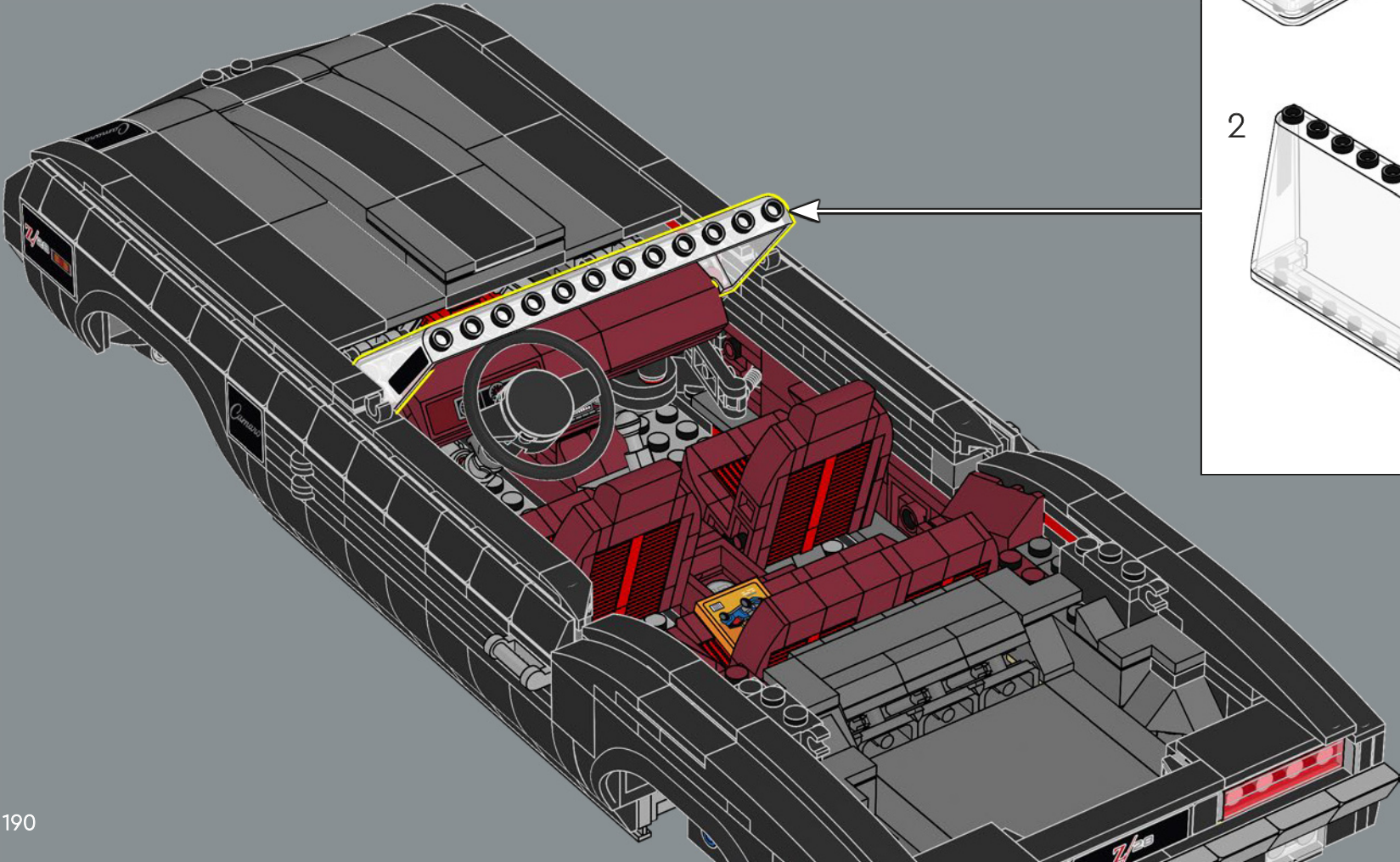

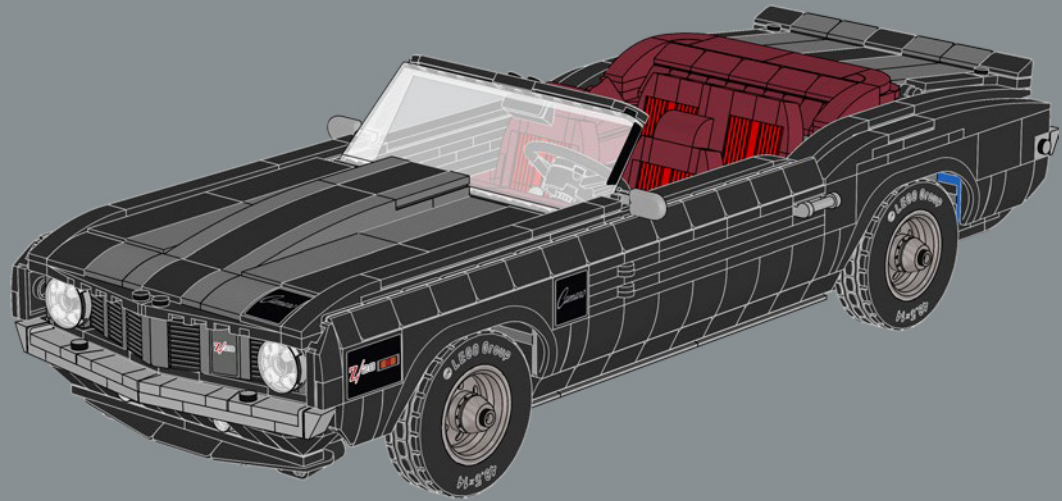
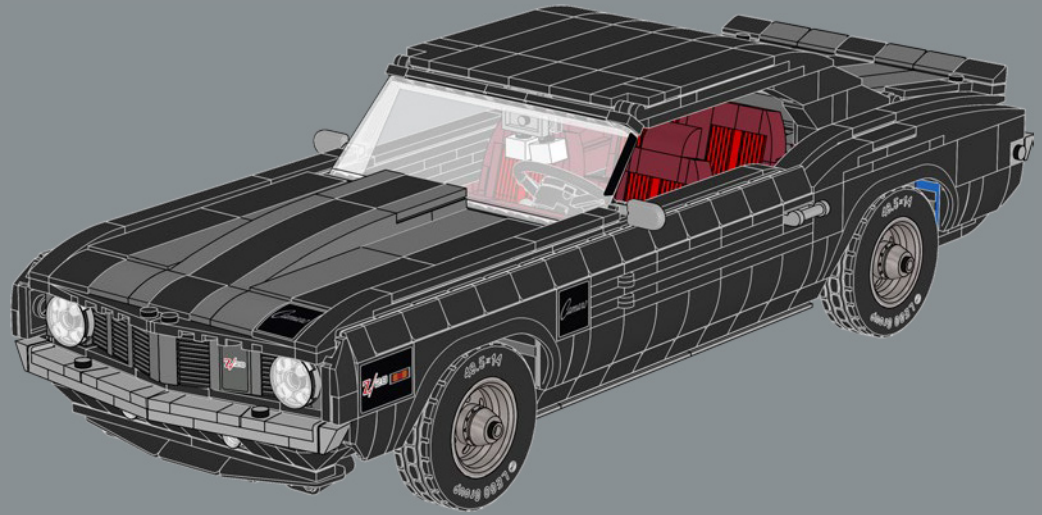

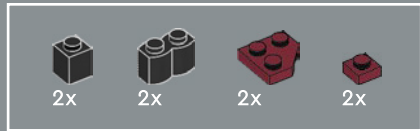
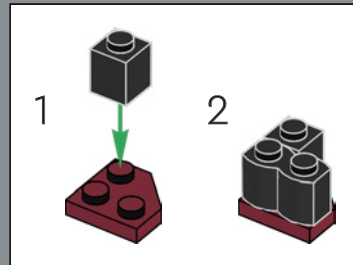

317

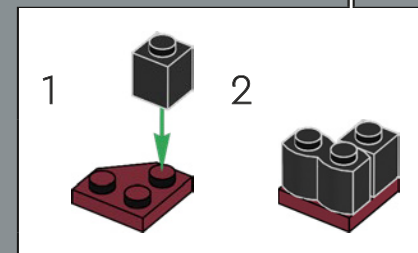
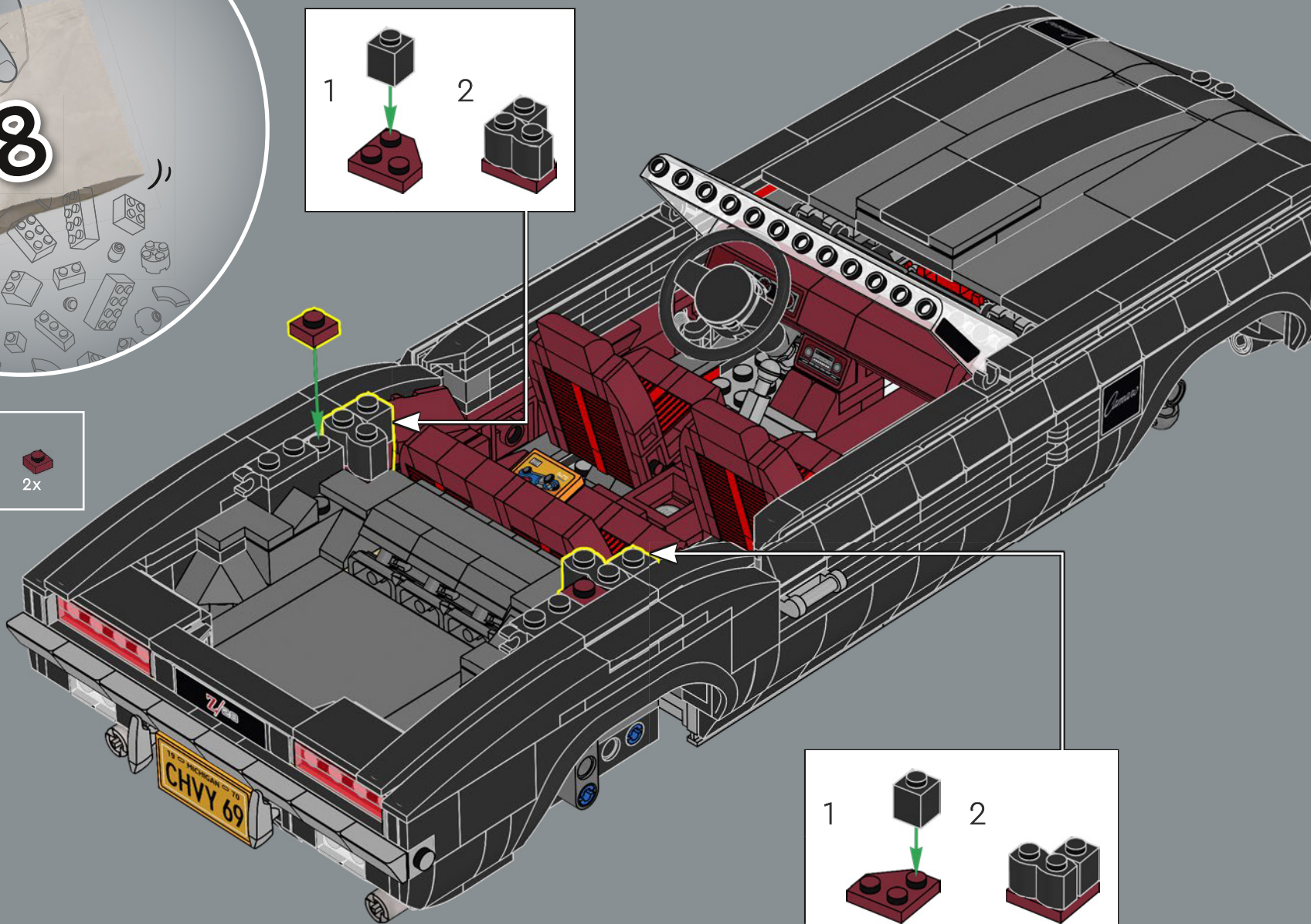



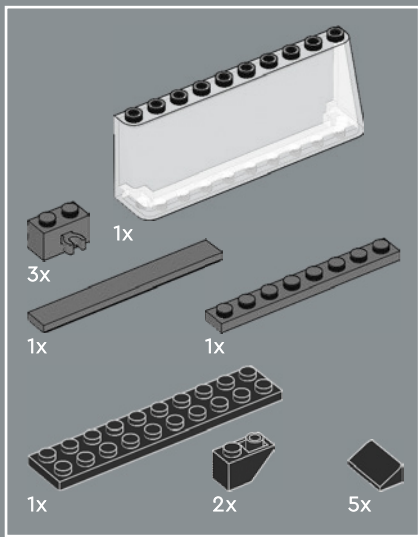

318

1

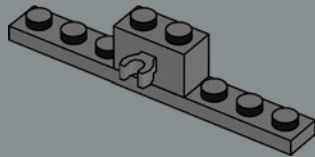

2

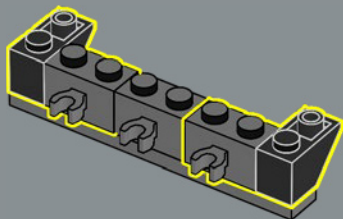

3

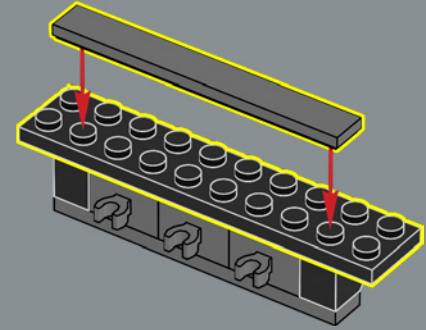

4

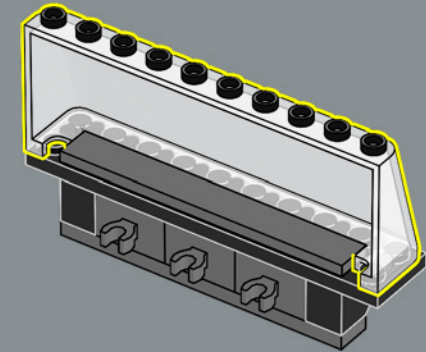

5

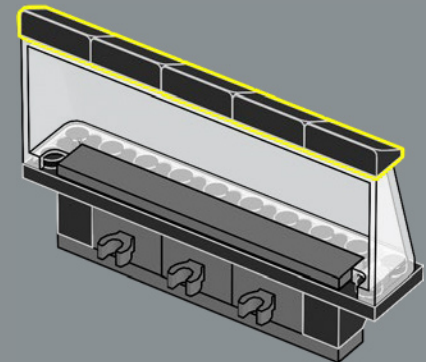

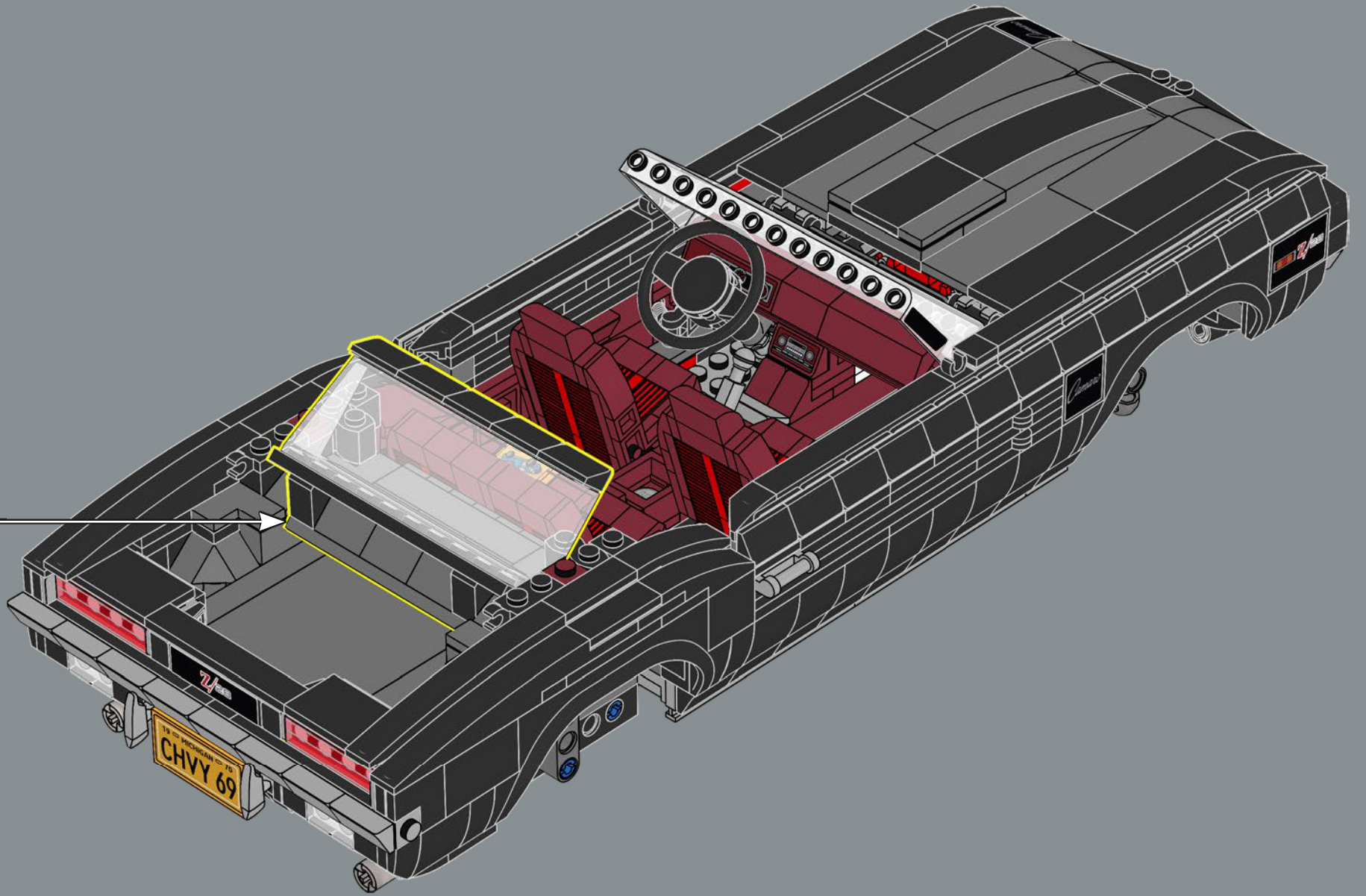

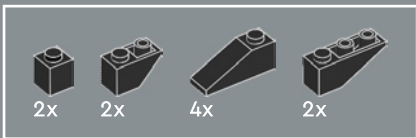

319

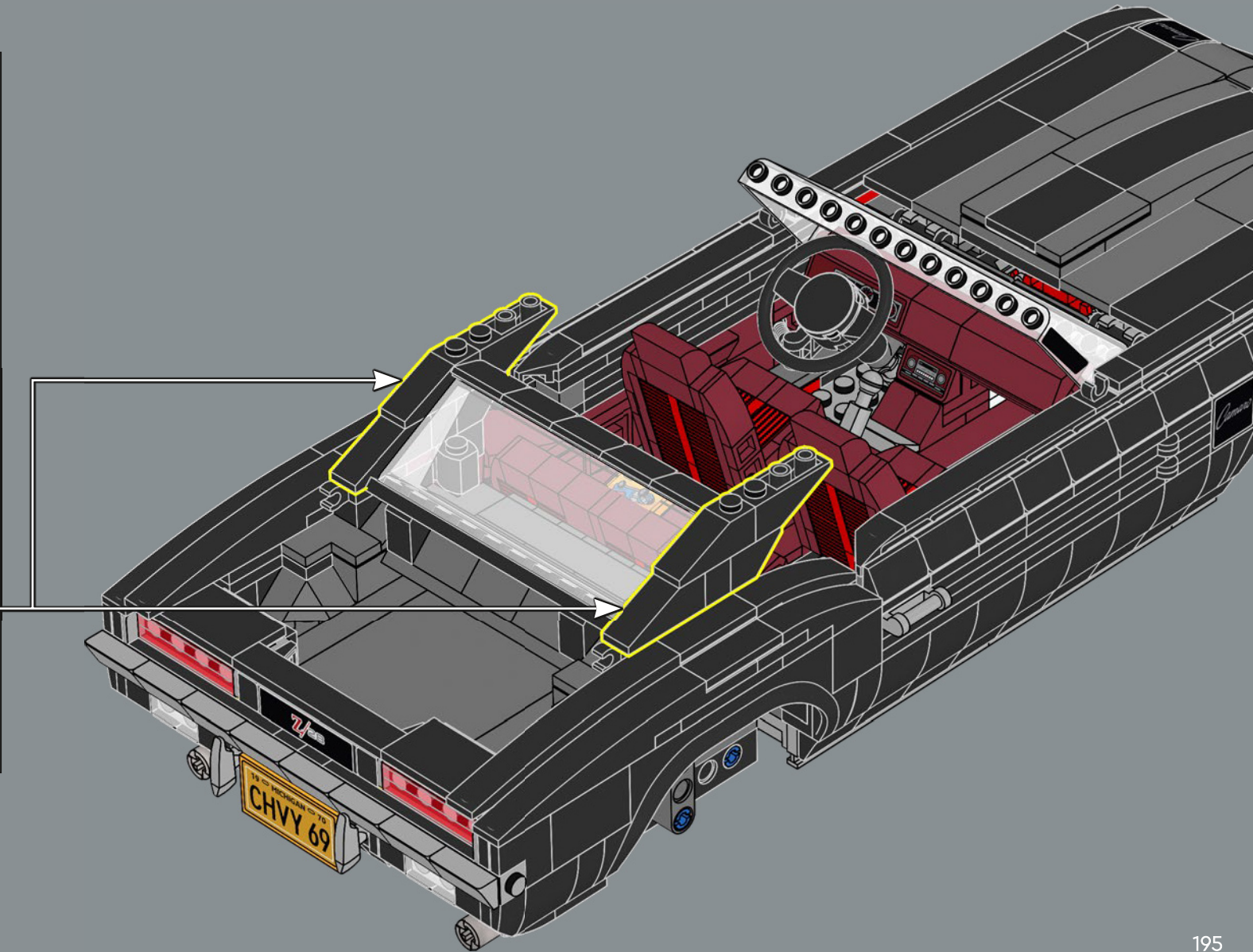
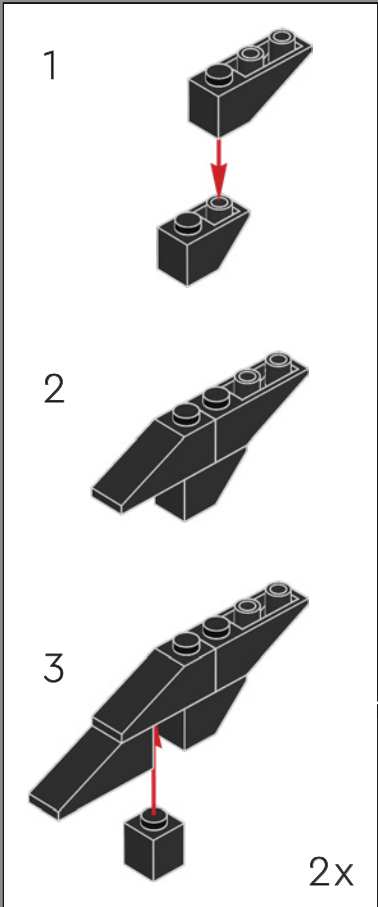

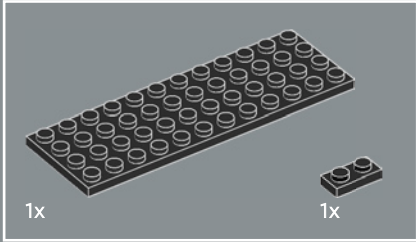
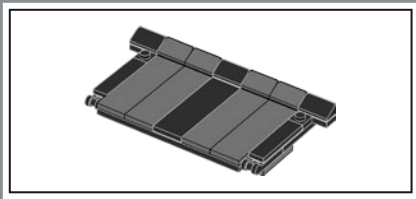

320

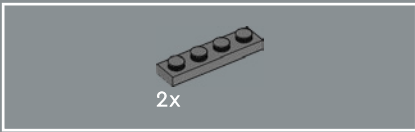
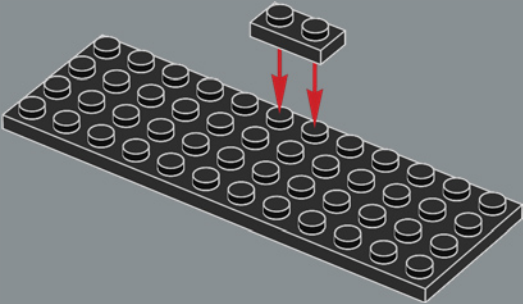

321

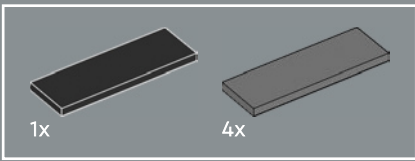
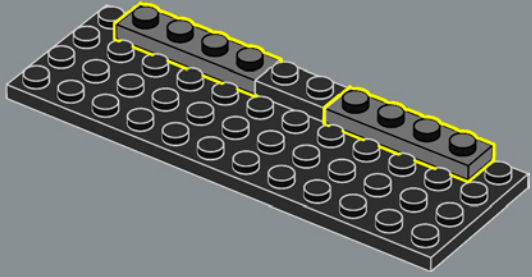

322

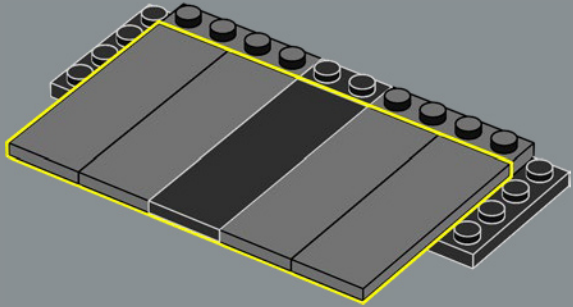

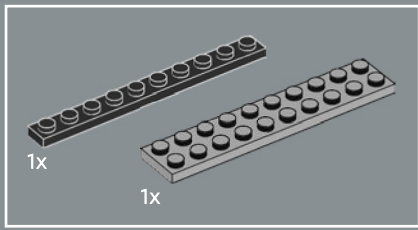

323

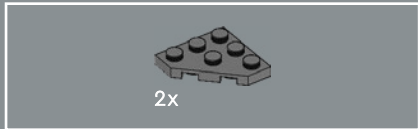
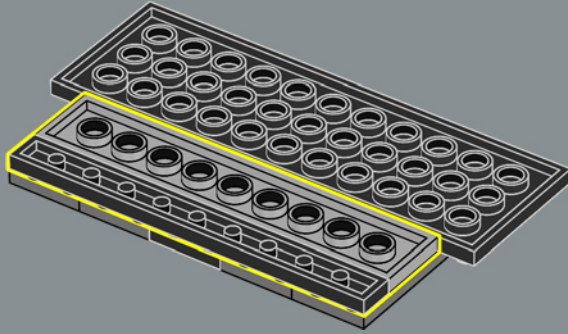

324

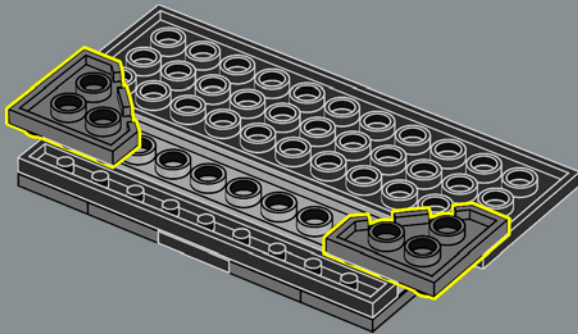

325

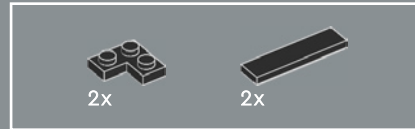
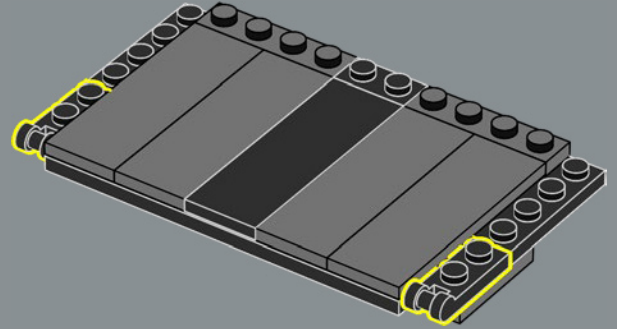

326

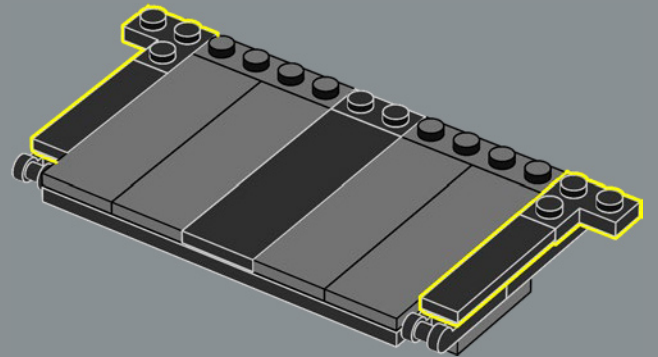



327

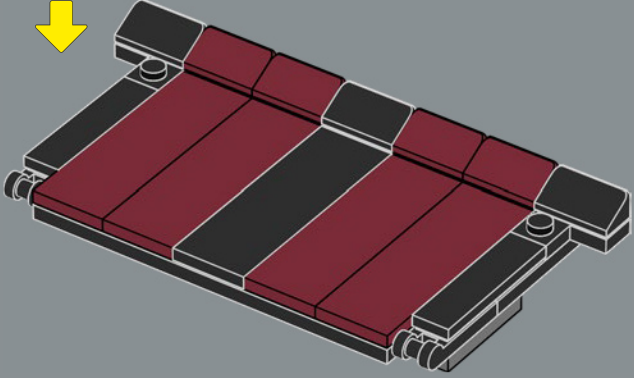
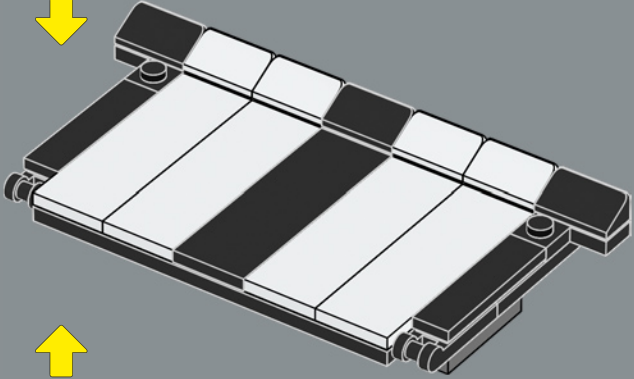
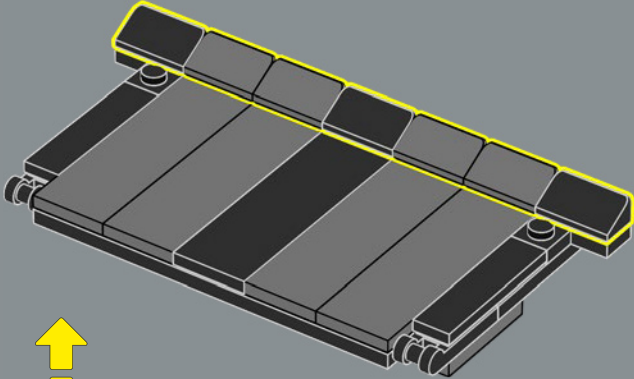

328

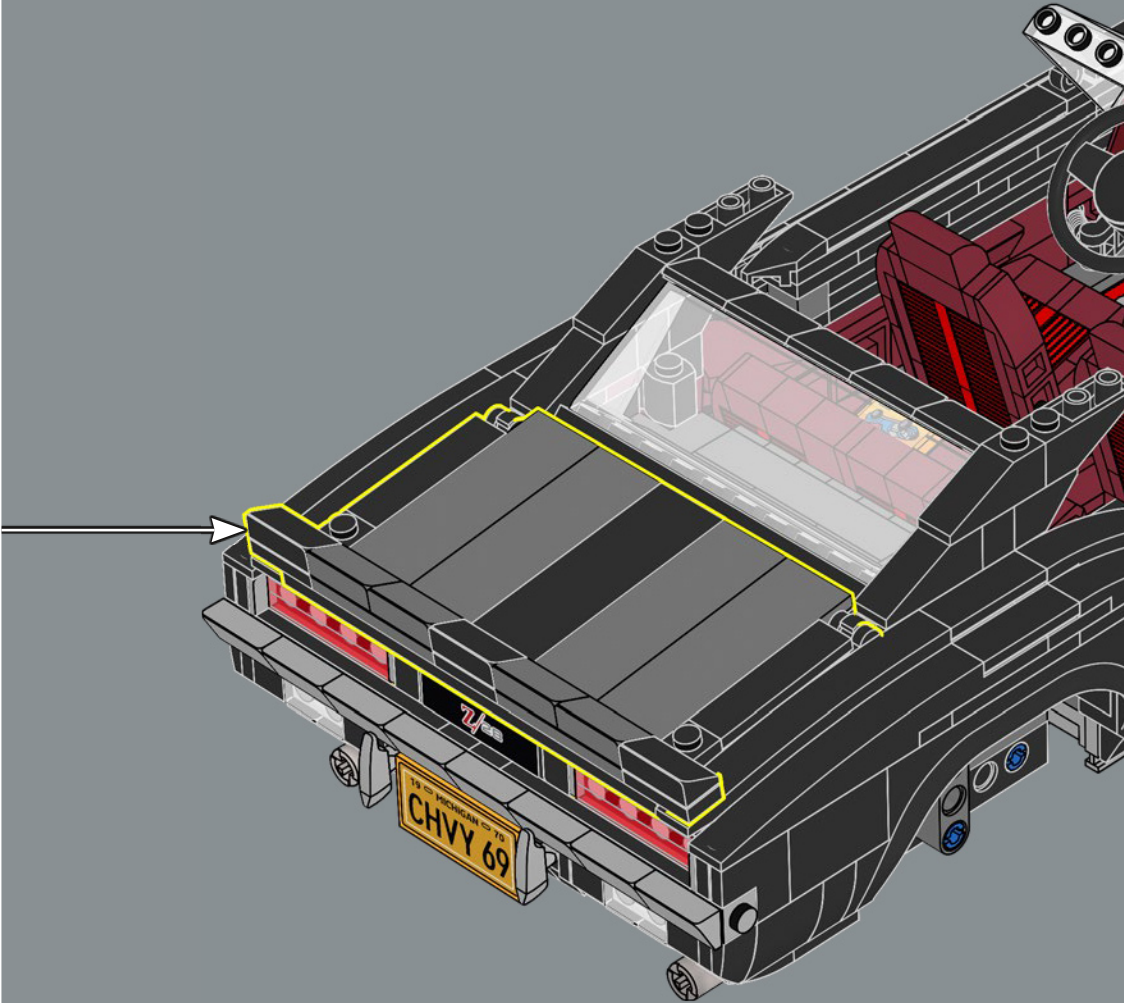

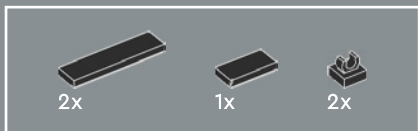

329

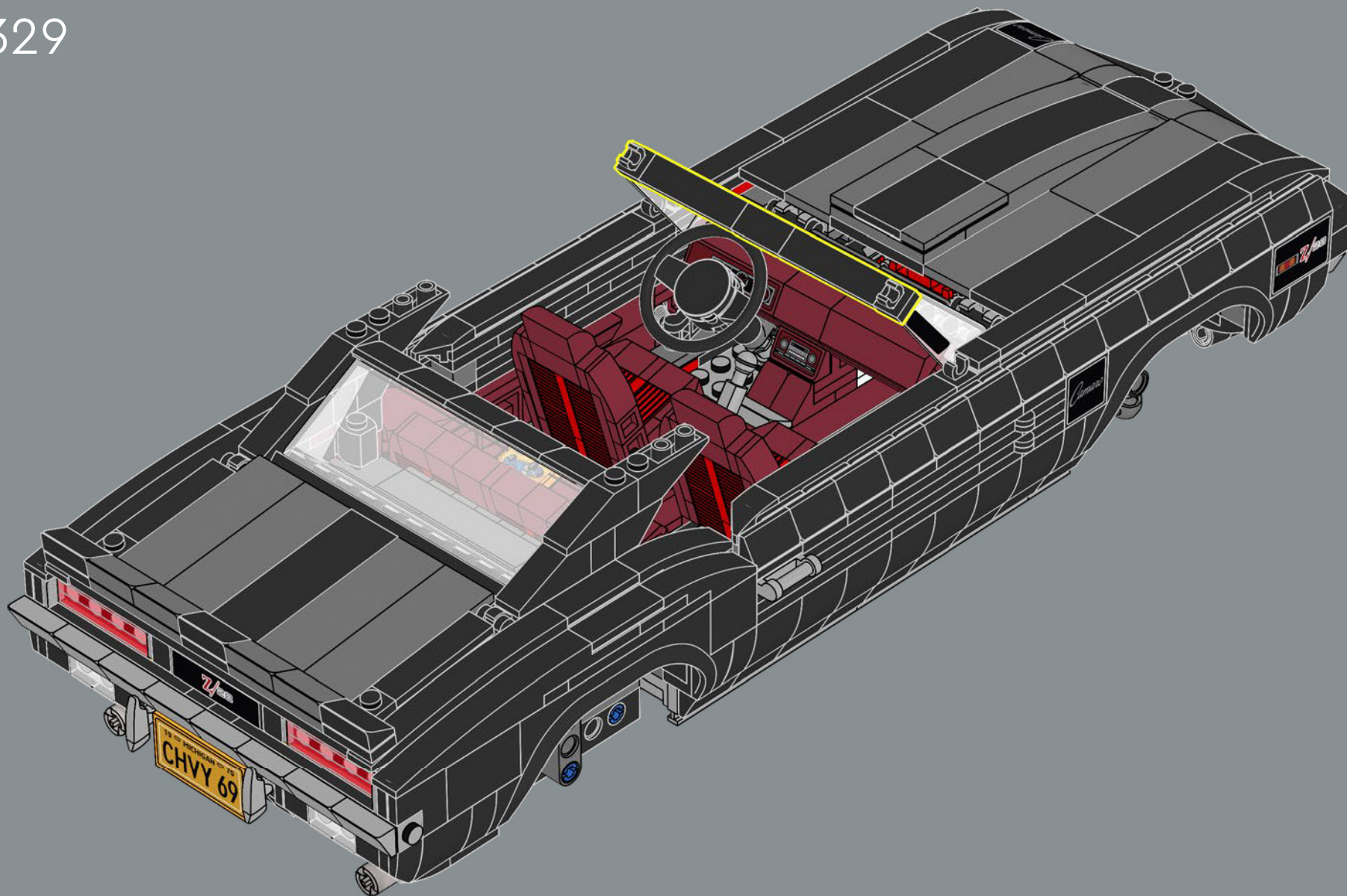

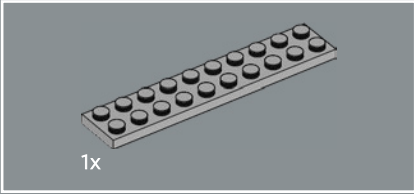
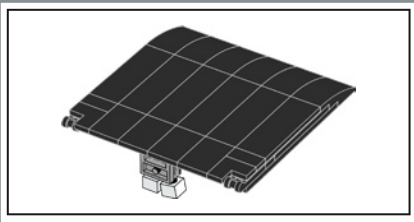

330

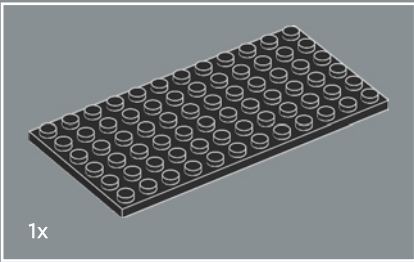
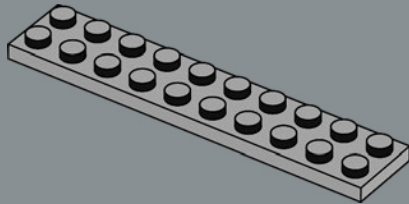

331

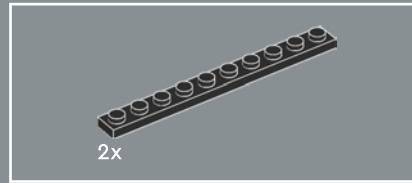
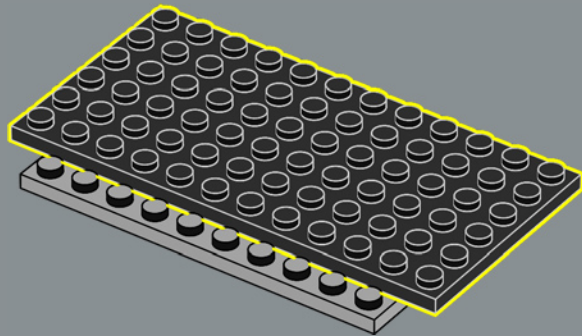

2x

332

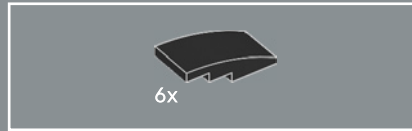
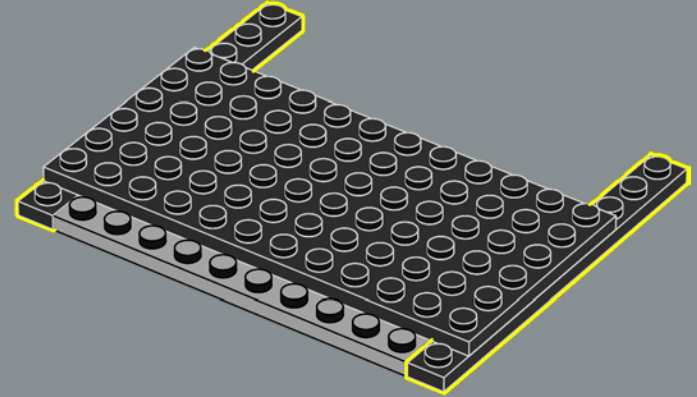

6x

333

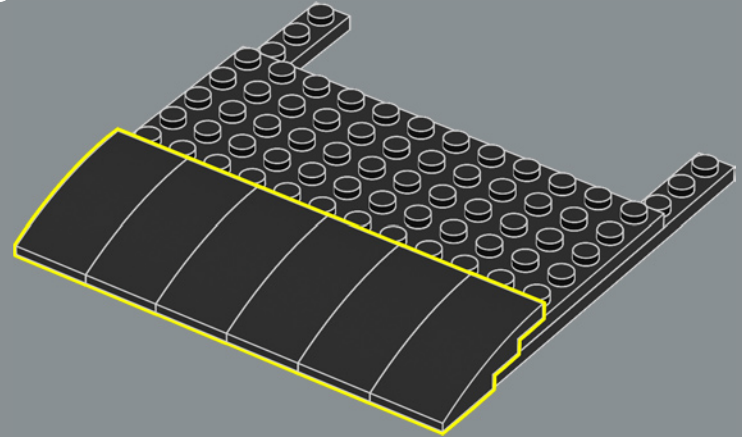



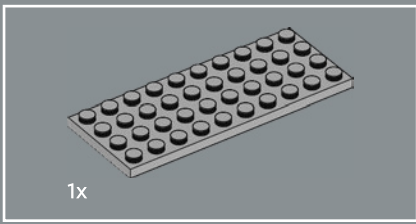

334

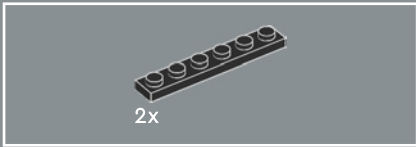
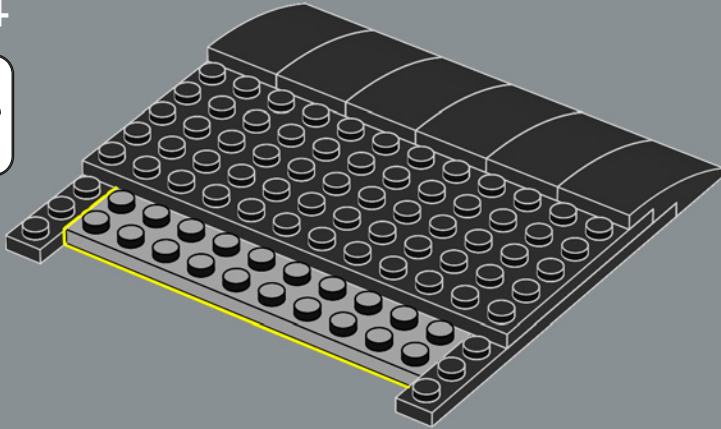

335

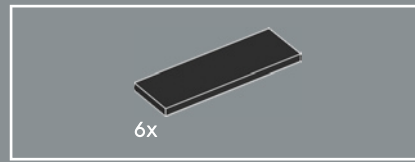
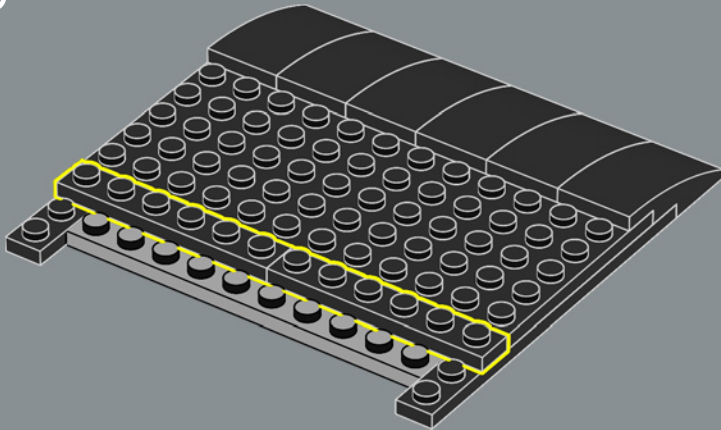

336

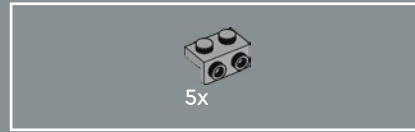
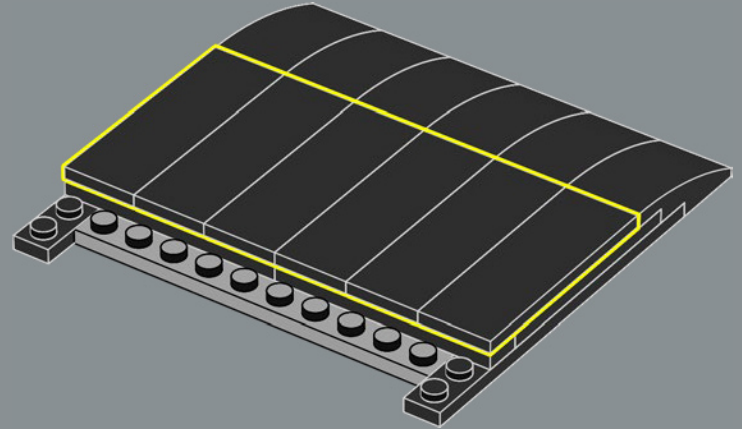

337

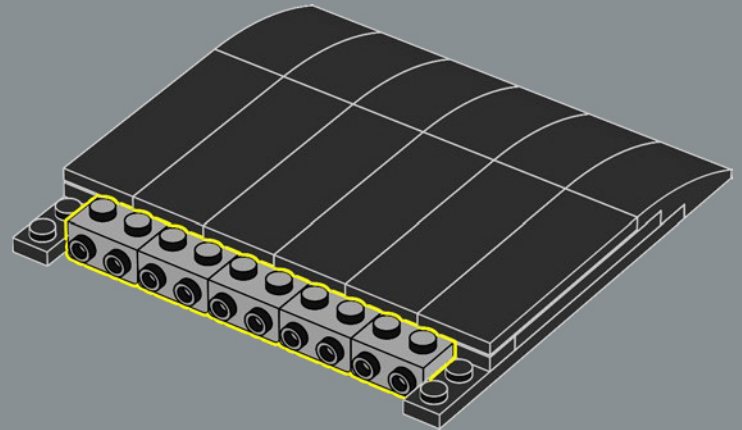

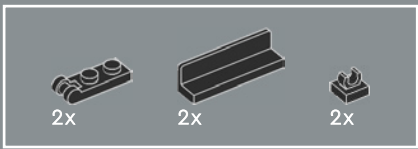

338

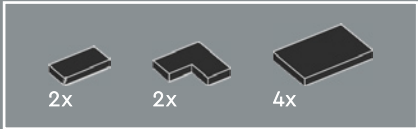
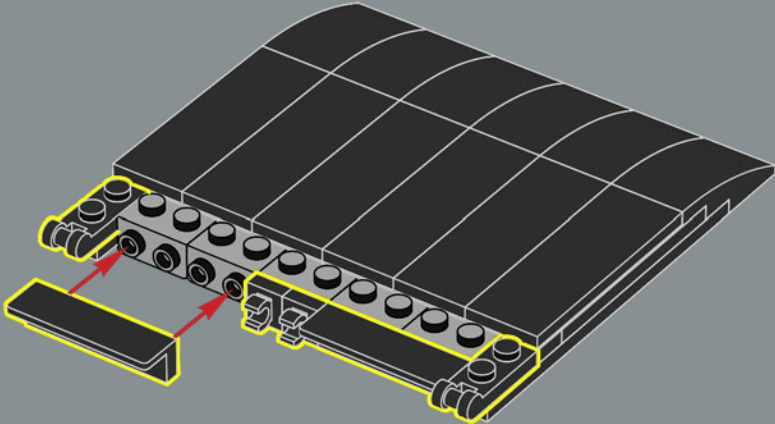

339

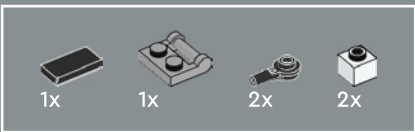
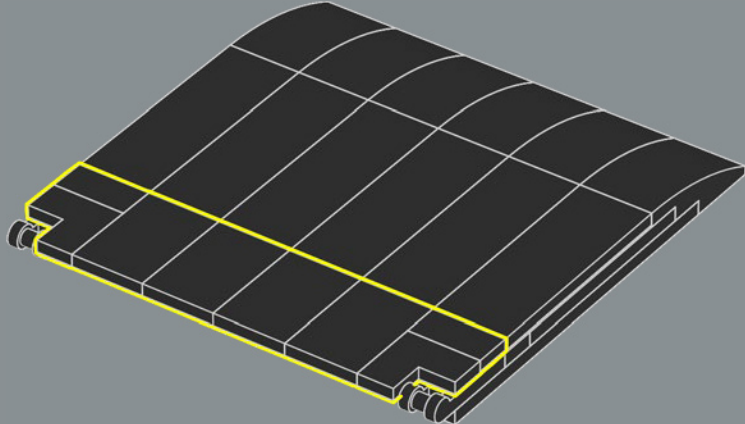

340

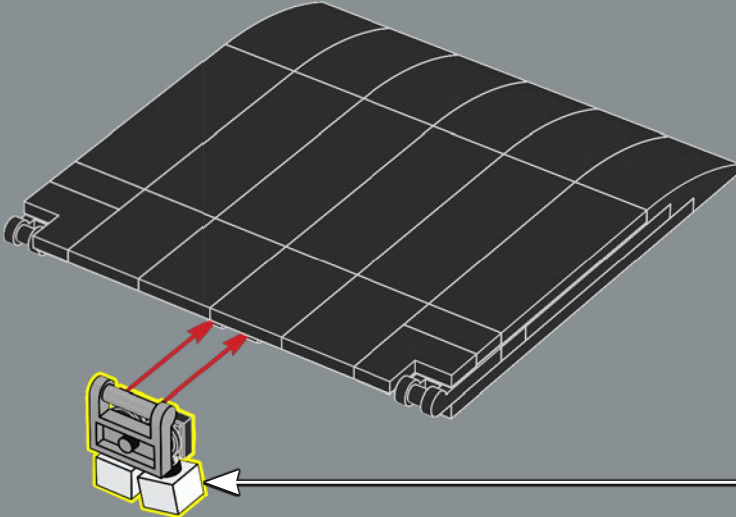
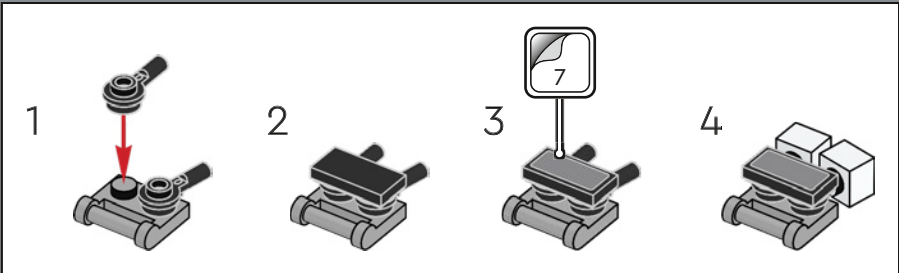

341

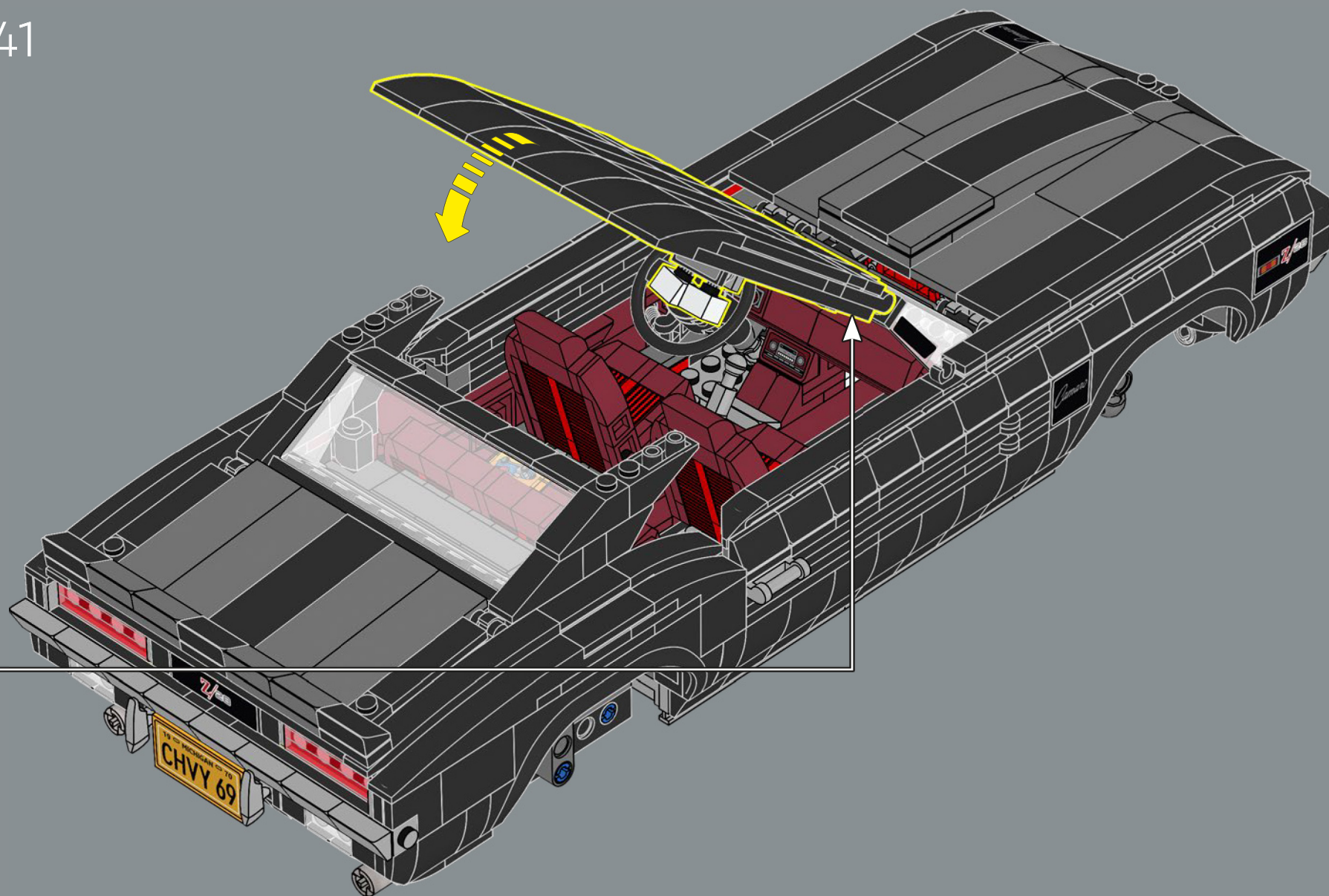

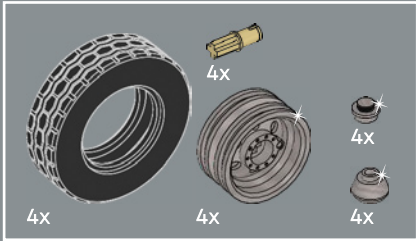
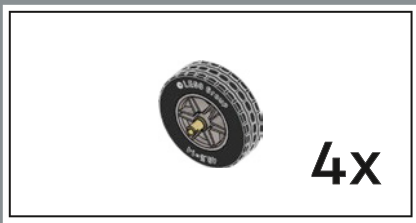

342

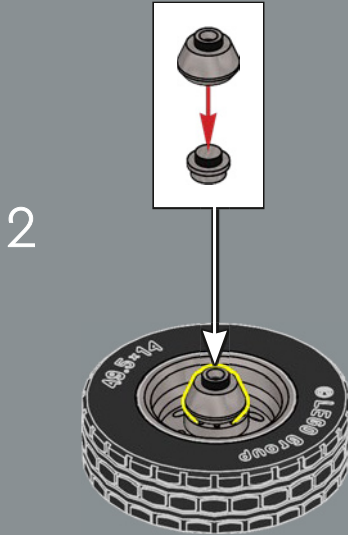
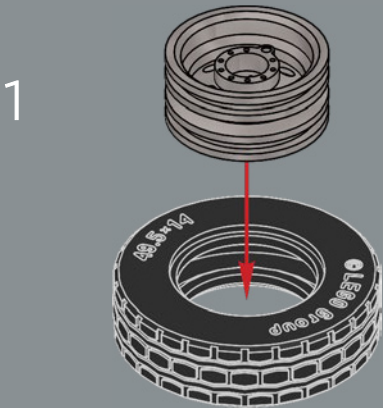

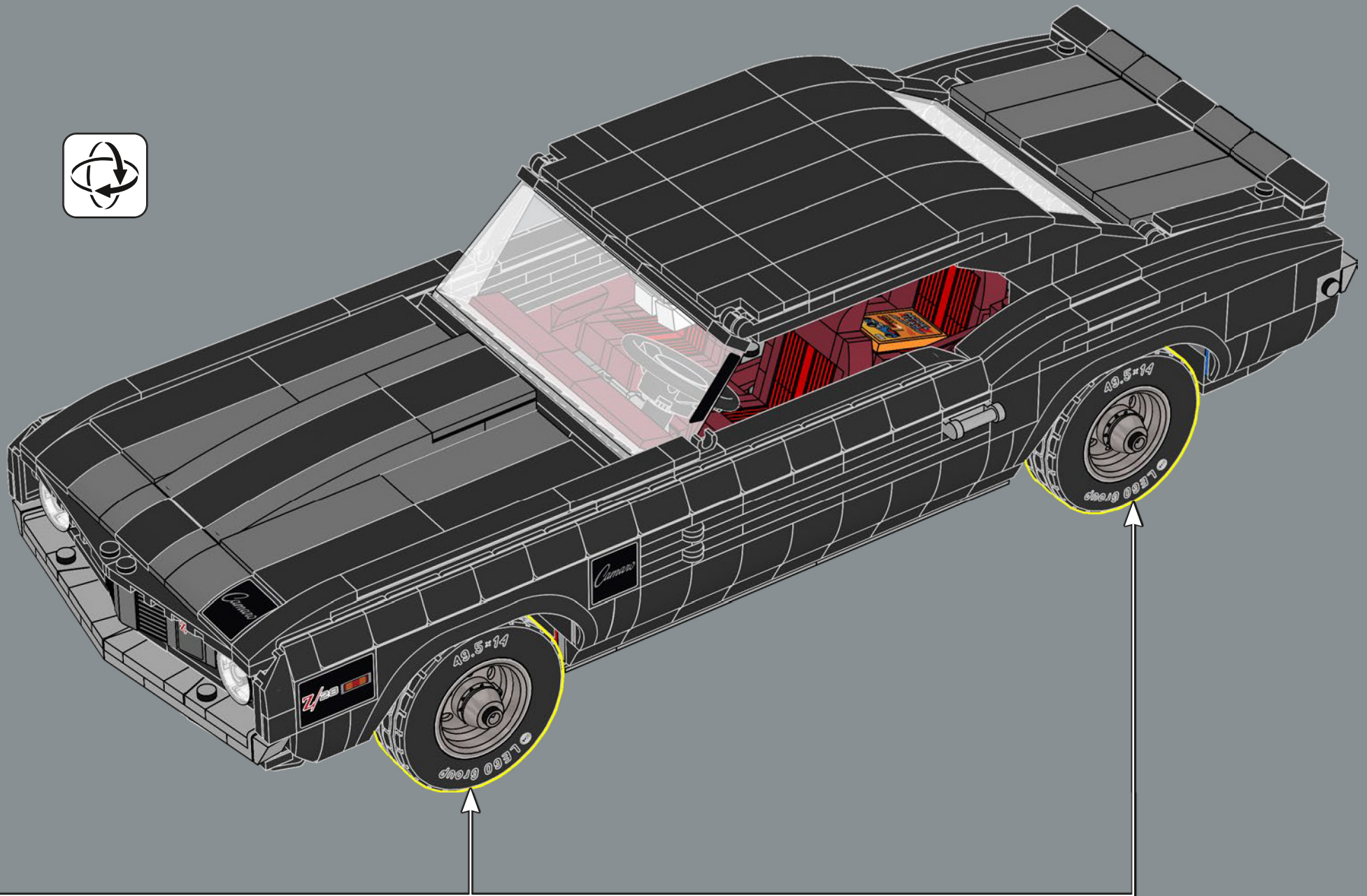



2x

343

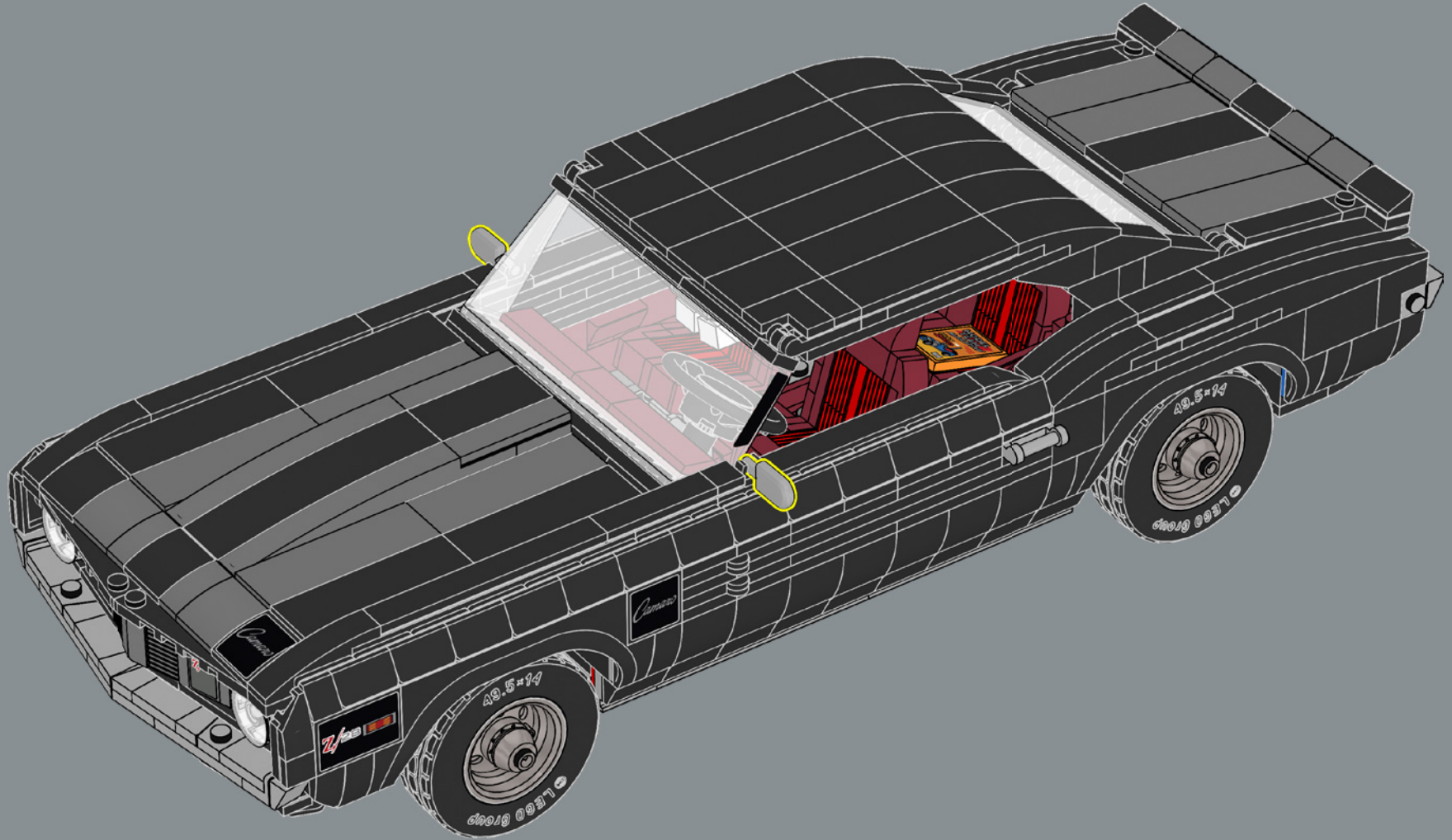

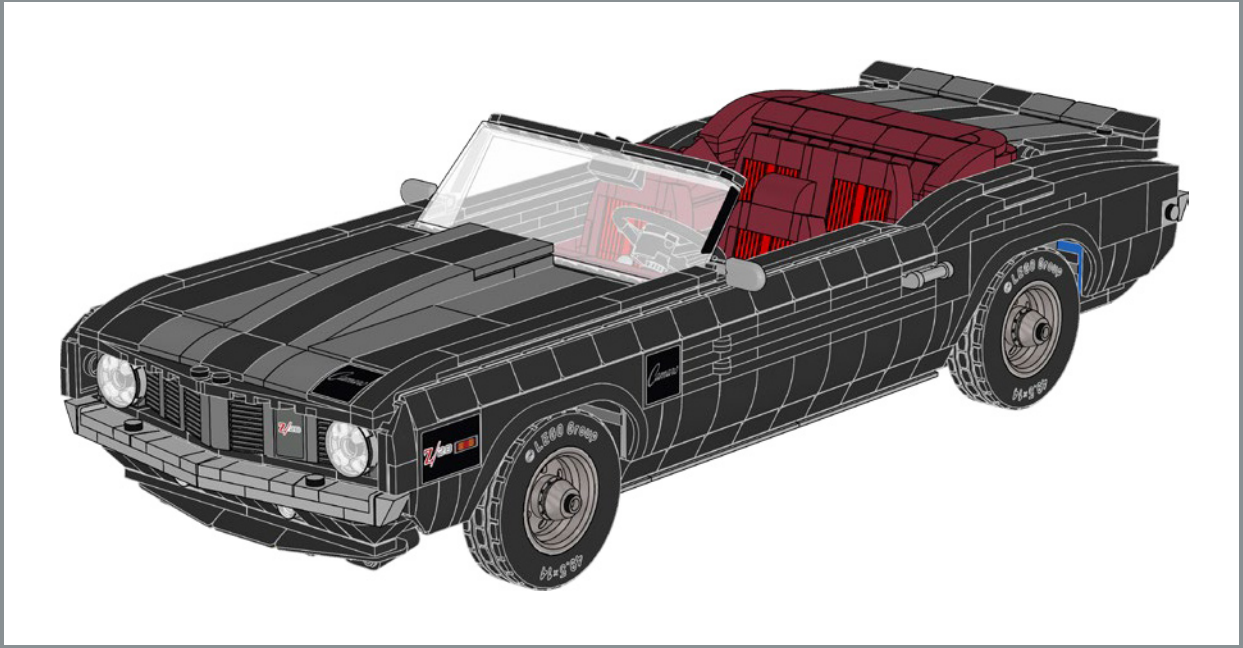

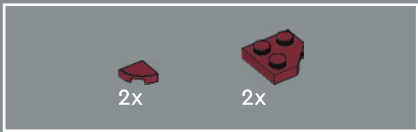

317

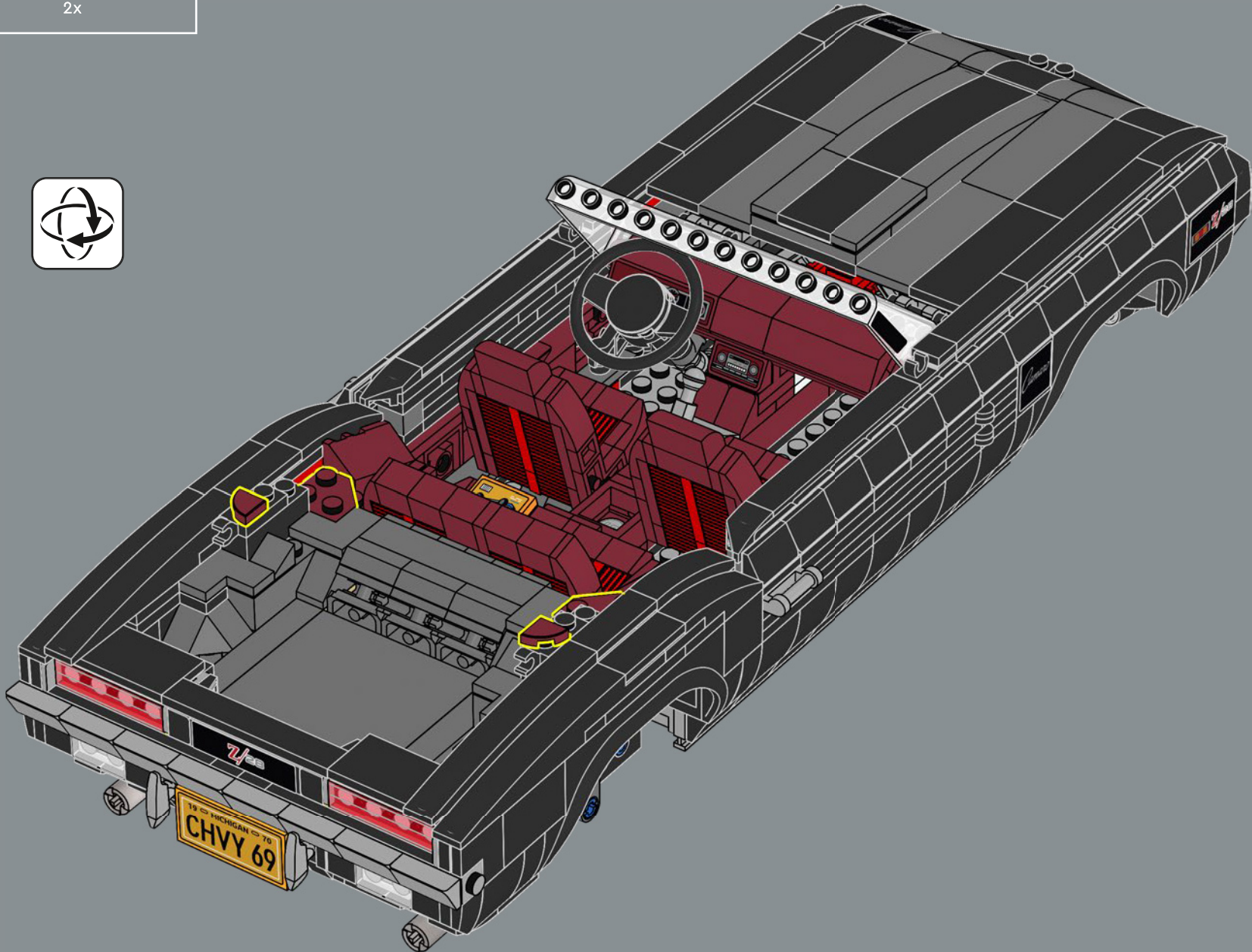





318

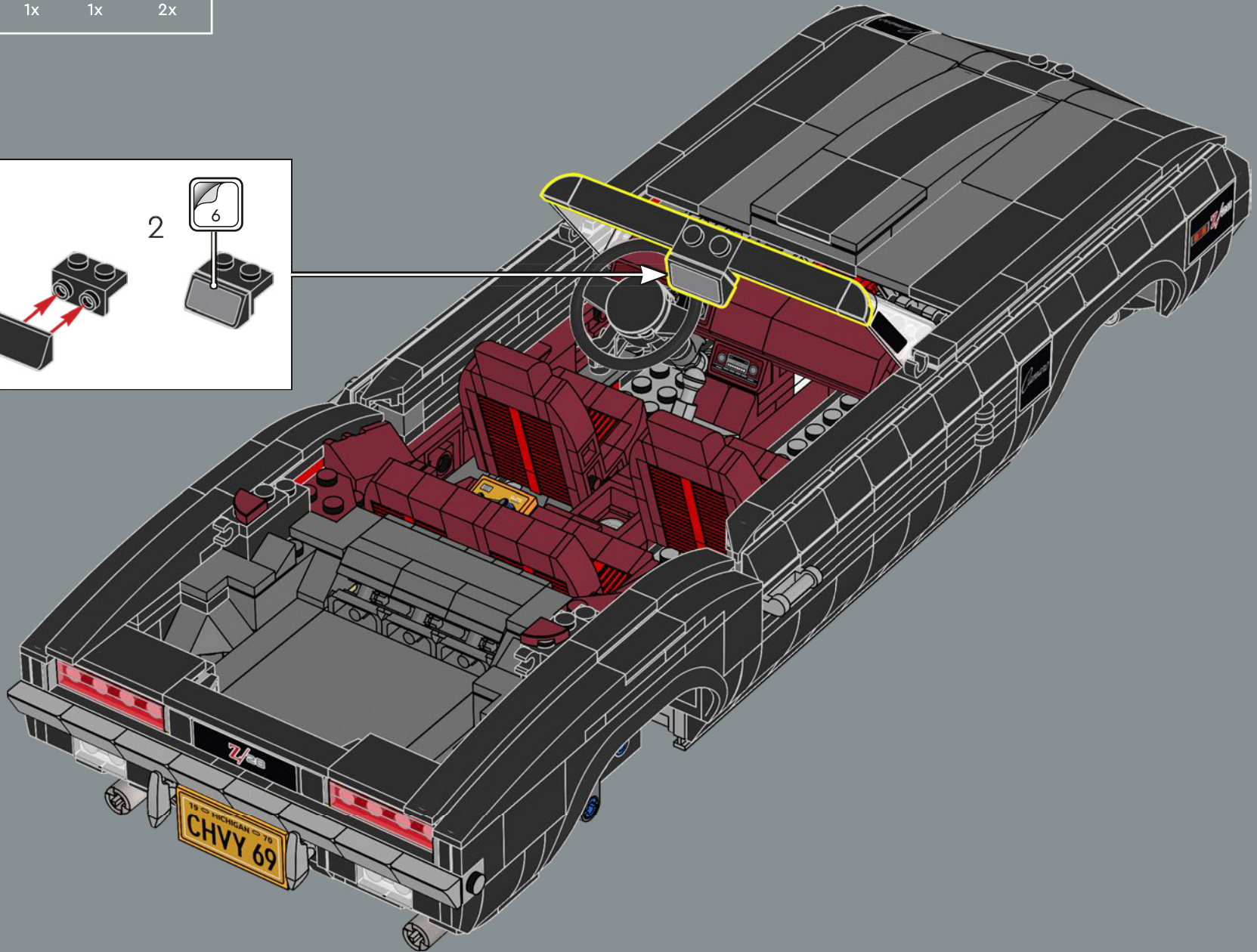
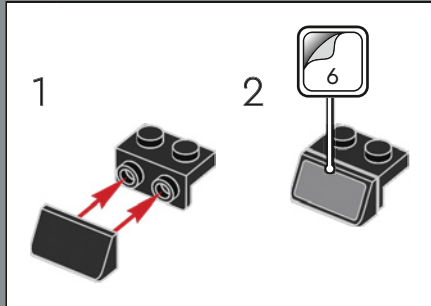

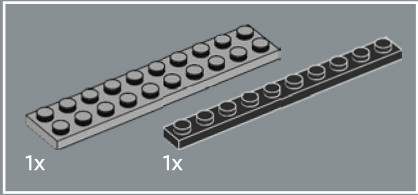

319

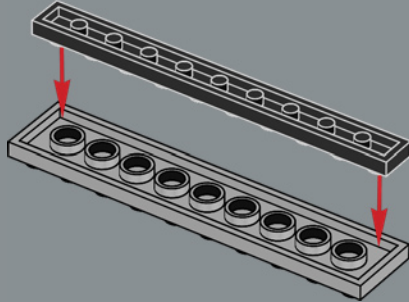

320

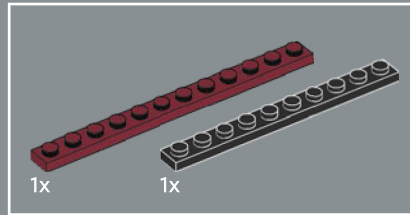
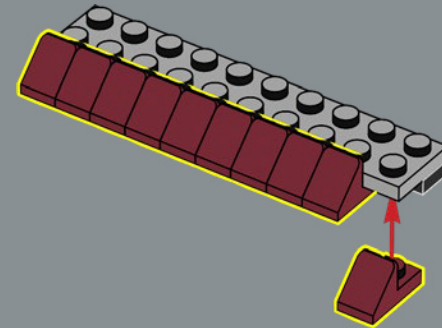

321

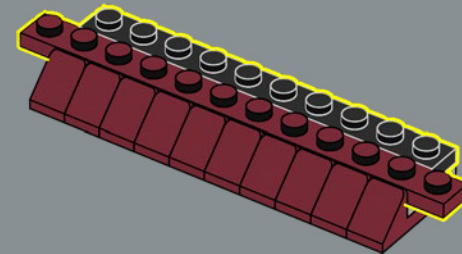

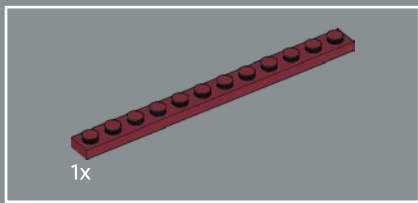

322

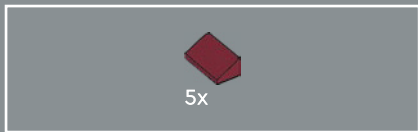
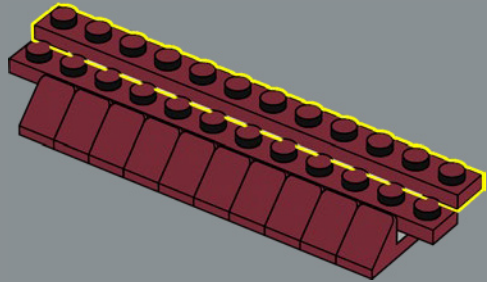

323

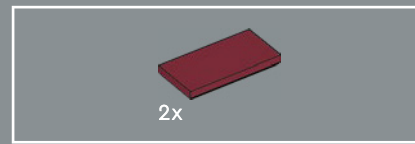
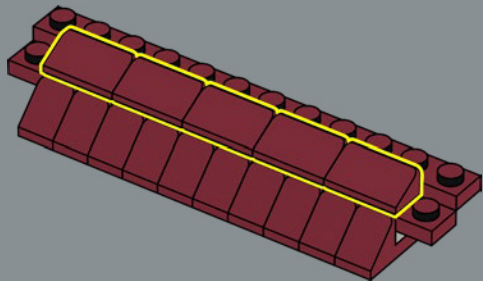

324

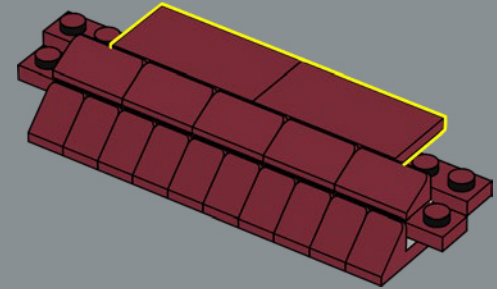

325

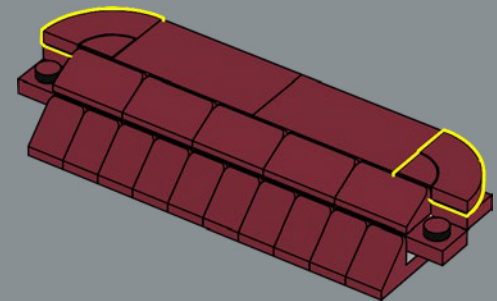

326

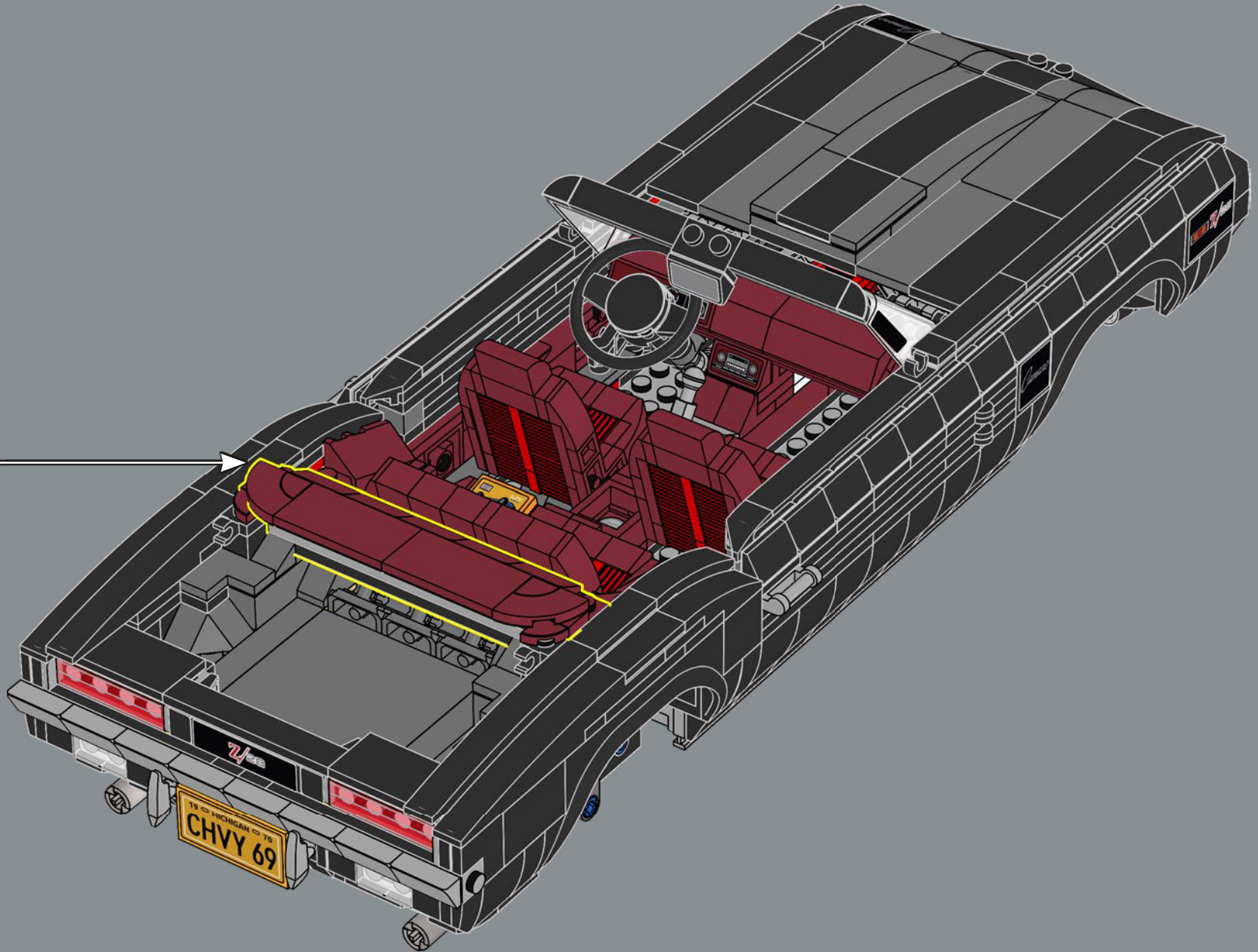

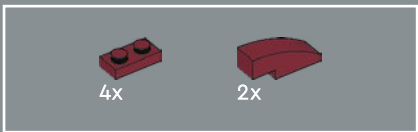

327

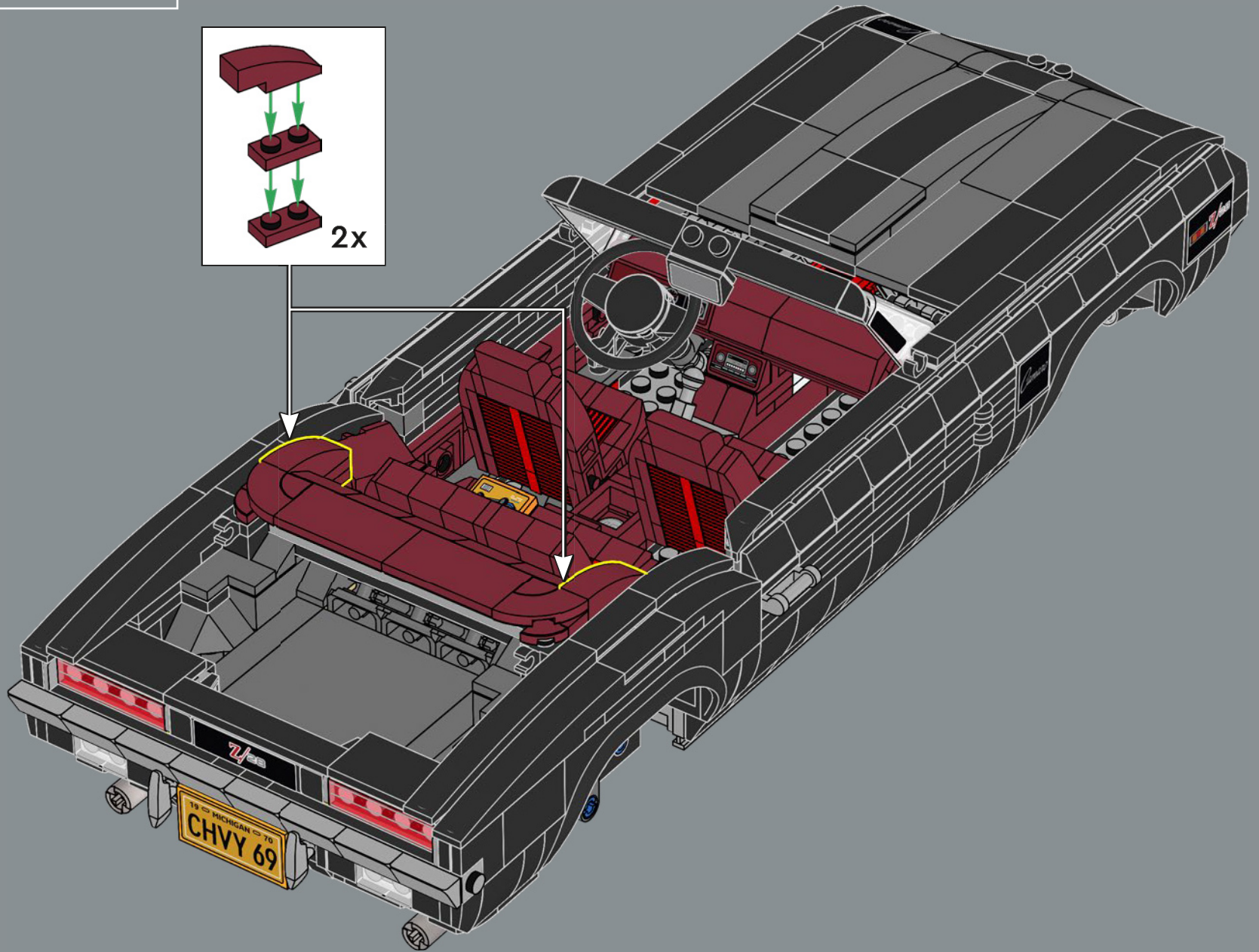
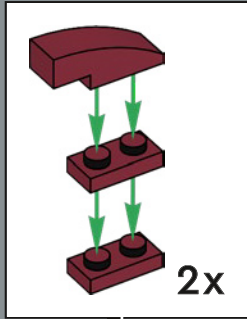

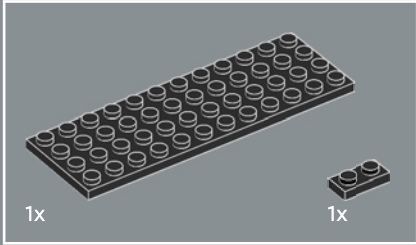
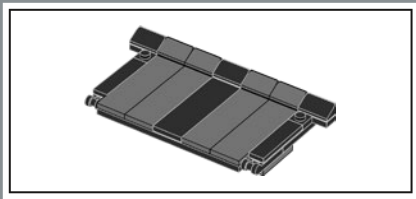

328

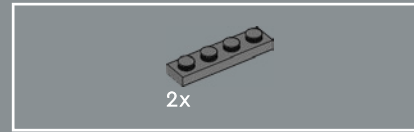
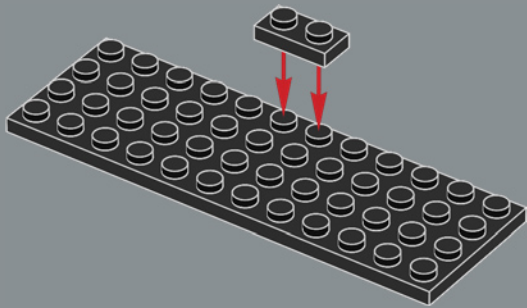

329

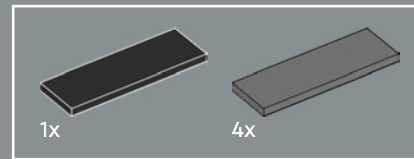
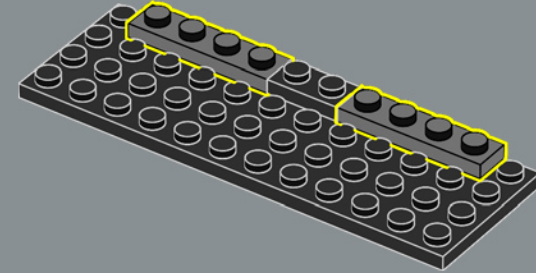

330

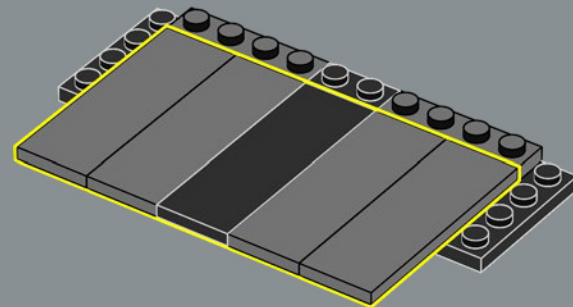

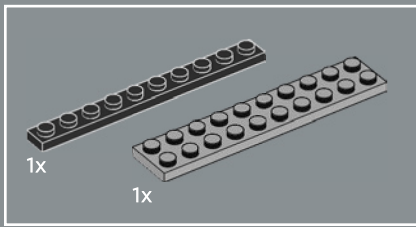

331

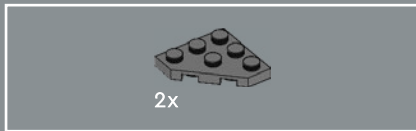
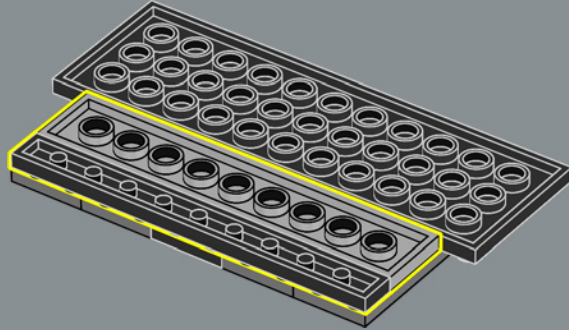

332

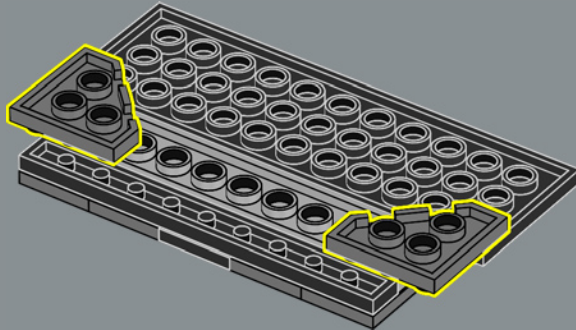

333

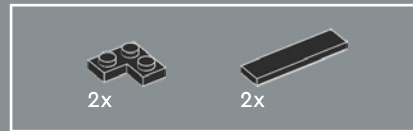
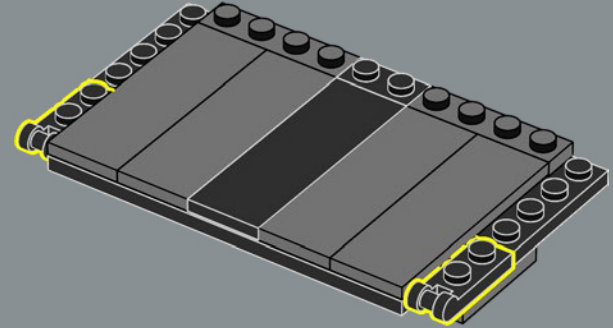

334

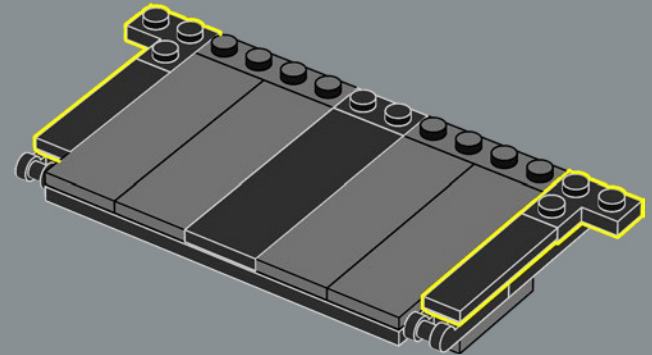

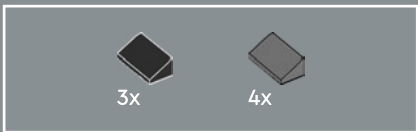

335

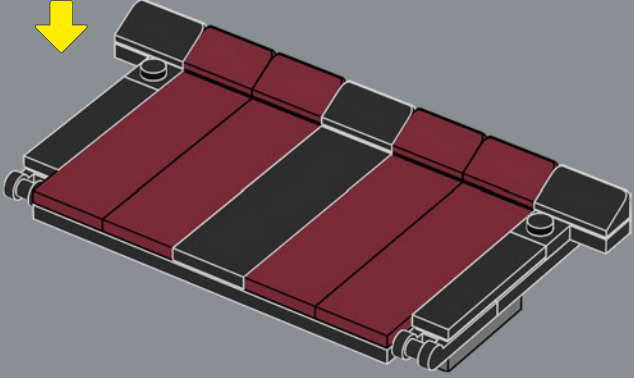
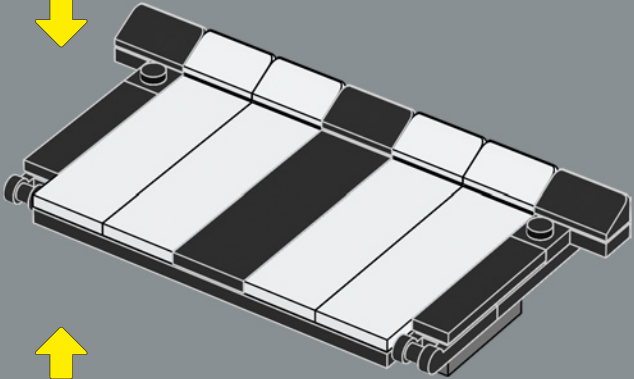
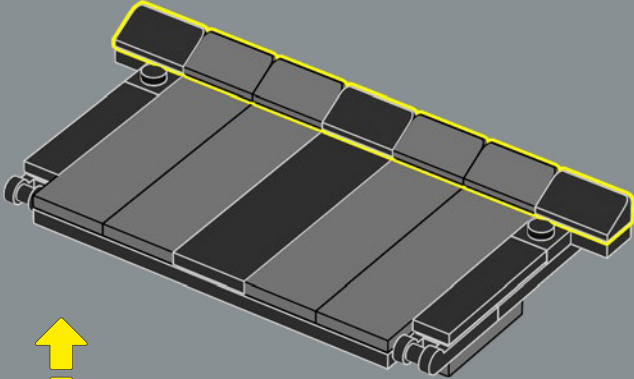

336

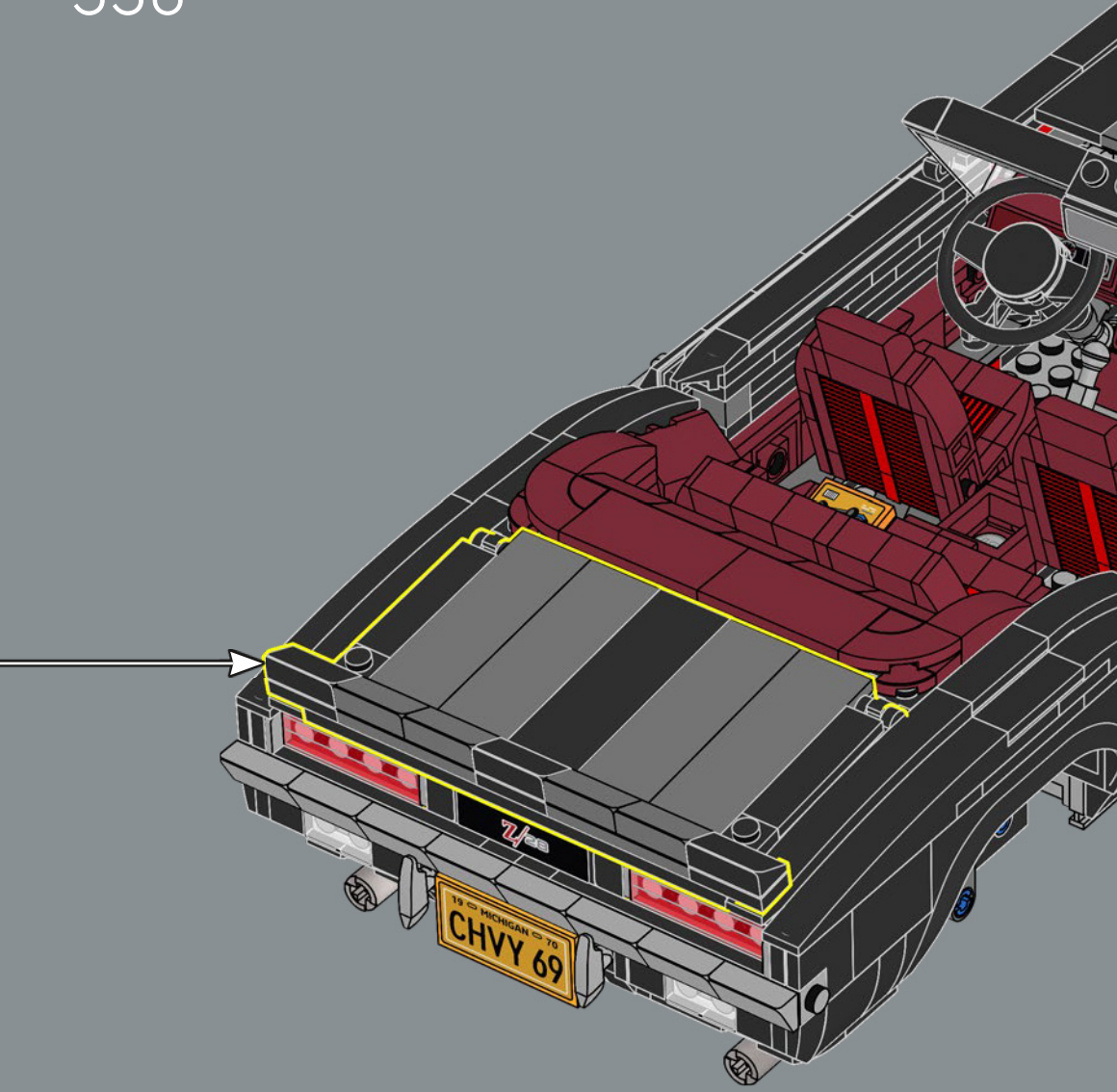



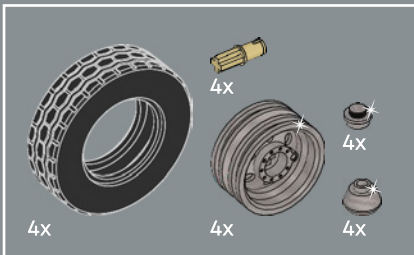
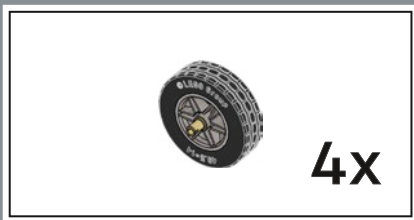

337

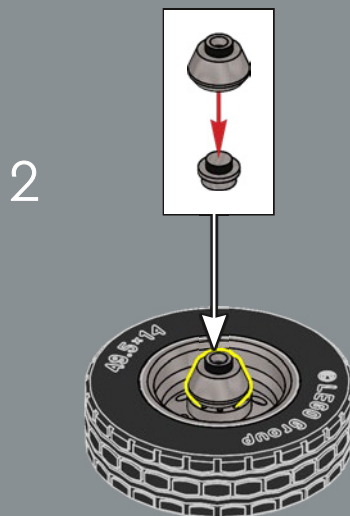
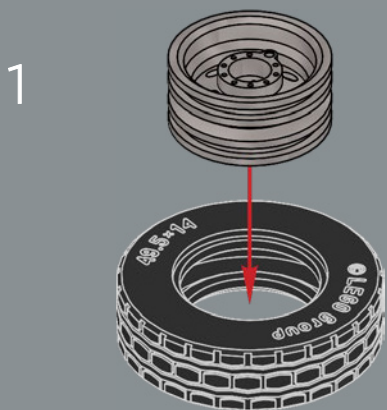

A limited replica production of the Camaro Z11 pace car from the 1969 Indianapolis 500 remains one of the most sought-after Camaro models.

Une réplique en édition limitée de la Camaro Z11 qui a fait office de voiture pilote lors de l'Indianapolis 500 de 1969 reste l'un des modèles de Camaro les plus recherchés.

La réplica de edición limitada del Camaro Z11 que se usó como auto de seguridad en las 500 Millas de Indianápolis de 1969 sigue siendo una de las variantes más codiciadas del Camaro.

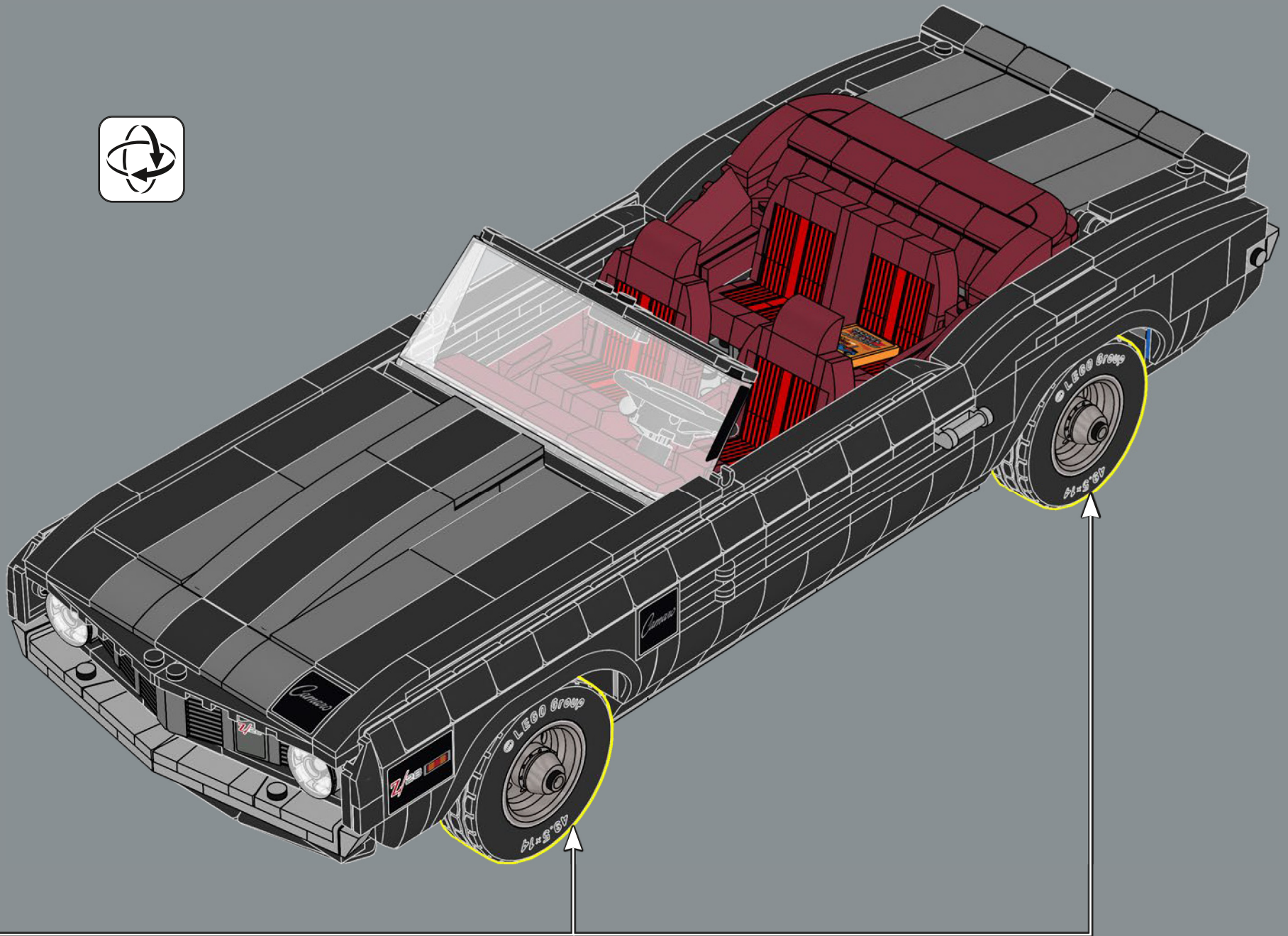



338

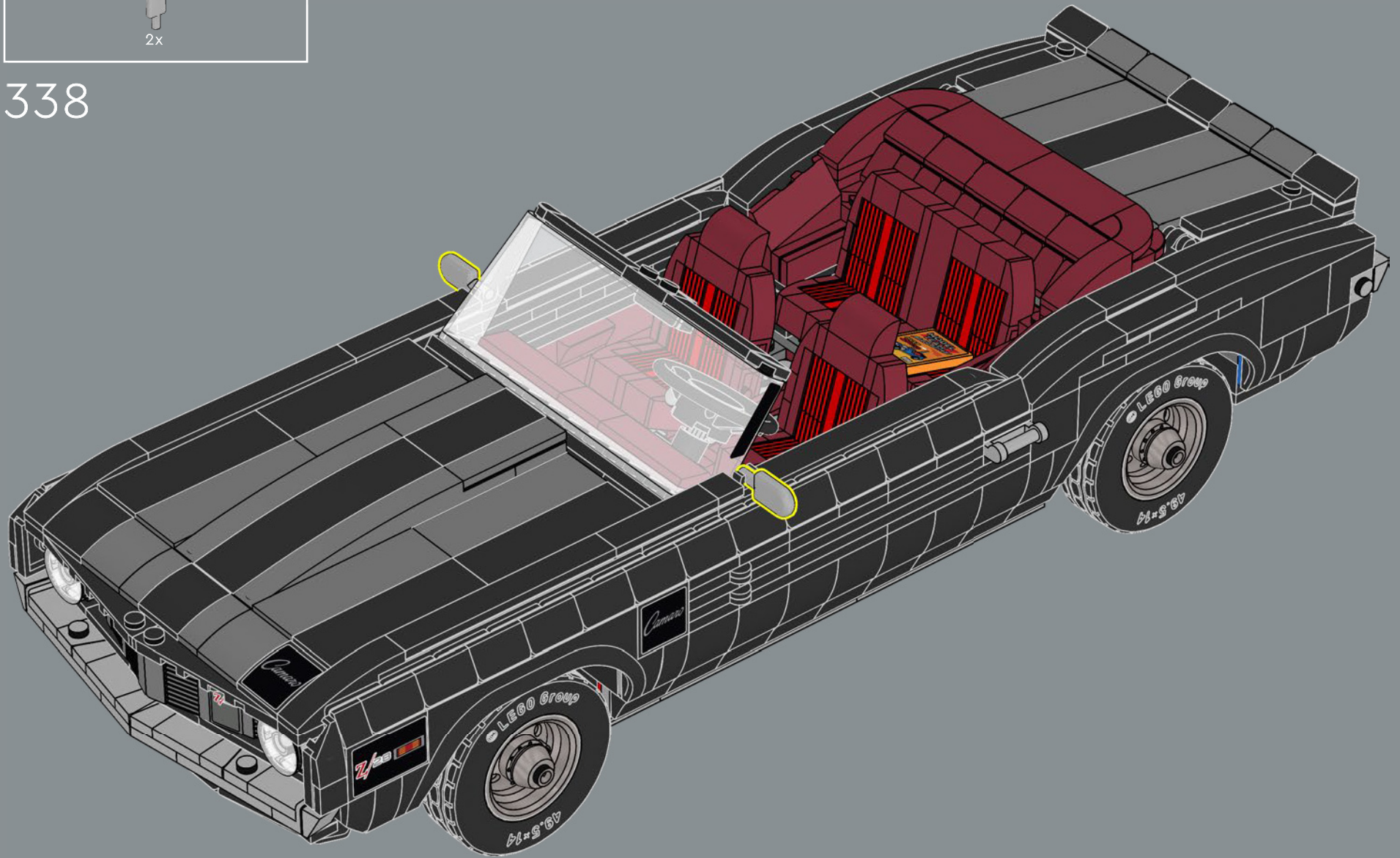

- 4x 4547489
- 2x 6034044
- 2x 6047220
- 4x 6276981
- 2x 6383985
- 4x 302201
- 2x 243101
- 2x 371001
- 2x 6104805
- 3x 302001
- 8x 6332042
- 2x 6035405
- 2x 6242241
- 3x 6347287
- 1x 6265740
- 2x 6146525
- 2x 614101
- 1x 6371416
- 1x 6289797
- 2x 4162465
- 8x 418793
- 2x 6360037
- 8x 6024495
- 6x 4523145
- 8x 4121921
- 3x 4143409
- 3x 4249019
- 6x 6253003
- 2x 6013938
- 4x 4666579
- 2x 6416525
- 24x 6219677
- 2x 300321
- 2x 4558886
- 1x 654121
- 2x 370021
- 2x 6385920
- 1x 6275178
- 1x 330021
- 2x 307021
- 2x 302321
- 4x 6092565
- 2x 306921
- 6x 362321
- 2x 6378120
- 12x 371021
- 1x 303221
- 1x 303421
- 2x 6337002
- 2x 6347308
- 6x 6261351
- 5x 6168634
- 1x 6266205
- 8x 6168619
- 1x 6271820
- 3x 4142865
- 4x 6347789
- 1x 6130002
- 6x 393721
- 2x 300223
- 6x 6290531
- 1x 4212411
- 1x 6171063
- 2x 6057802
- 2x 306923
- 4x 6252060
- 2x 6196596
- 3x 303423
- 3x 6117968
- 4x 4206482
- 10x 6299413
- 2x 393723
- 2x 300524
- 2x 235724
- 2x 654124
- 14x 302324
- 2x 6195183
- 2x 6271167
- 1x 6170294
- 1x 6331822
- 2x 366624
- 6x 6248833
- 10x 300526
- 2x 4644456
- 4x 300426
- 6x 362226
- 2x 300226
- 5x 301026
- 2x 4584274
- 3x 370226
- 4x 4504382
- 53x 4548180
- 2x 4121966
- 4x 6267487
- 6x 366526
- 12x 6069000
- 1x 303926
- 2x 6176768
- 4x 428626
- 6x 428726
- 1x 6064228
- 5x 6181720
- 4x 6273589
- 2x 4107558
- 4x 302426
- 2x 6388352
- 6x 307026
- 44x 302326
- 8x 306926
- 2x 6214807
- 14x 6192346
- 4x 306826
- 2x 6312724
- 10x 302226
- 6x 242026
- 4x 6133722
- 4x 6195271
- 1x 403226
- 5x 6181713
- 2x 6184784
- 10x 6047276
- 26x 6053077
- 2x 6211476
- 2x 4618880
- 2x 6280394
- 1x 6319983
- 1x 6316923
- 1x 6331026
- 6x 6037746
- 6x 4647286
- 1x 6296083
- 4x 6037664
- 6x 243126
- 6x 371026
- 7x 302026
- 4x 4560182
- 2x 6350415
- 3x 663626
- 12x 366626
- 11x 6318582
- 6x 416226
- 1x 303226
- 1x 395826
- 14x 447726

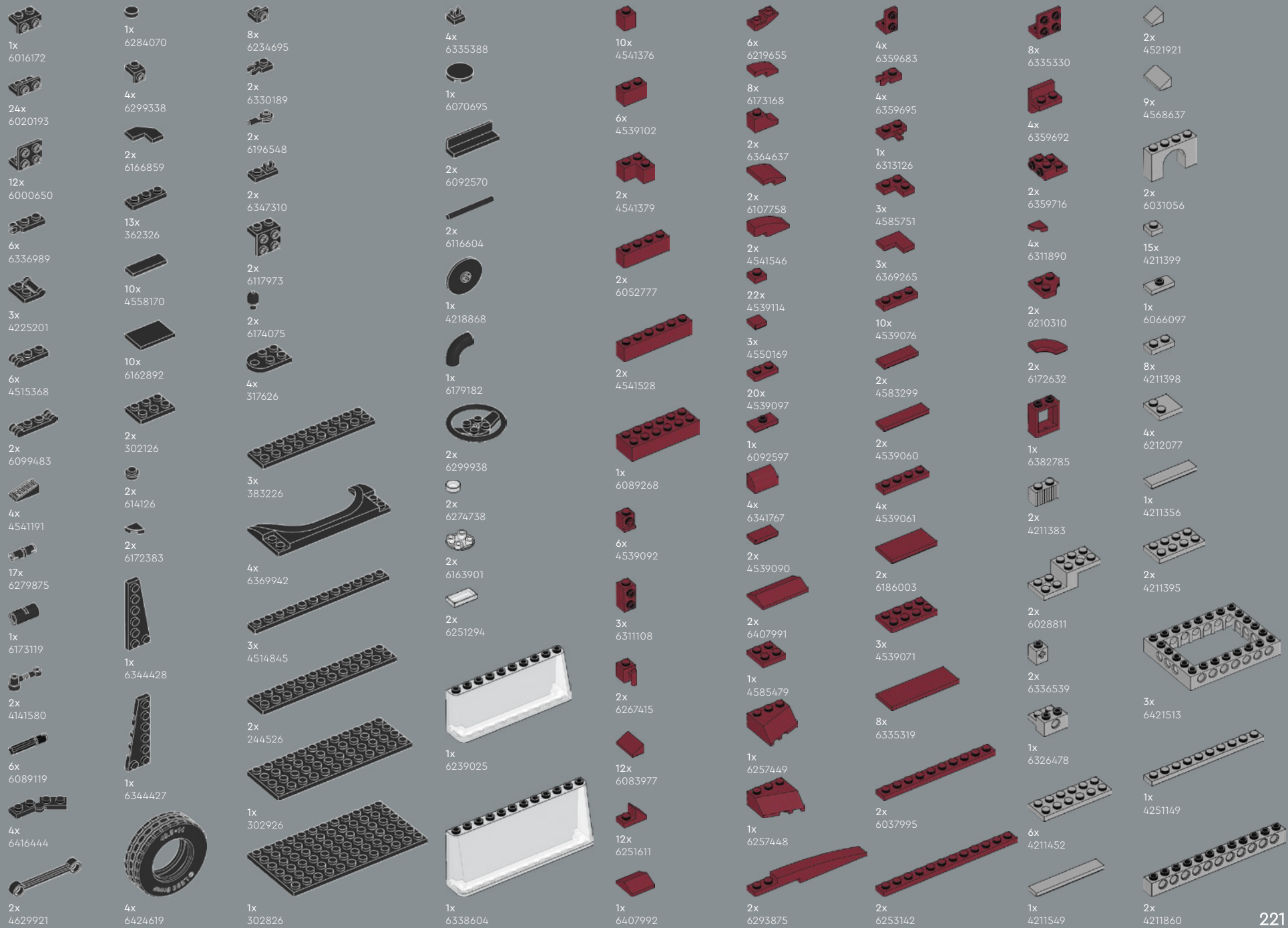



Customer Service  
 Kundenservice  
 Service Client  
 Assistenza clienti  
 Atención al cliente  
 Serviço de Apoio ao Consumidor  
 Ügyfélszolgálat  
 Klientu apkalpošanas dienests  
 Serviciul pentru clienț  
 客户服务  
 コンシューマーサービス  
 고객 서비스  
**LEGO.com/service**



# FEEDBACK AND WIN



## FEEDBACK AND WIN

Your feedback will help shape the future development of this product series.

Please visit:

## FEEDBACK UND GEWINNEN

Dein Feedback trägt zur Weiterentwicklung dieser Produktreihe bei.

Geh auf:

## COMMENTEZ ET GAGNEZ

Vos commentaires nous aideront à concevoir les futurs produits de cette gamme.

Rendez-vous sur :

## COMENTA Y GANA

Tu opinión nos ayudará a dar forma al desarrollo de esta serie de productos en el futuro.

Visita:

## 反馈有奖

您的反馈将有助于我们在今后改进本系列产品。

请访问：

[LEGO.com/productfeedback](https://www.lego.com/productfeedback)

By completing, you will automatically enter a drawing to win a LEGO® set.

Terms & Conditions apply.

Durch Ausfüllen nimmst du automatisch an der Verlosung eines LEGO® Preises teil.

Es gelten die Teilnahmebedingungen.

En envoyant vos commentaires, vous serez automatiquement inscrit(e) à un tirage au sort qui vous permettra de remporter un prix LEGO®.

Offre soumise à conditions.

Al contestar, participarás automáticamente en el sorteo y podrás ganar un set LEGO®.

Sujeto a Términos y Condiciones.

完成我们的反馈调查，即可自动进入抽奖环节，赢取乐高®套装。

适用《条款和条件》。

