





# HERZLICH WILLKOMMEN

Dieses Herzensprojekt unseres Designteams, an dem zunächst nur in der Freizeit gearbeitet wurde, hat sich seit 2007 zu einer pulsierenden Innenstadt entwickelt, die von toller Architektur, opulenter Einrichtung, raffiniert verwendeten LEGO Steinen und fröhlichen Minifiguren geprägt ist. Und wie lässt sich das 15-jährige Jubiläum der Kollektion „Bauen mit Modulen“ am besten feiern? Natürlich mit einem der am sehnlichsten gewünschten Modelle der Fans!

Willkommen im historischen **Boutique-Hotel!** Dieses keilförmige Bauwerk beeindruckt mit unzähligen eleganten Formen und feinen Details, die die europäische Architektur um die Jahrhundertwende grandios widerspiegeln. Zudem verweisen viele kleine Geschichten und subtile Anspielungen auf frühere Modelle aus der Produktreihe „Bauen mit Modulen“. Wie viele dieser „altbekannten“ Elemente wirst du wiedererkennen?





*Von links nach rechts:*

Michael Psiaki  
Astrid Graabæk  
Wesley Alan Talbott  
Torben Kidde Skov  
Anderson Ward Grubb  
Chris McVeigh  
Jamie Berard

15 faszinierende Jahre „Bauen mit Modulen“!  
Dies sind alle Modelle und ihre zahlreichen  
Designerinnen und Designer



Anderson Ward Grubb  
Designer des Boutique-Hotels (10297)



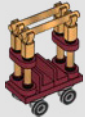
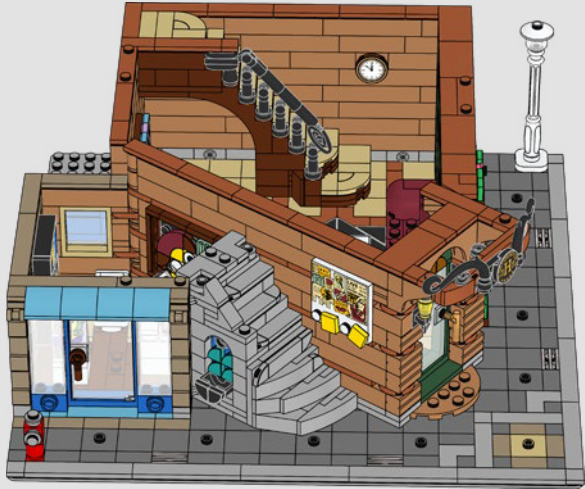
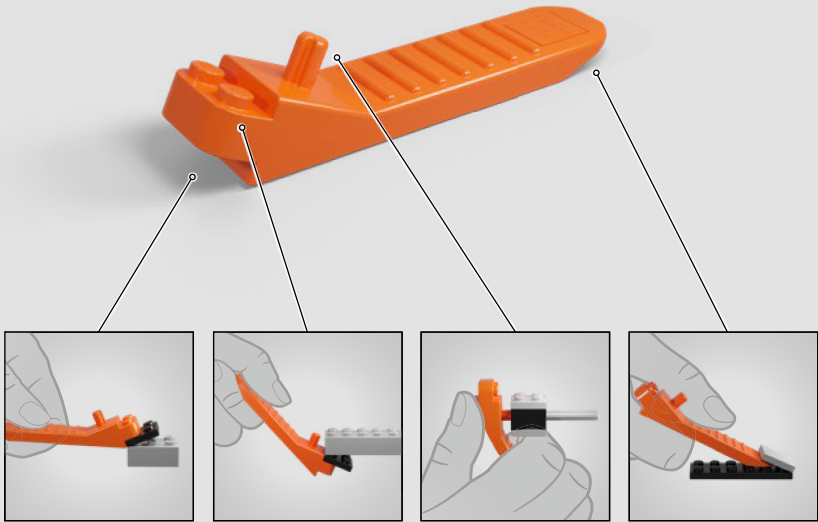
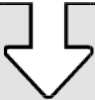
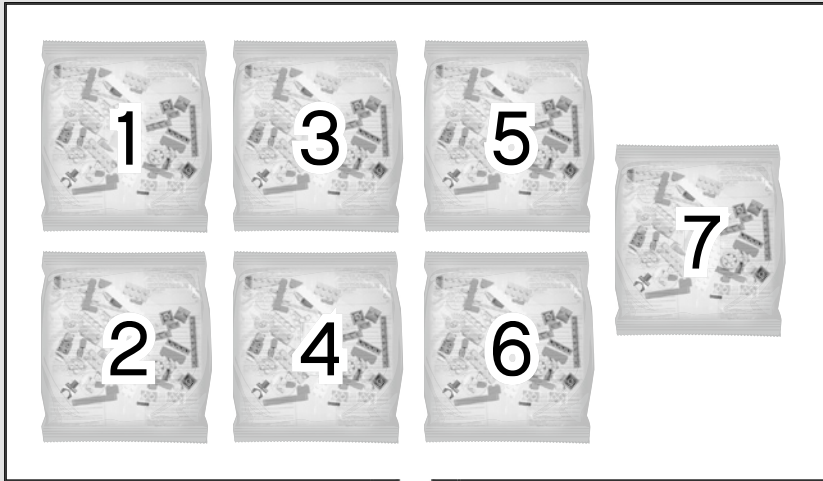

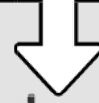
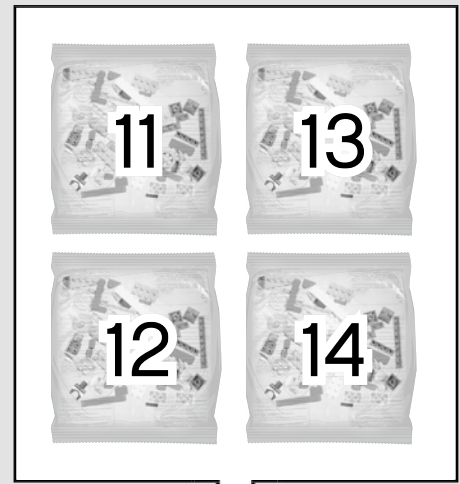
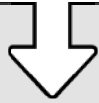

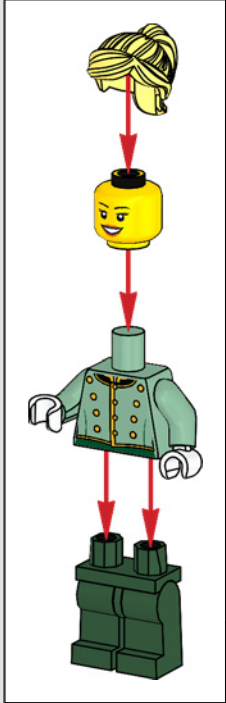
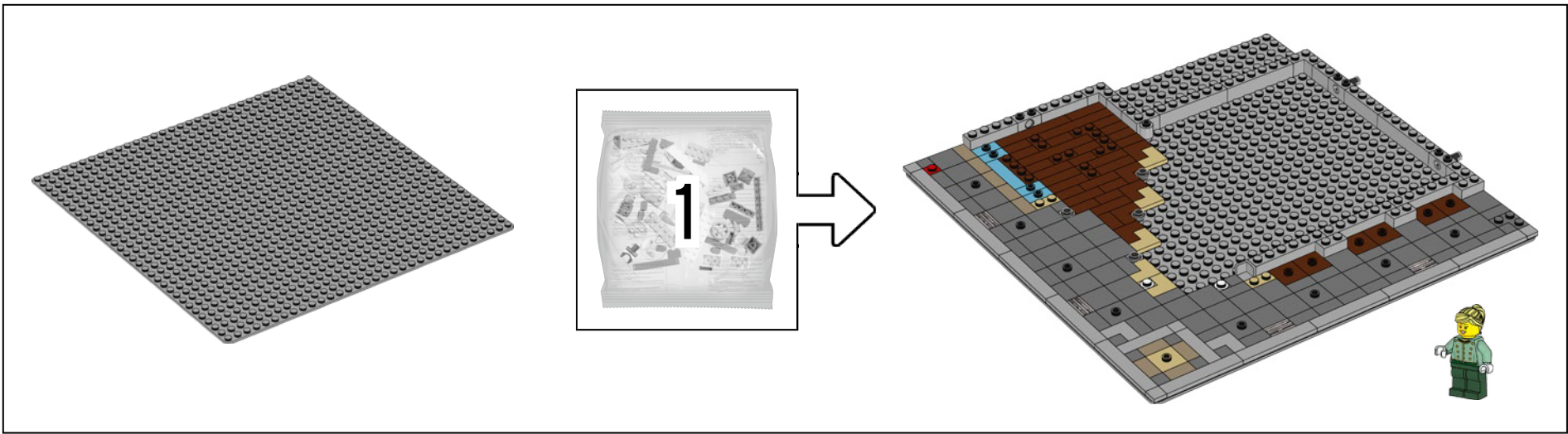

★ ★ ★ ★ ★  
Brauchst du einige Tipps für deinen Aufenthalt?  
Frag doch die Rezeptionistin nach ihrem  
Lieblingsladen im „Großen Kaufhaus“ (10211)  
oder dem besten Gericht im Chez Albert.



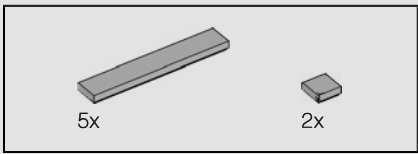

1

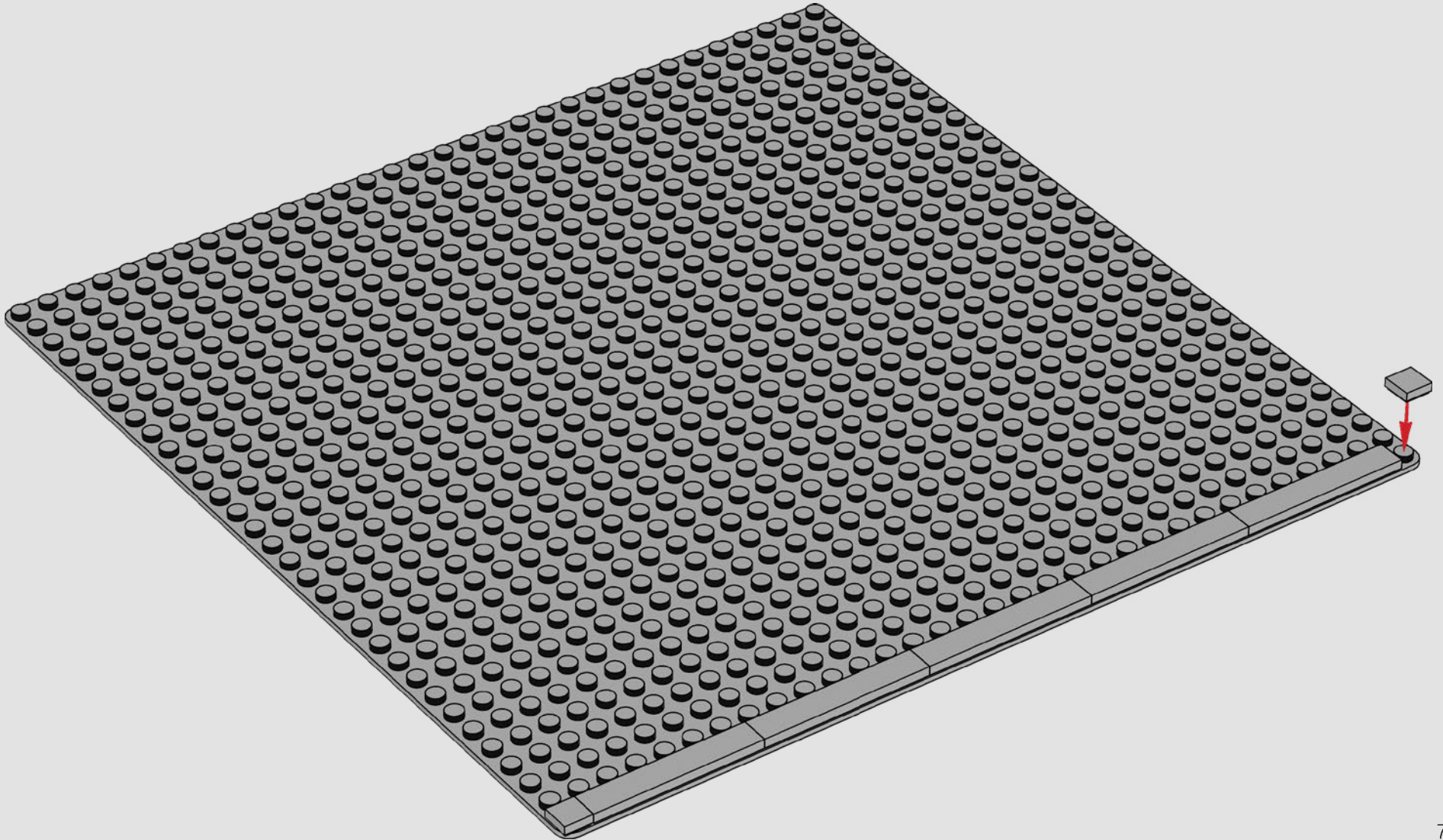

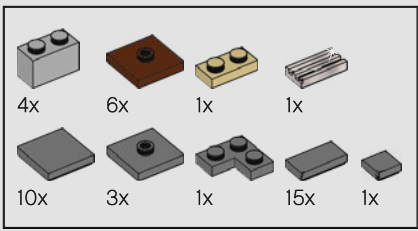

2

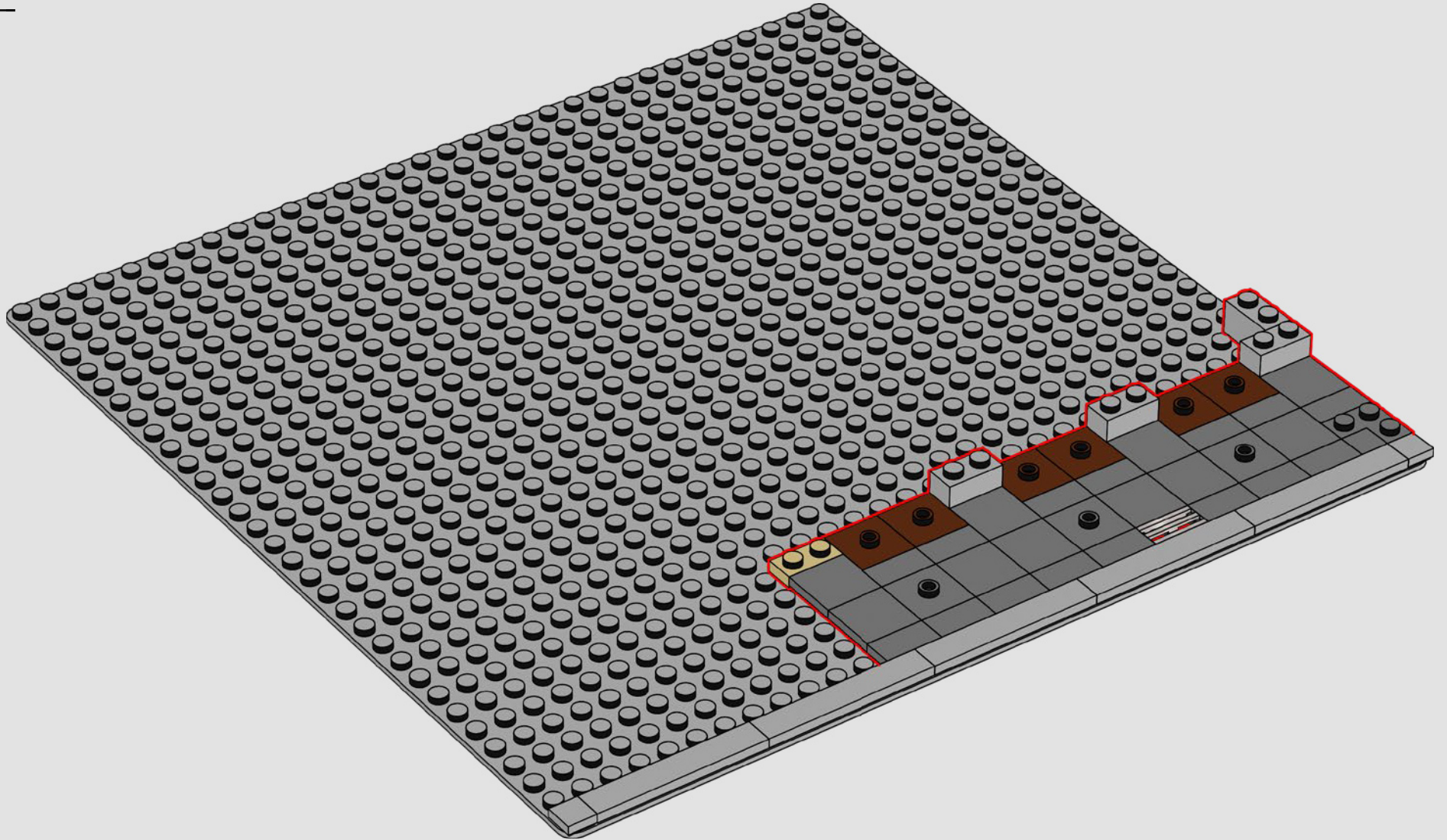



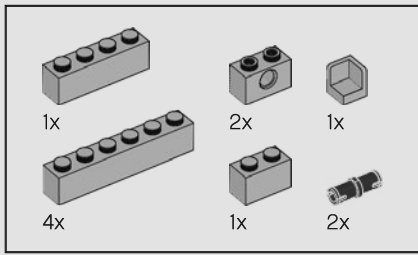

3

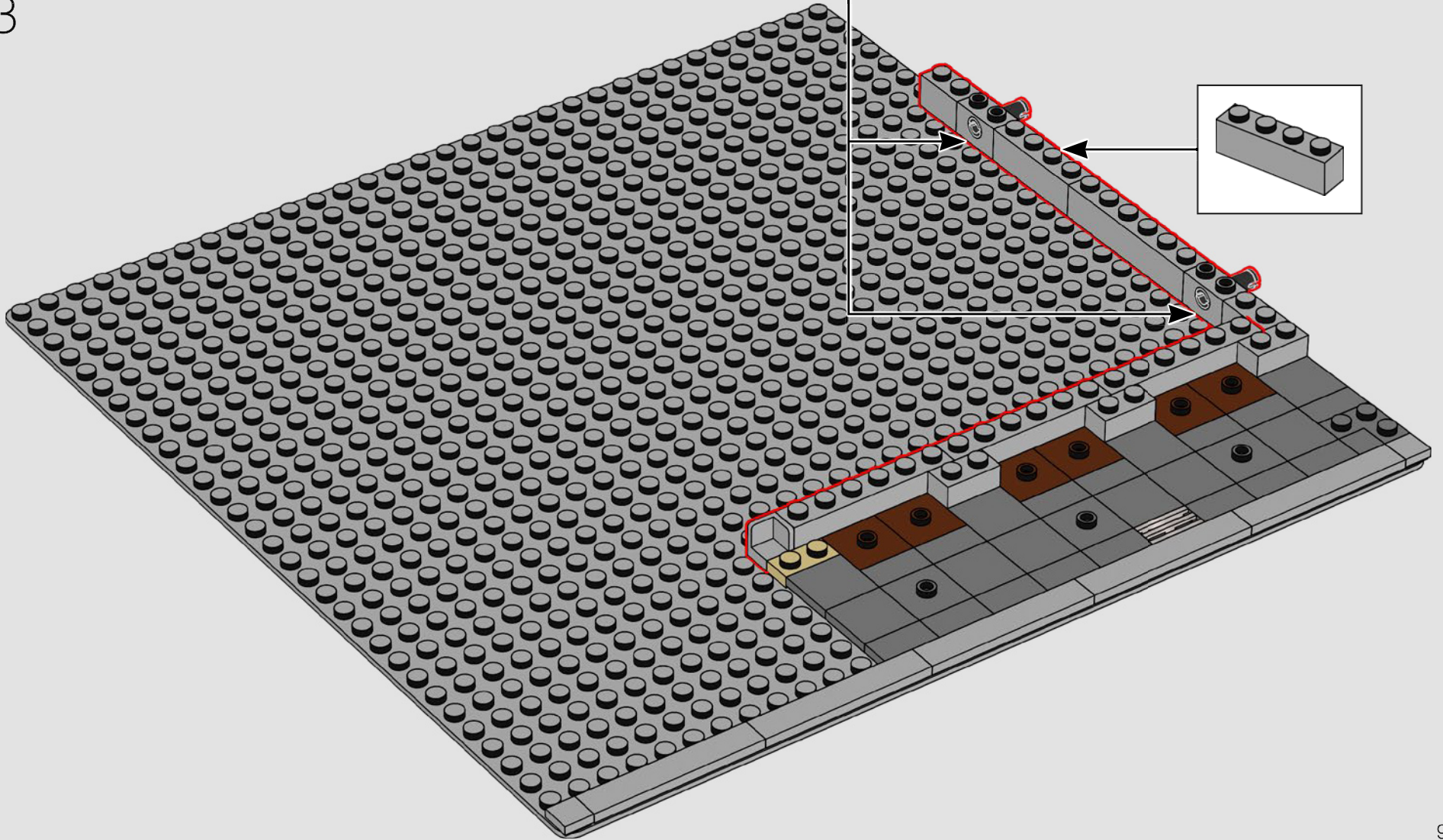
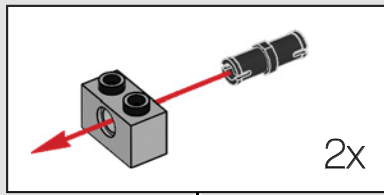

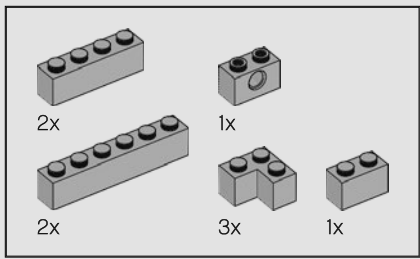

4

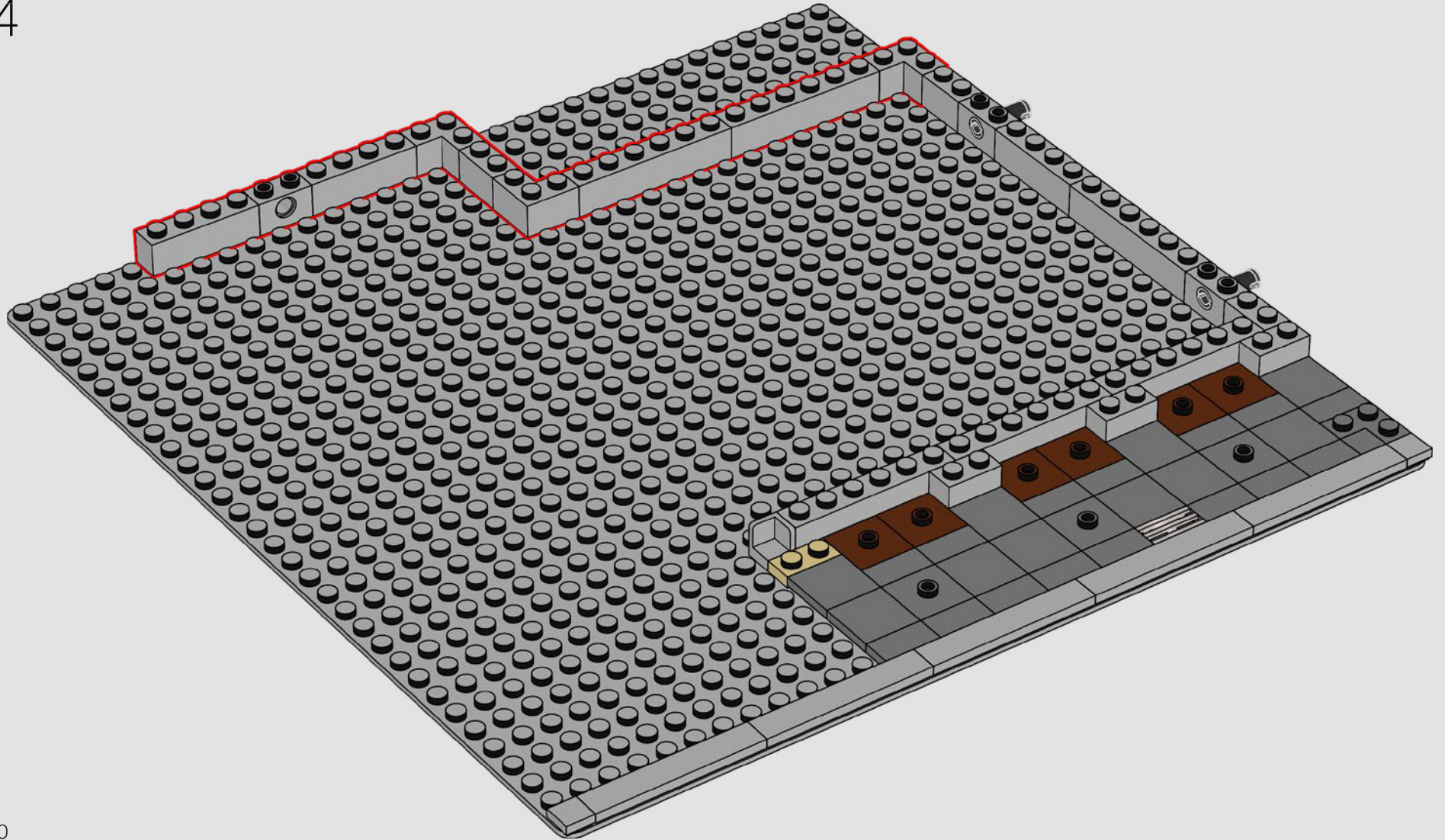

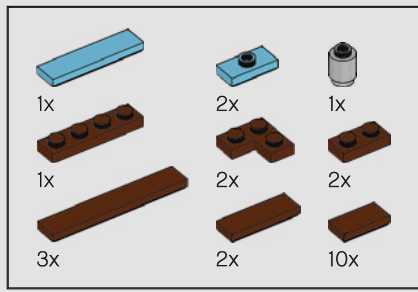

5

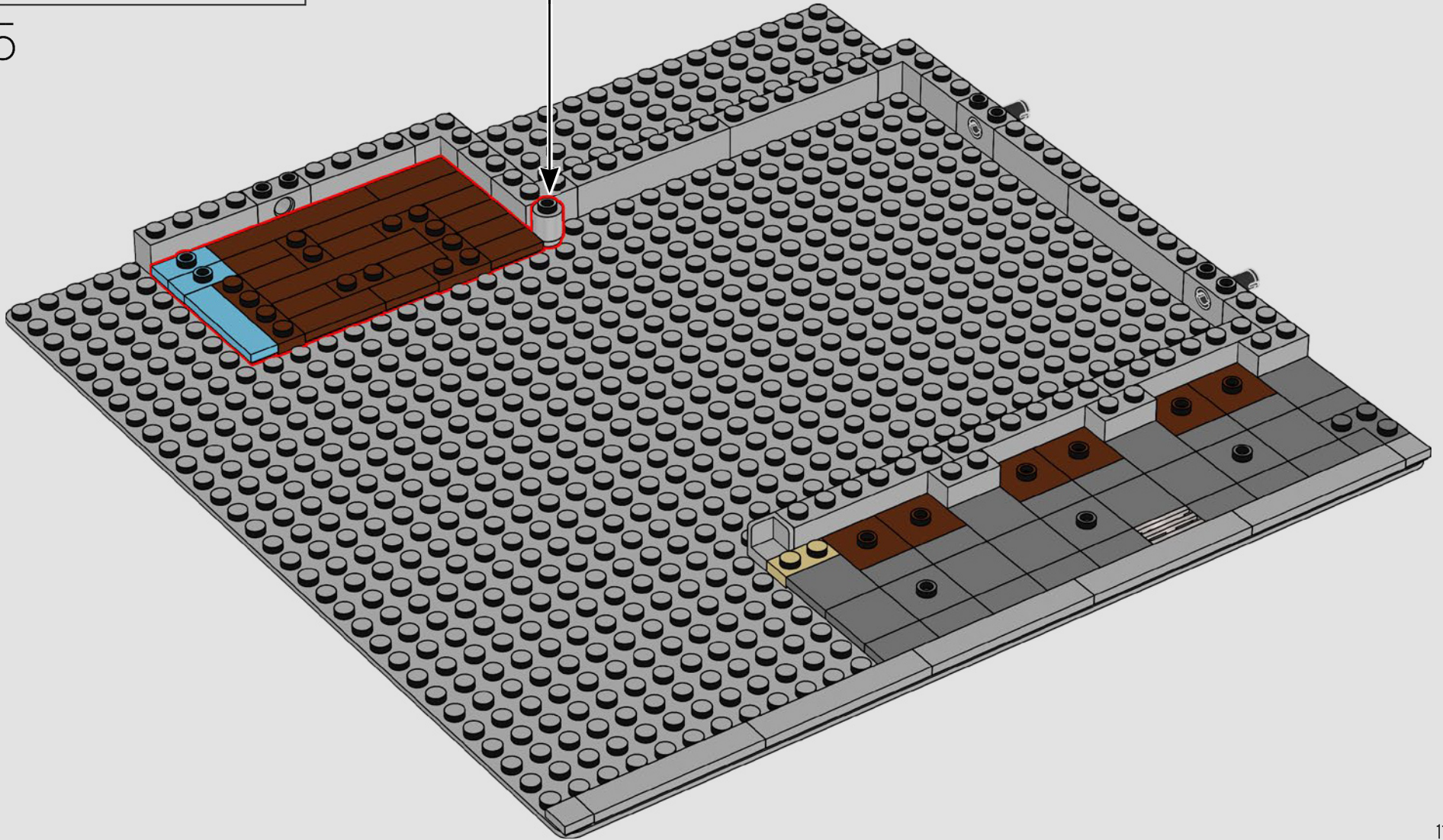
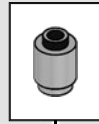

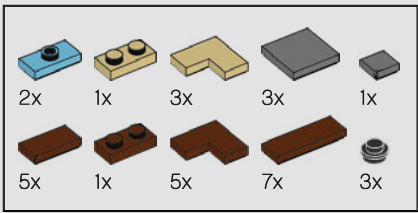

6

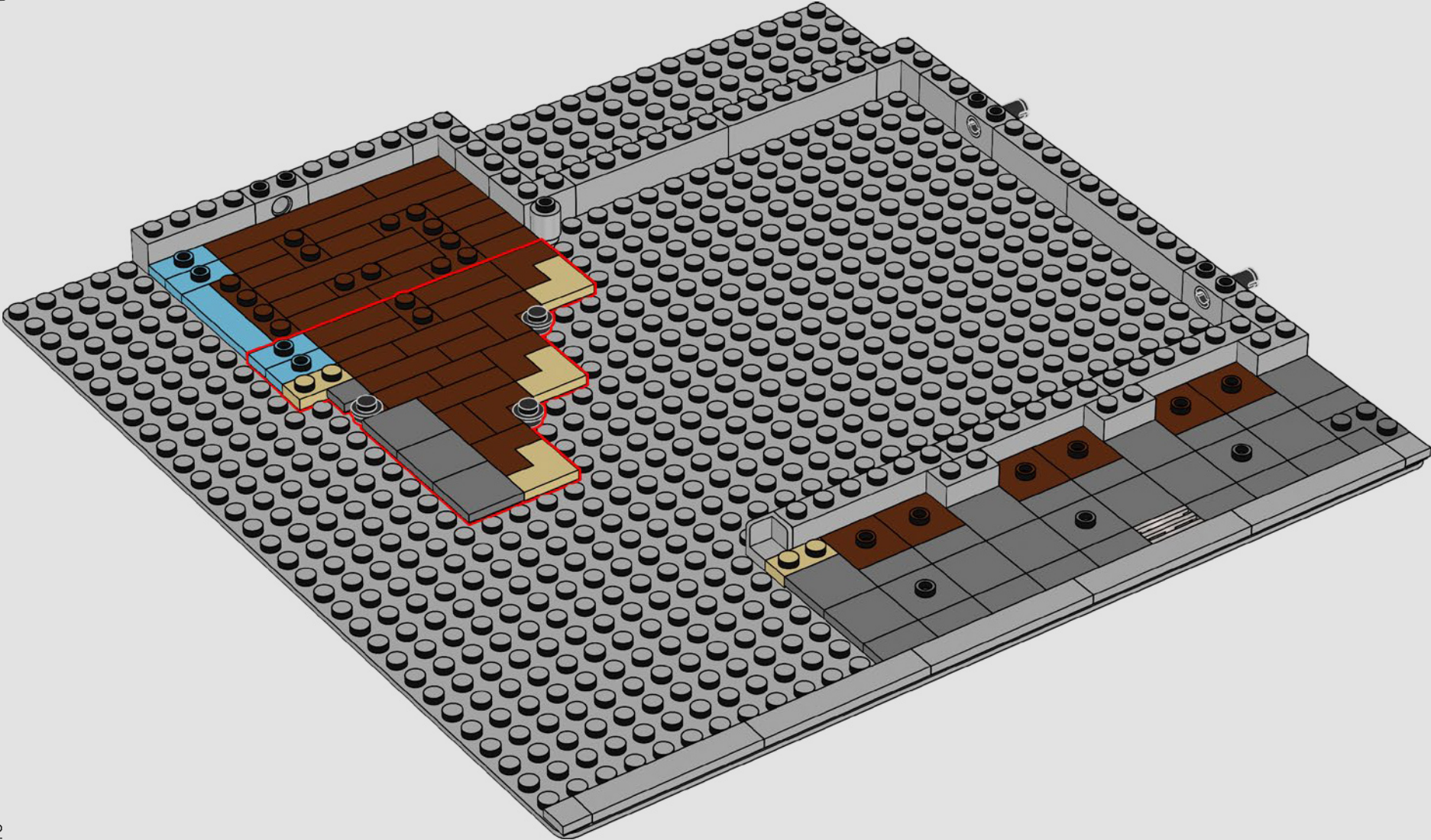

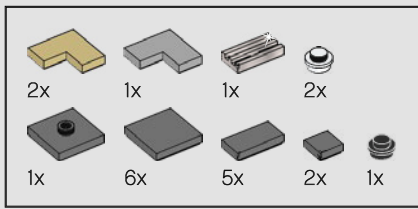

7

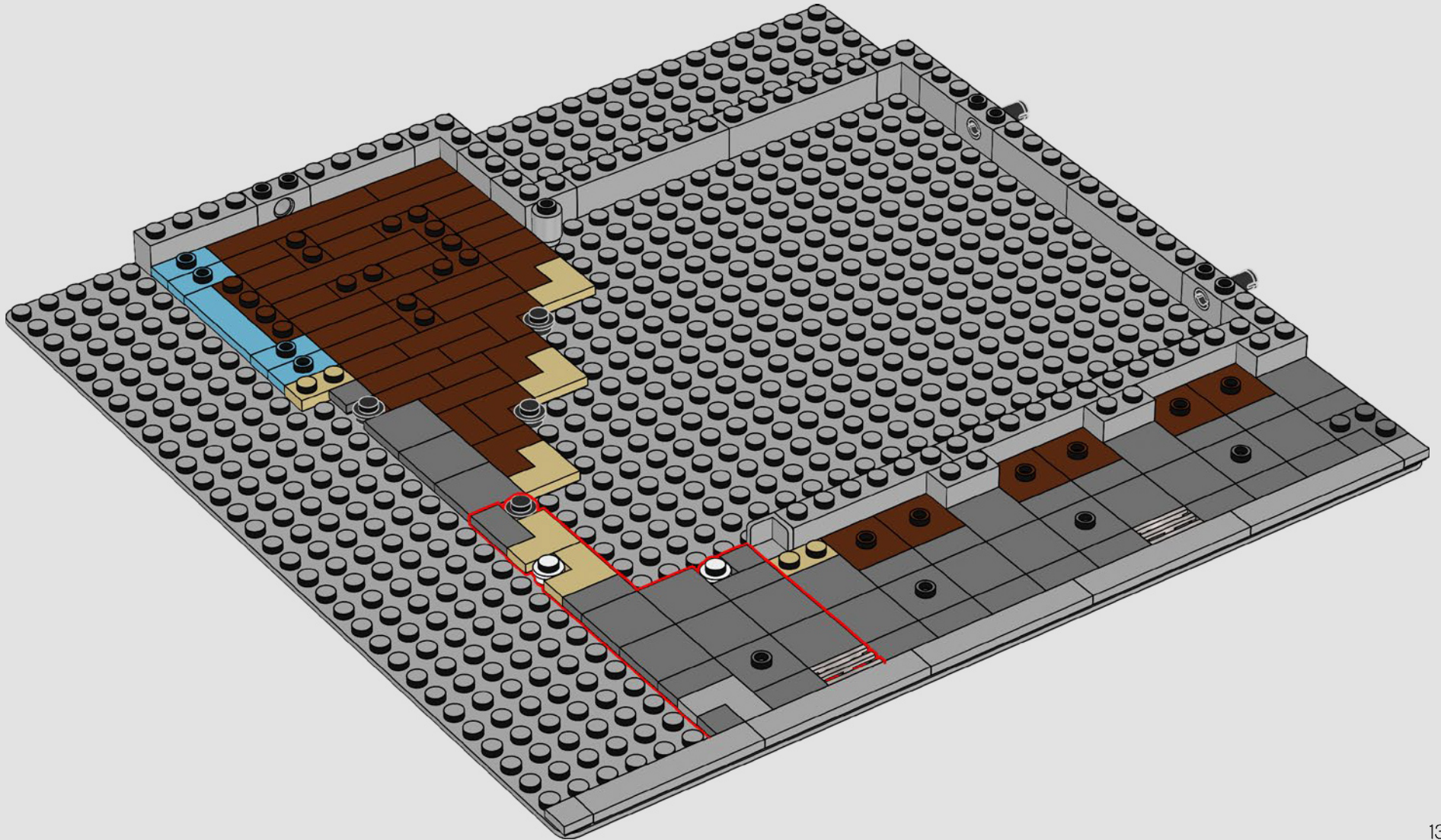

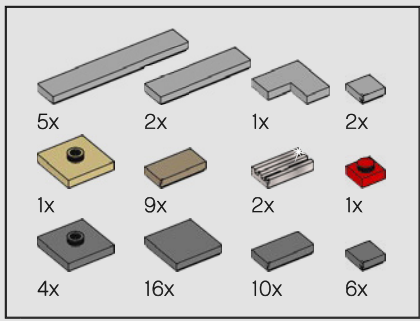

8

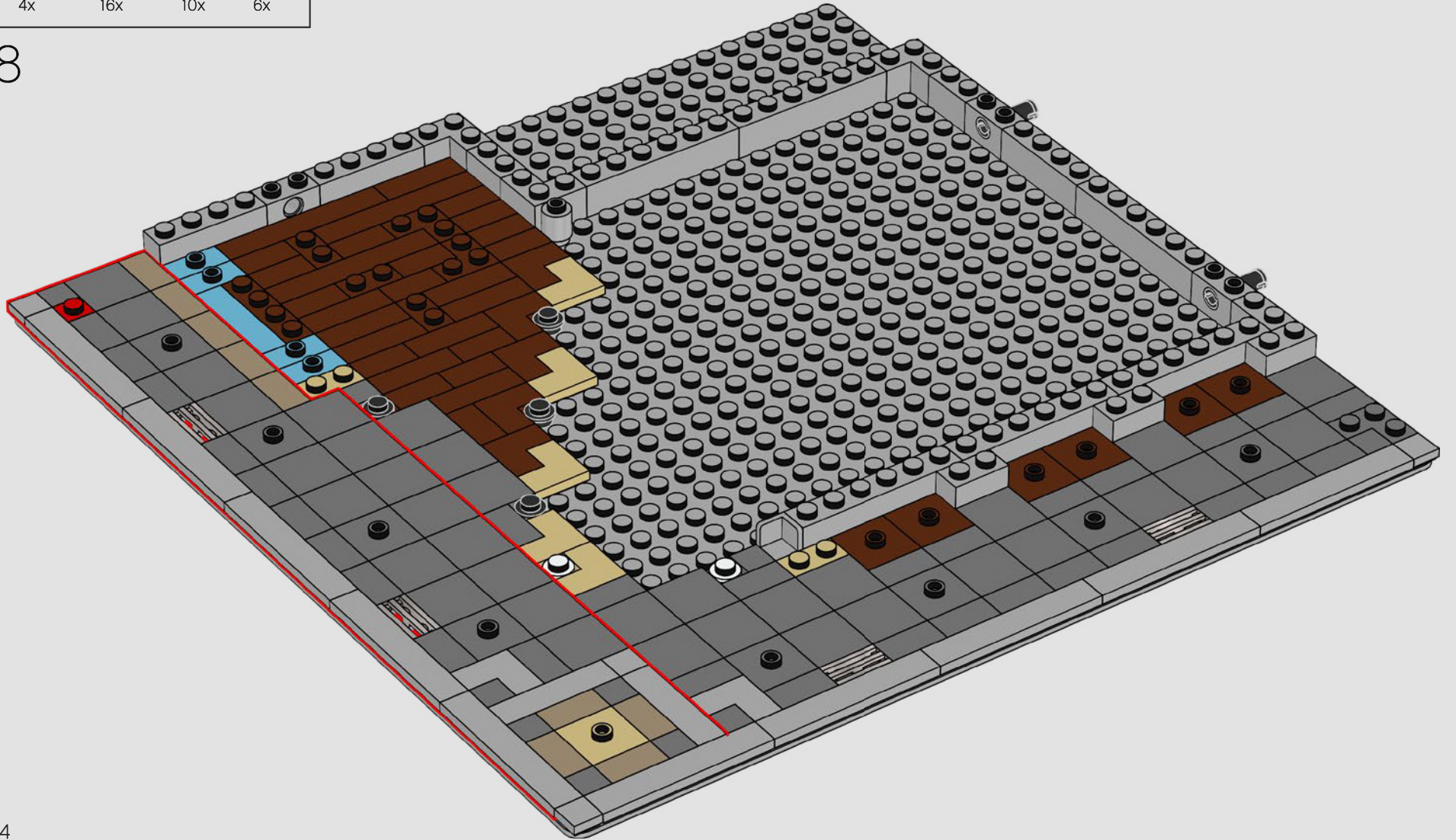

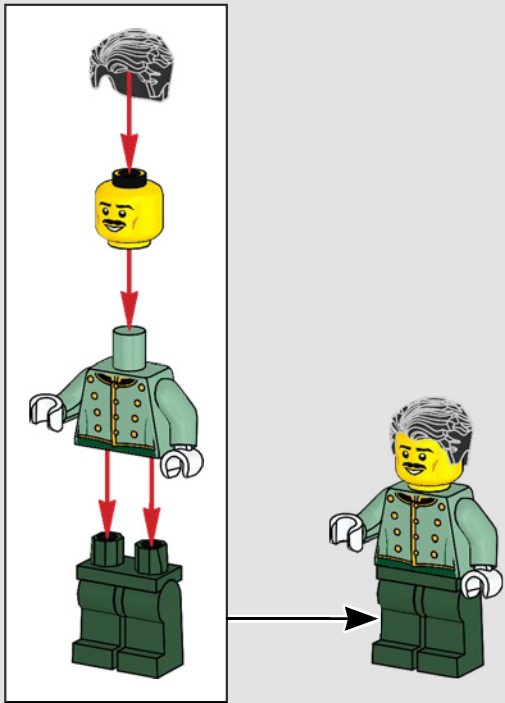
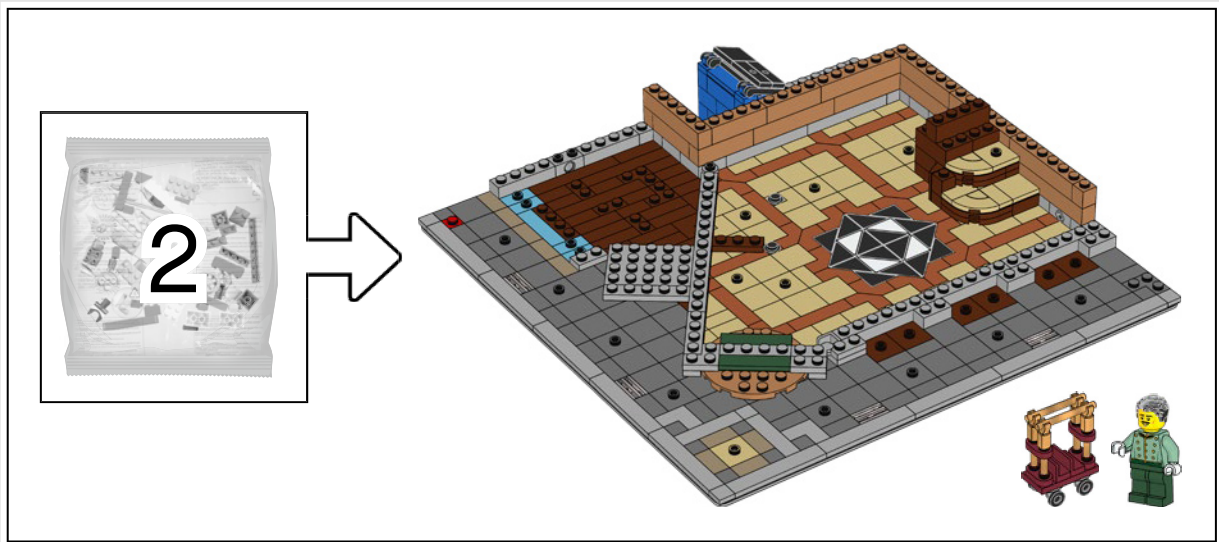

Der Page wird dein Gepäck dann  
gerne in dein Zimmer hinaufbringen.  
Vergiss bloß nicht das Trinkgeld!

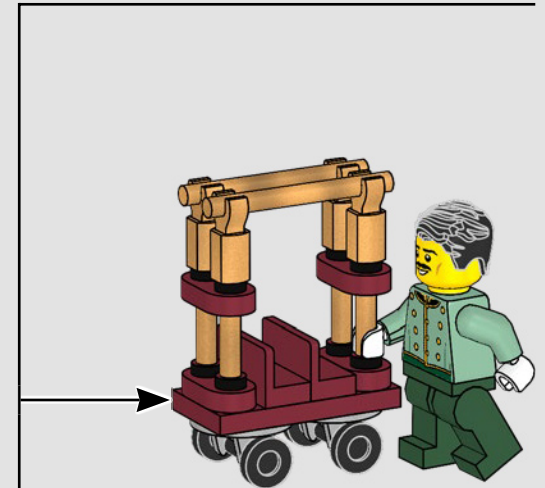
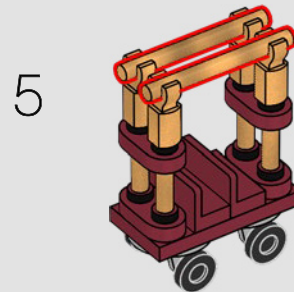
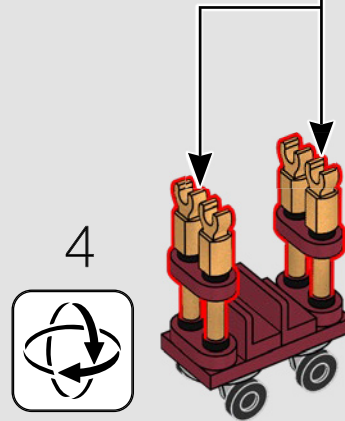
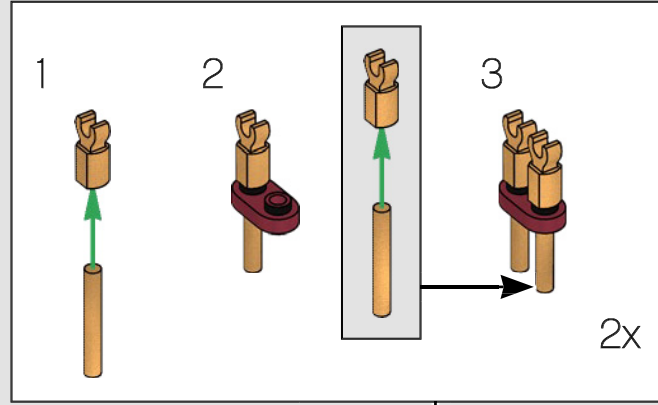
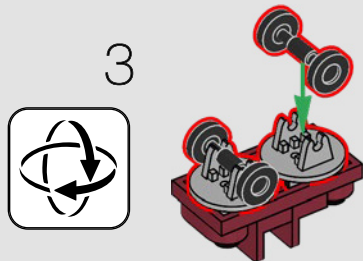
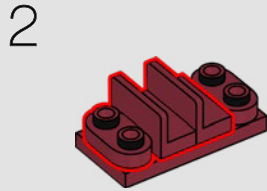
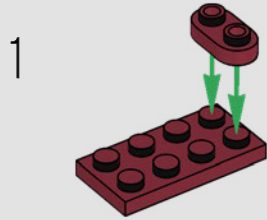
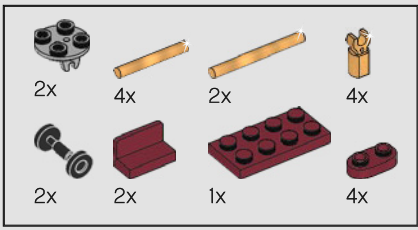



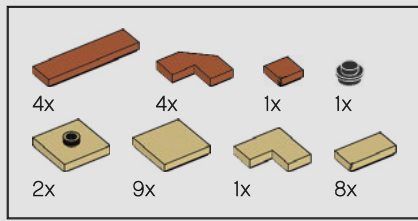

9

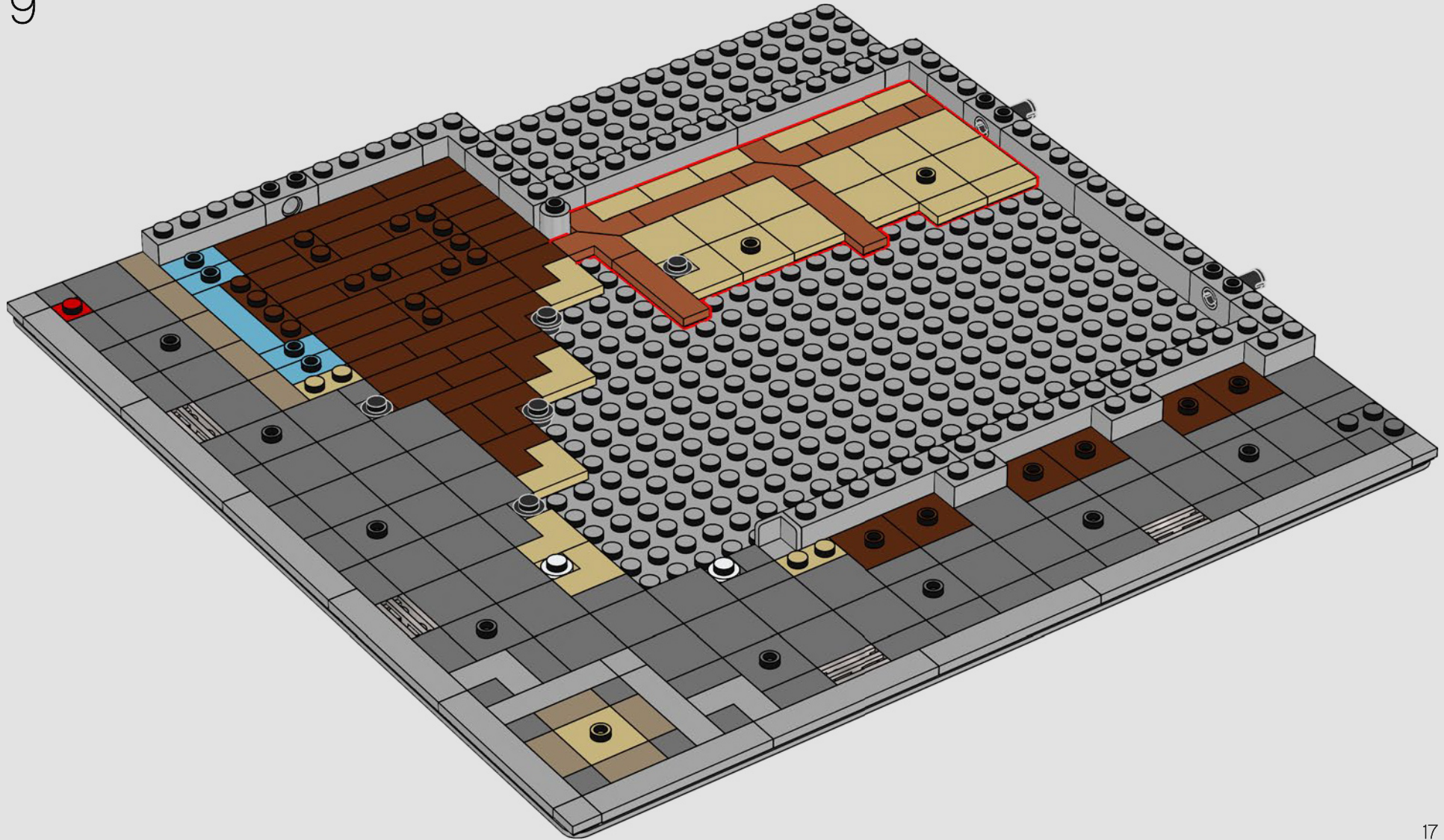

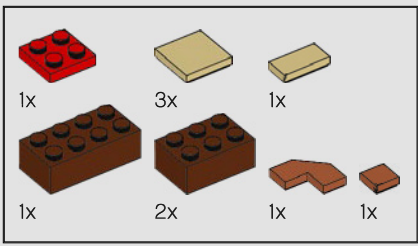

10

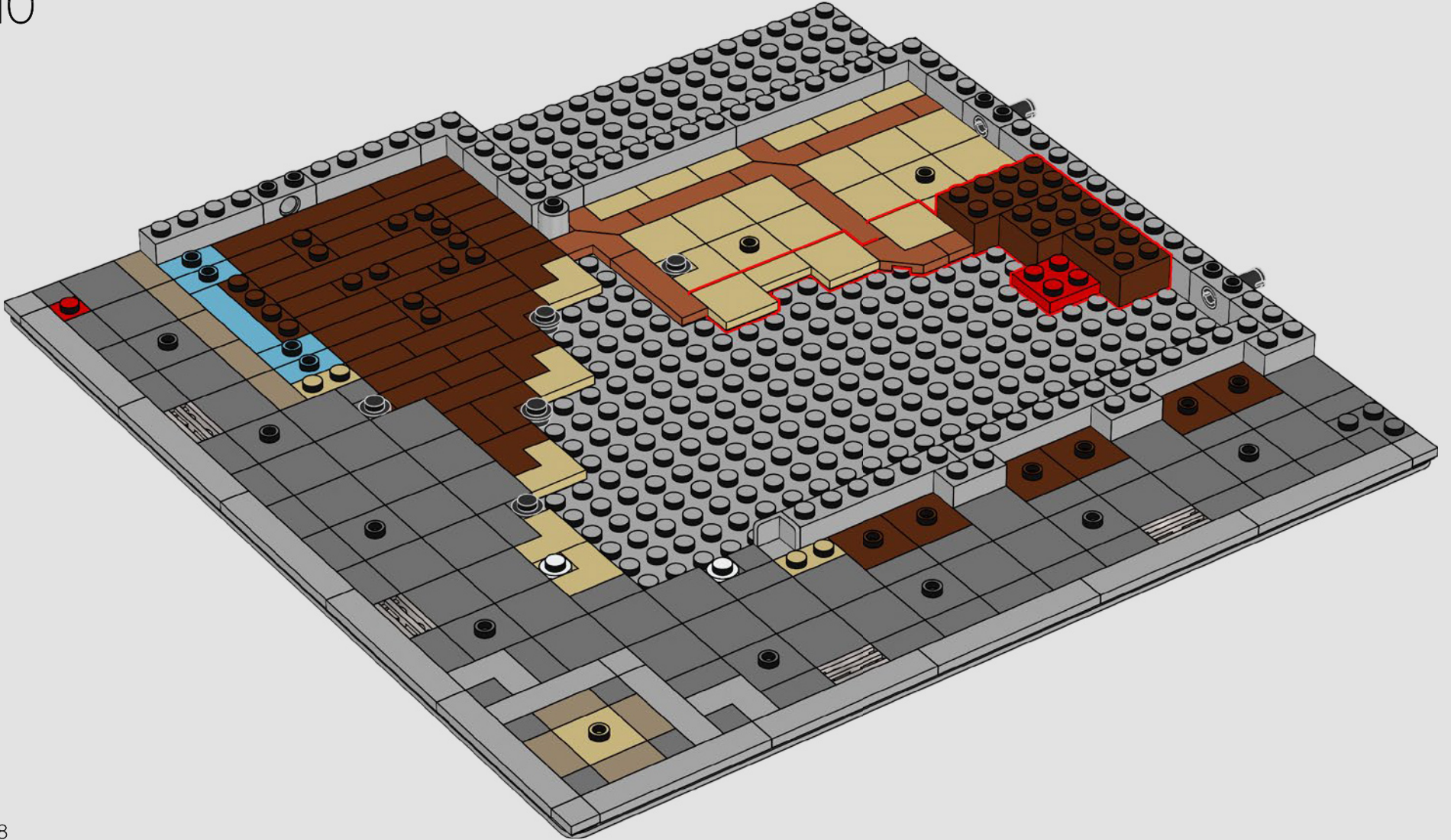

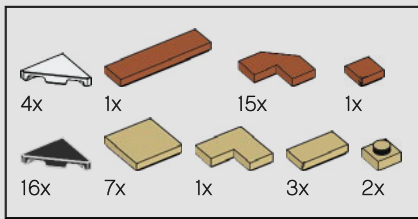

11

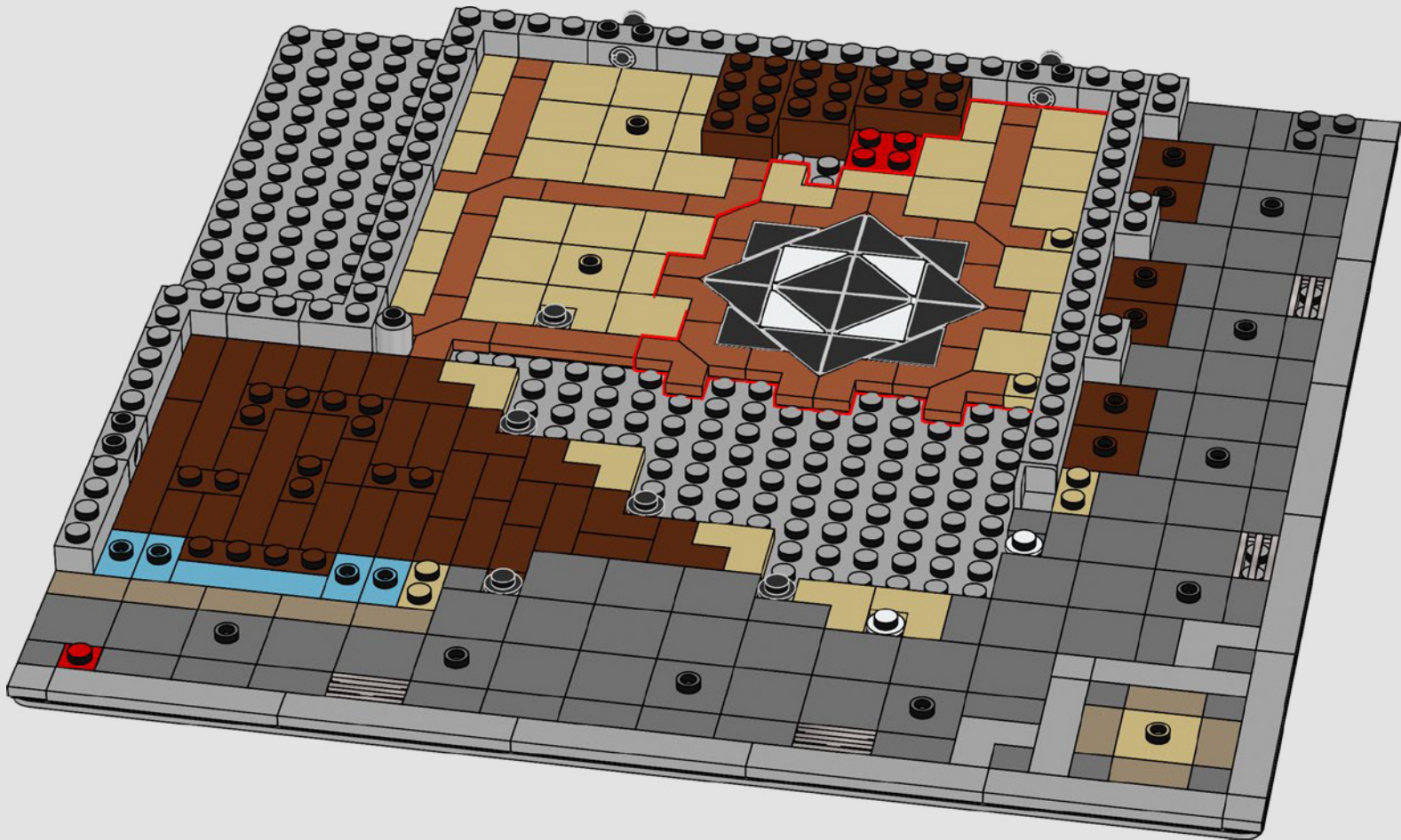

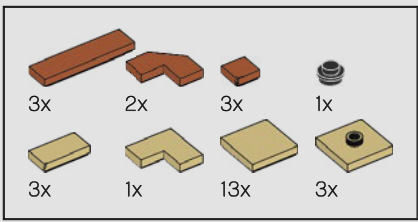

12

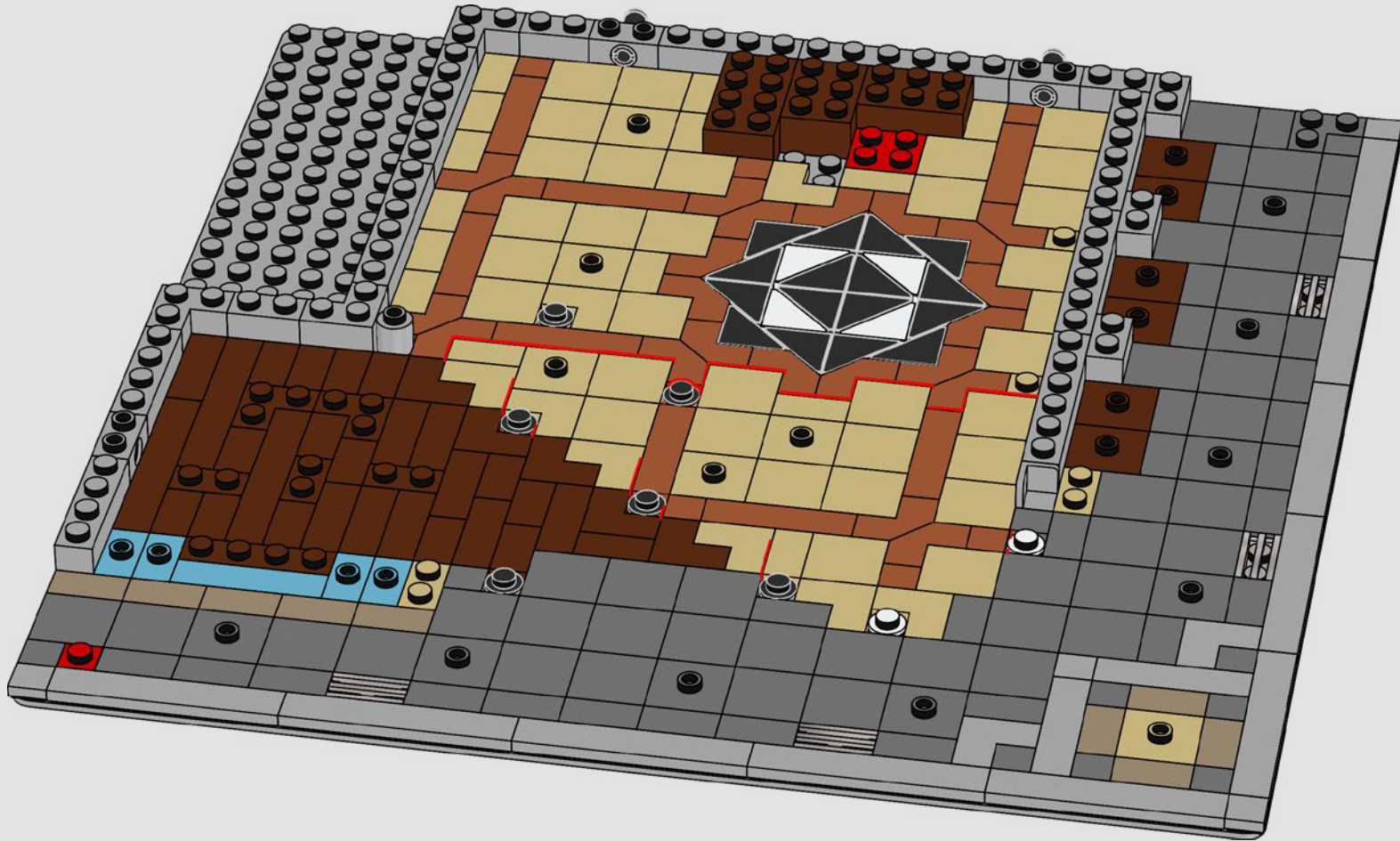

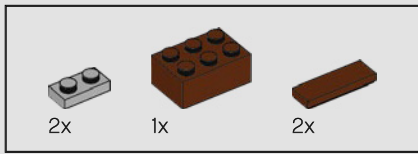

13

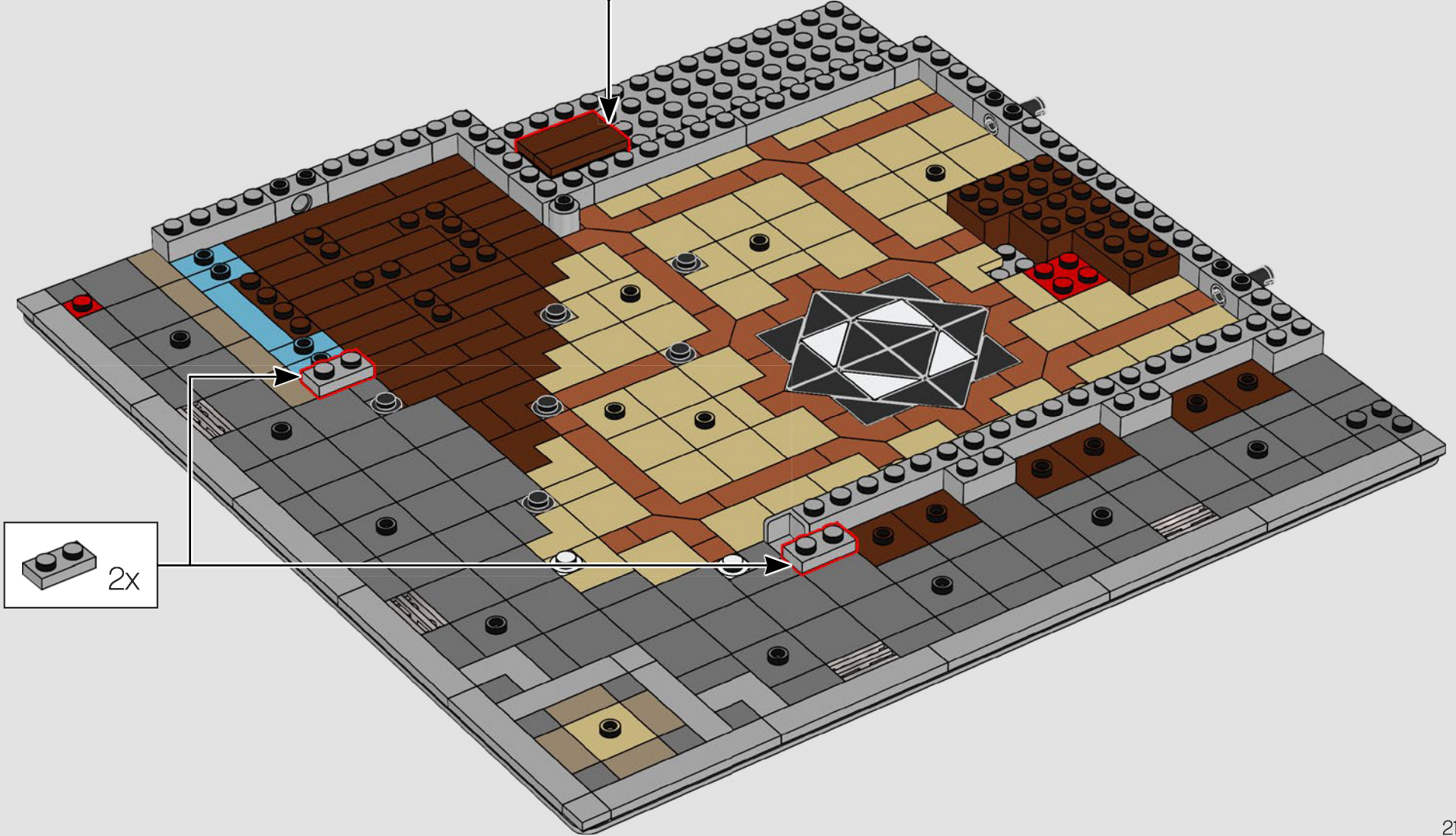
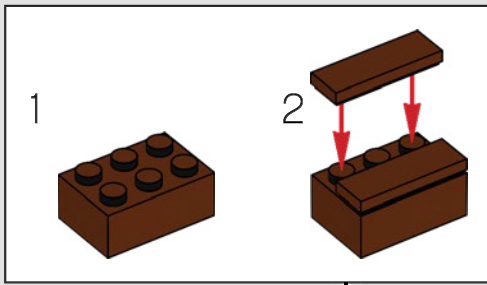

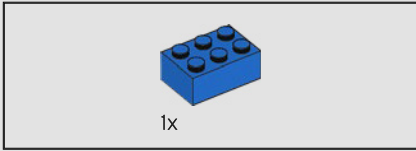
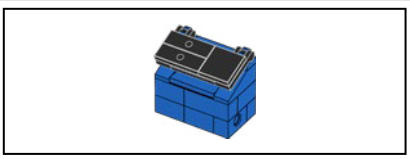

14

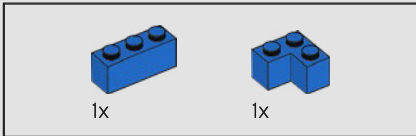
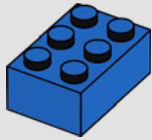

15

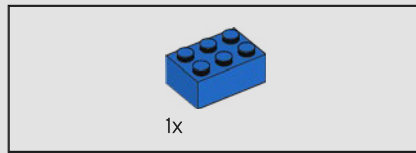
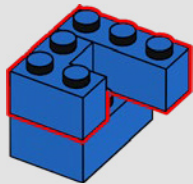

16

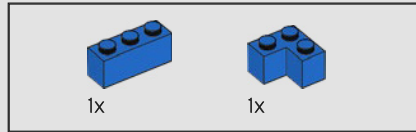
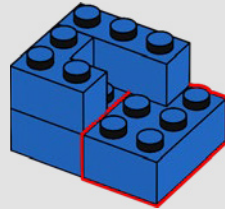

17

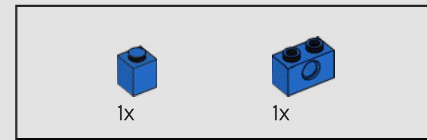
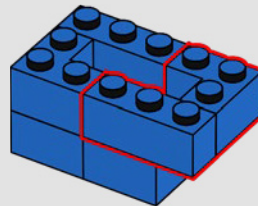

18

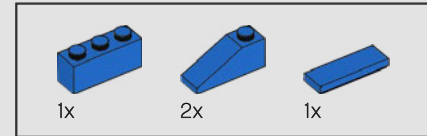
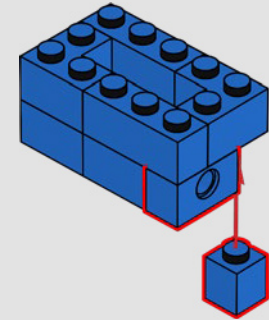

19

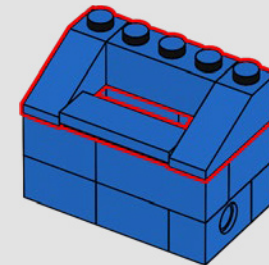

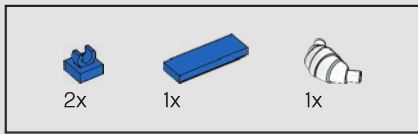

20

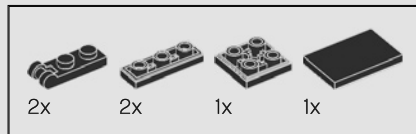
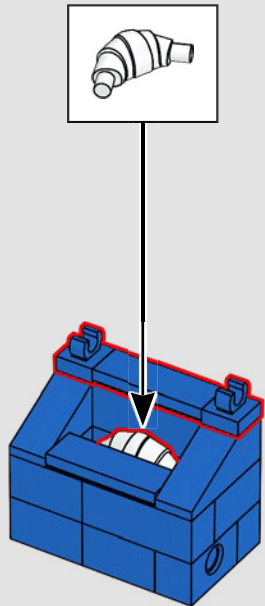

21

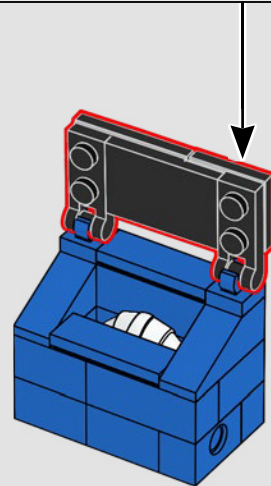
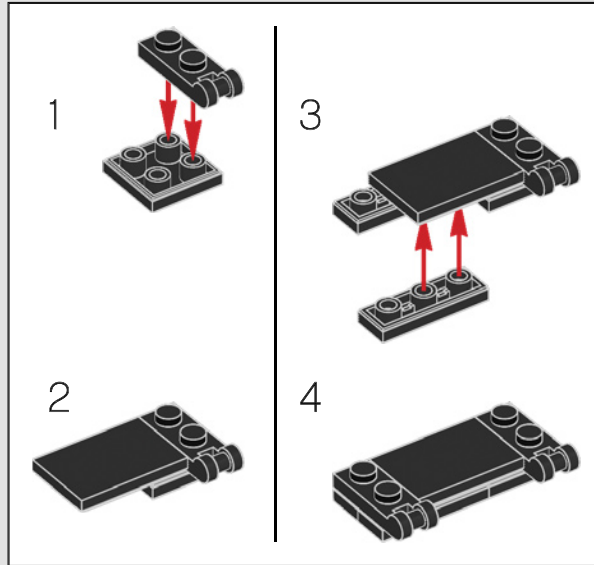

22

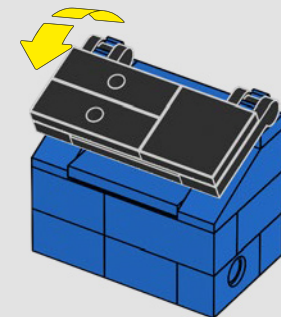

Dieses Croissant stammt aus dem „Pariser Restaurant“ (10243) ... aber wer mag schon ein verschimmeltes weißes Croissant?

23

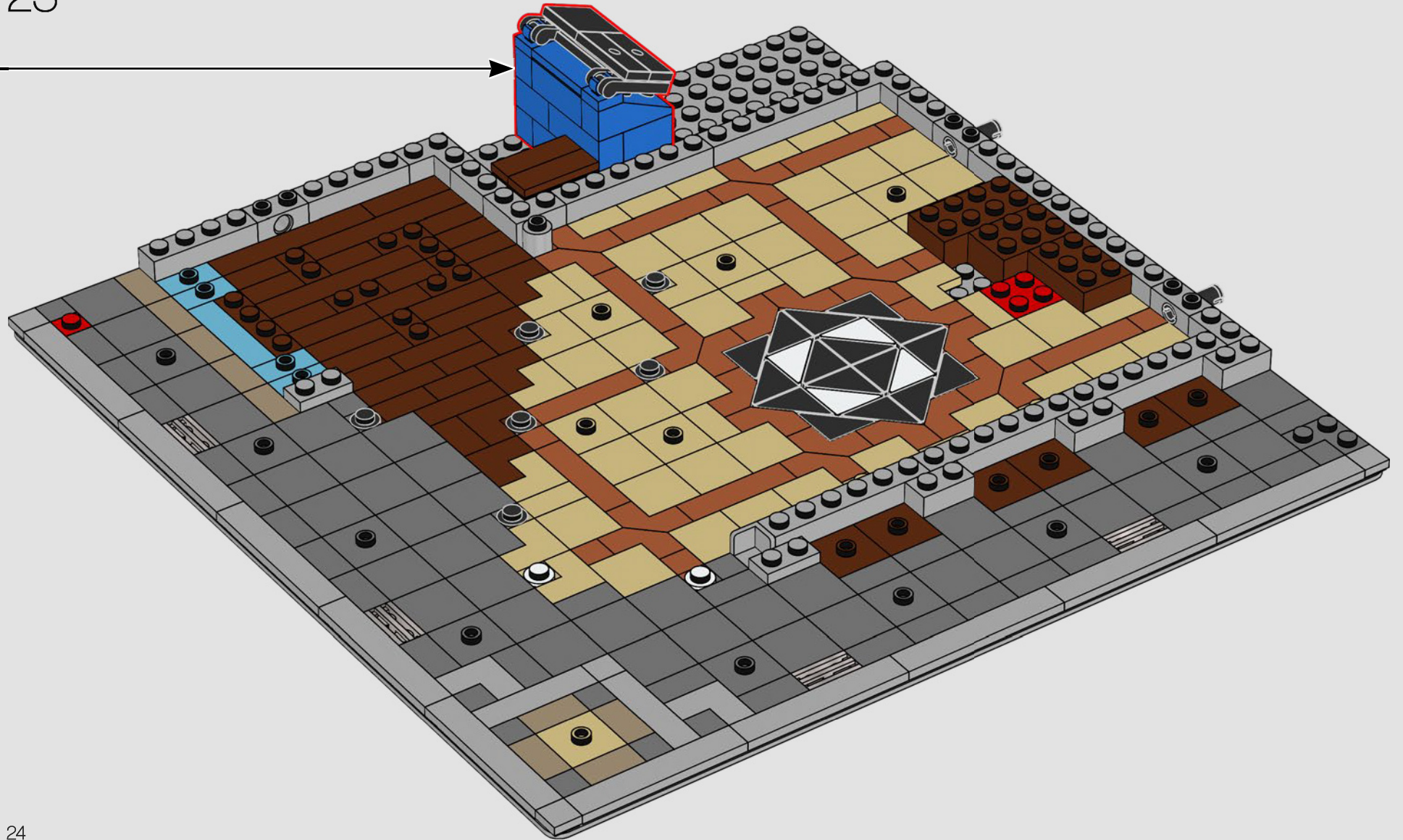

24



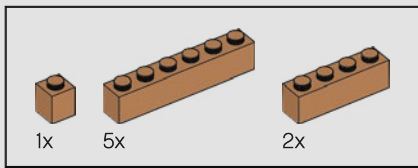

24

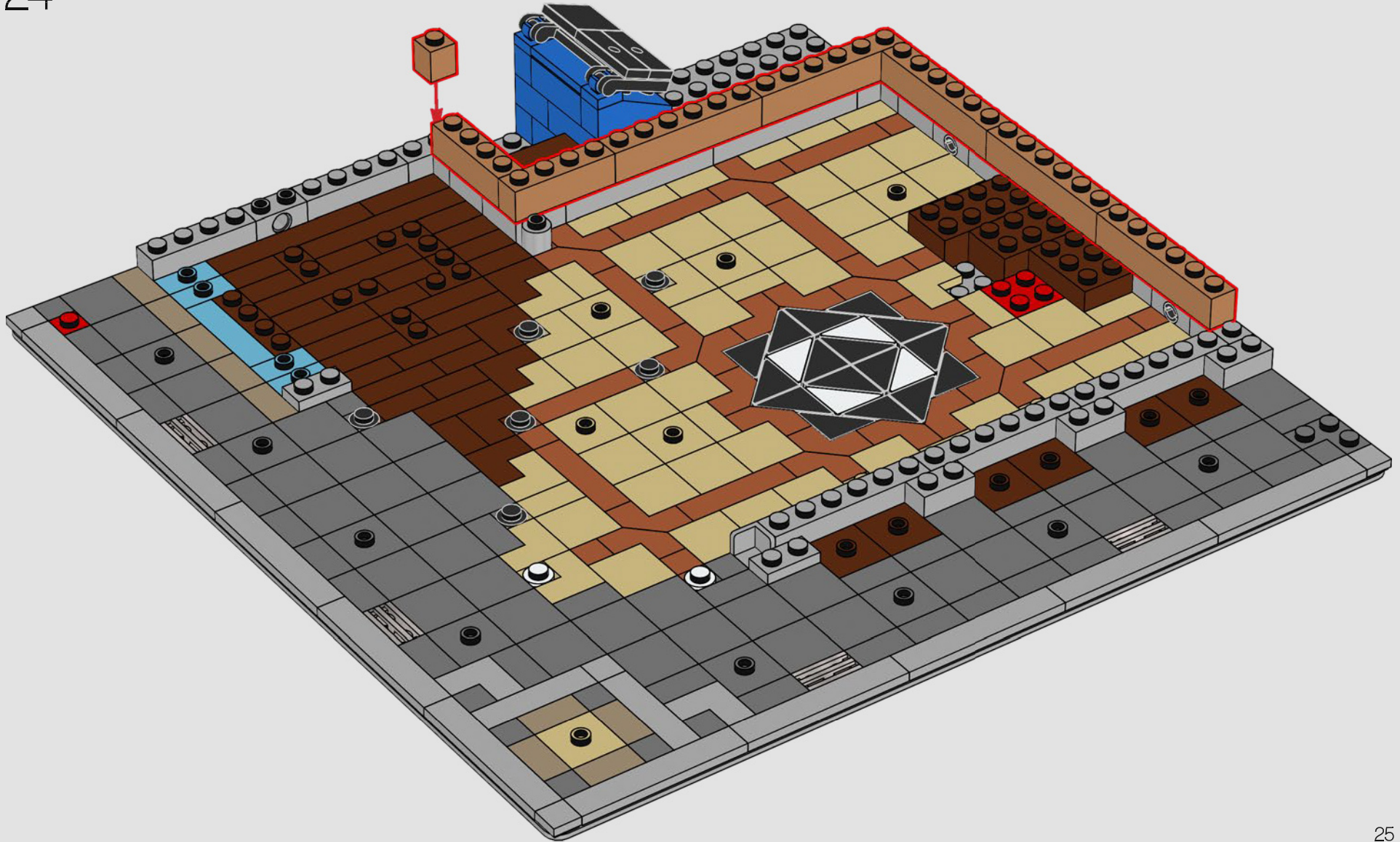

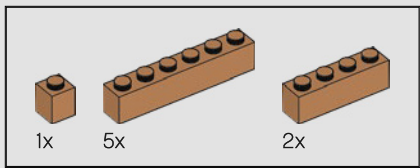

25

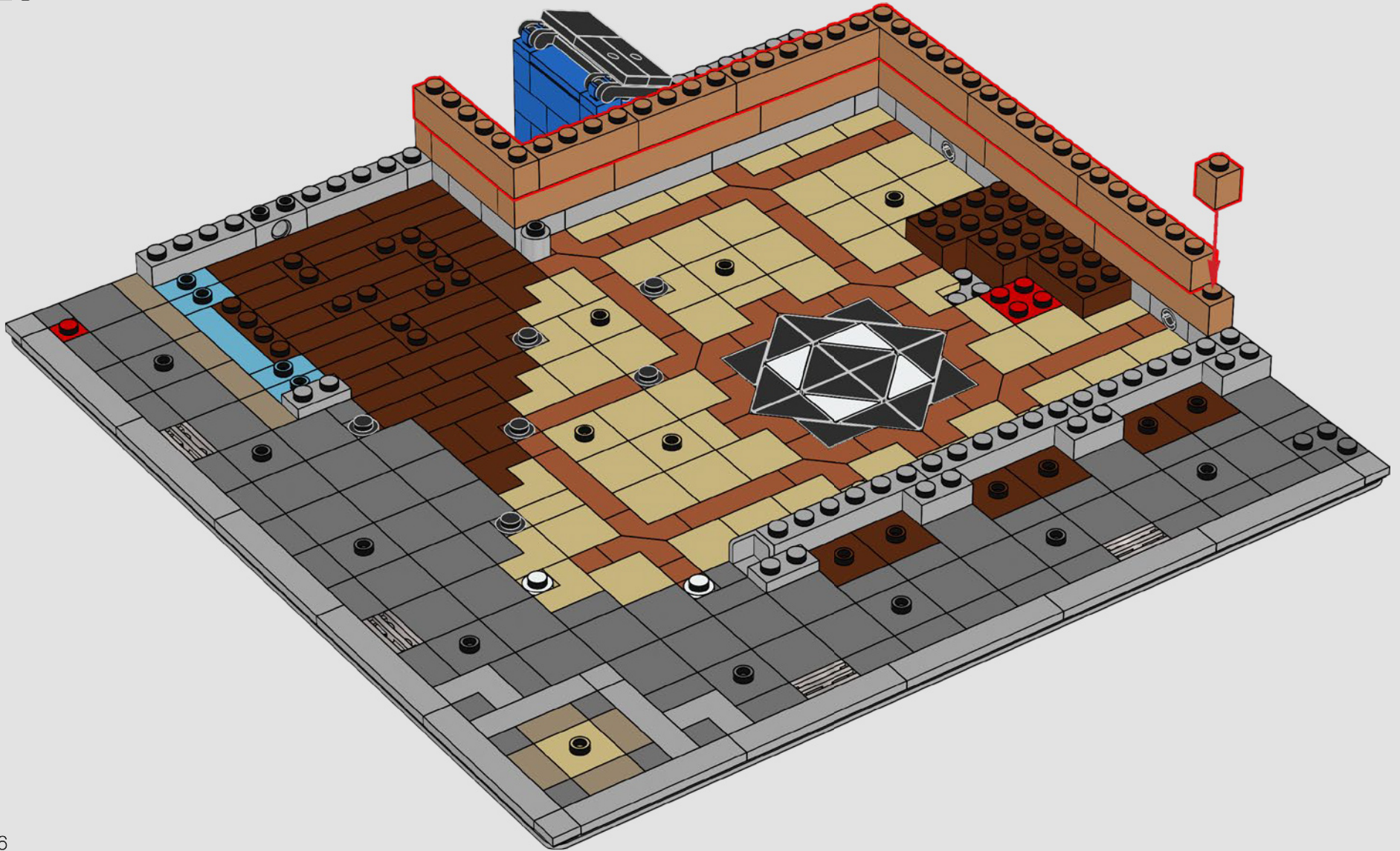

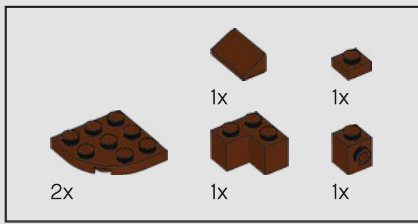

26

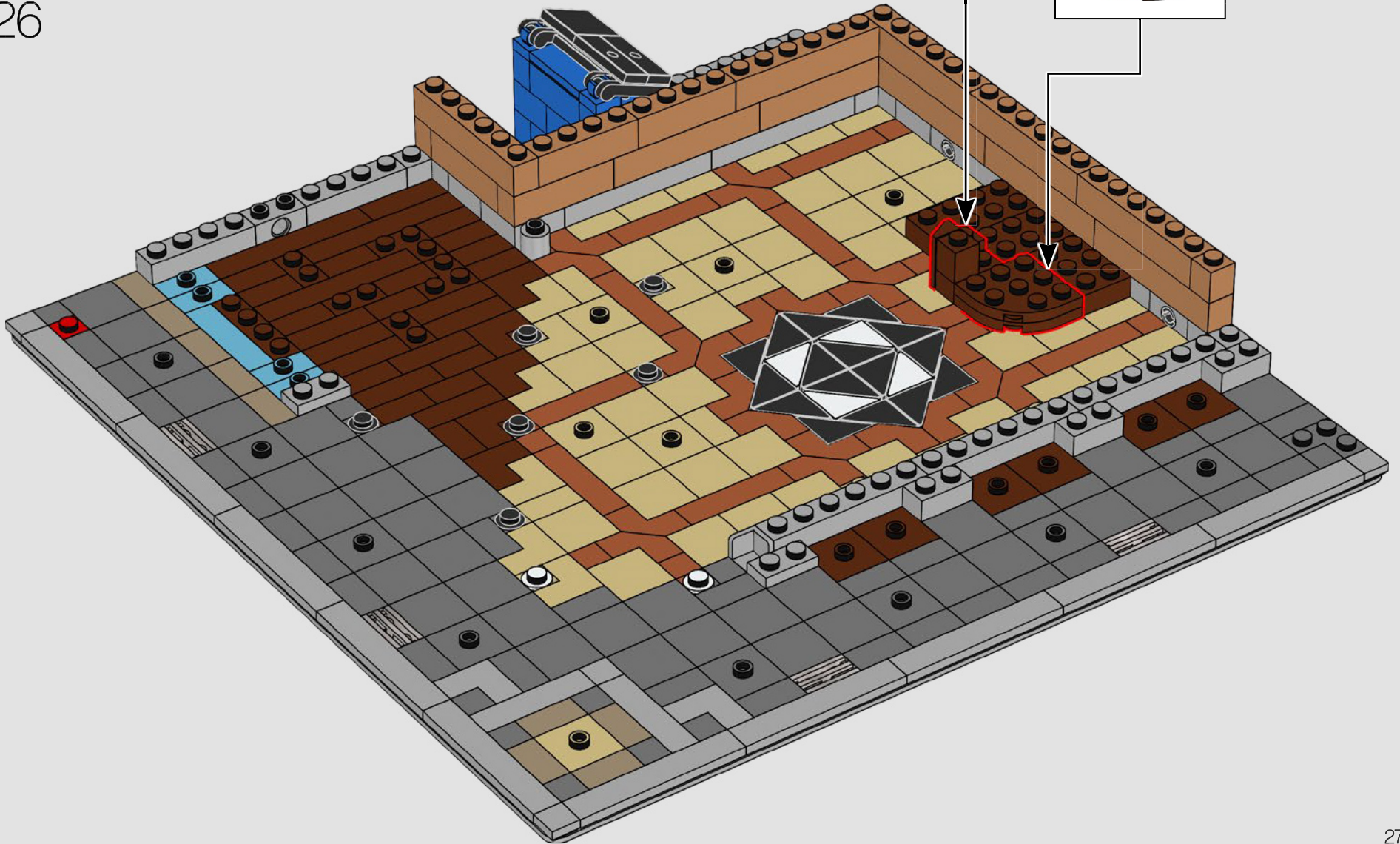
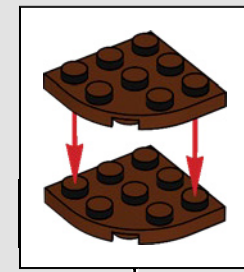
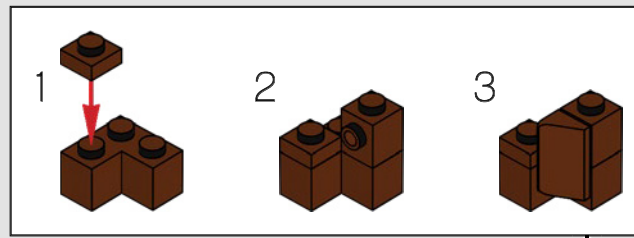

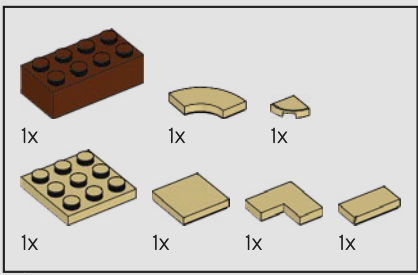

27

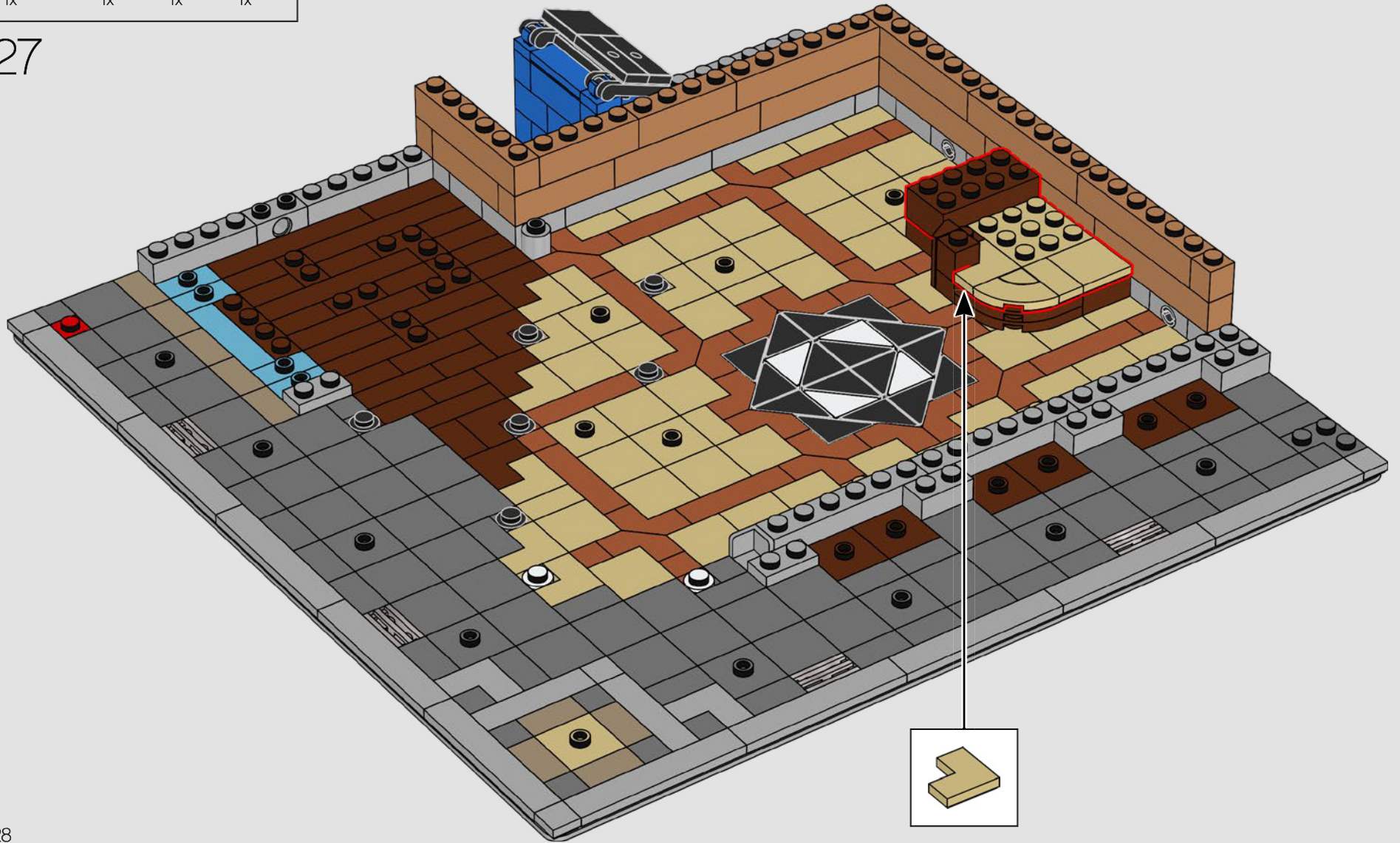

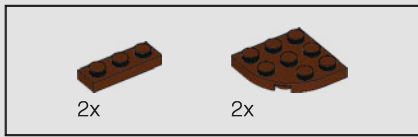

28

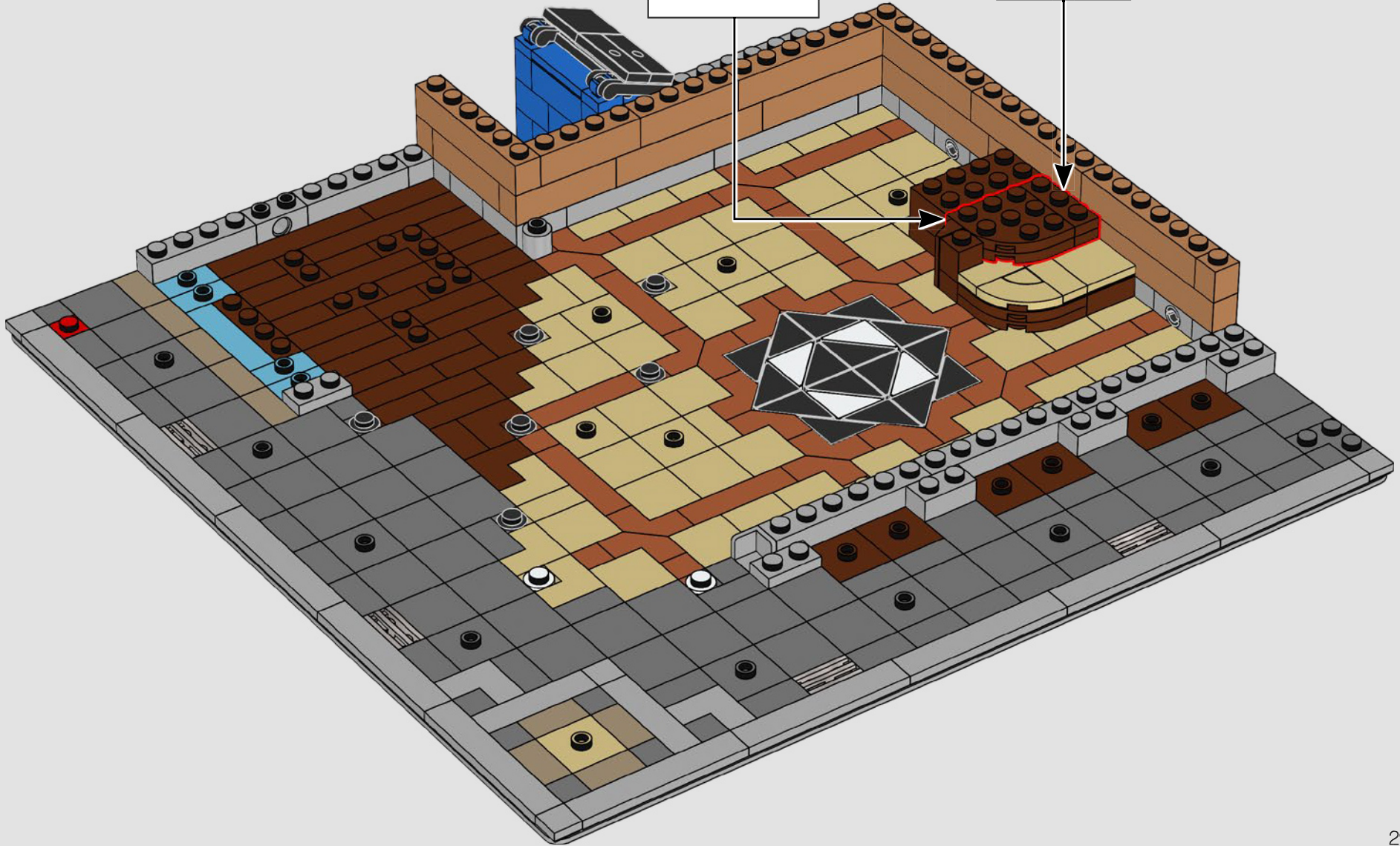
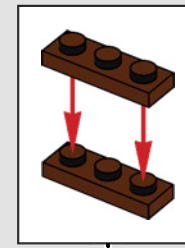
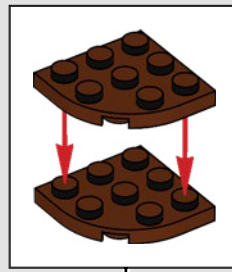

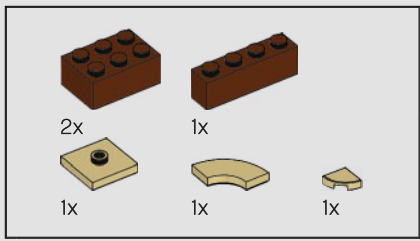

29

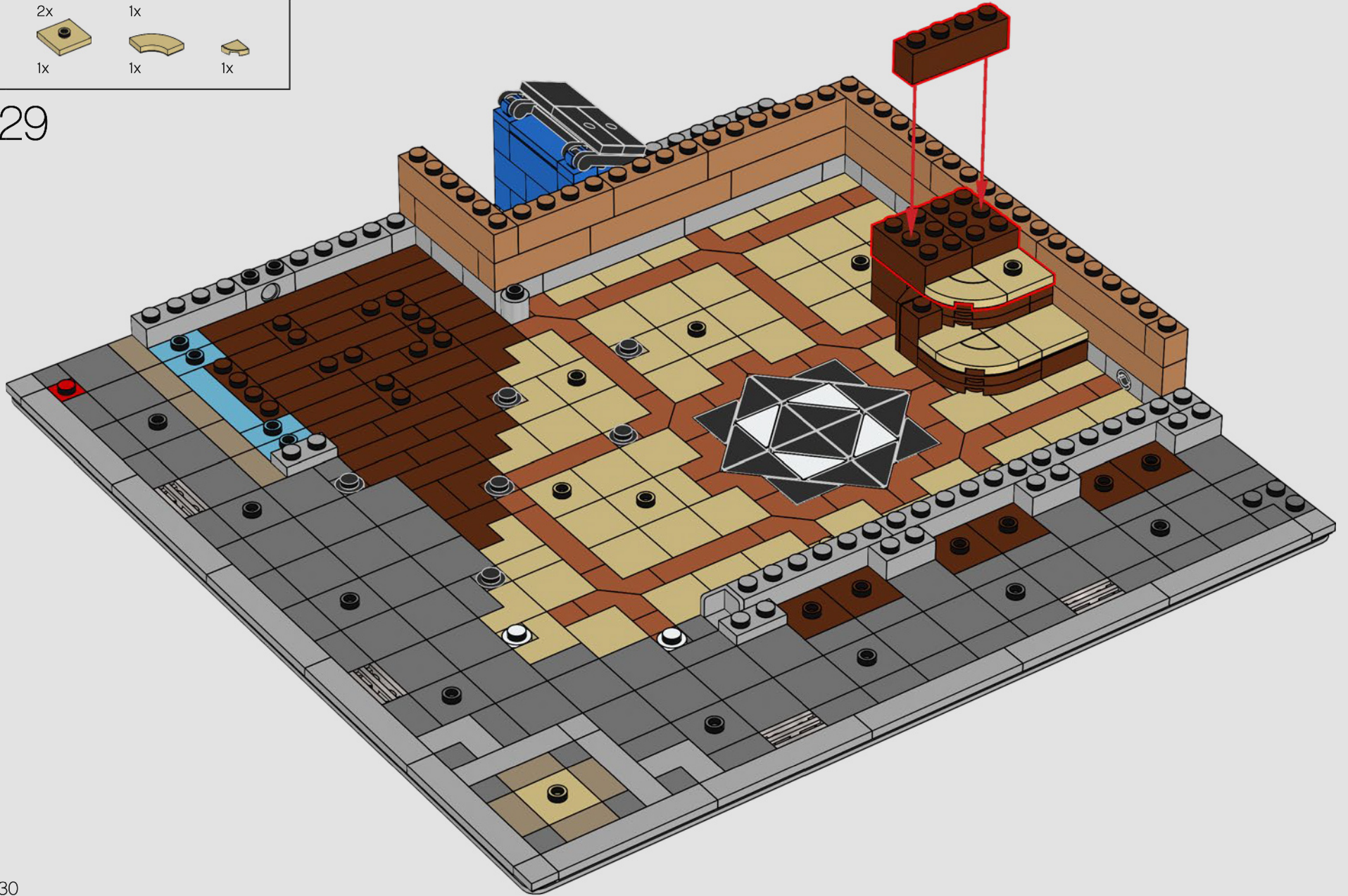

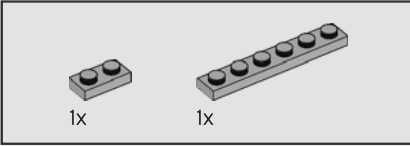
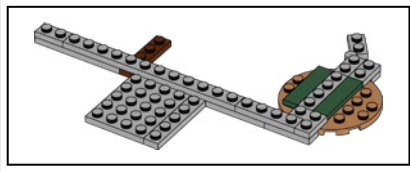

30

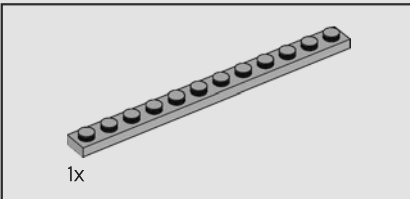
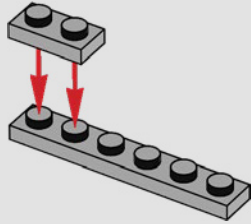

31

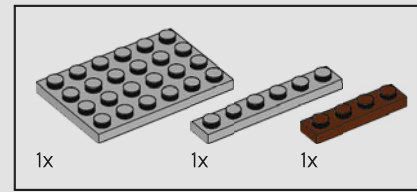
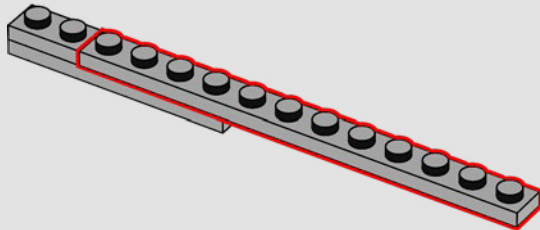

32

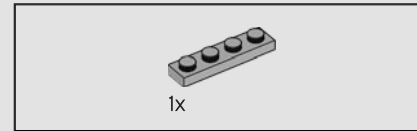
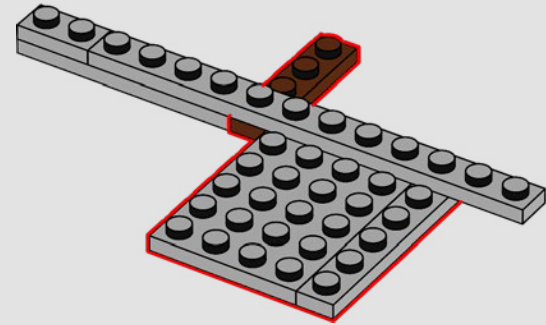

33

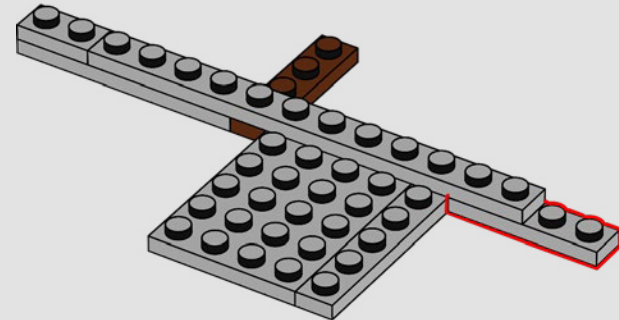

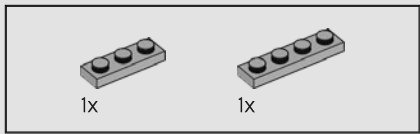

34

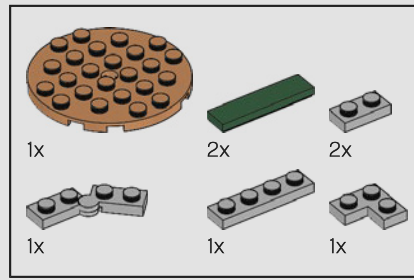
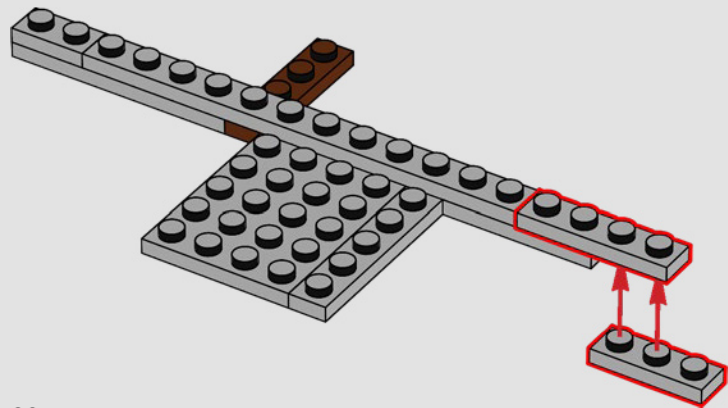

35

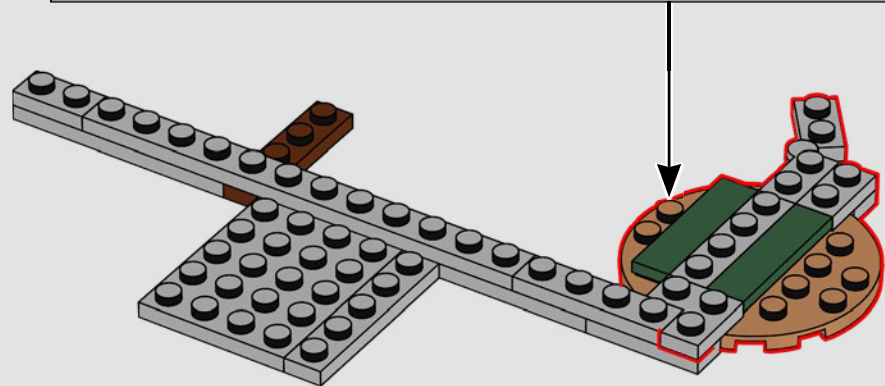
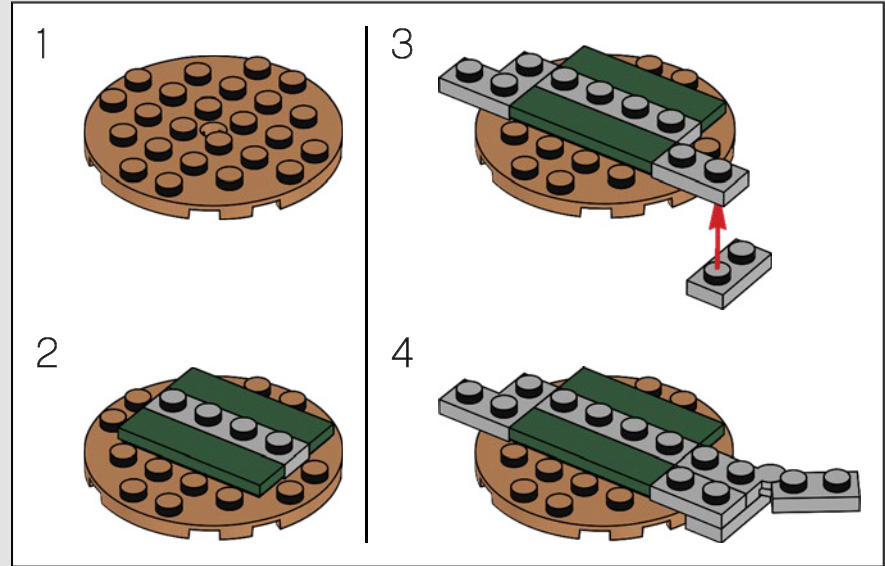



36

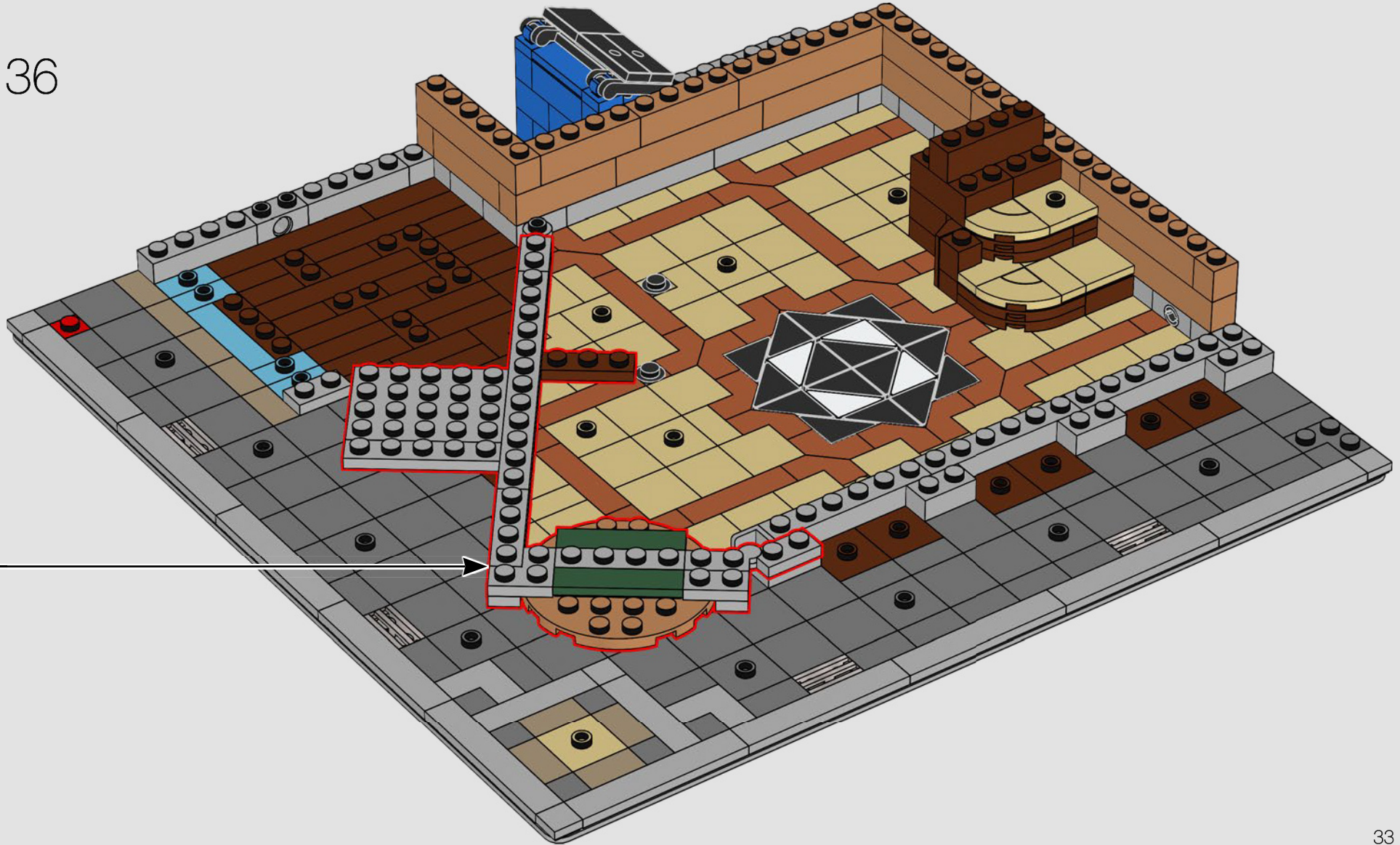

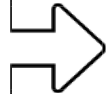

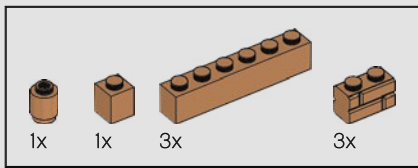

37

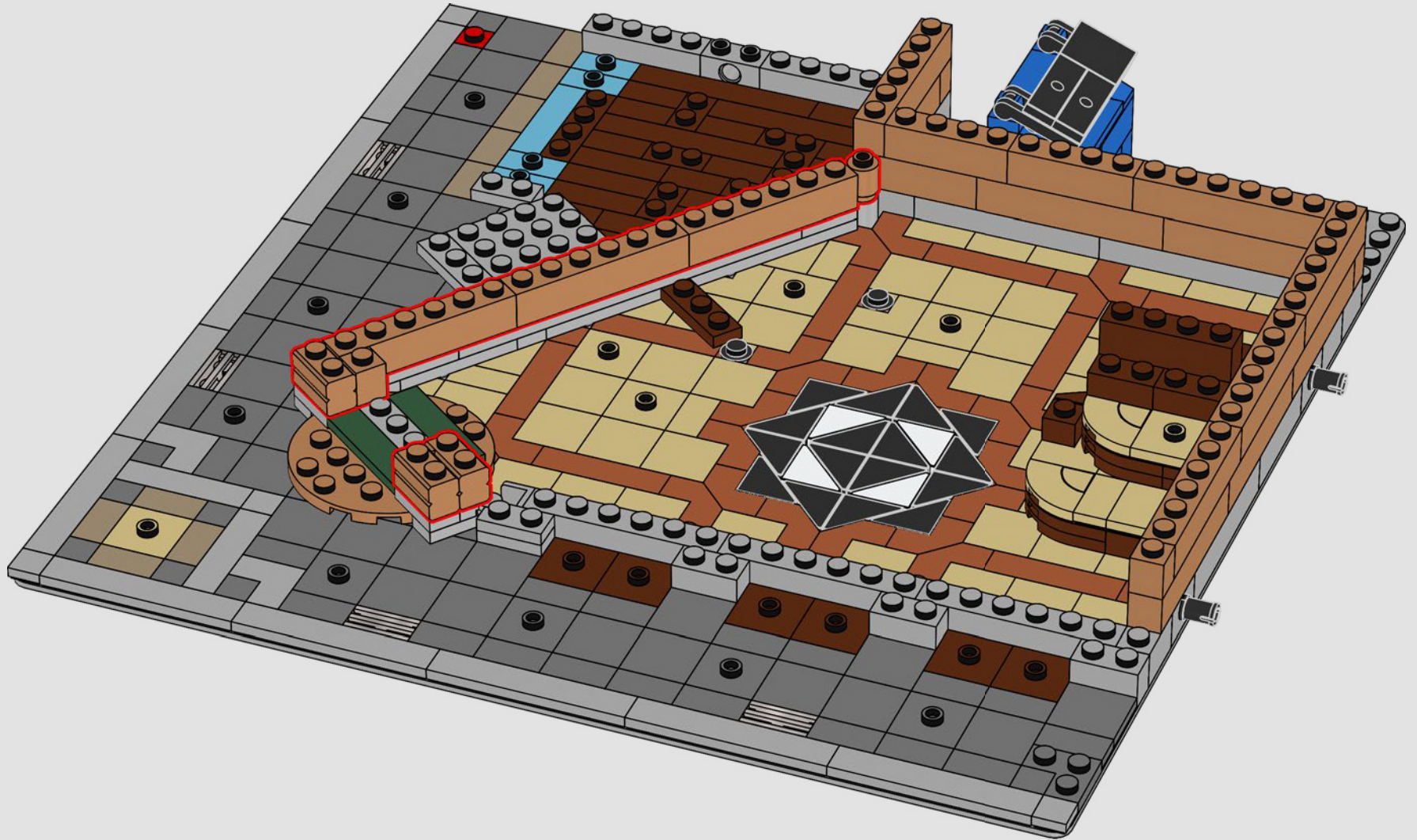

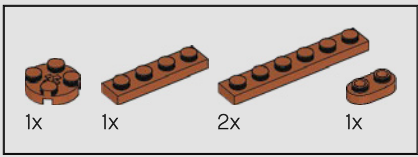

38

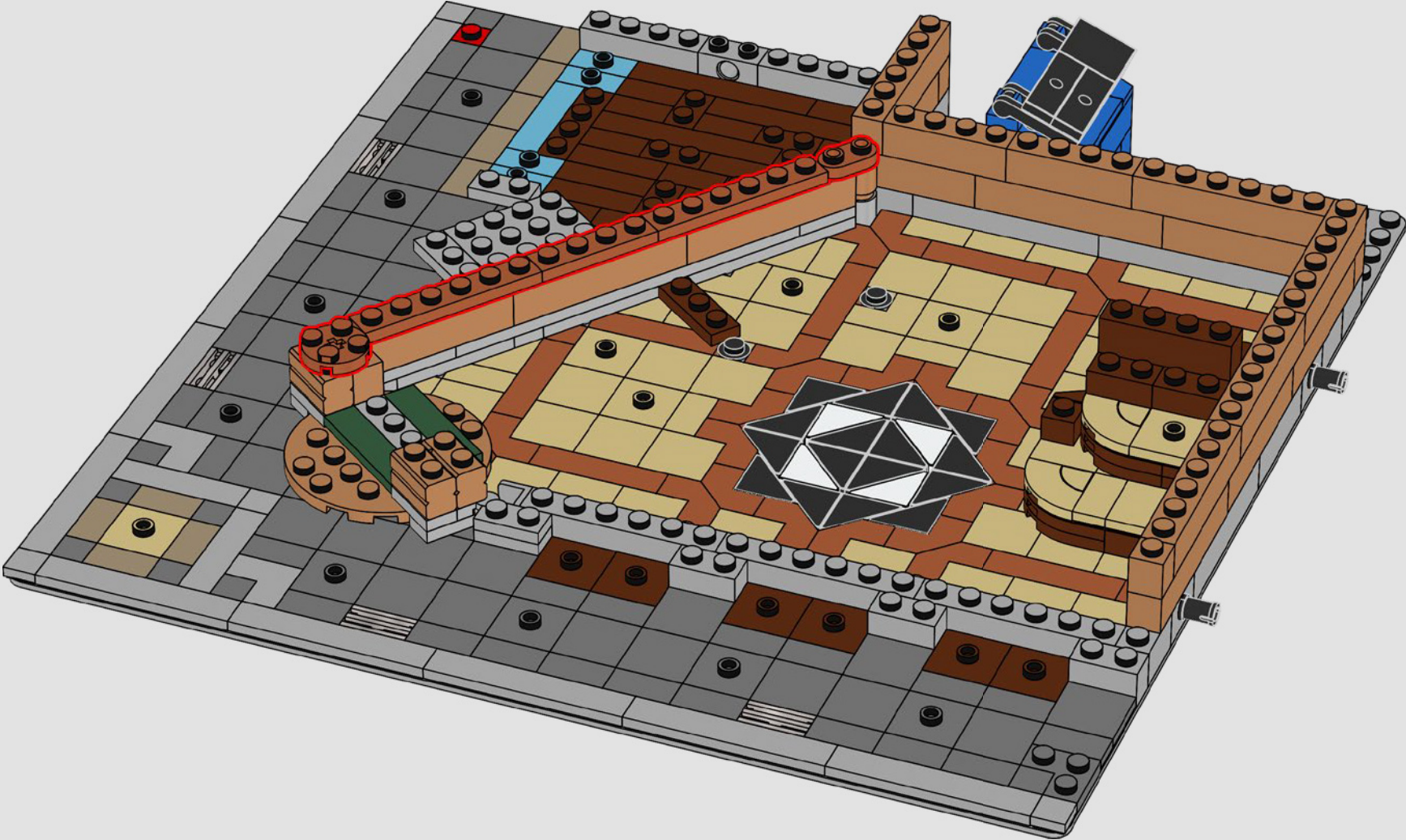

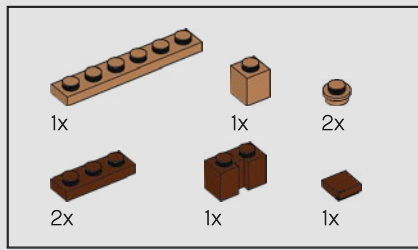

39

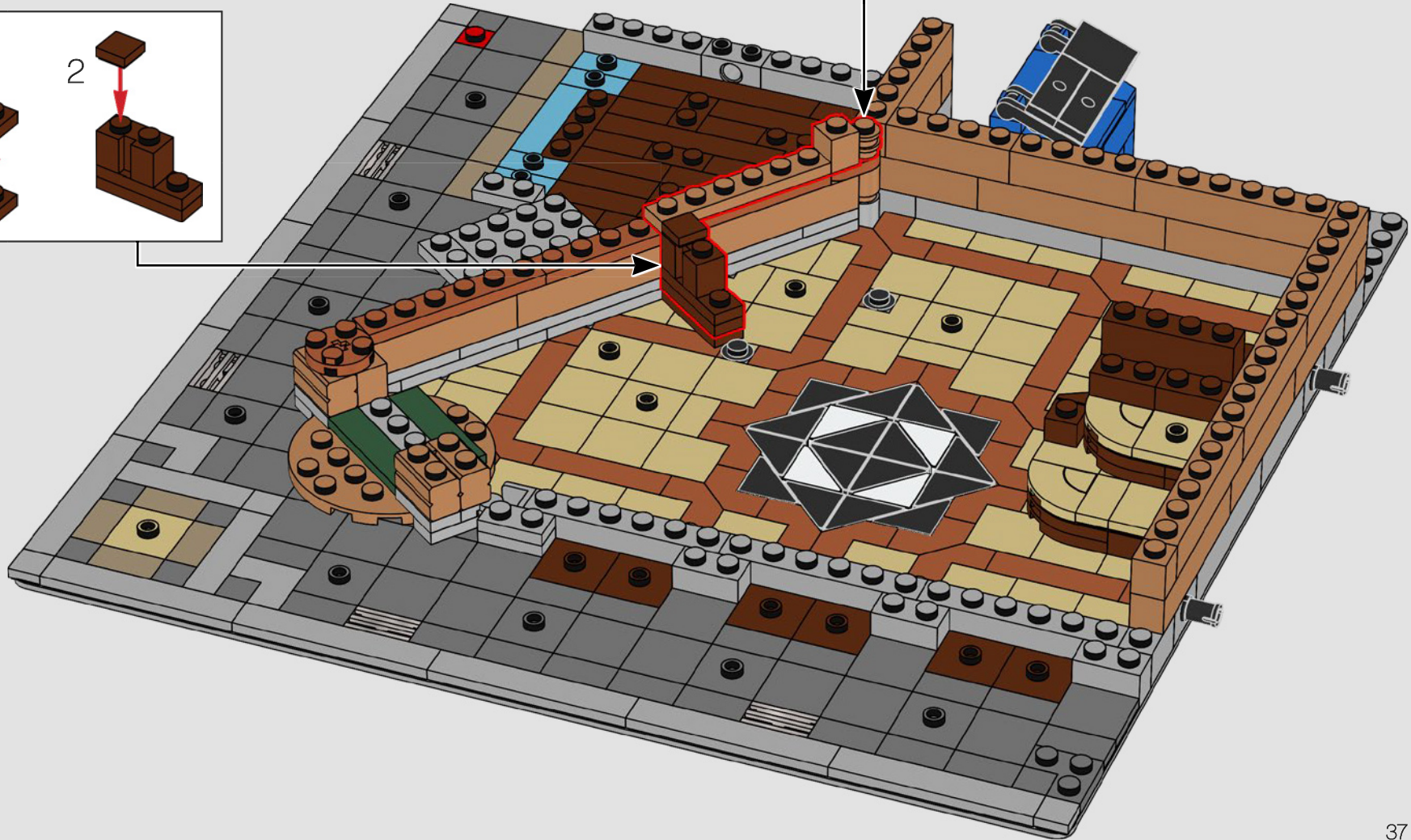
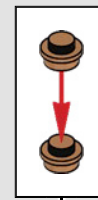
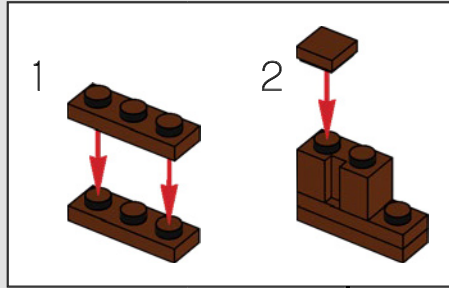

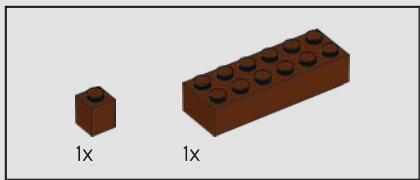

40

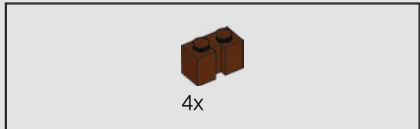
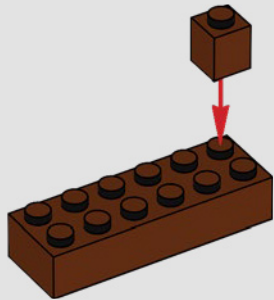

41

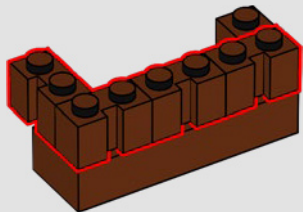

42

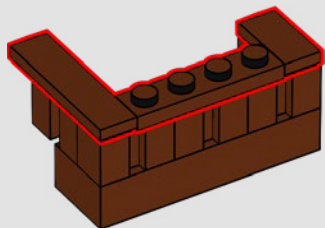

Viele der Gäste dieses Hotels stammen aus früheren Sets der Kollektion „Bauen mit Modulen“! Erkennst du sie wieder?

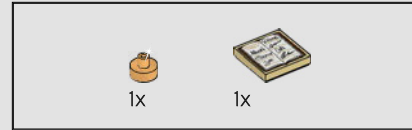

43

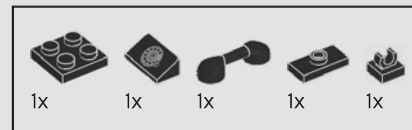
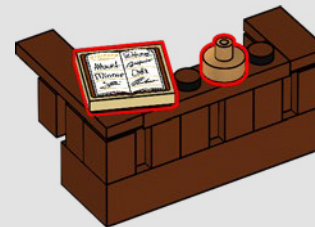

44

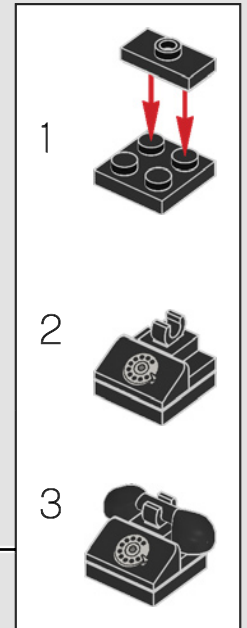
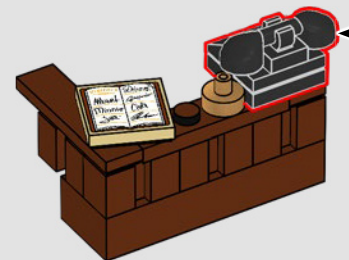



Die Rezeptionistin benutzt gerne dieses Telefon, um ihren Freund in der „Polizeistation“ (10278) anzurufen.

45

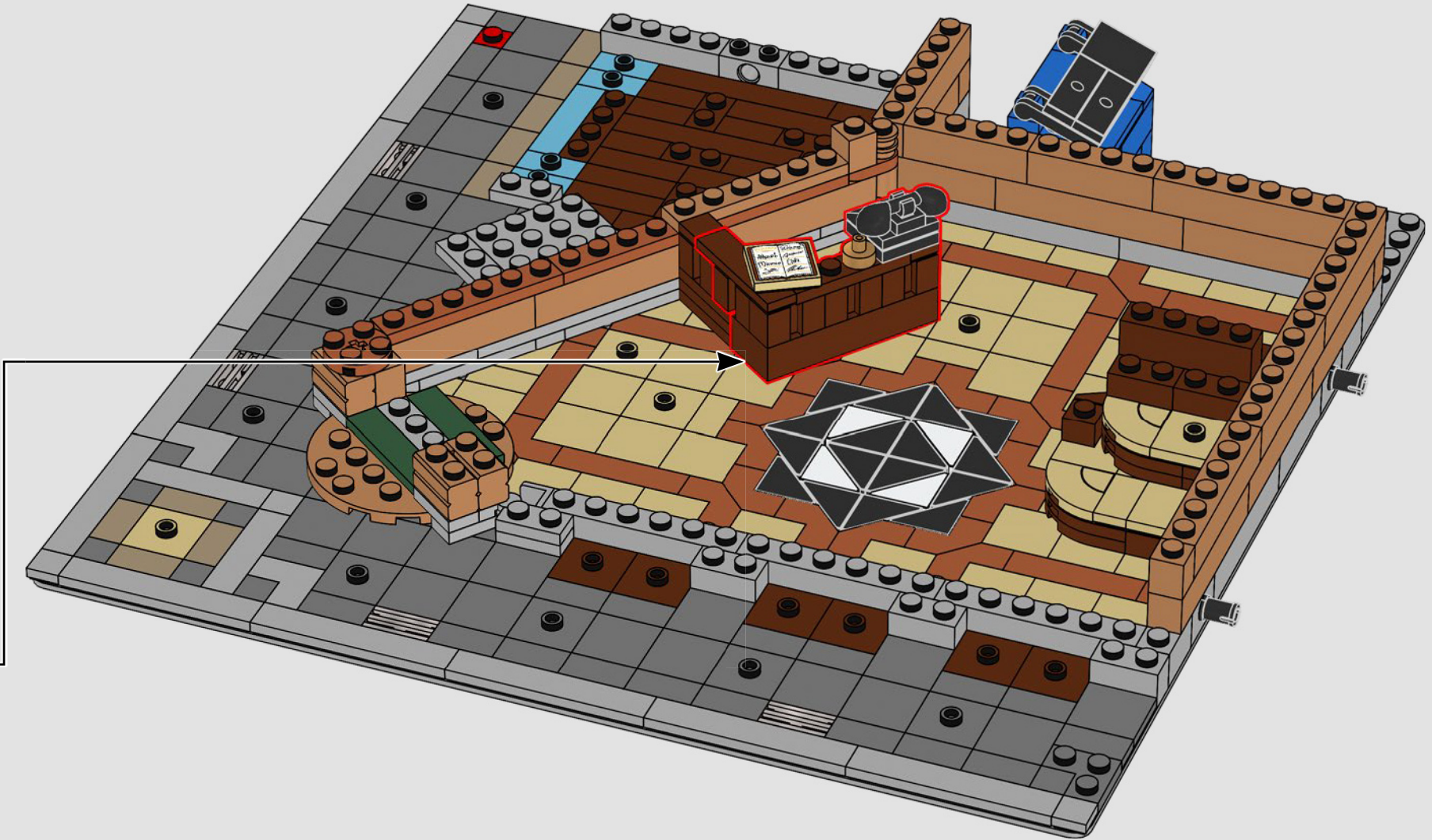

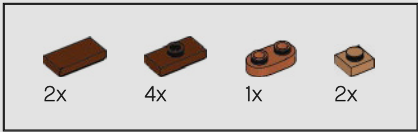

46

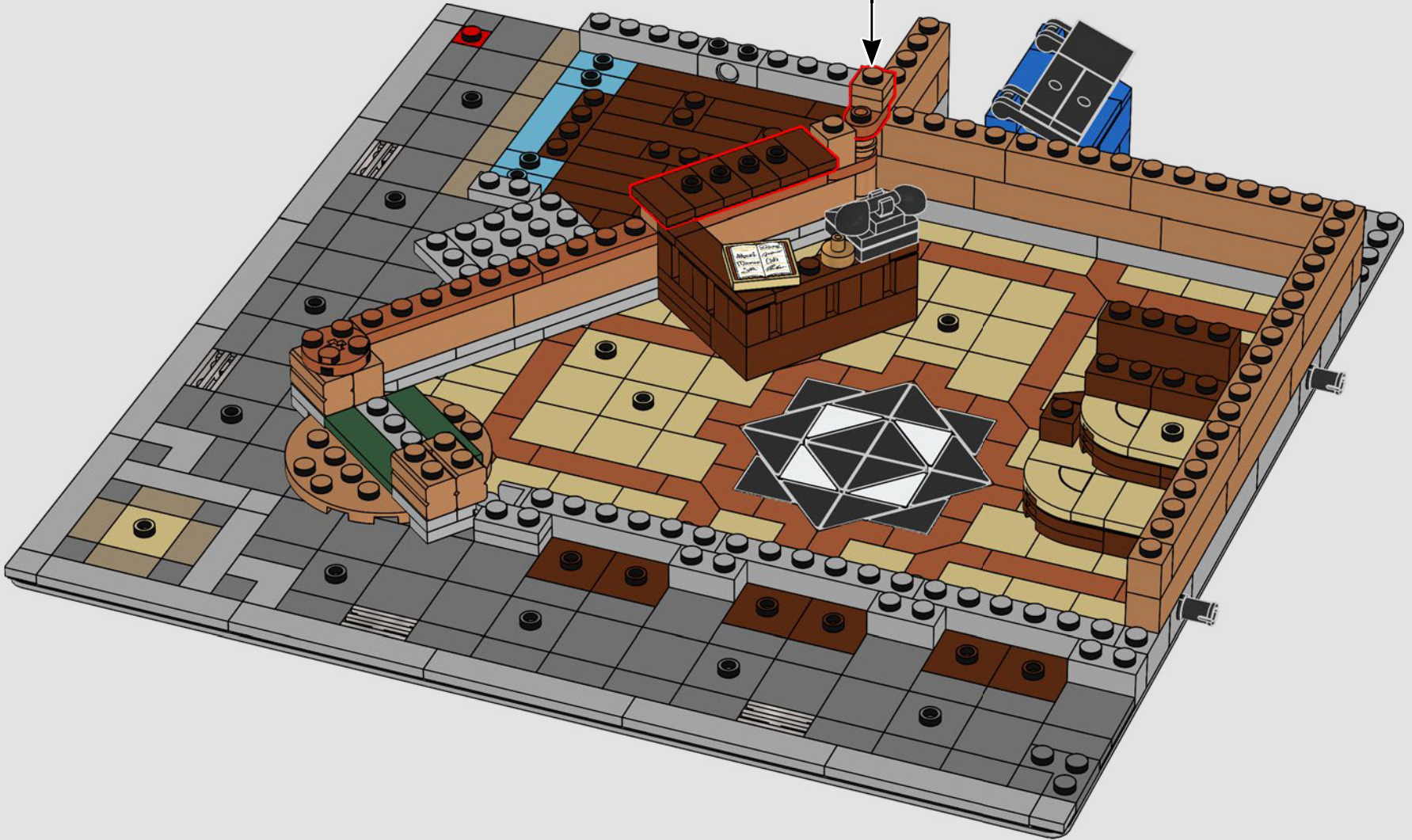
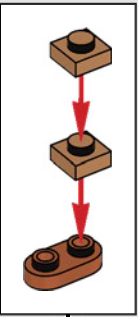



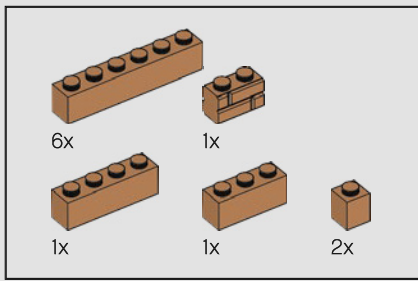

47

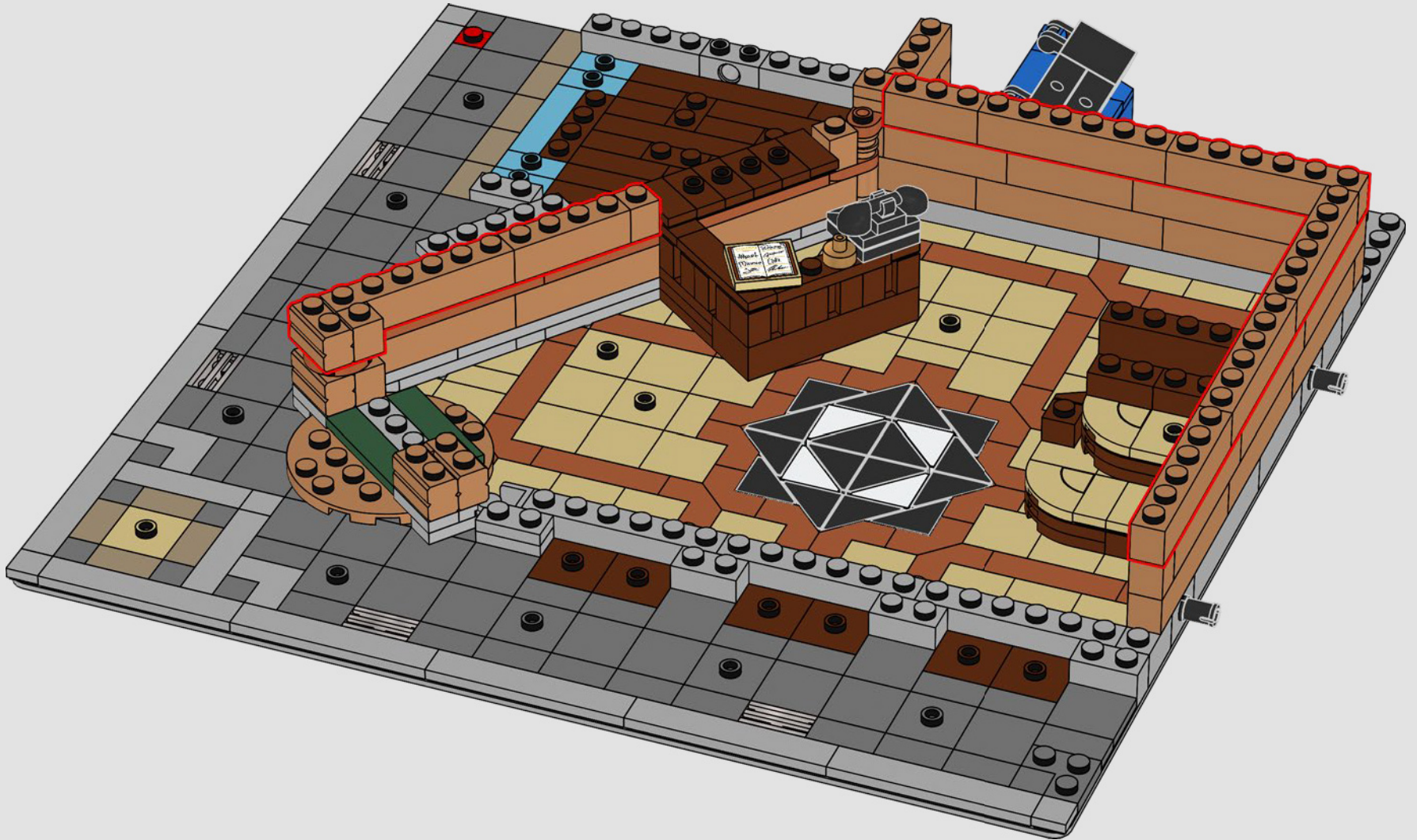

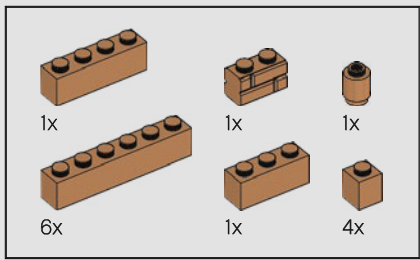

48

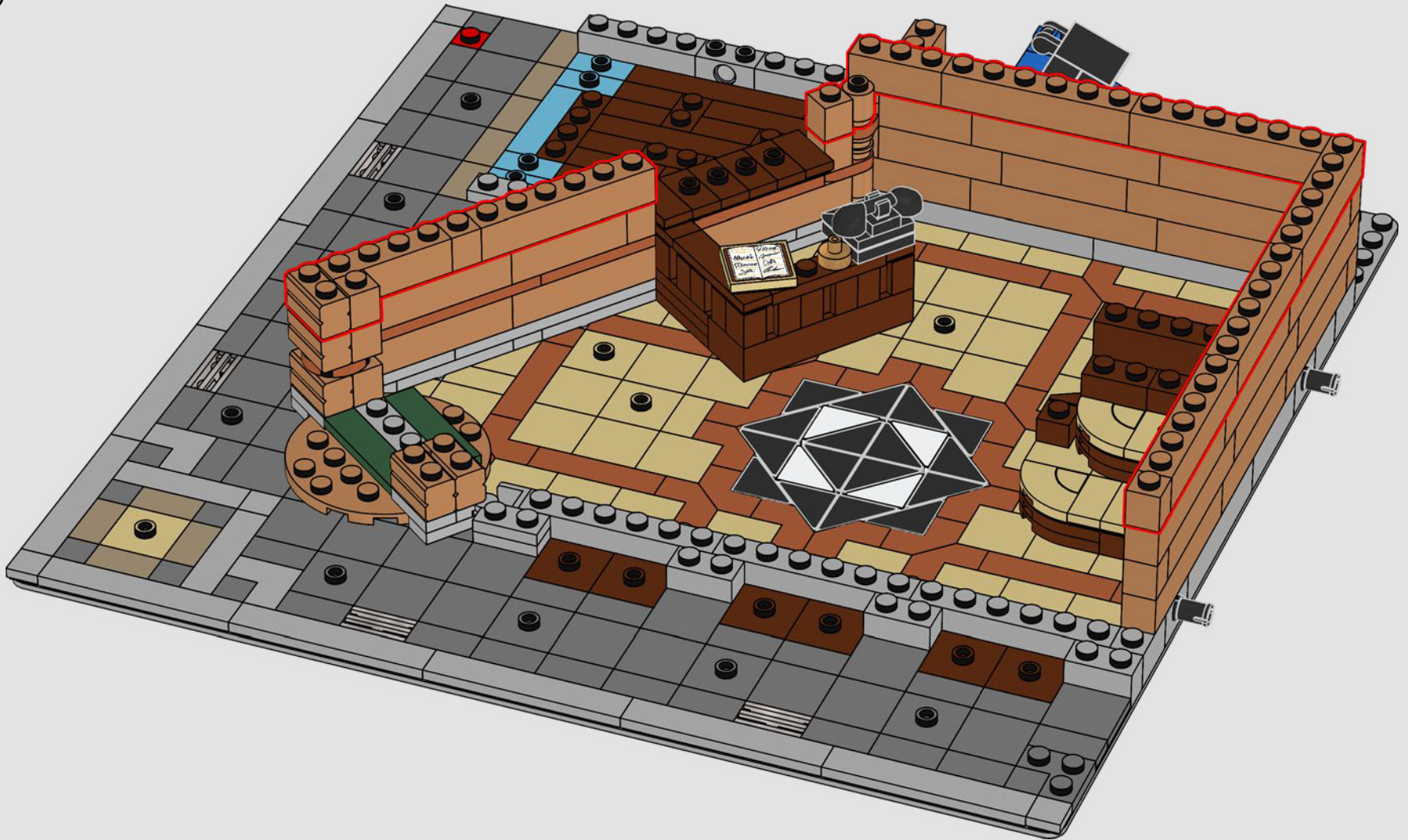

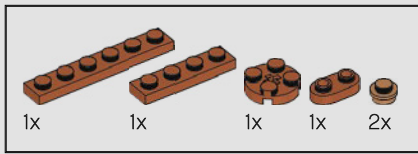

49

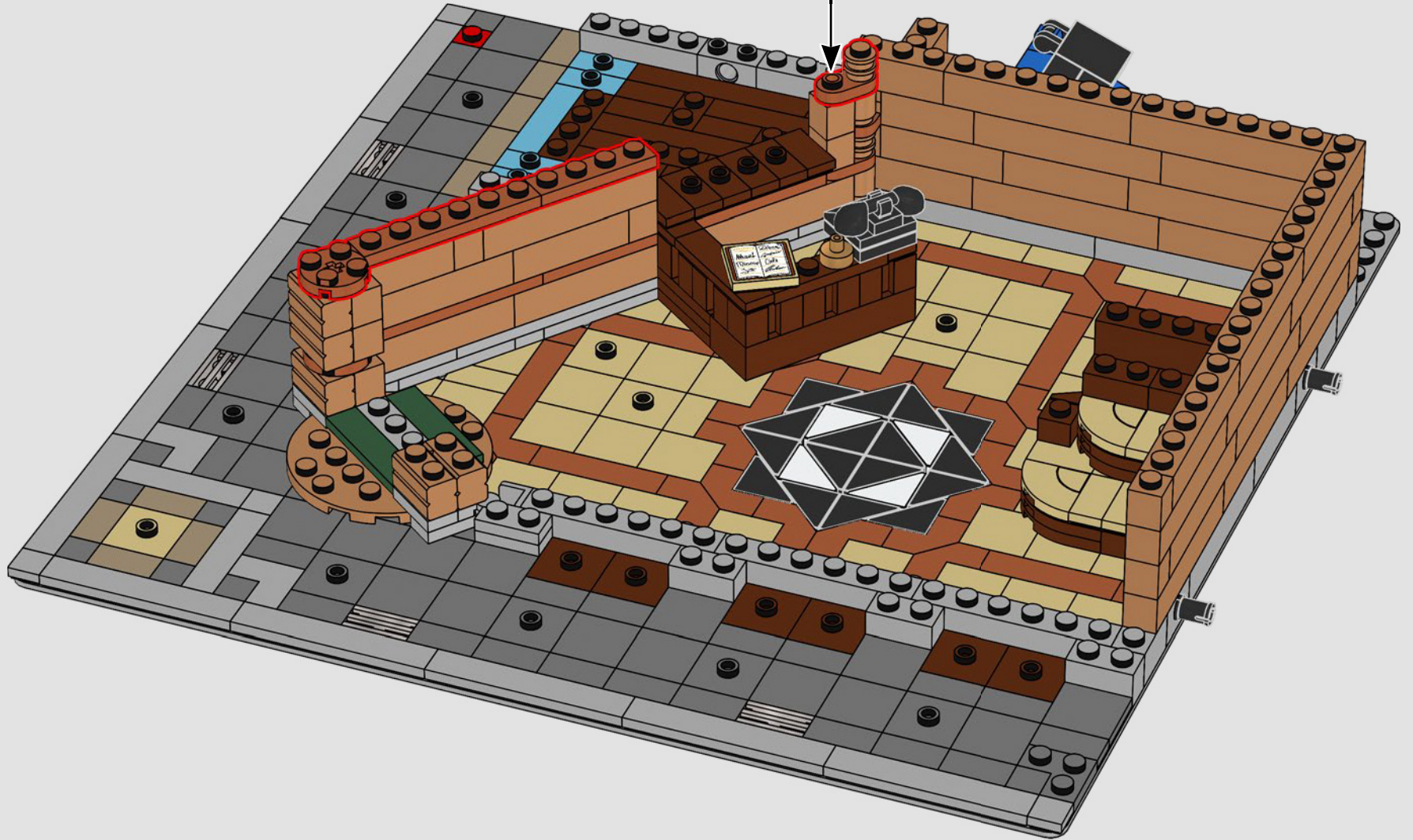
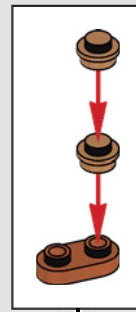

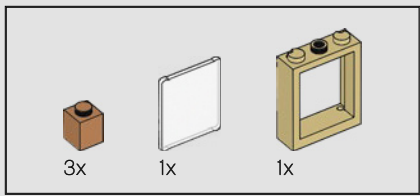

50

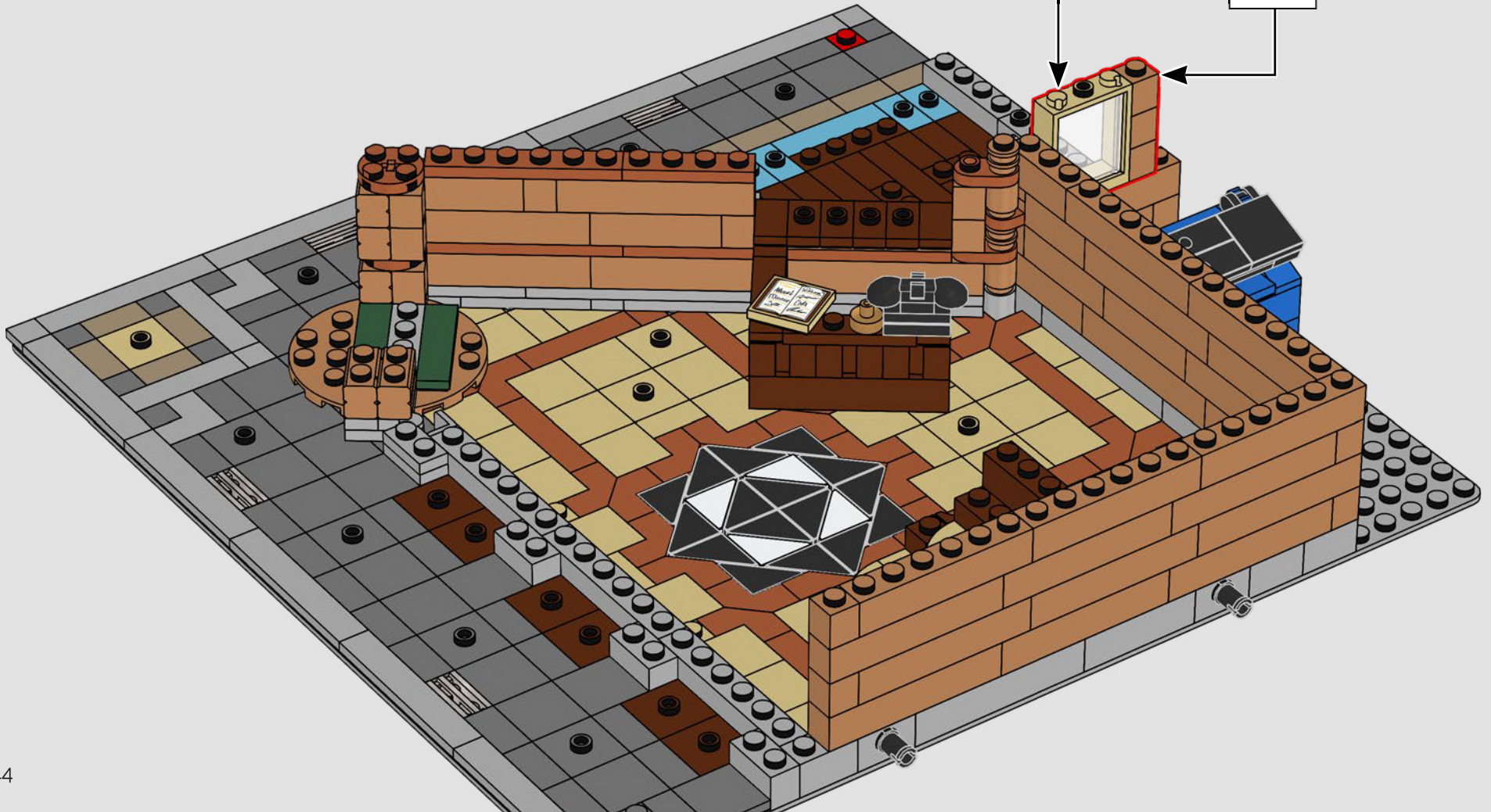
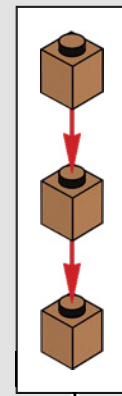
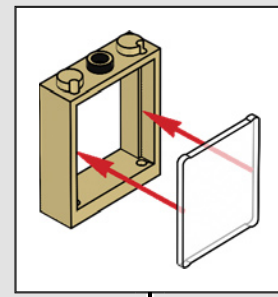

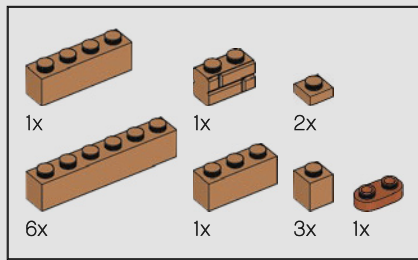

51

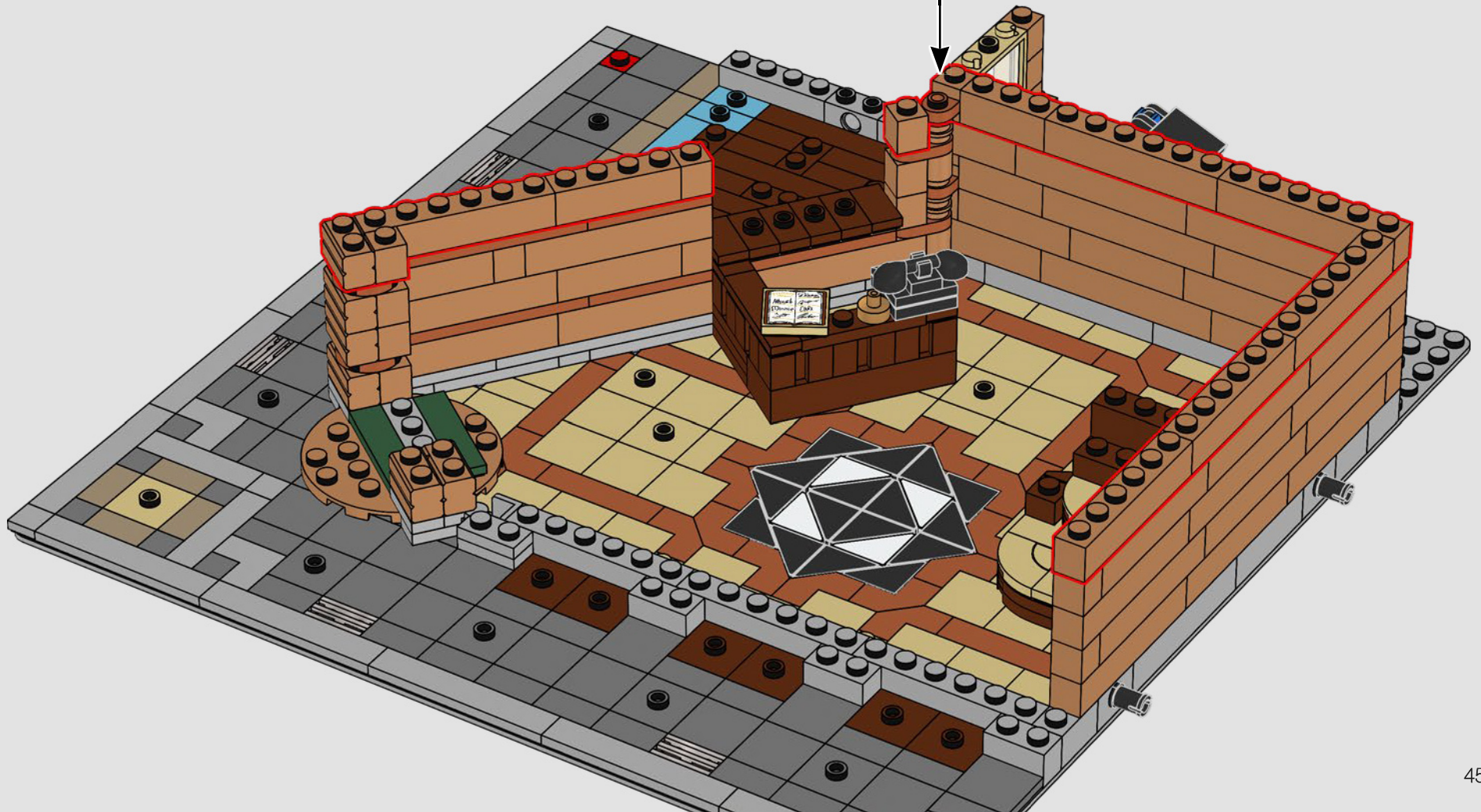
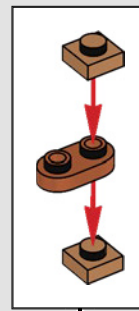

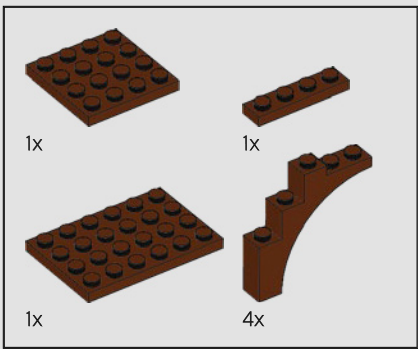

52

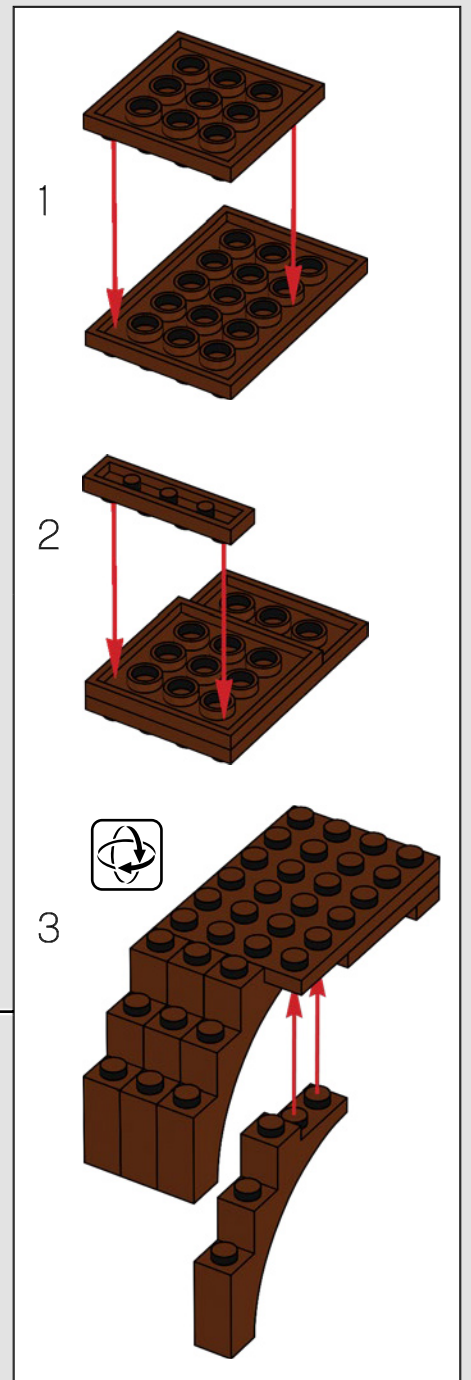
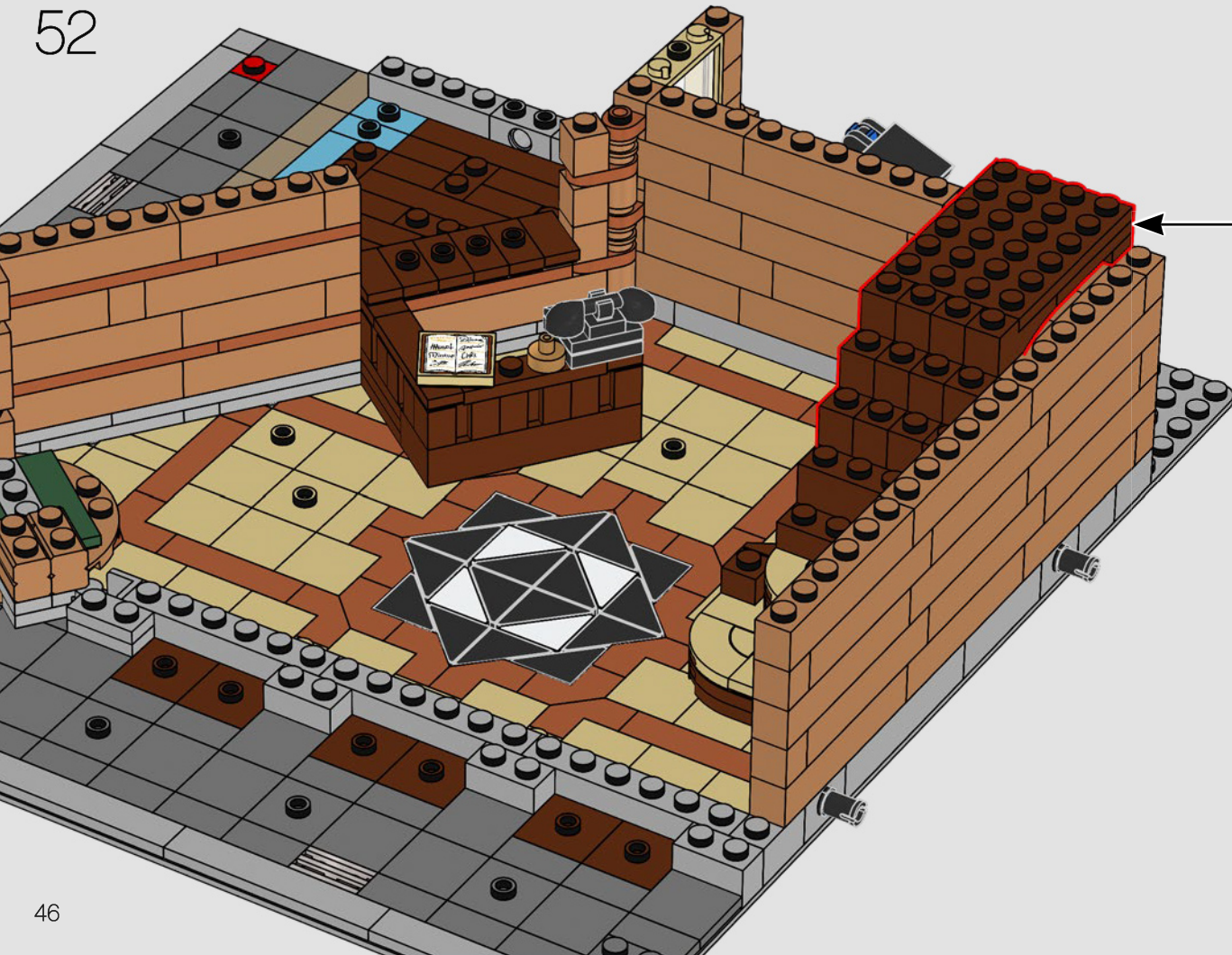

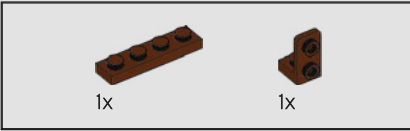

53

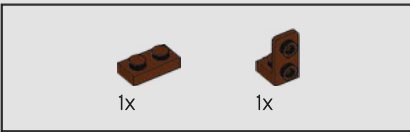
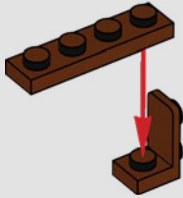

54

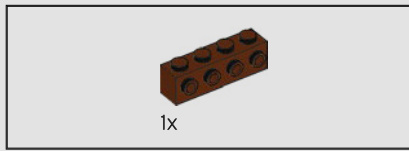
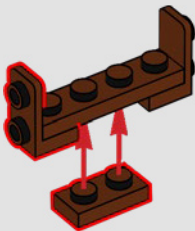

55

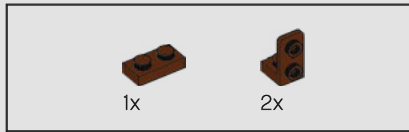
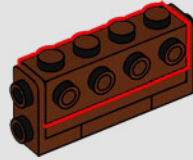

56

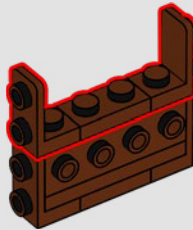

57

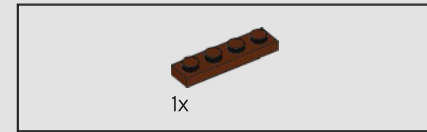
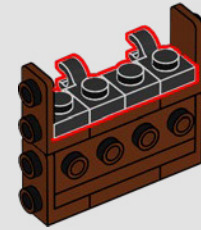

58

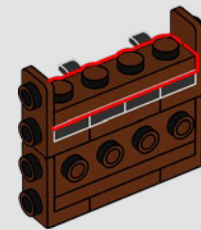



59



60

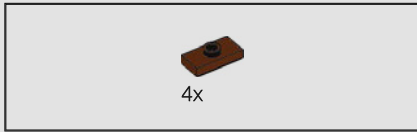
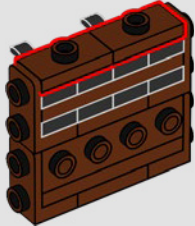

61

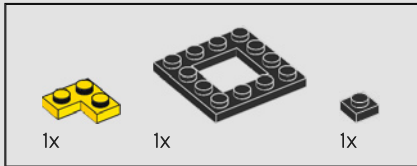
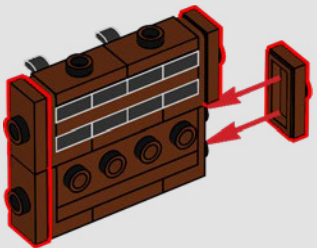

62

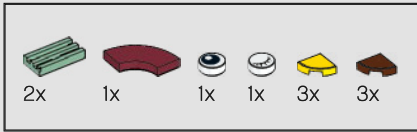
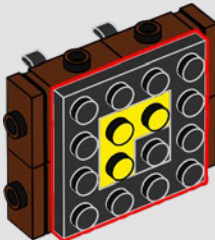

63

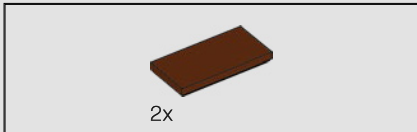
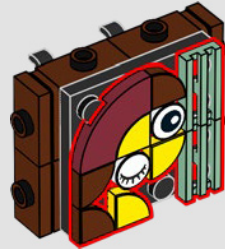

64

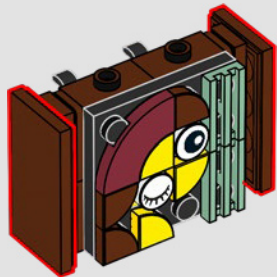



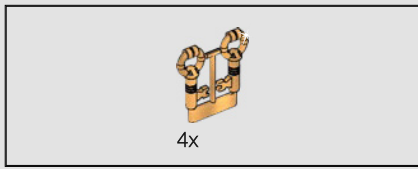

65

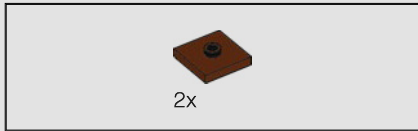
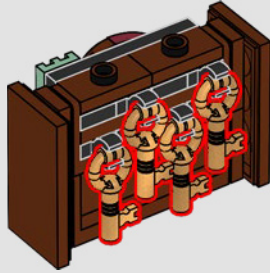

66

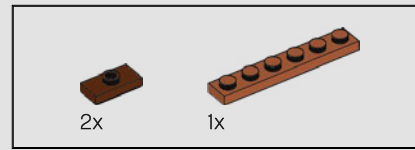
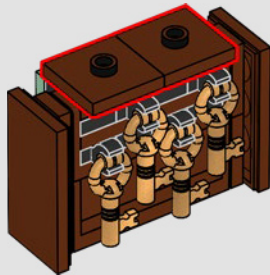

67

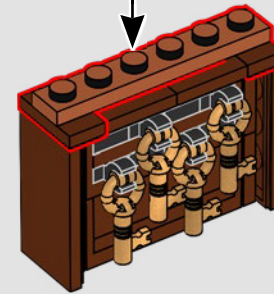
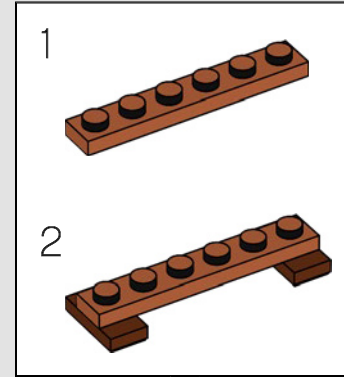

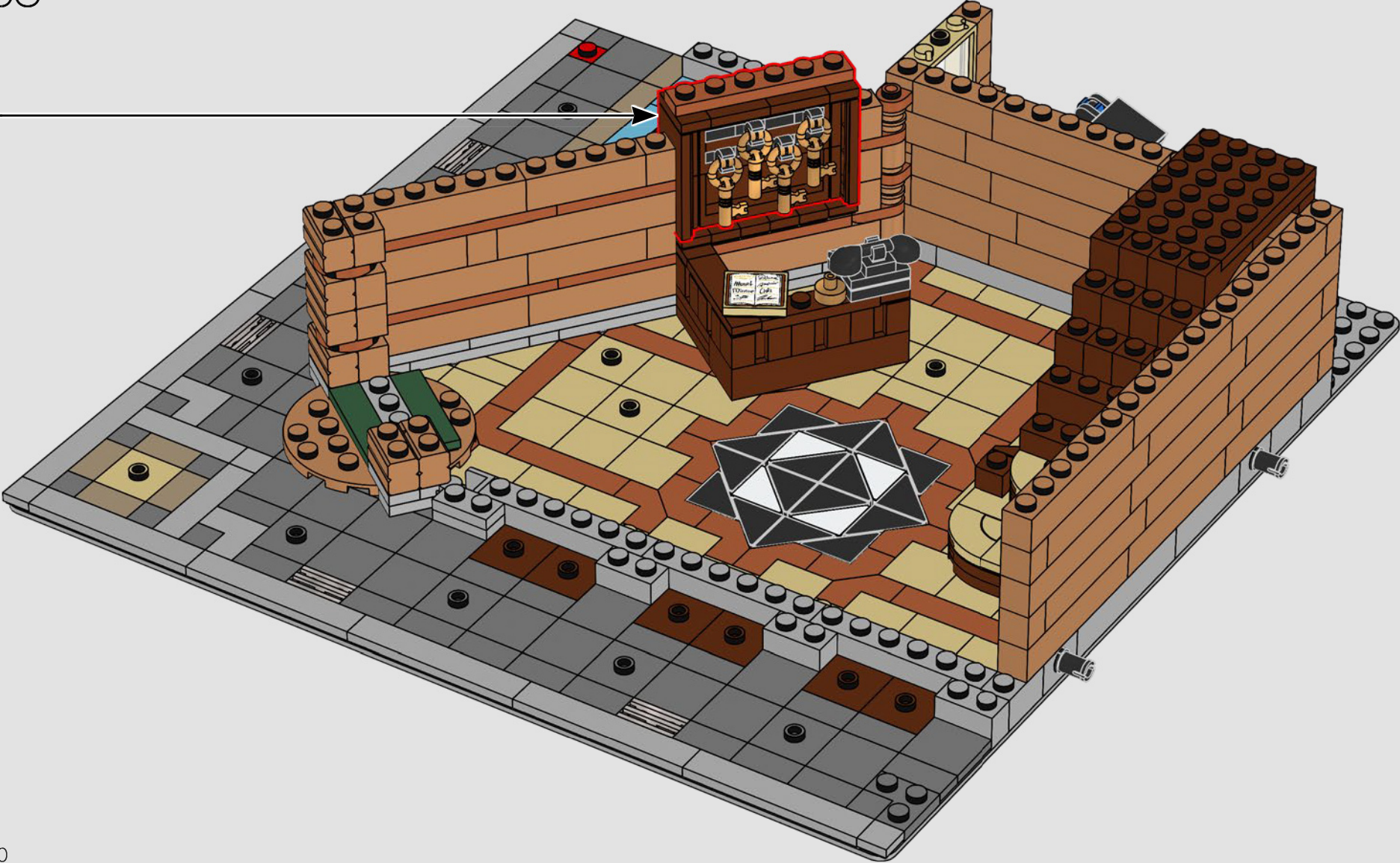

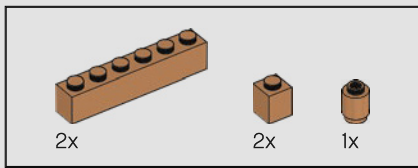

69

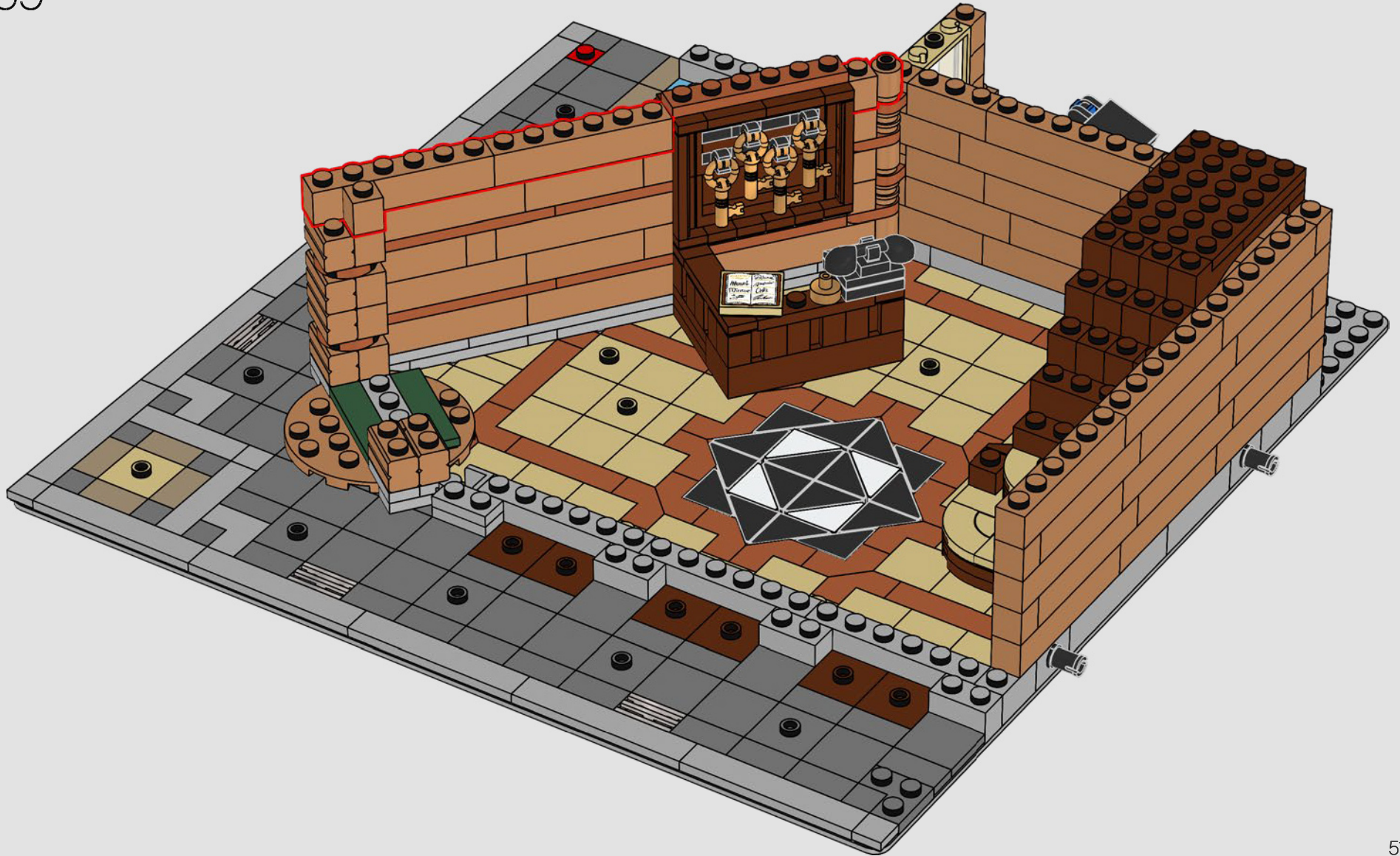

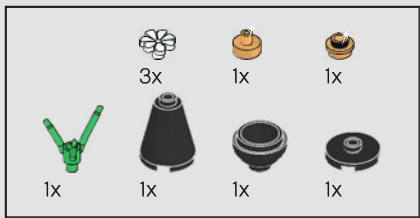

70

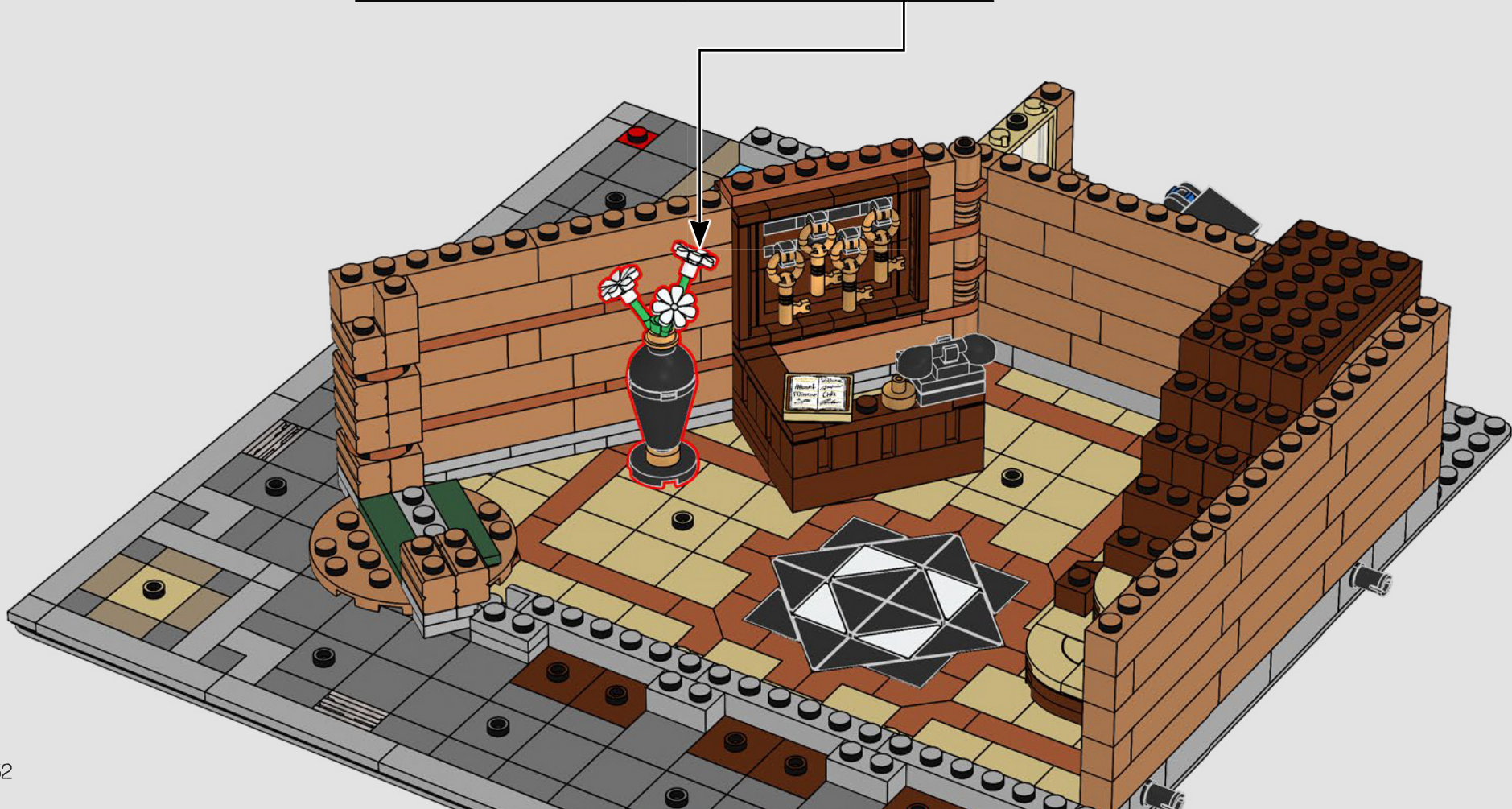
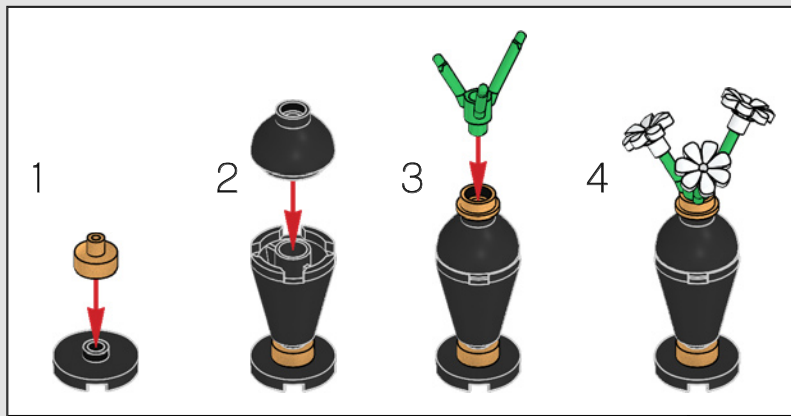

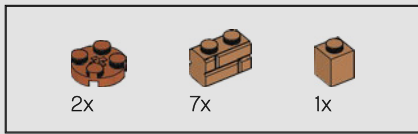

71

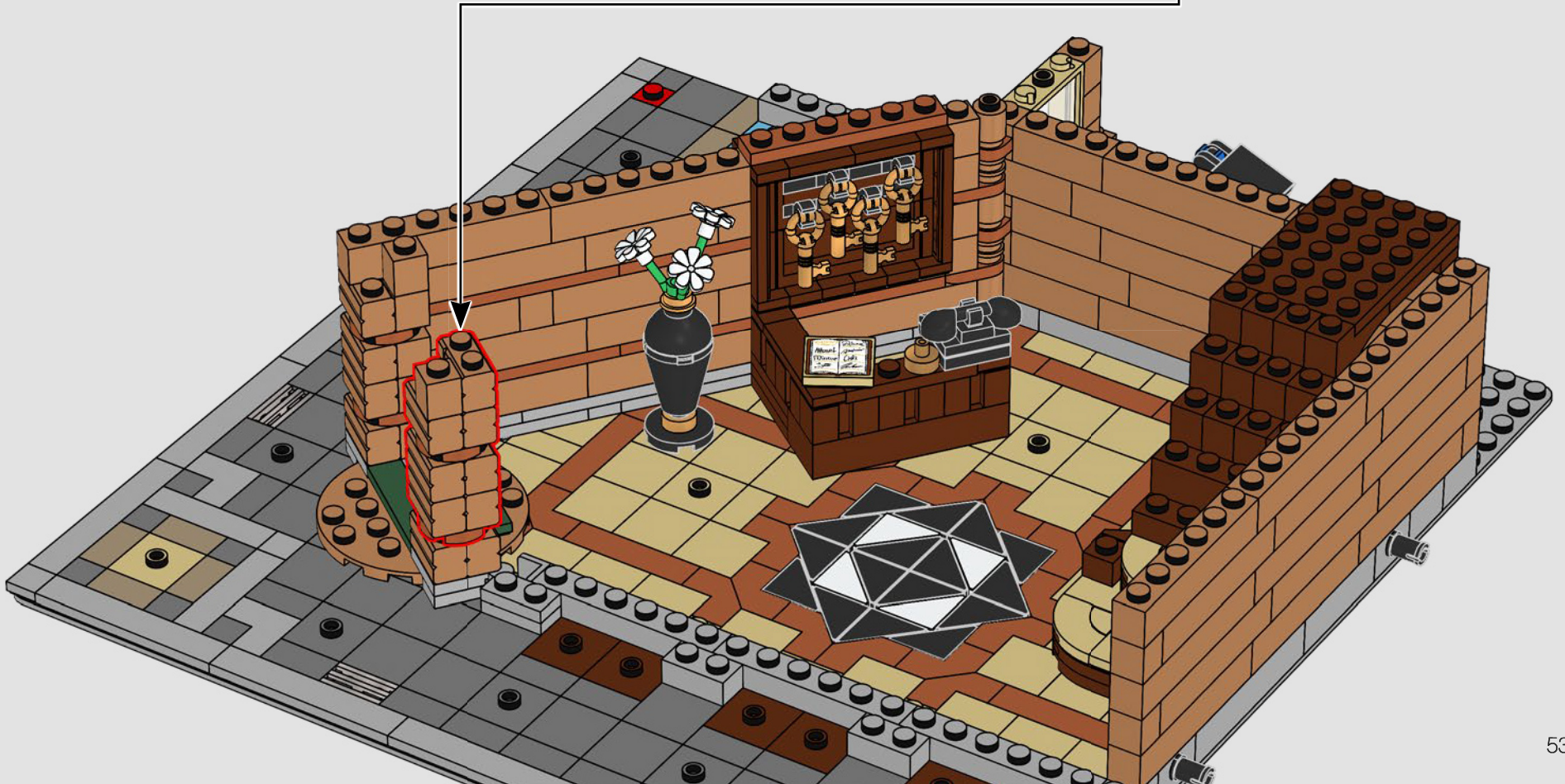
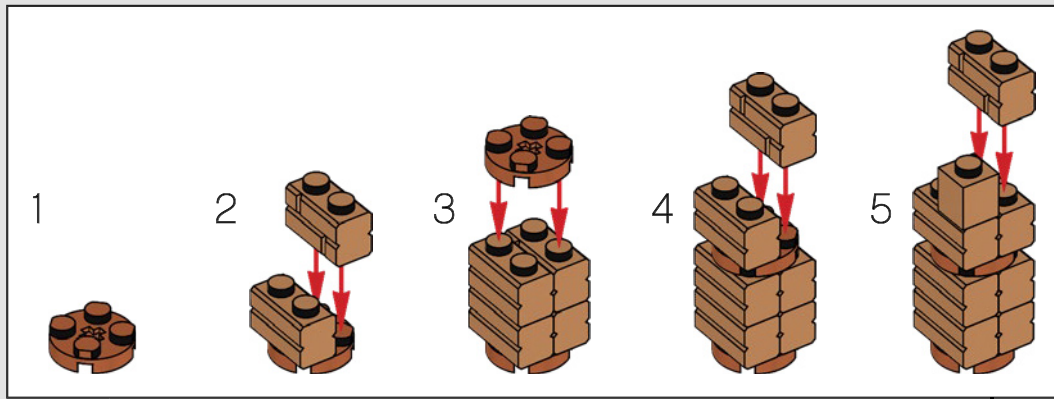

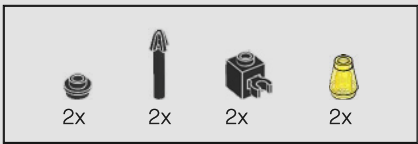

72

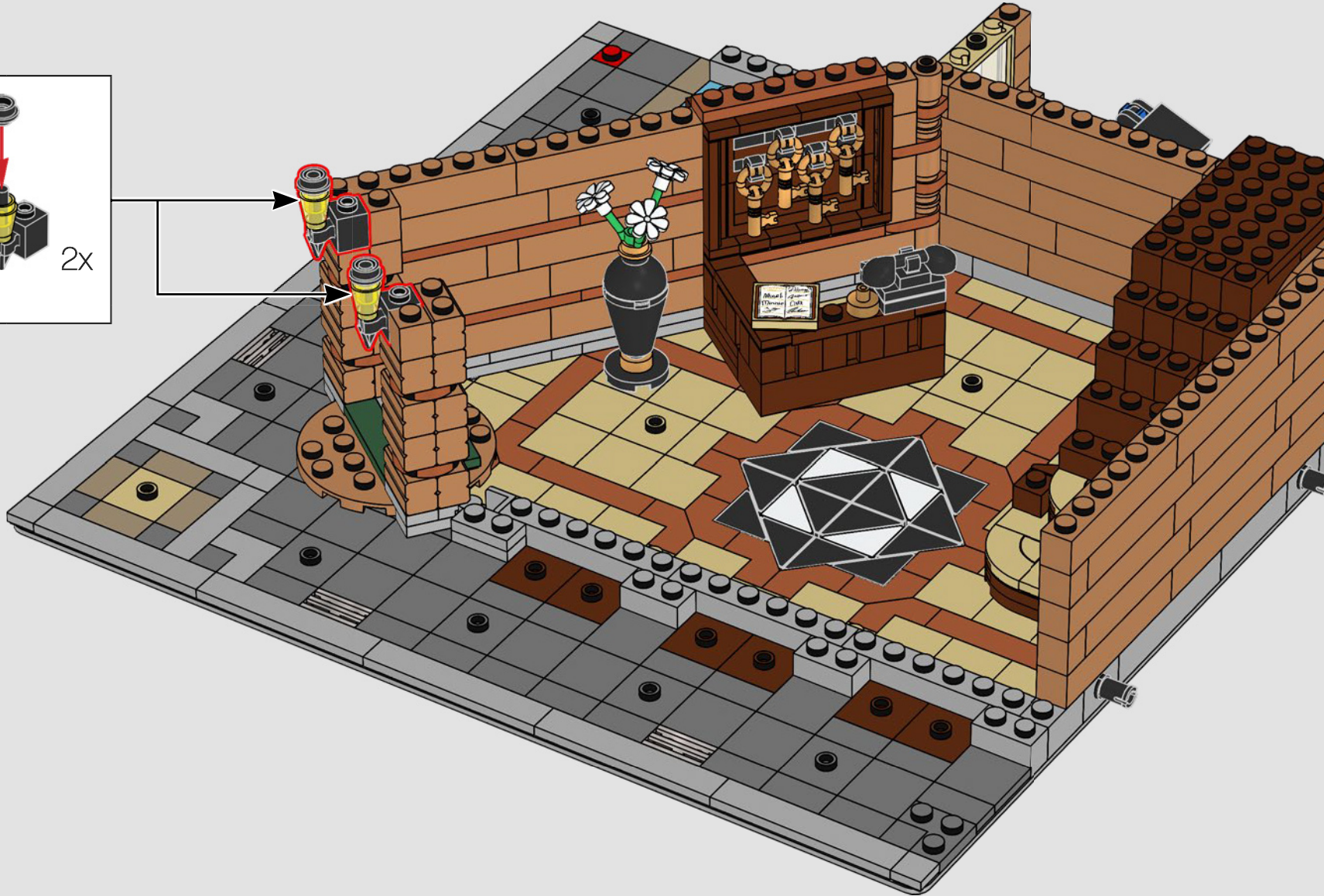
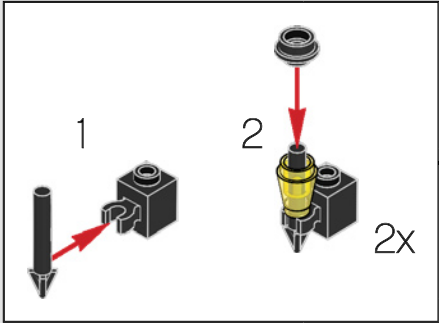

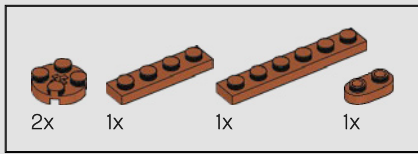

73

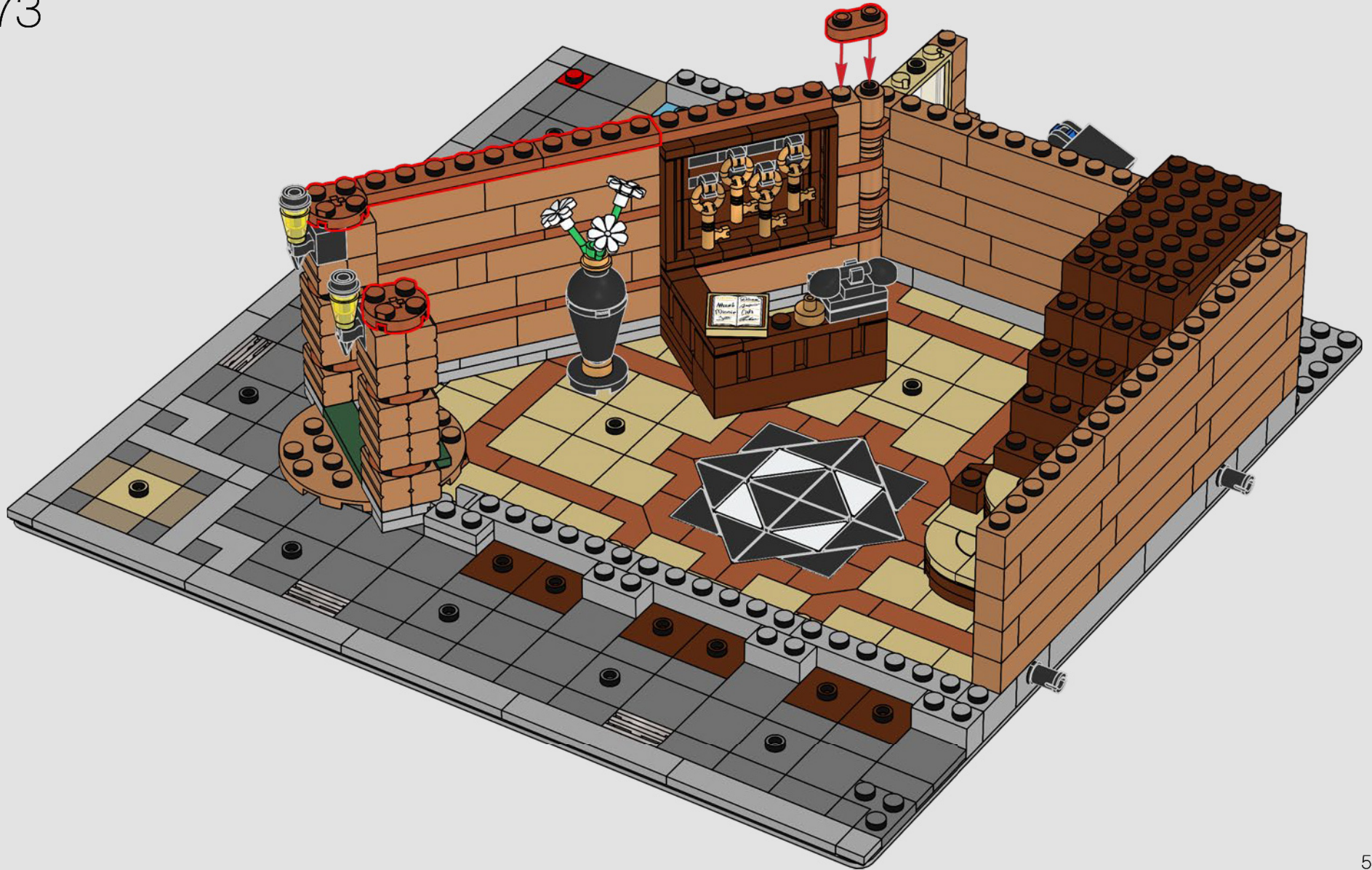

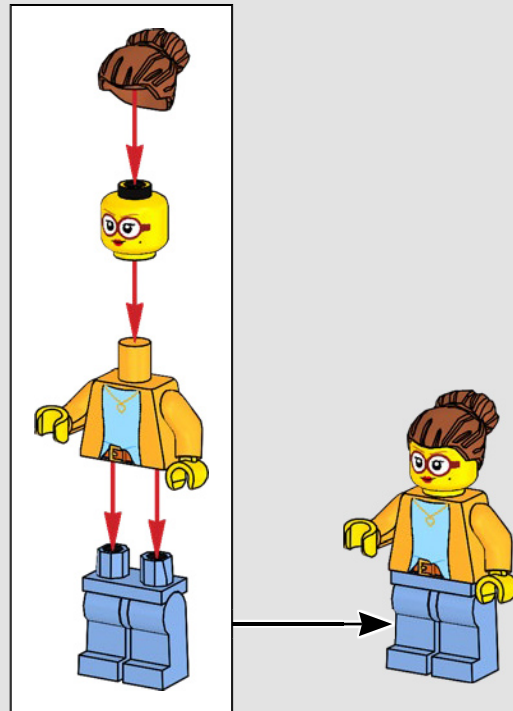



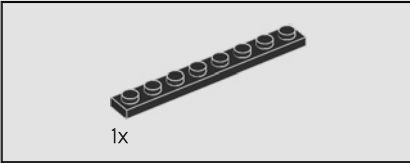
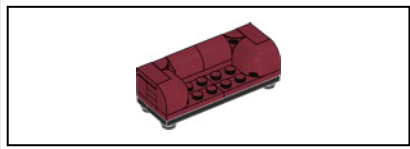

1x

74

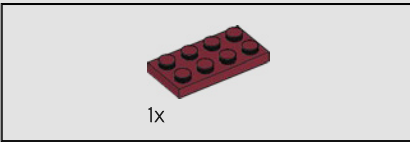
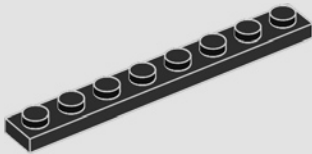

1x

75

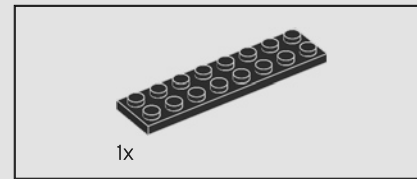
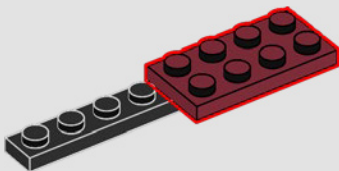

1x

76

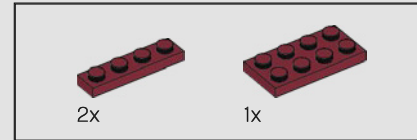
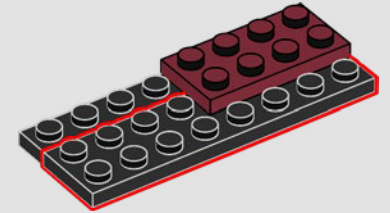

2x

1x

77

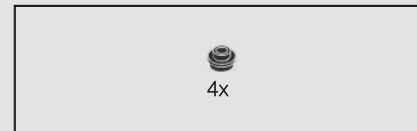
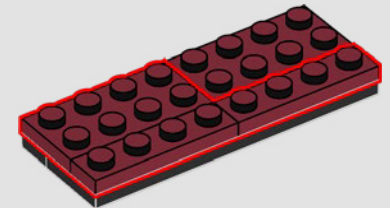

4x

78

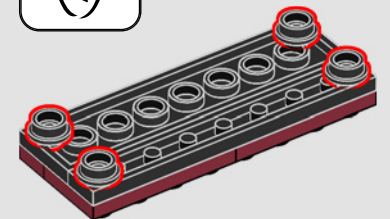
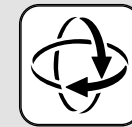

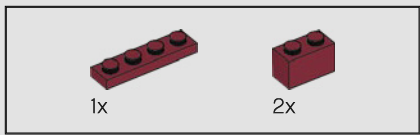

79

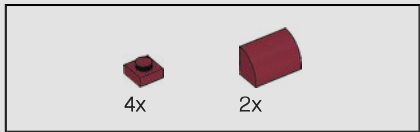
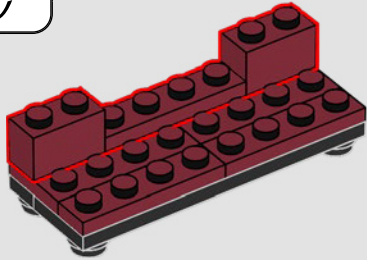

80

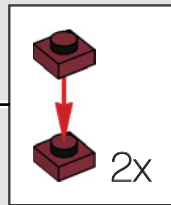
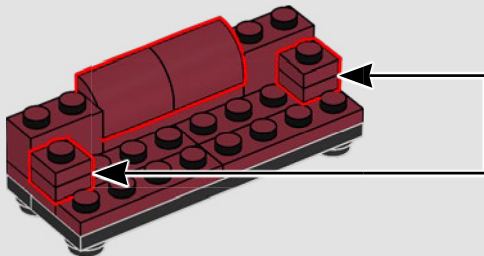

81

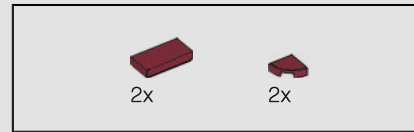
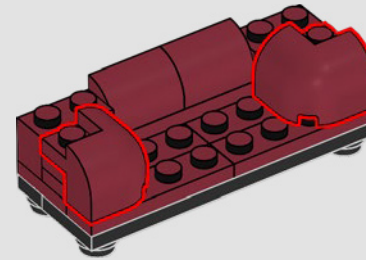

82

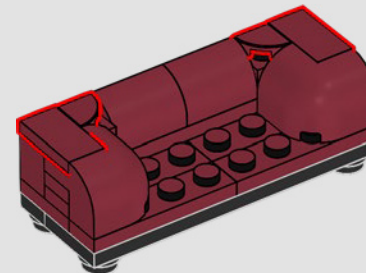



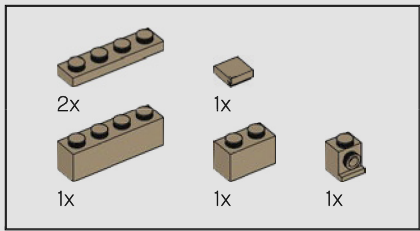

84

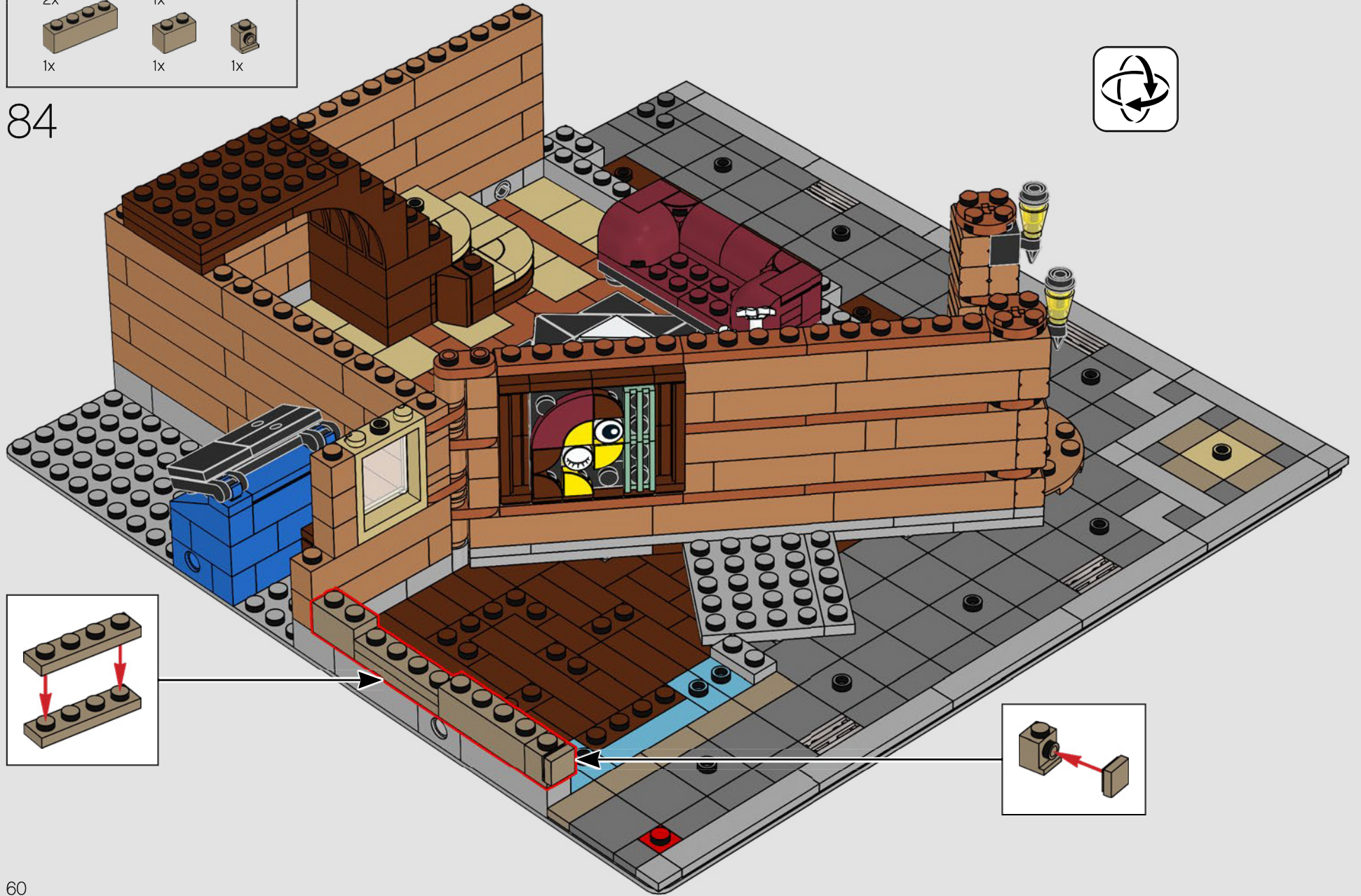

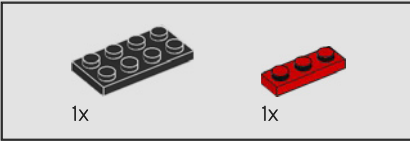

85

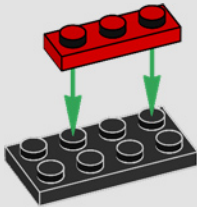

86

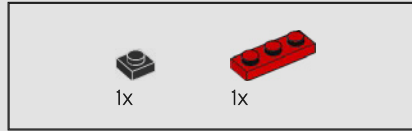
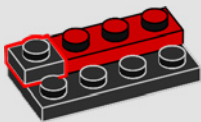

87

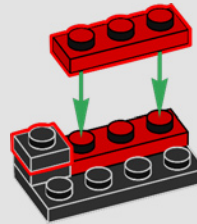

88

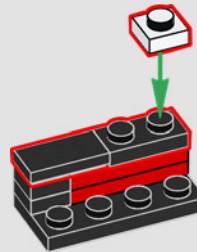

89

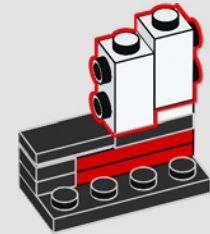

90

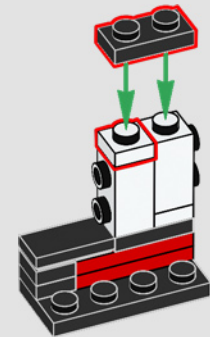

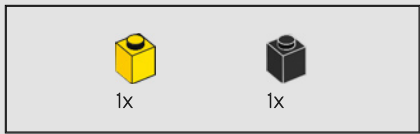

91

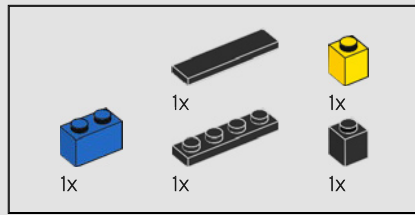
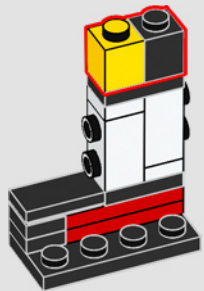

92

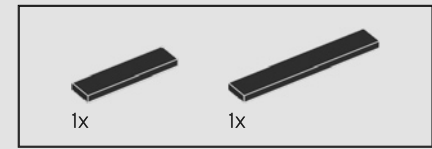
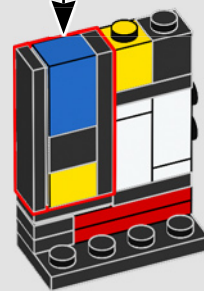
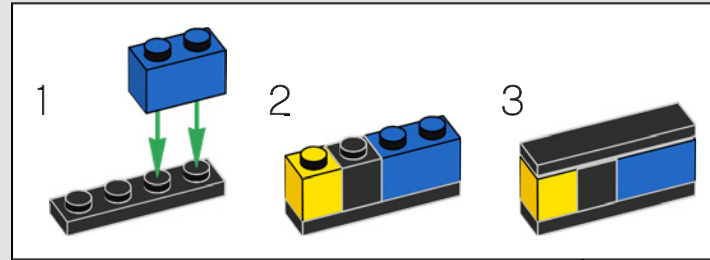

93

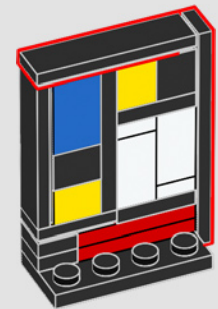

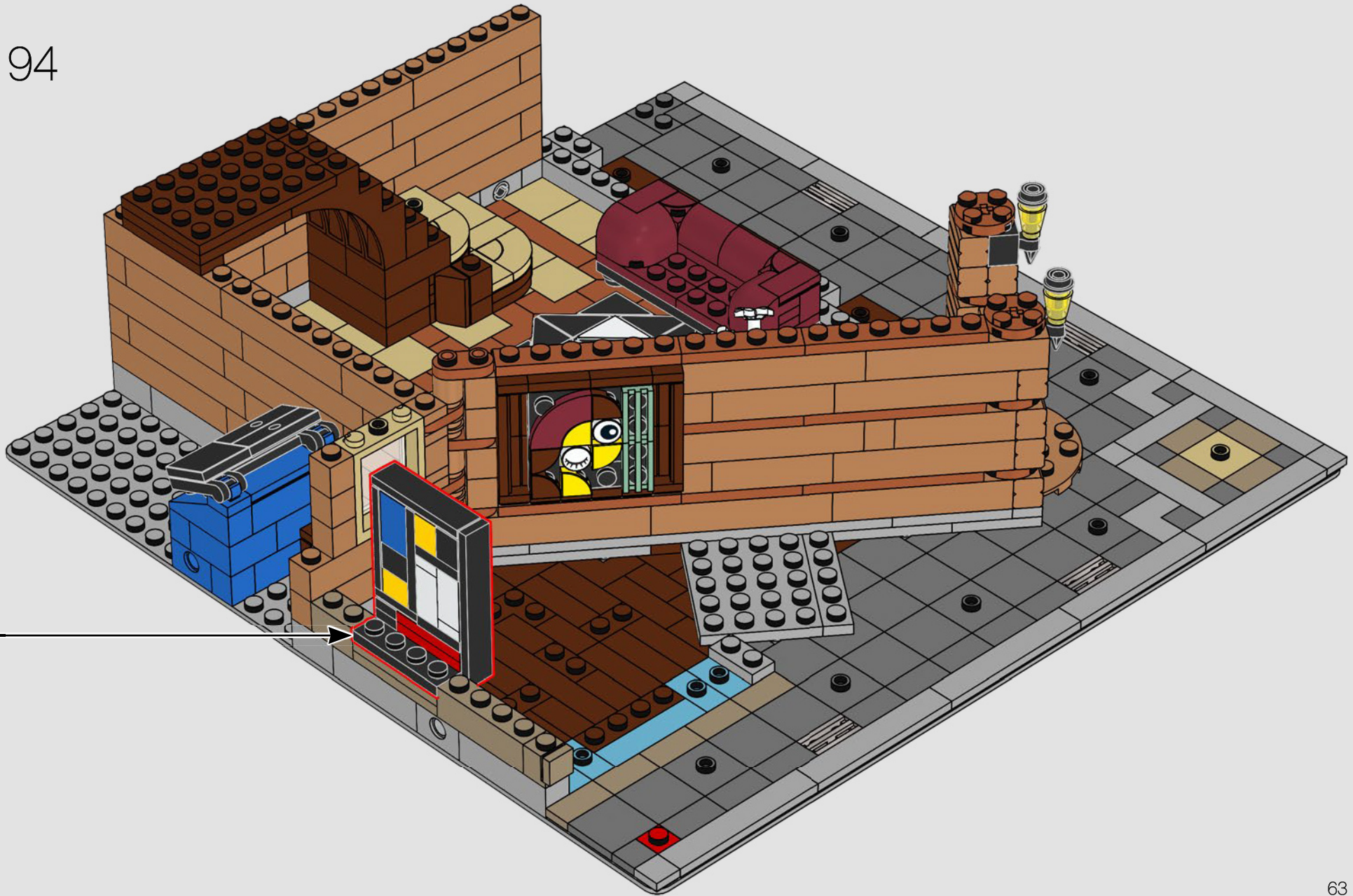

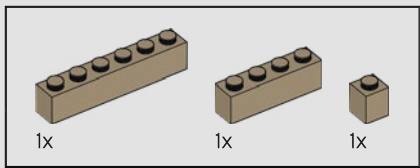

95

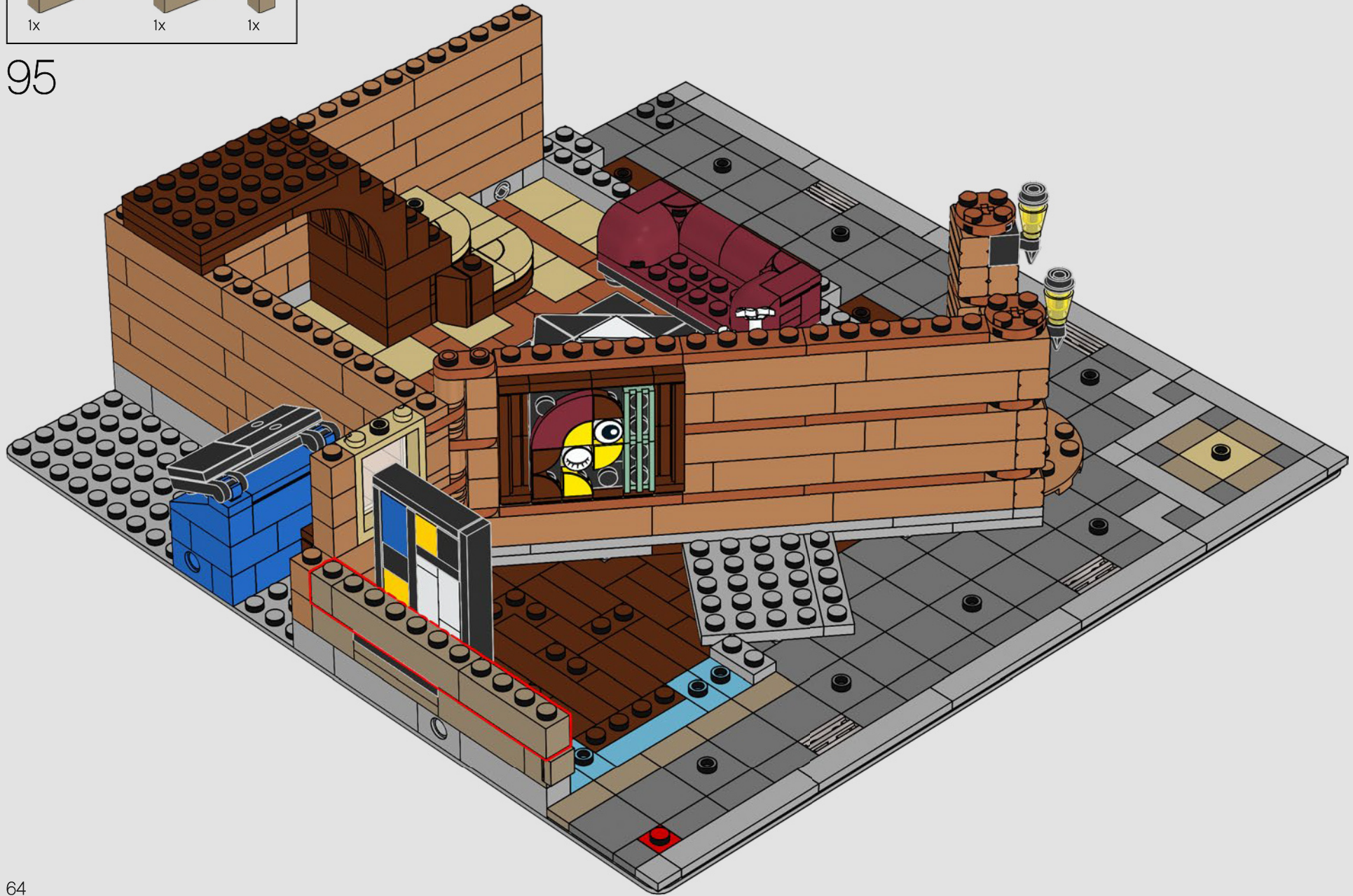



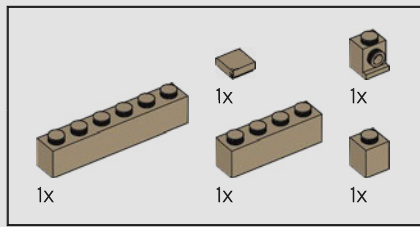

96

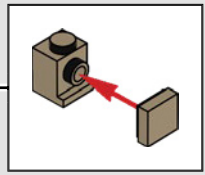
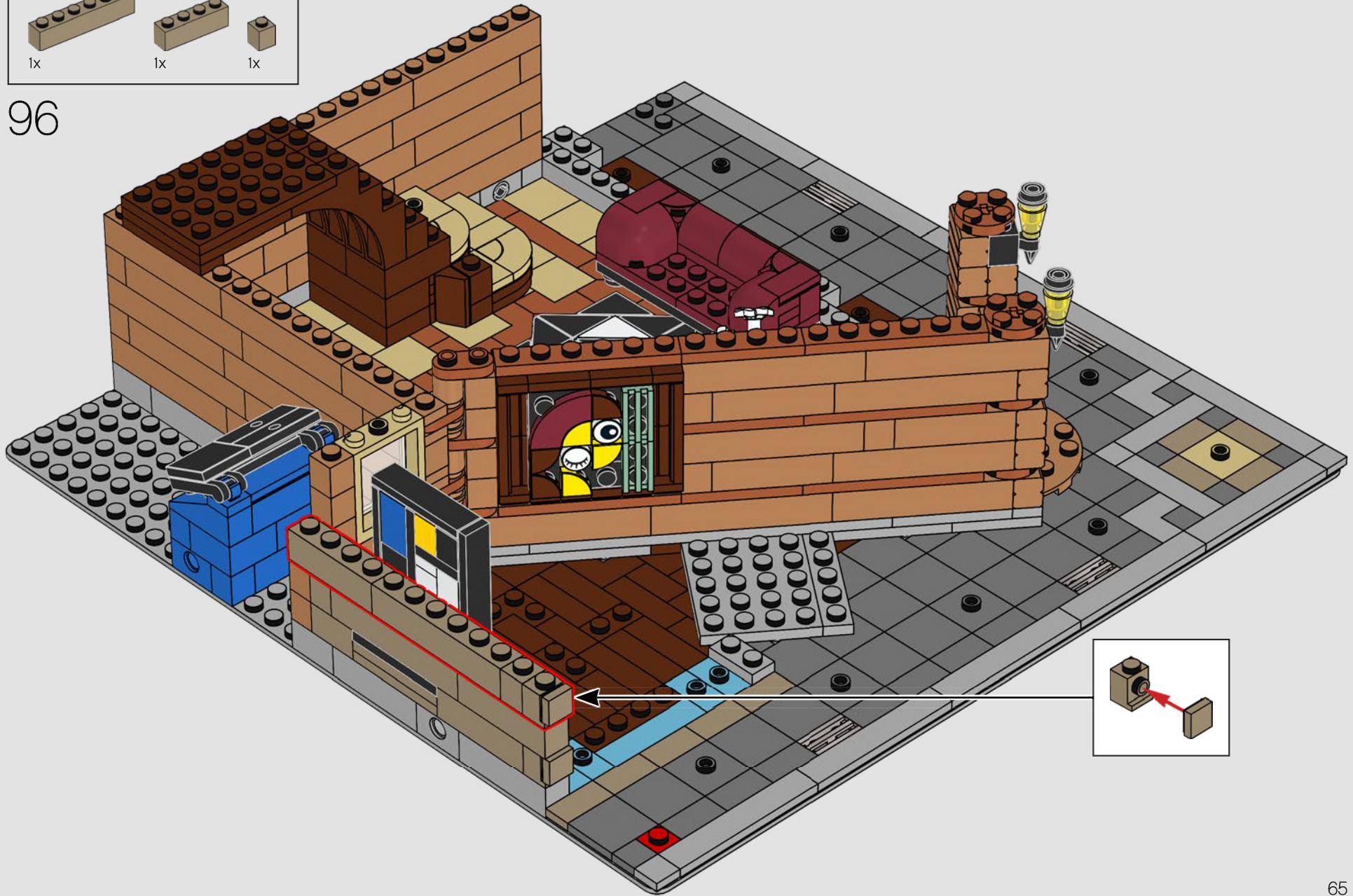

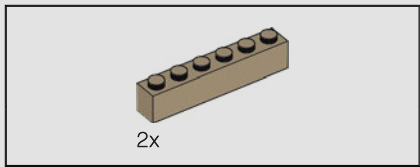

97

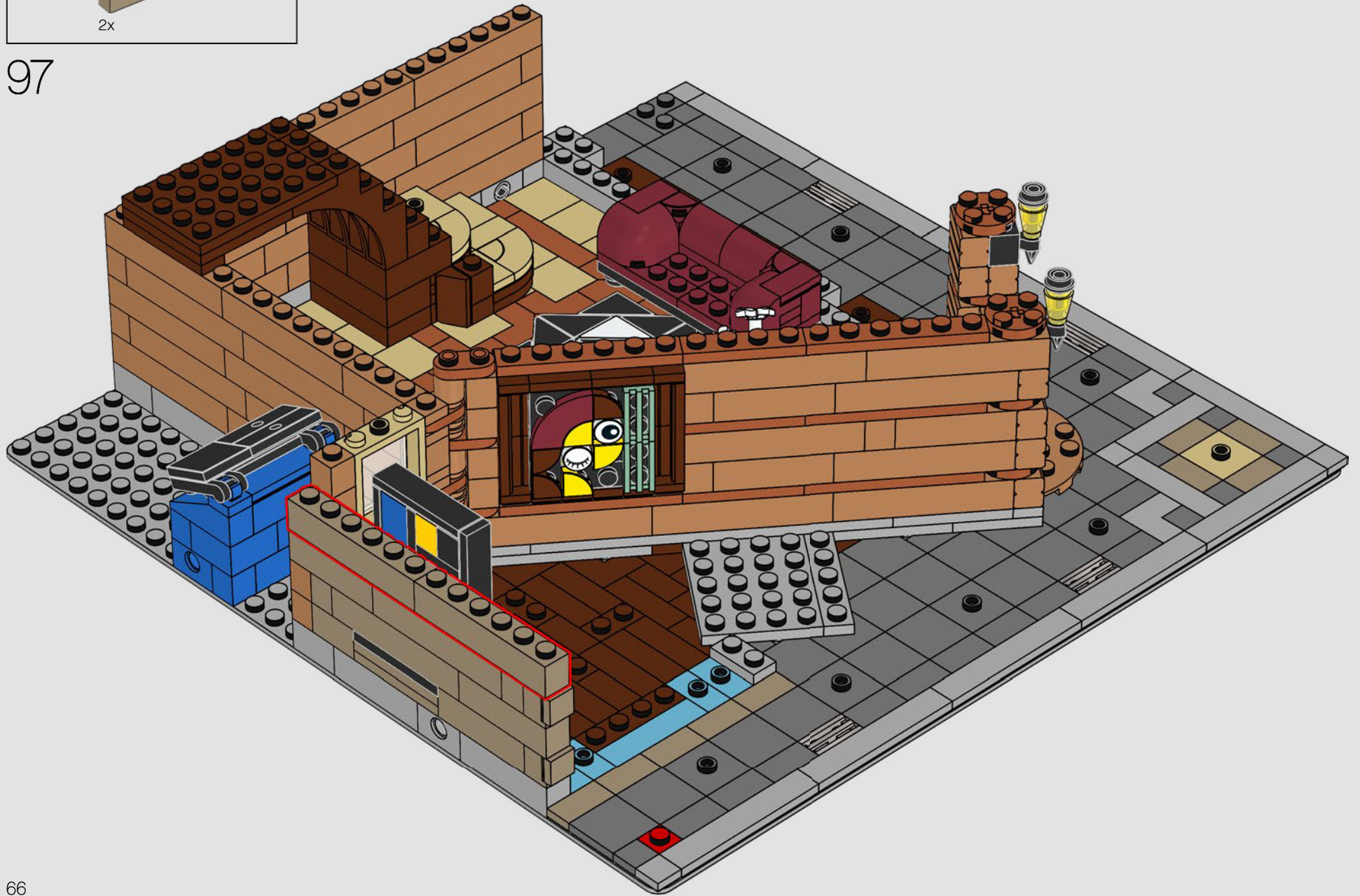

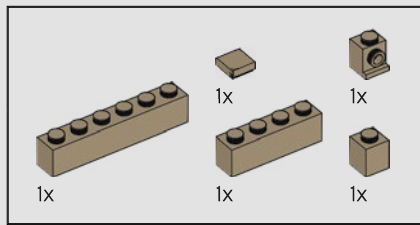

98

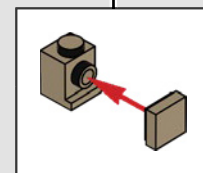
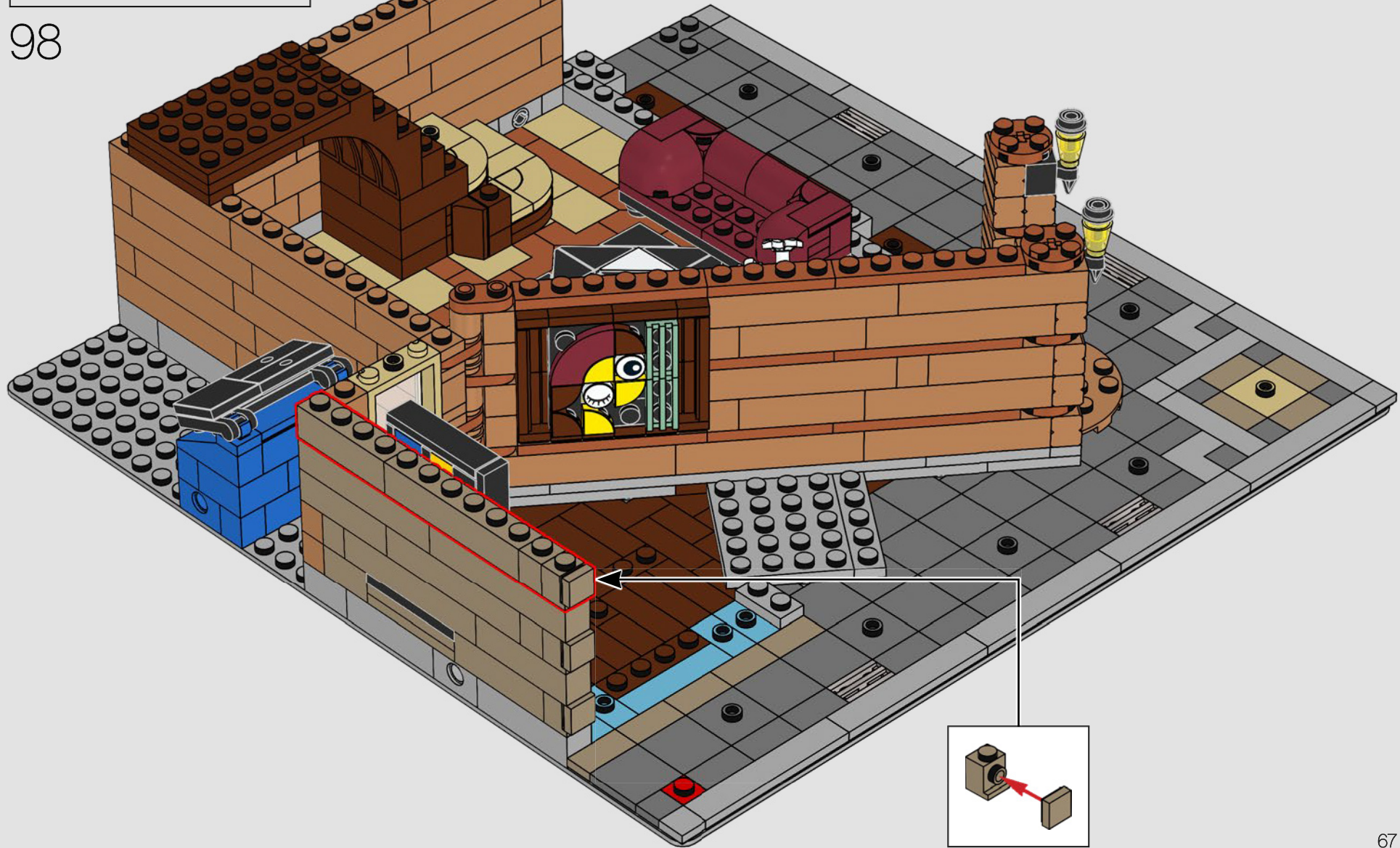

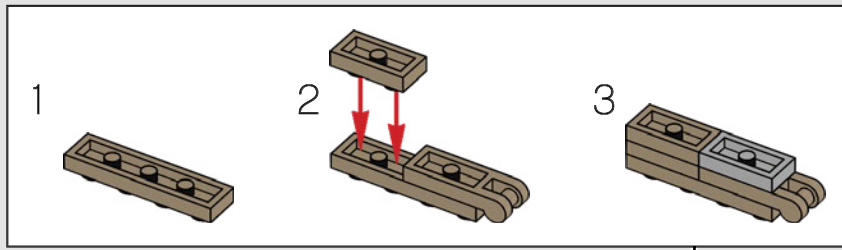
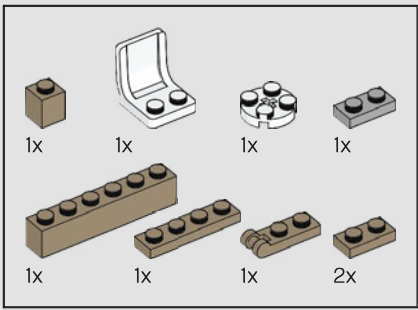

99



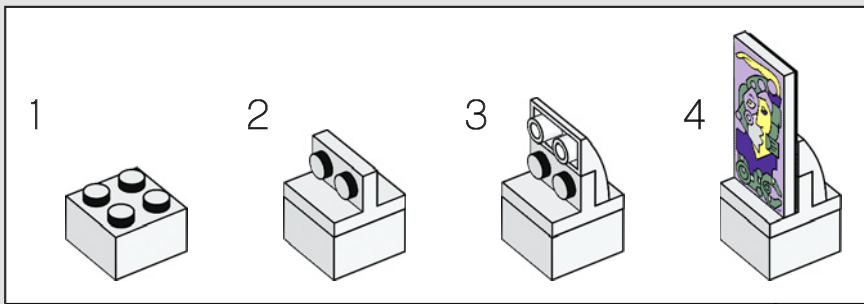
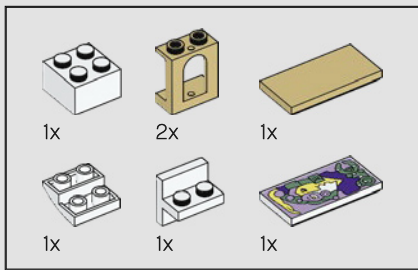

100

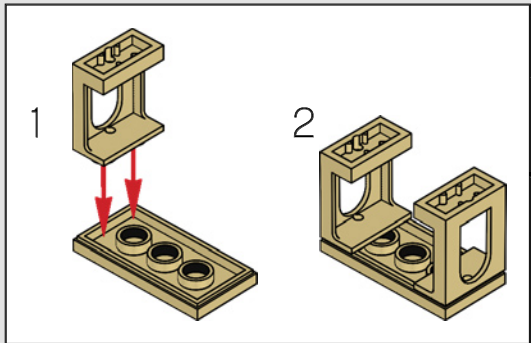

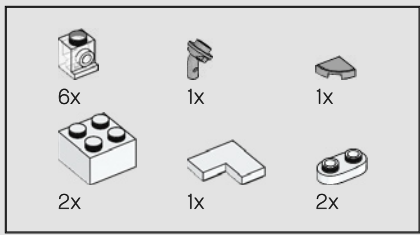

101

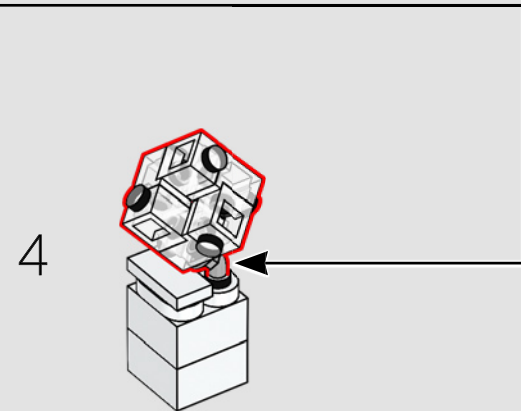
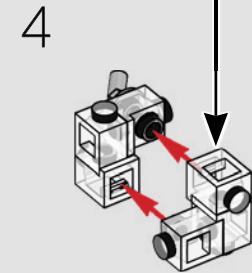
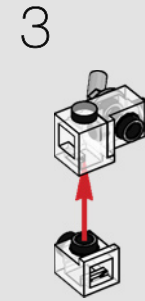
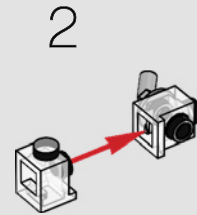
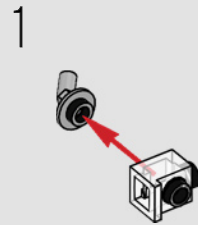
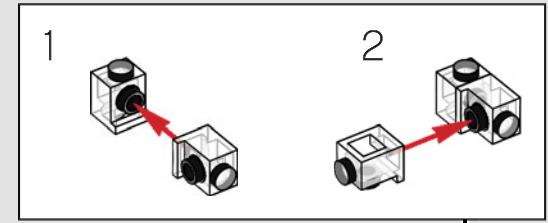
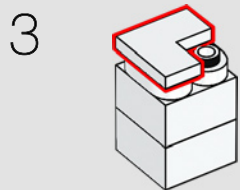
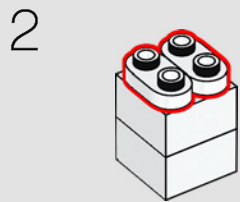
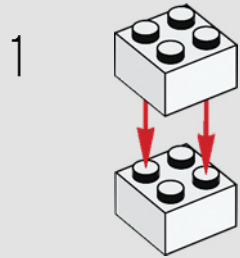

Die Galeristin freut sich schon auf die Vernissage mit ihren kubistischen Kunstwerken. Ihr Lieblingsstück ist jedoch kein kubistisches Werk, sondern ein akribisch gefertigter Kubus.

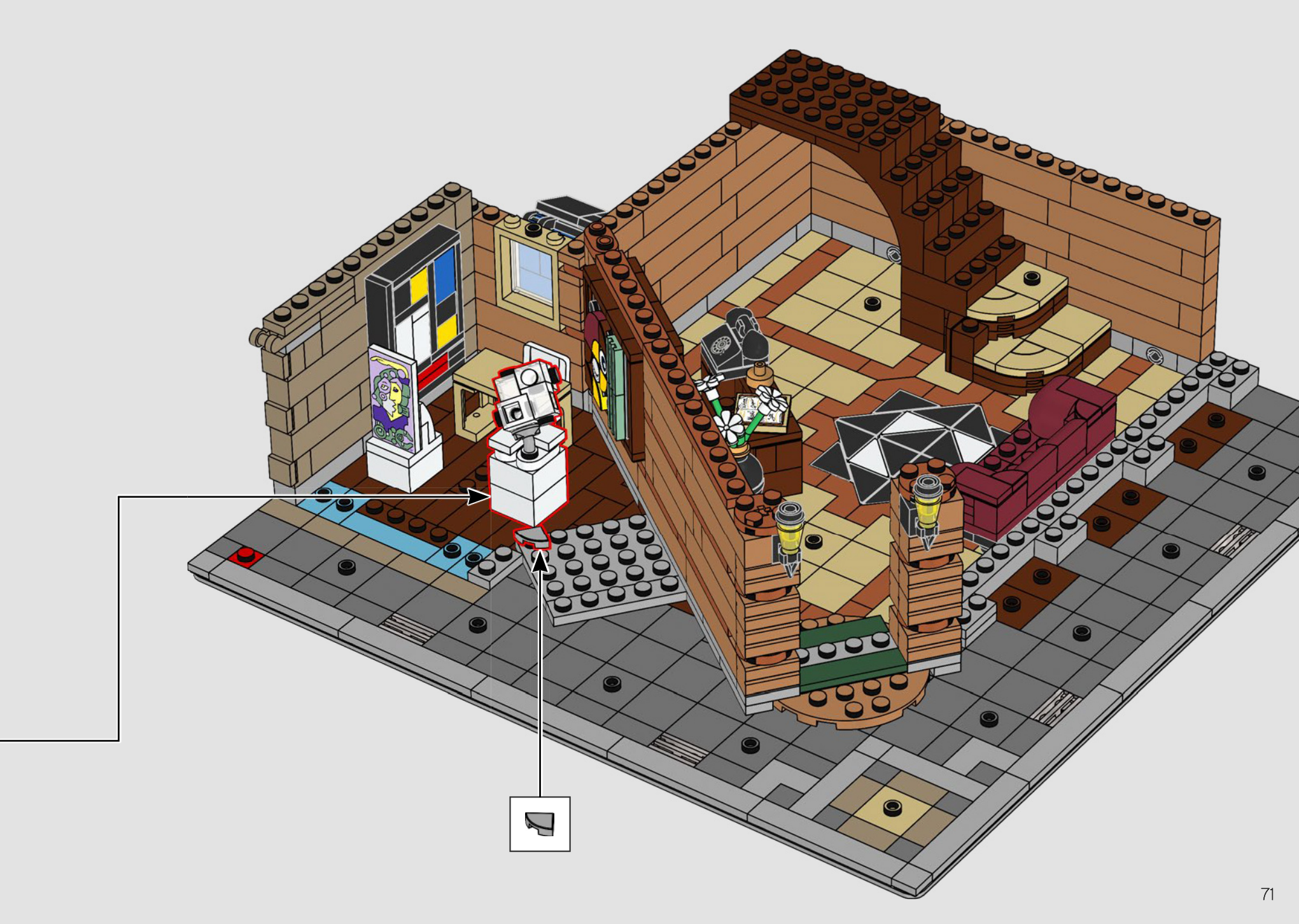

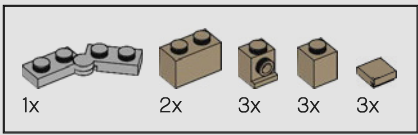

102

1

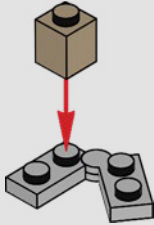

2

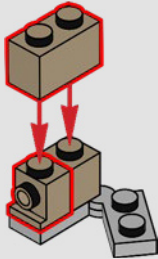

3

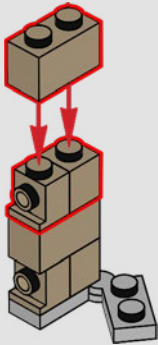

4

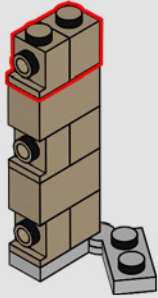

5

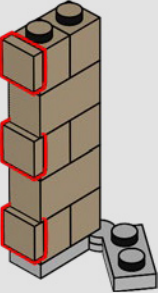



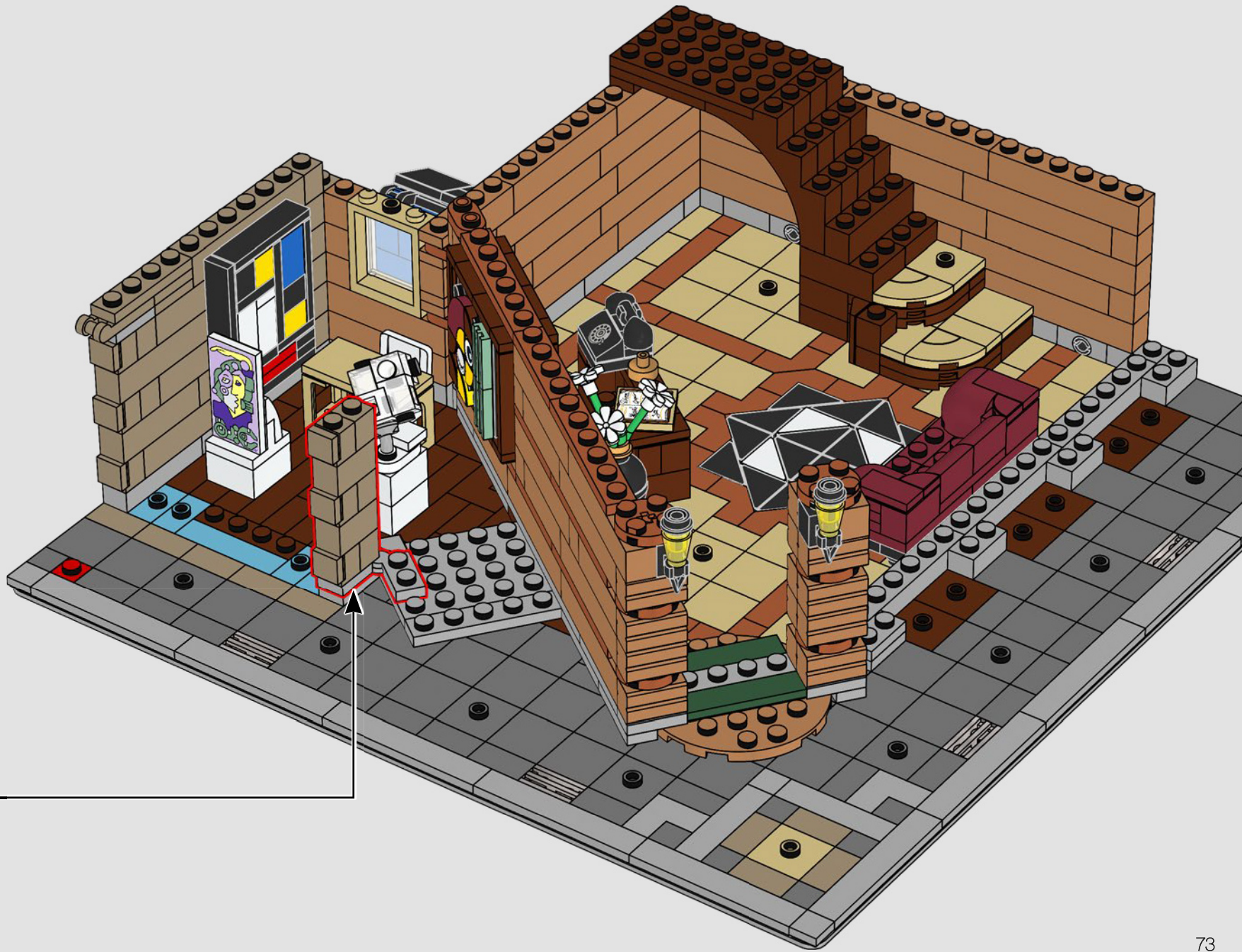

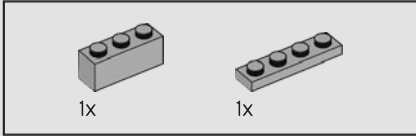
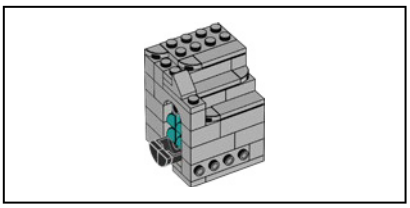

103

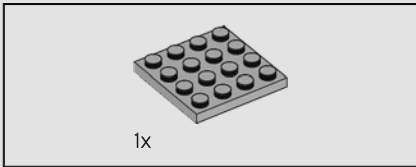
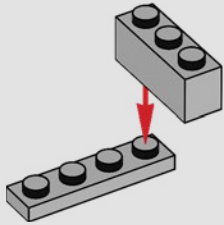

104

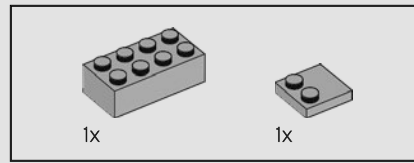
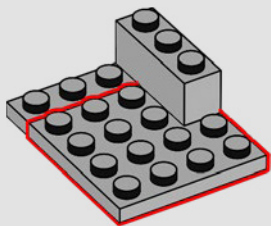

105

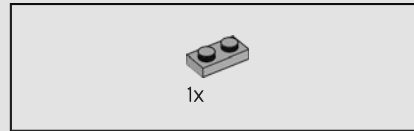
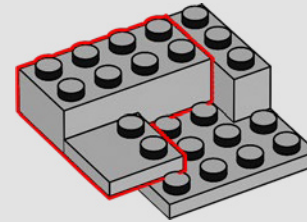

106

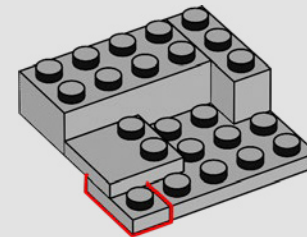

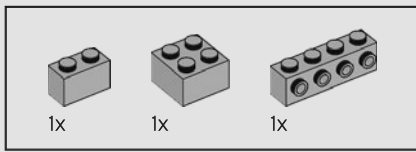

107

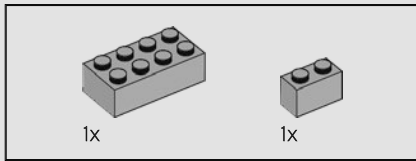
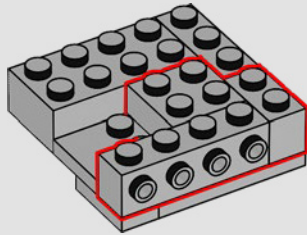

108

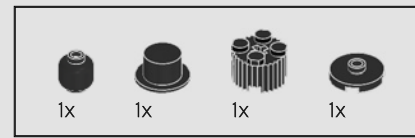
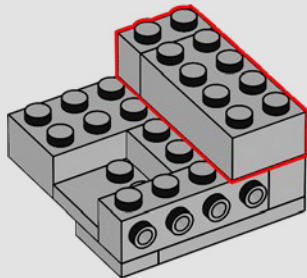

109

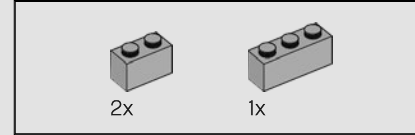
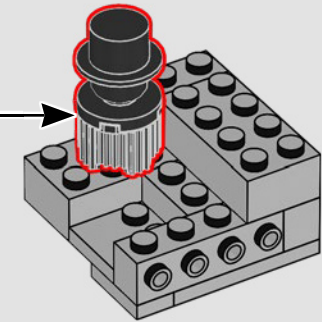
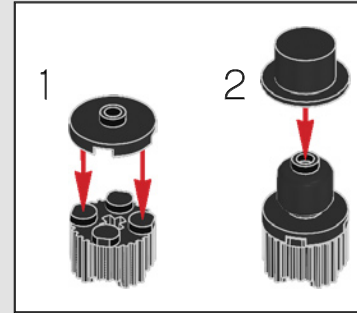

110

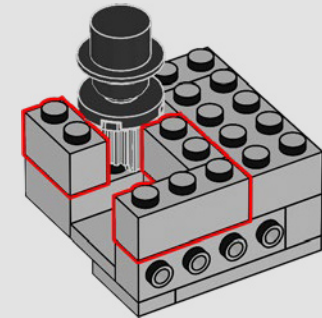

Diese Büste stammt von demselben Künstler, der auch die weiße Büste im Foyer des „Rathauses“ (10224) erschaffen hat.

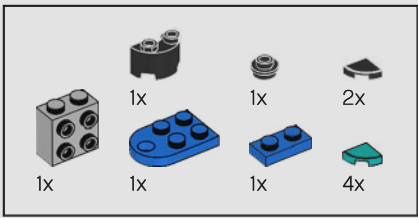

111

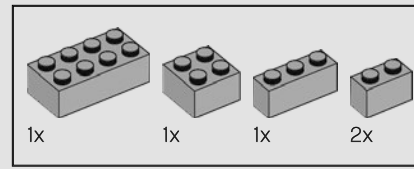
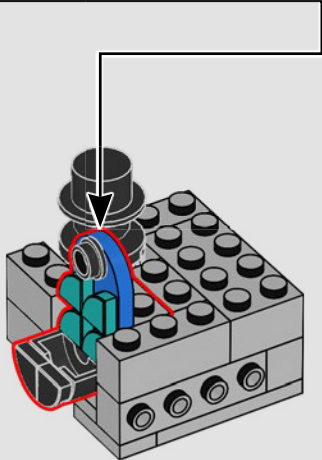
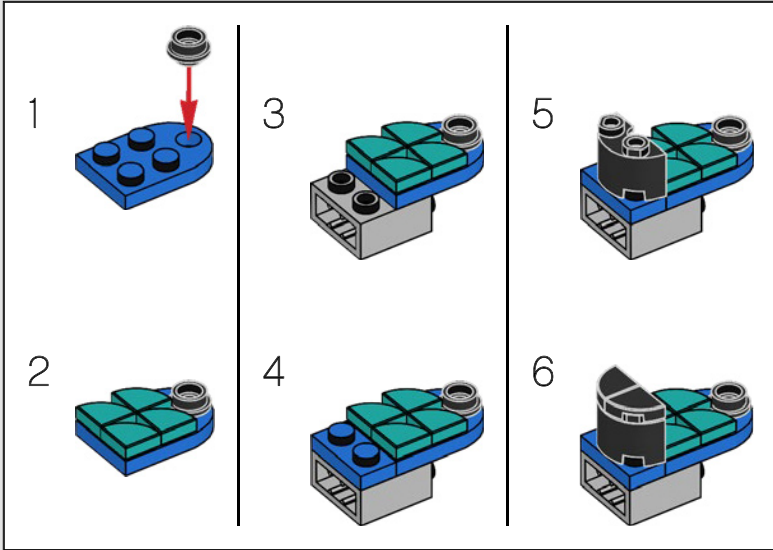

112

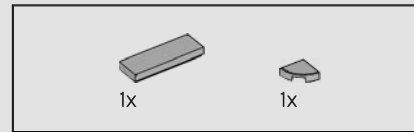
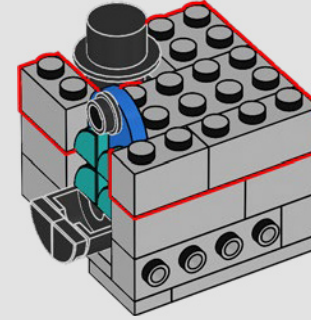

113

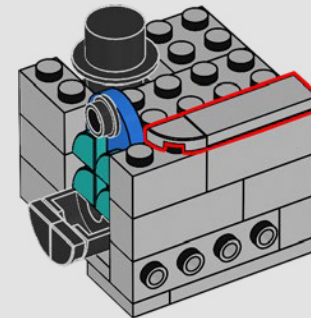

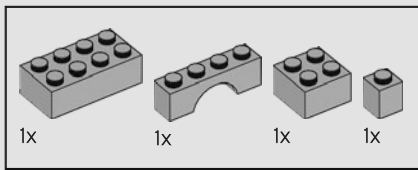

114

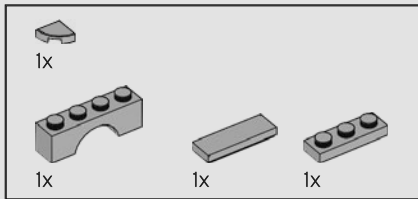
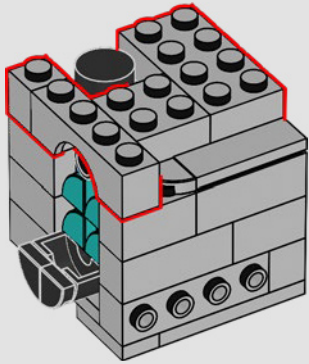

115

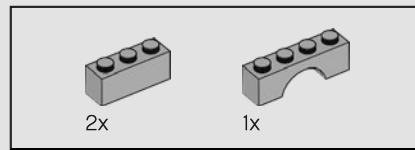
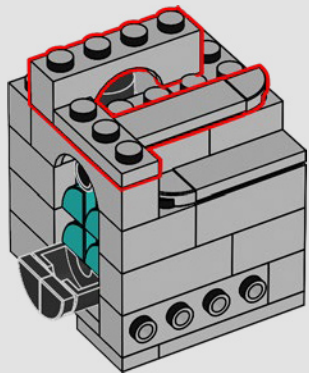

116

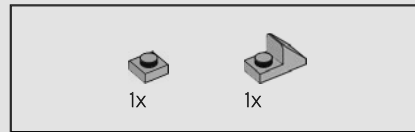
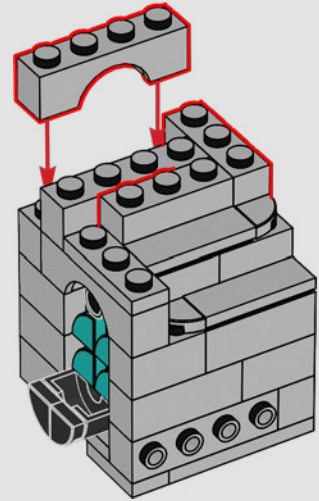

117

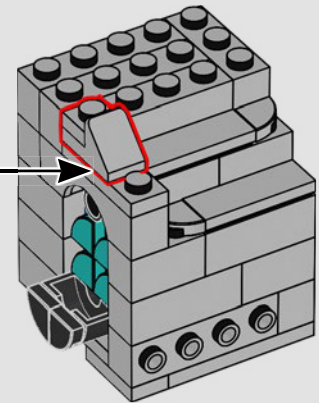
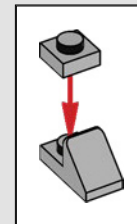

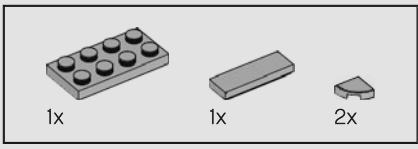

118

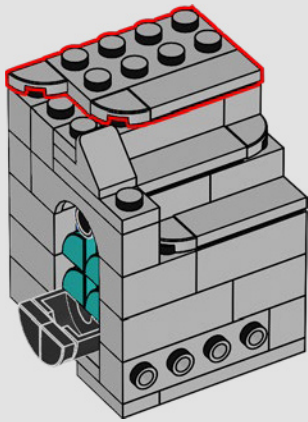

119

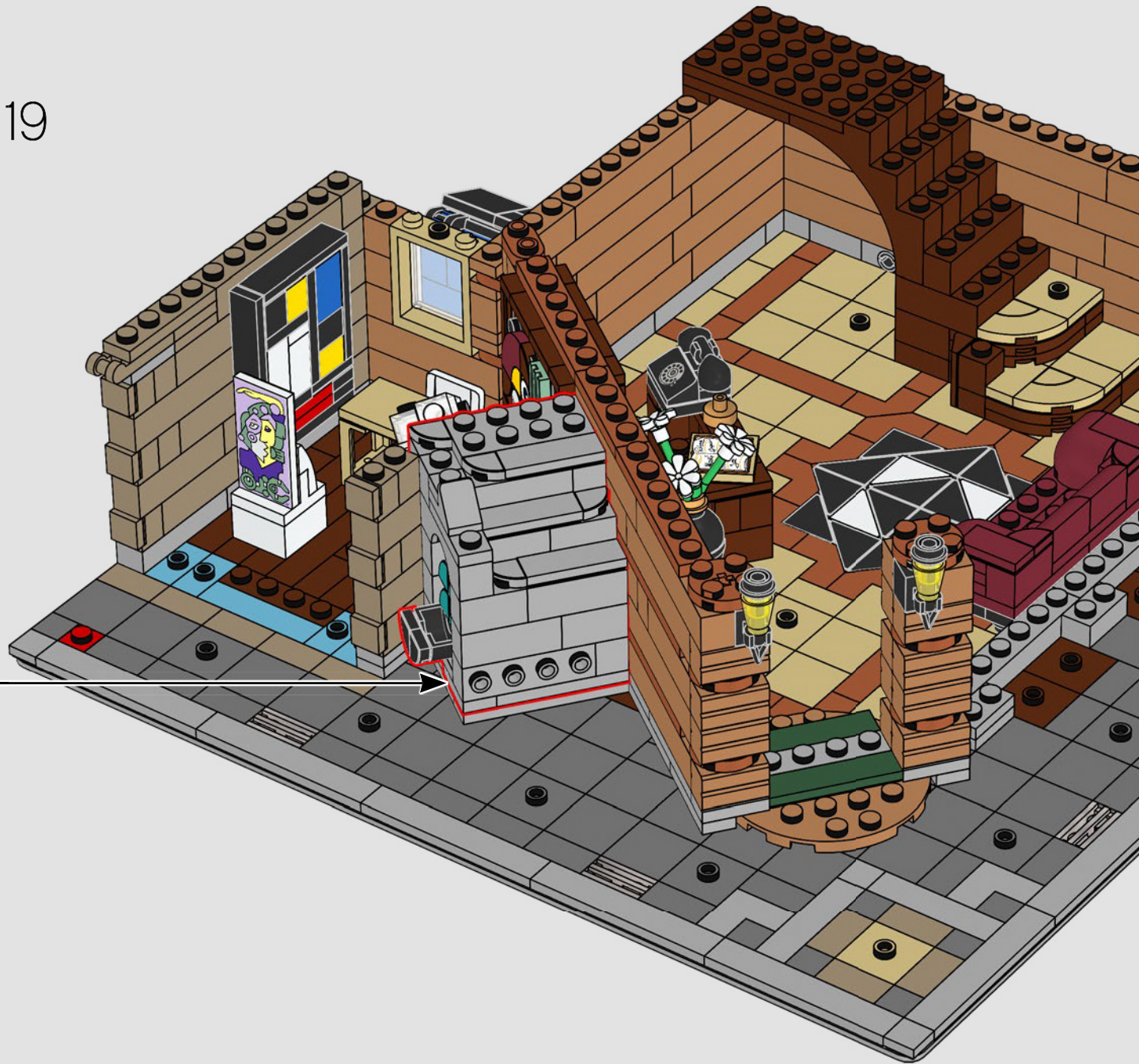

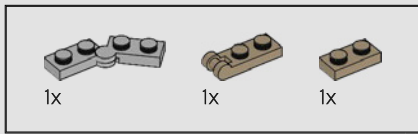

120

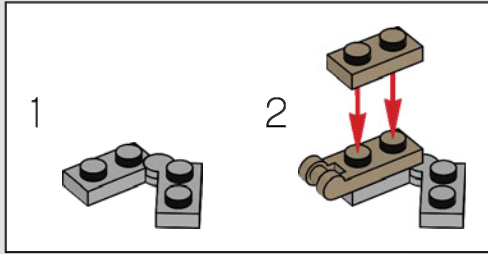

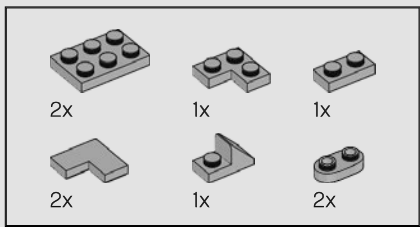

121

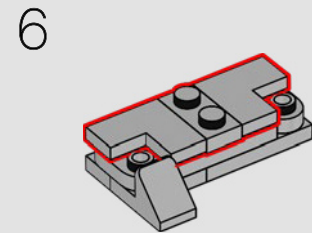
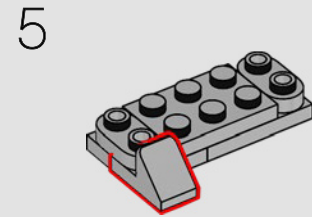
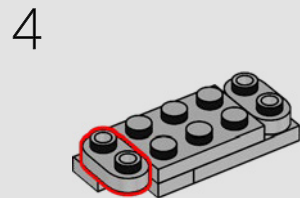
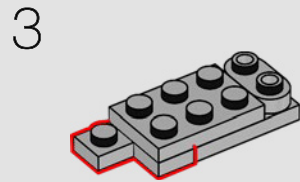
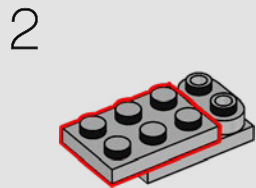
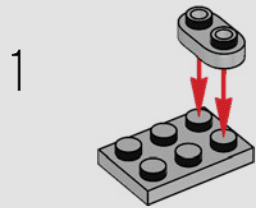





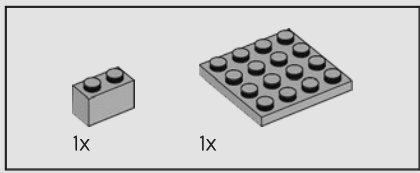

122

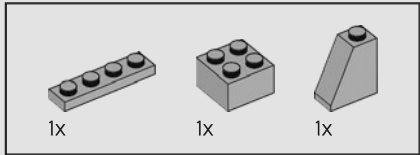
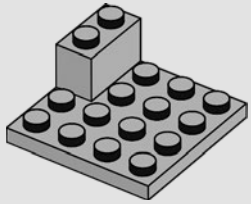

123

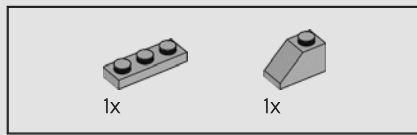
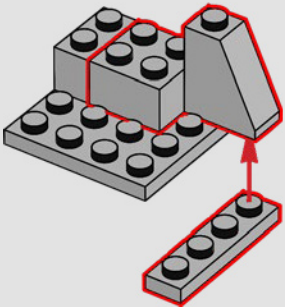

124

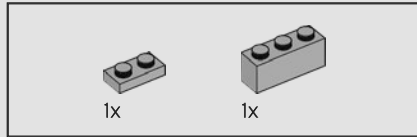
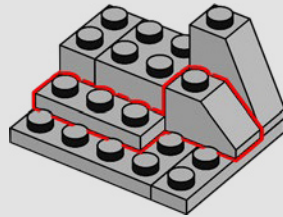

125

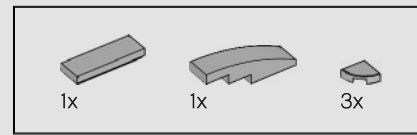
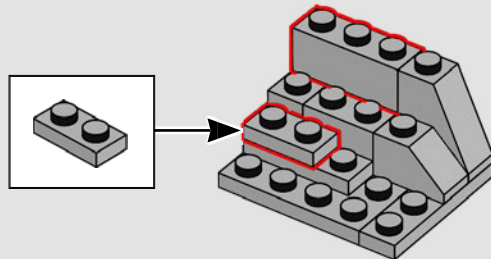

126

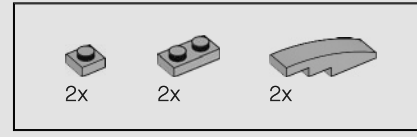
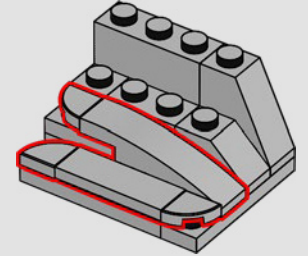

127

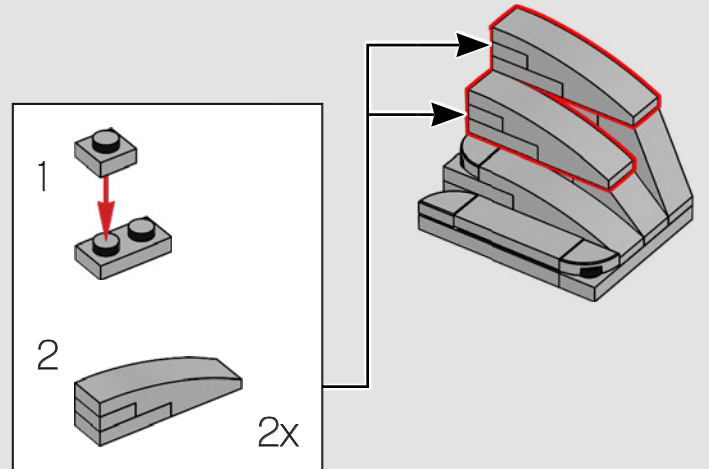

128

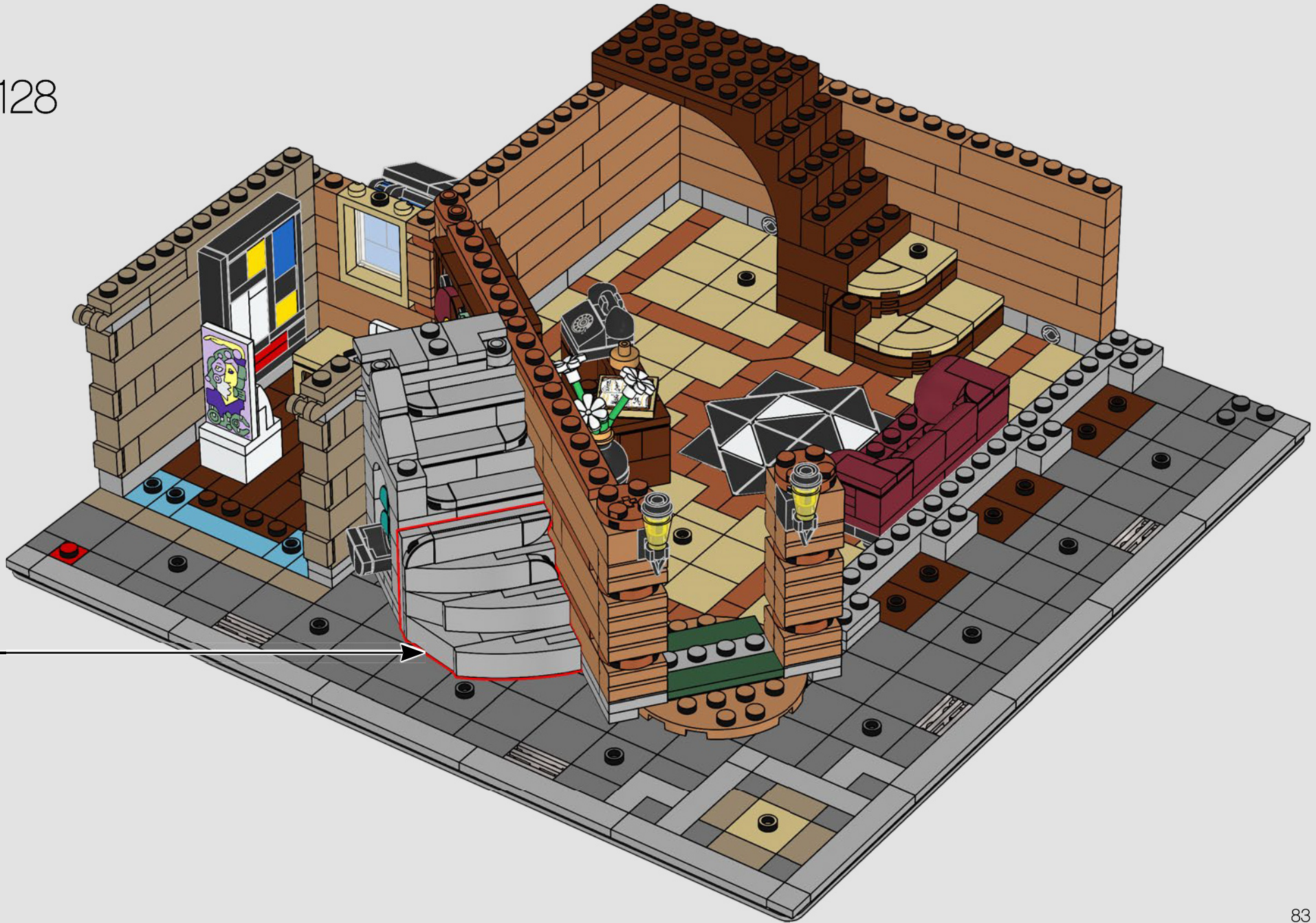

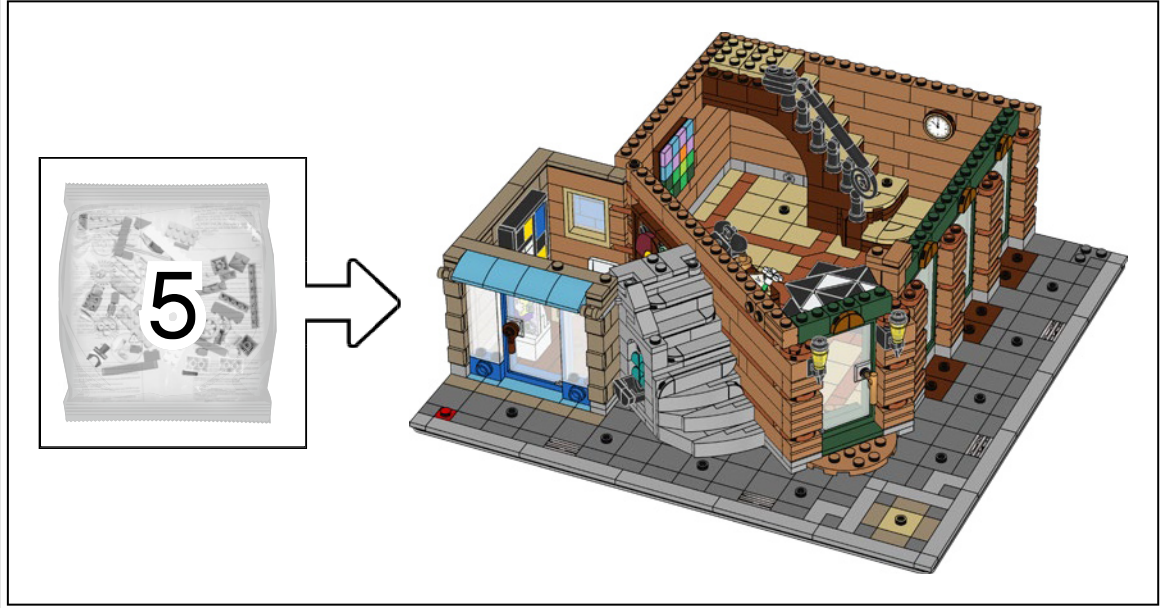

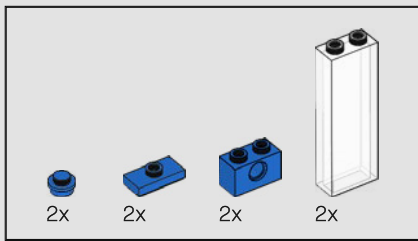

129

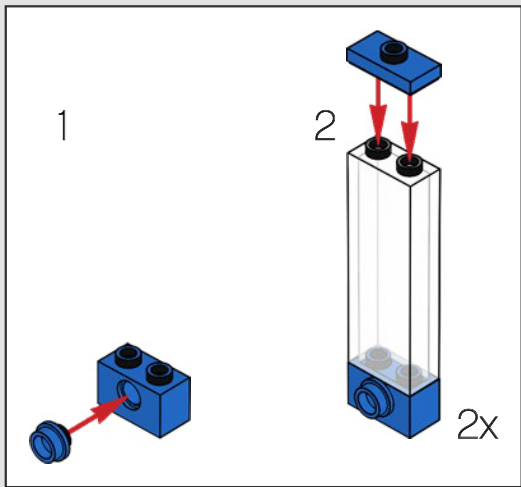

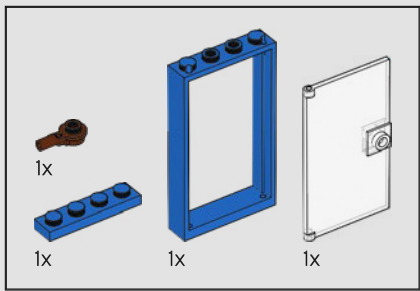

130

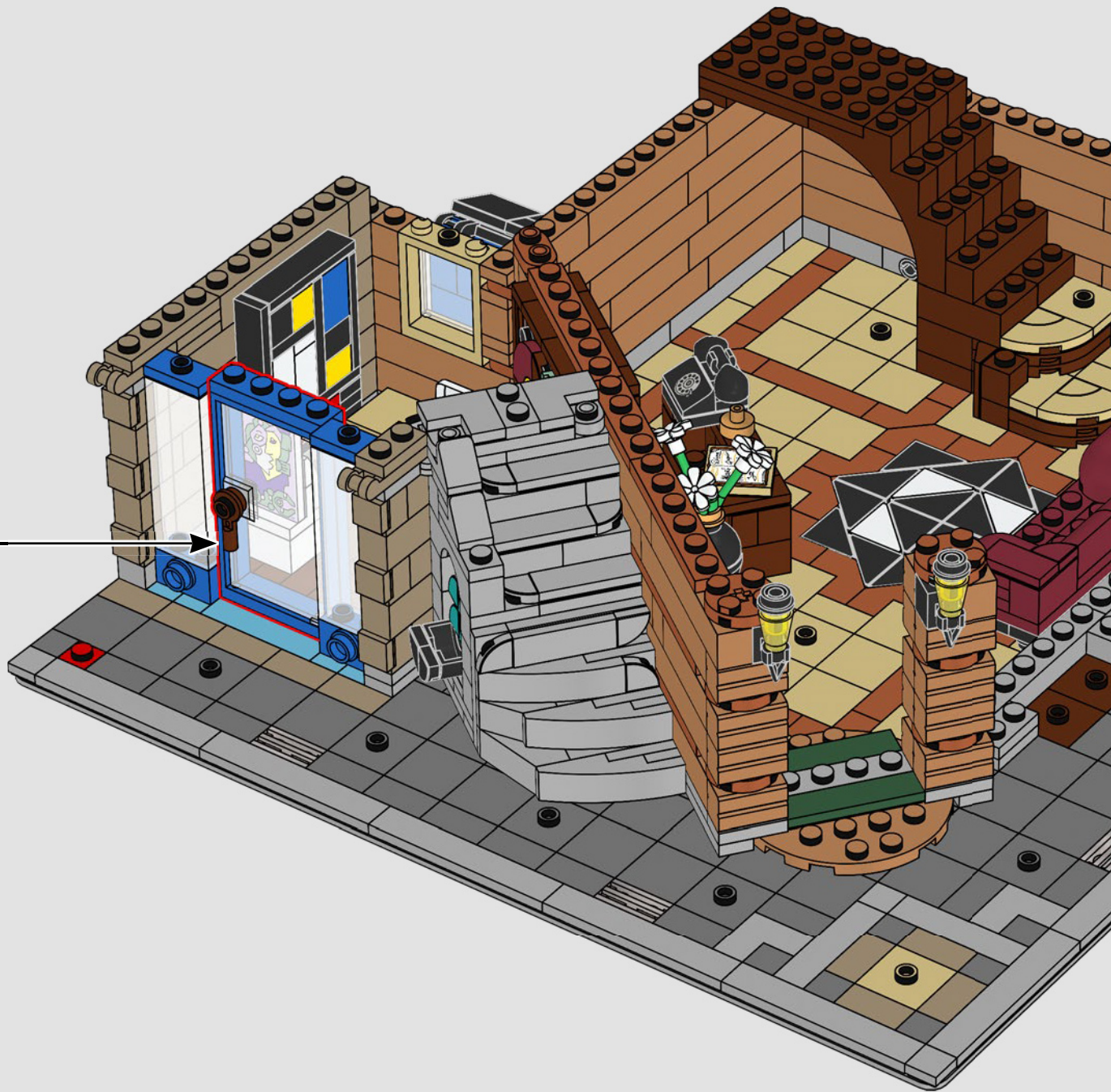
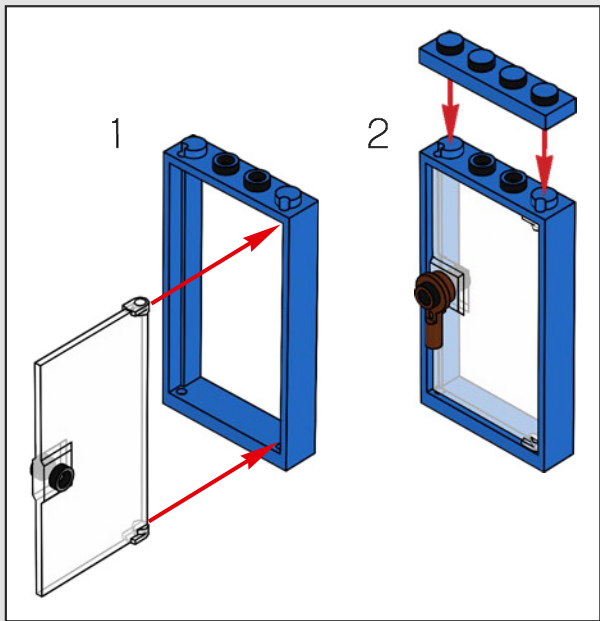

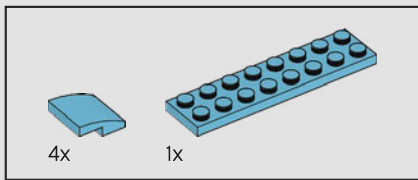

131

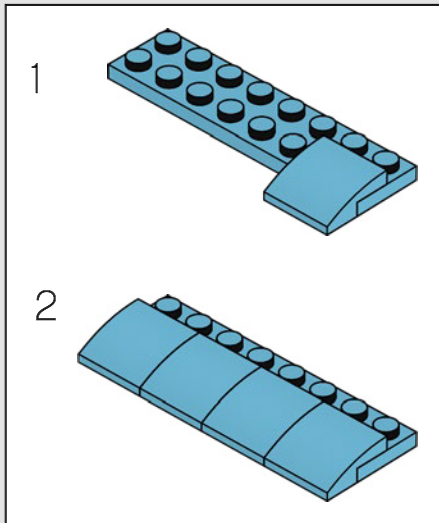

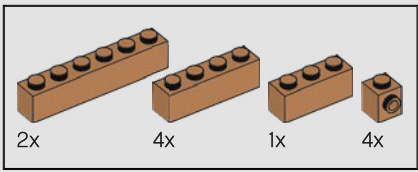

132





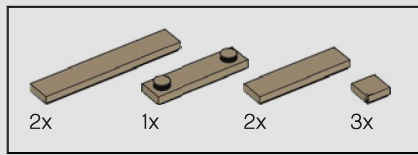

133



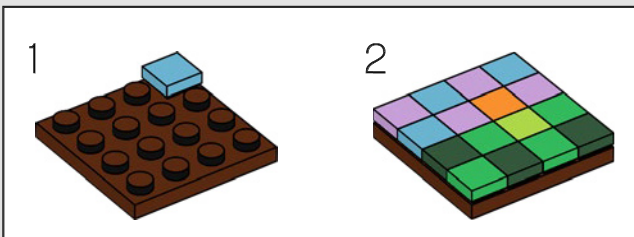
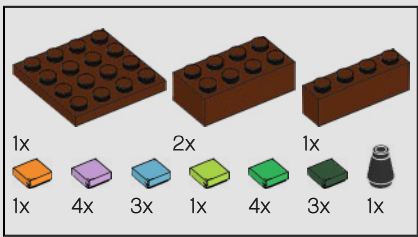

Dieses Gemälde stammt von dem Künstler, dessen Atelier sich im Loft über dem „Pariser Restaurant“ (10243) befindet.

134



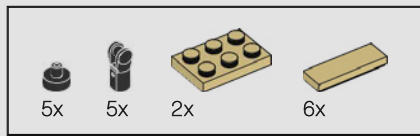

135

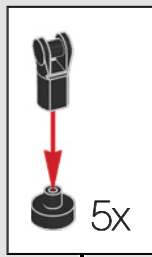



136

- 1
- 2
- 3
- 4



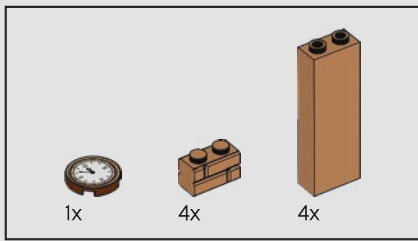

137

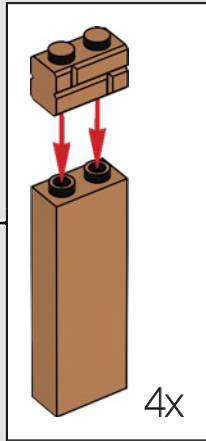

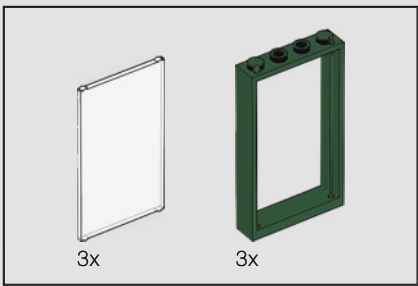

138

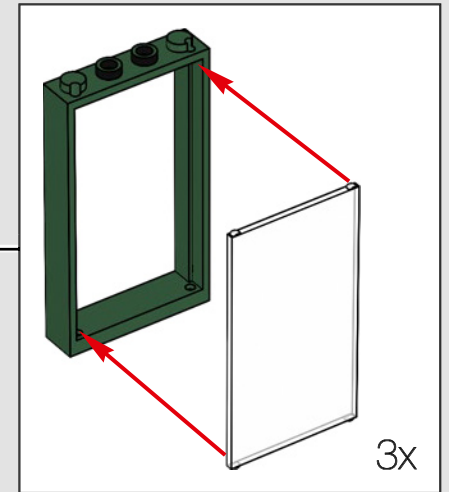

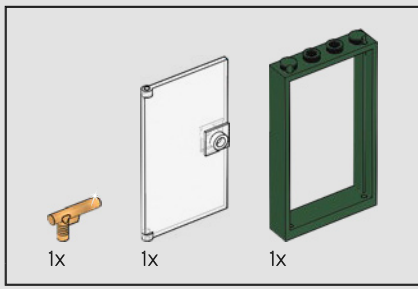

139

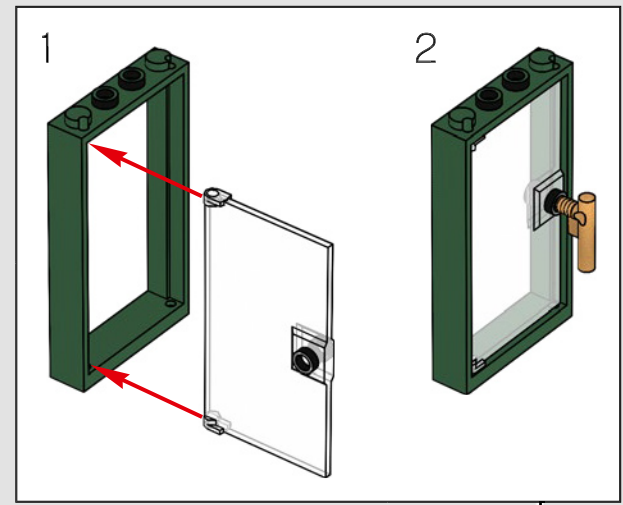

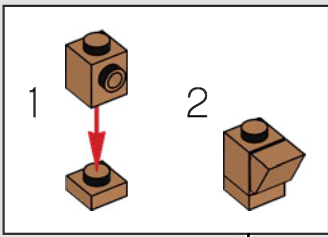
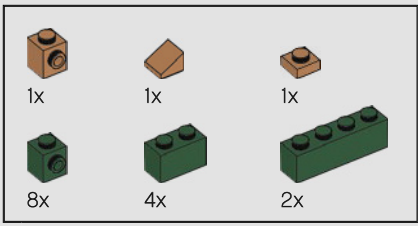

140







141



-  12x
-  20x
-  1x
-  1x
-  1x

142

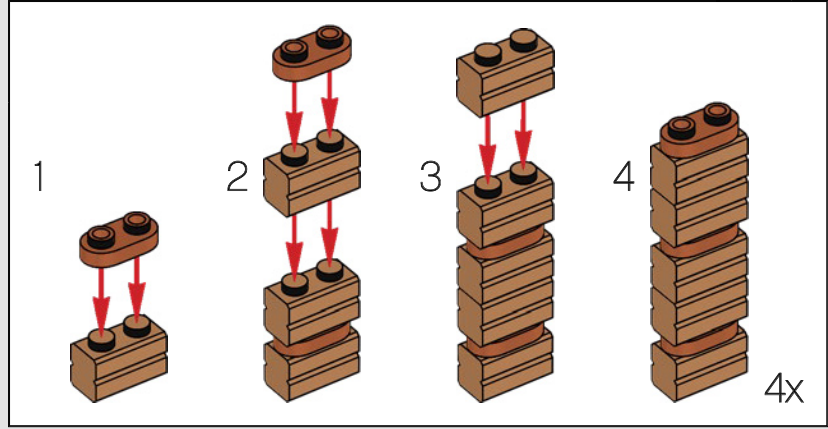
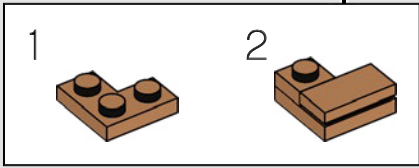

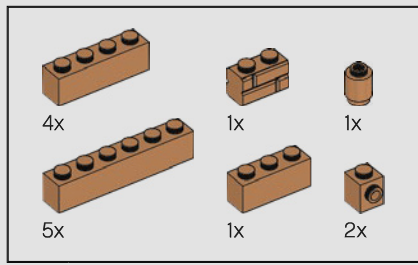

143



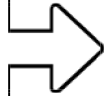

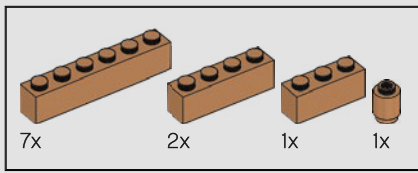

144



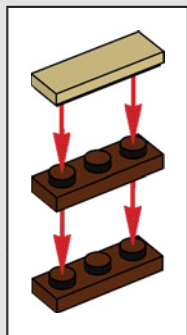
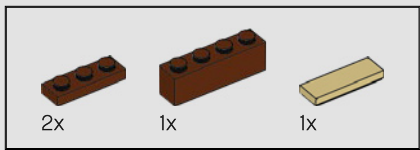

145



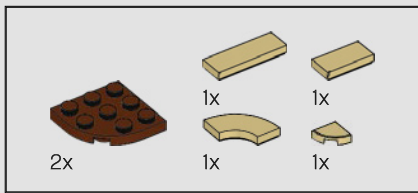

146

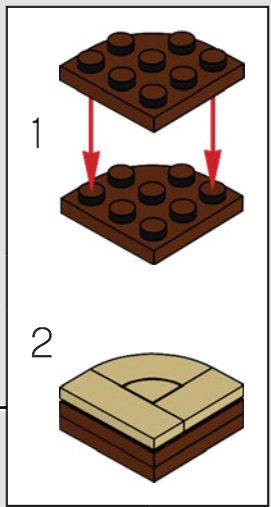

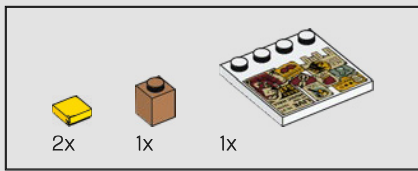

147

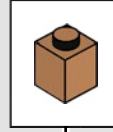
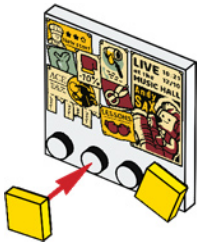
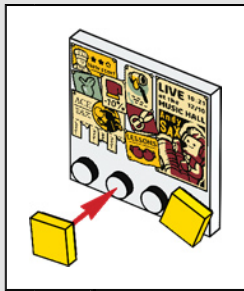

Die Zettel an dieser Pinnwand werben für Produkte und Dienste, die in früheren Sets der Kollektion „Bauen mit Modulen“ erhältlich waren. Erkennst du die Anspielungen?





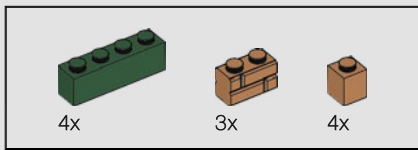

148

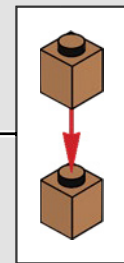

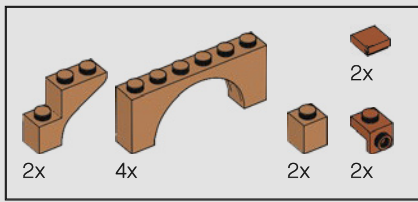

149

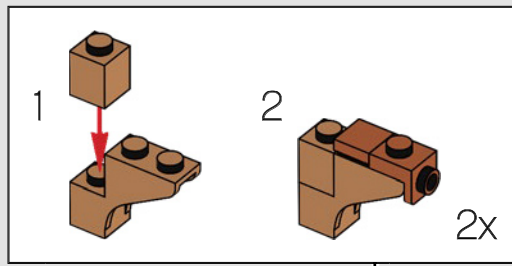

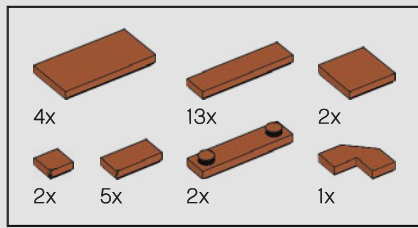

150



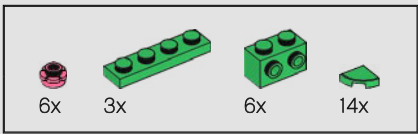

151

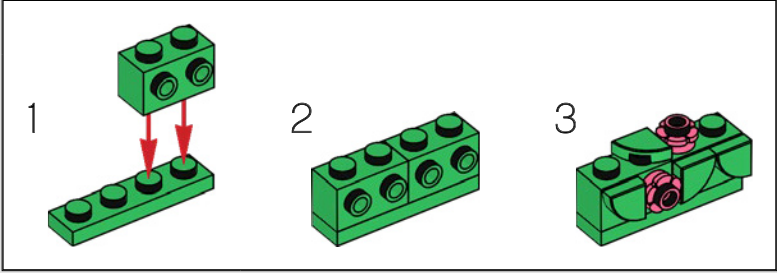
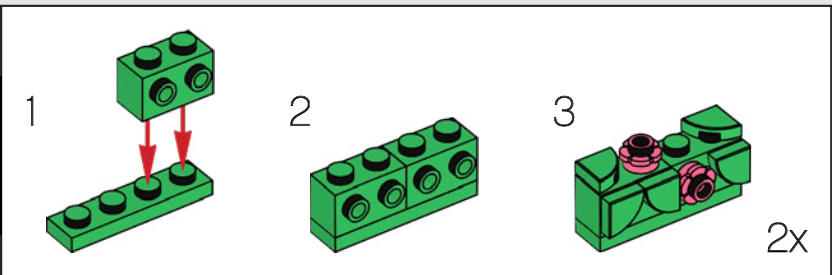

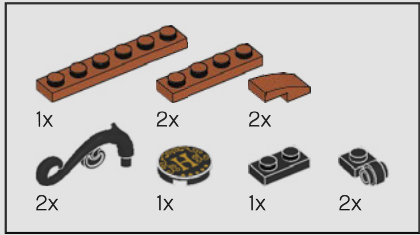
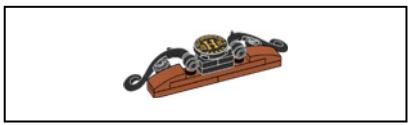

152

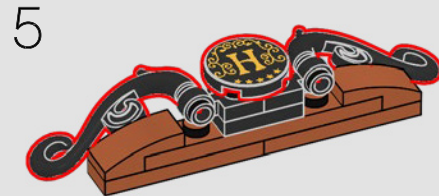
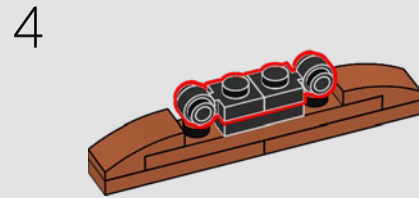
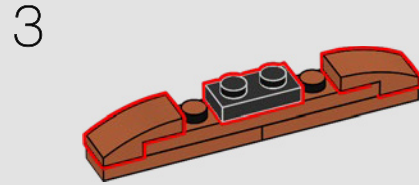
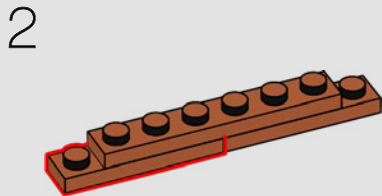
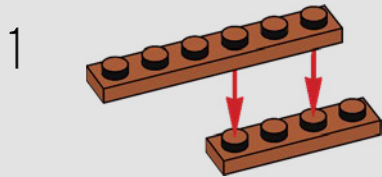



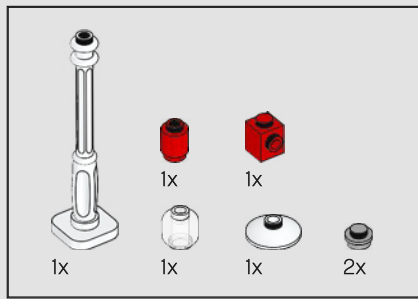

153

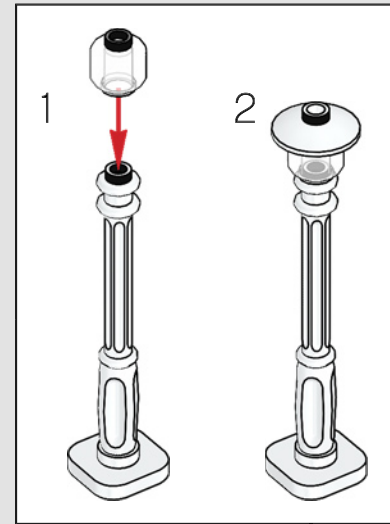
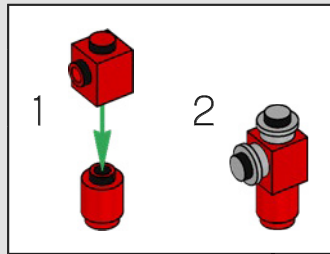

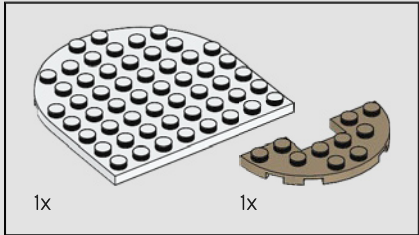
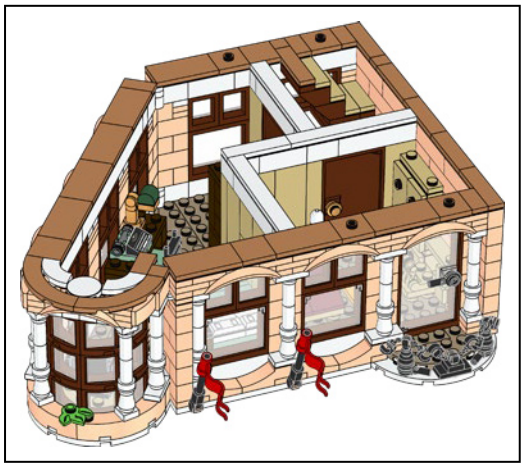
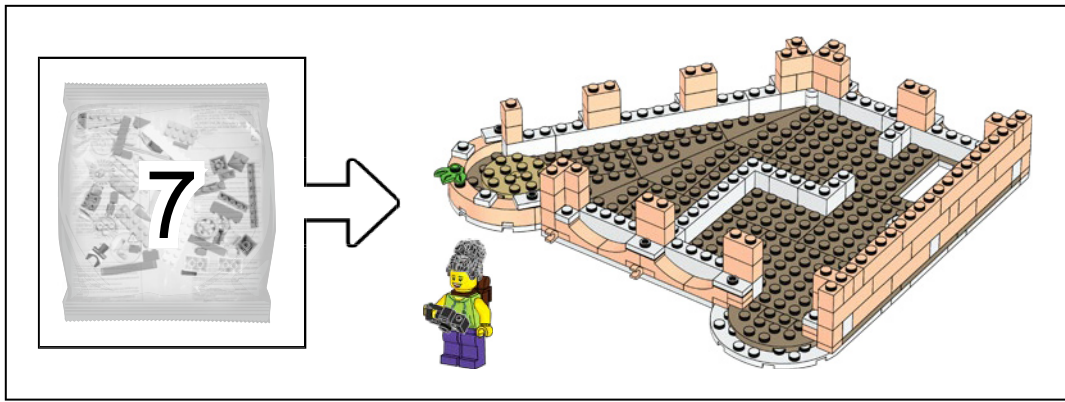

154

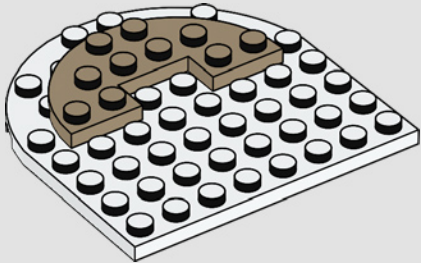
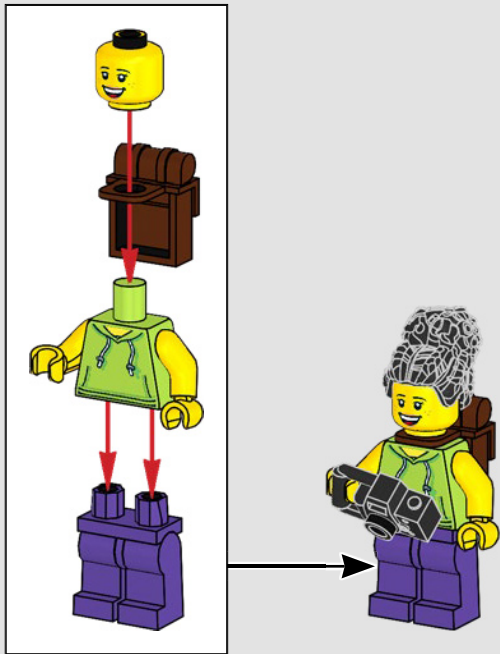

Die Rucksacktouristin reist um die ganze Welt!  
Wegen ihrer knappen Reisekasse muss sie im preisgünstigsten Zimmer des Hotels übernachten.



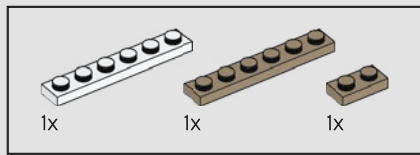

155

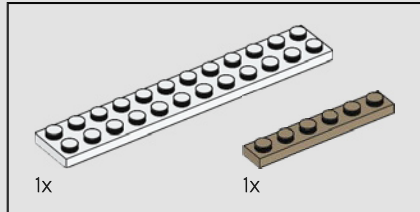
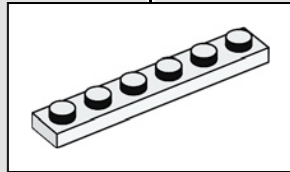
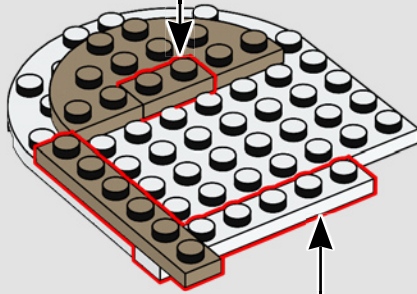
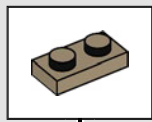

156

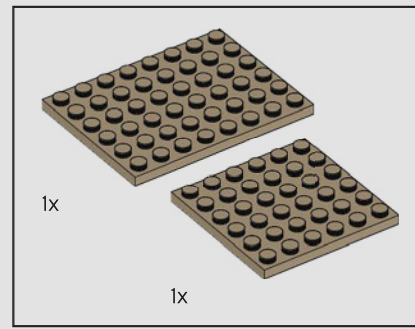
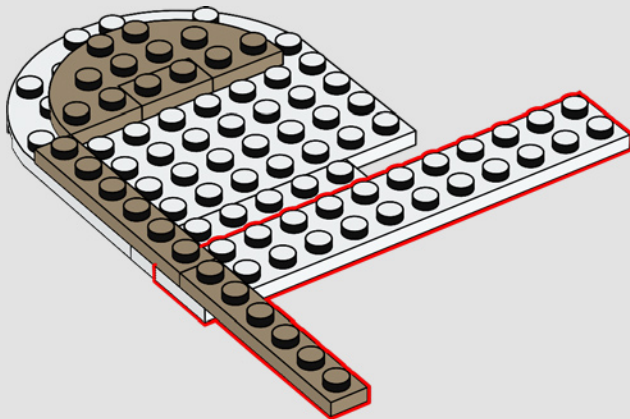

157

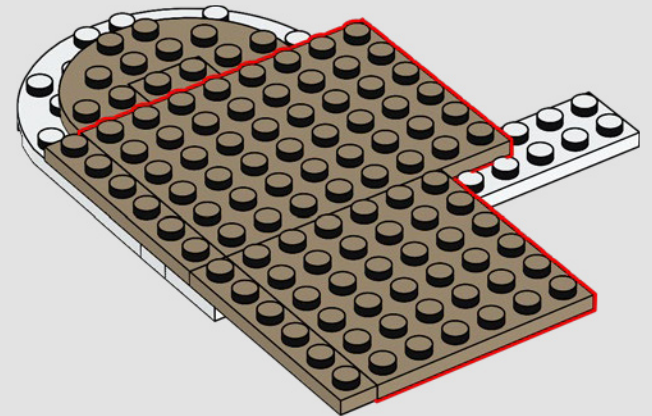

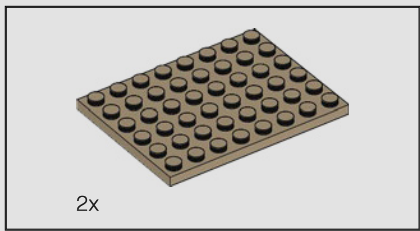

158

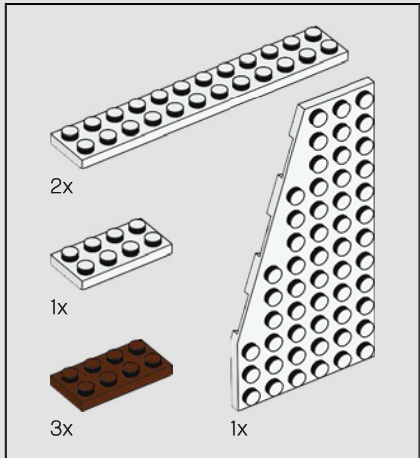
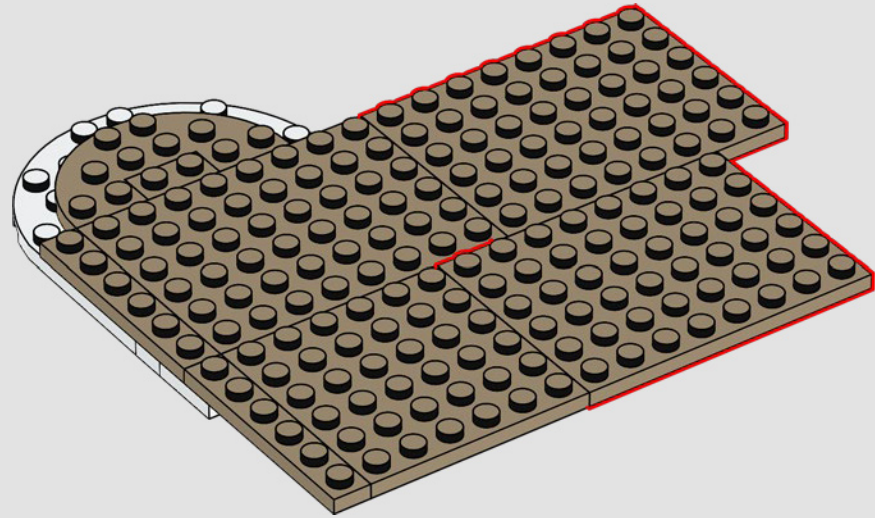

159

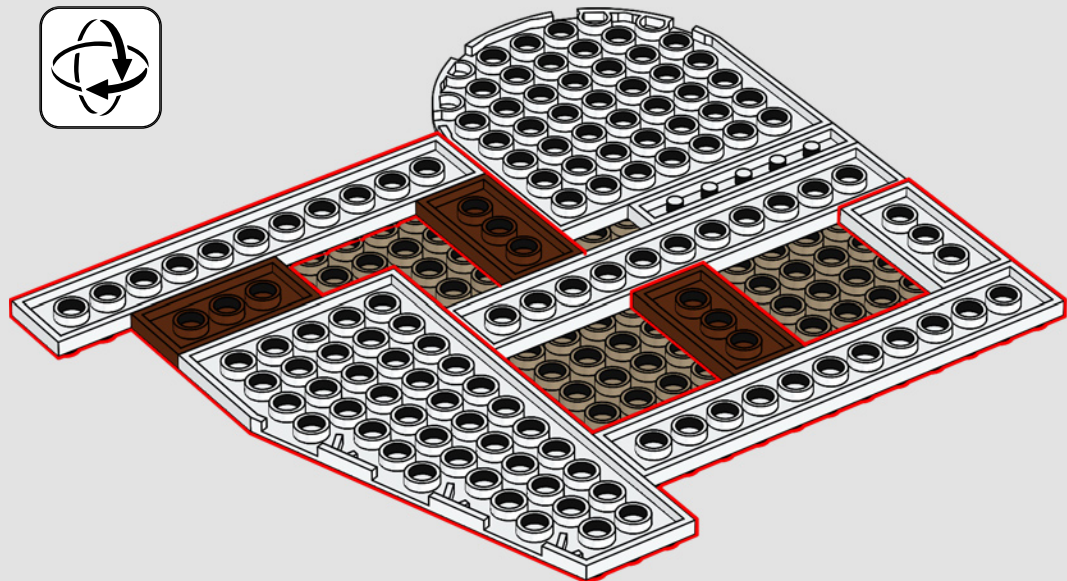
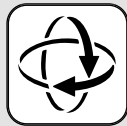

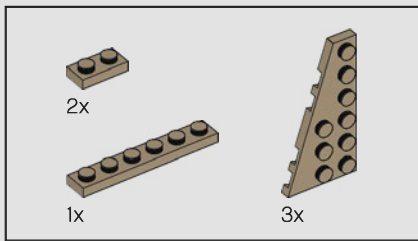

160

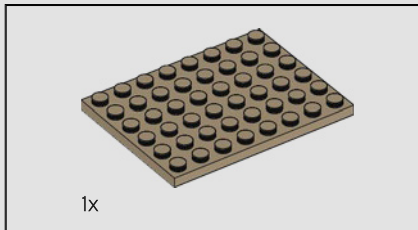
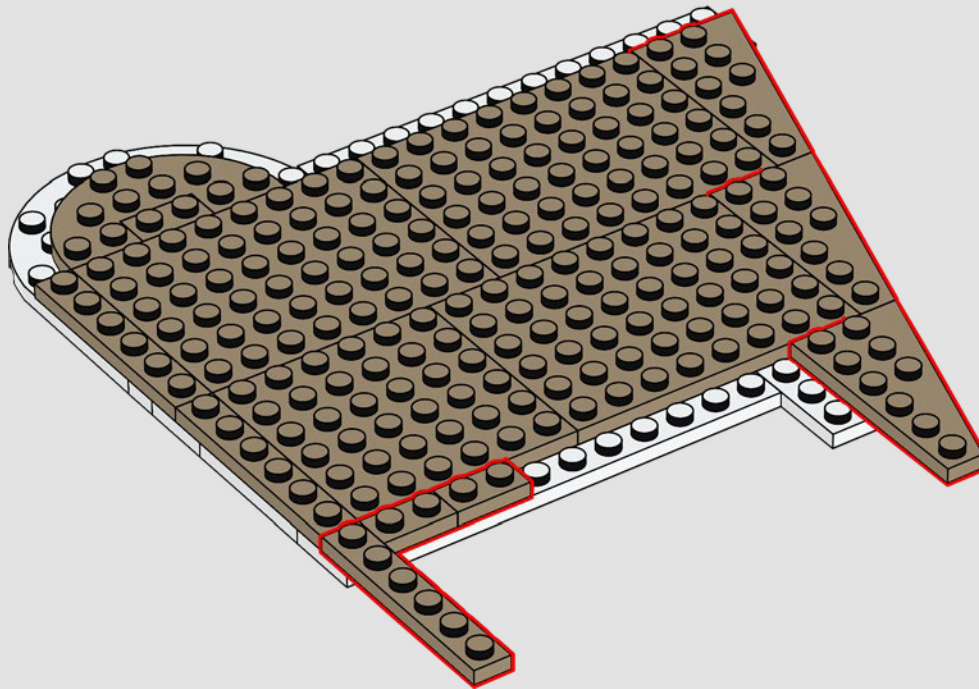

161

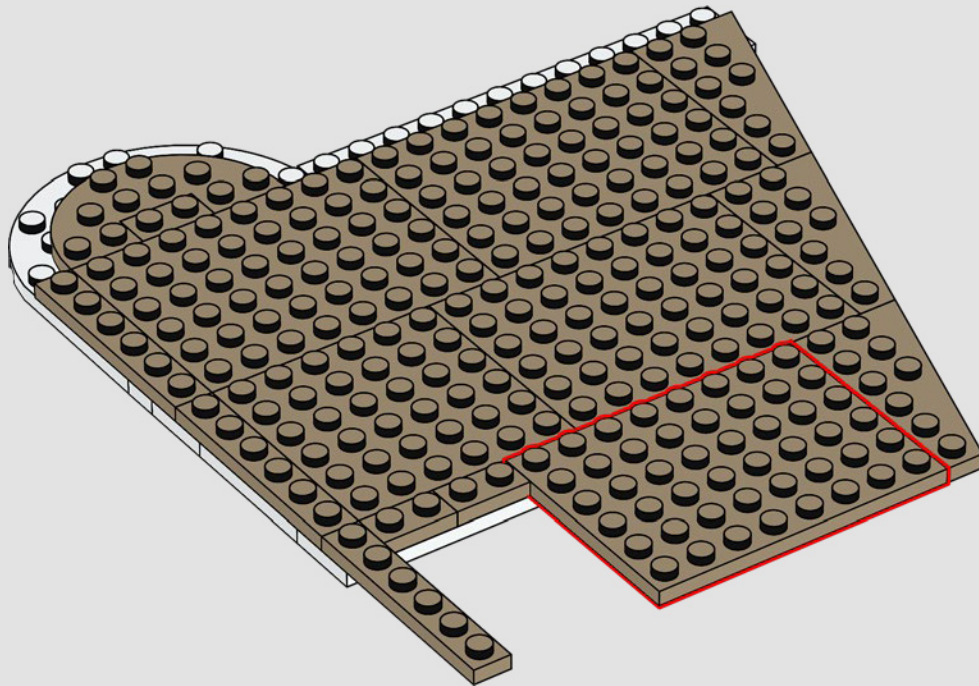

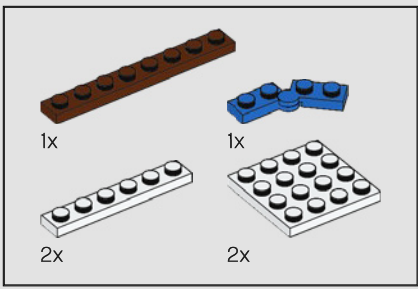

162

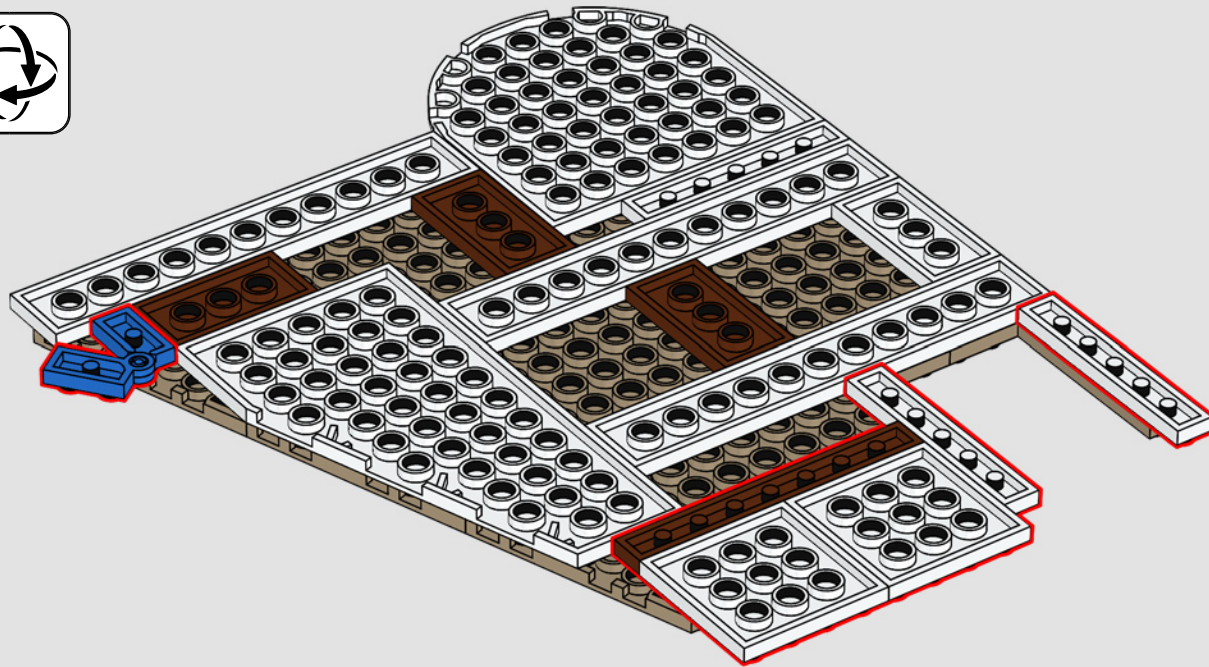

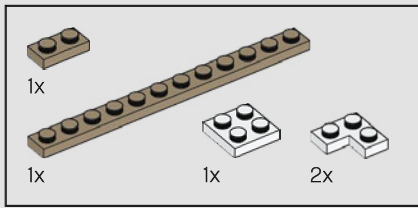

163

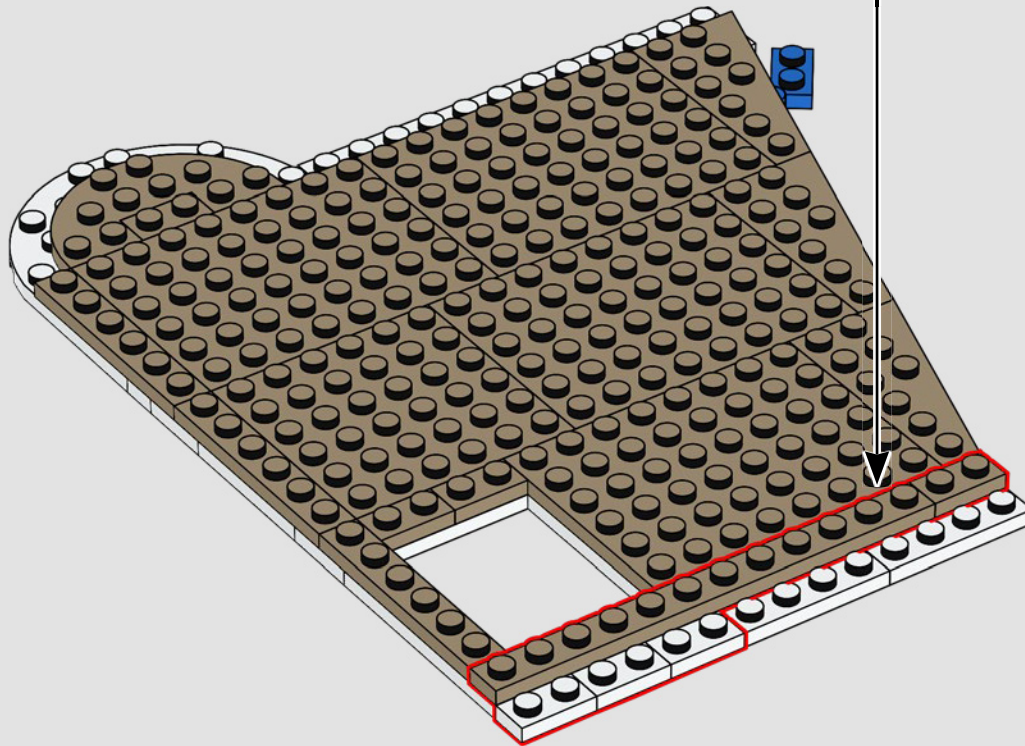
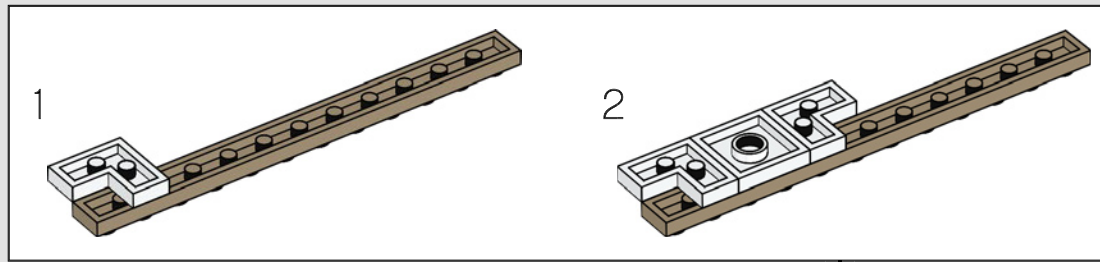

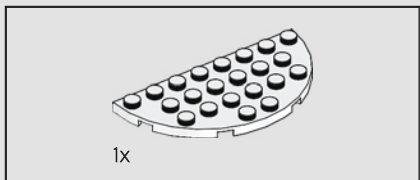

164

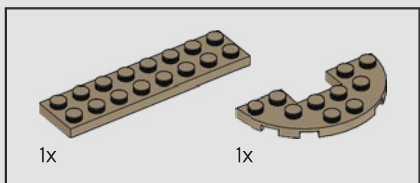
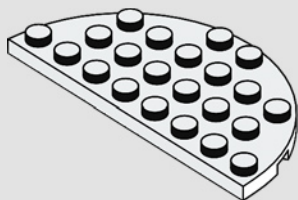

165

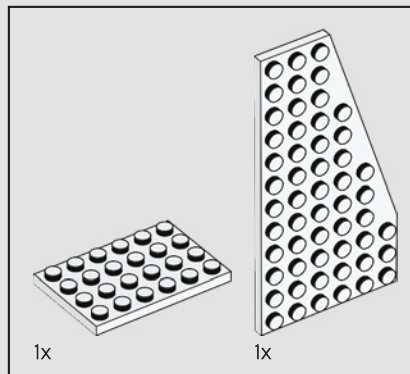
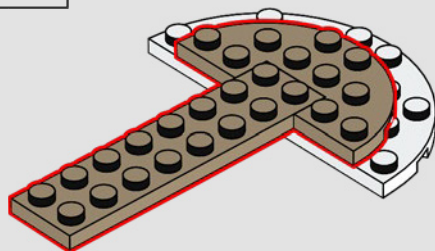

166

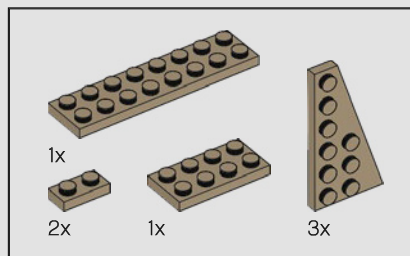
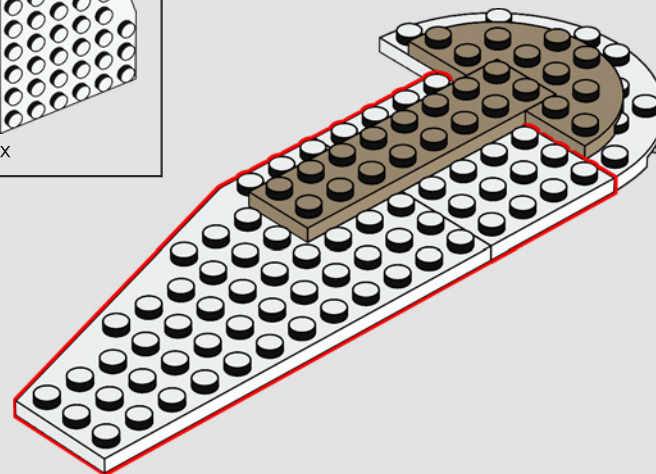

167

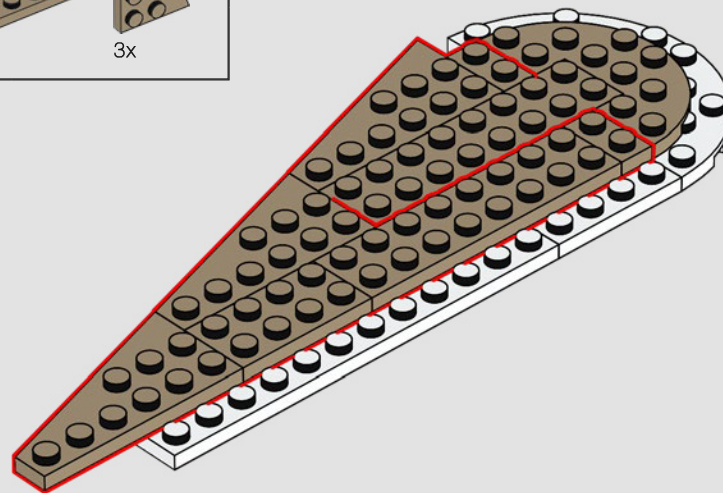

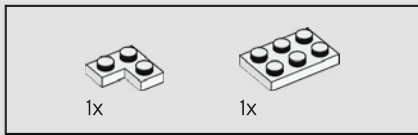

168

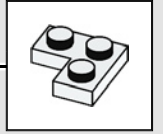
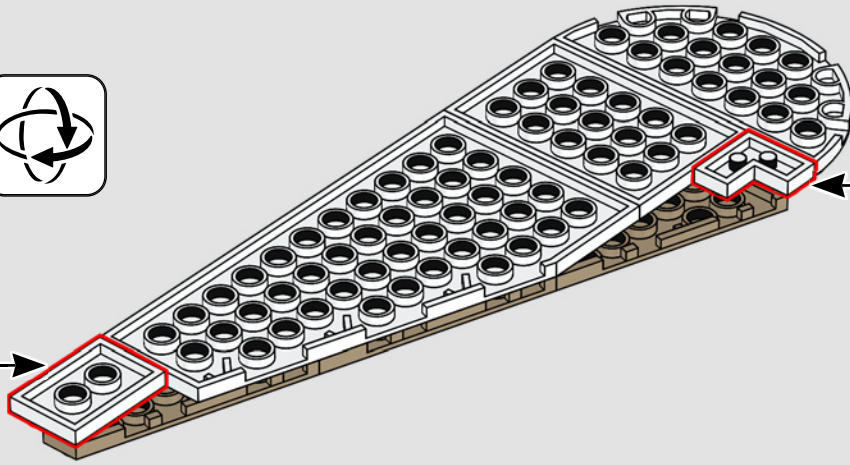
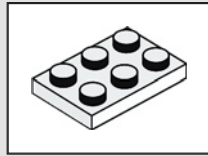

169

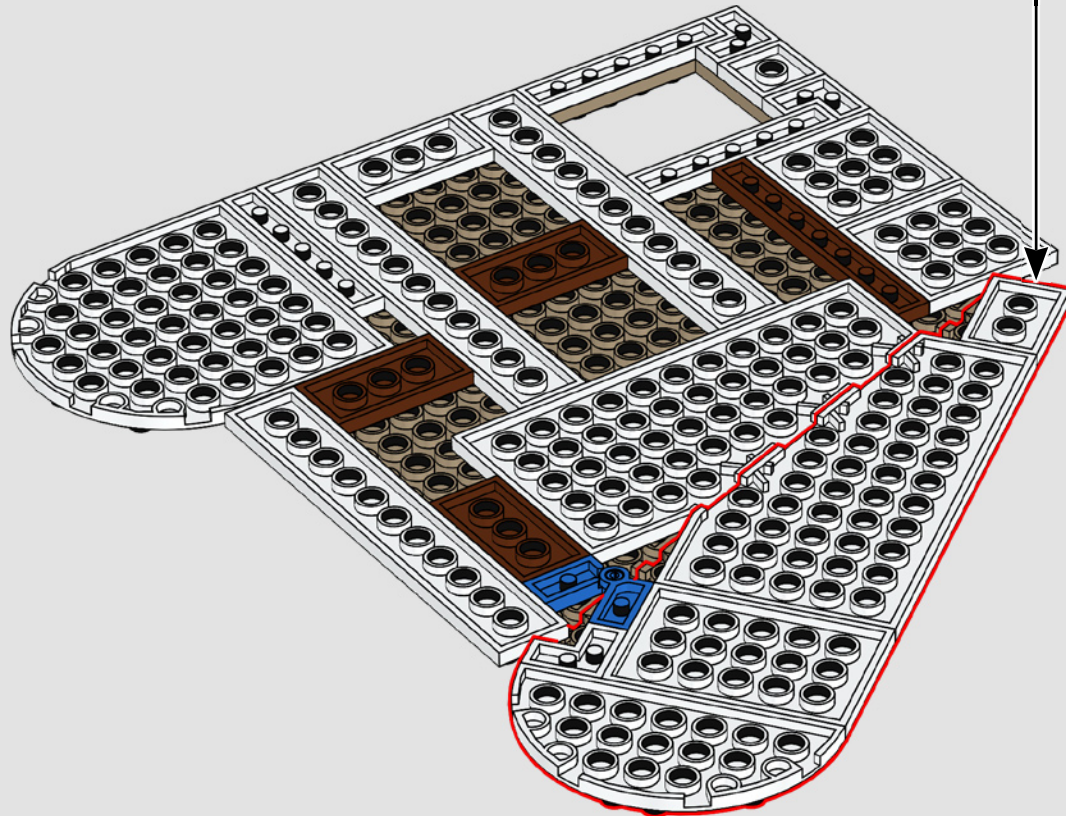

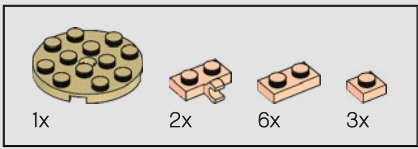

170

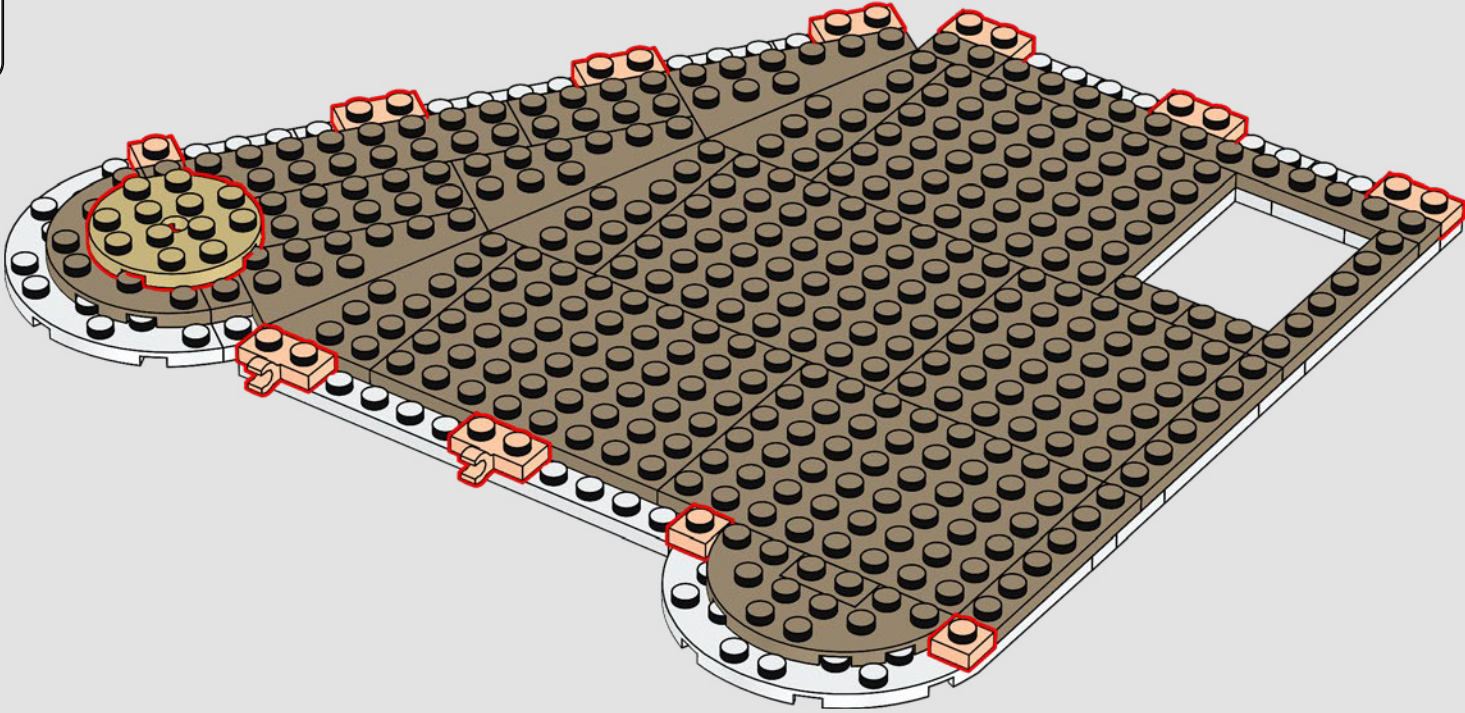



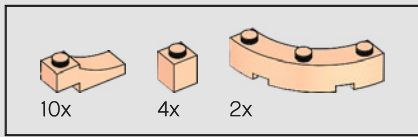

171

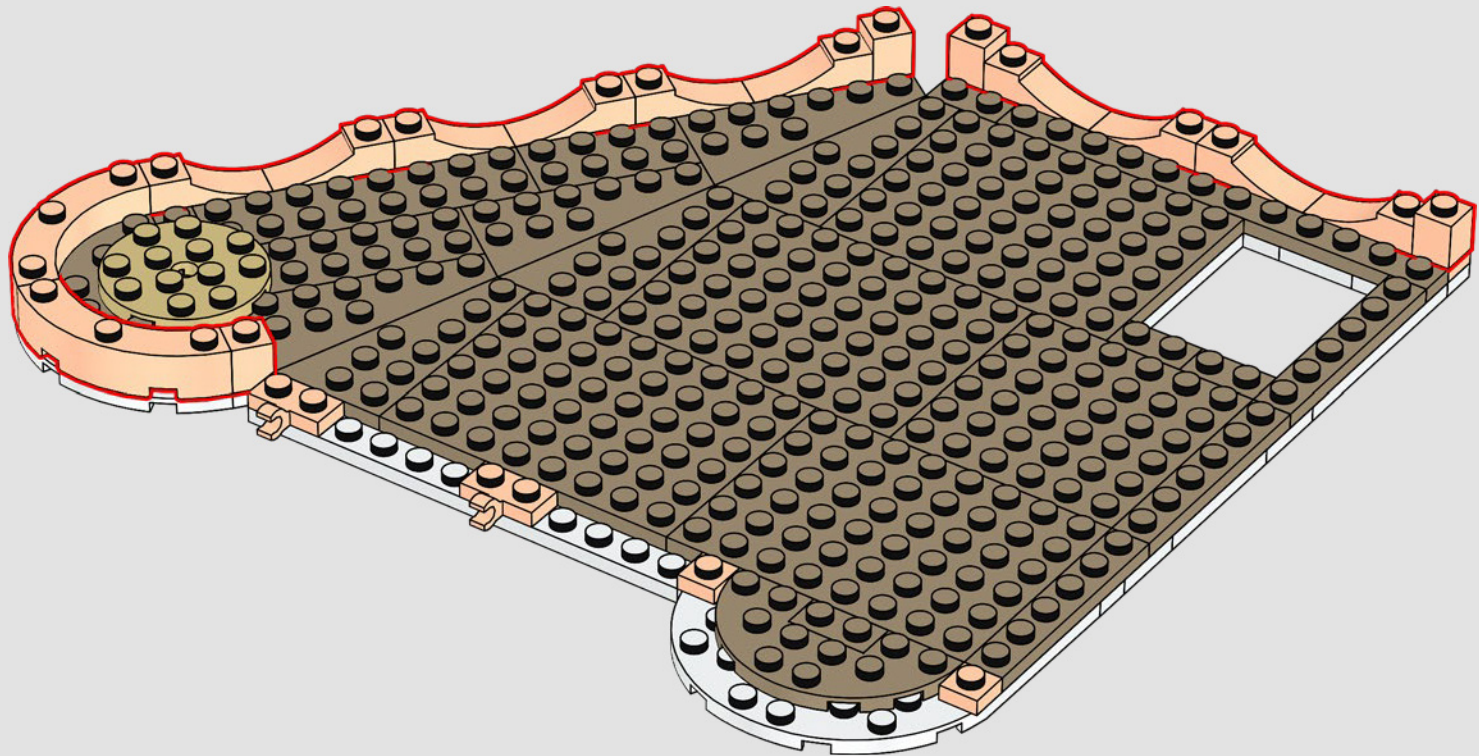

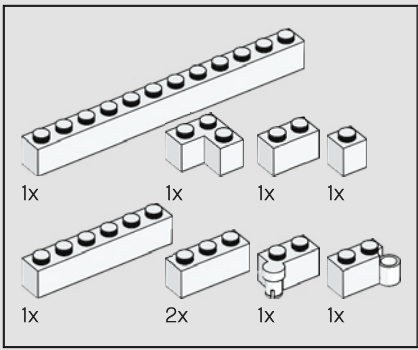

172

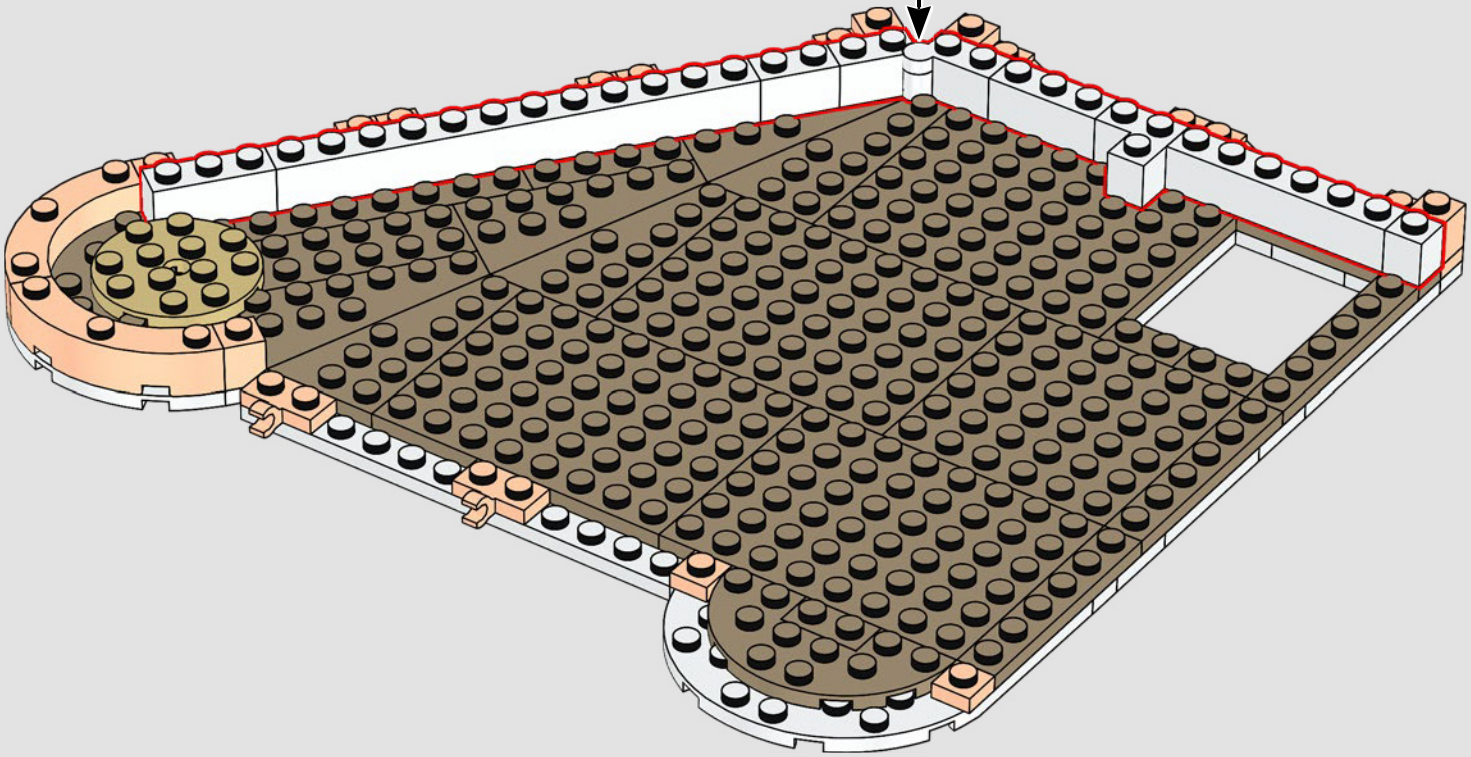
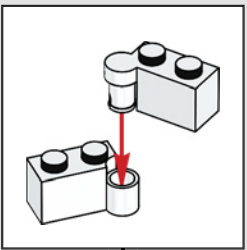

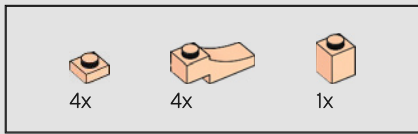

173

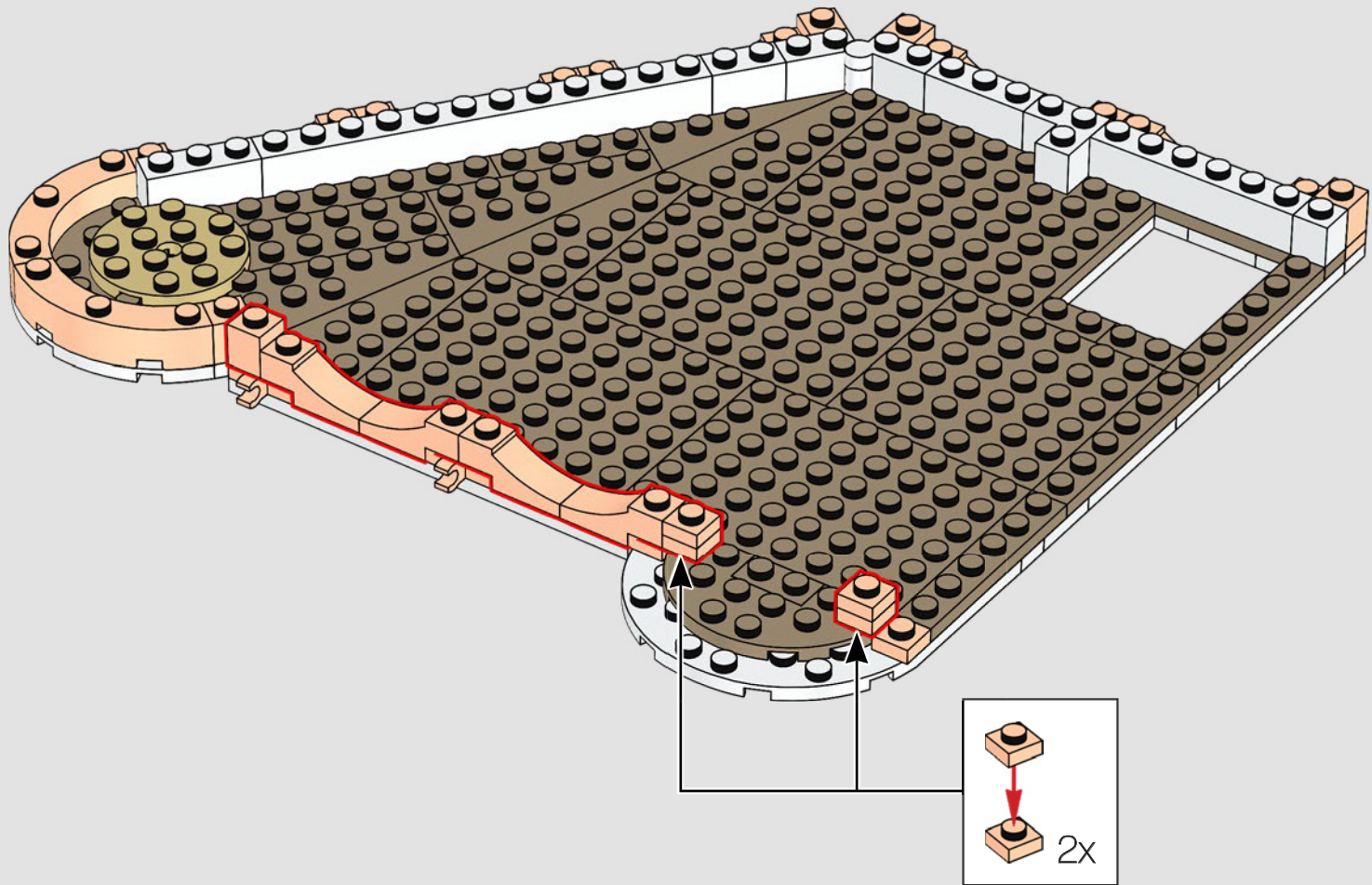

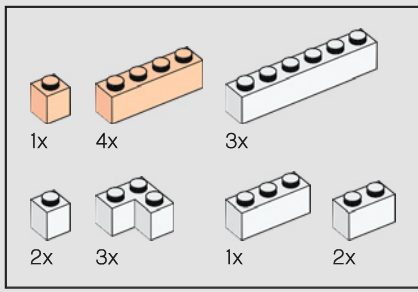

174

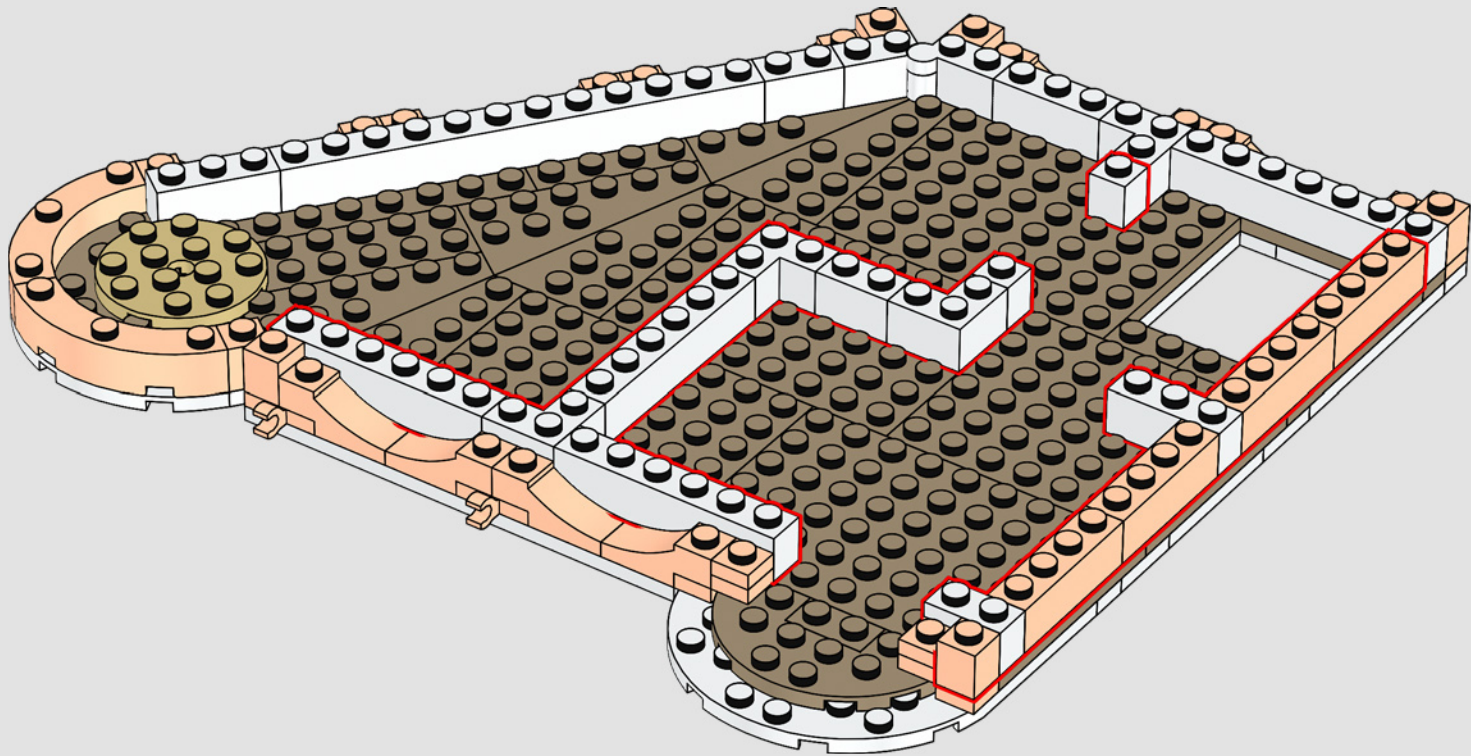

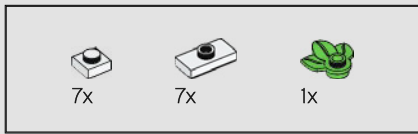

175

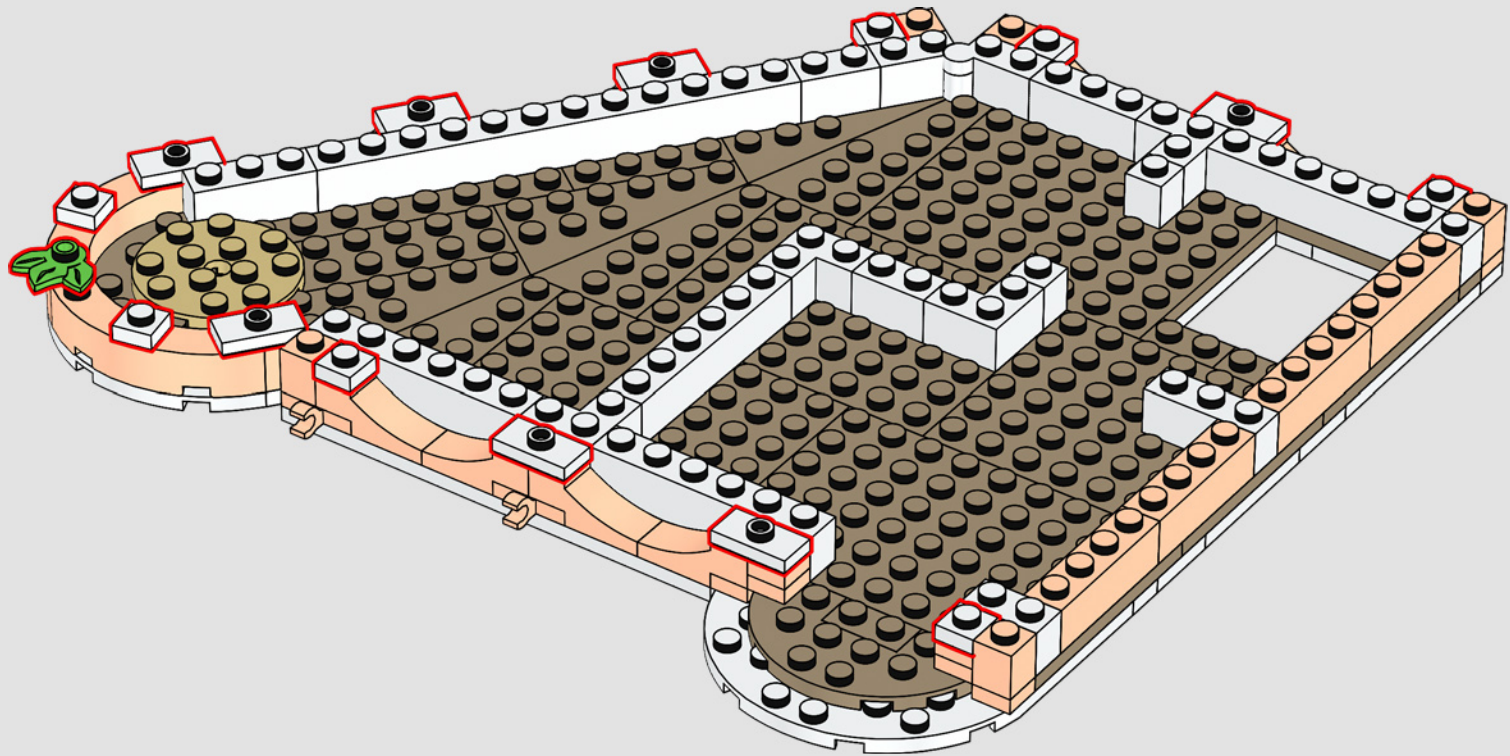

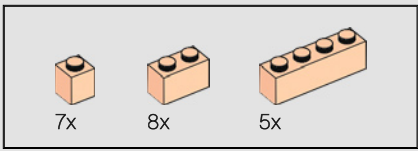

176

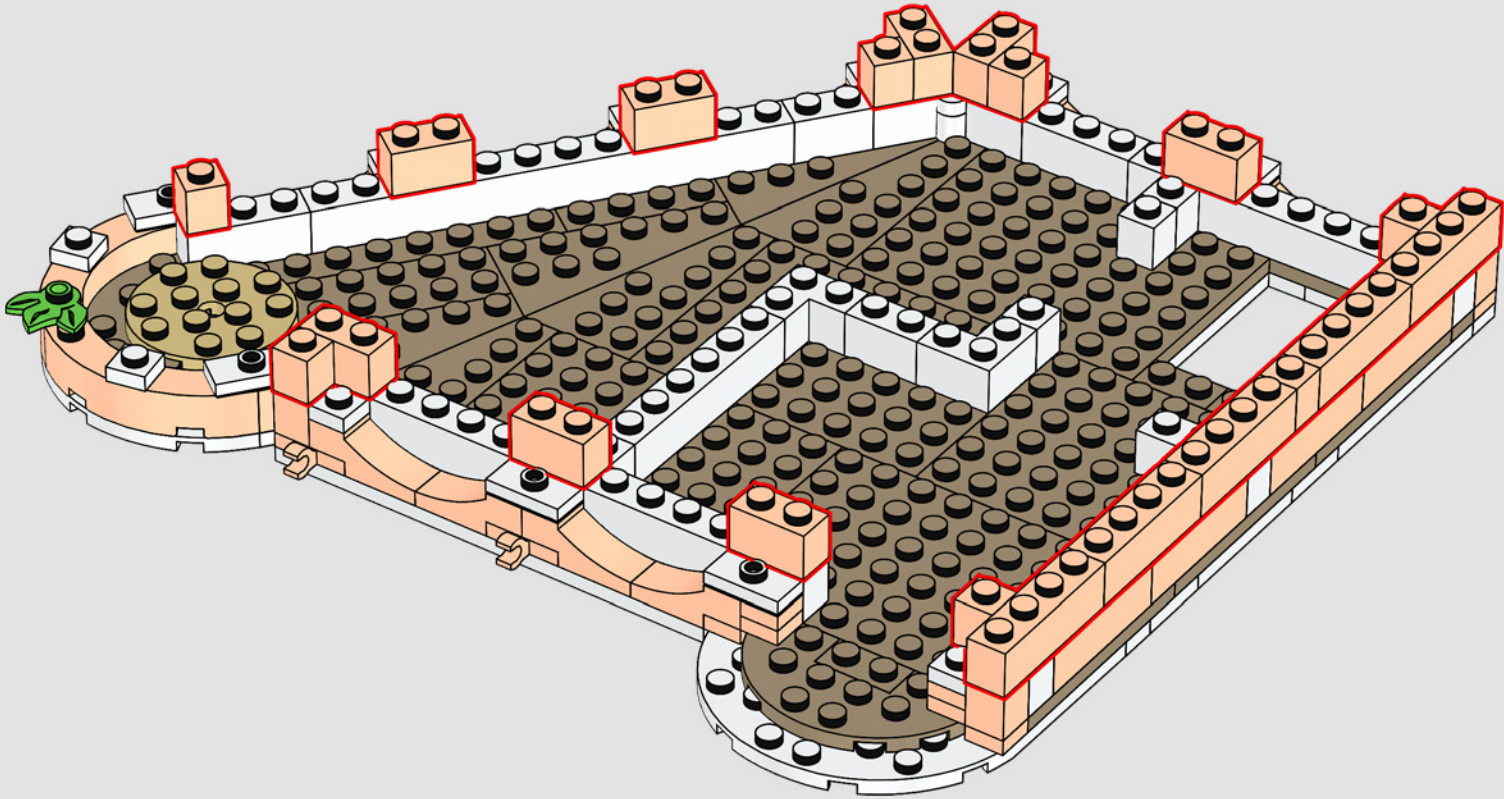

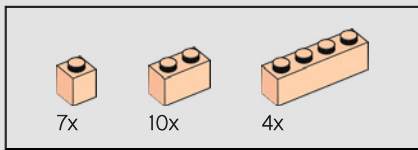

177

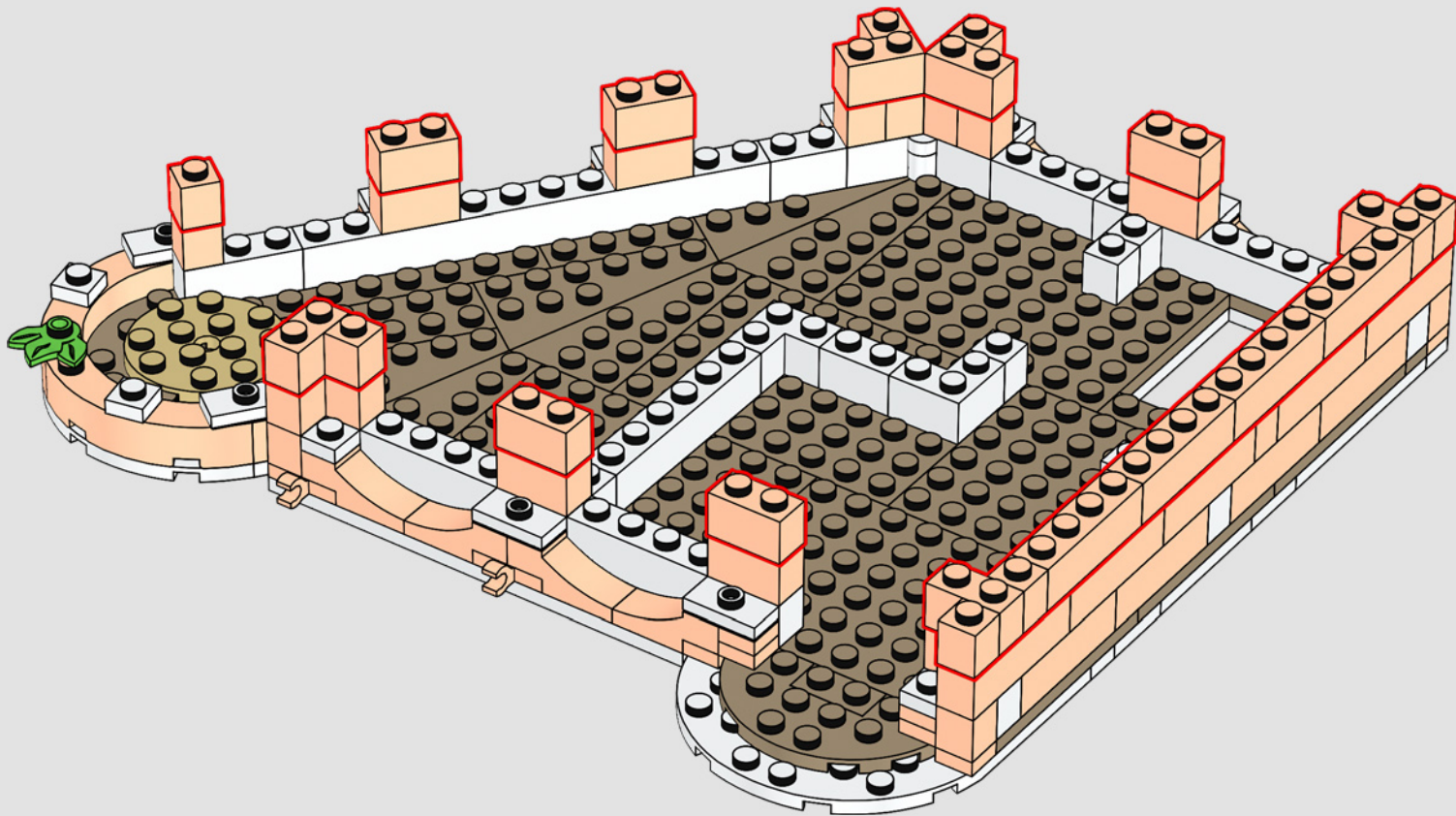

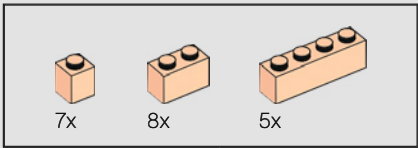
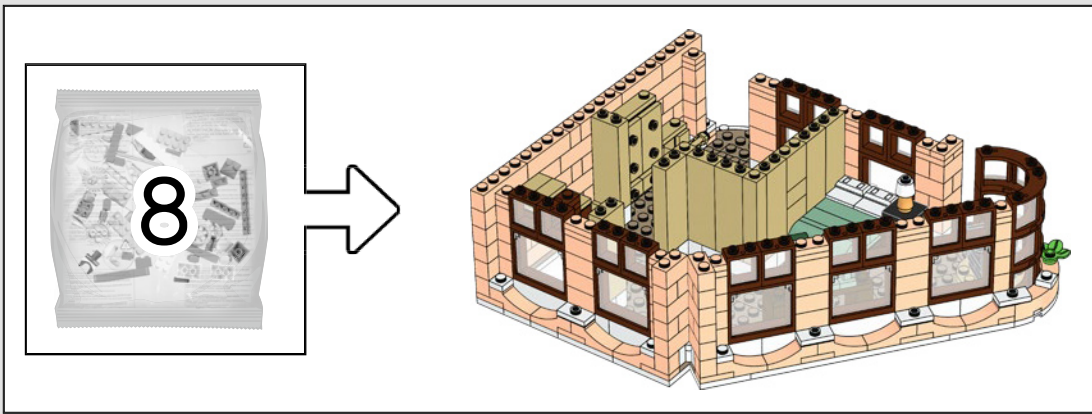

178

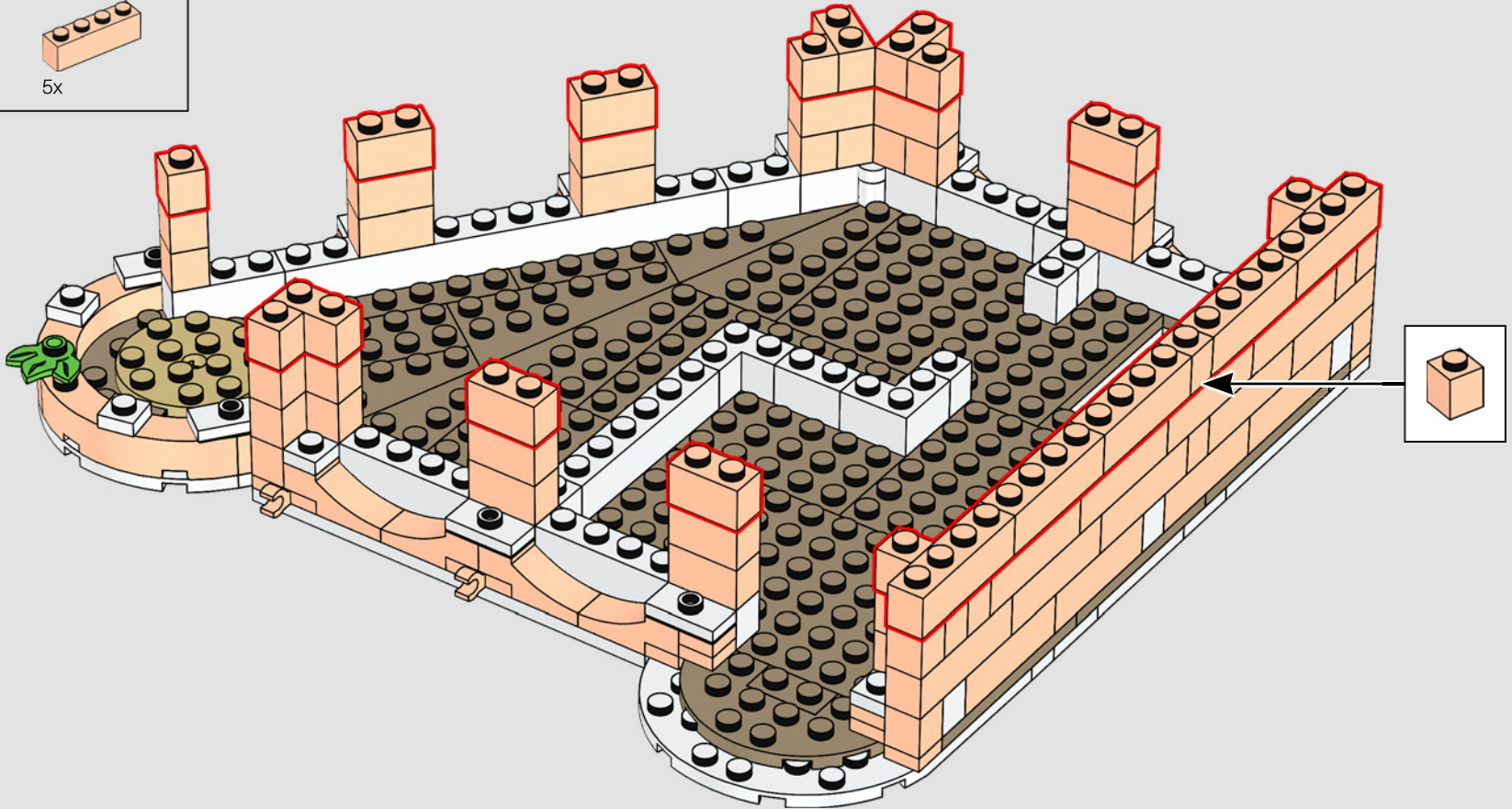



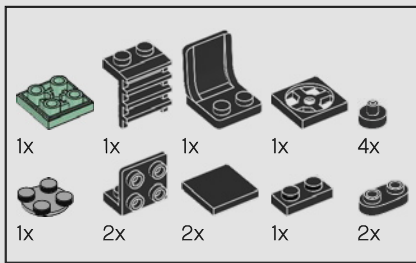

179

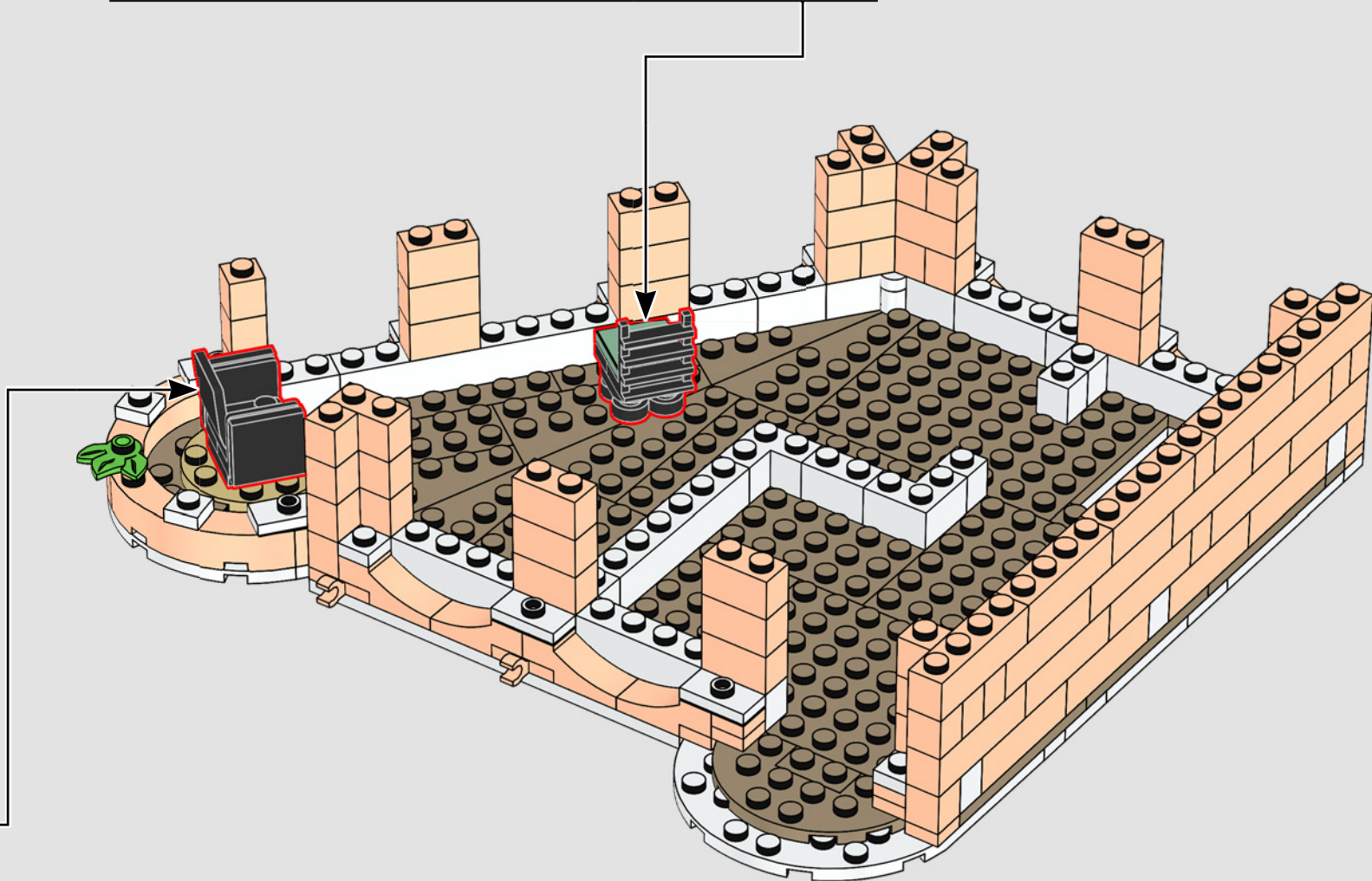
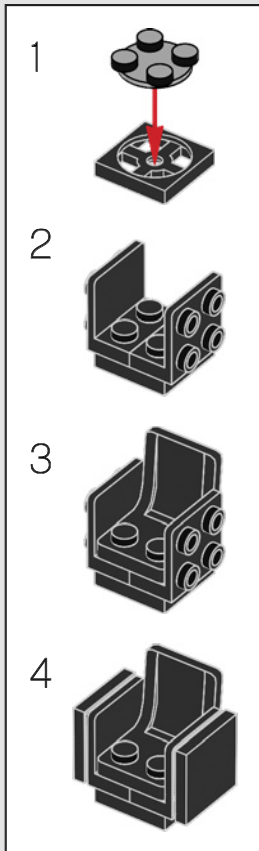
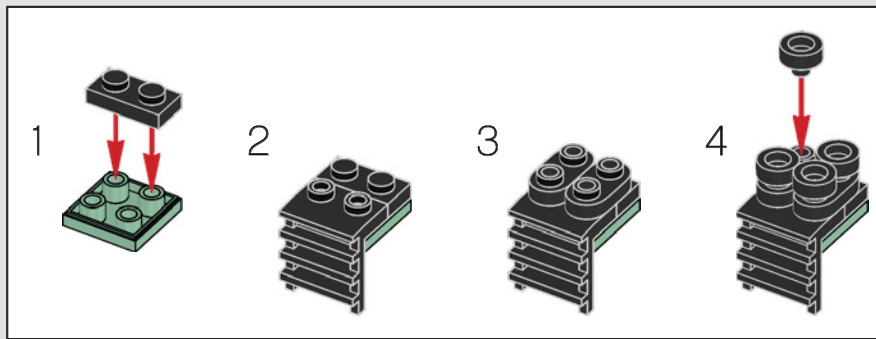

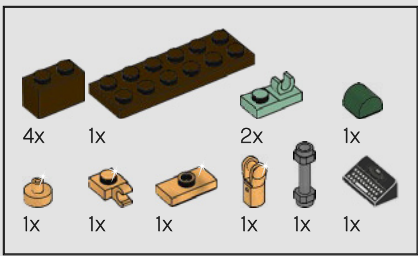

180

1

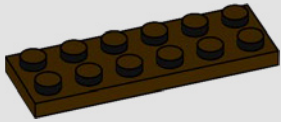

2

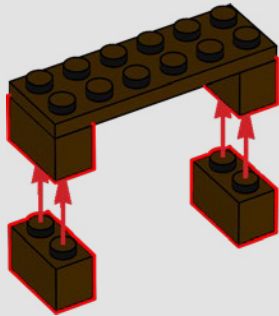

3

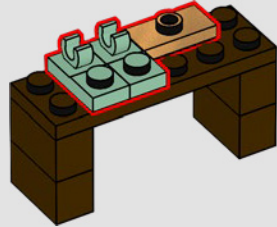

4

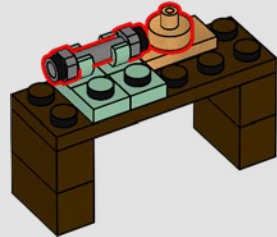

★★★★★  
 Der örtliche Schreibmaschinenhersteller hat erst kürzlich zwei Modelle ans Hotel und die „Polizeistation“ (10278) verkauft.

5

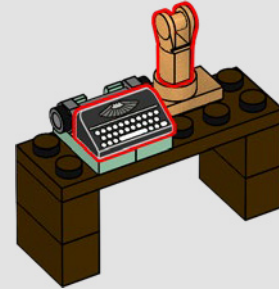

6

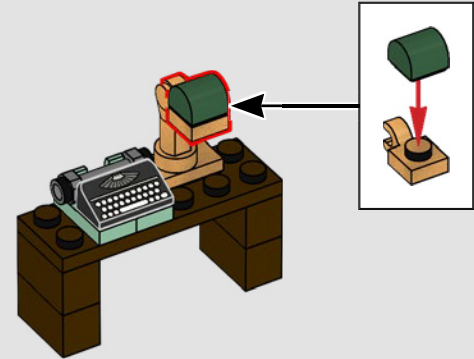

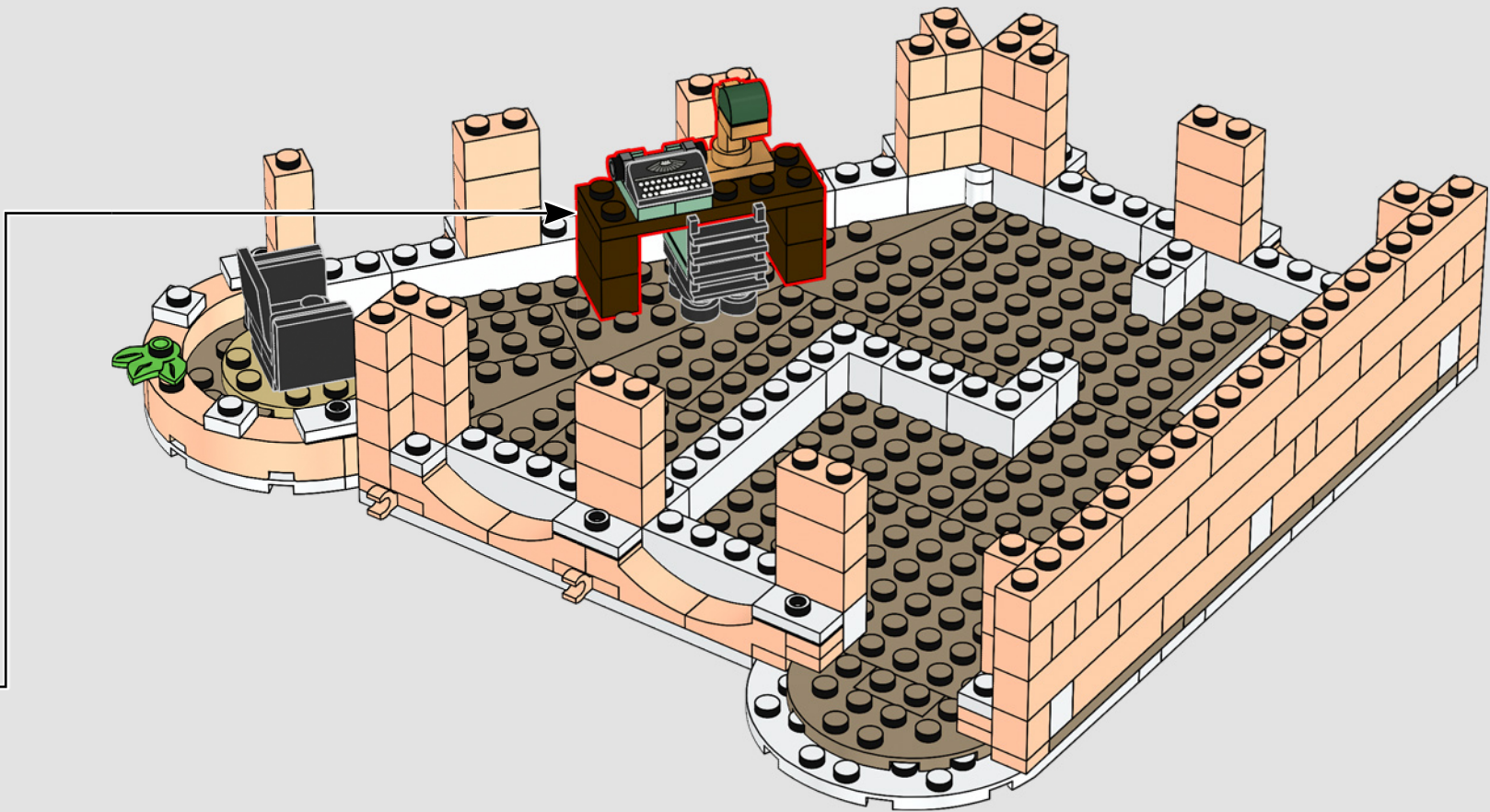

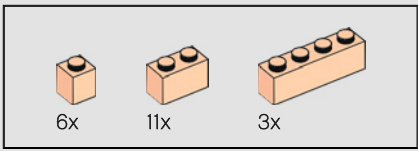

181

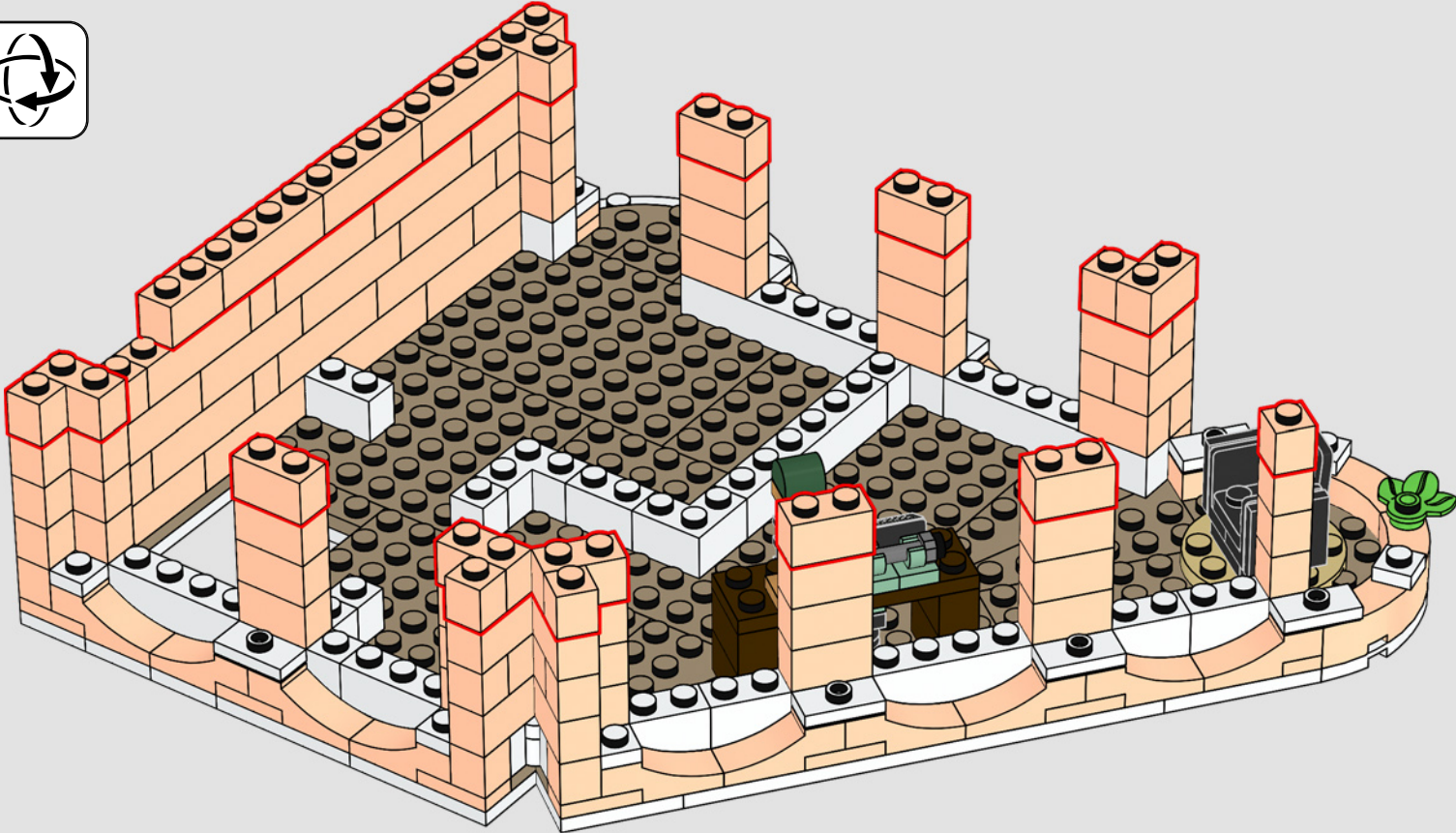

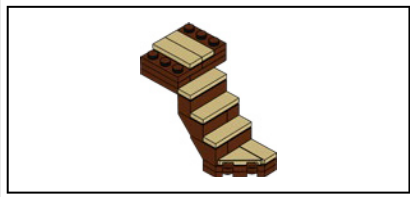

182

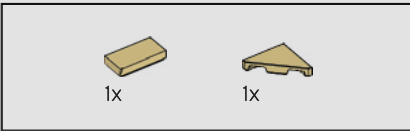
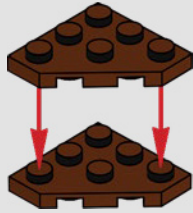

183

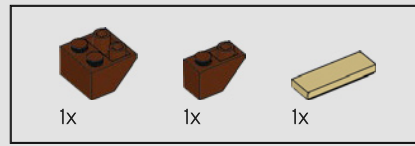

184

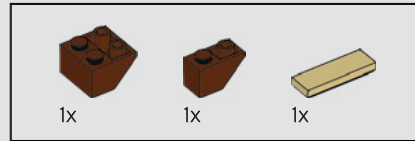
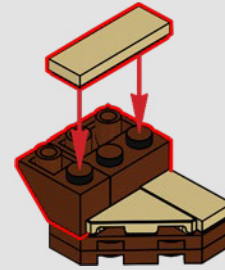

185

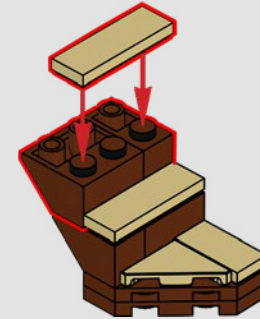

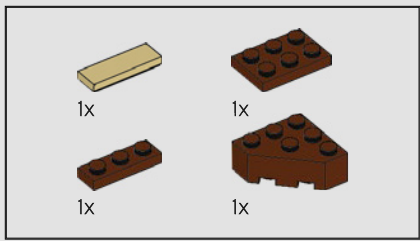

186

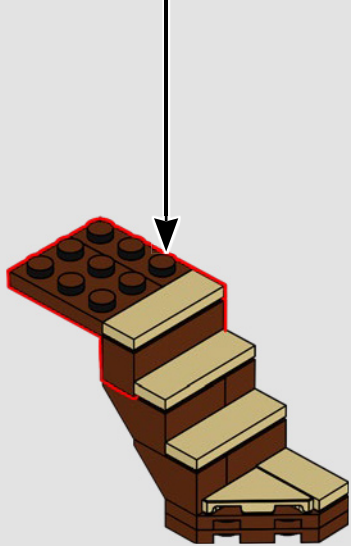
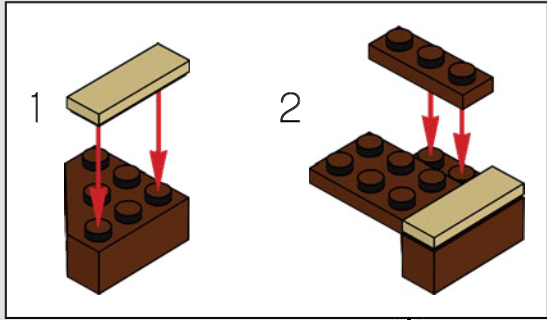

187

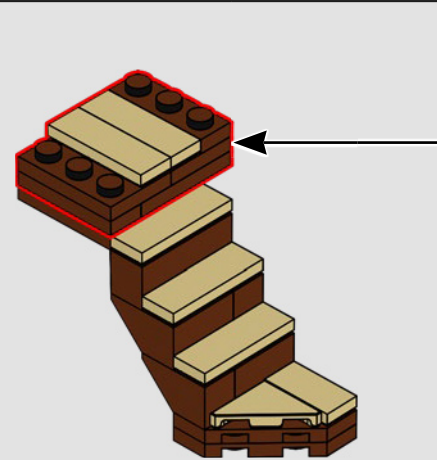
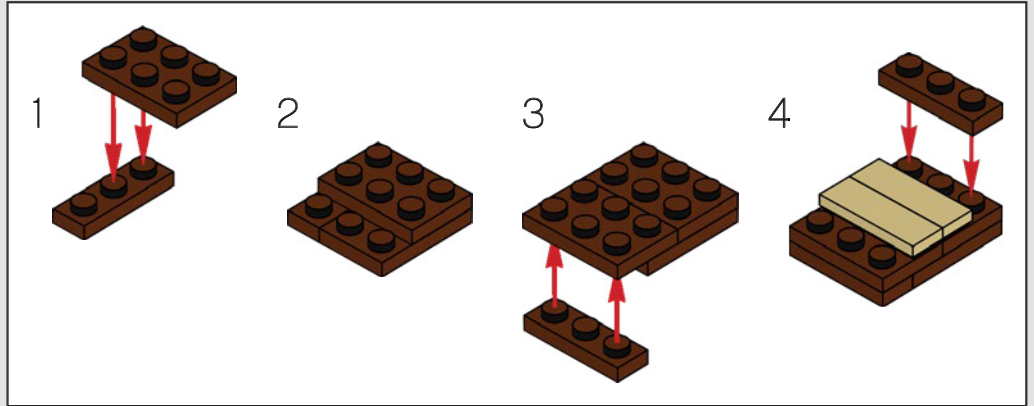

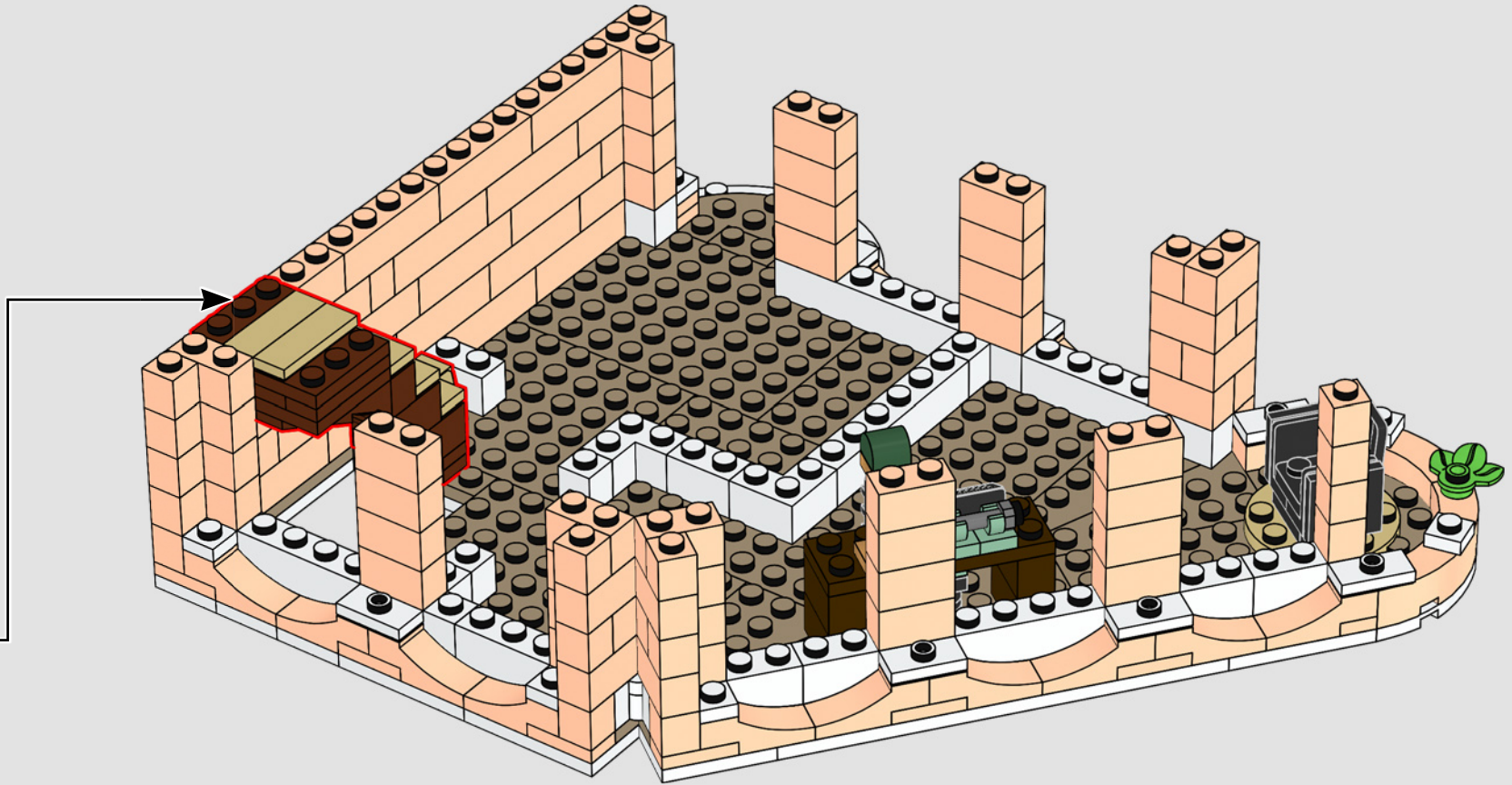

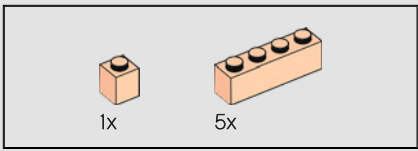

189

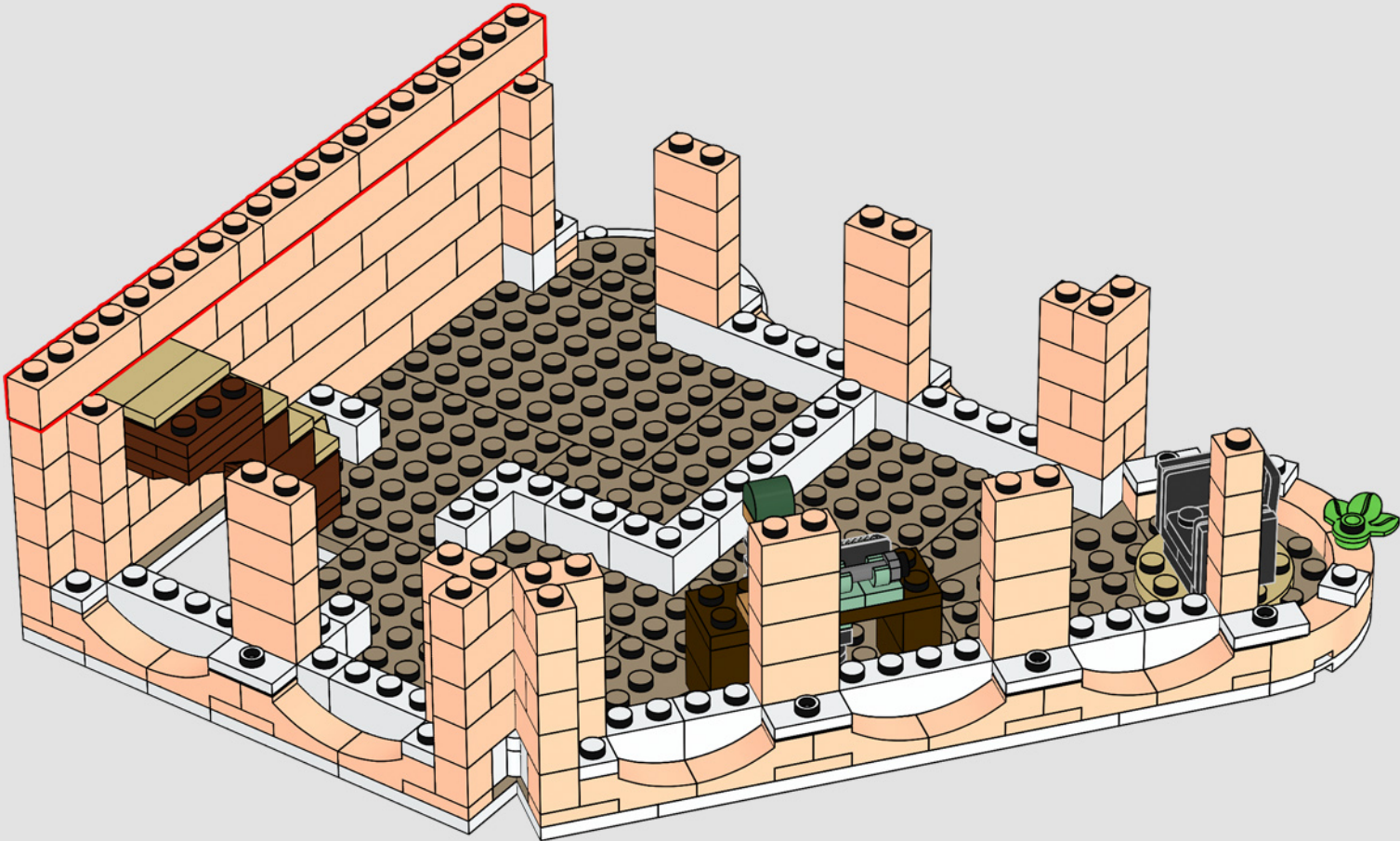



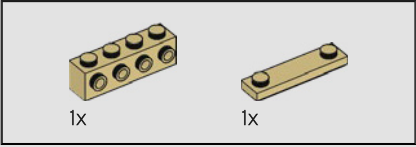
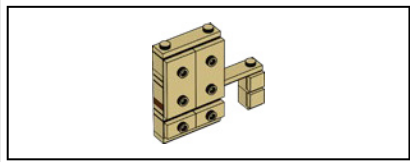

190

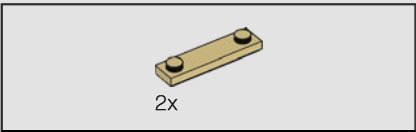
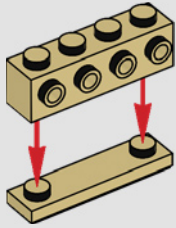

191

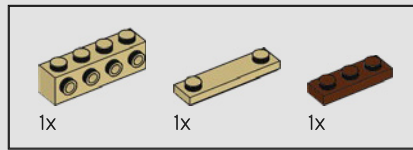
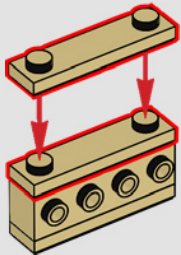

192

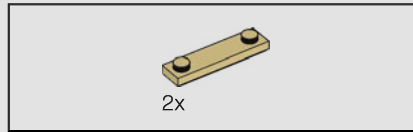
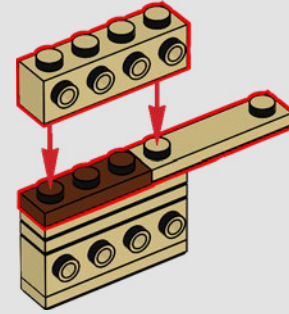

193

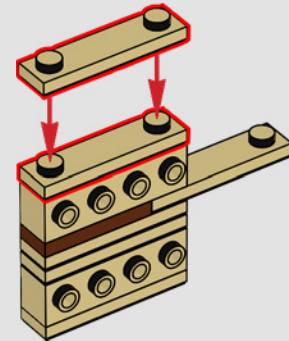

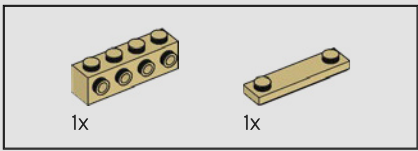

194

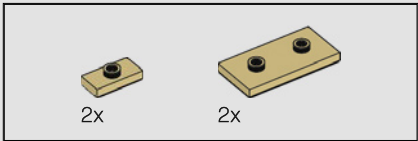
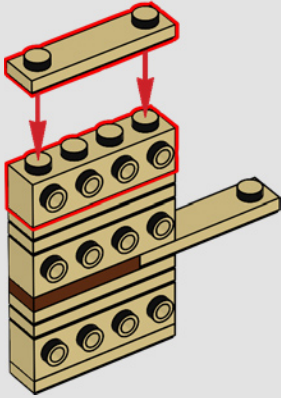

195

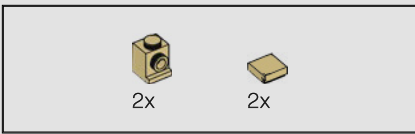
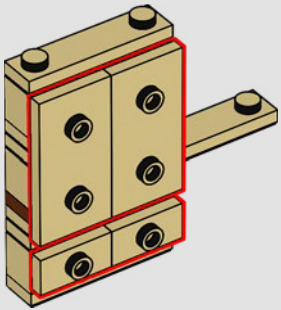

196

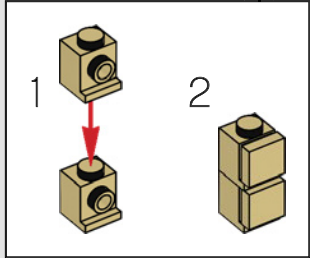
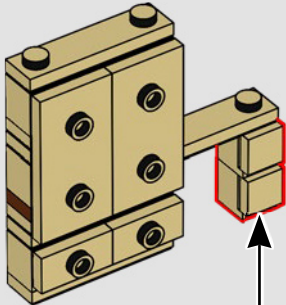

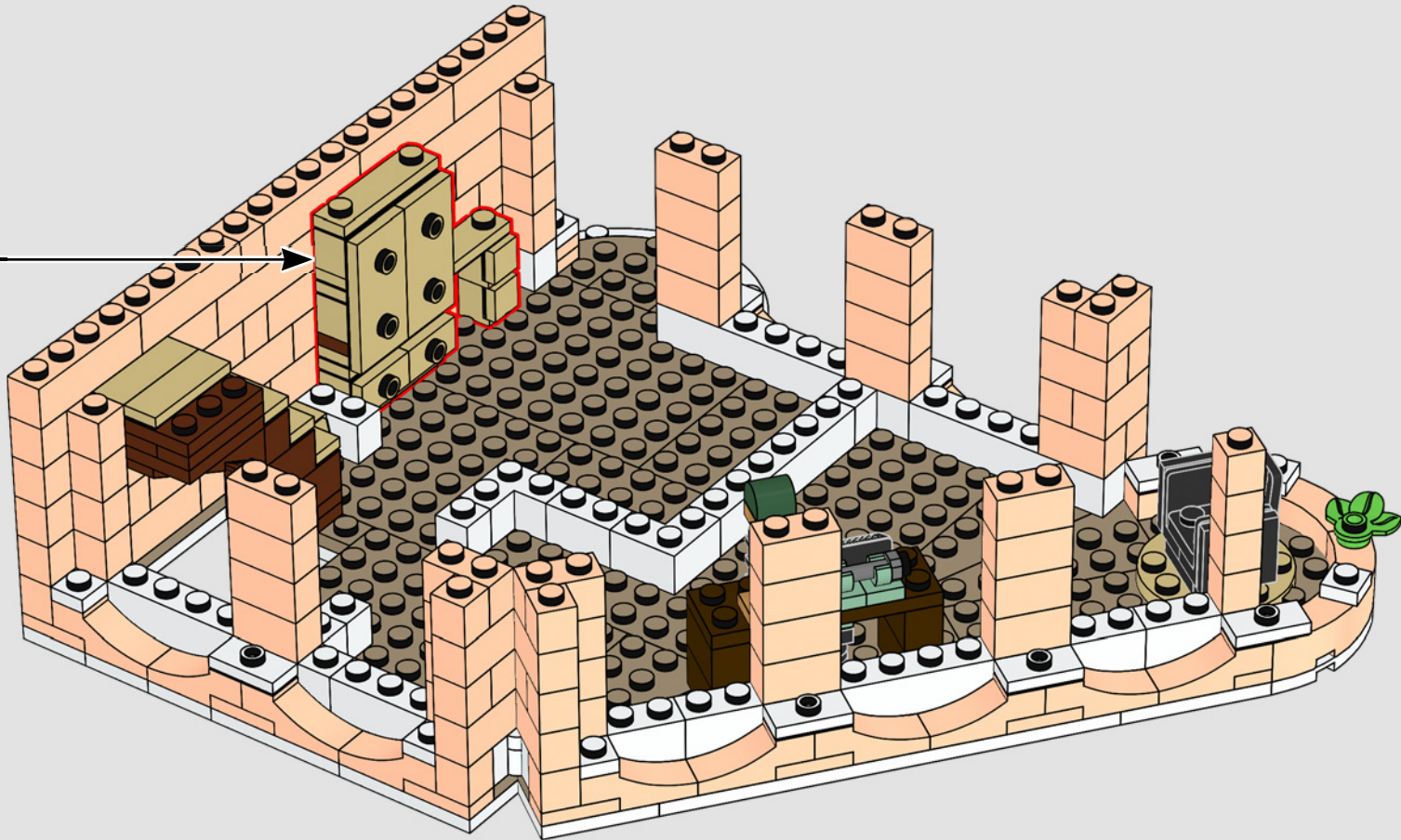

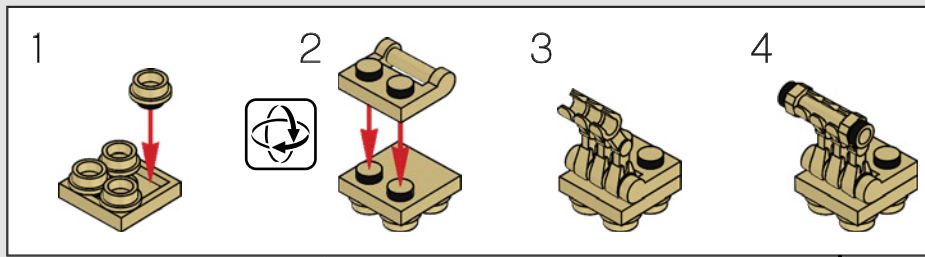
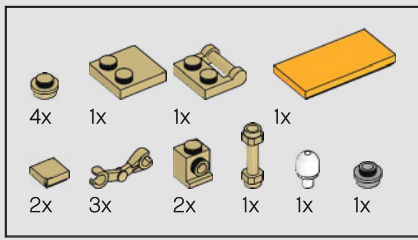

198

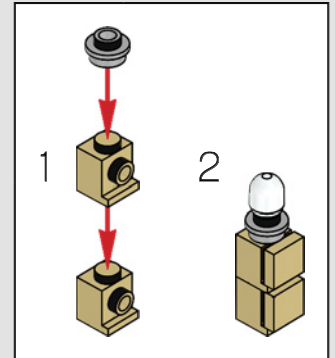
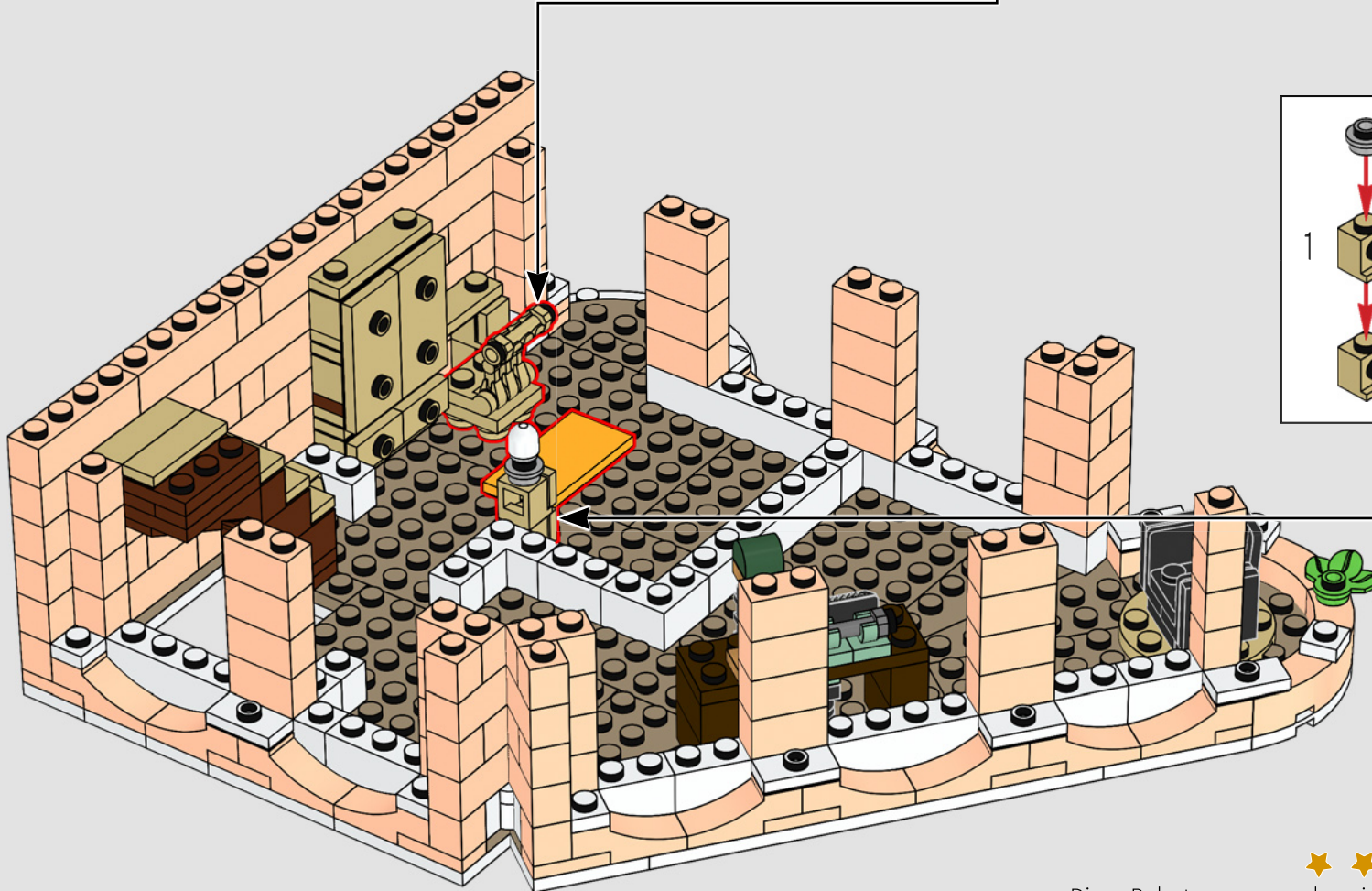

Diese Roboterarme wurden nicht zum ersten Mal in einem Modell aus Modulen verwendet. Sie stellen auch das Balkongeländer im Set „Marktstraße“ (10190) dar.

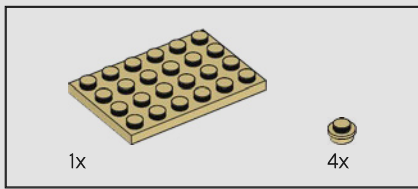

199

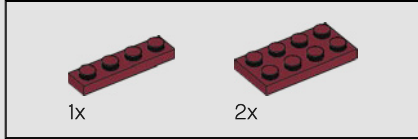
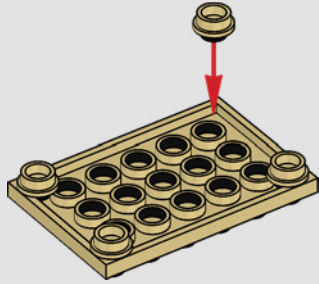

200

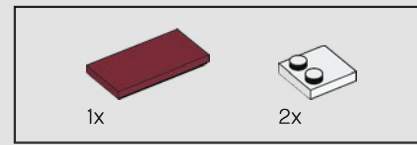
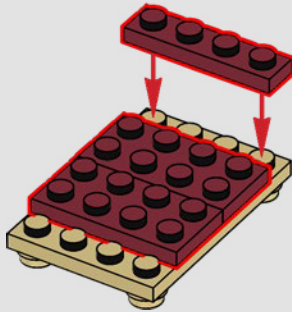

201

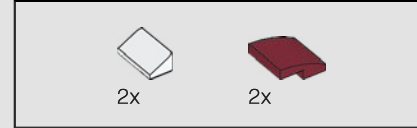
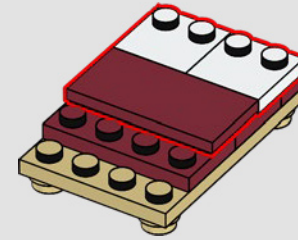

202

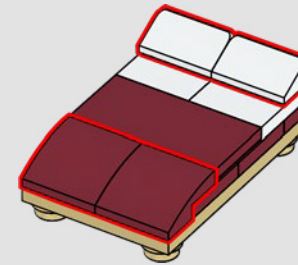

203

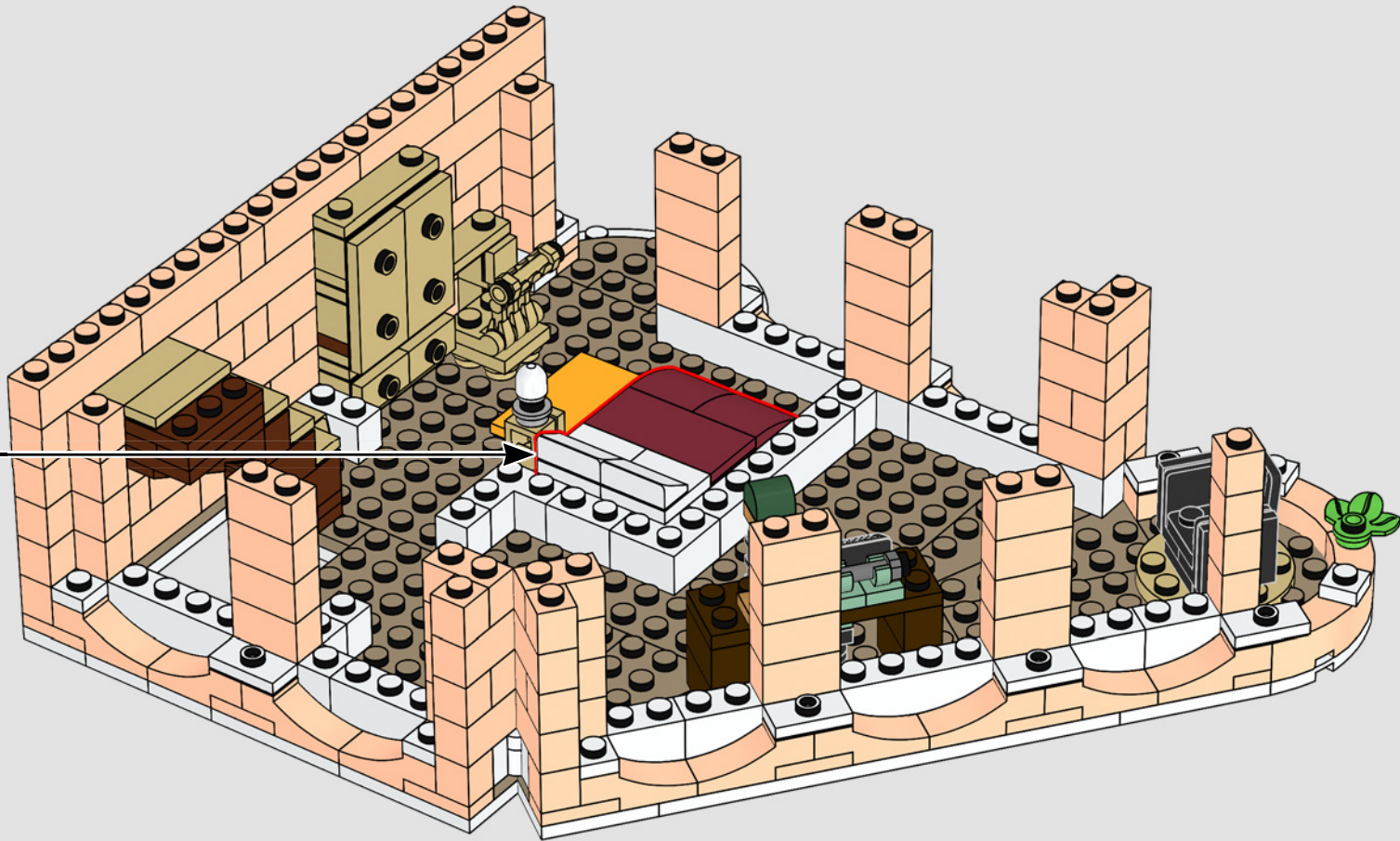

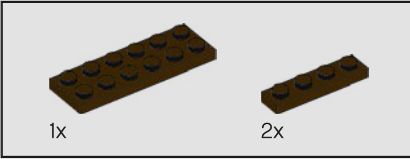
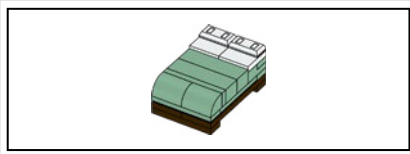

204

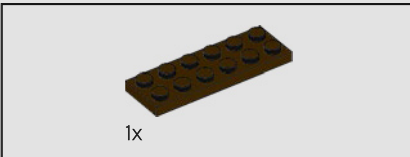
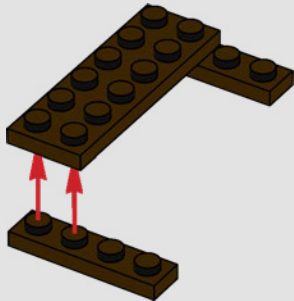

205

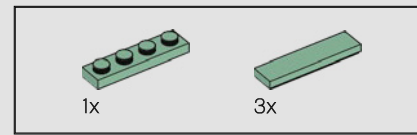
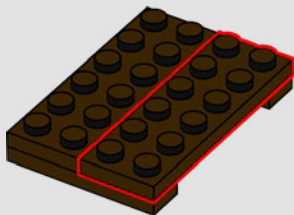

206

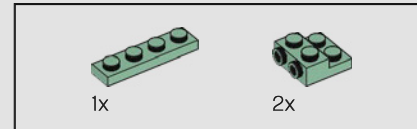
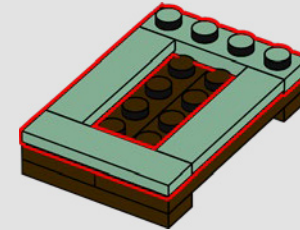

207

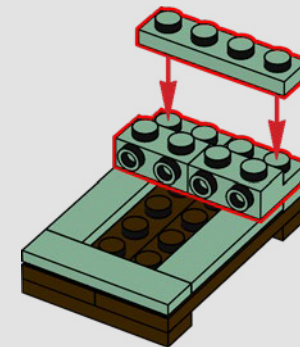

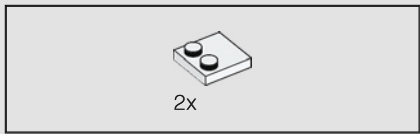

208

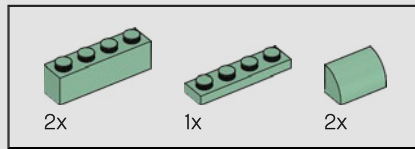
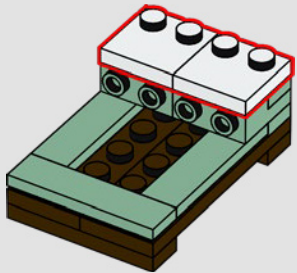

209

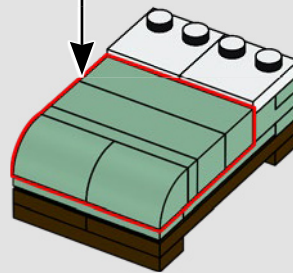
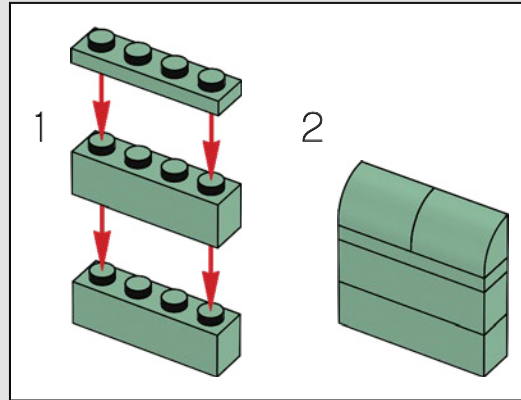

210

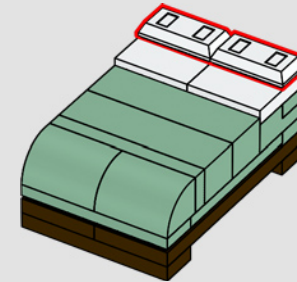



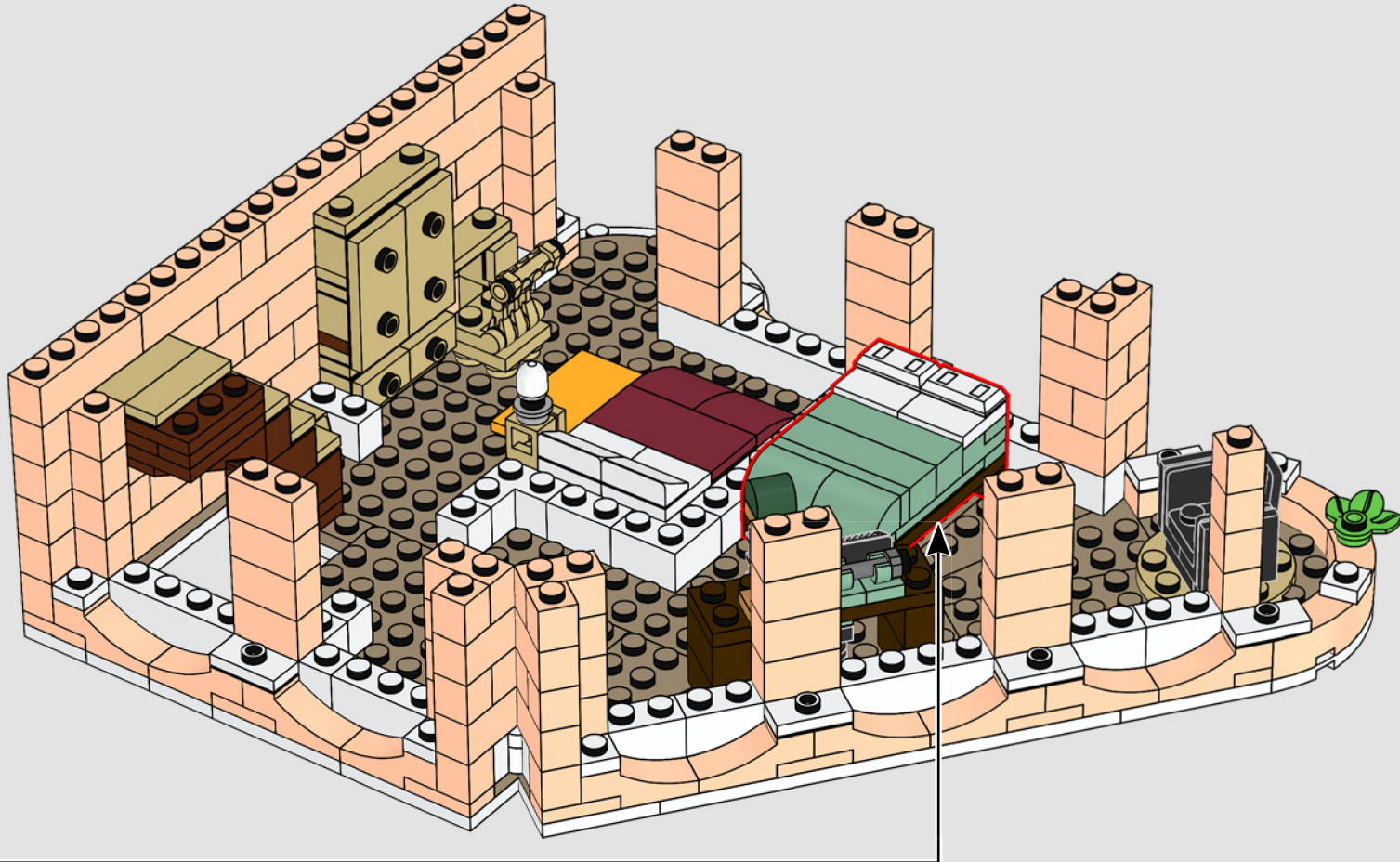

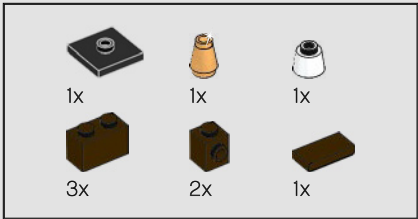

212

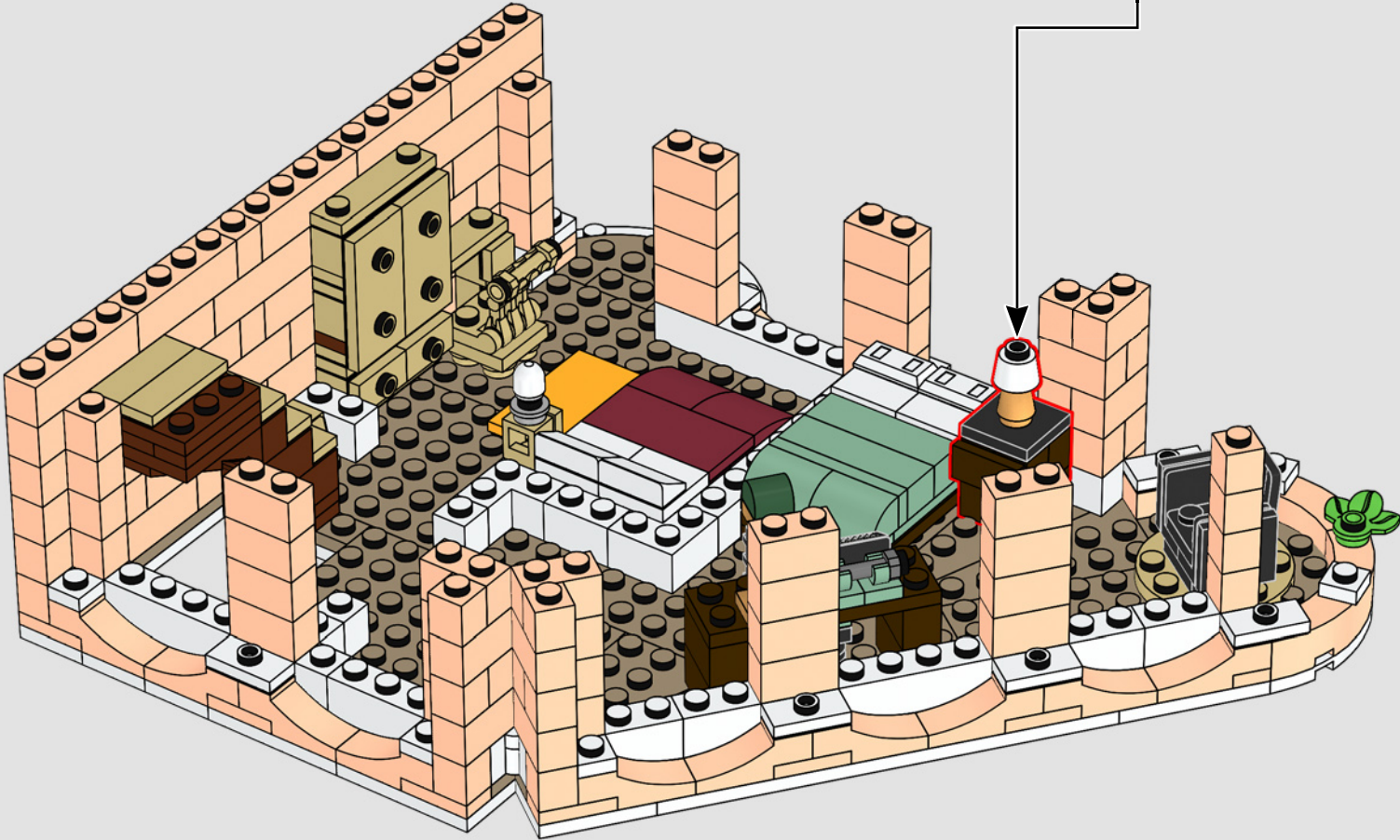
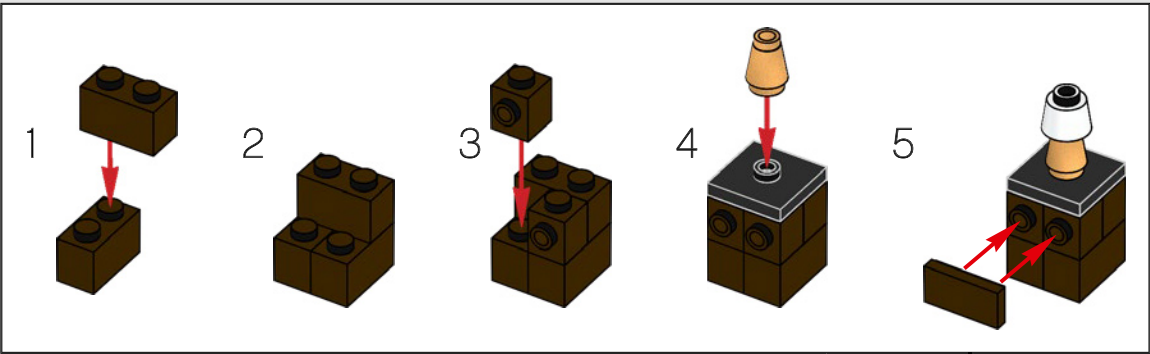

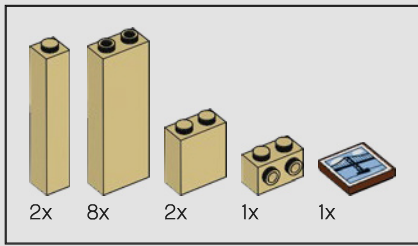

213

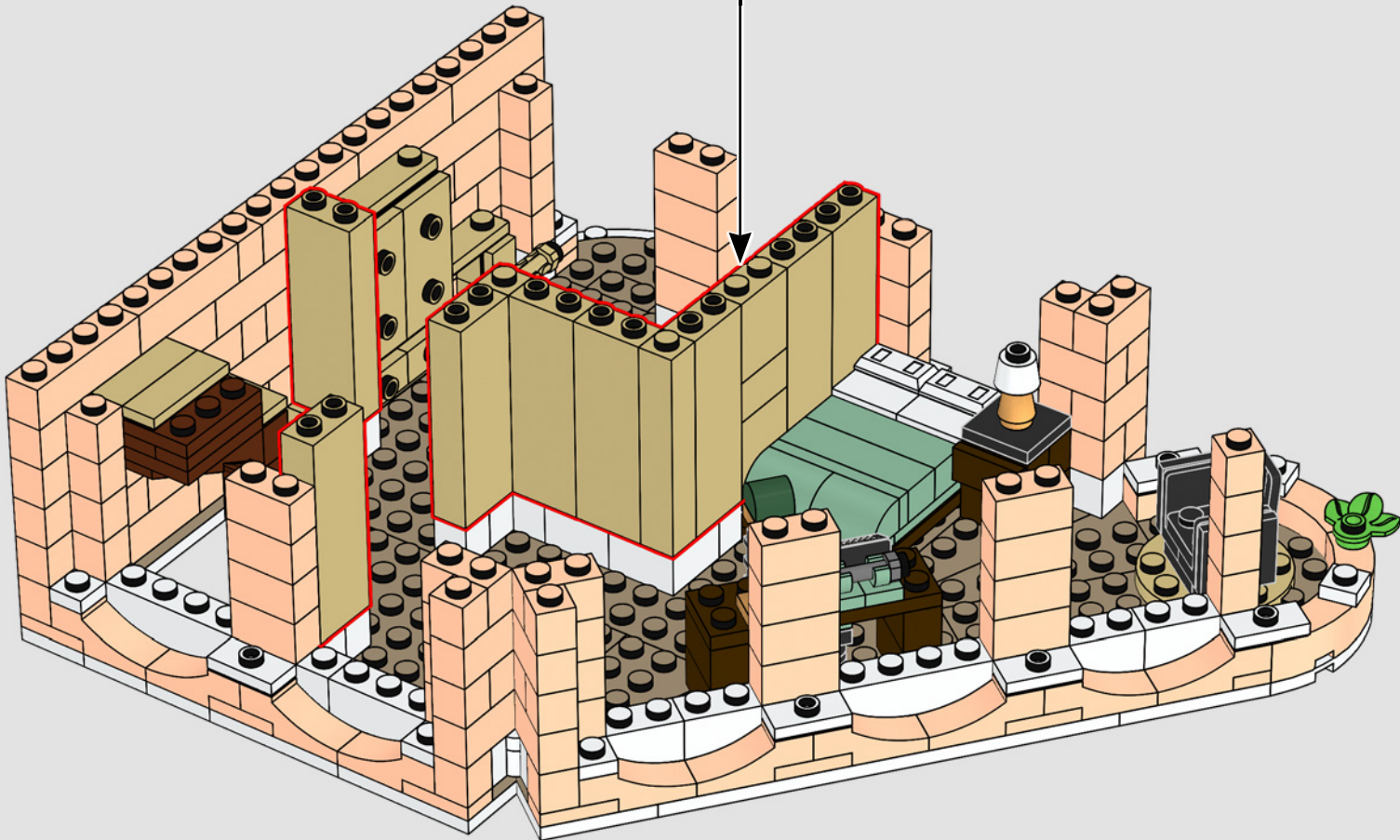
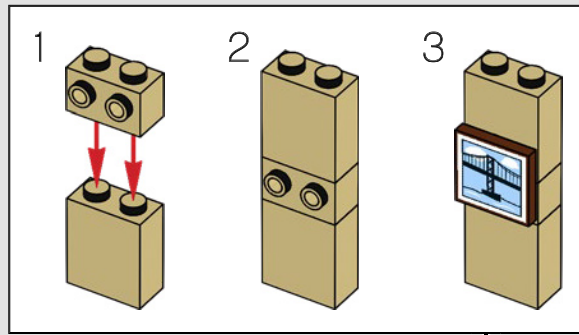

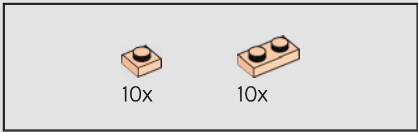

214

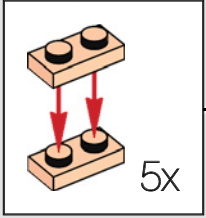
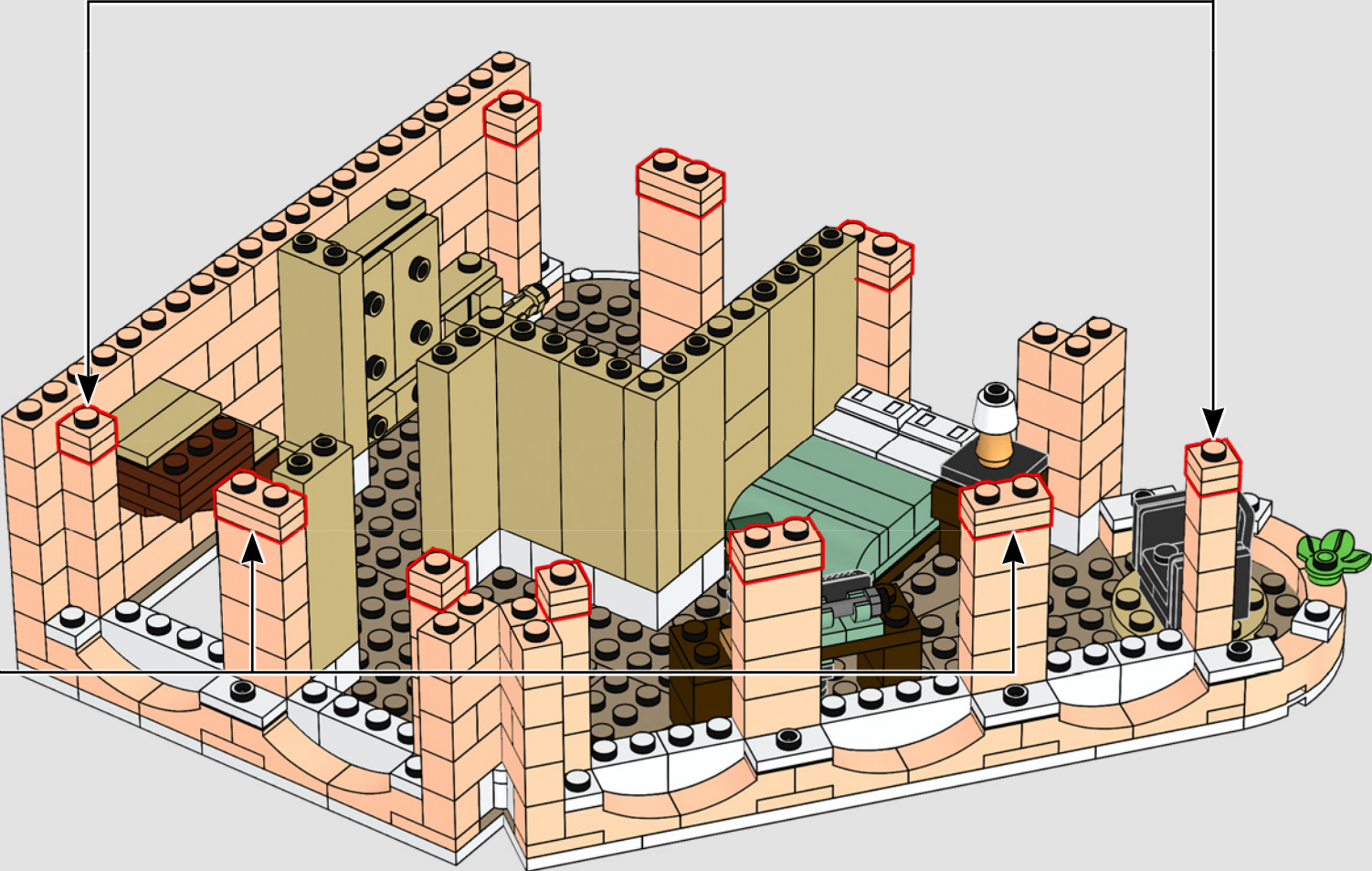
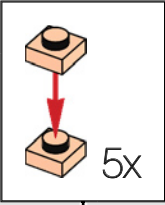

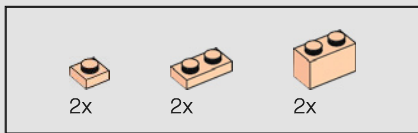

215

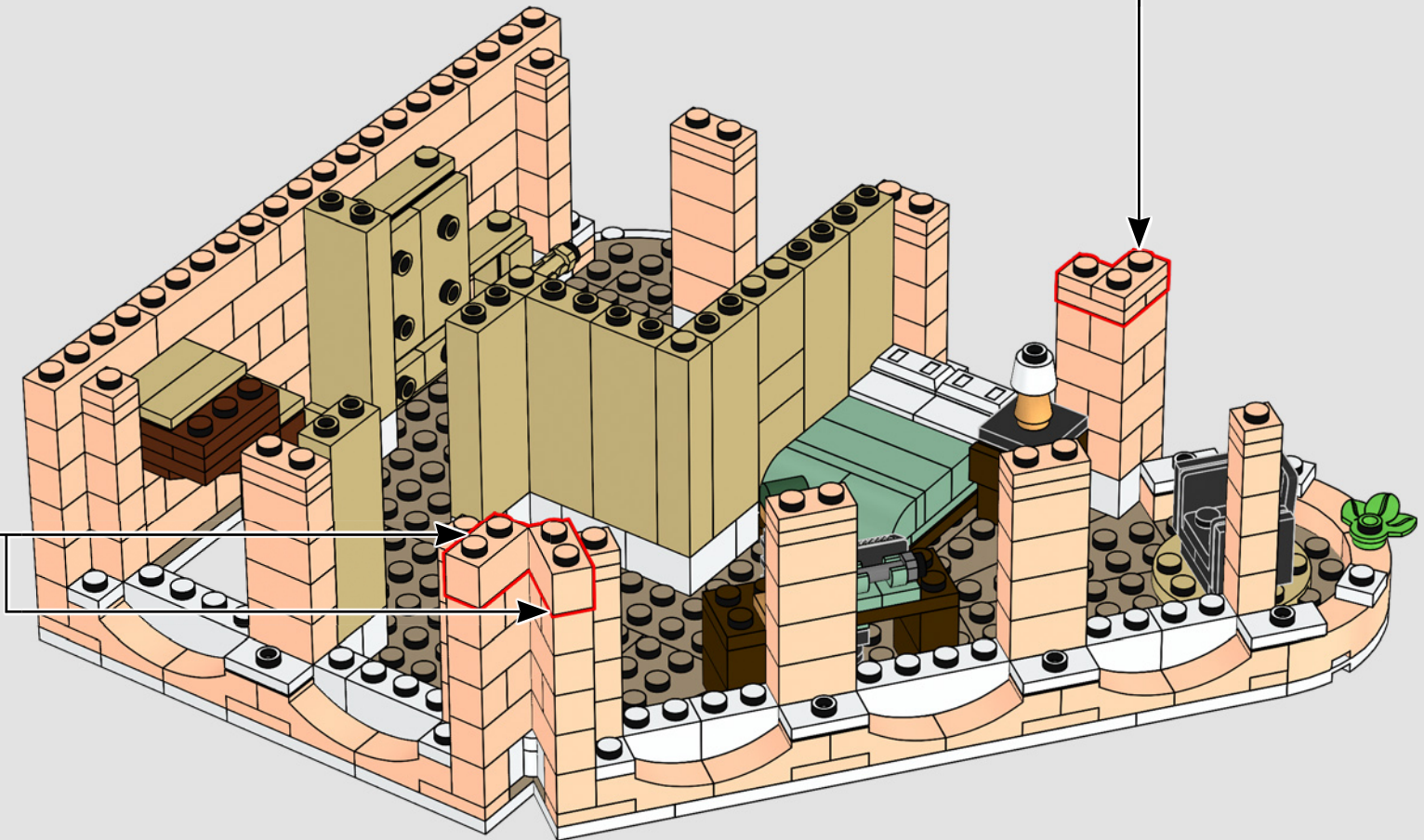
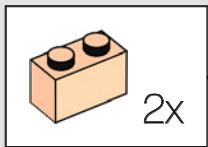
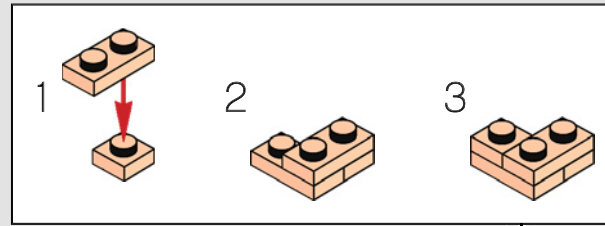

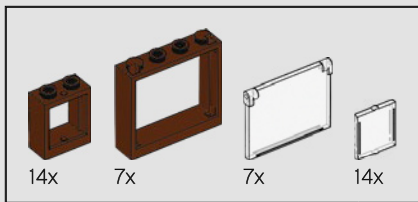

216

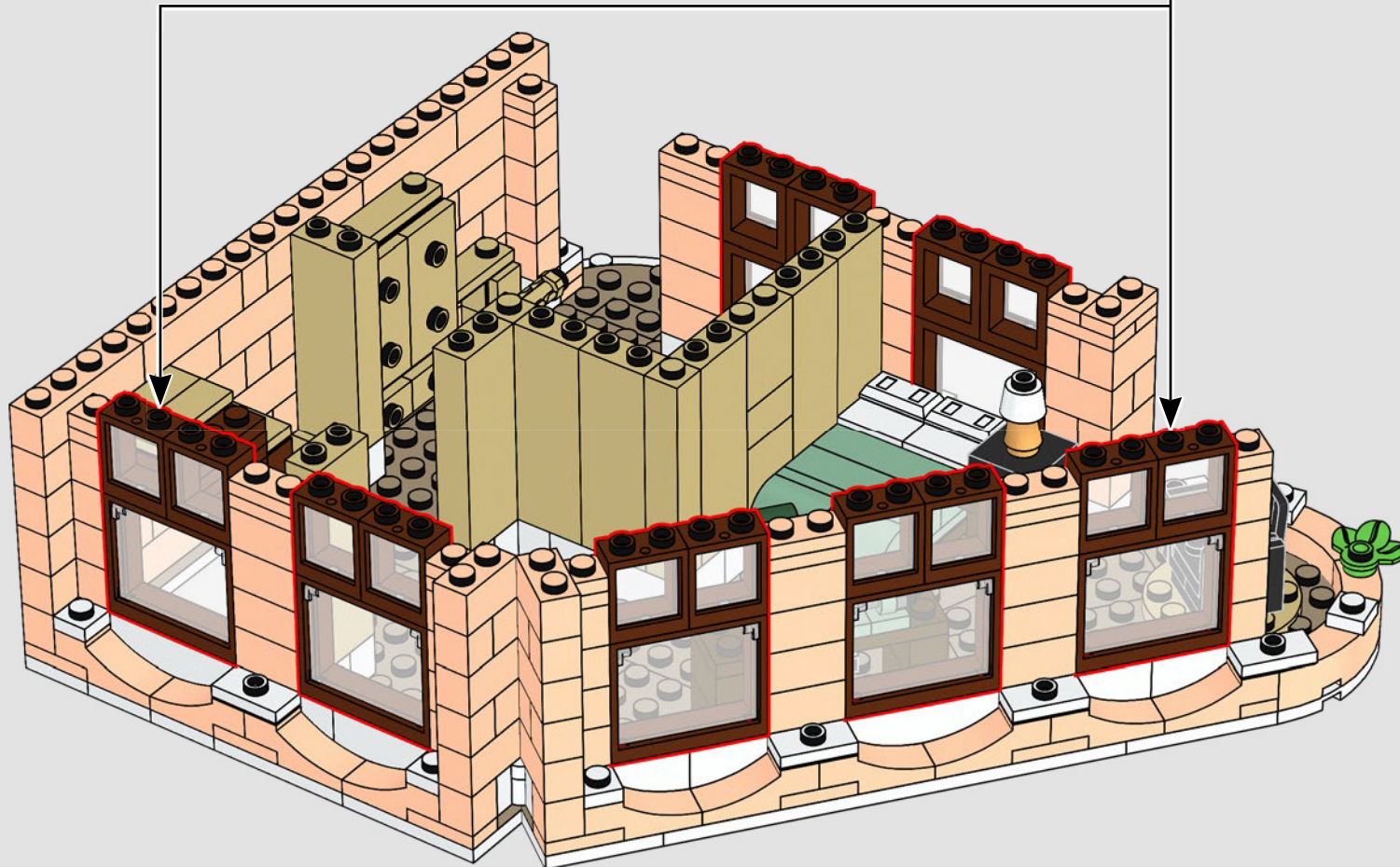
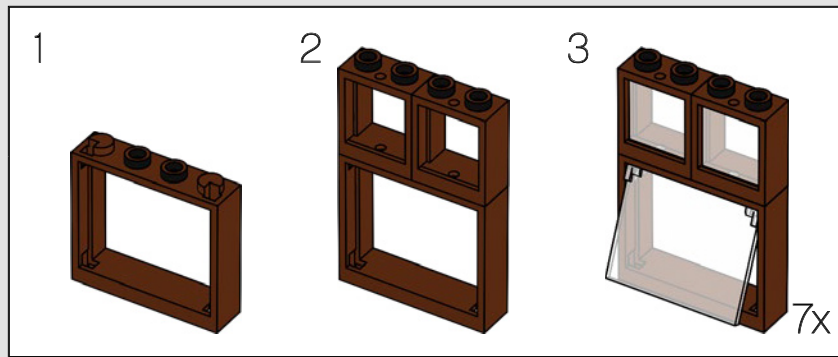

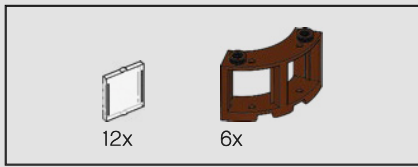

217

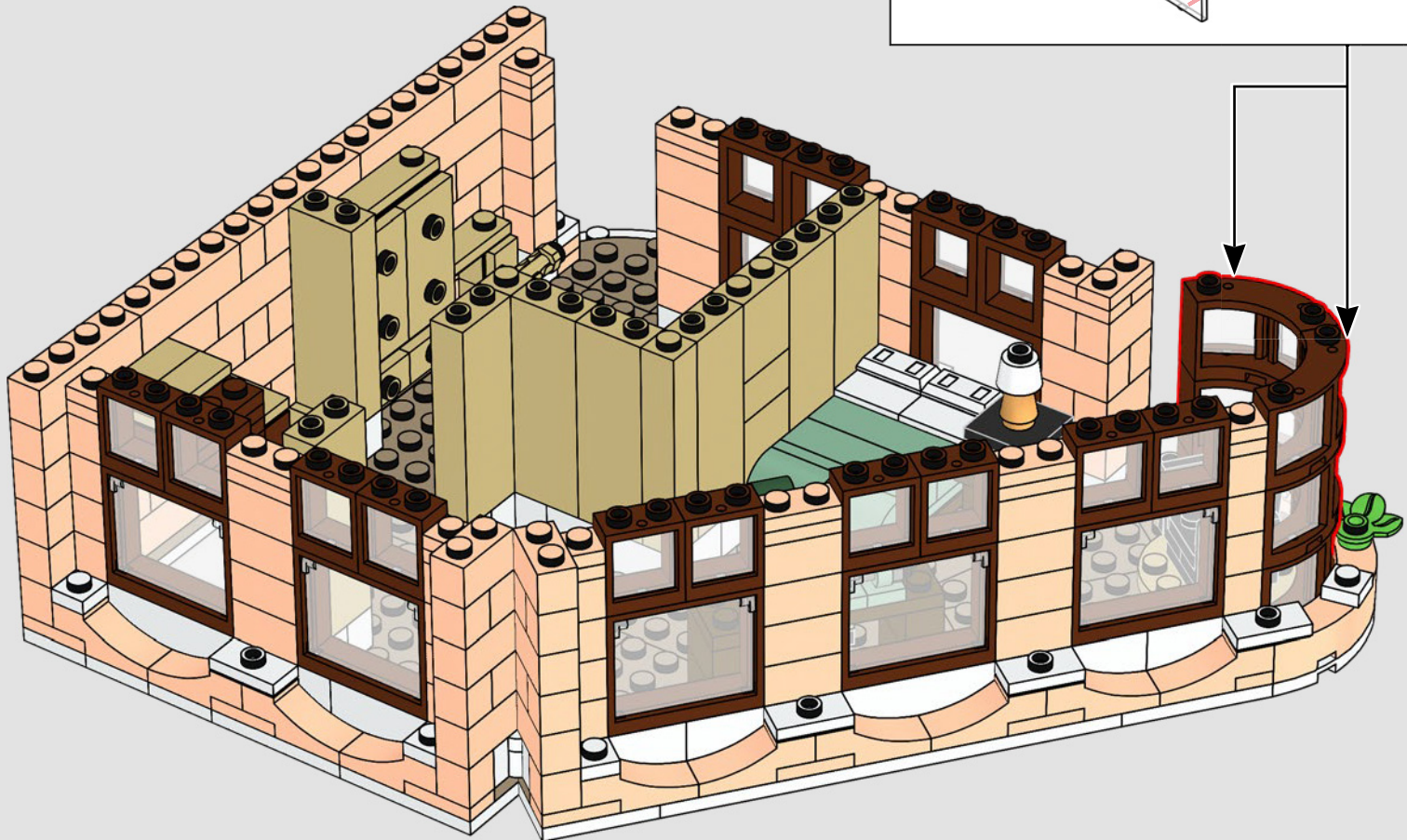
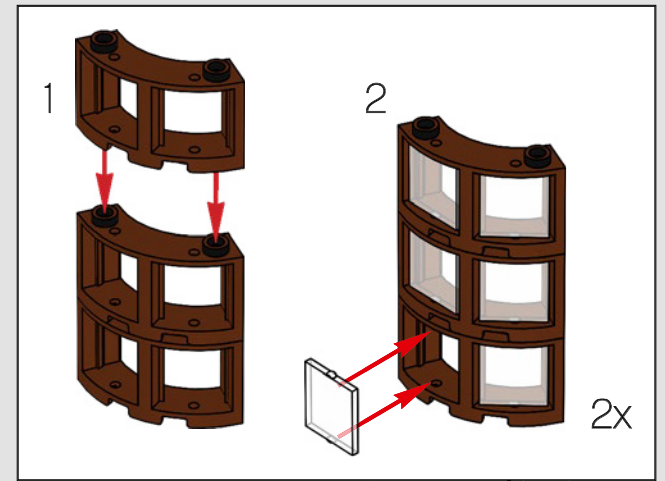

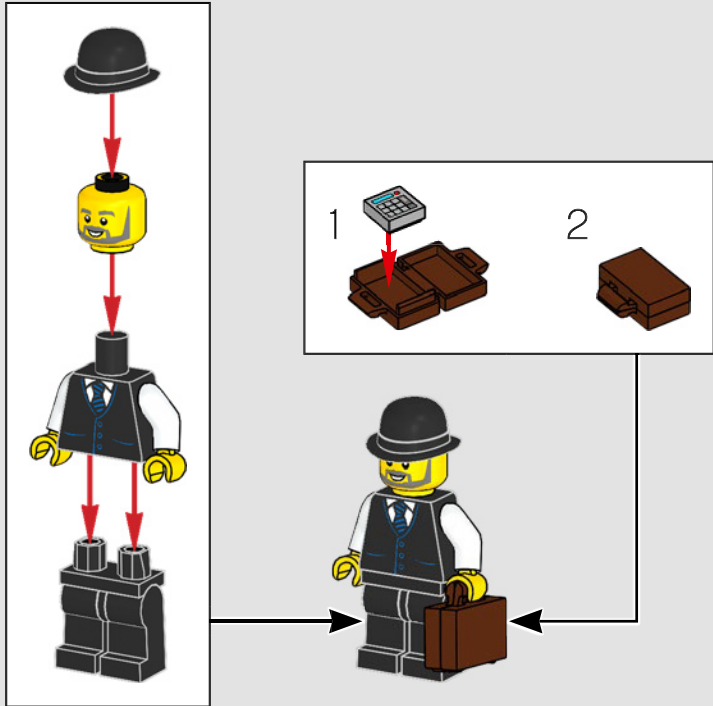
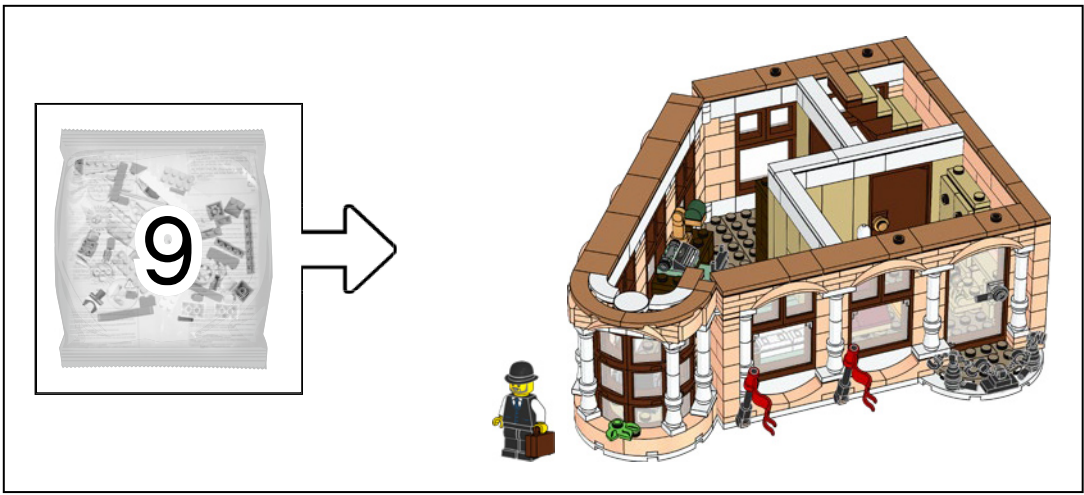

Der Buchhalter ist in der Stadt, um beim Verkauf der Meisterstücke aus der Kunstgalerie zu helfen. Allerdings muss er auch die Konten in der „Steine-Bank“ (10251) prüfen.



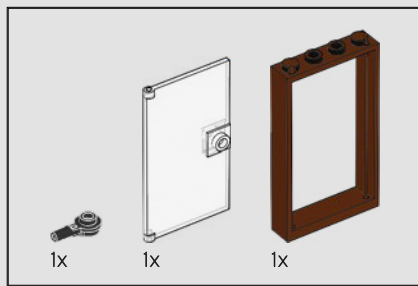

218

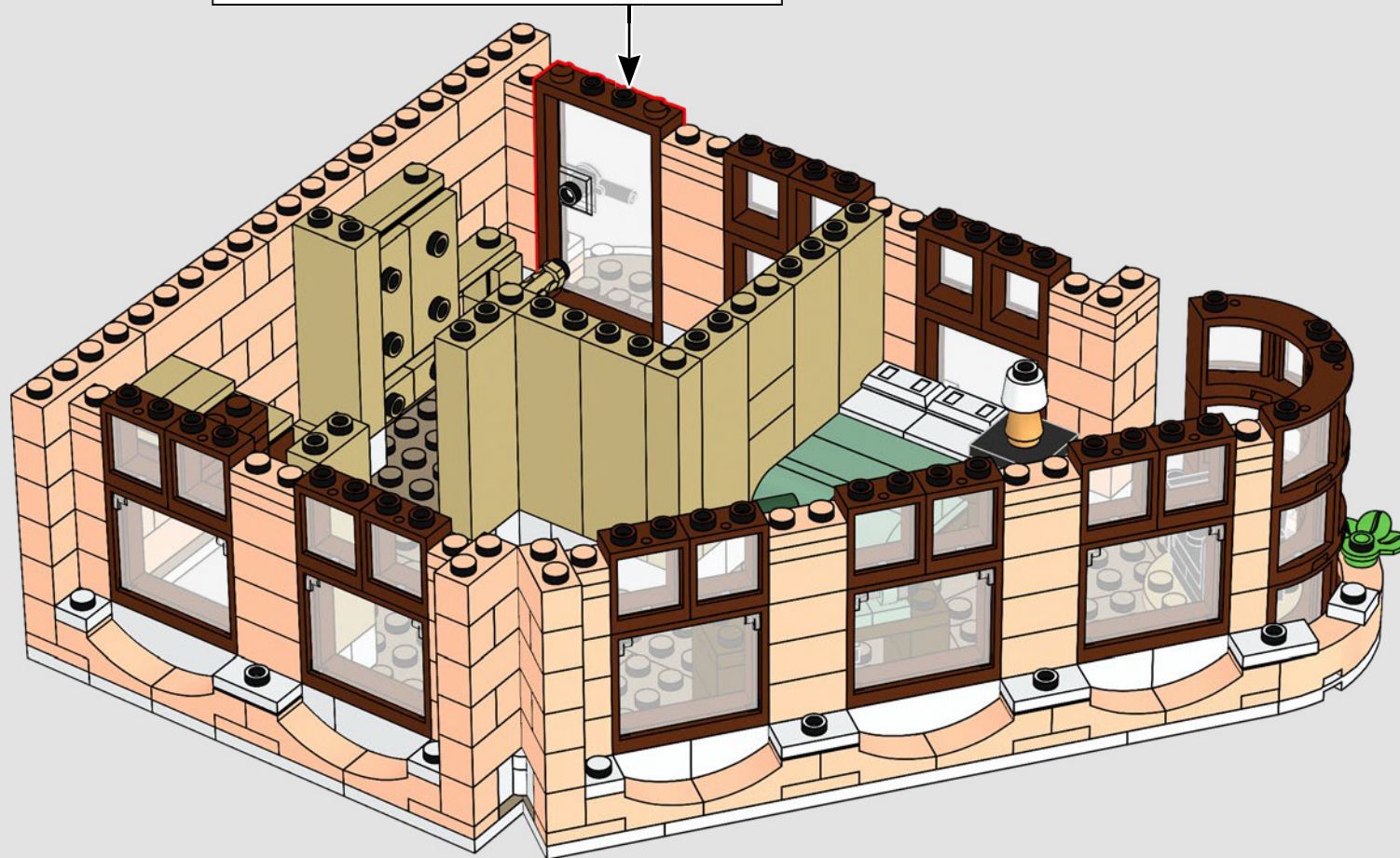
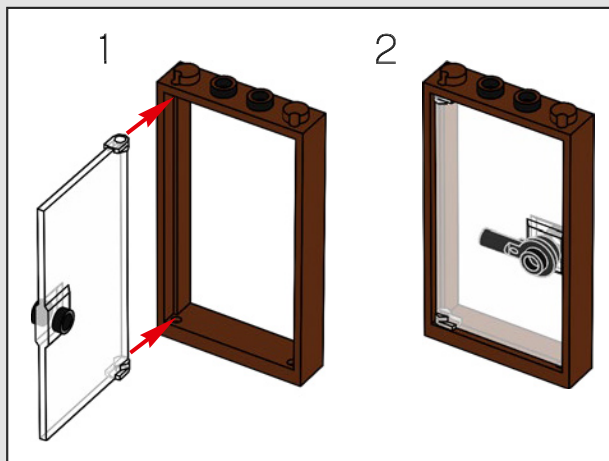

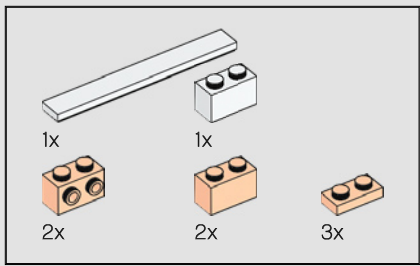

219

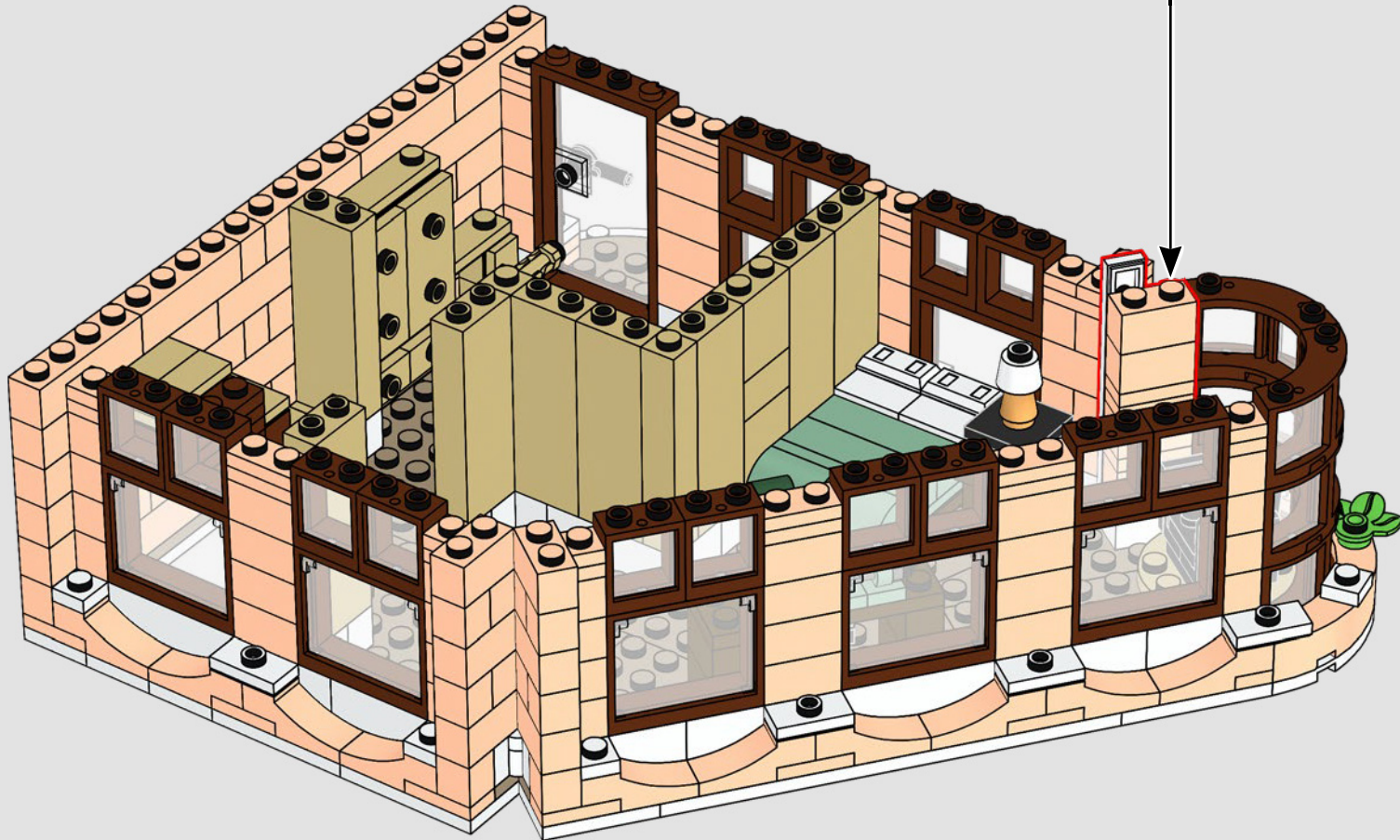
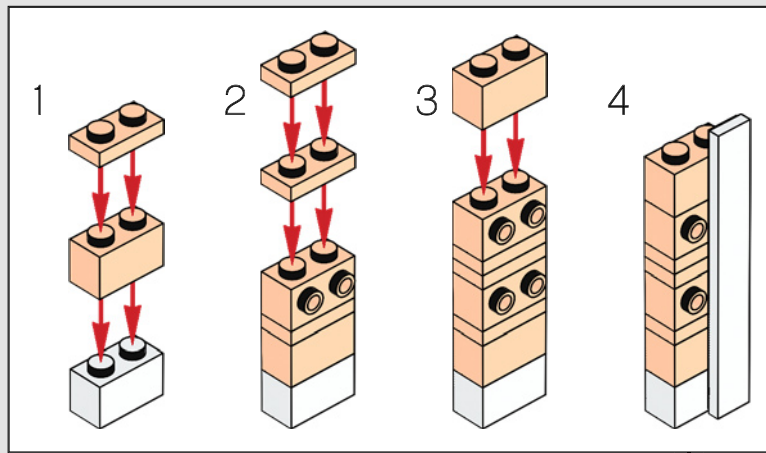

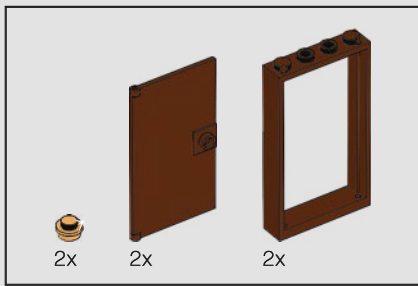

220

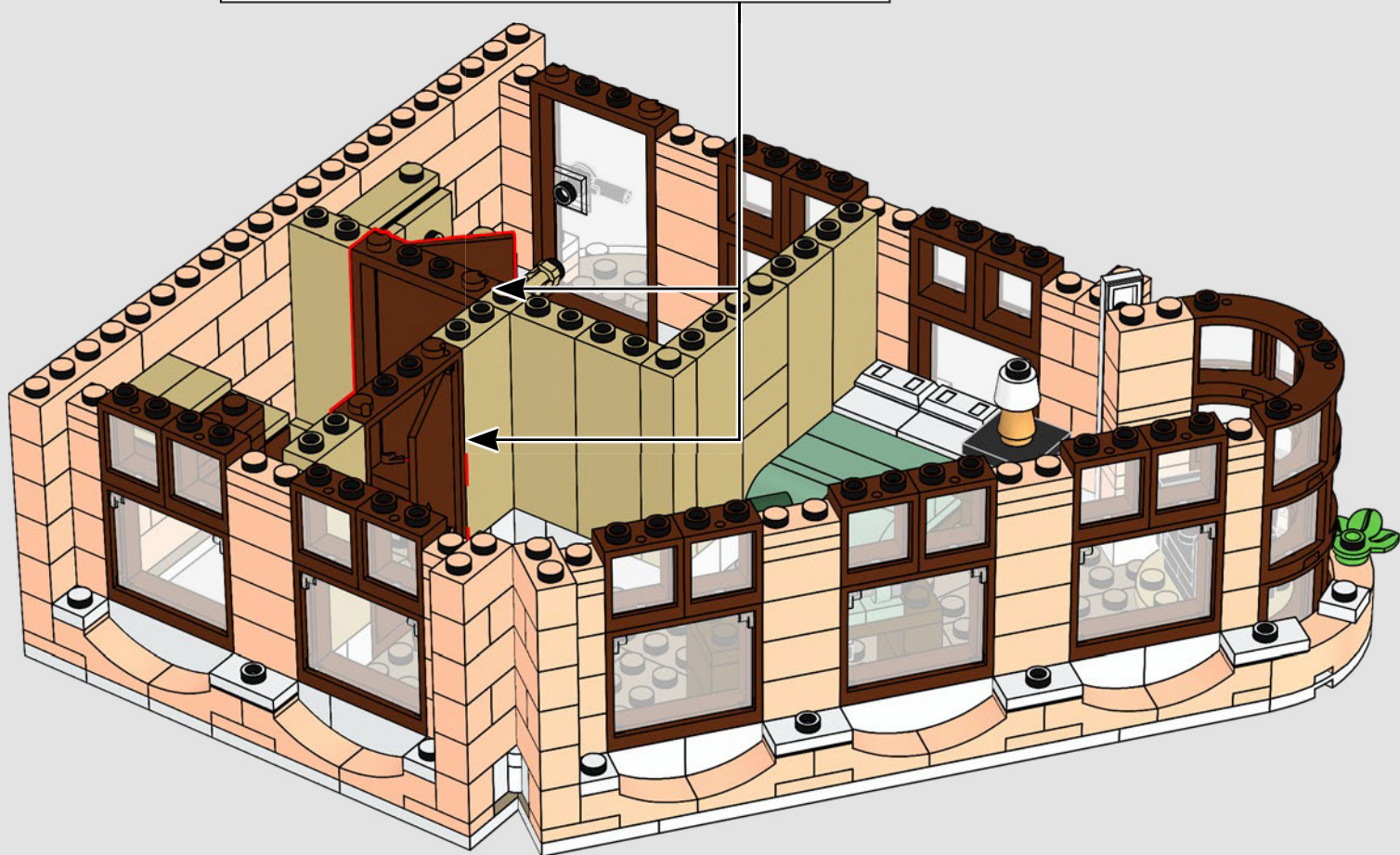
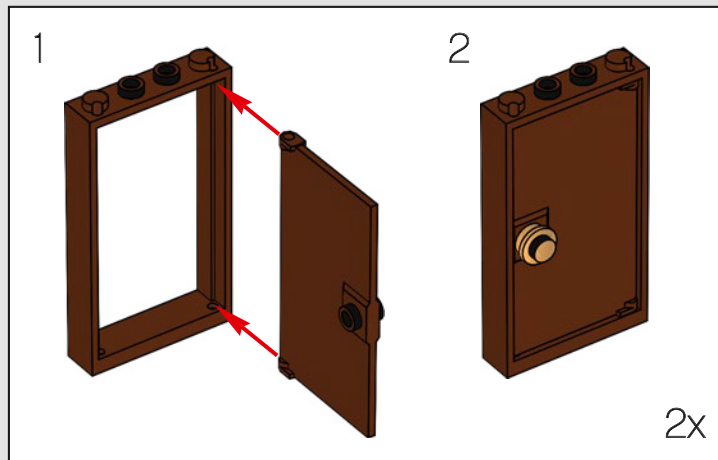

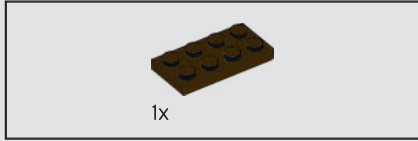
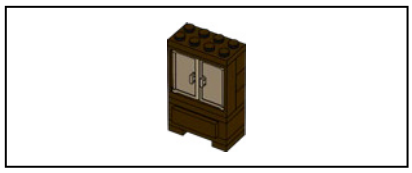

221

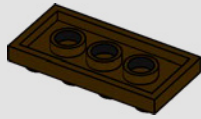

222

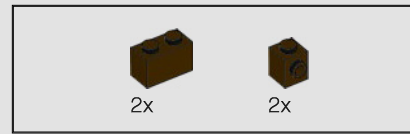
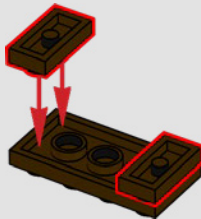

223

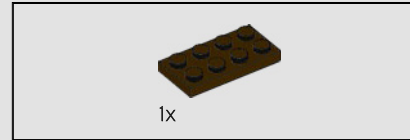
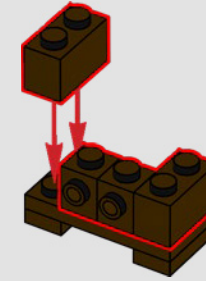
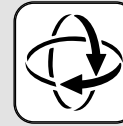

224

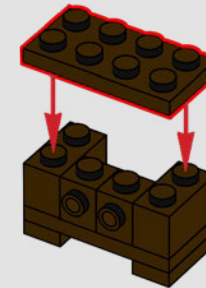

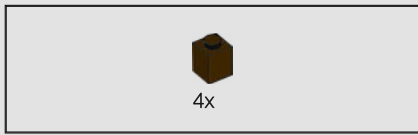

225

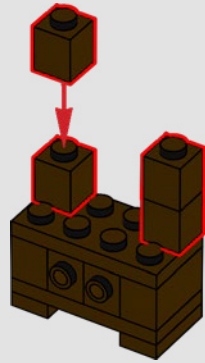

226

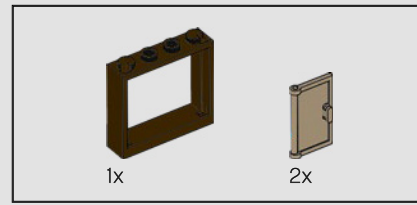
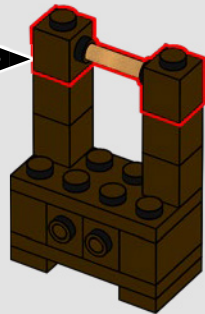
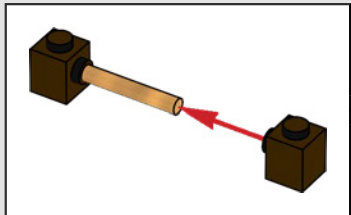

227

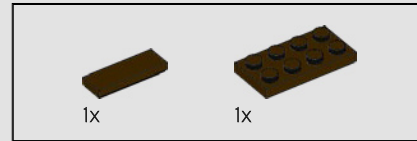
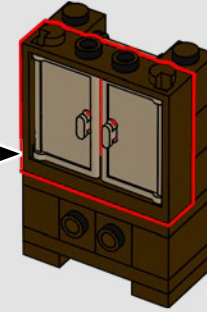
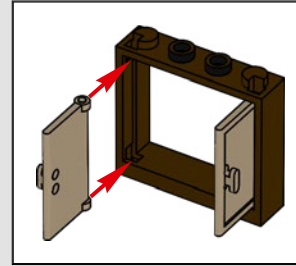

228

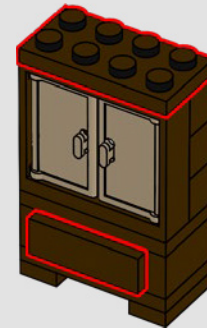

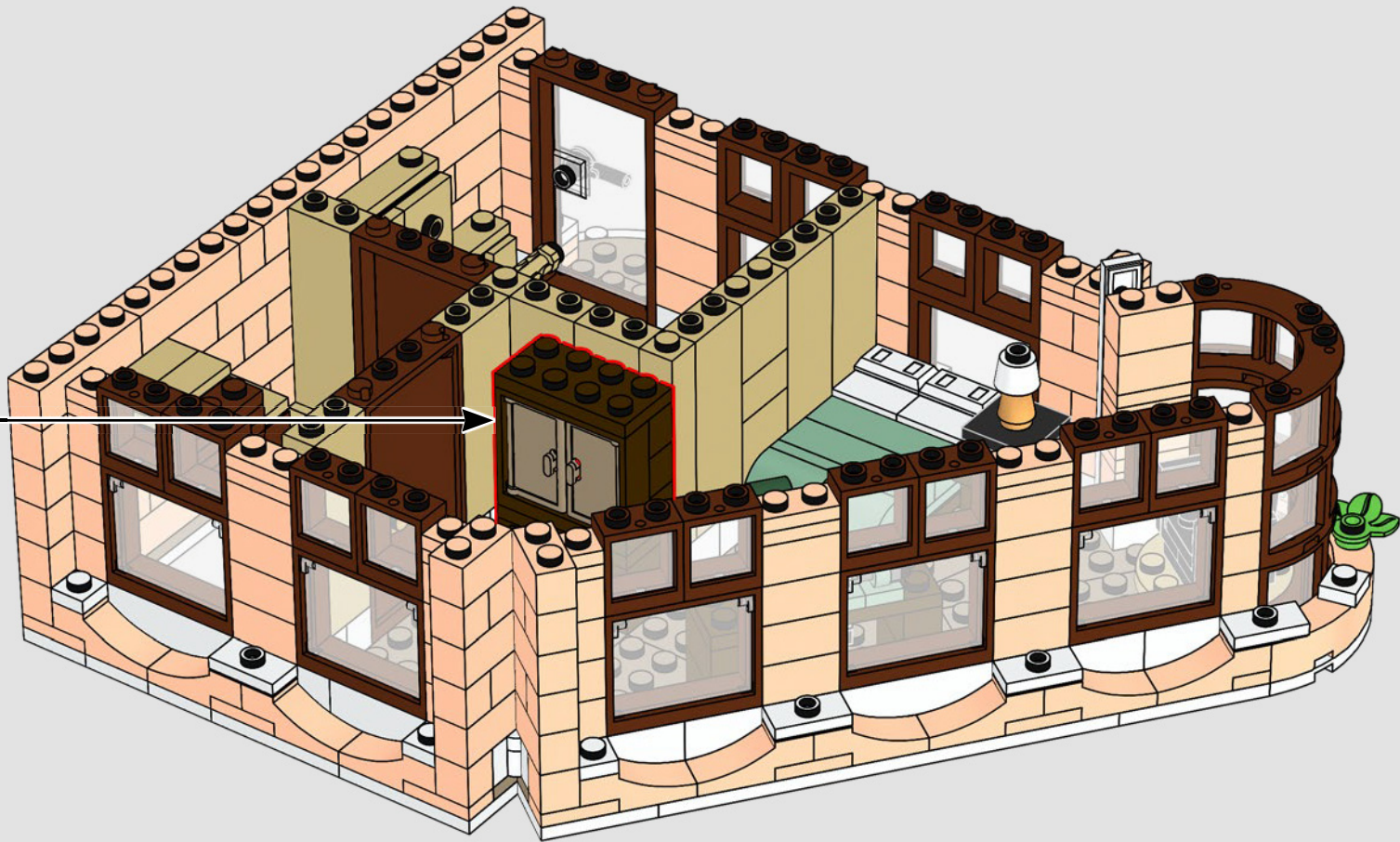



230

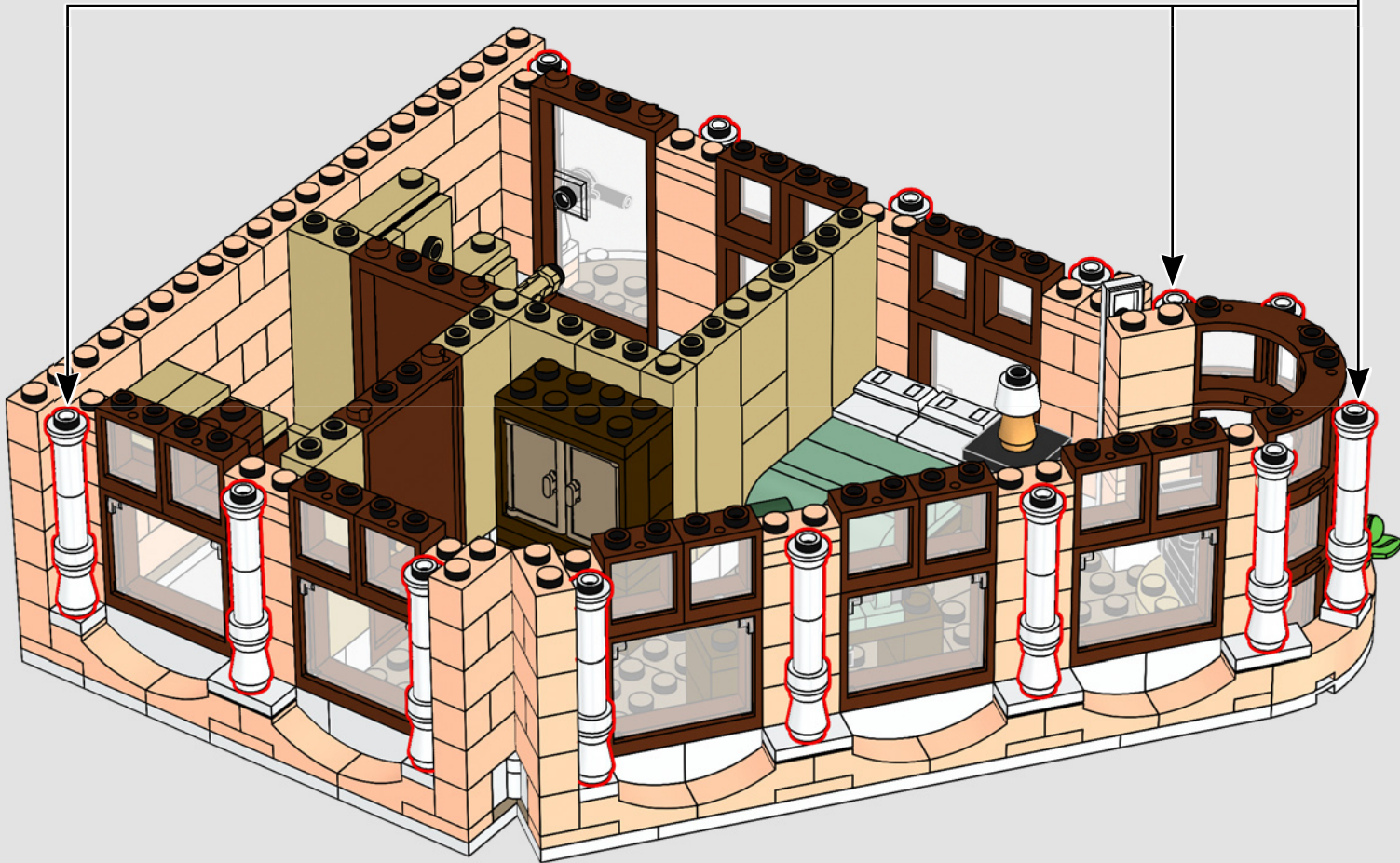
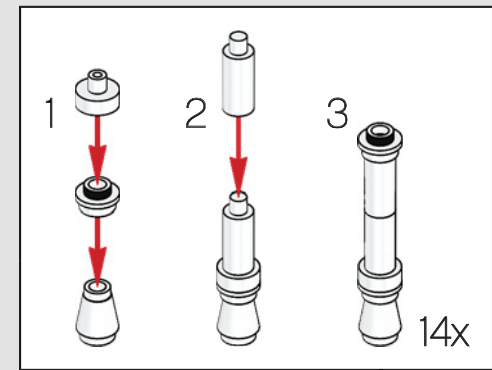

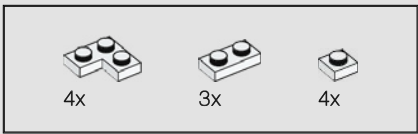

231

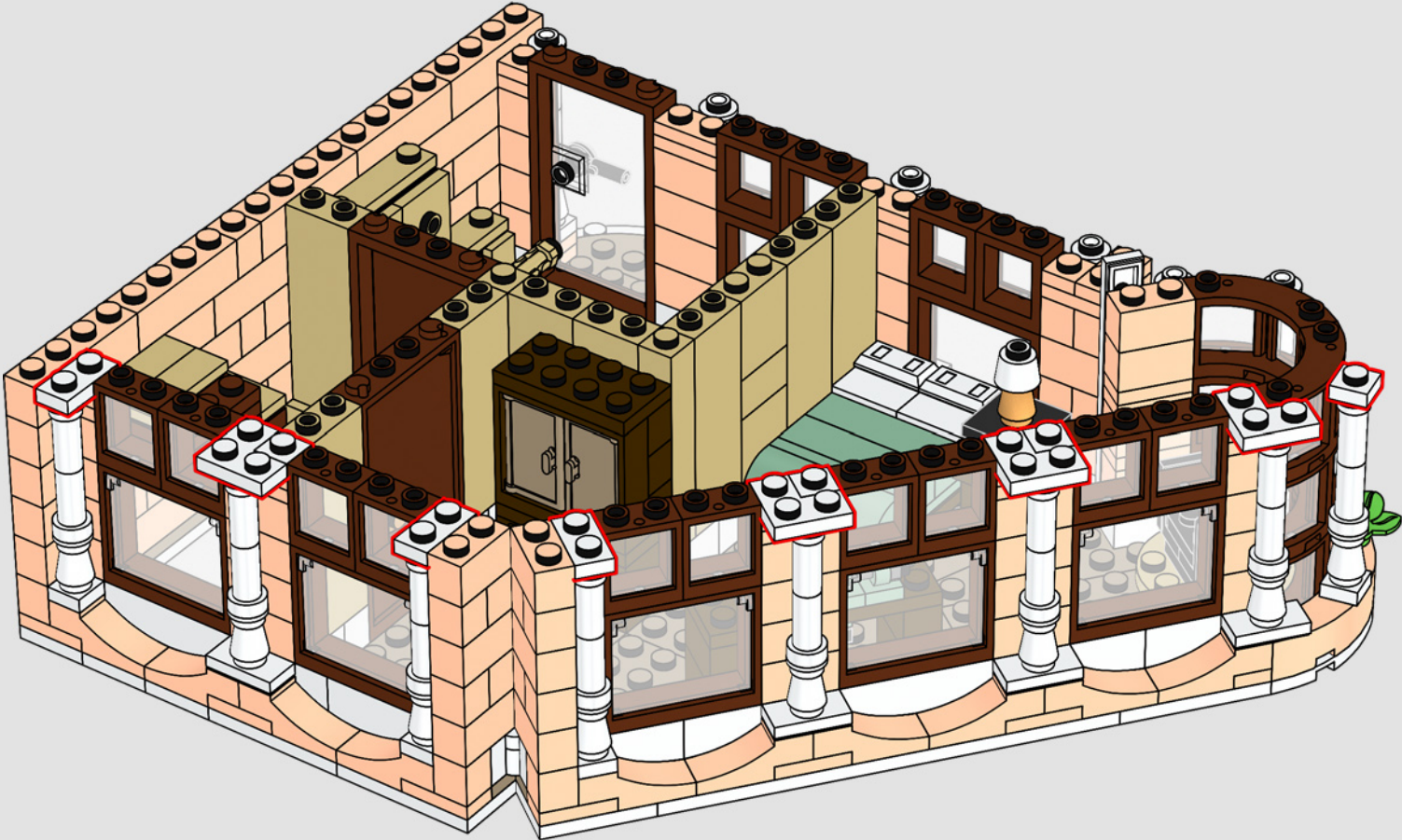



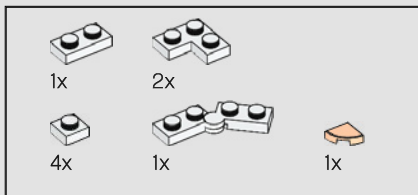

232

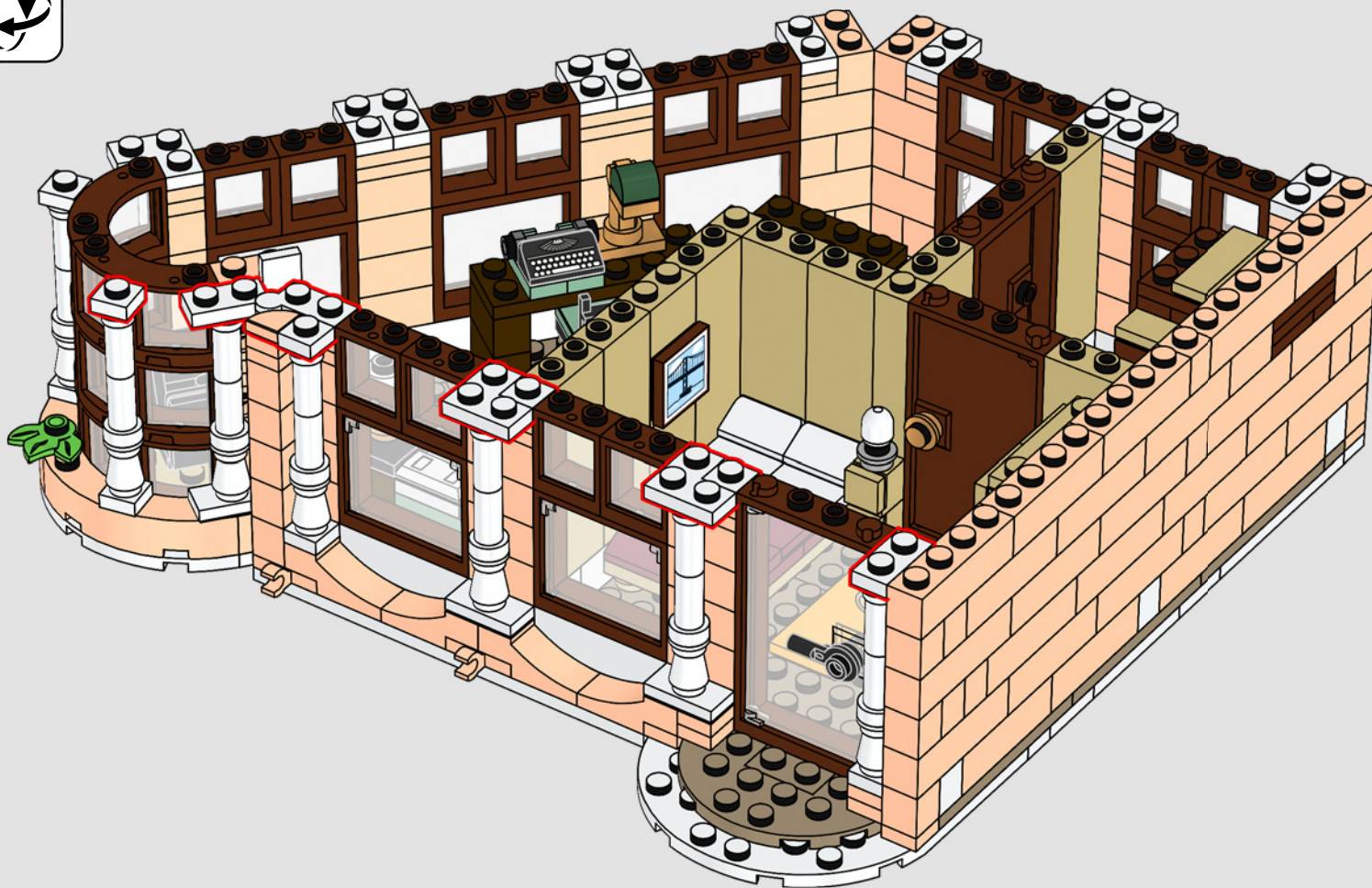



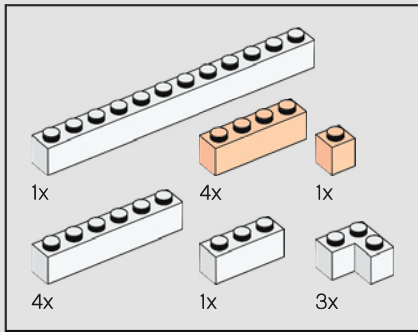

234



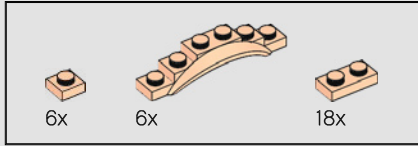
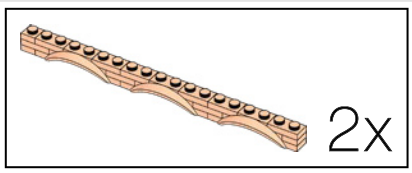

235

1

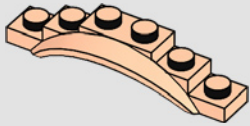

2

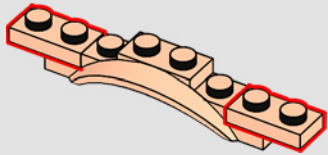

3

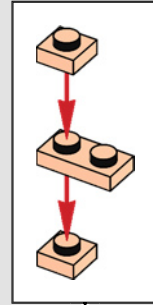
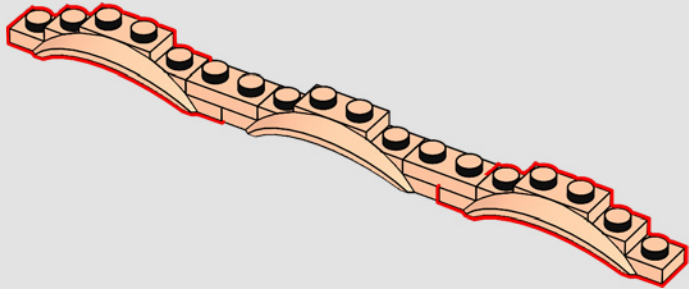

4

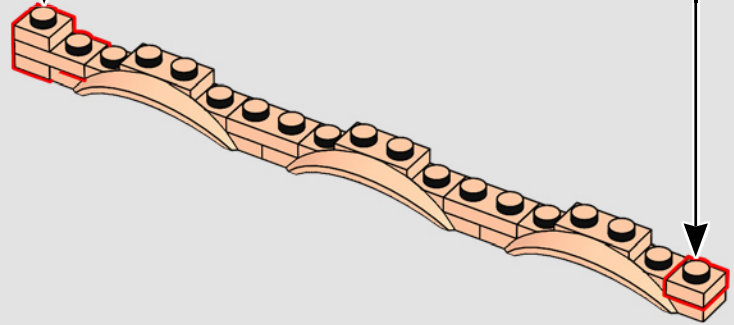

5

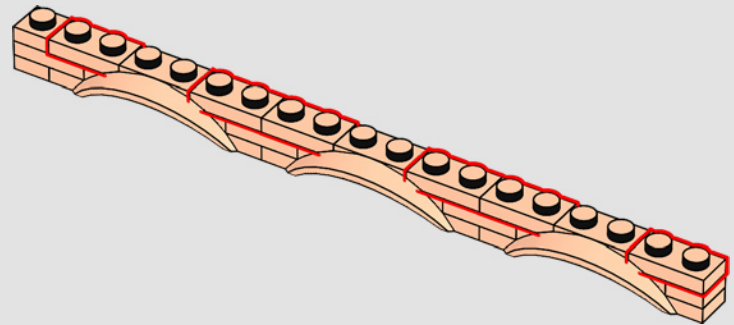

2x

236



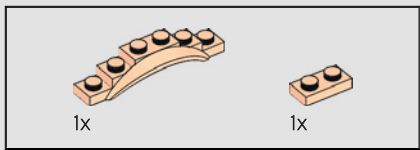

237

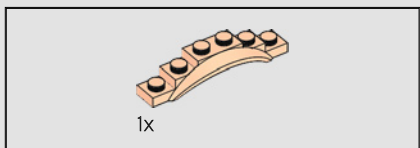
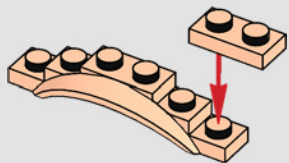

238

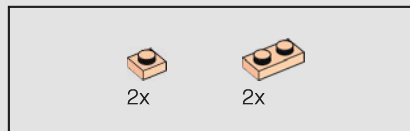
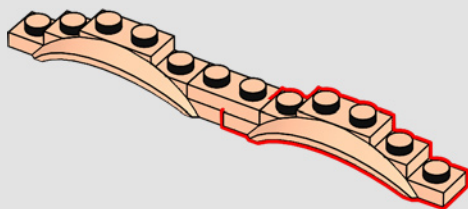

239

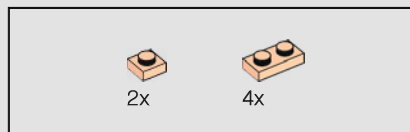
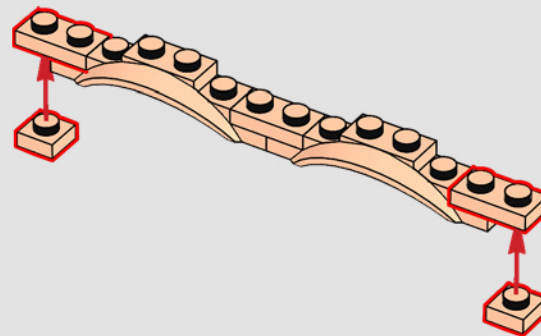

240

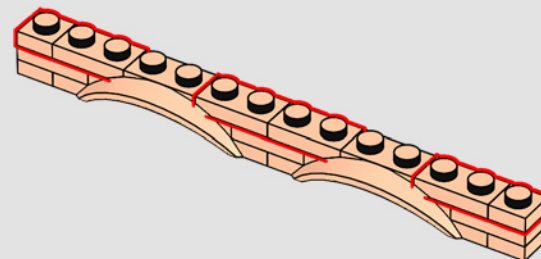

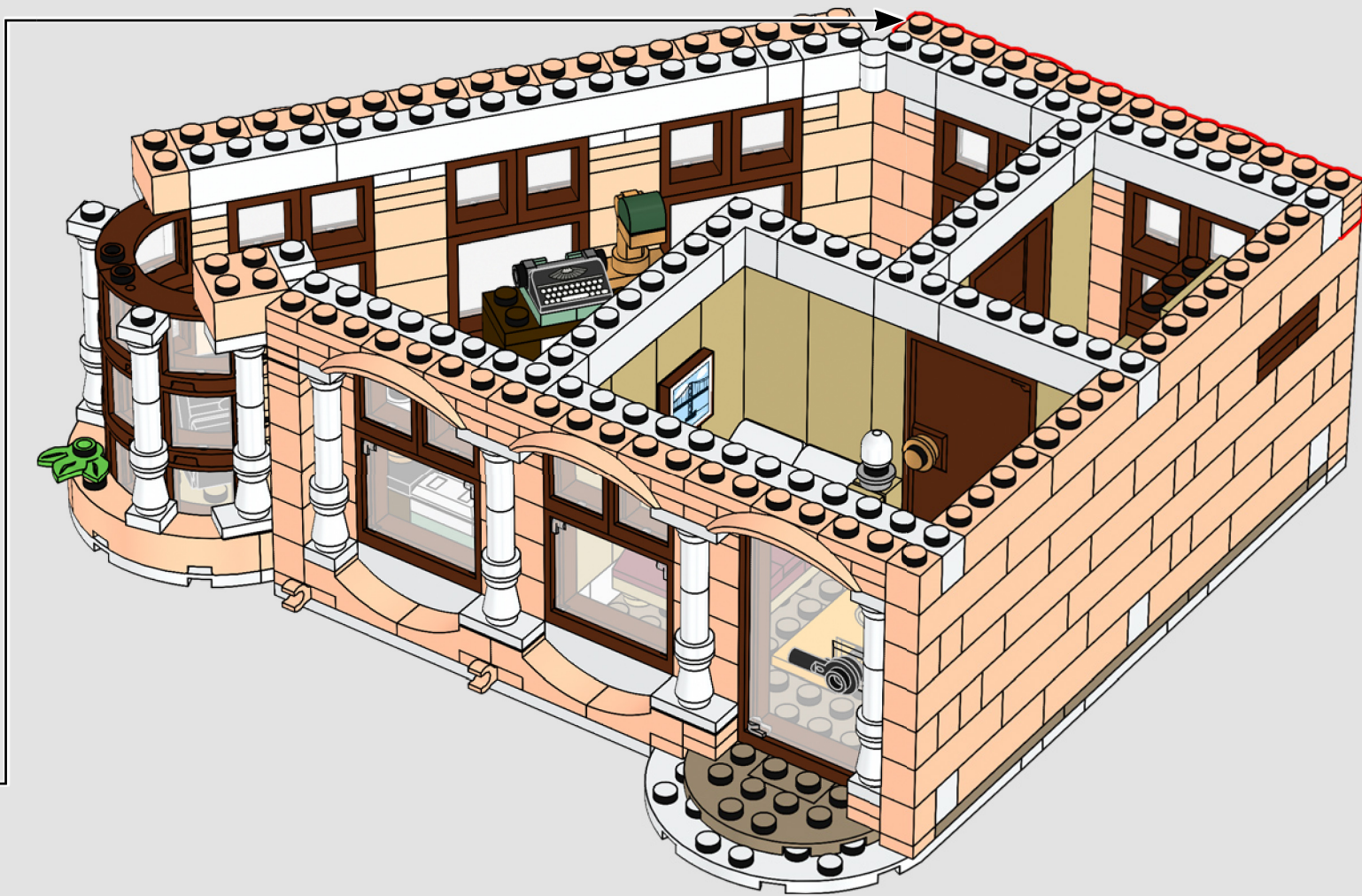

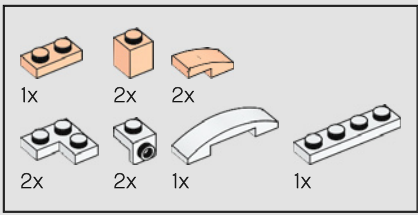

242

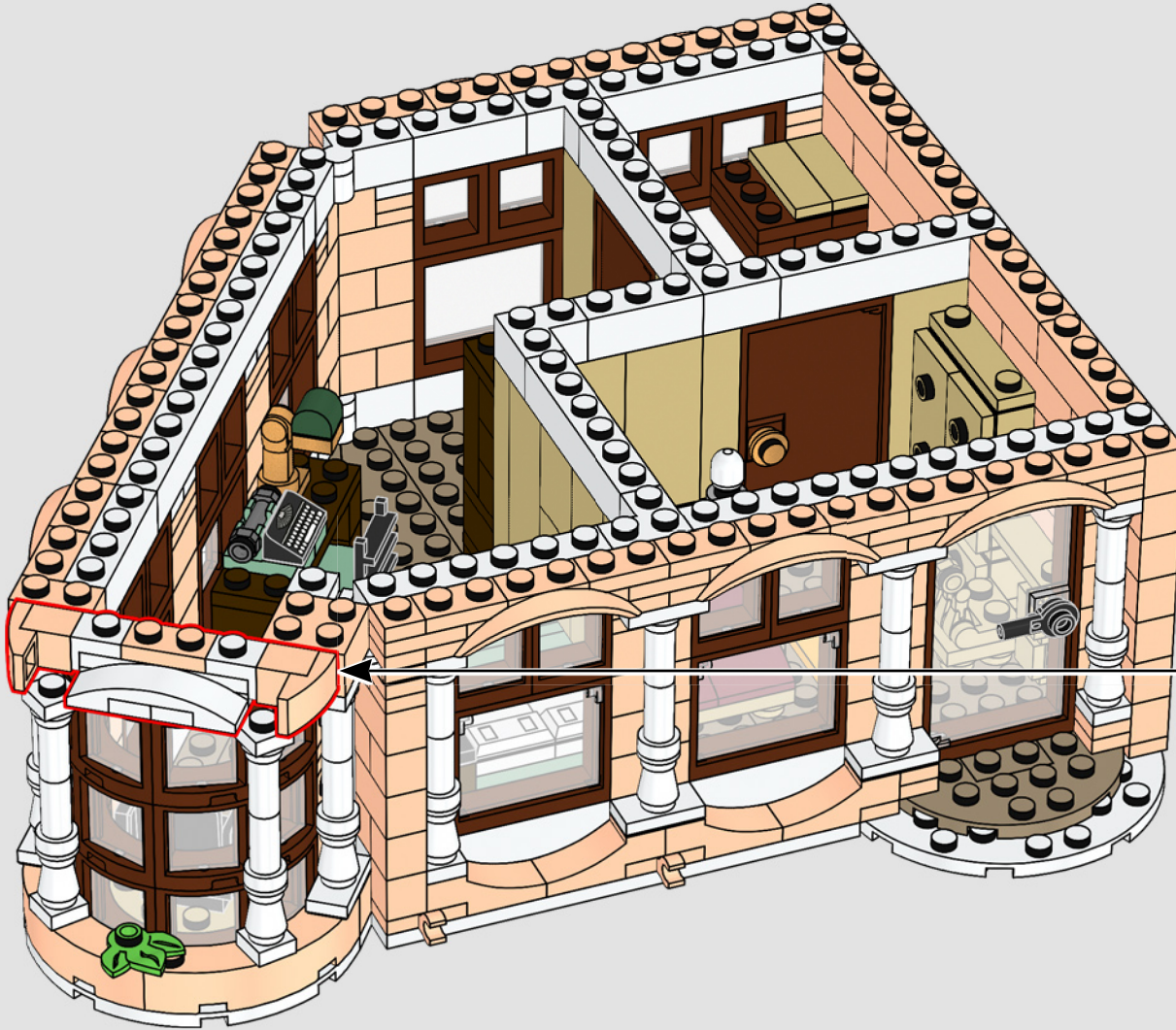
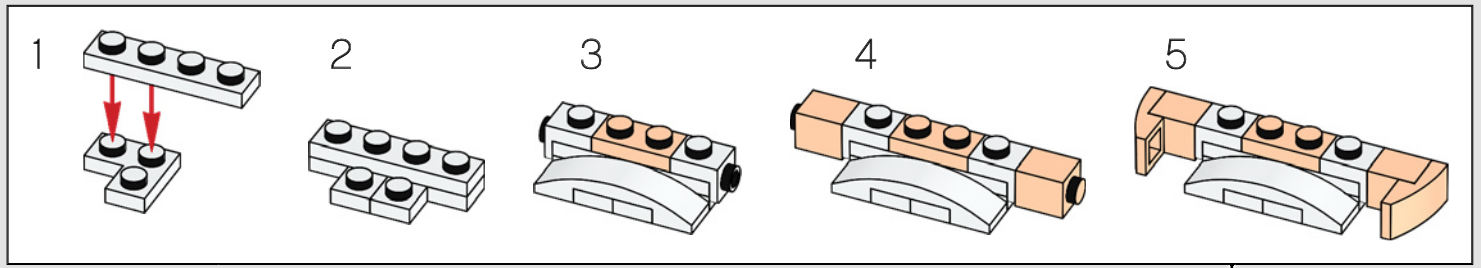



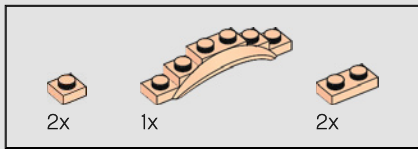

243

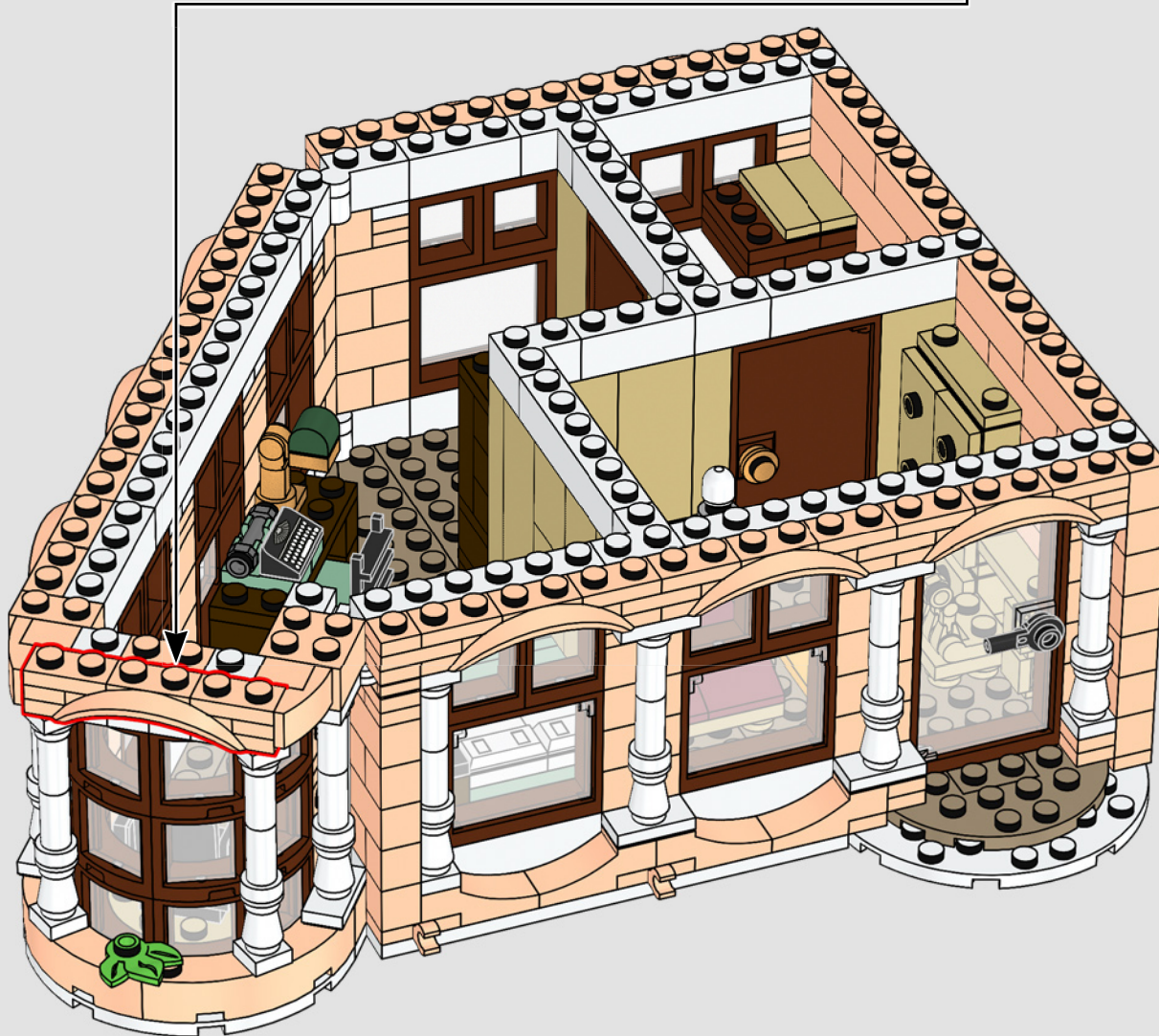
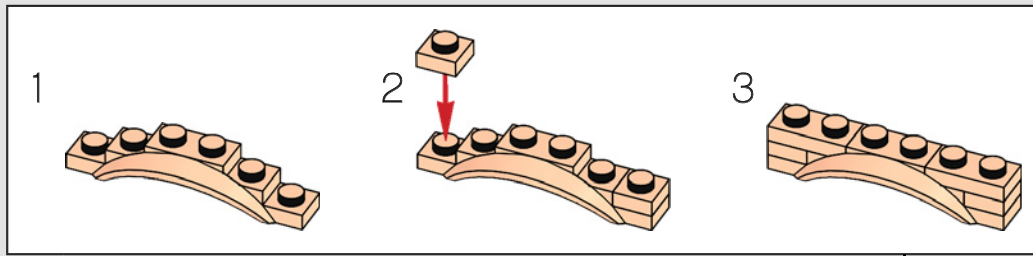

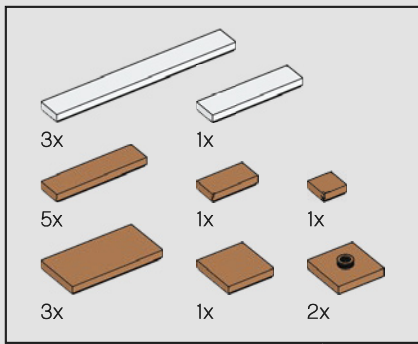

244



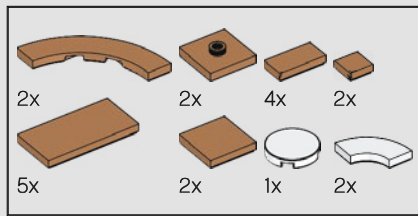

245

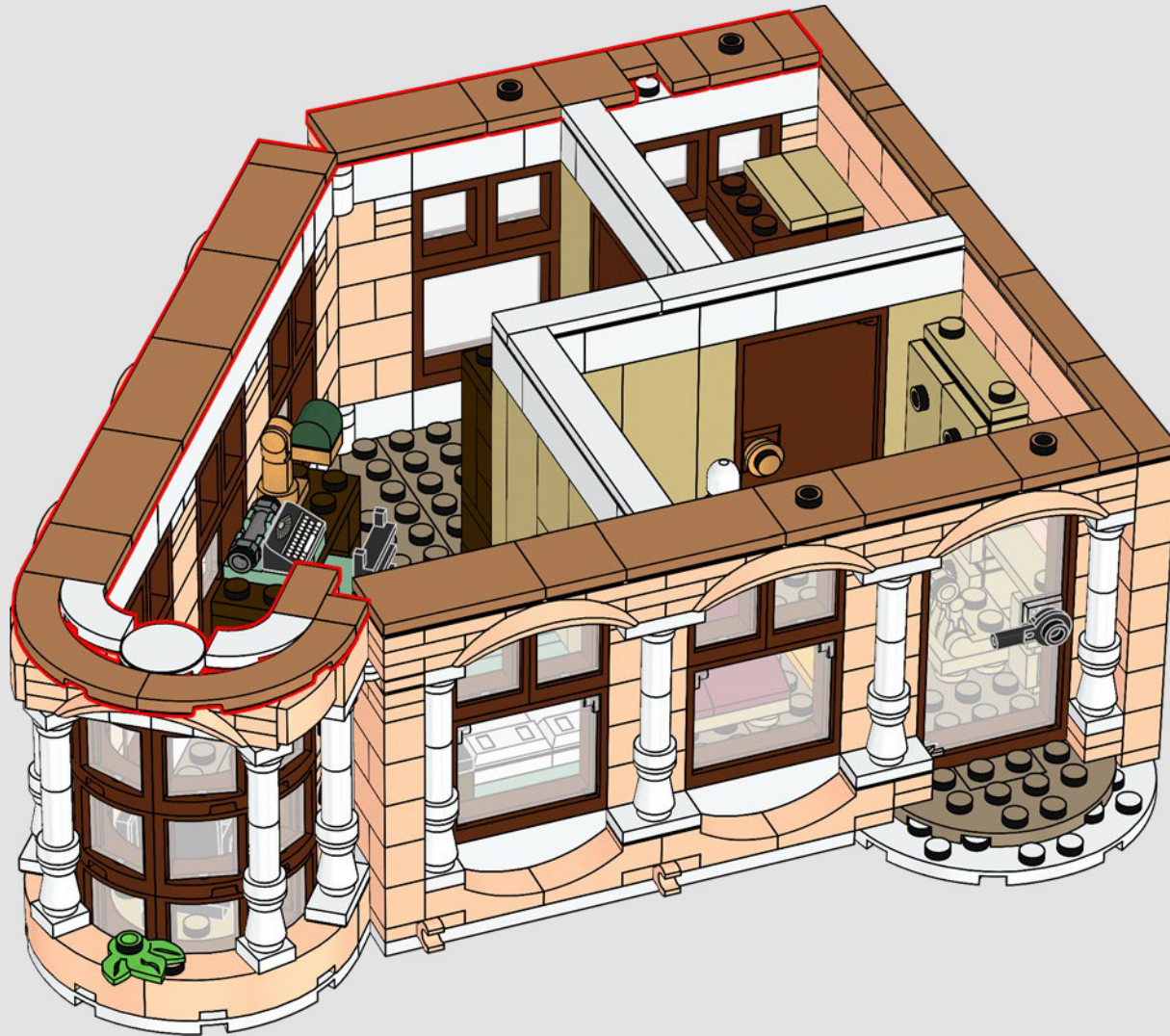

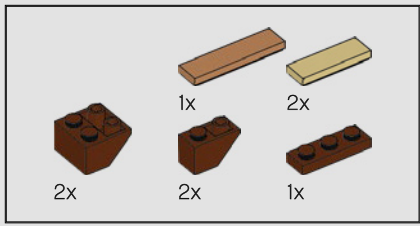

246

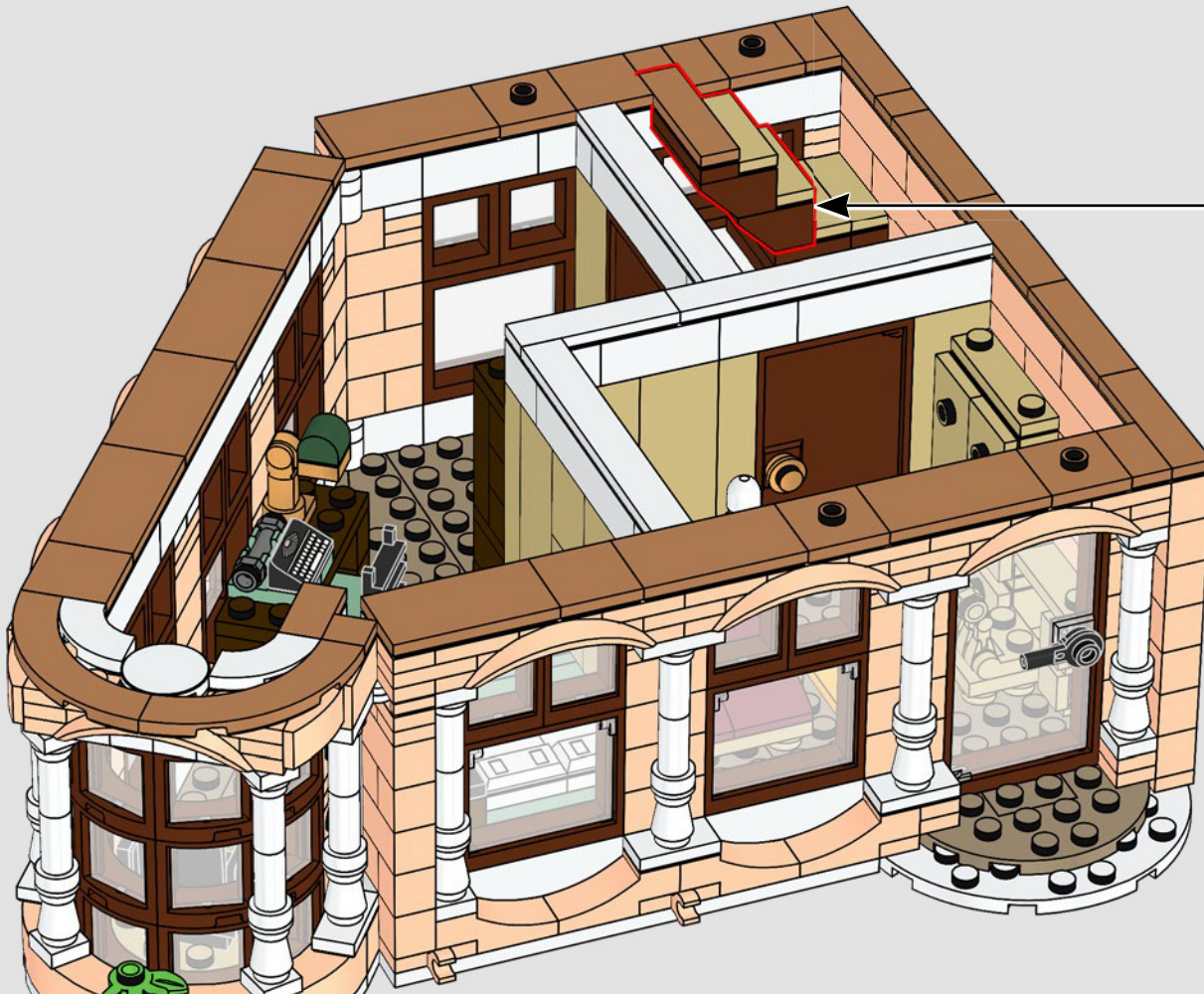
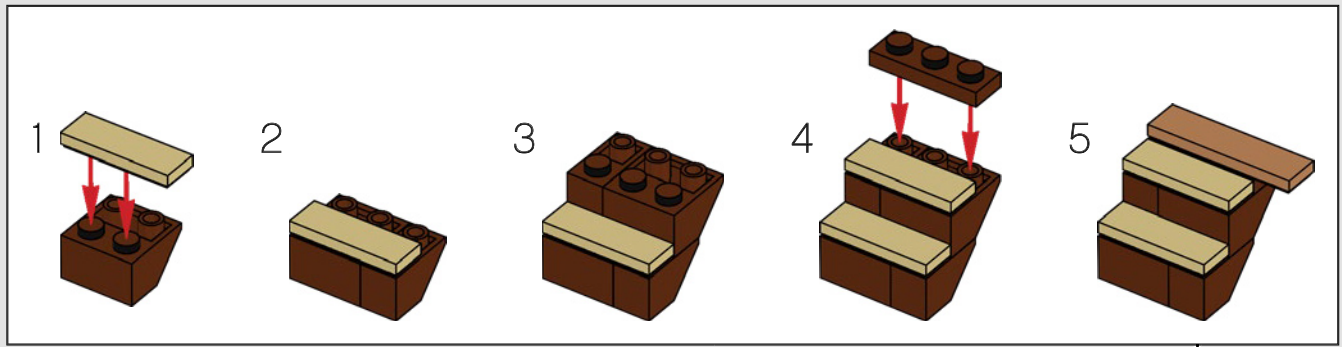

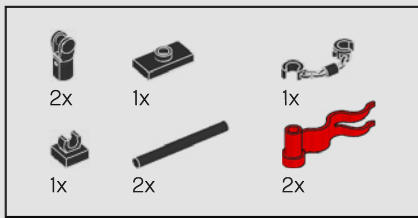

247

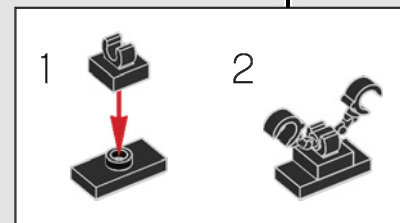
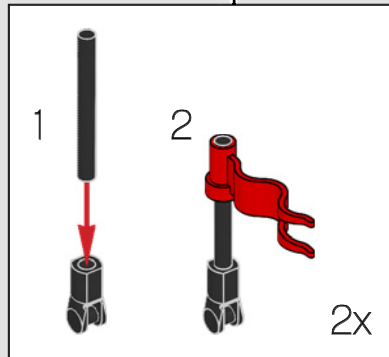



Die Beine des Minifigur-Skeletts wurden schon für den Balkon im Set „Gemüsehändler“ (10185) benutzt.

248

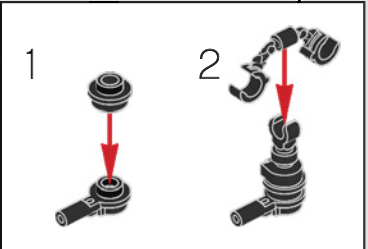
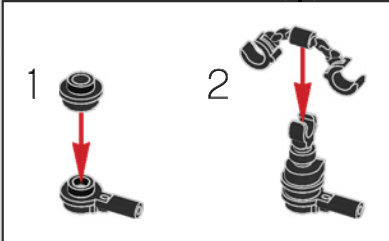
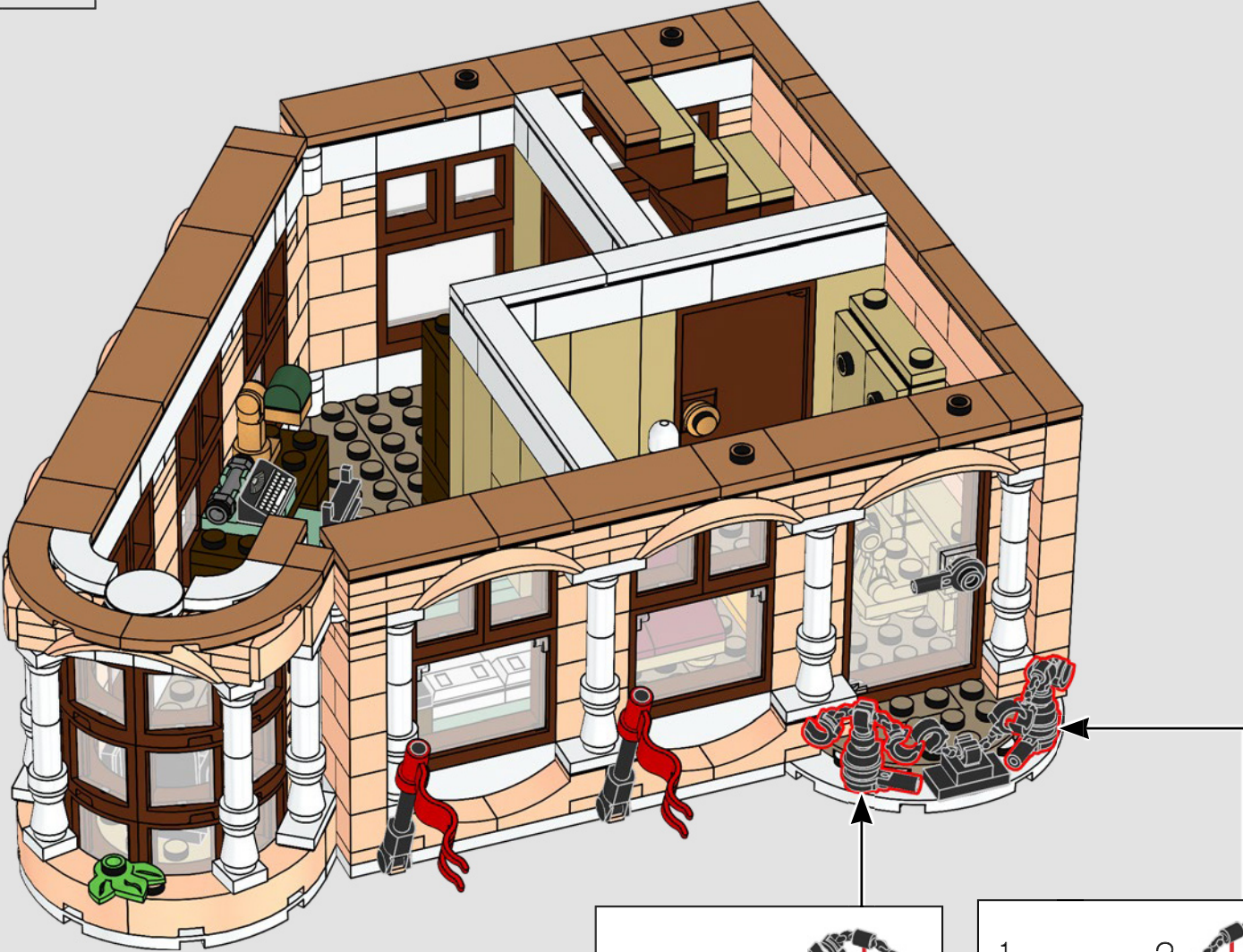



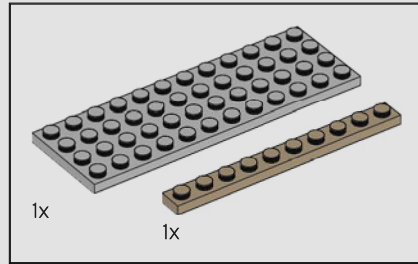

250

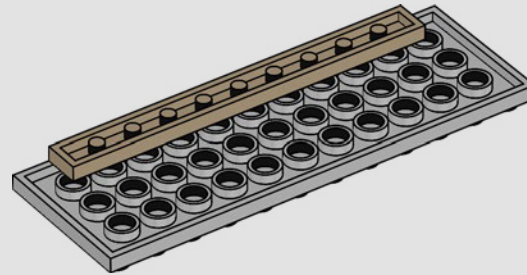



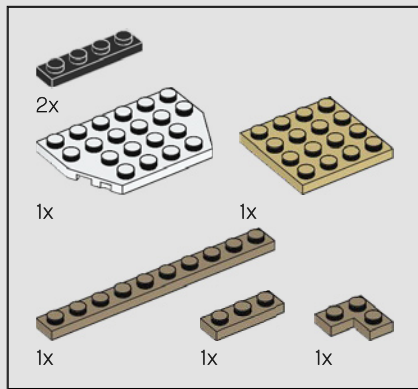

251

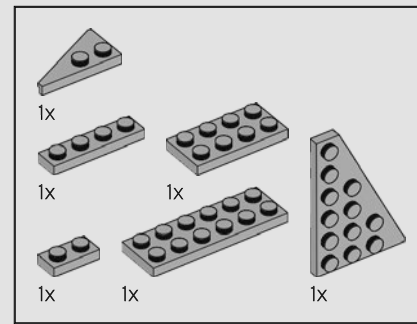
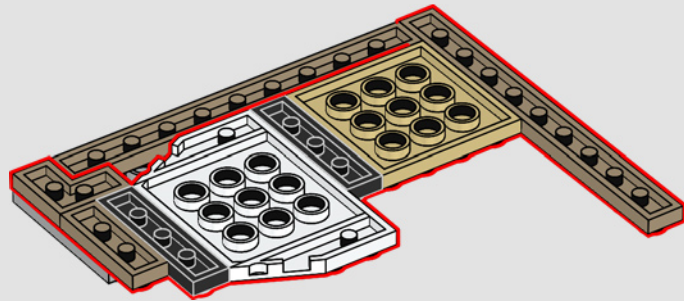

252

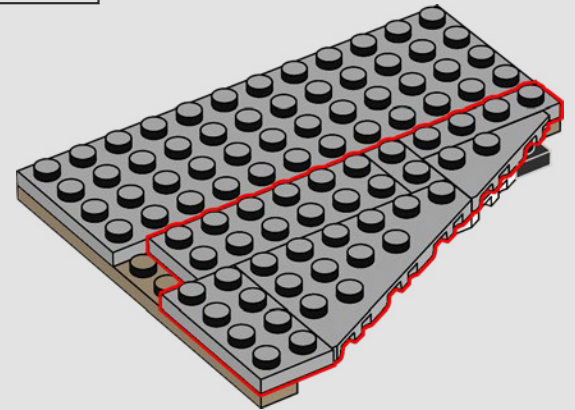
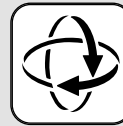

253

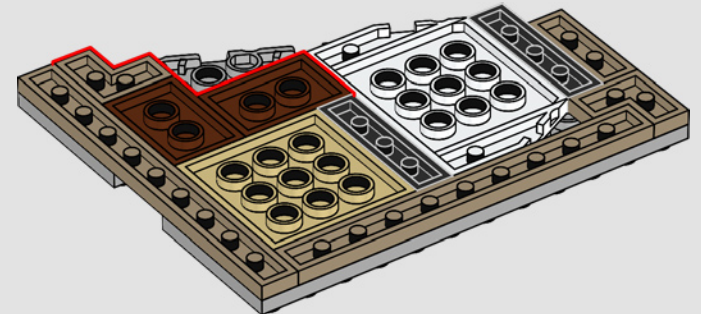

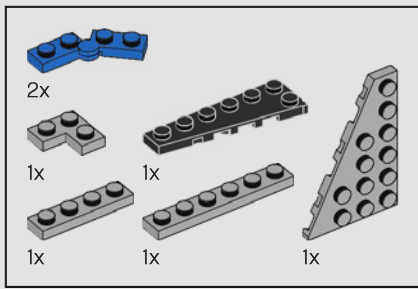

254

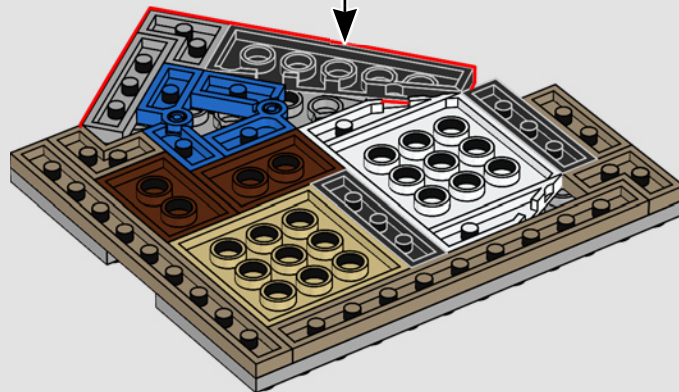
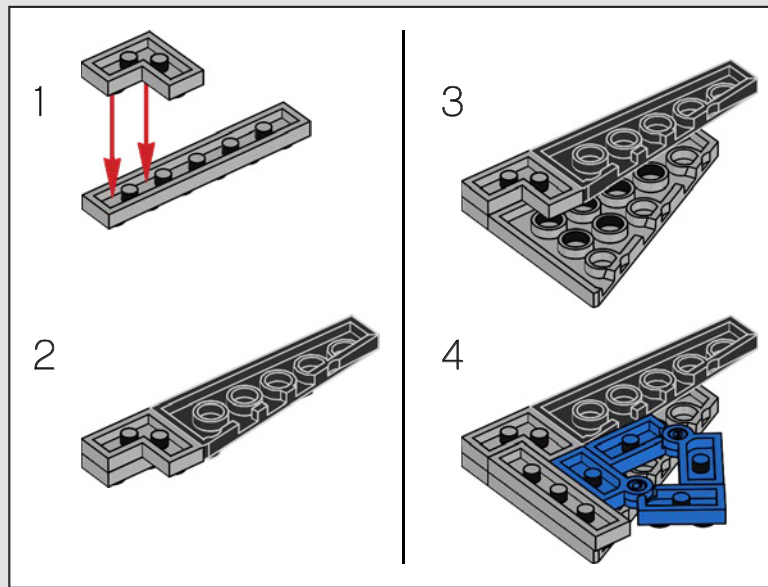

Die Terrasse wird nach dem Prinzip des Spiegeldreiecks gebaut. In Kombination mit dem Hotelgebäude entstehen rechtwinklige Dreiecke,

178 die perfekt zum LEGO® Gittersystem passen.

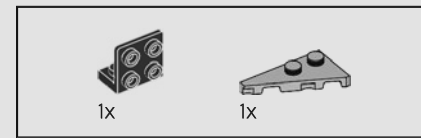

255

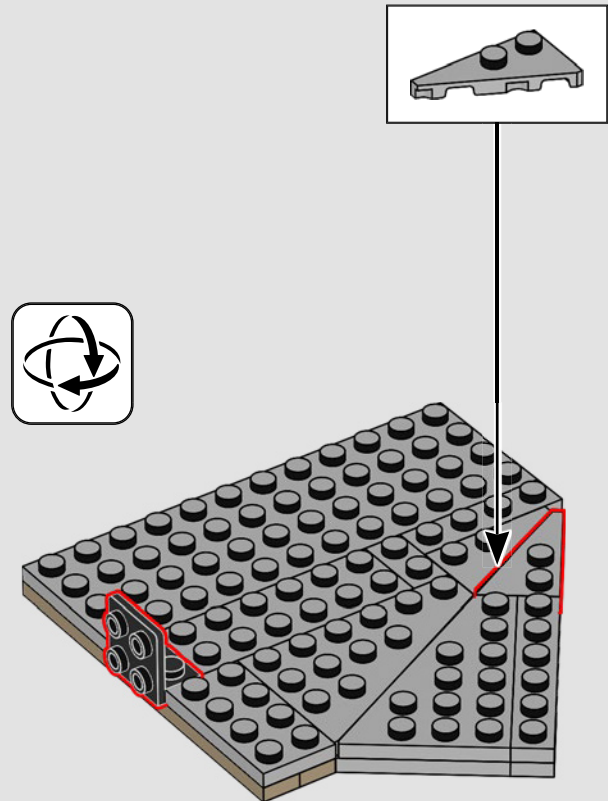
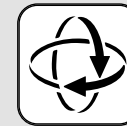

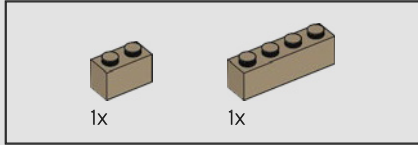
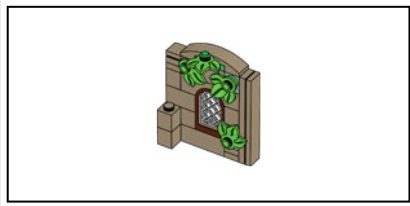

256

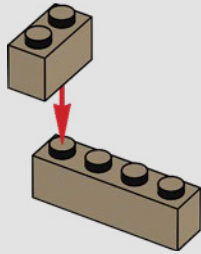

257

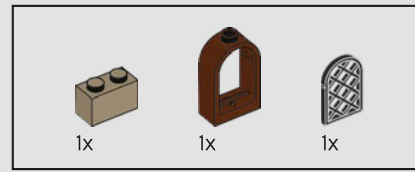
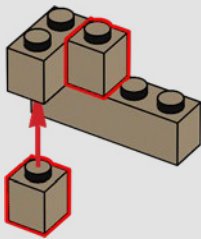

258

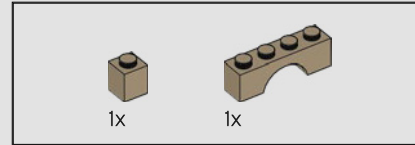
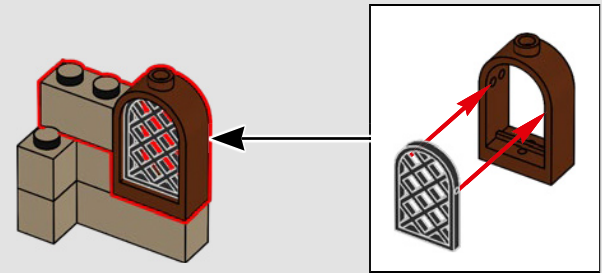

259

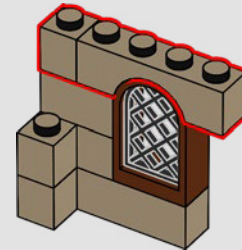

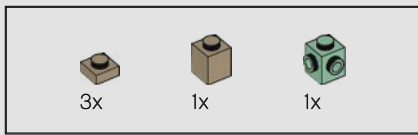

260

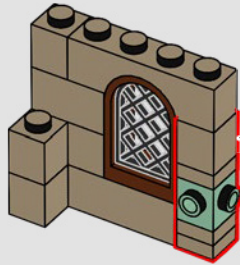
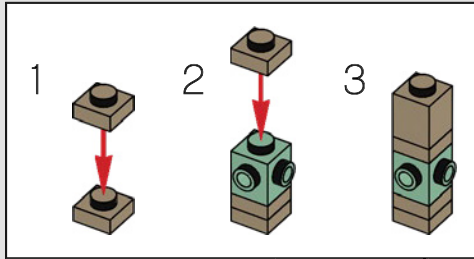

261

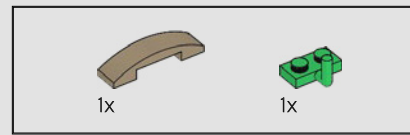
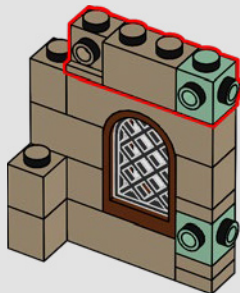

262

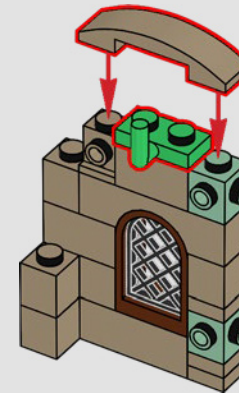

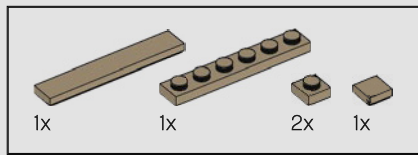

263

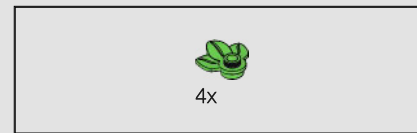
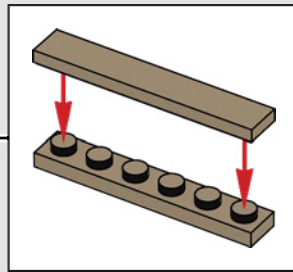
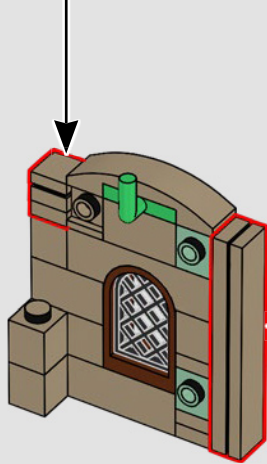
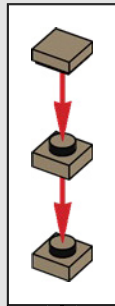

264

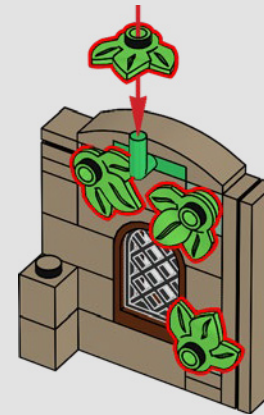

265

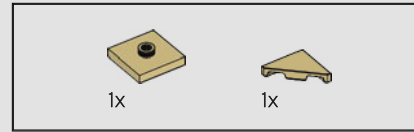
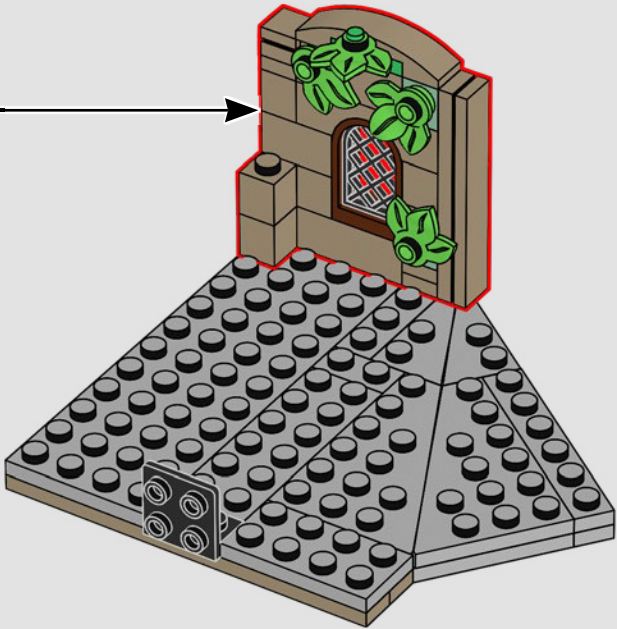

266

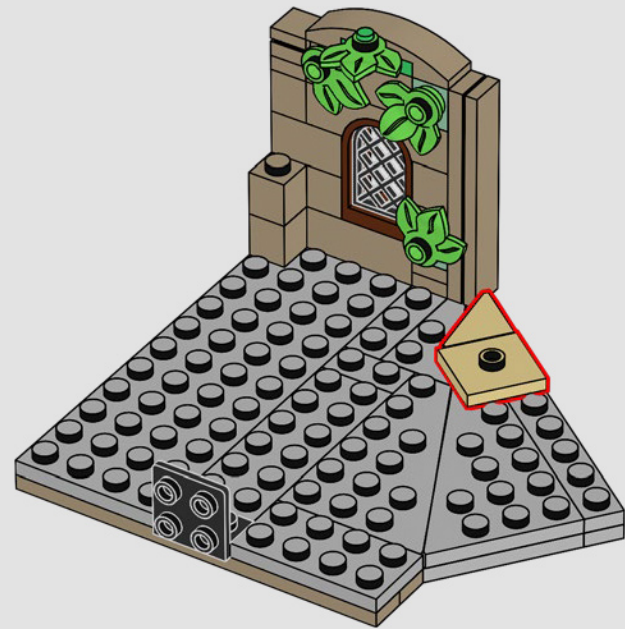

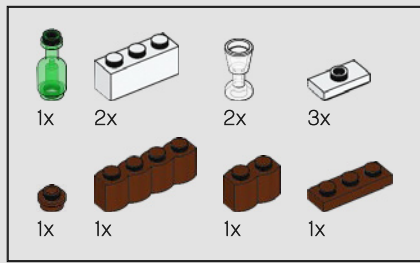

267

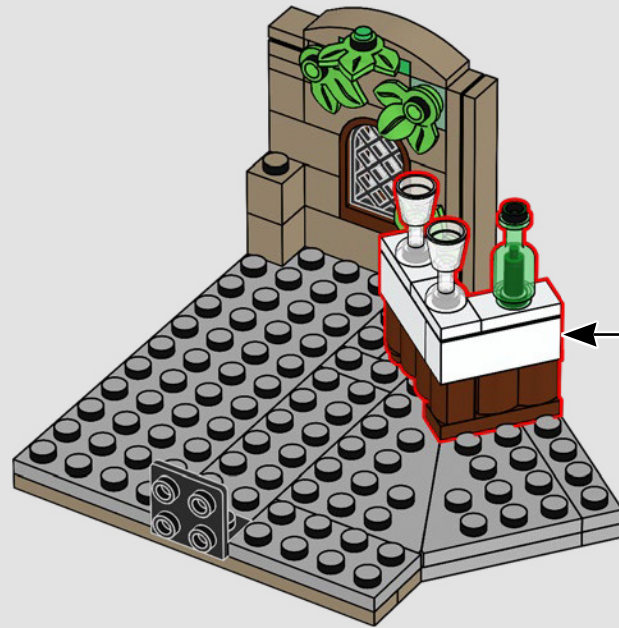
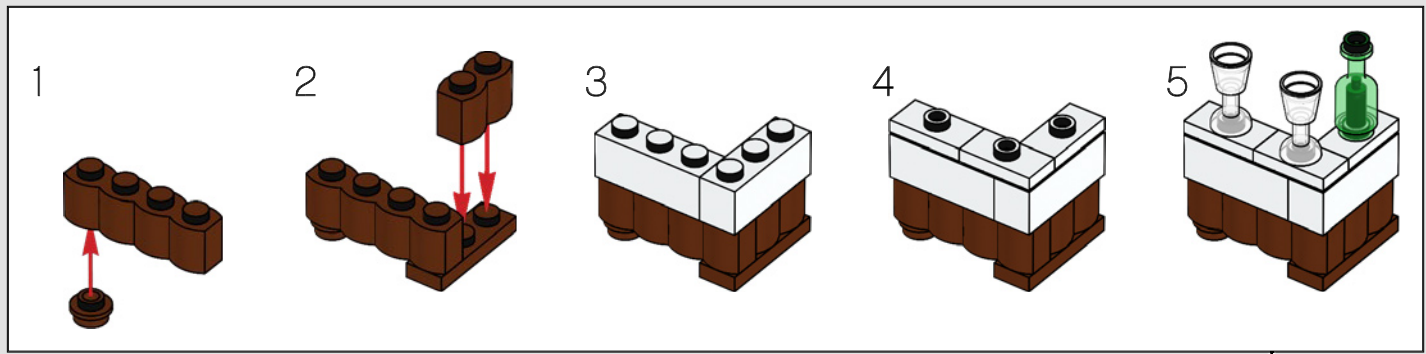

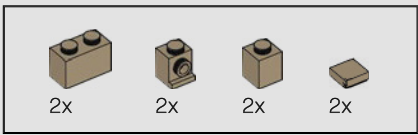

268

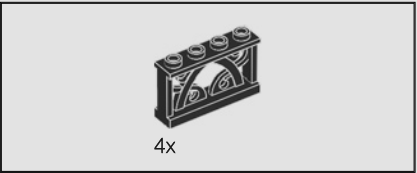
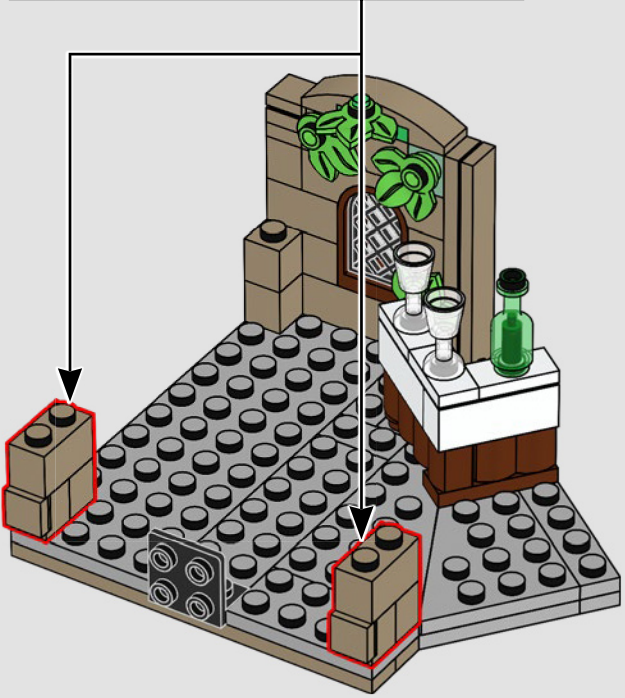
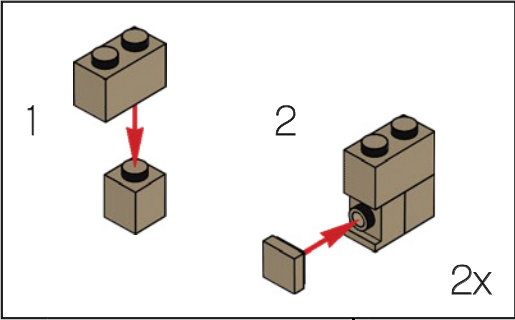

269





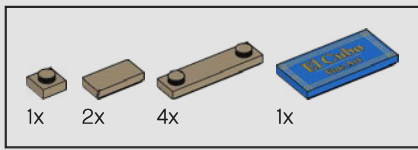

270

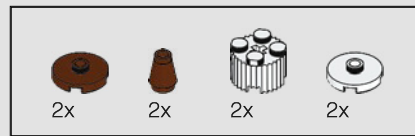
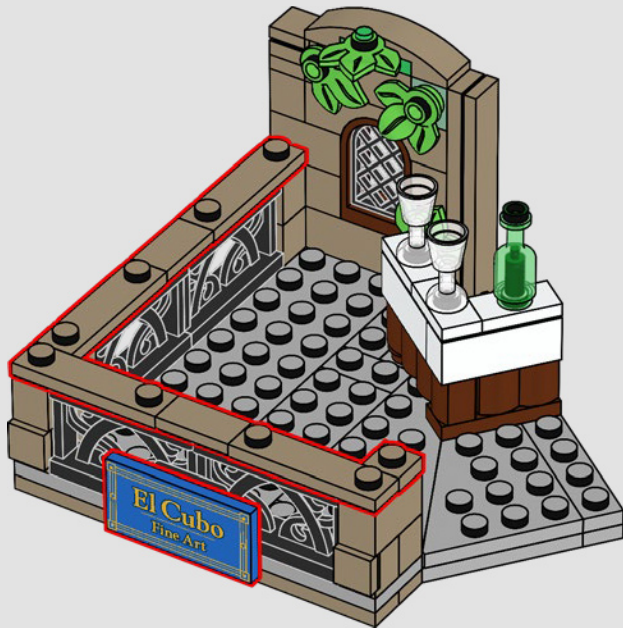

271

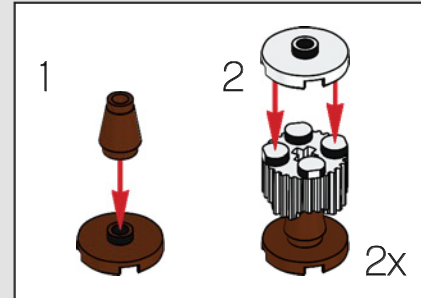

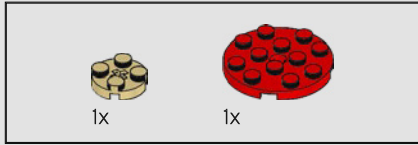

272

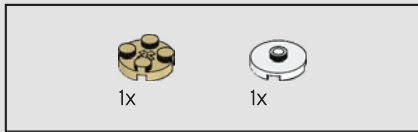

273

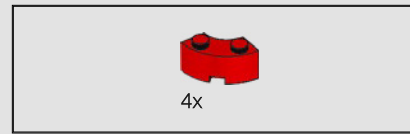
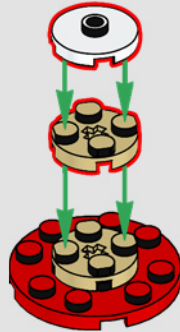

274

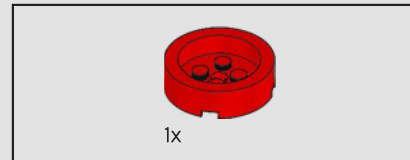
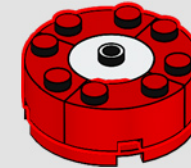

275

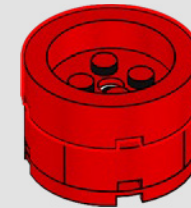

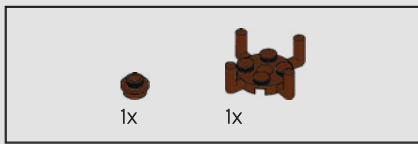

276

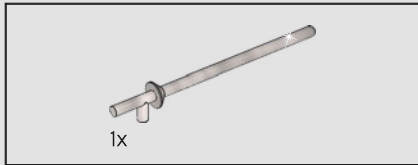
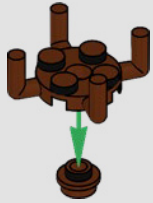

277

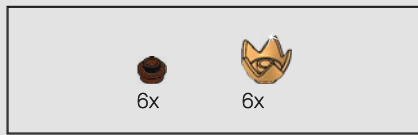

278

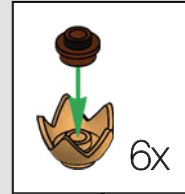

279

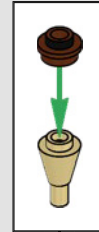

280



5x

281

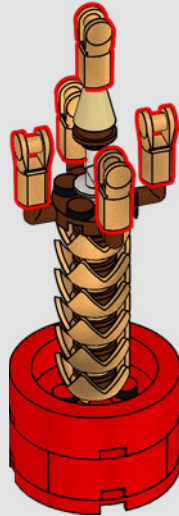

5x

282

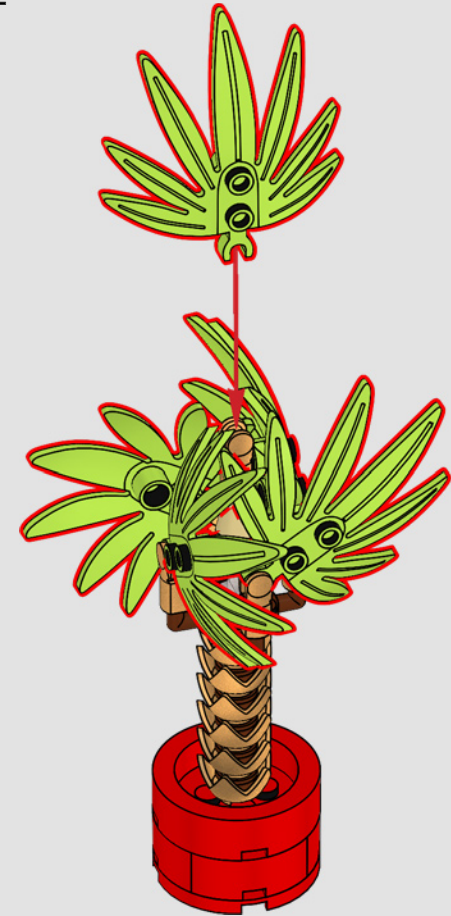

Die Elemente, aus denen der Stamm der Palme besteht, bildeten ursprünglich die Krone von Königin Wasimma Si-Willi aus *THE LEGO® MOVIE 2™*.

283

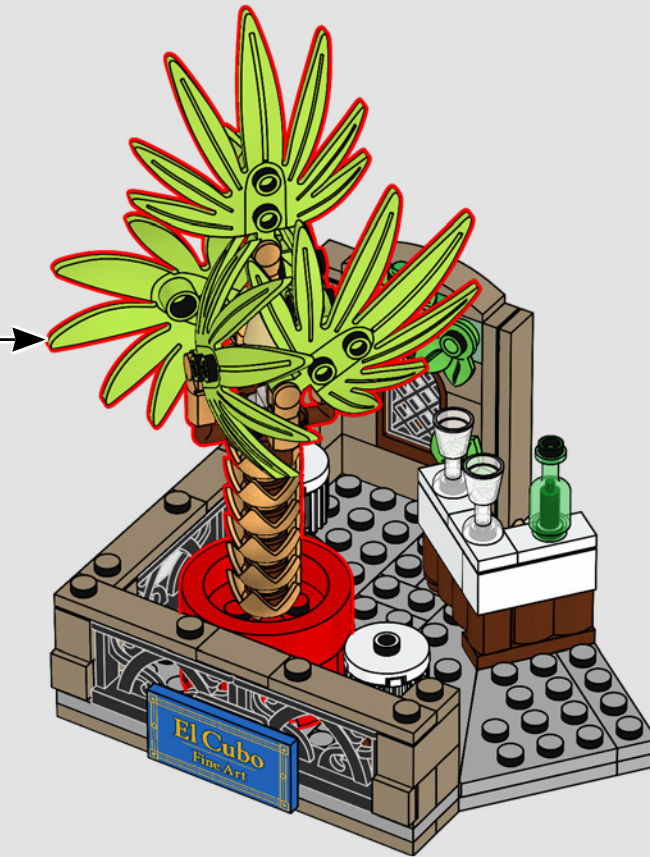

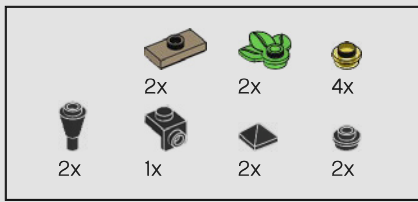

284

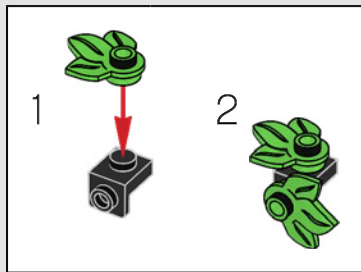
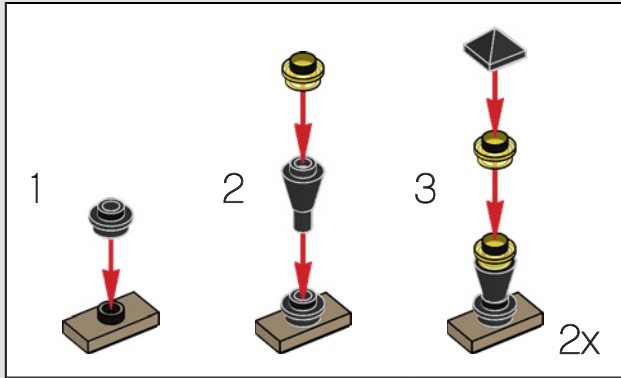

285



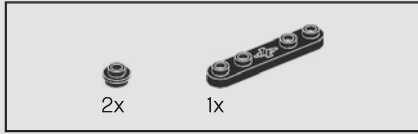
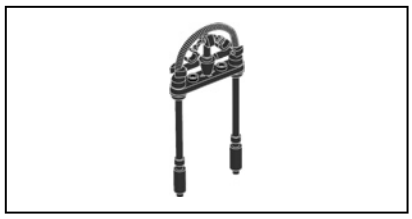

286

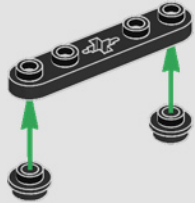

287

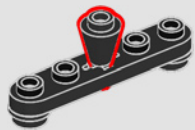

288

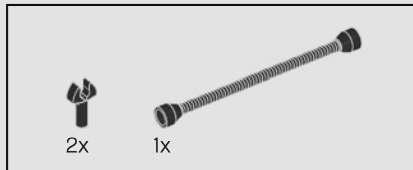
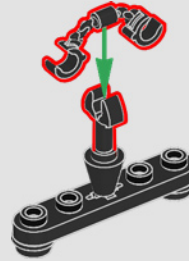

289

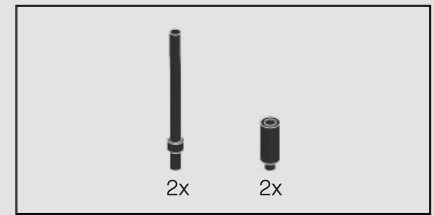
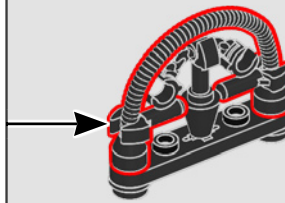
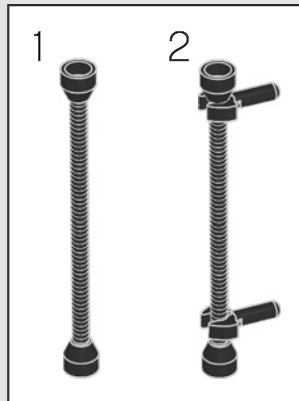

290

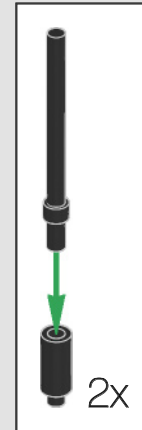
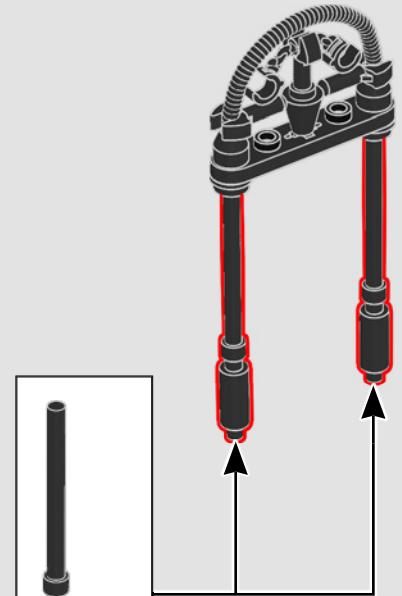





Das schmiedeeiserne Tor feierte in der „Marktstraße“ (10190) seine Premiere. Besonders bemerkenswert waren die Minifigur-Peitschen, mit denen sich die geschwungenen Details darstellen ließen.

291



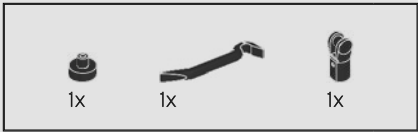

292

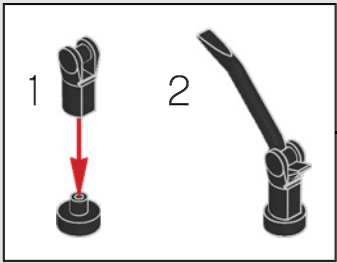

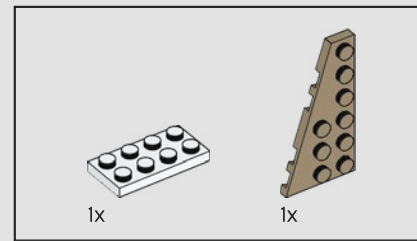
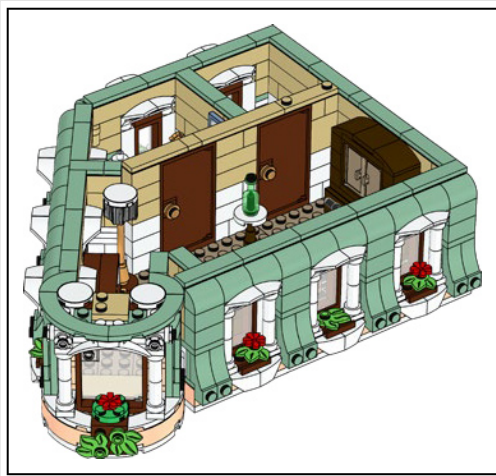
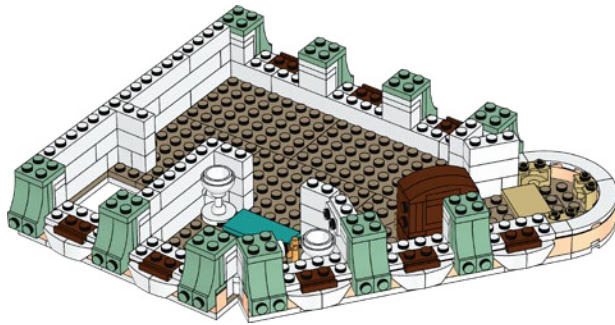
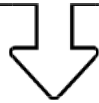

293

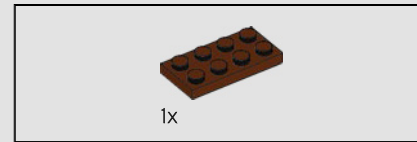
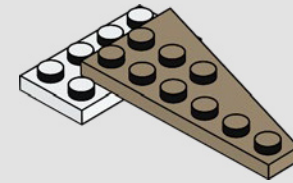

294

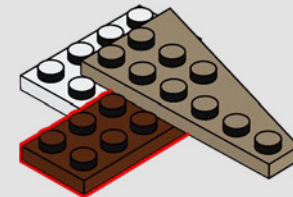

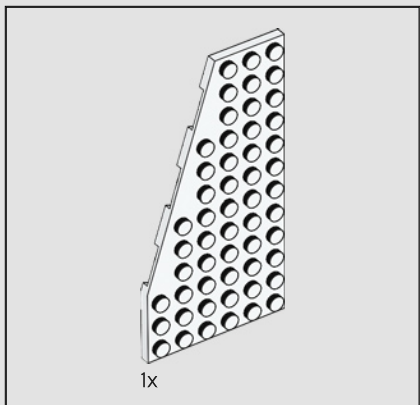

295

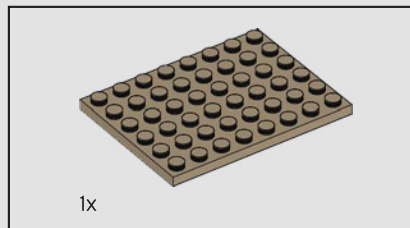
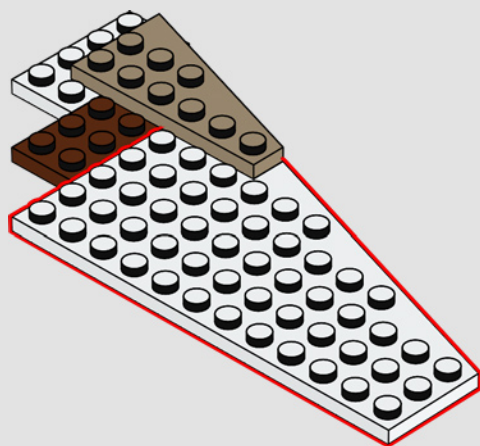

296

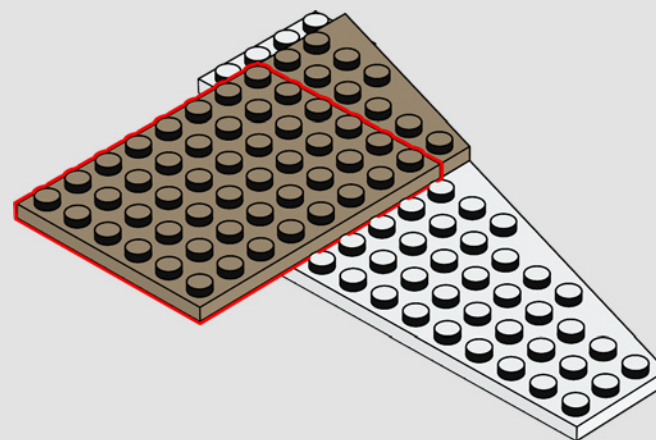

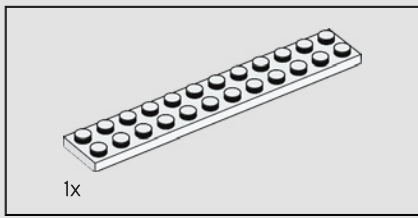

297

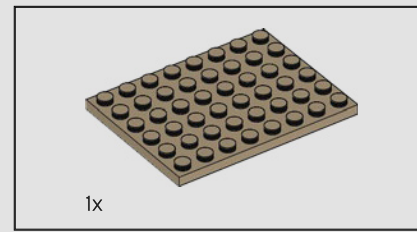
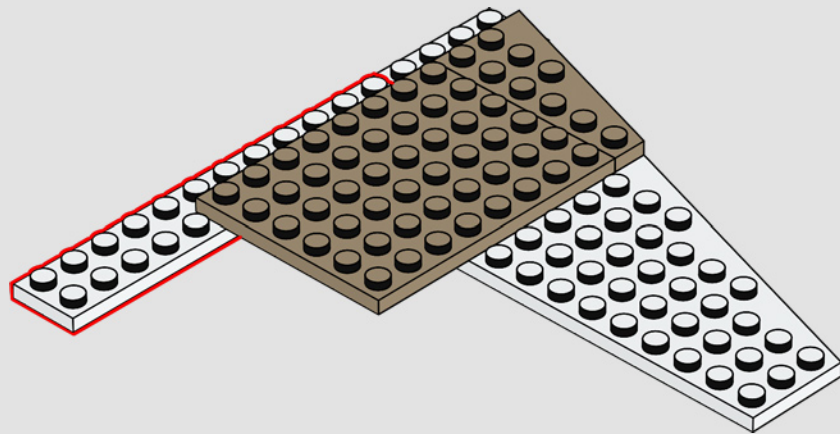

298

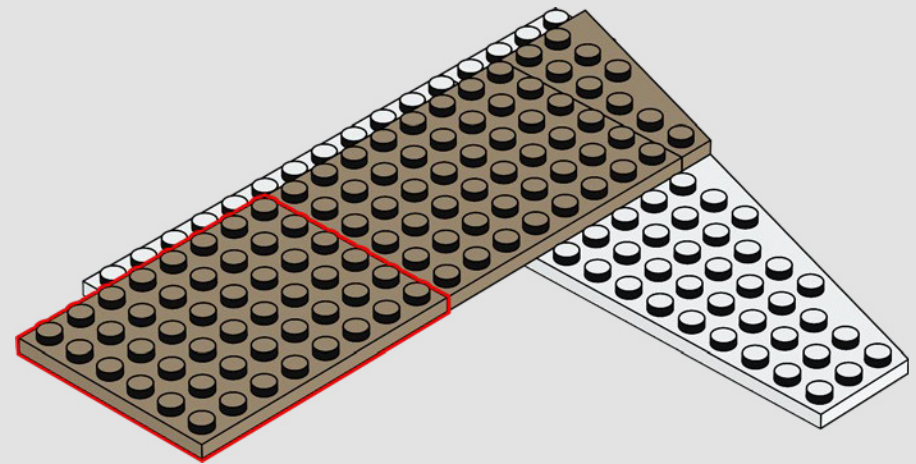

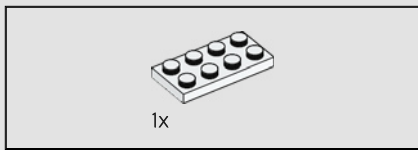

299

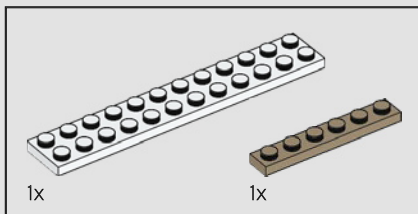
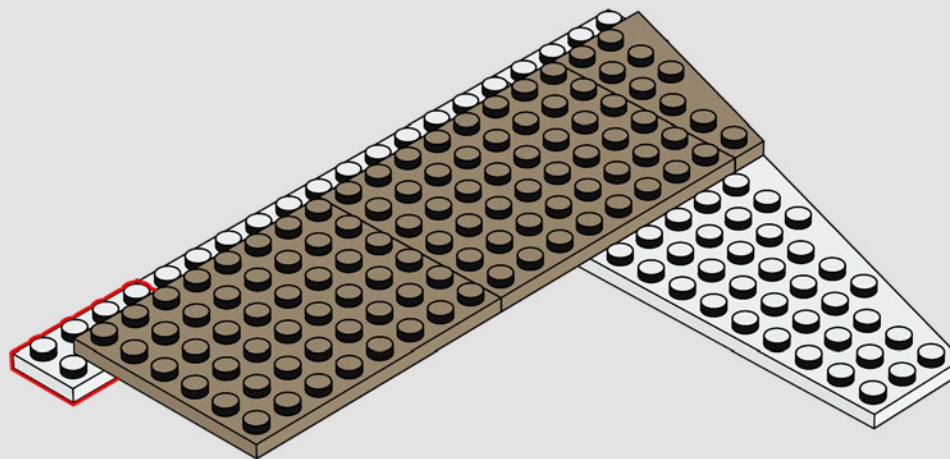

300

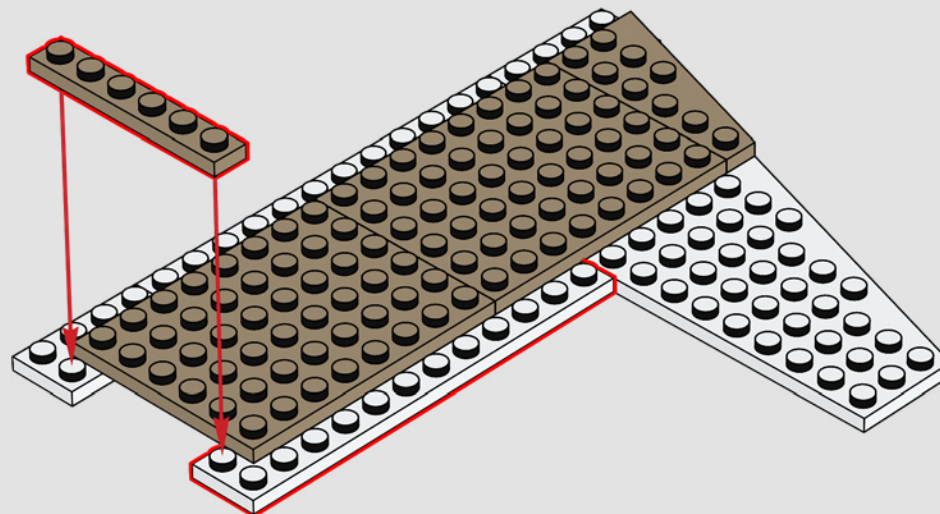

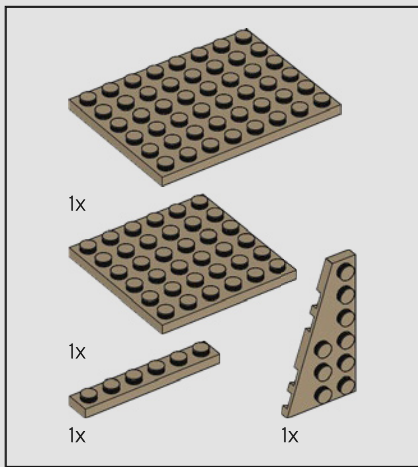

301

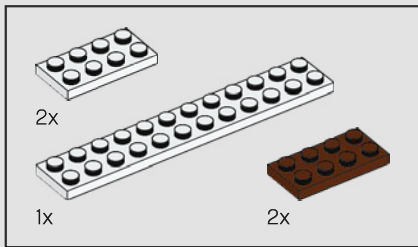
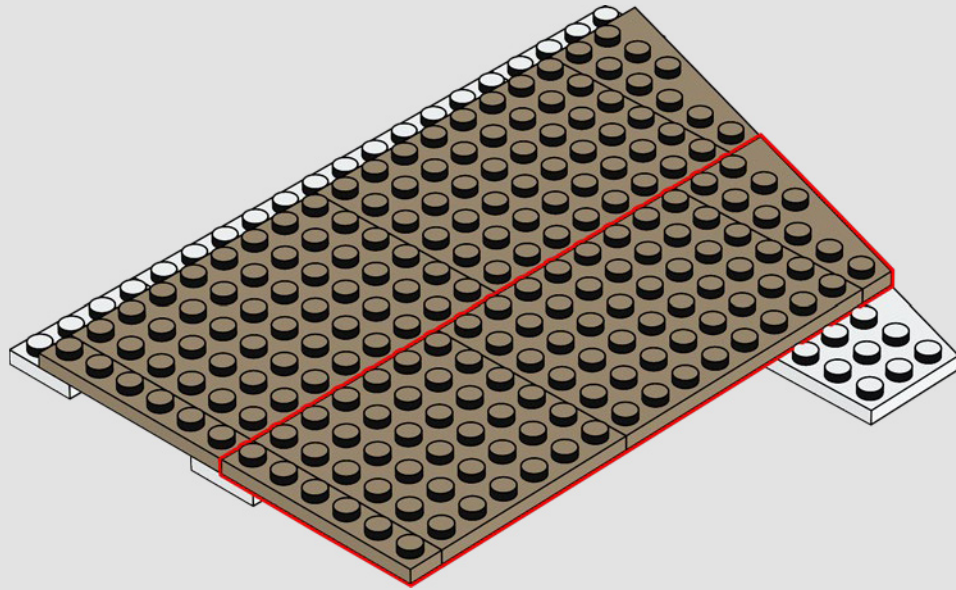

302

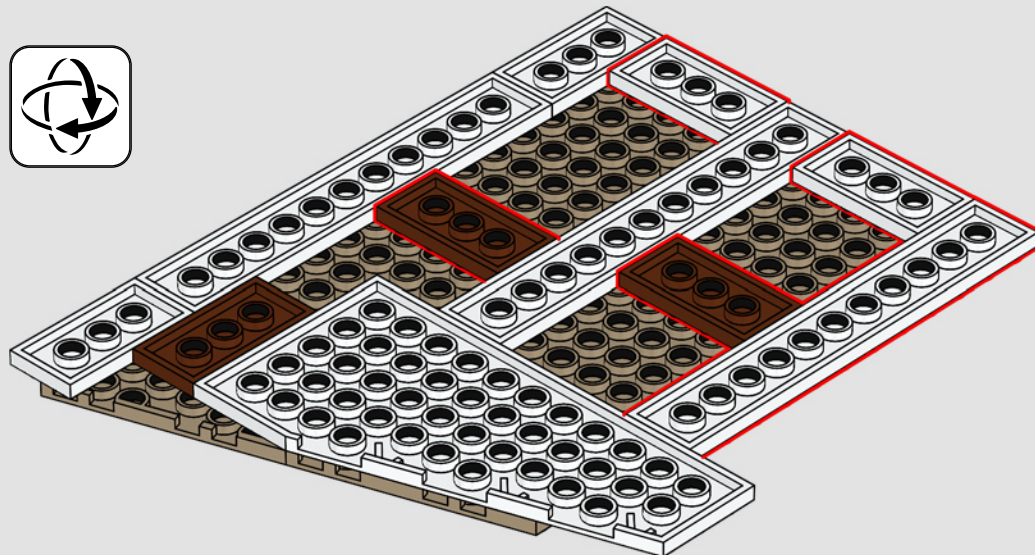

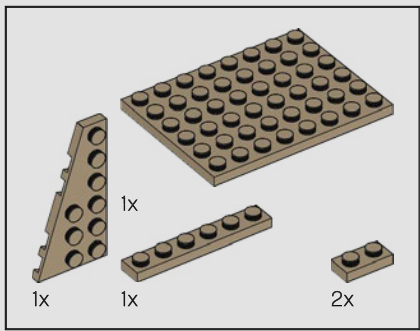

303

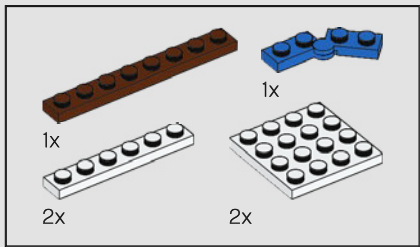
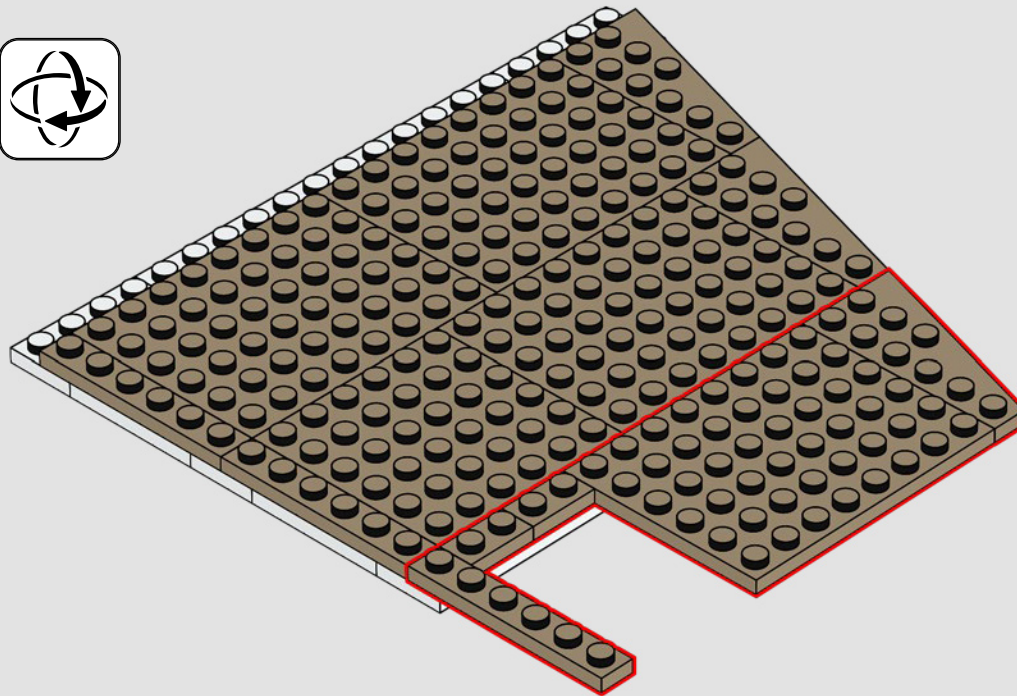

304

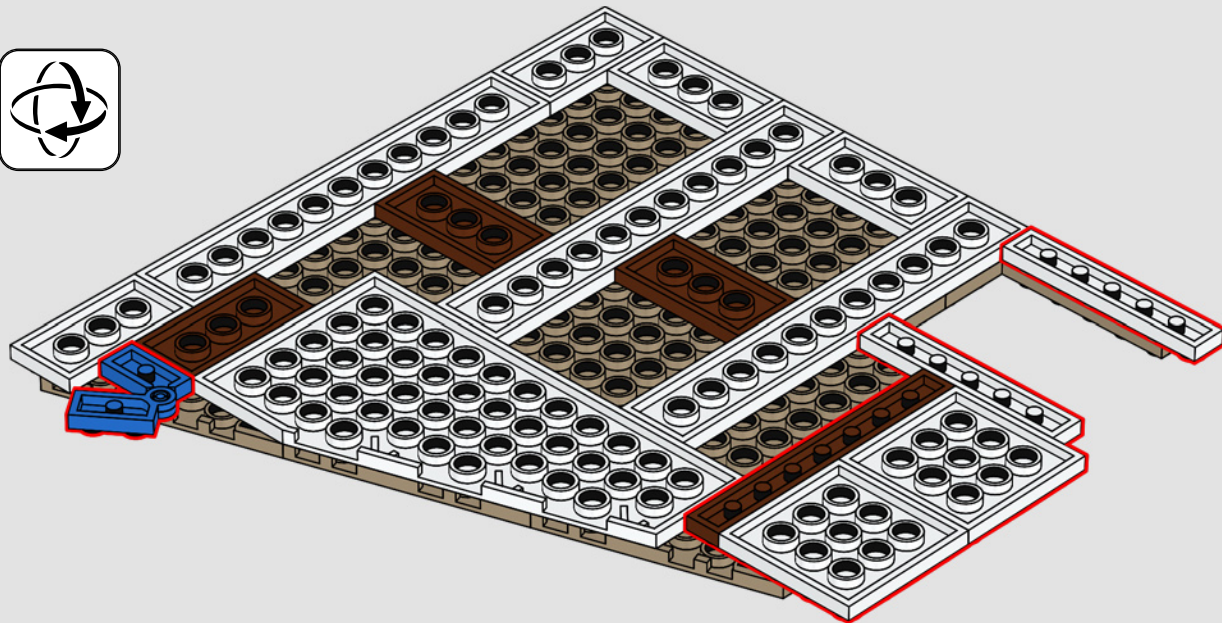
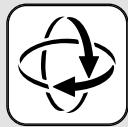



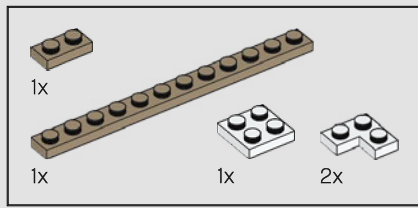

305

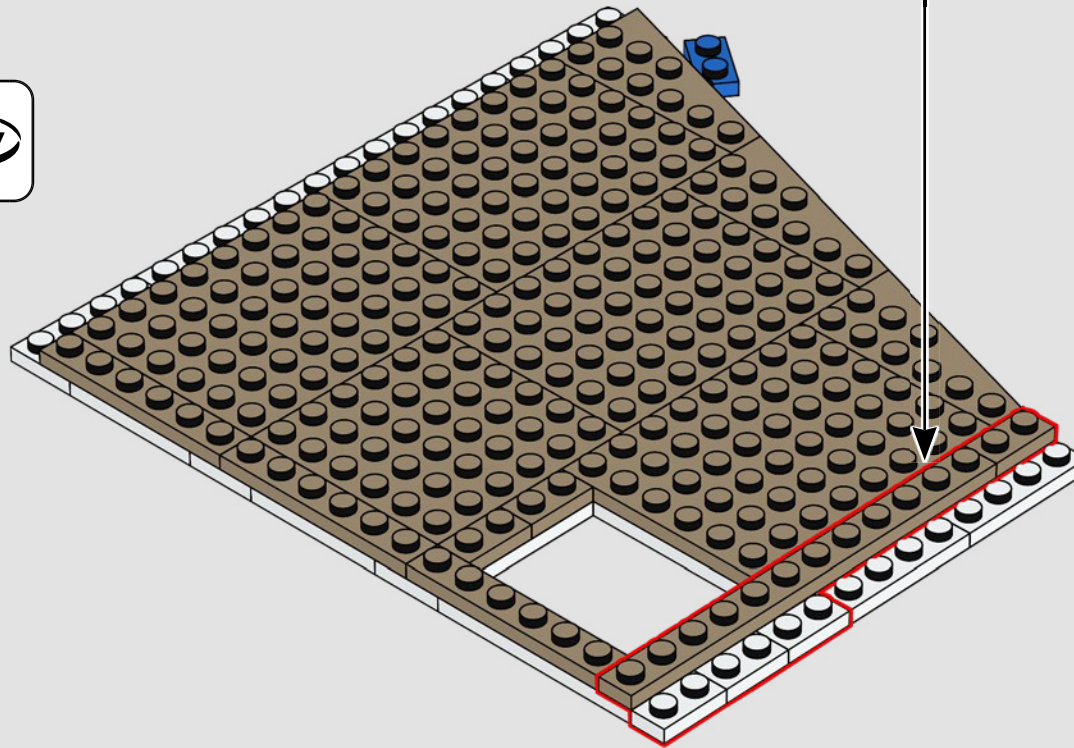
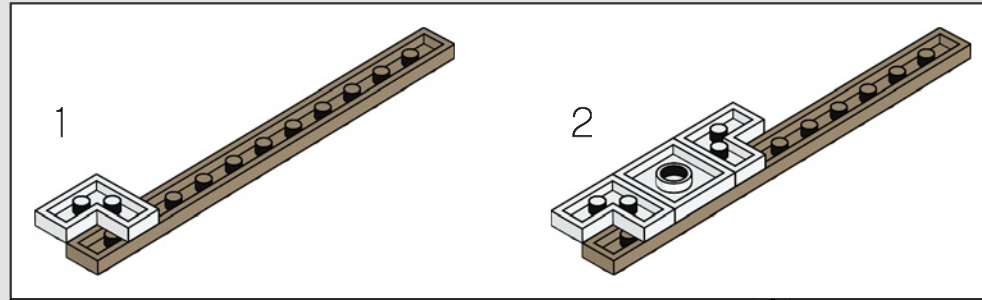

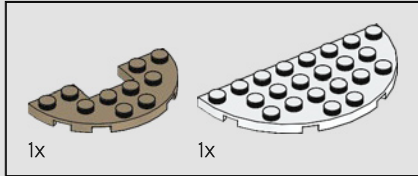
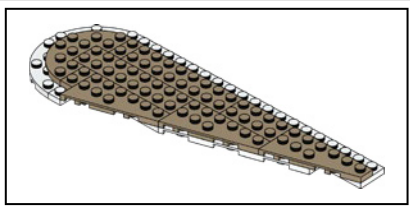

306

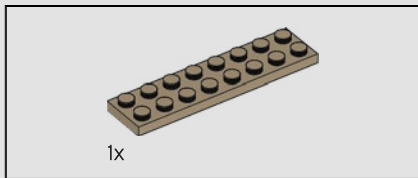
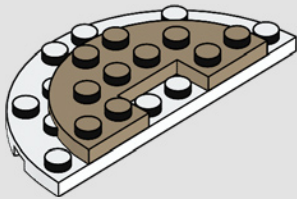

307

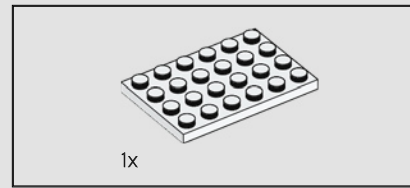
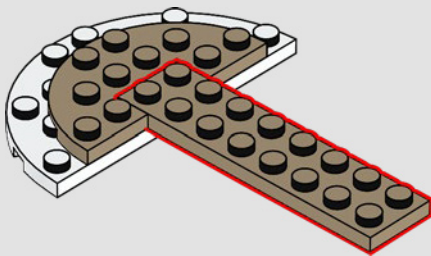

308

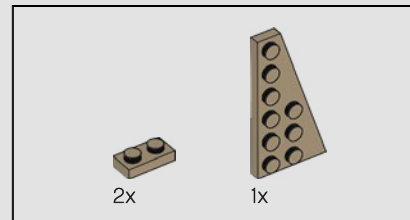
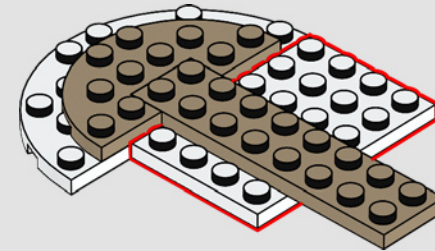

309

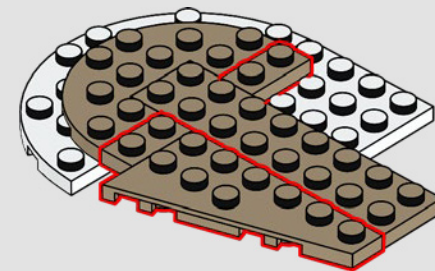

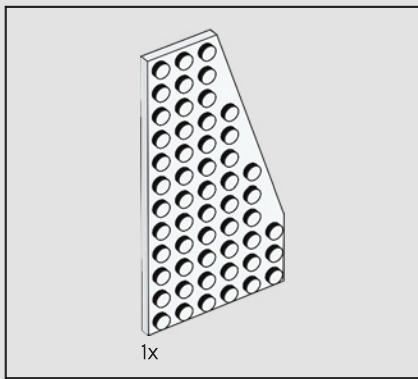

310

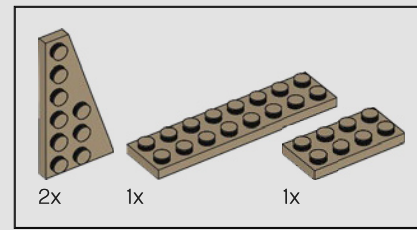
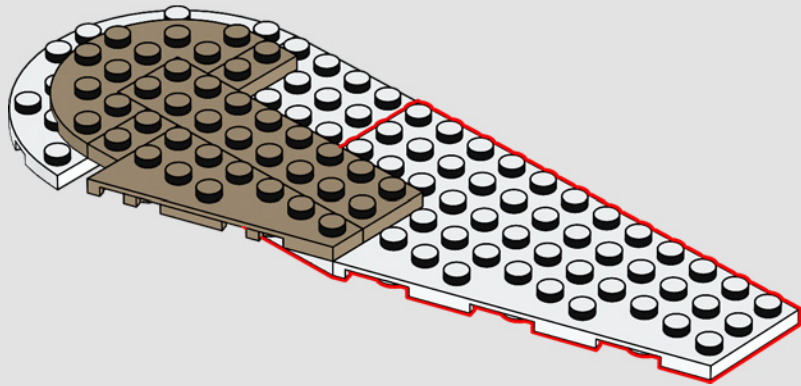

311

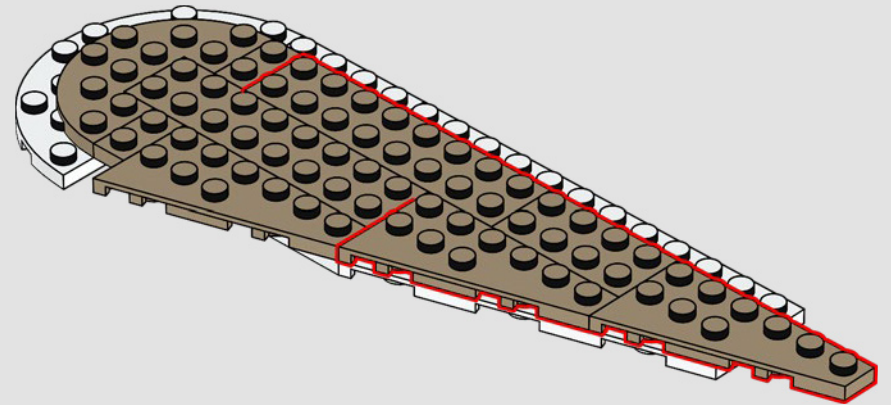

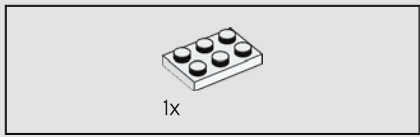

312

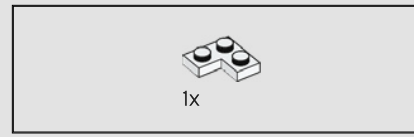
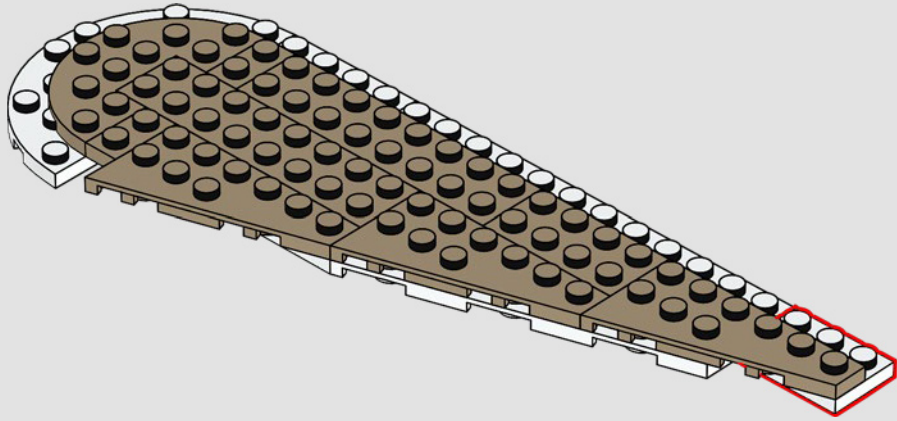

313

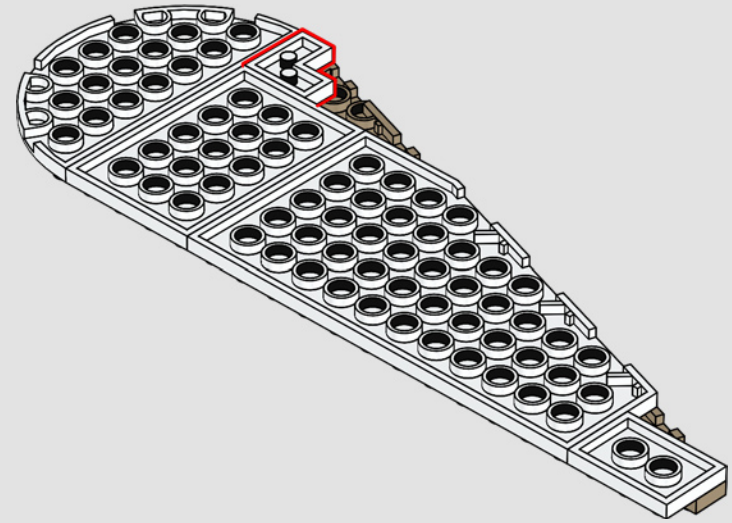
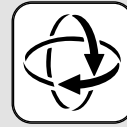

314

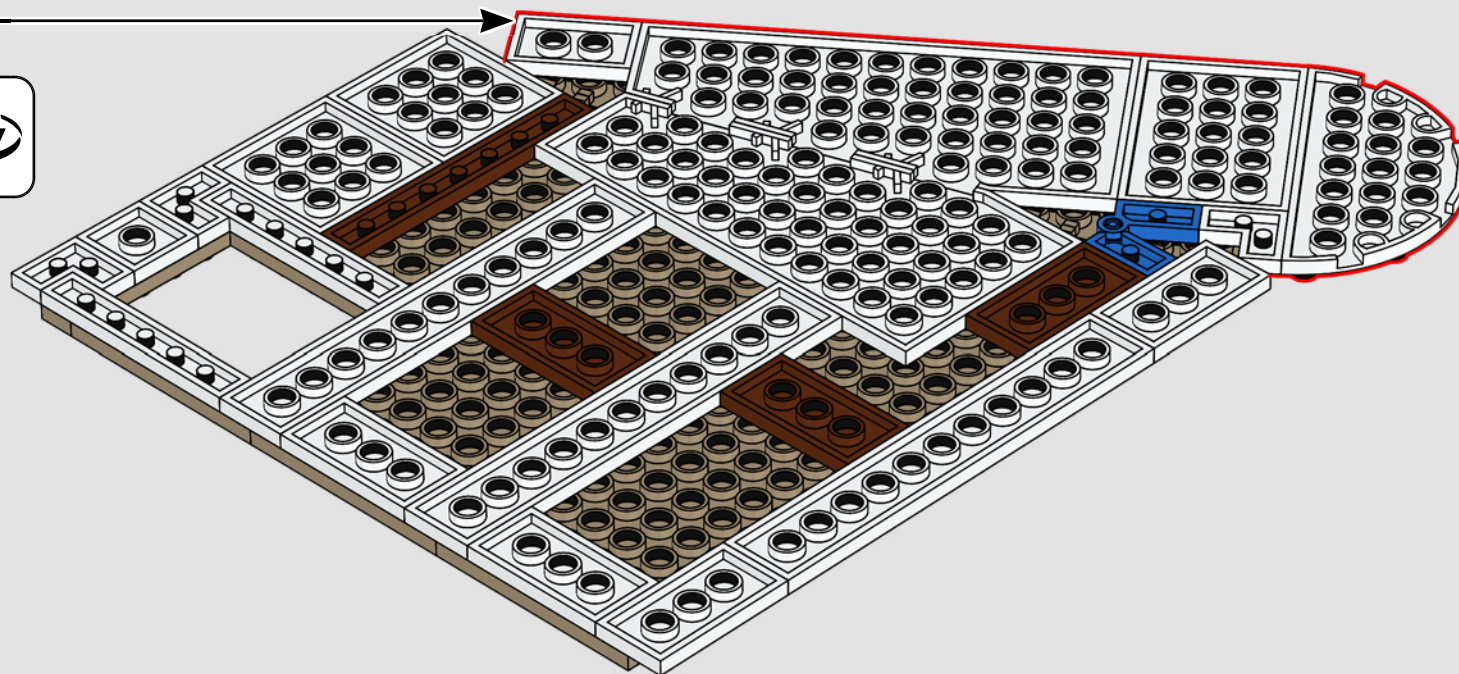

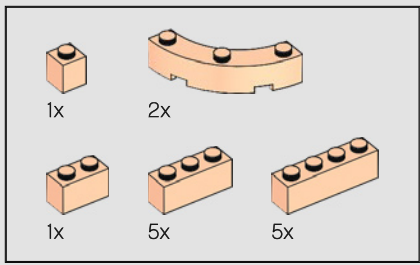

315

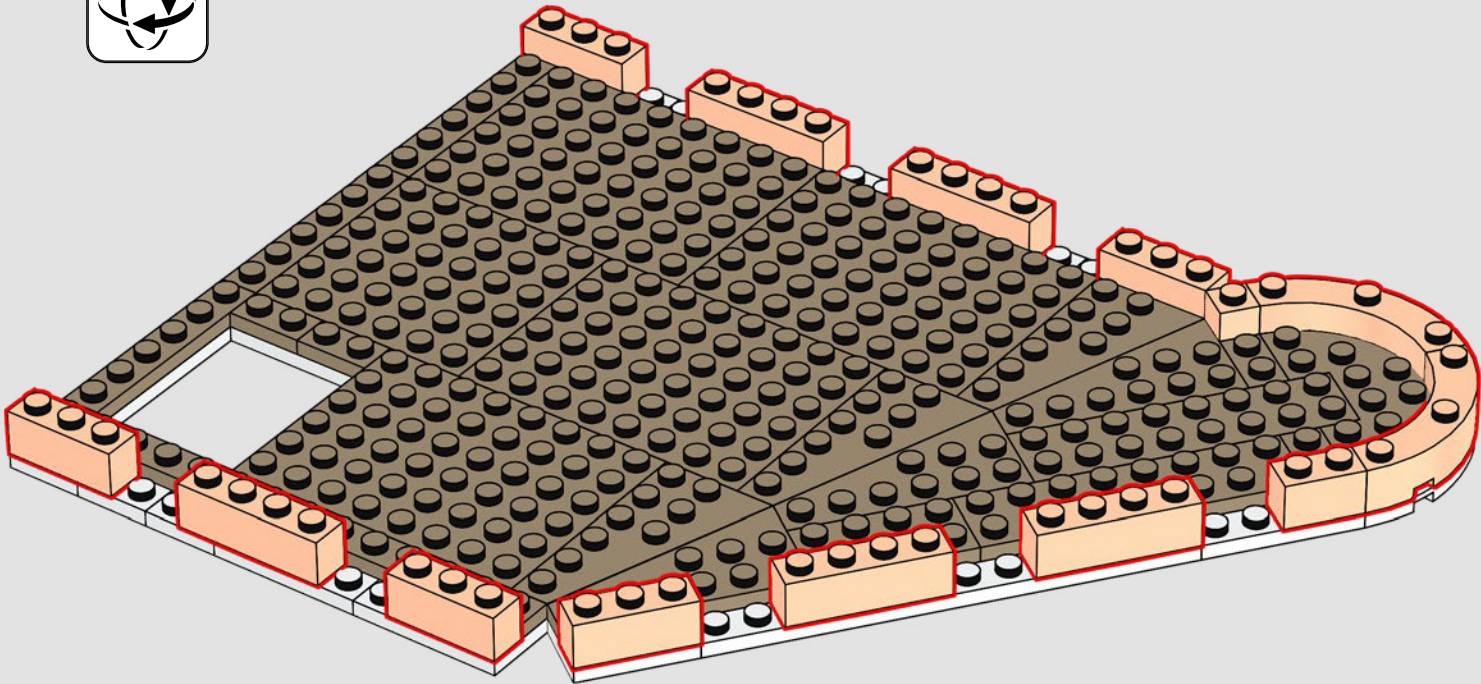

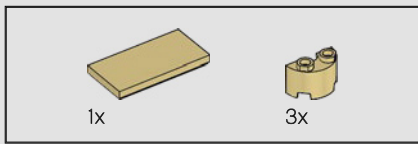

316

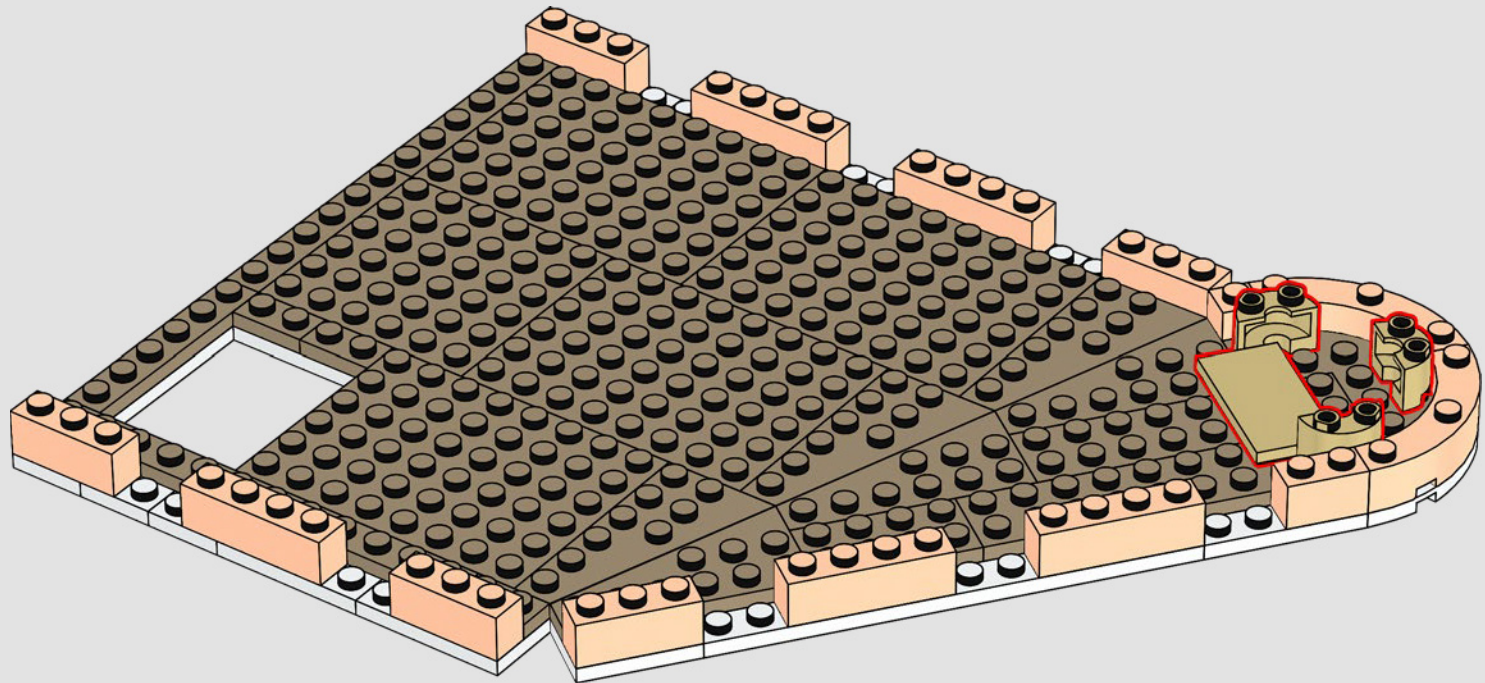

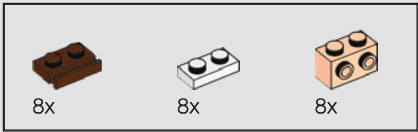

317

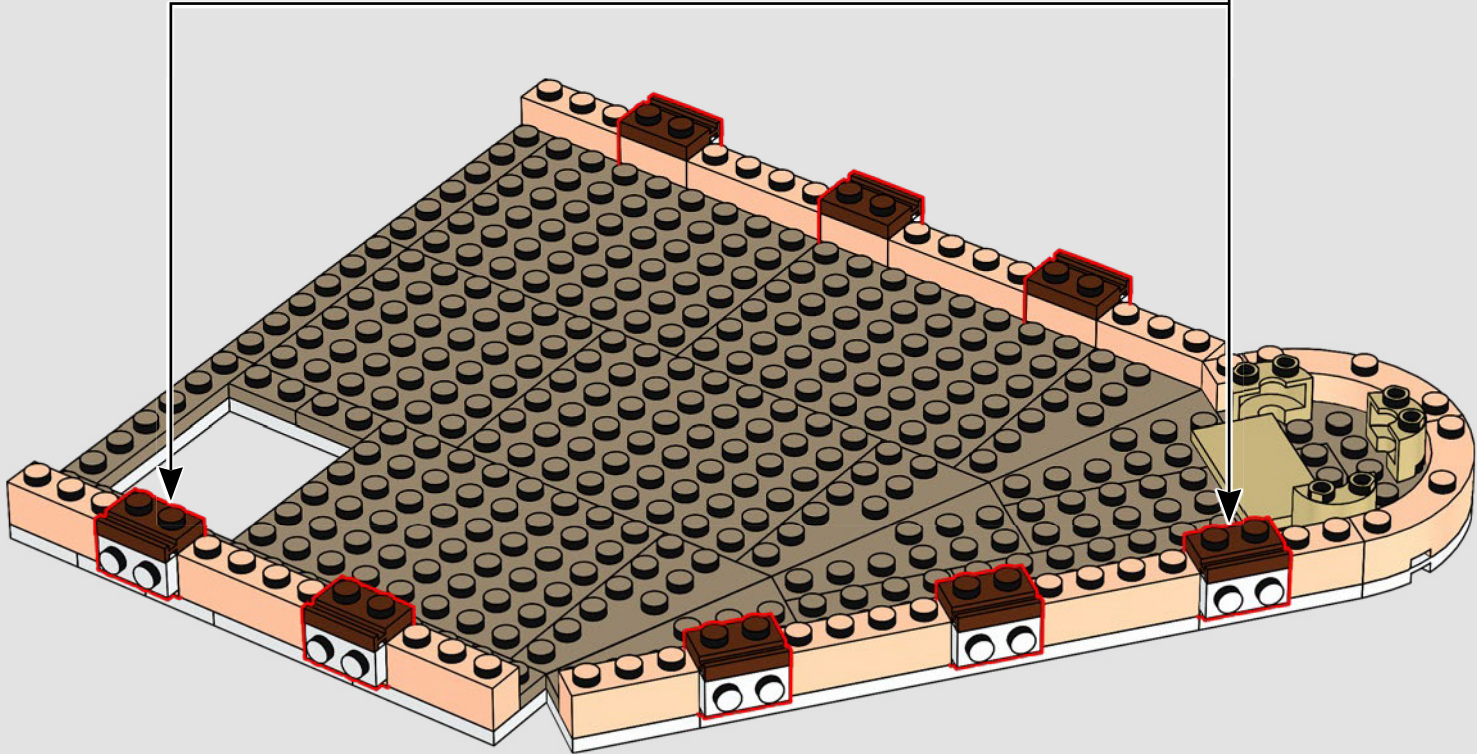
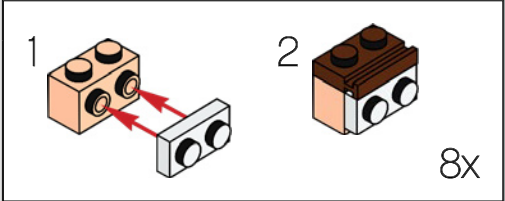



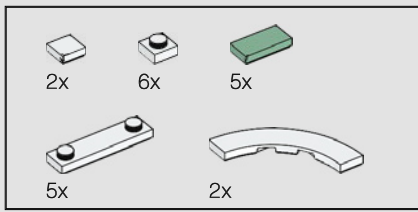

318

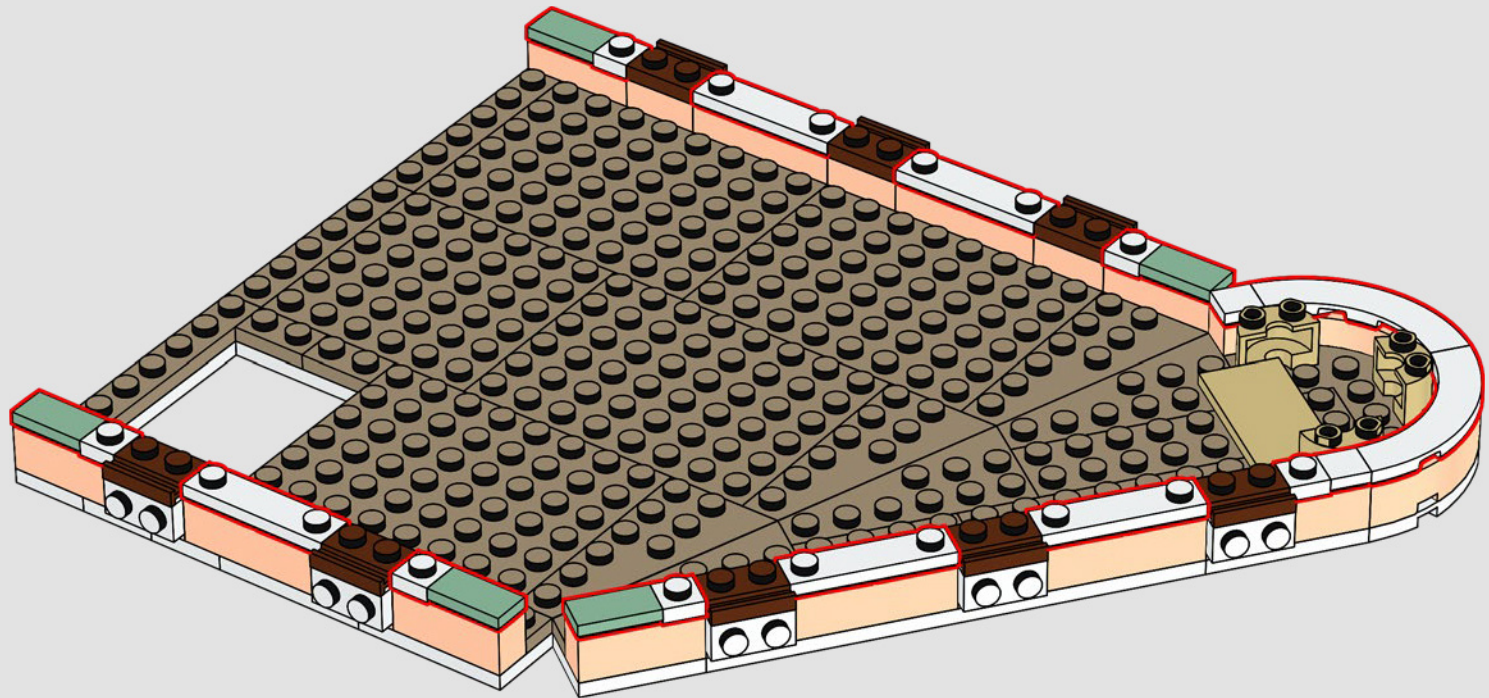

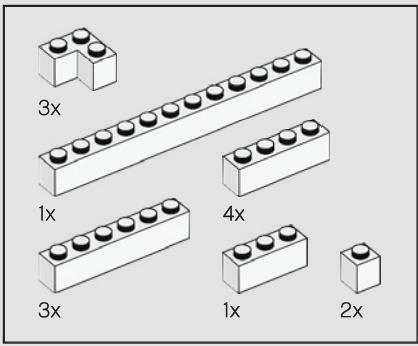

319

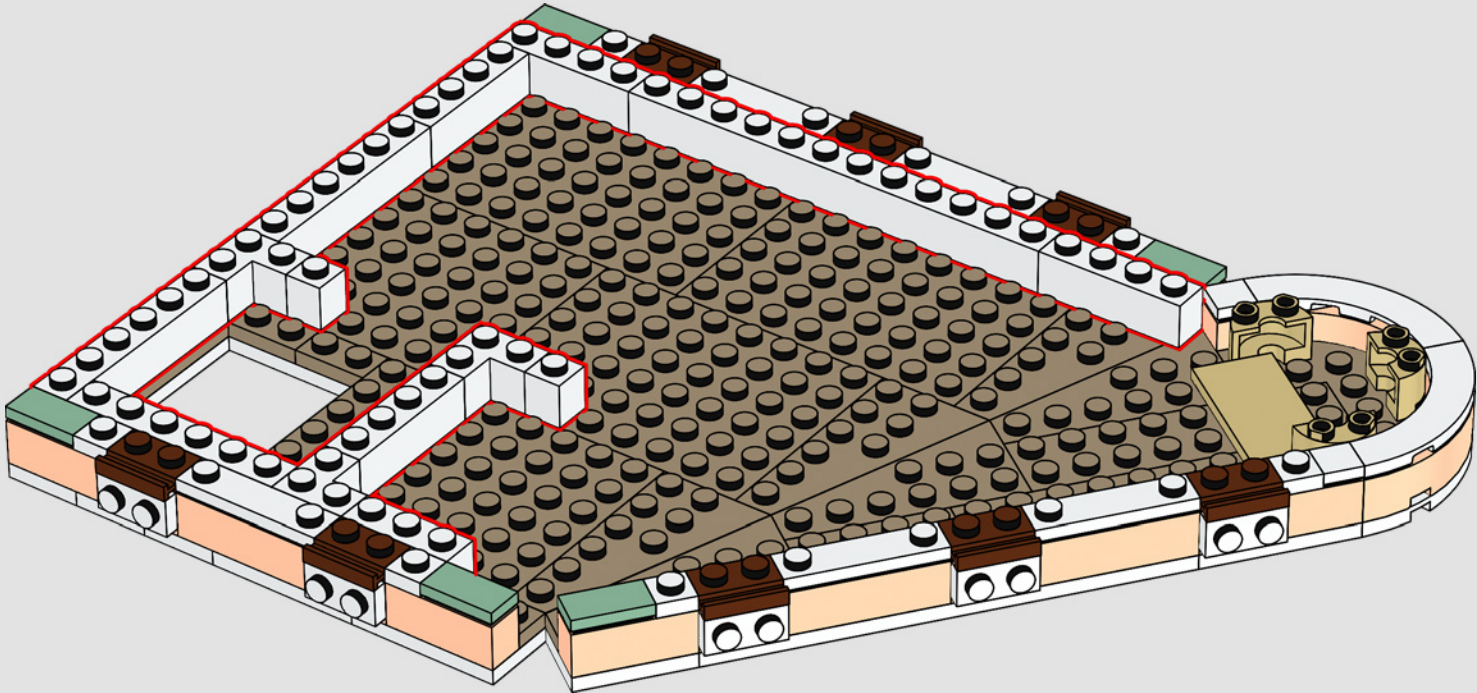

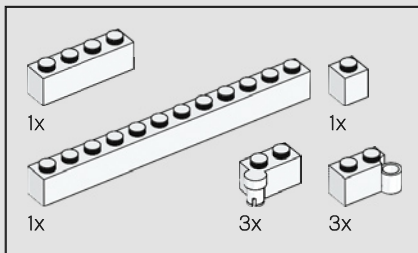

320

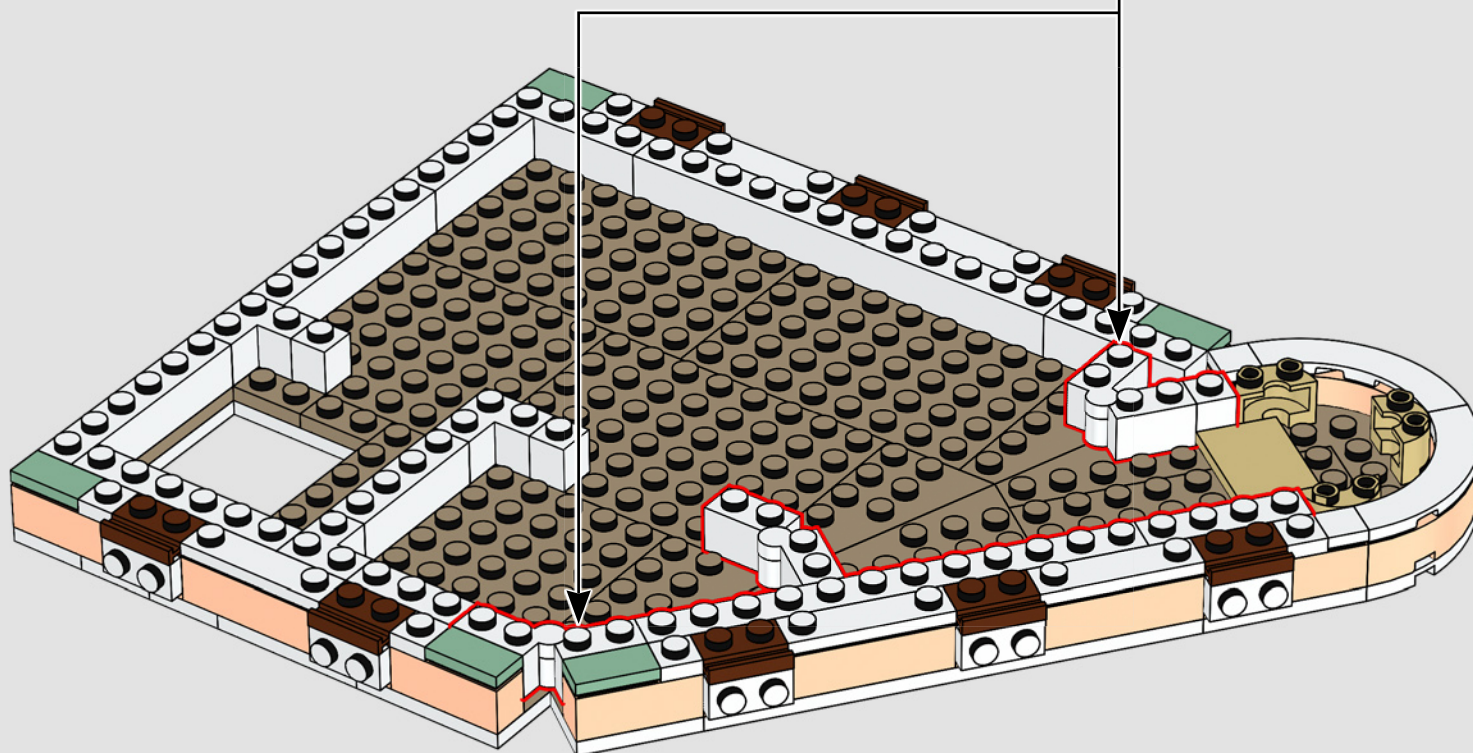
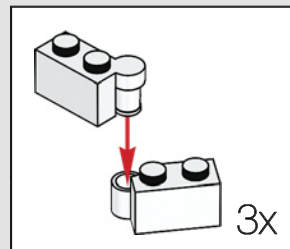

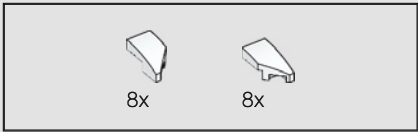

321

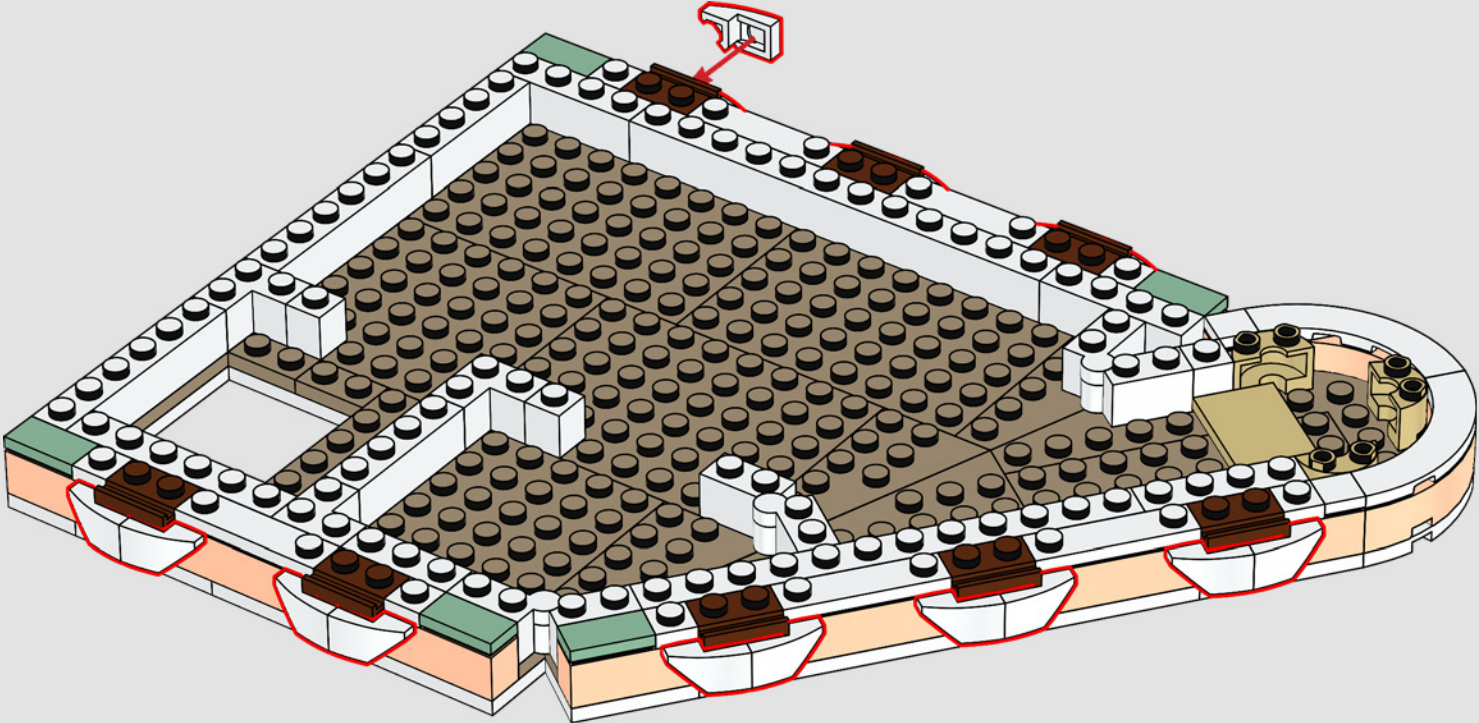

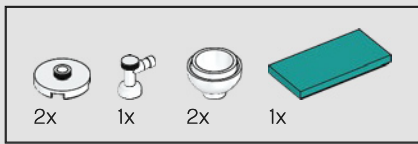

322

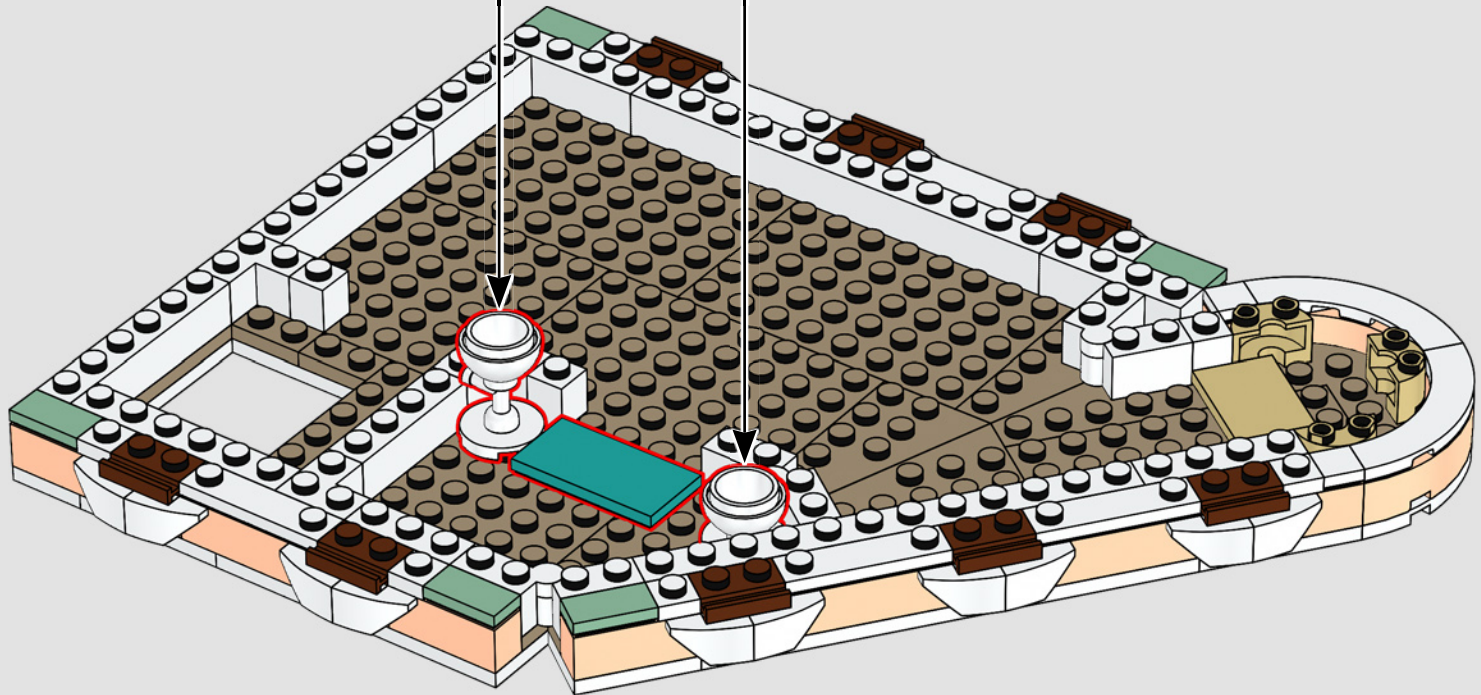
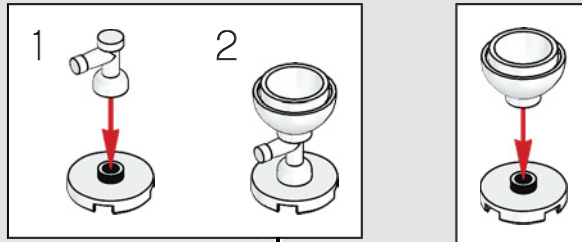



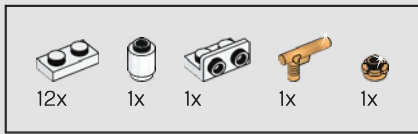

324

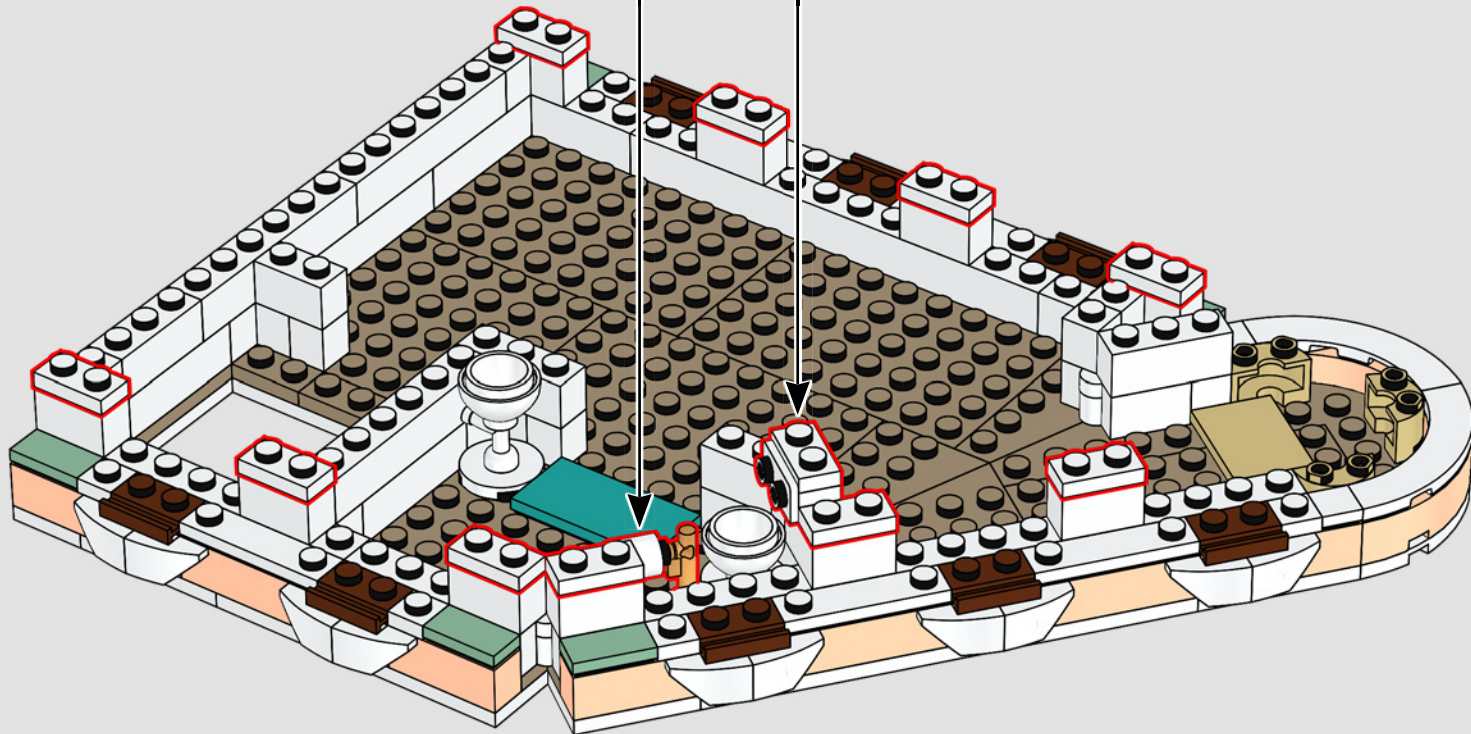
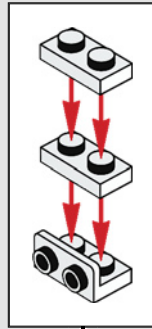
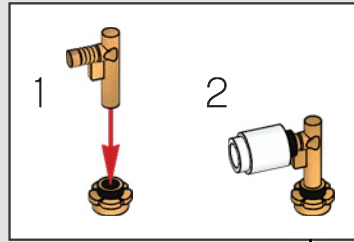

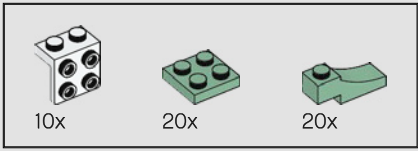

325

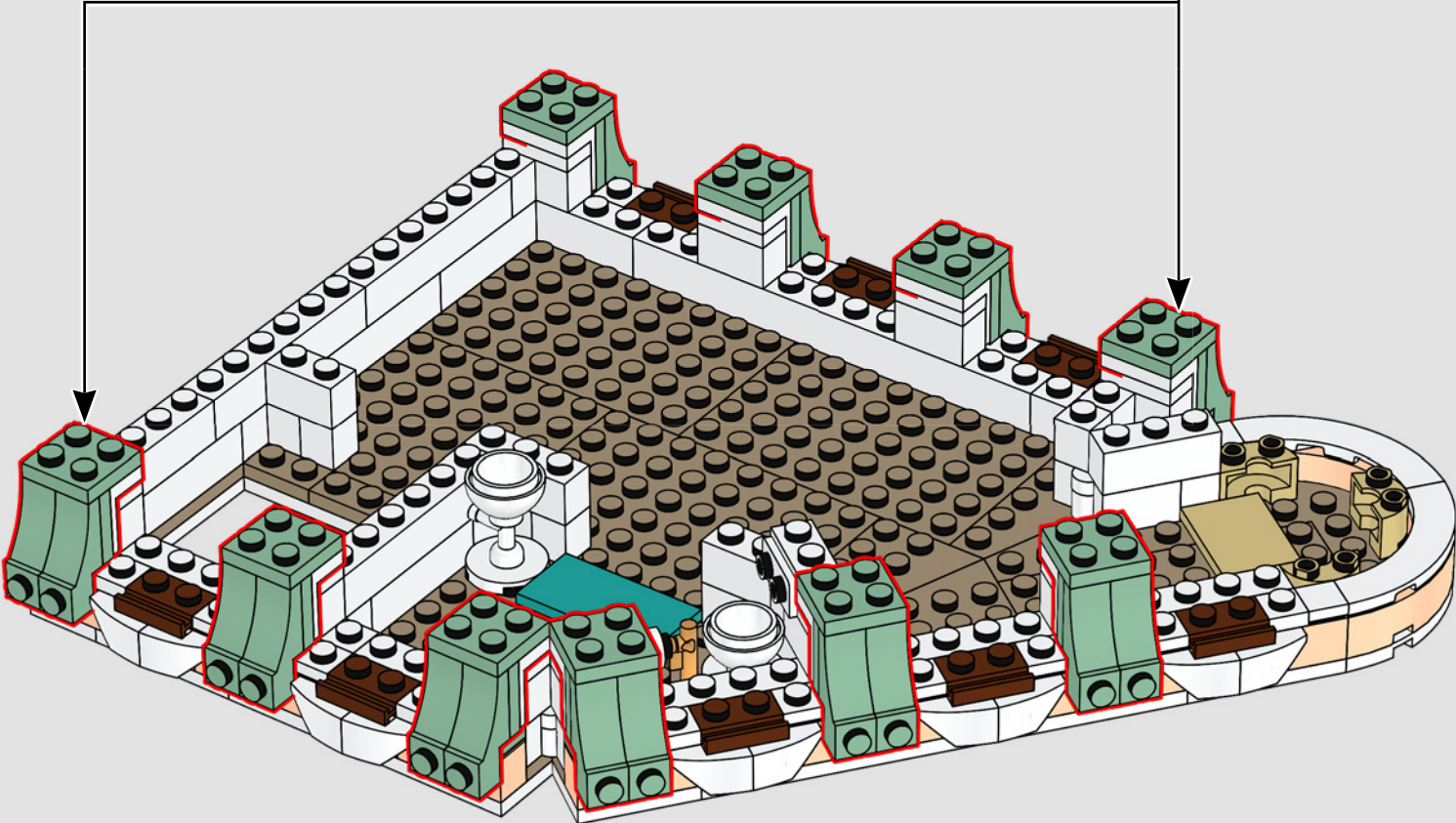
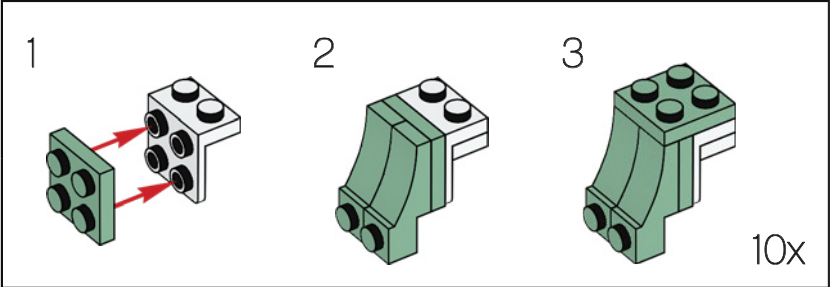



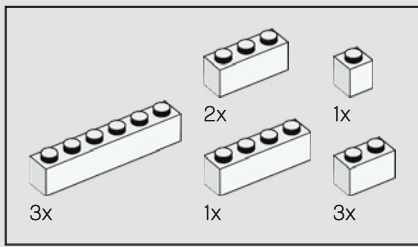

326

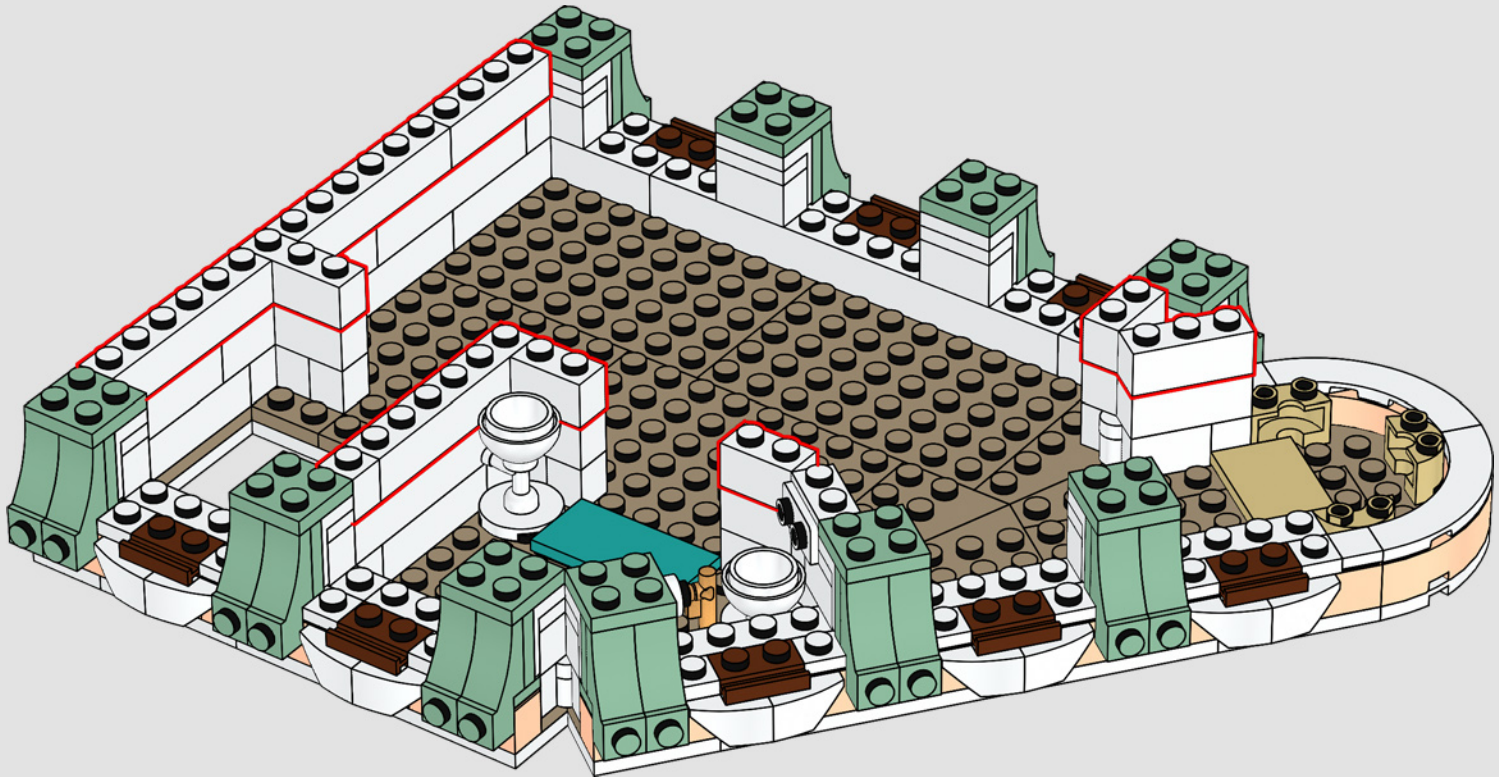

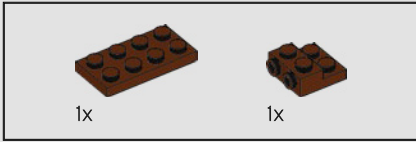

327

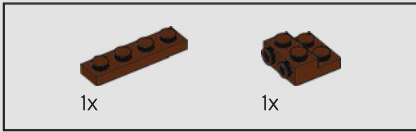
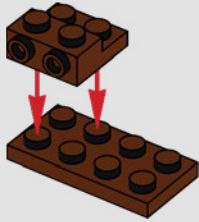

328

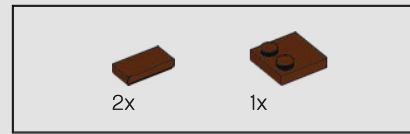
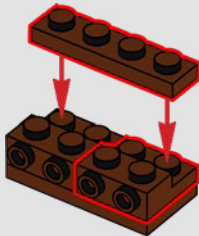

329

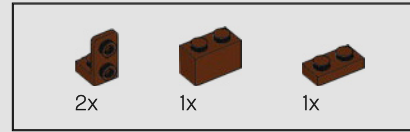
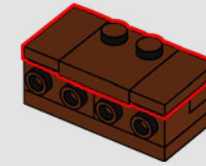

330

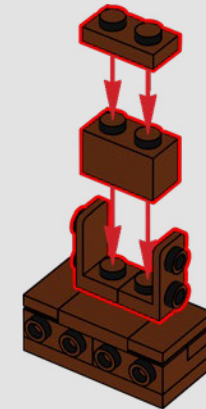

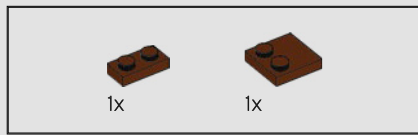

331

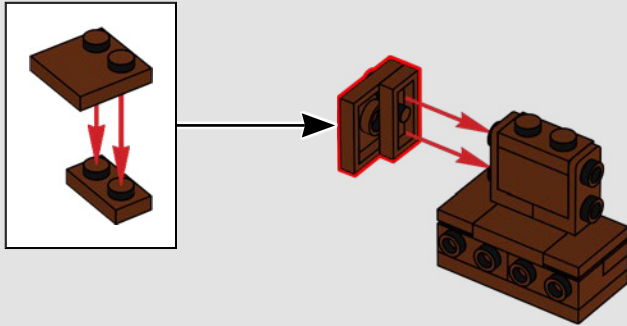

332

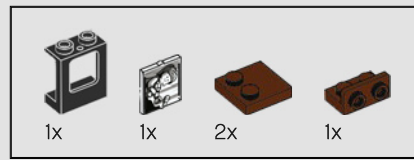
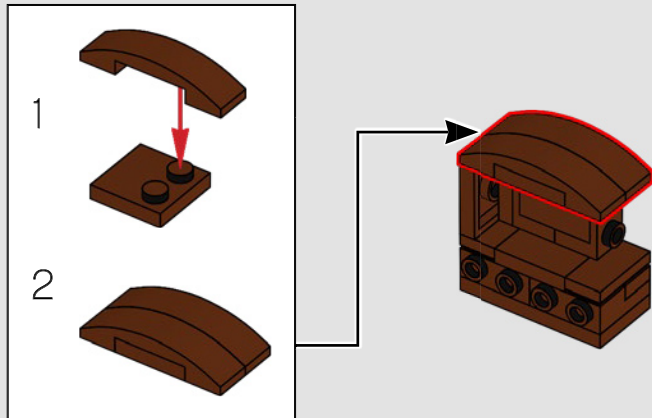

333

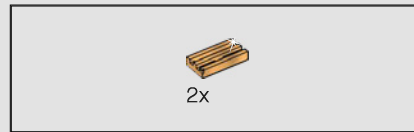
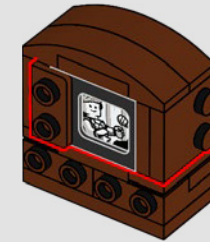
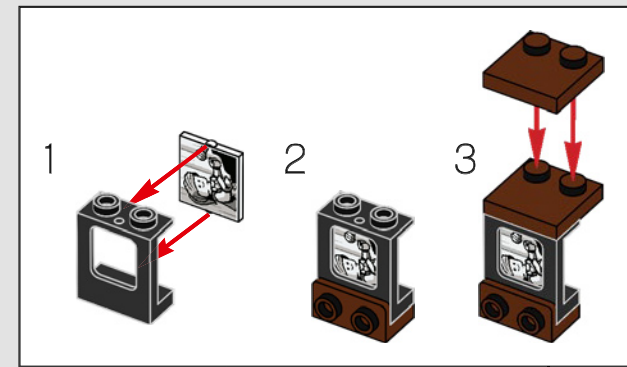

334



335

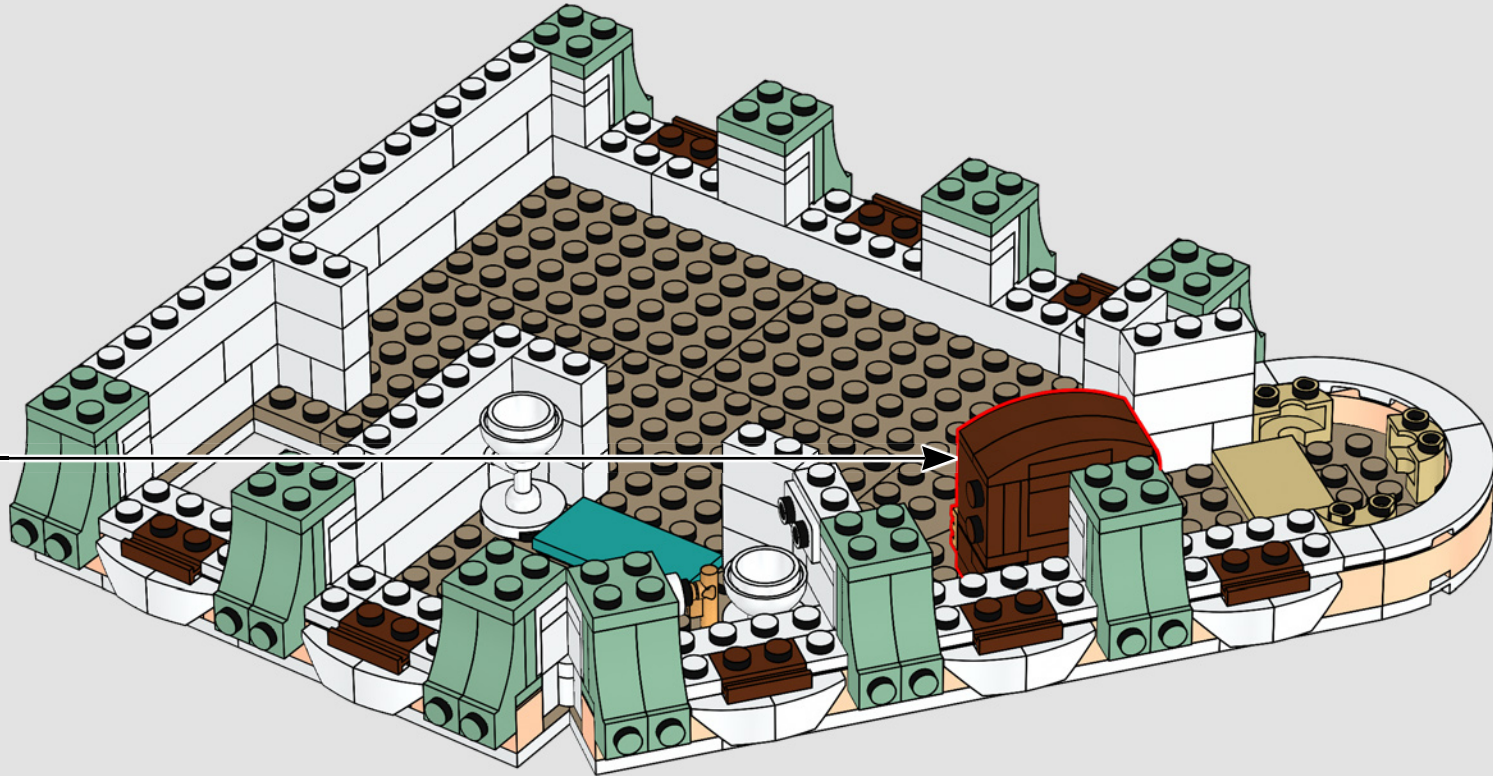



Die Weltenbummlerin war schon überall.  
Sie kommt aber immer wieder gerne ins  
Boutique-Hotel zurück, um sich von den  
Reisesträpazen zu erholen.

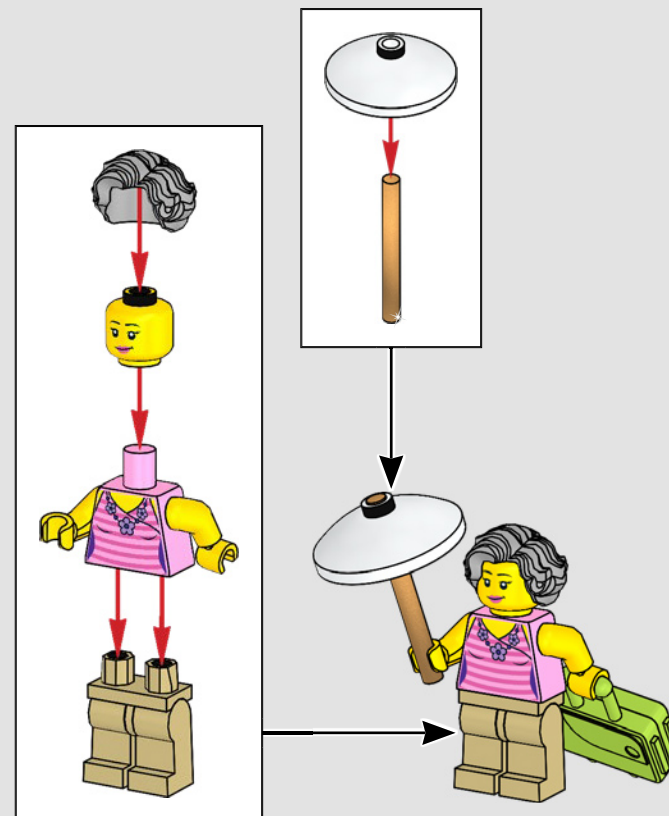
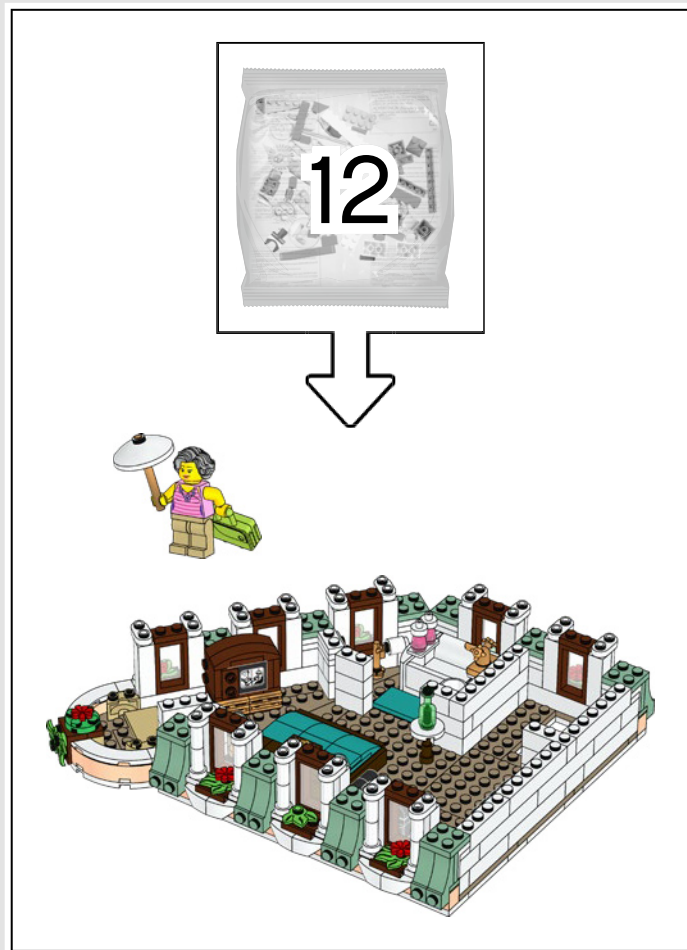

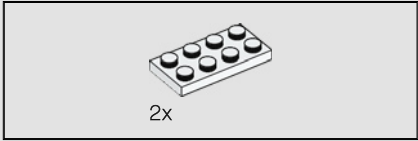
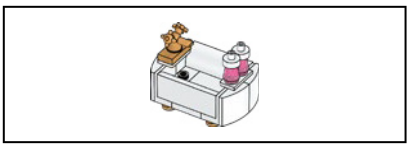

2x

336

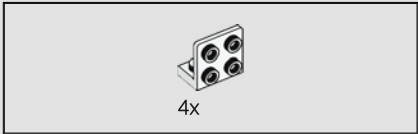
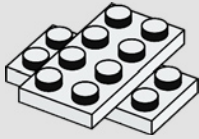

4x

337

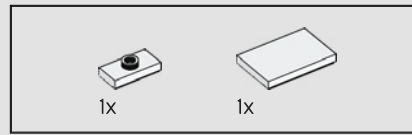
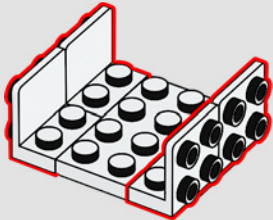

1x

1x

338

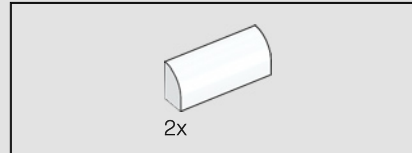
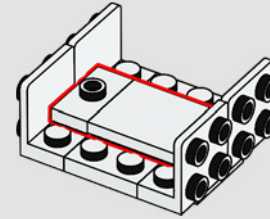

2x

339

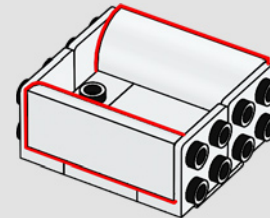

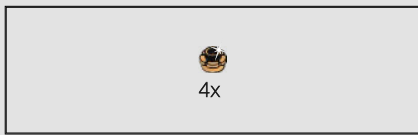

340

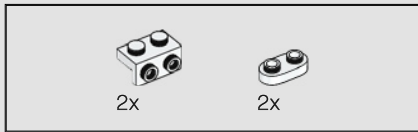
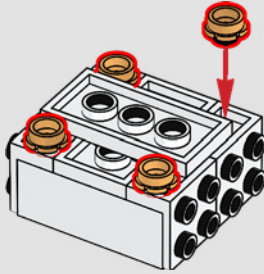

341

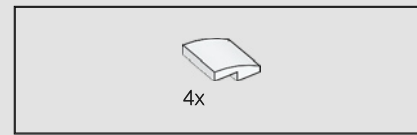
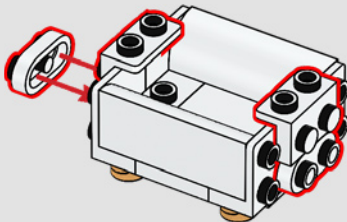

342

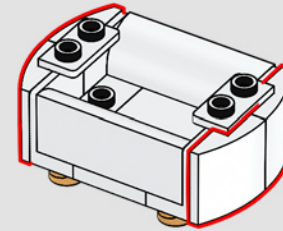

343

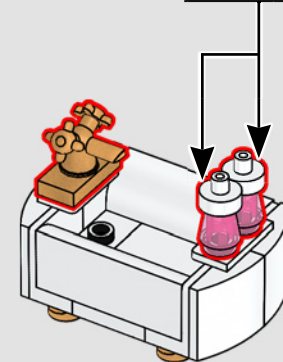
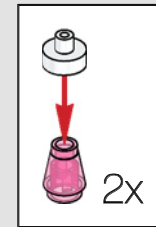

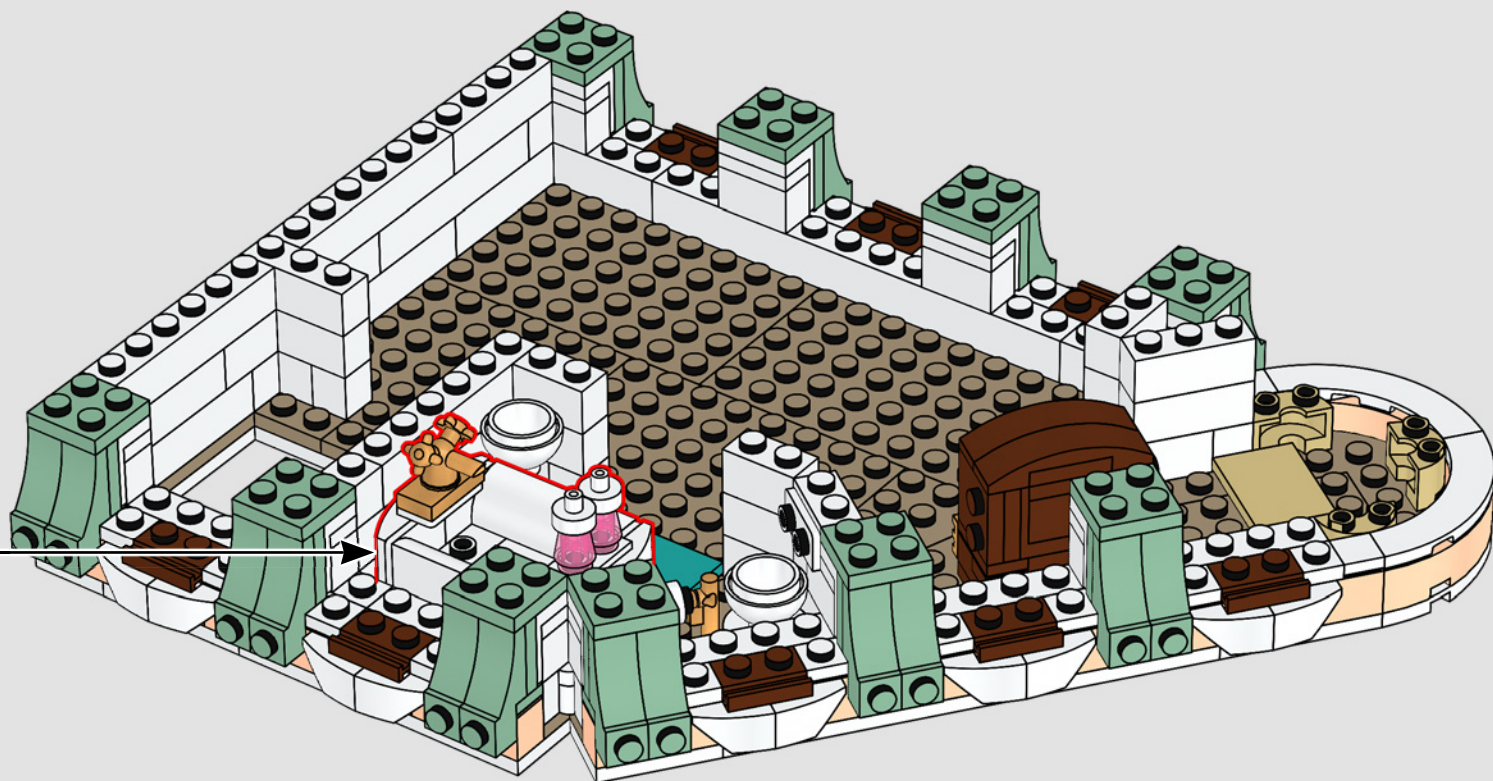



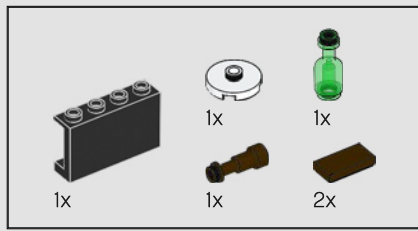

345

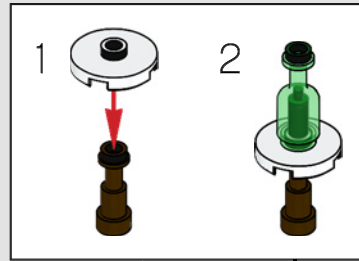

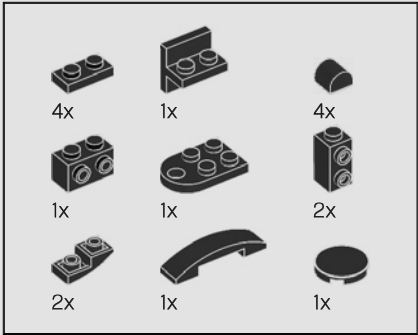

346

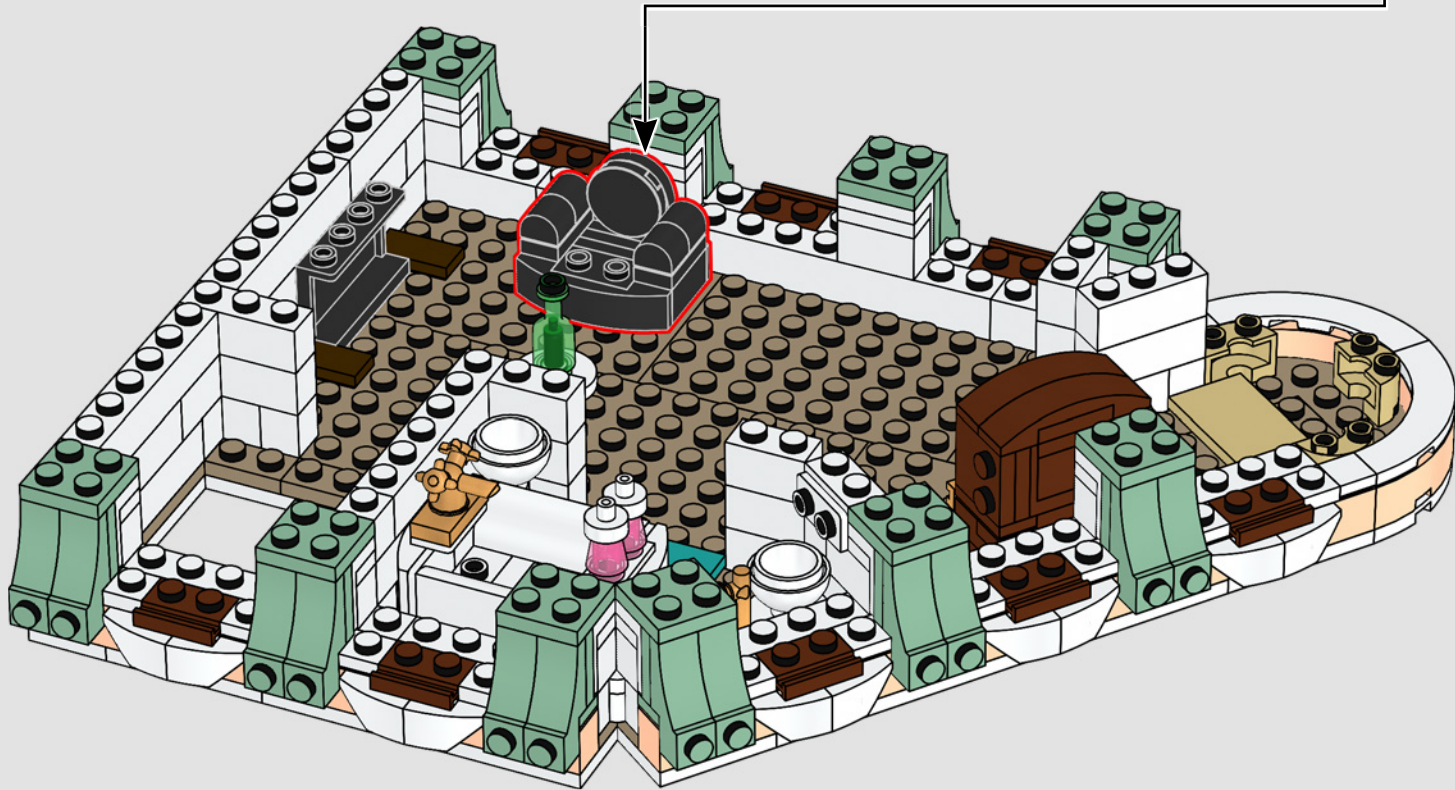
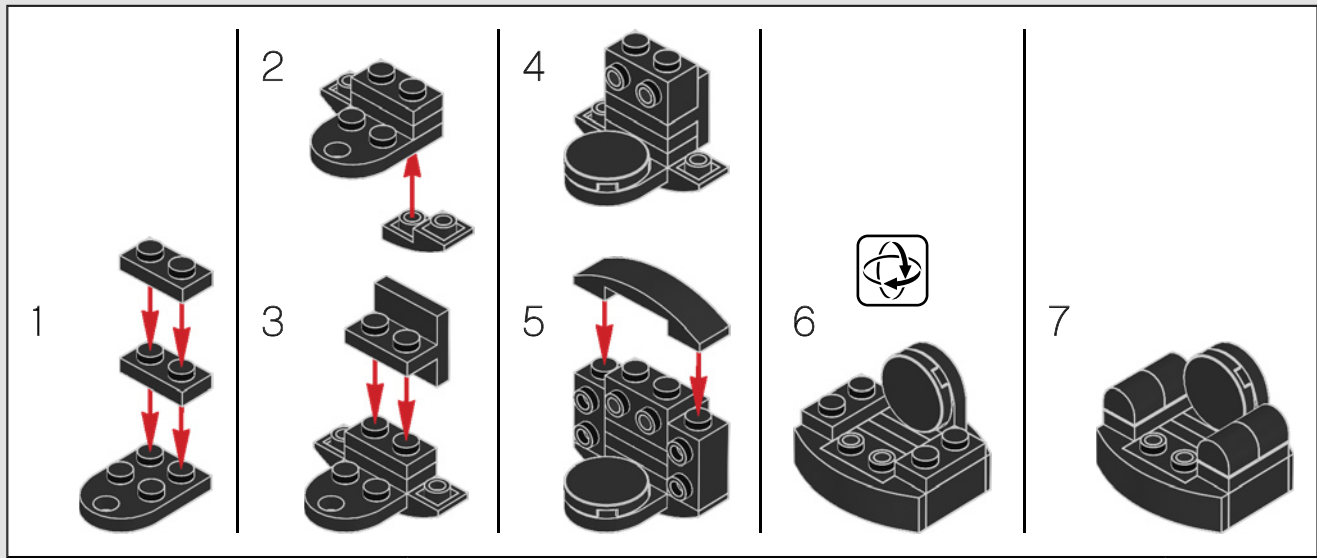



Der Lampenschirm ist eigentlich ein Cupcake-Element aus einem LEGO® Friends Set.

347

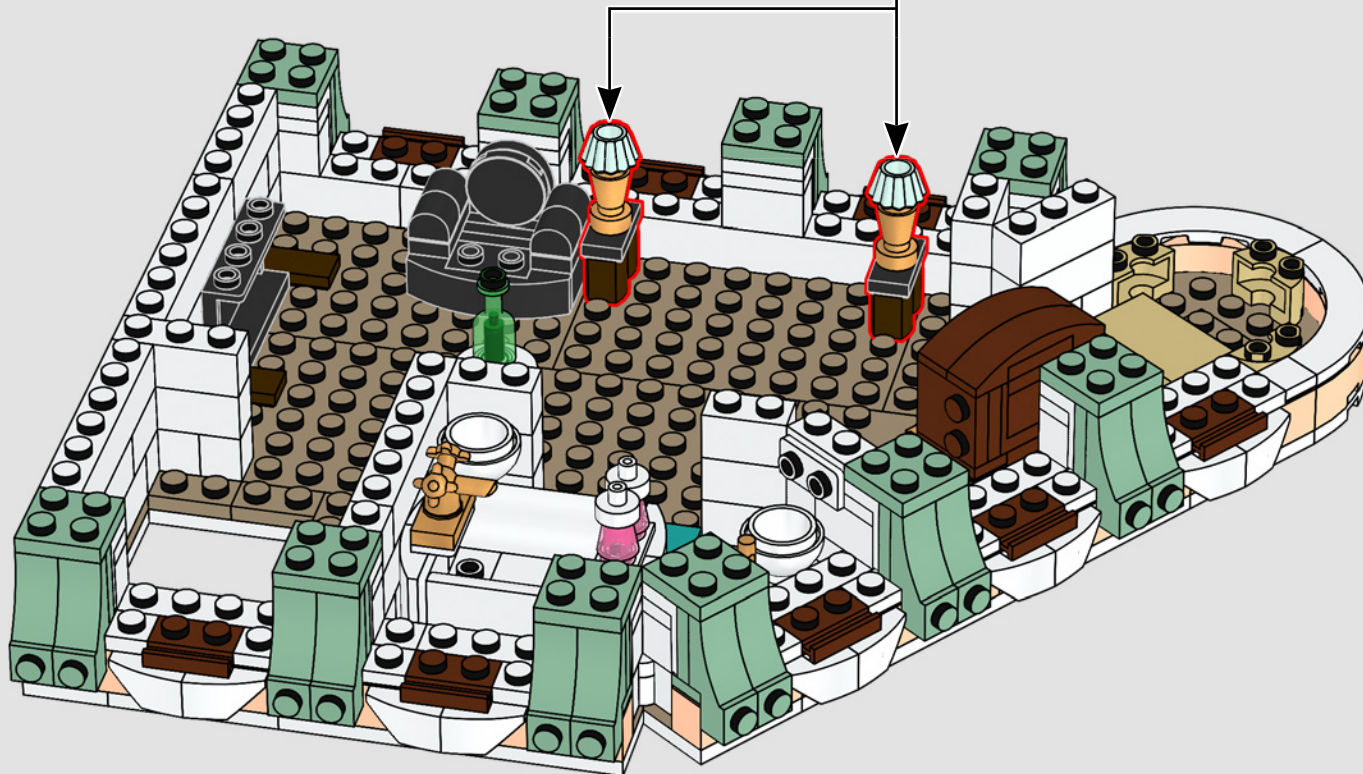
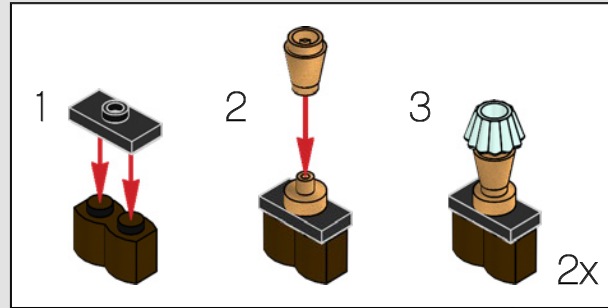

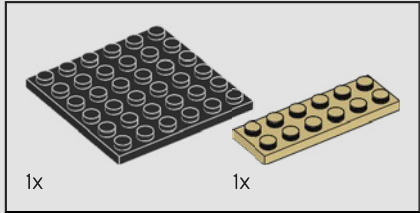
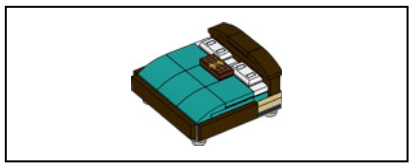

348

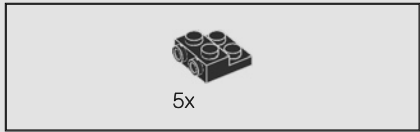
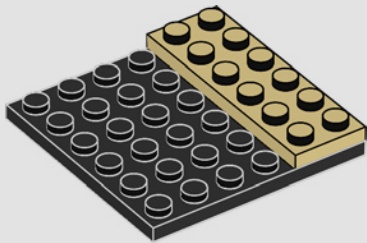

349

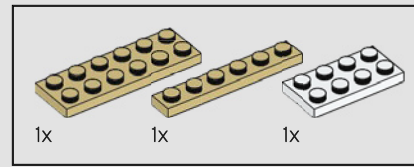
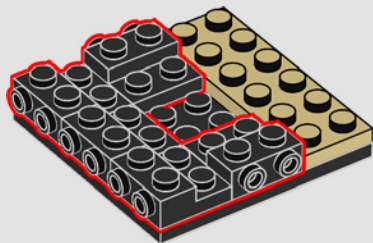

350

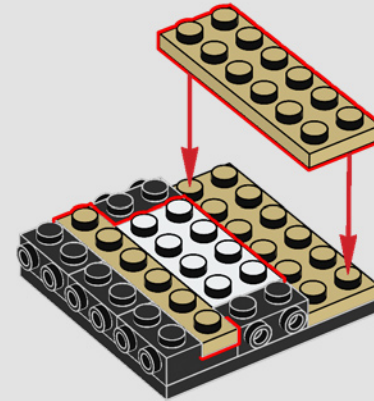

351

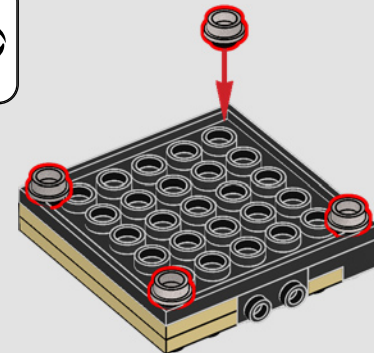
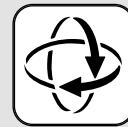

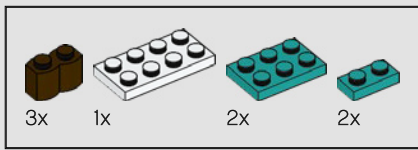

352

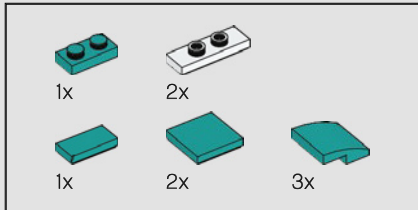
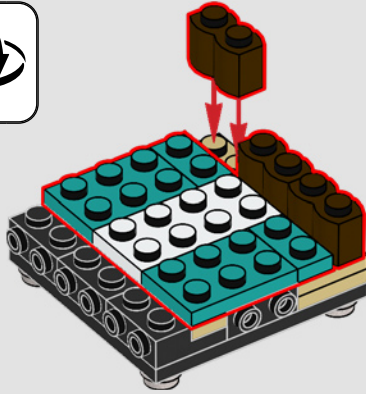

353

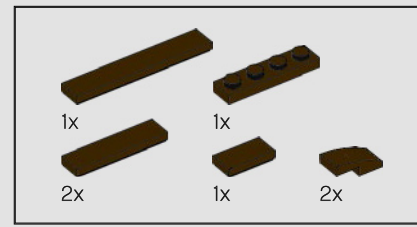
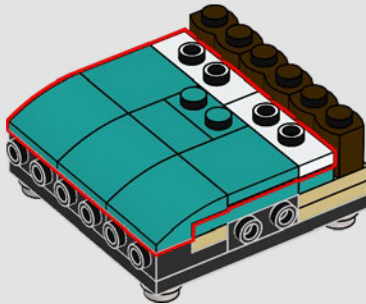

354

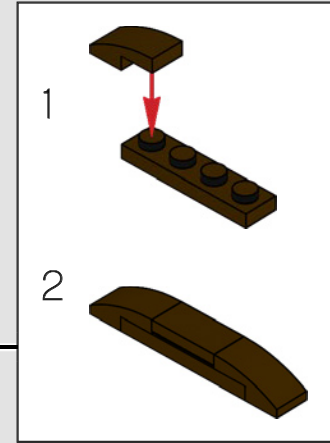
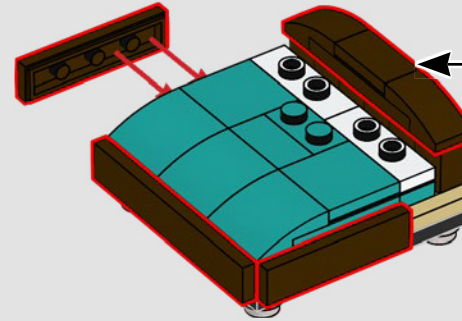

355

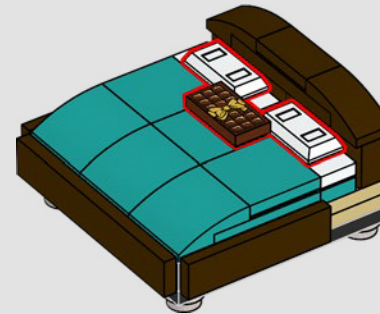

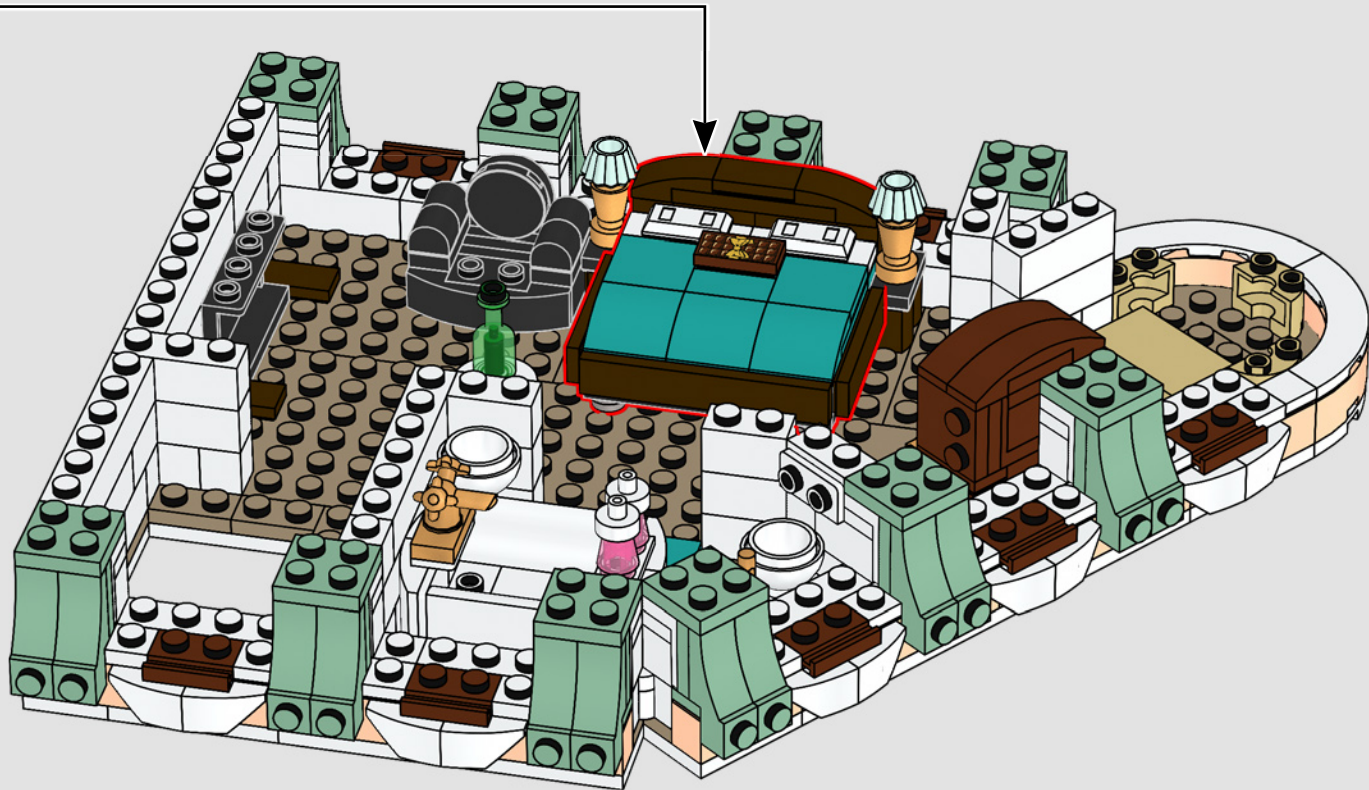

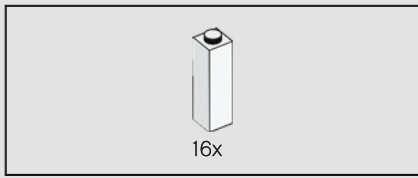

357

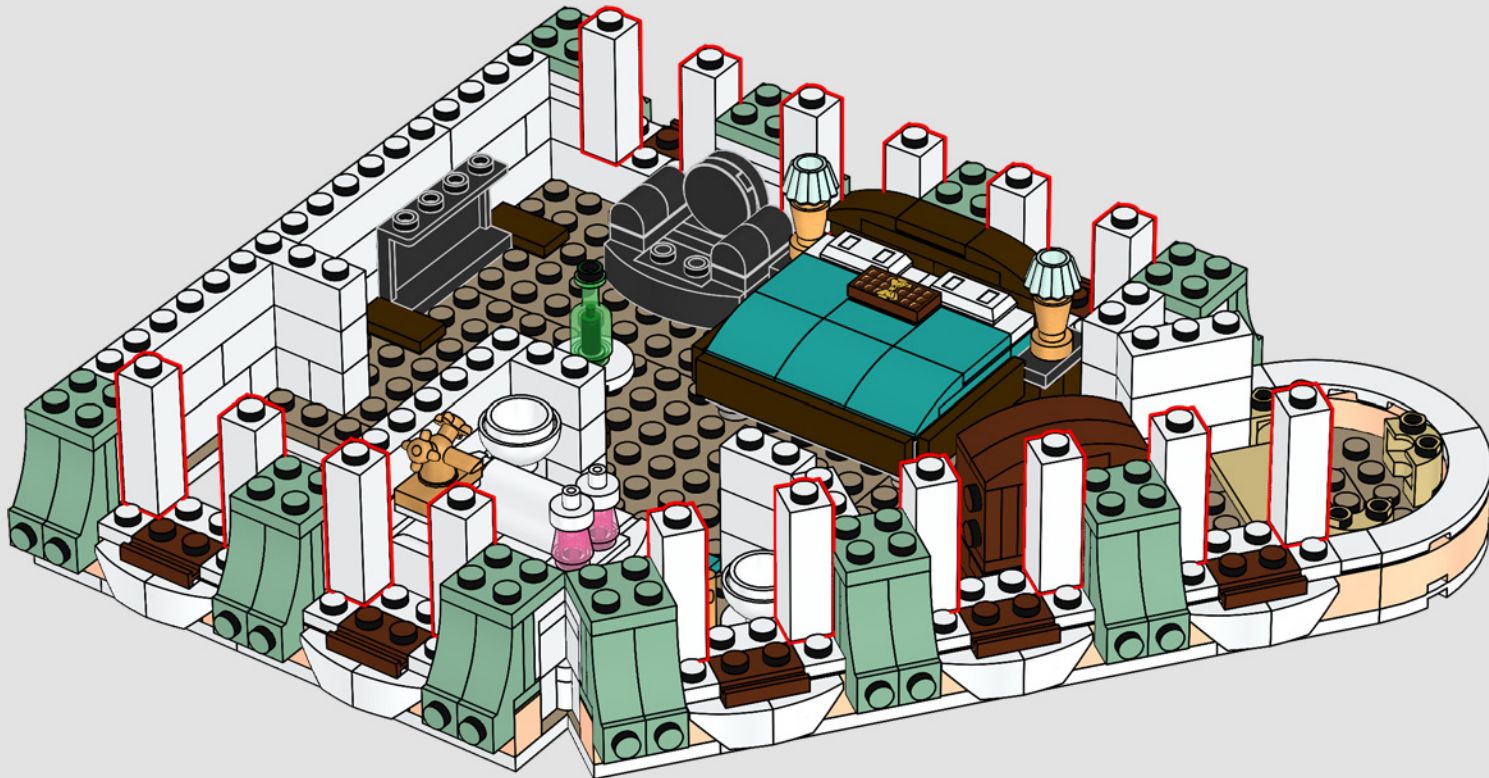

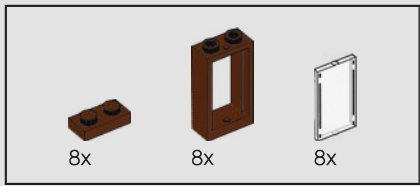

358

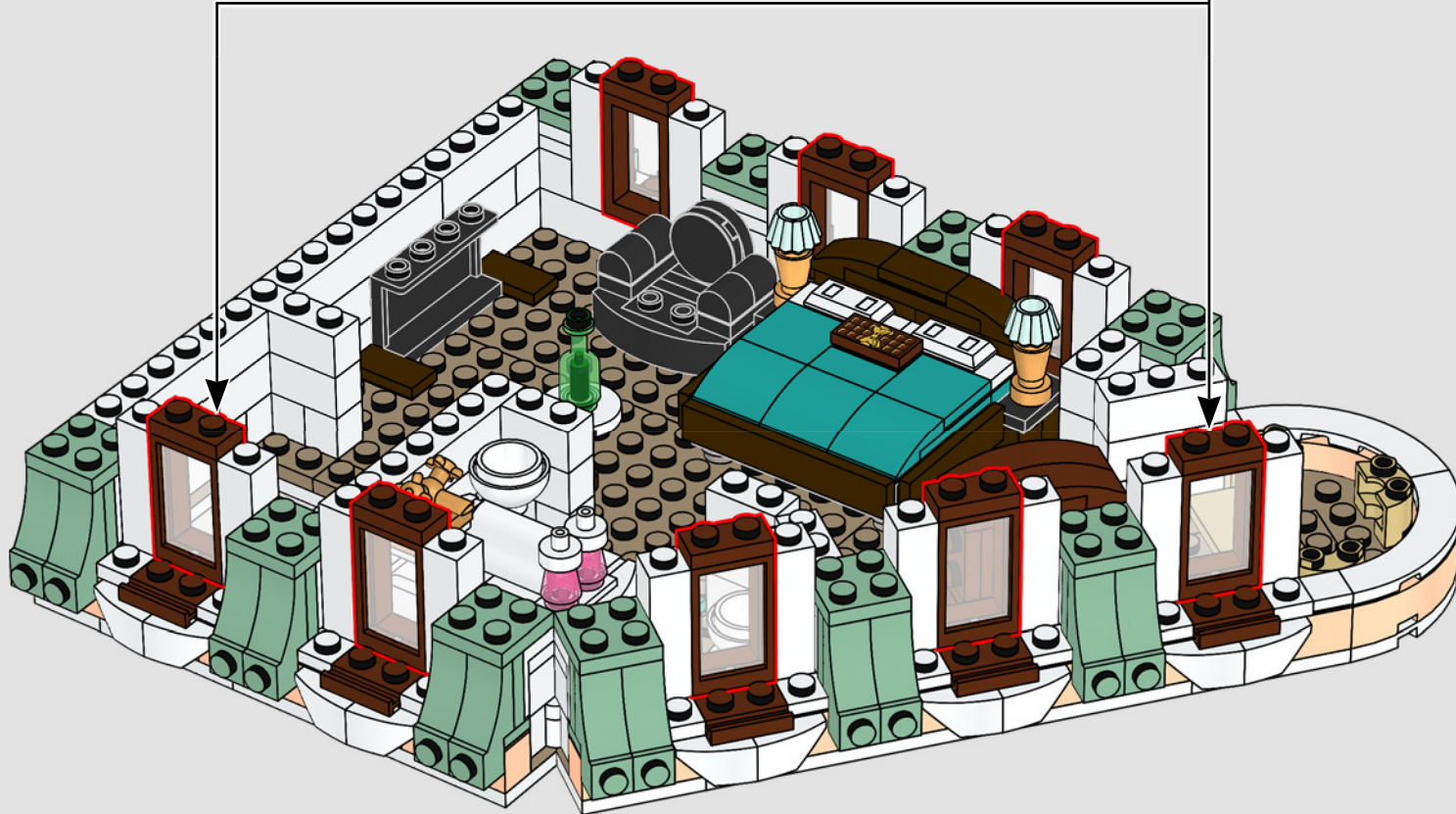
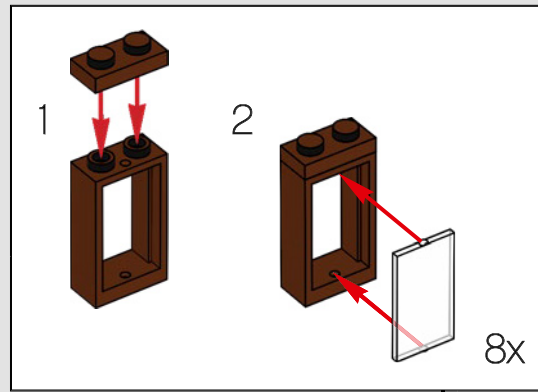



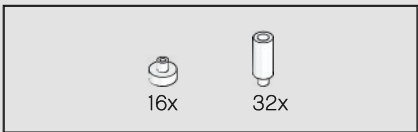

359

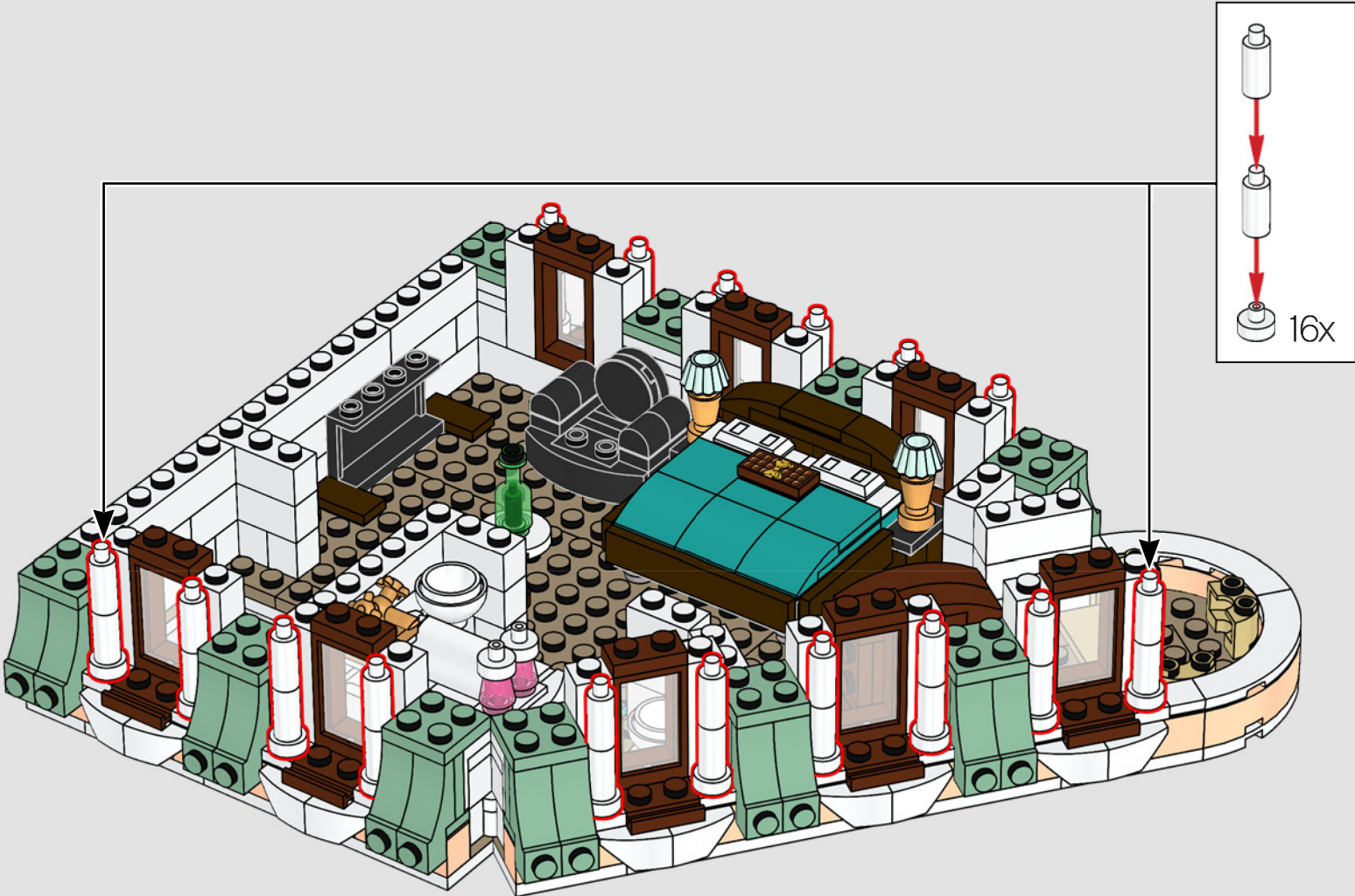



16x

360

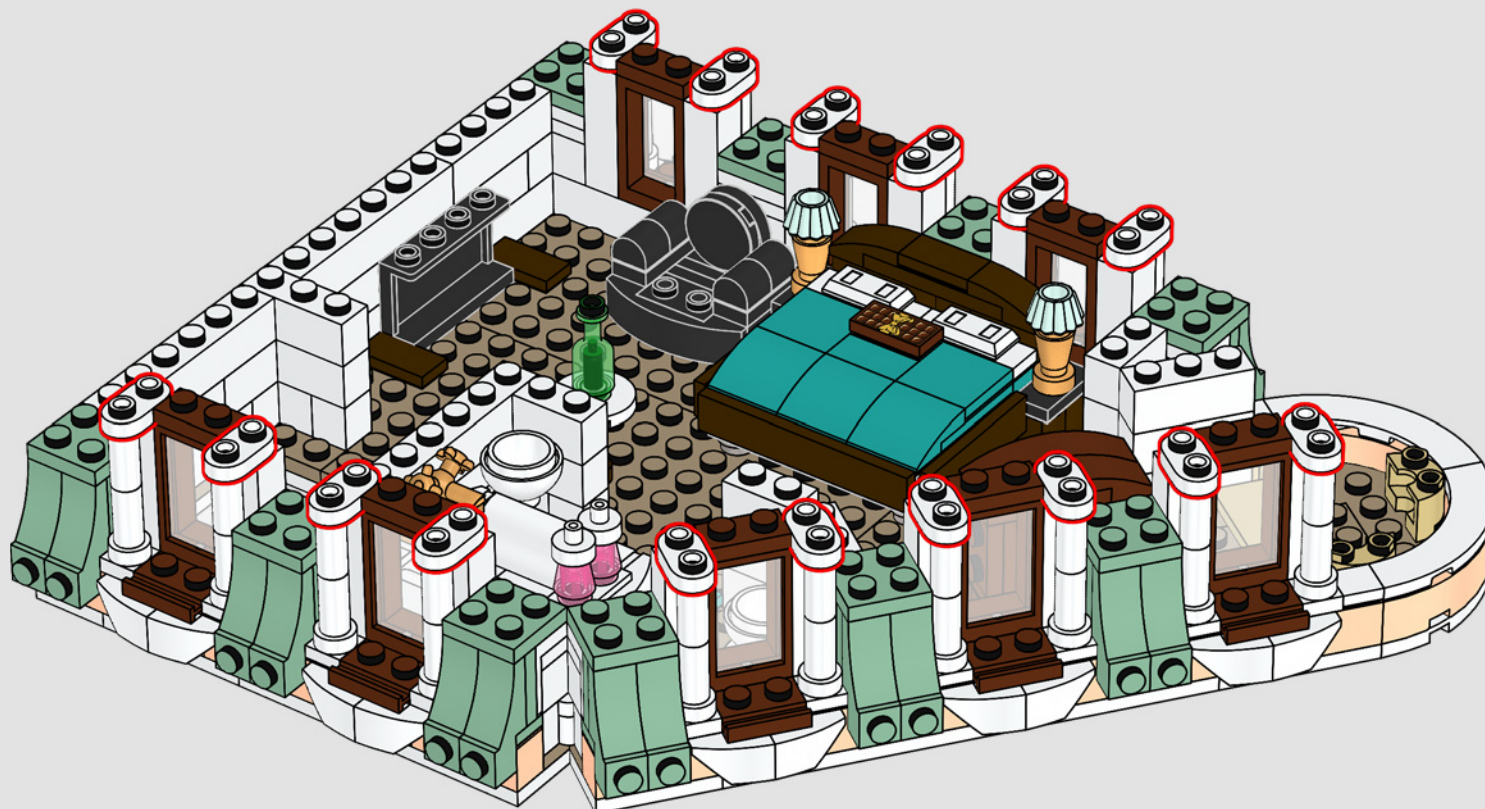

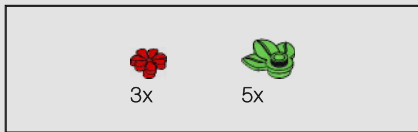

361

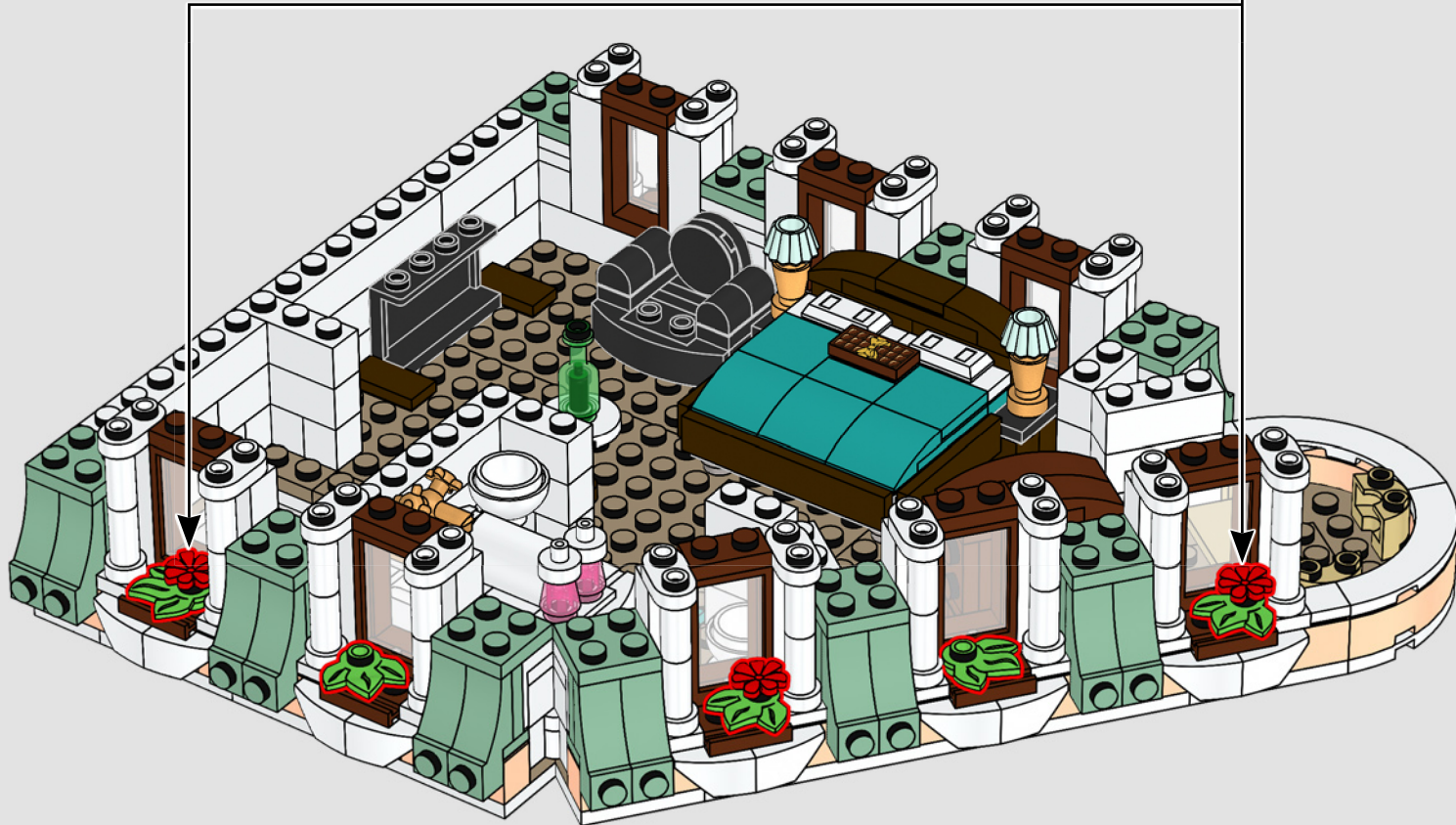
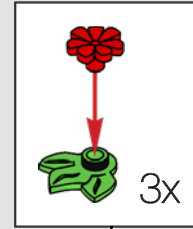

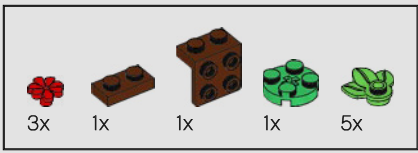

362

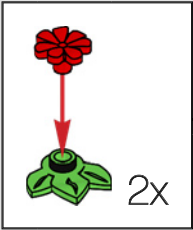
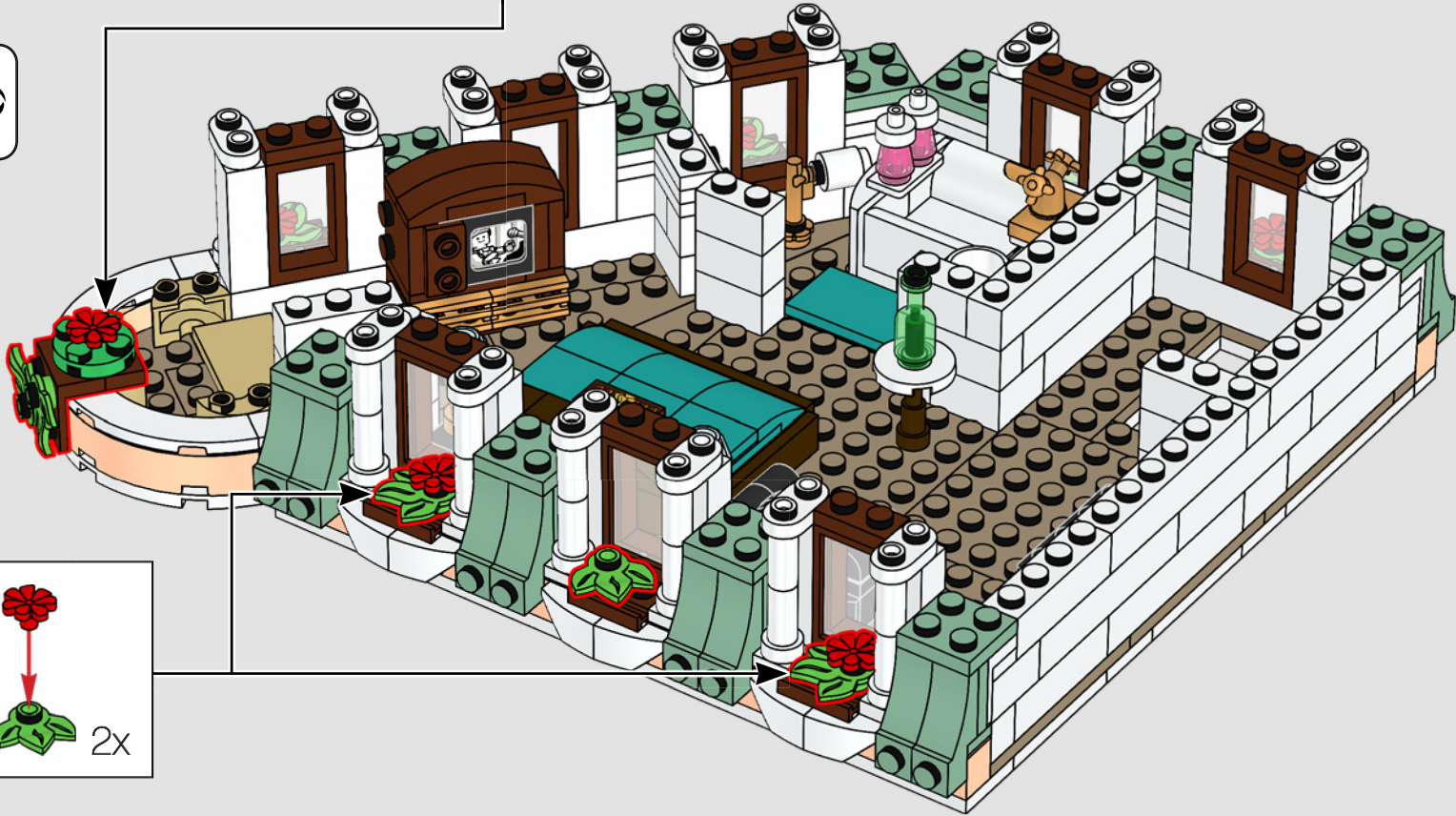
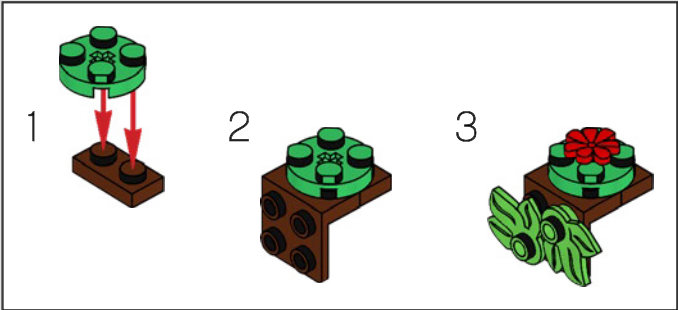

13

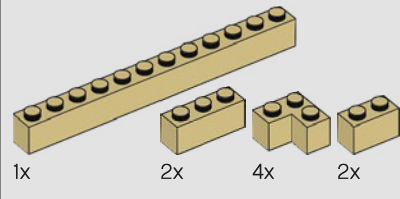
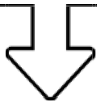

363

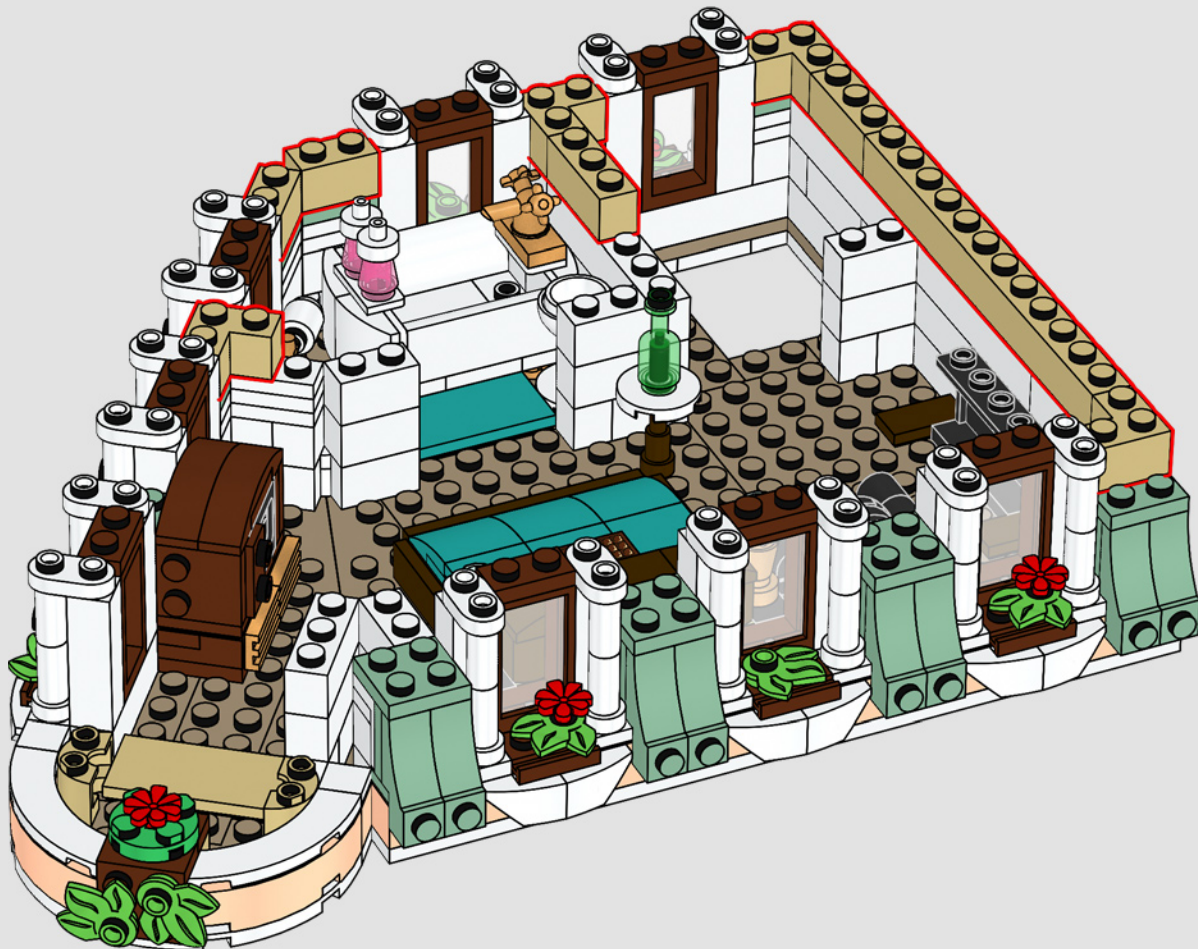

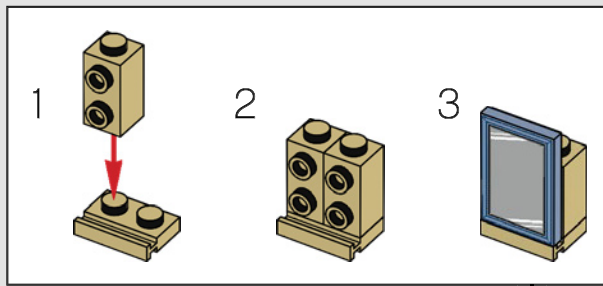
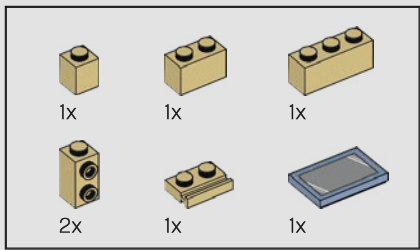

364

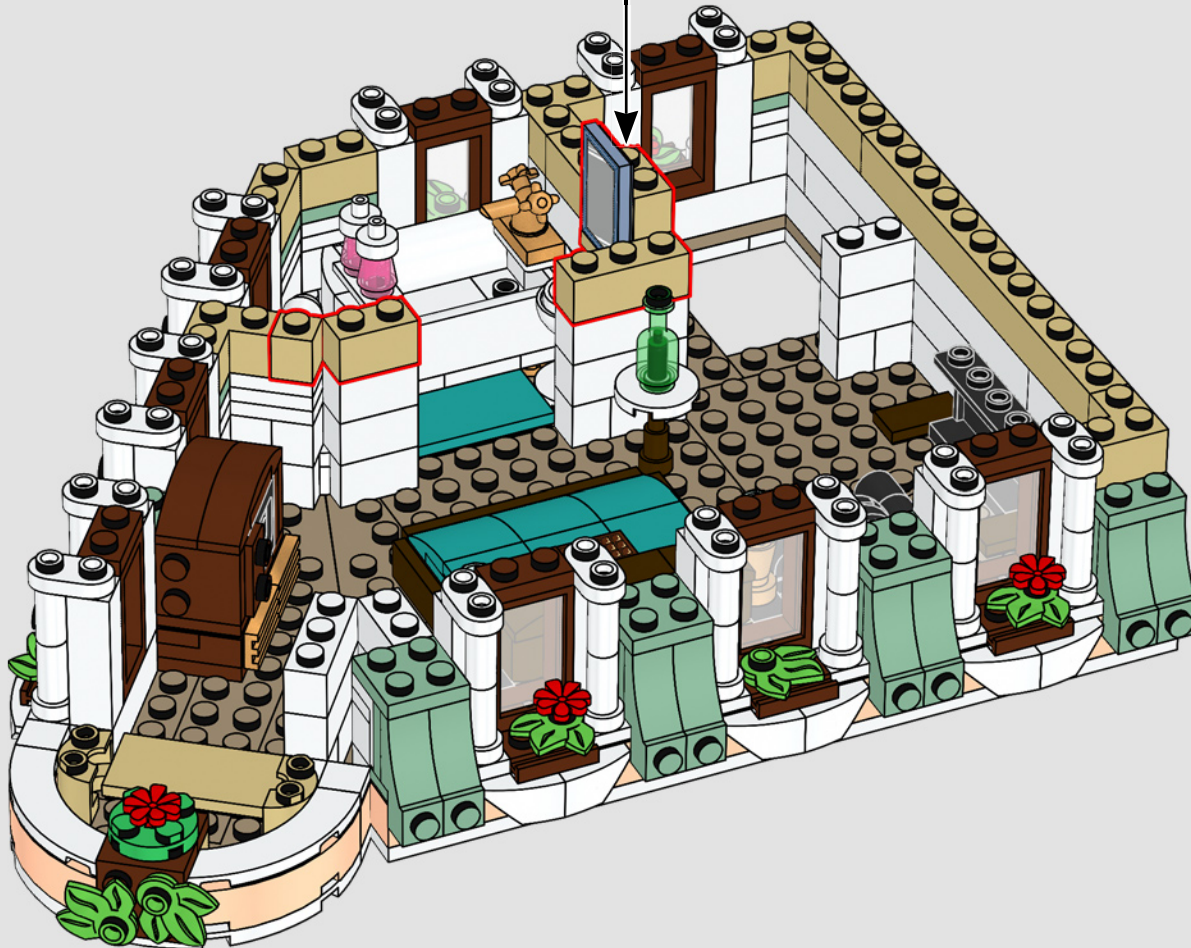

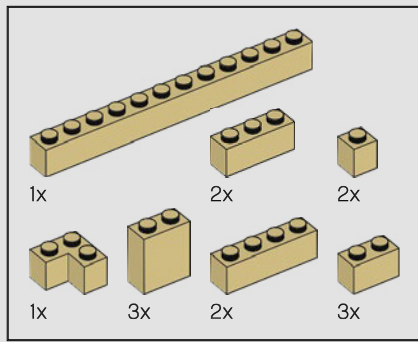

365



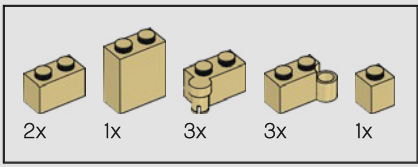

366

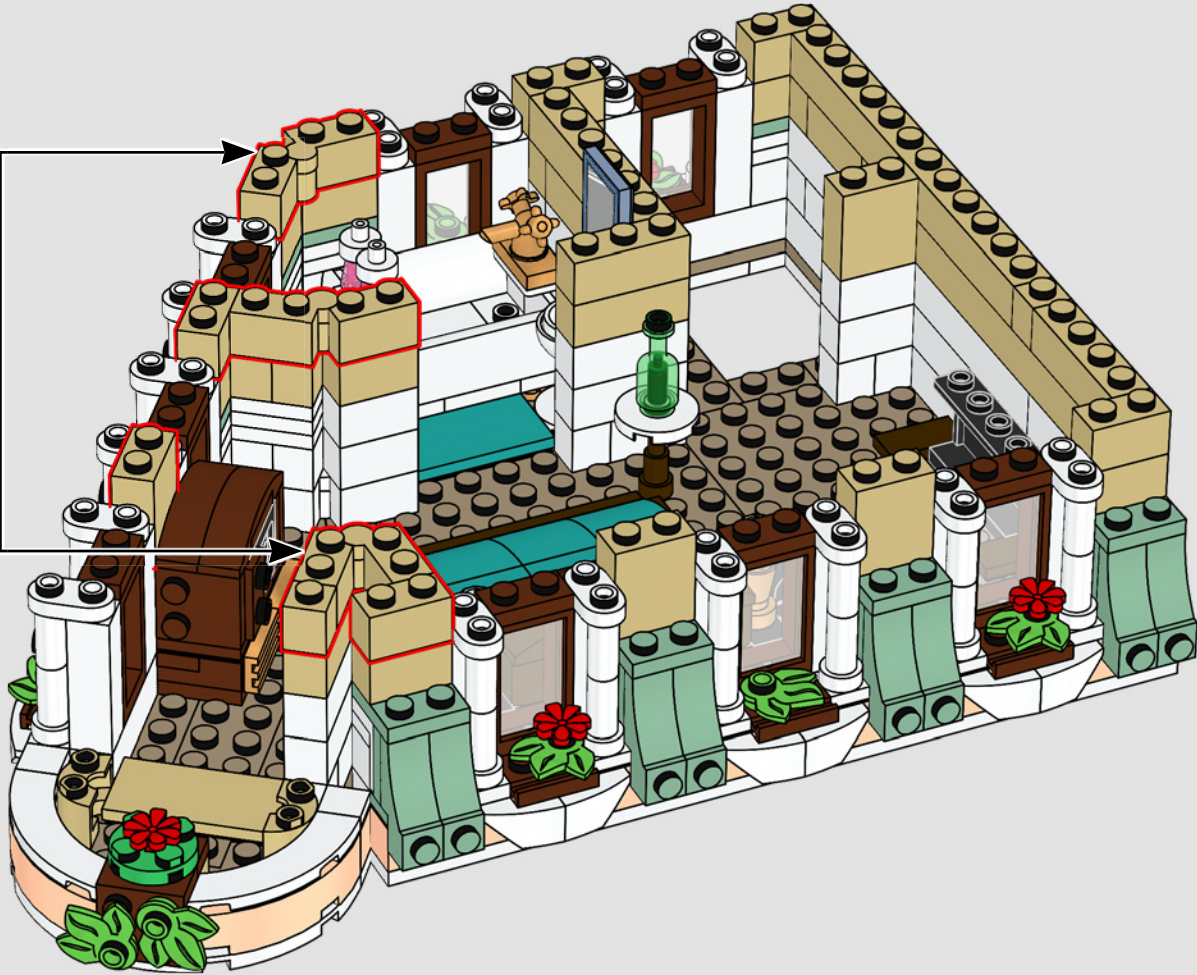
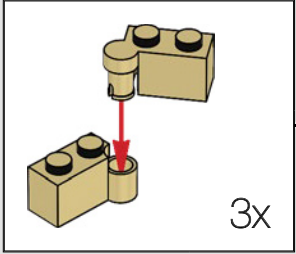



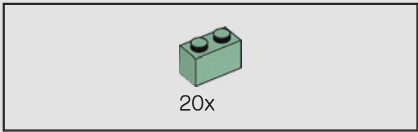

367

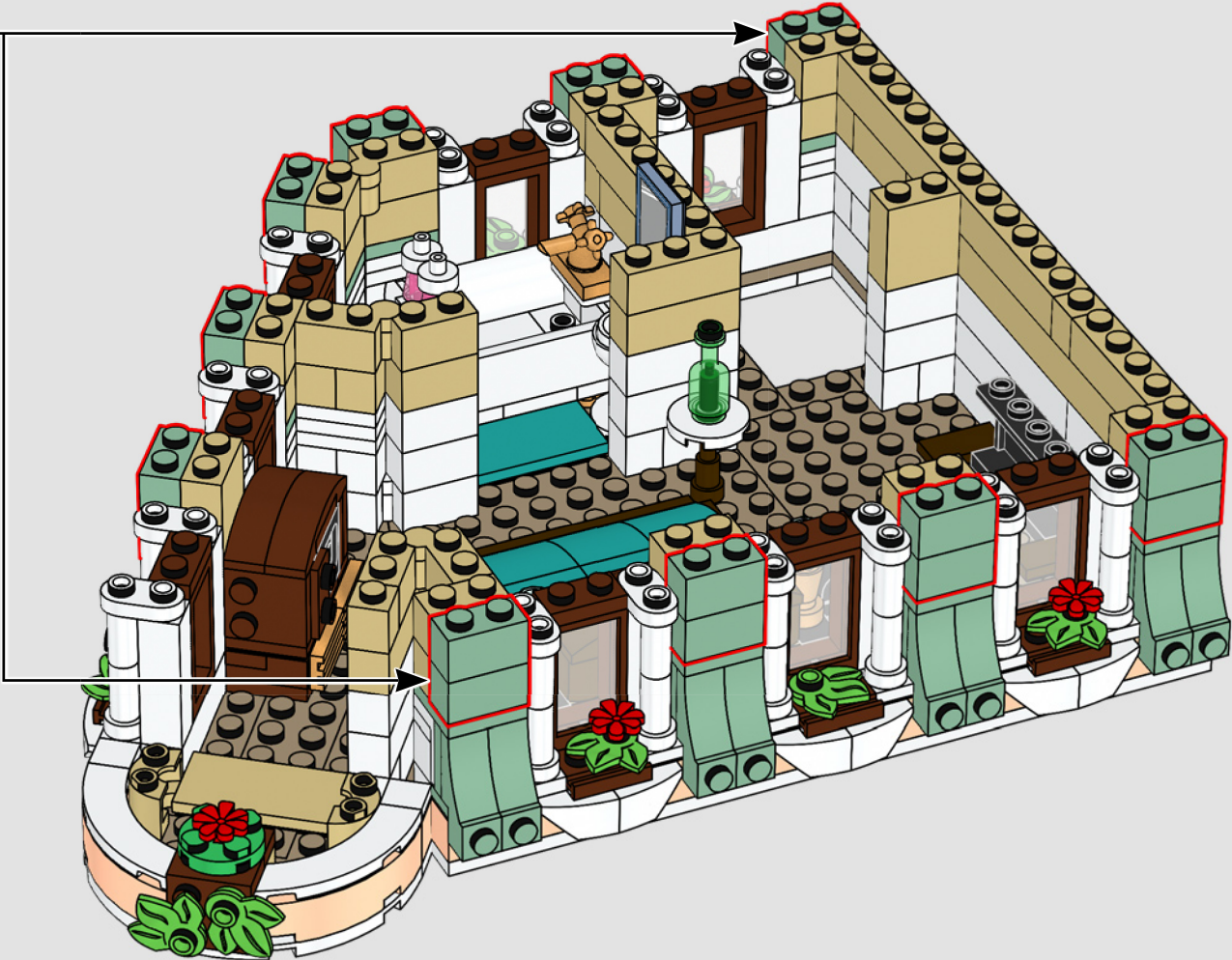
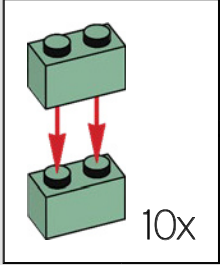

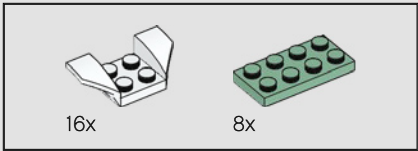

368

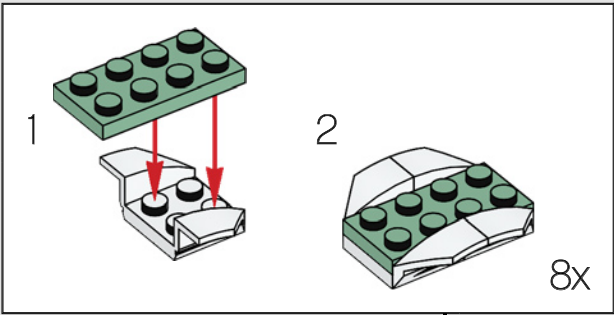

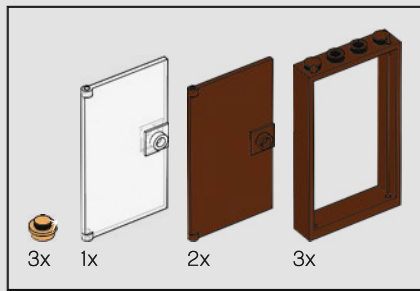

369

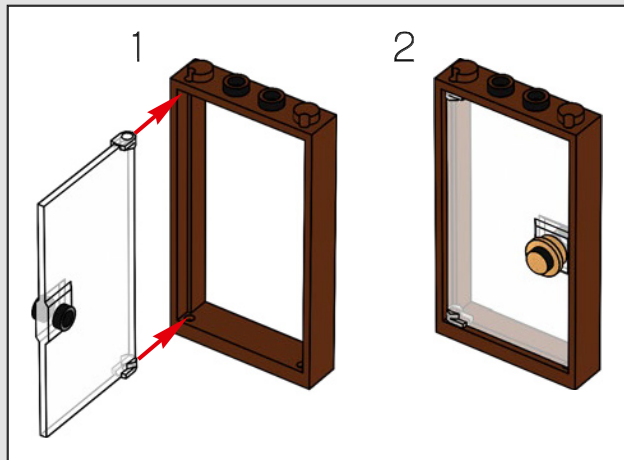
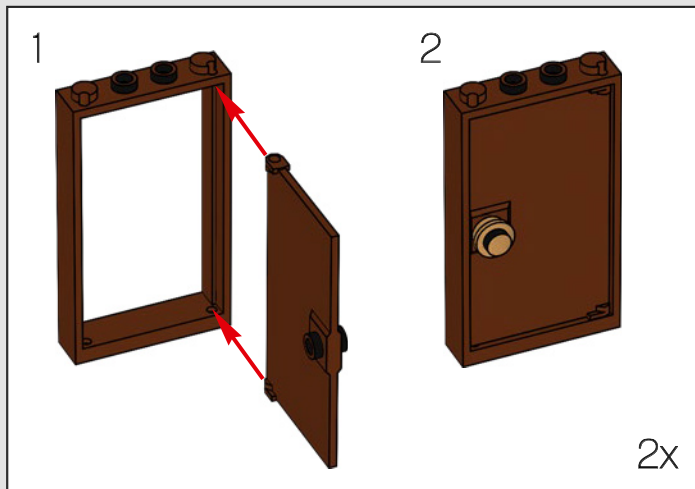

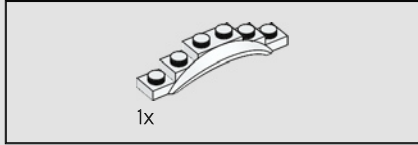
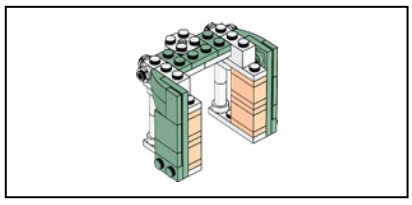

370

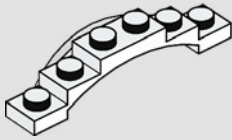

371

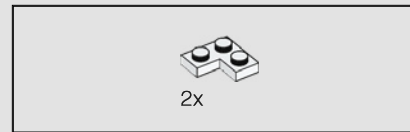
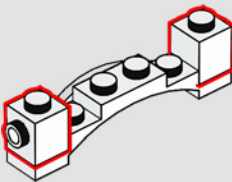

372

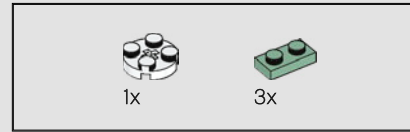
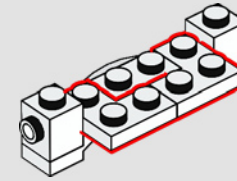

373

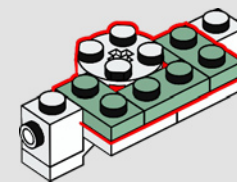



374

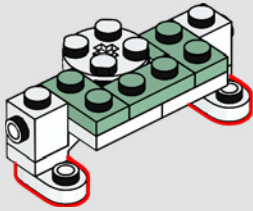

375

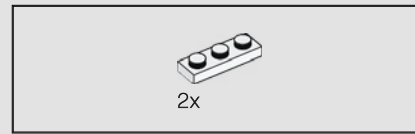
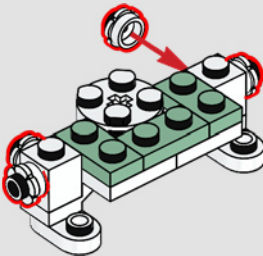

376

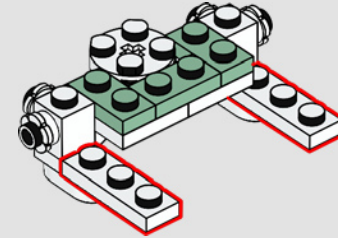

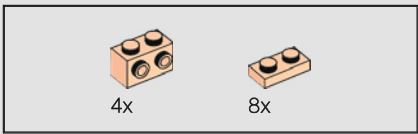

377

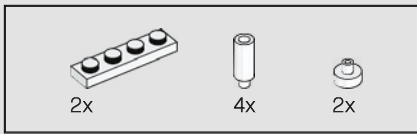
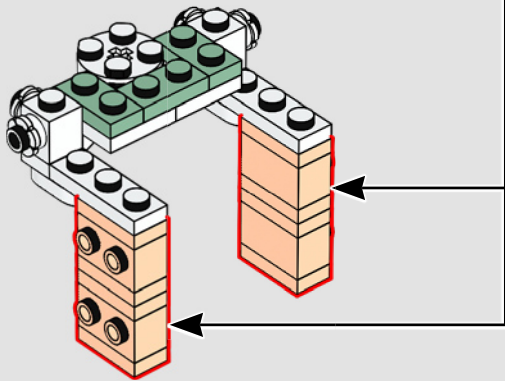
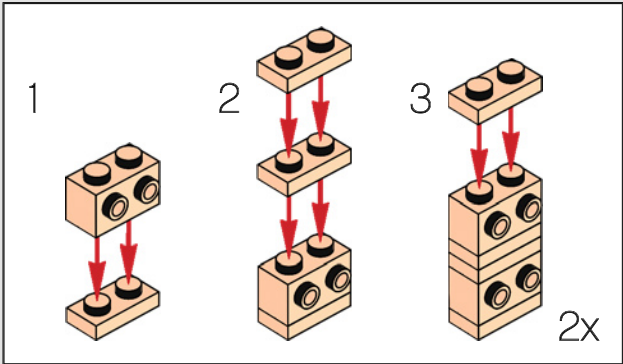

378

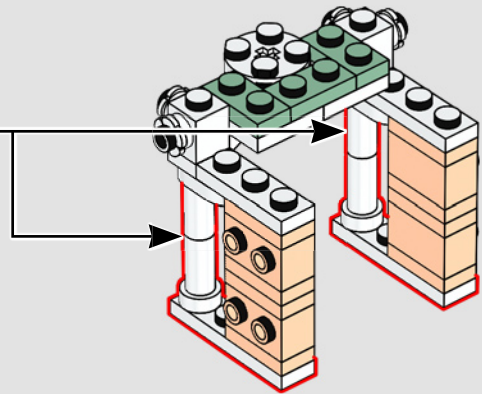
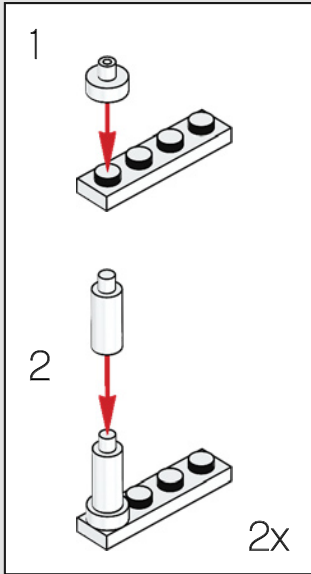

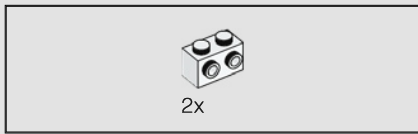

379

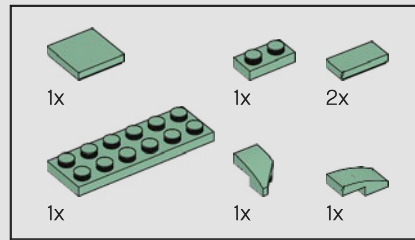
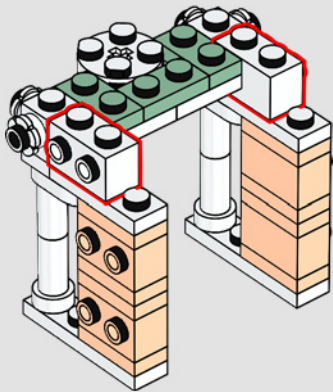

380

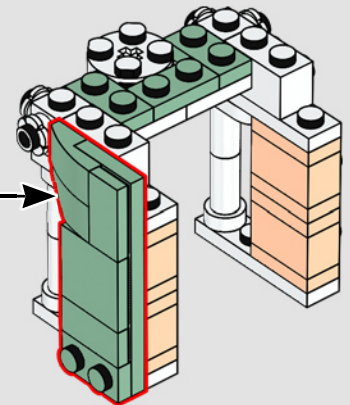
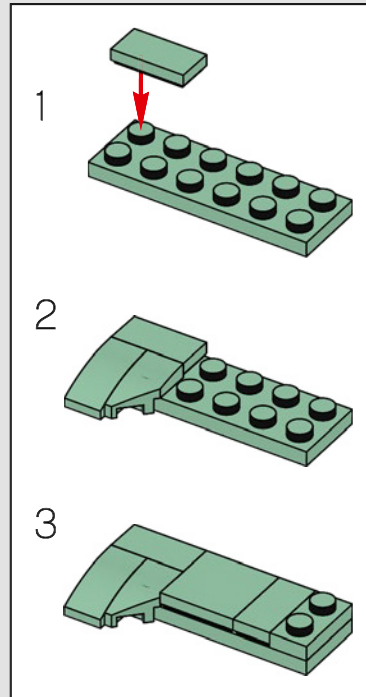

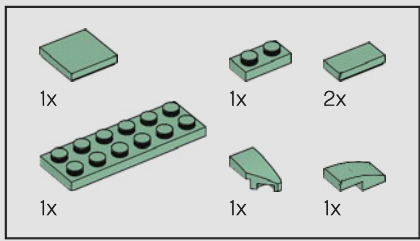

381

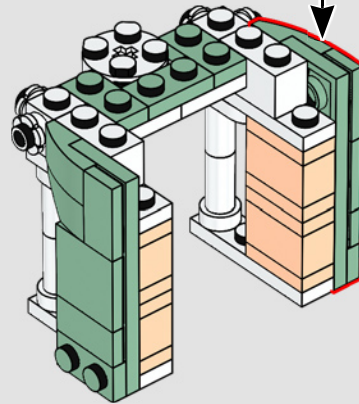
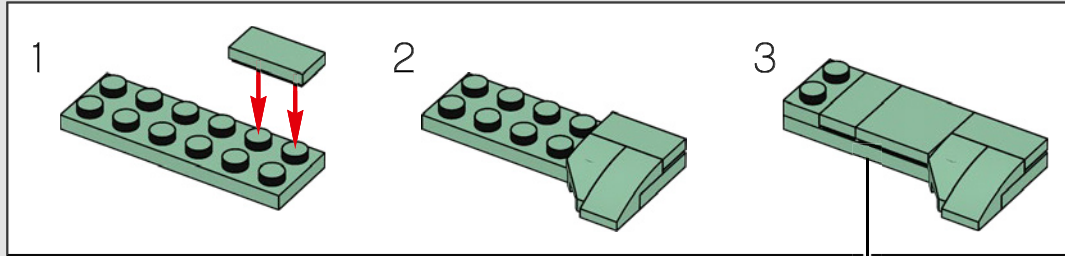



382

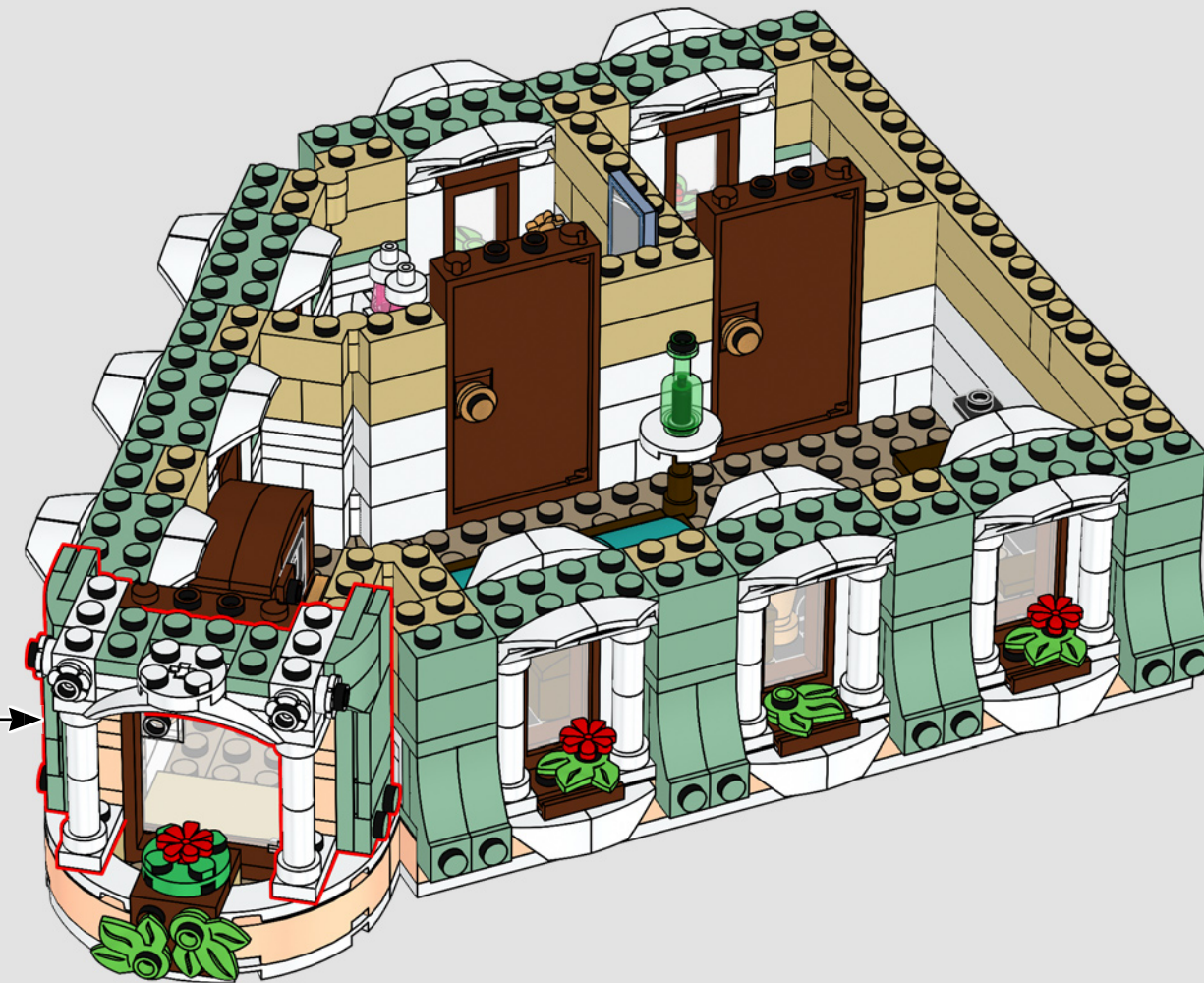

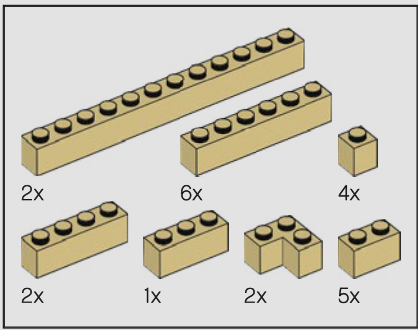

383

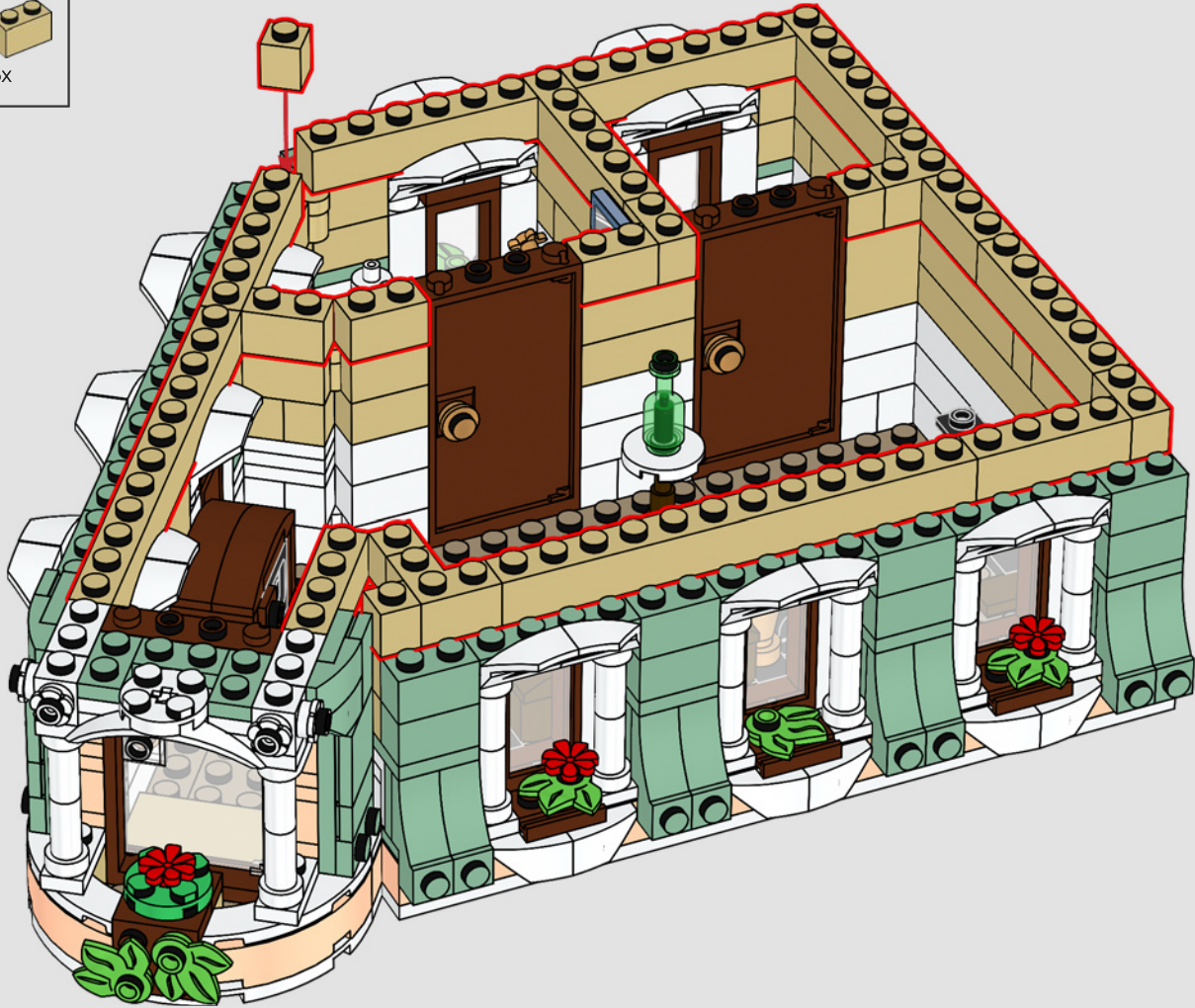

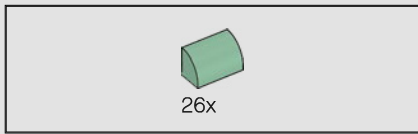

384



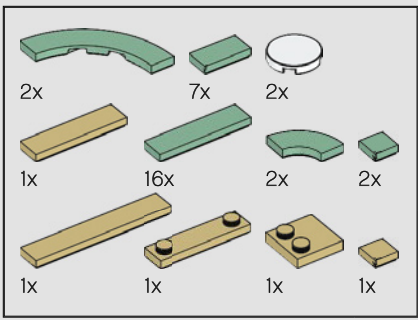

385

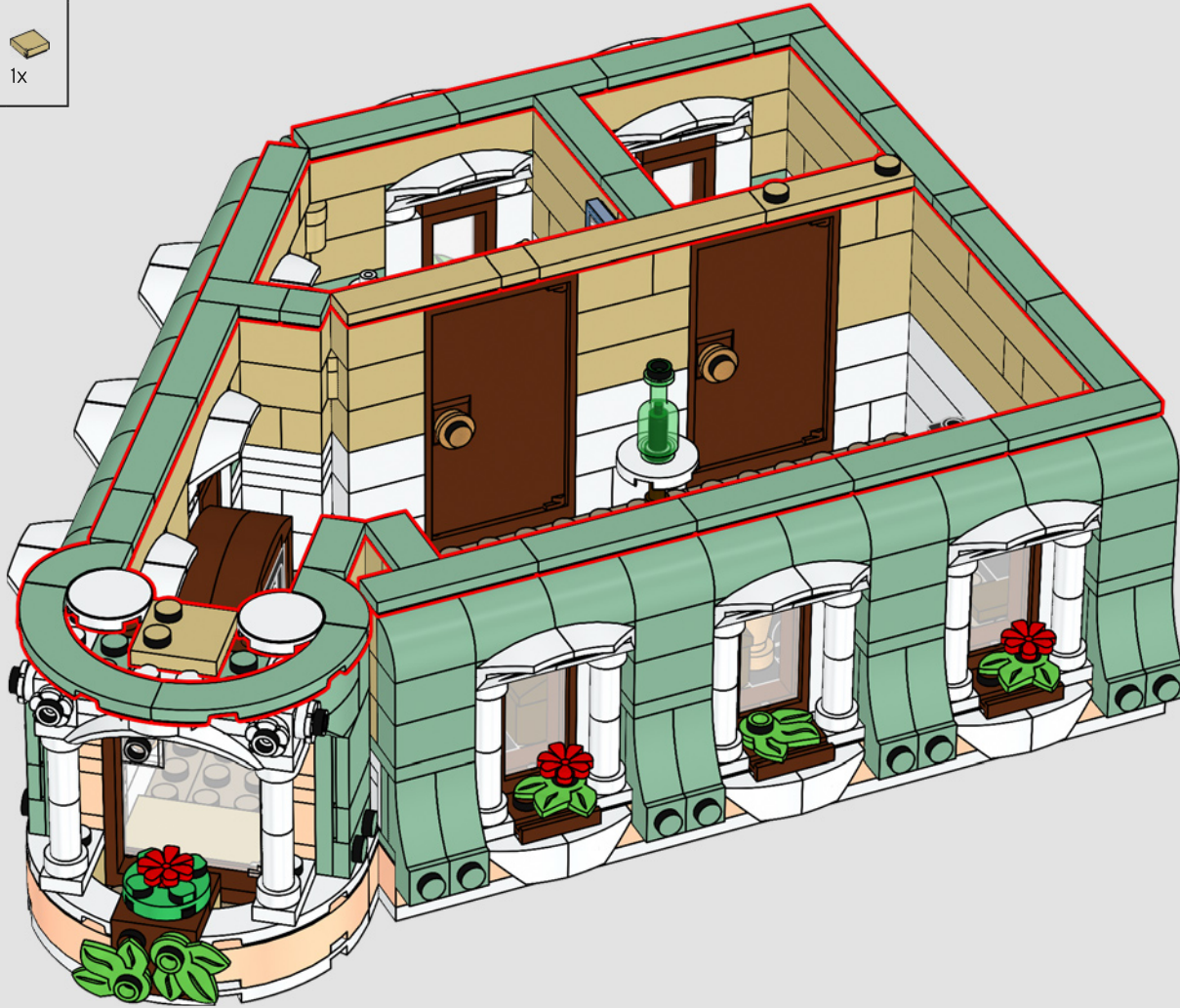

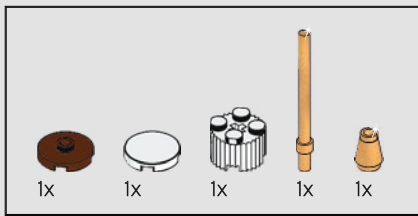

386

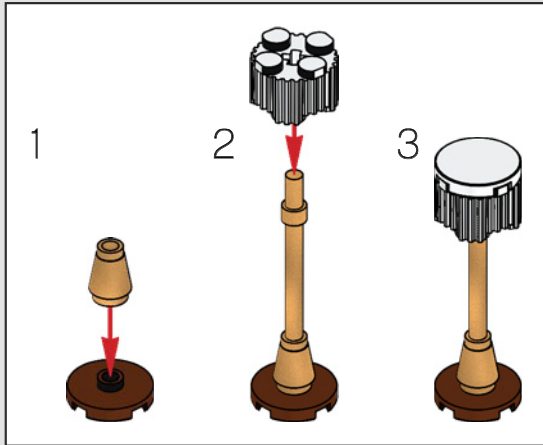

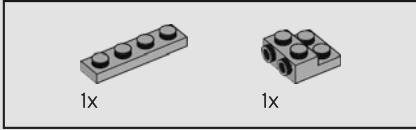
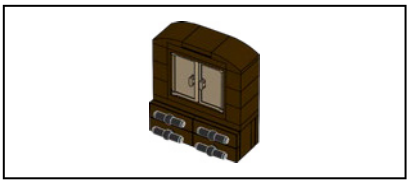

387

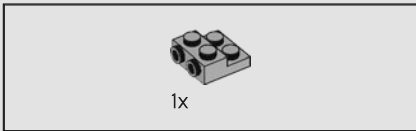
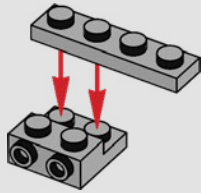

388

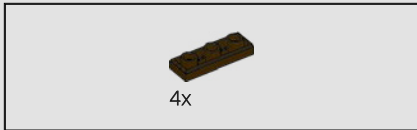
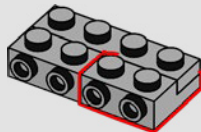

389

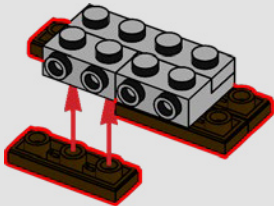

390

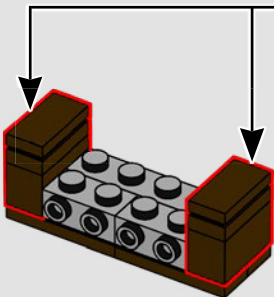
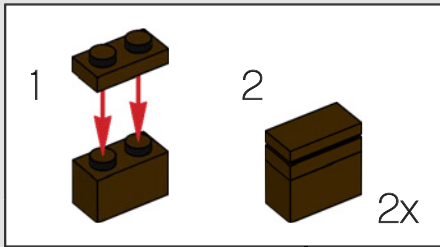

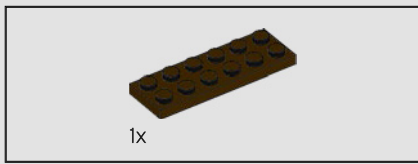

391

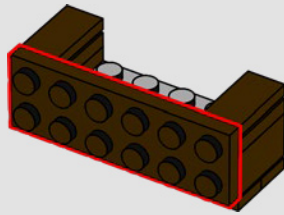

392

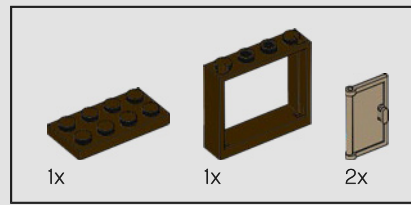
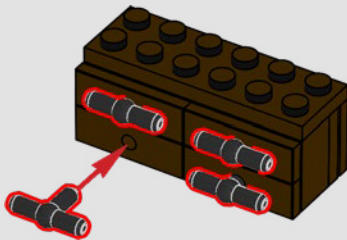

393

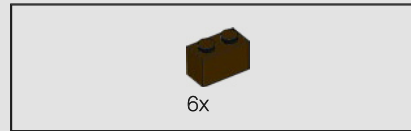
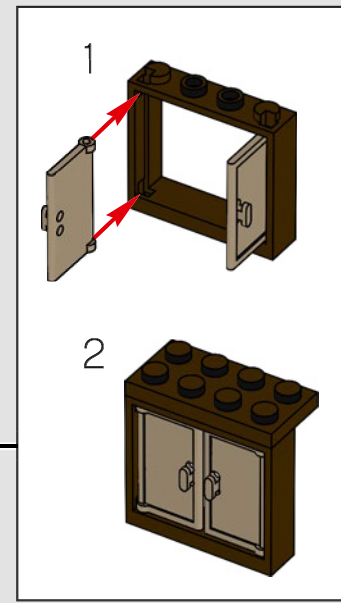
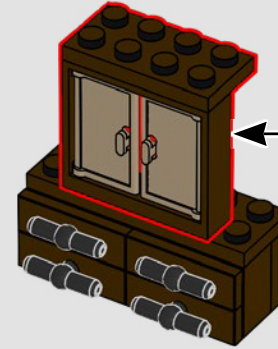

394

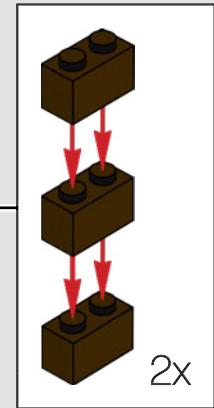
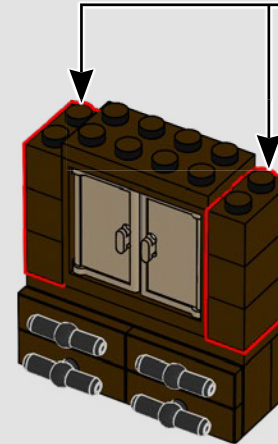

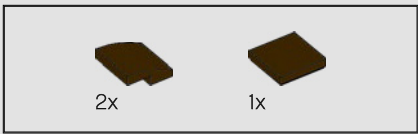

395

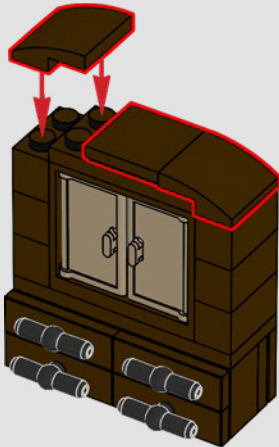

396





397

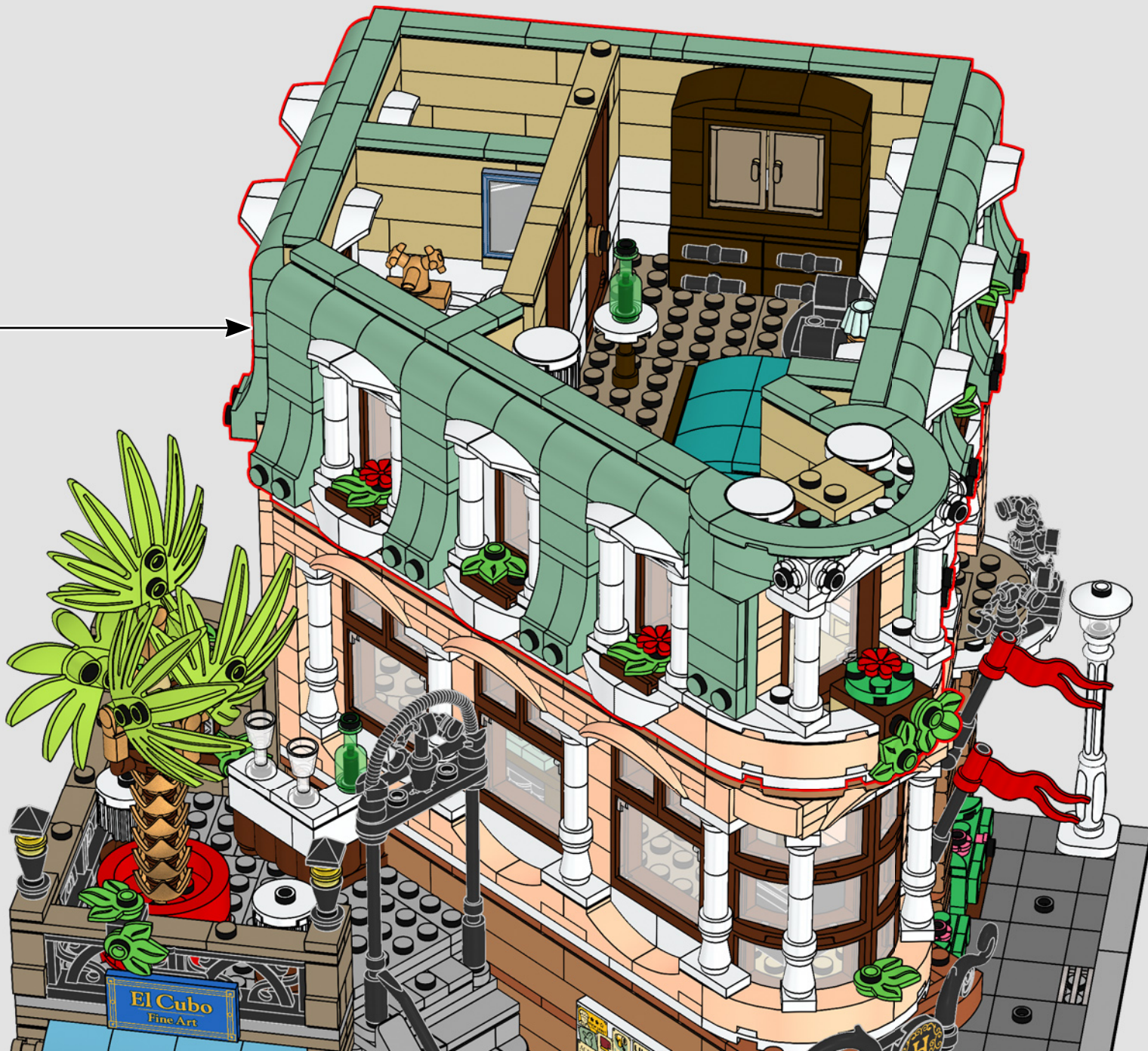

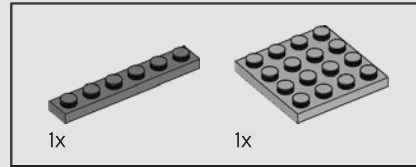
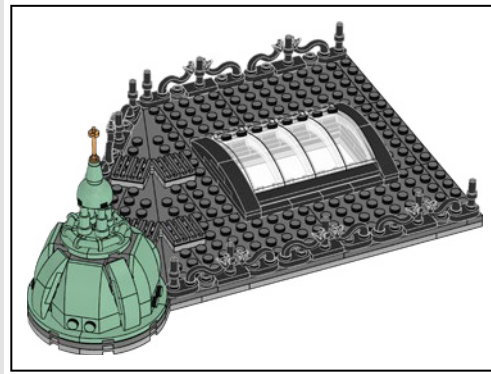
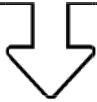

1x

1x

398

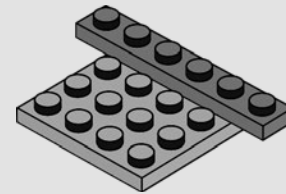

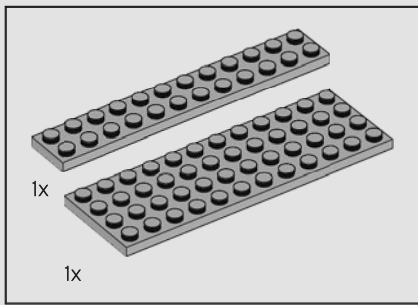

399

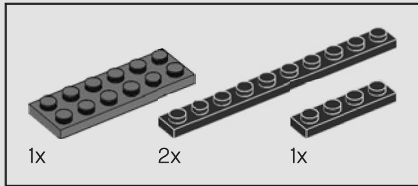
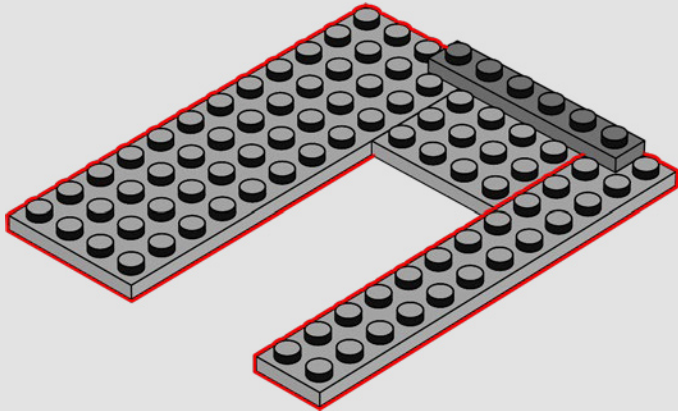

400

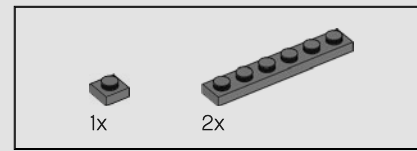
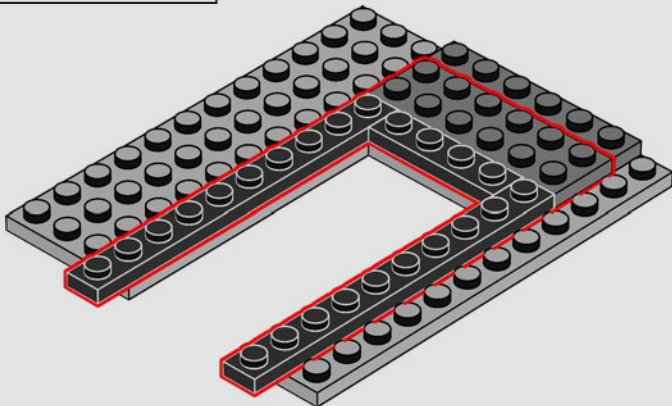

401

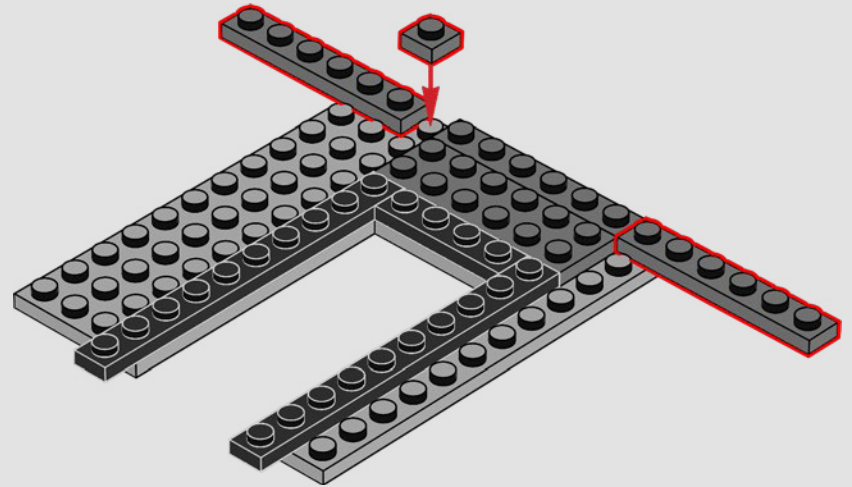

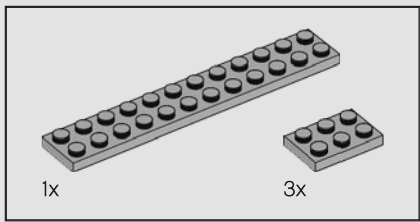

402

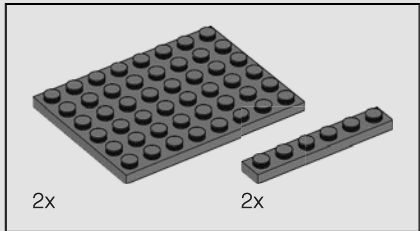
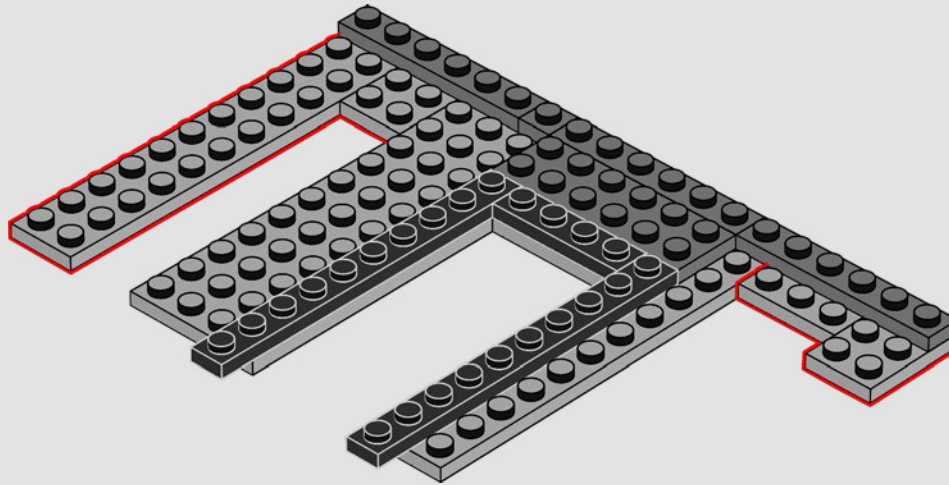

403

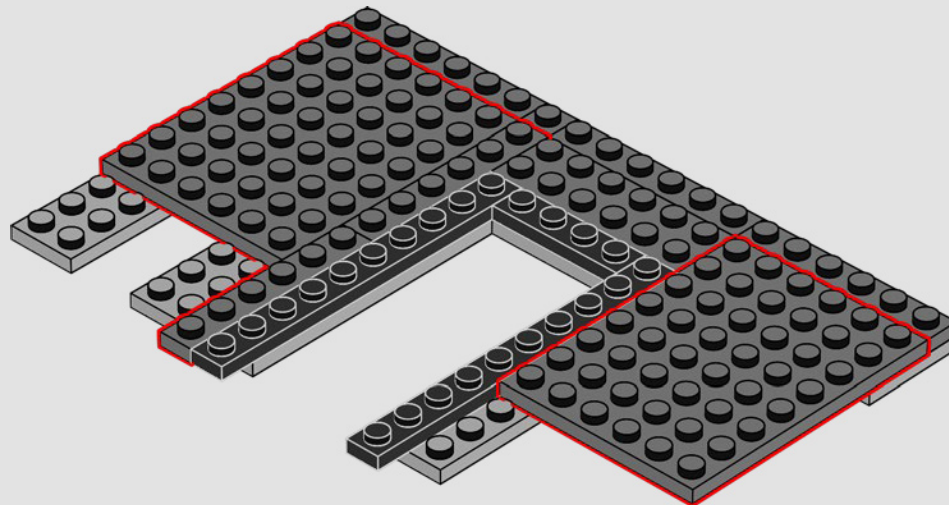

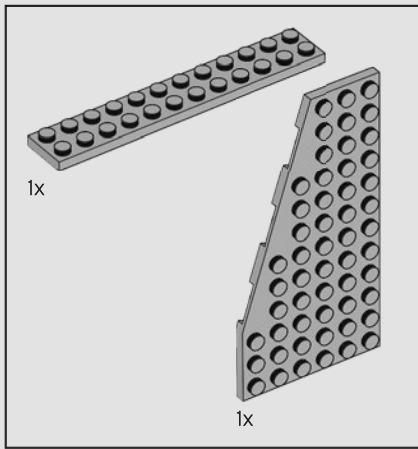

404

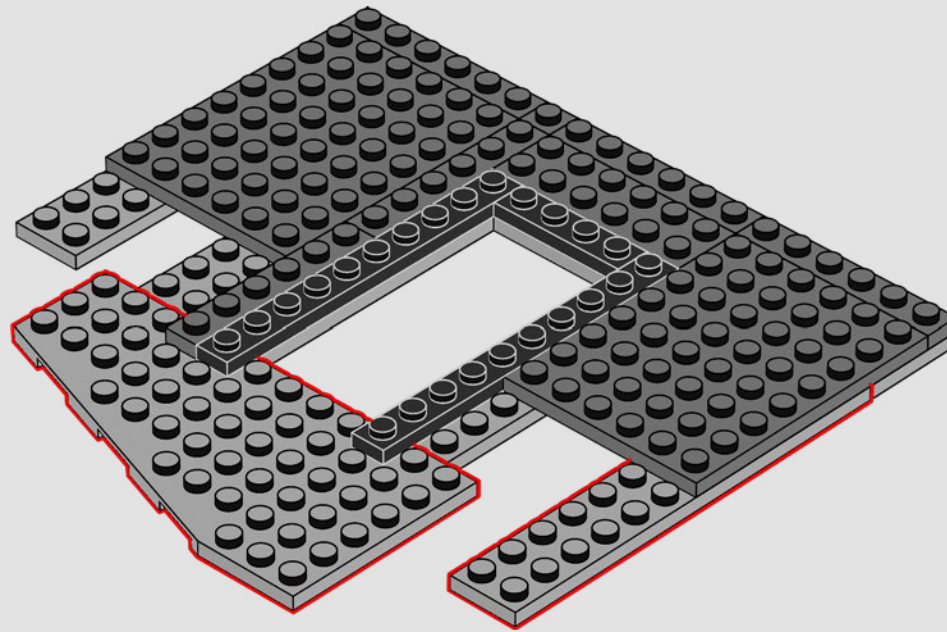

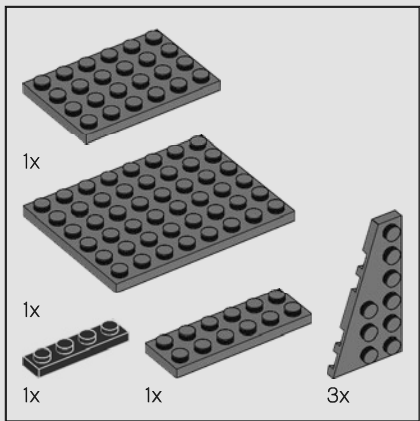

405

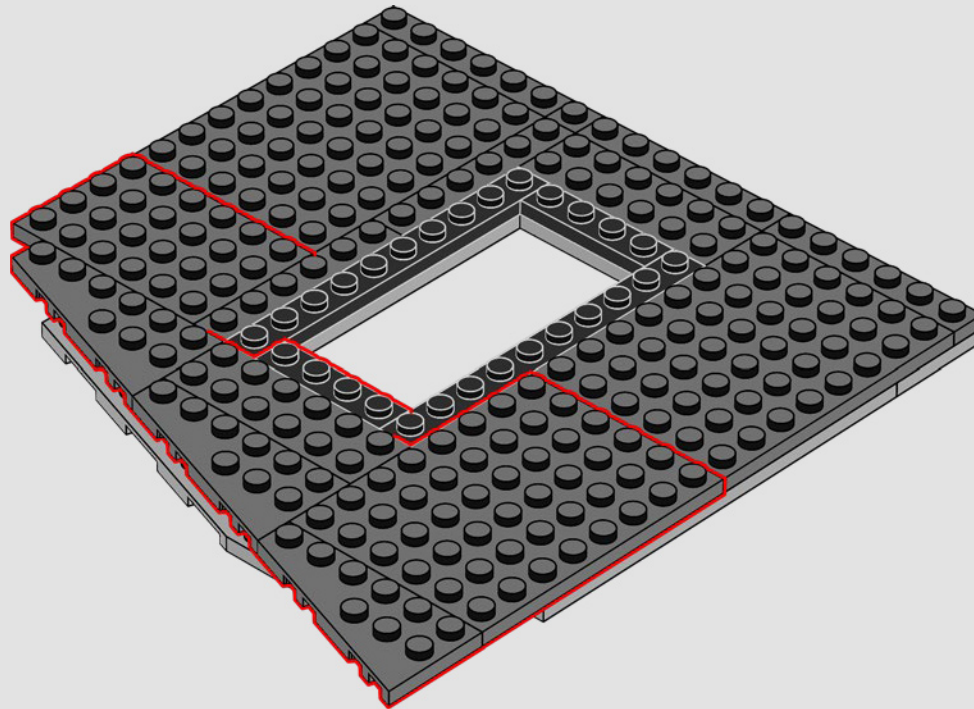

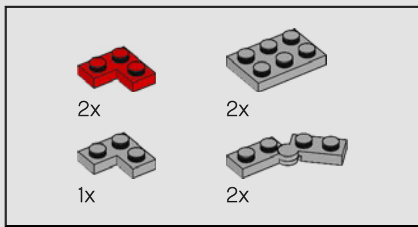

406

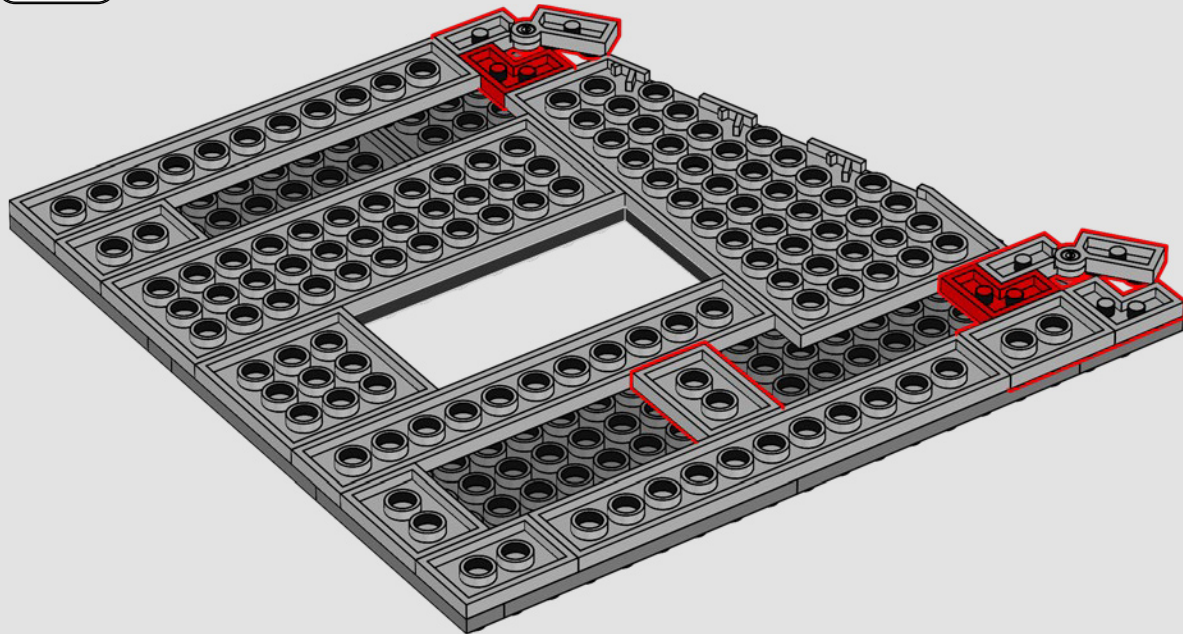



1x

407

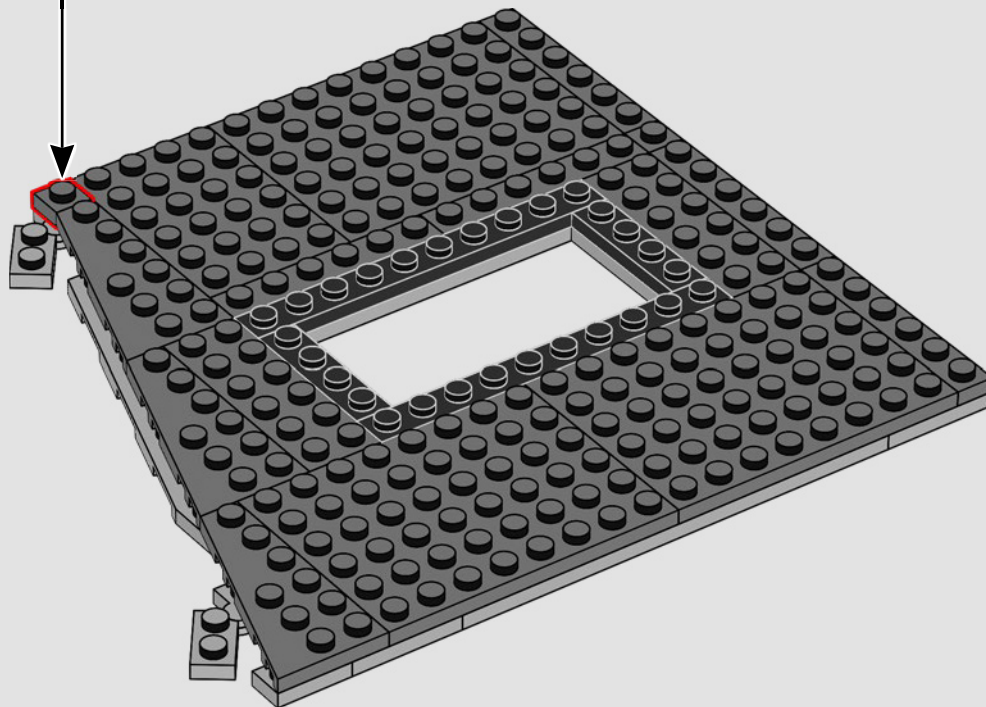
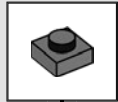



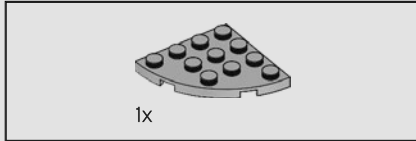
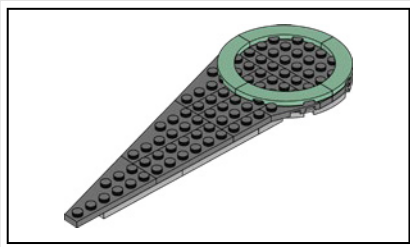

408

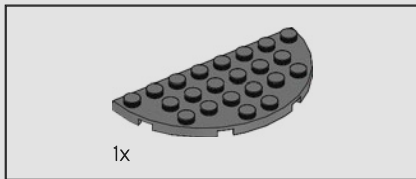
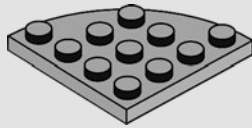

409

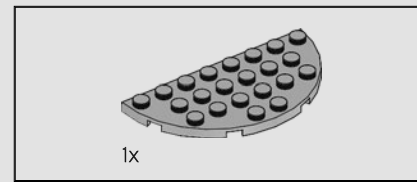
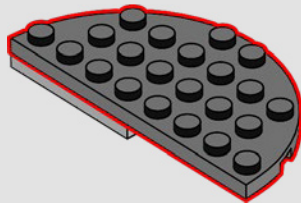

410

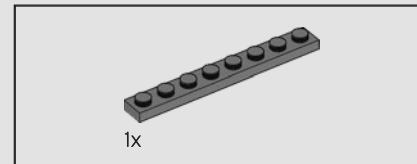
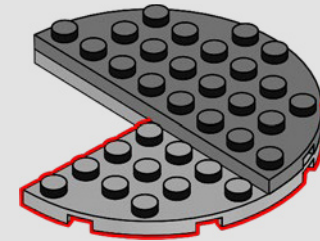

411

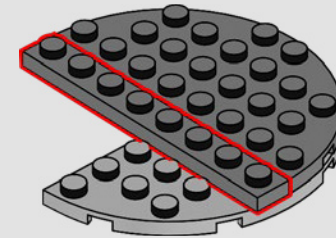

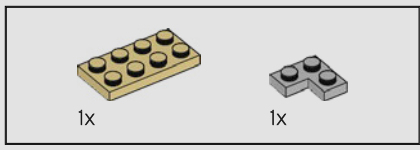

412

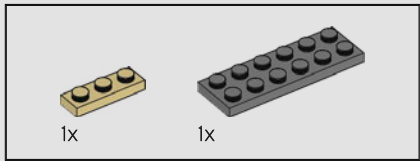
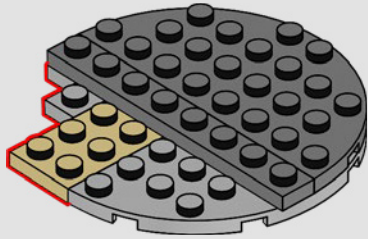

413

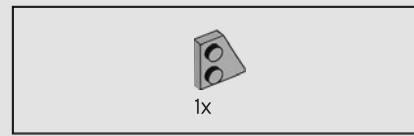
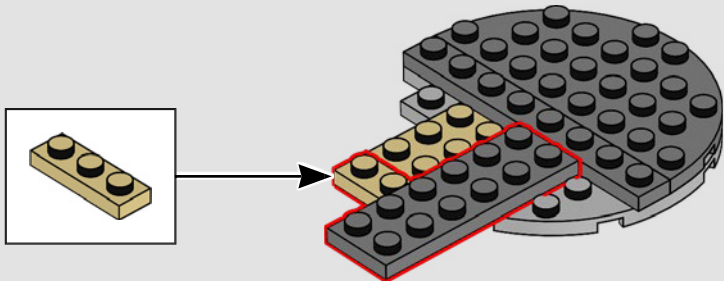

414

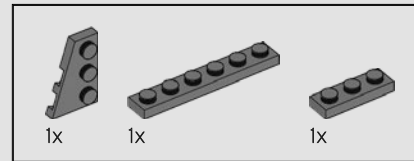
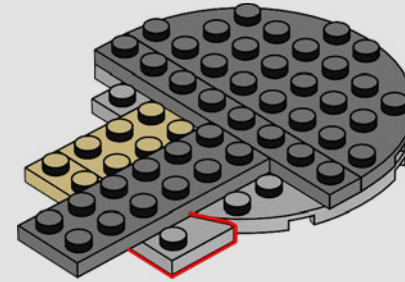

415

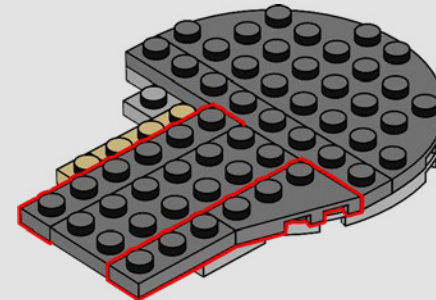

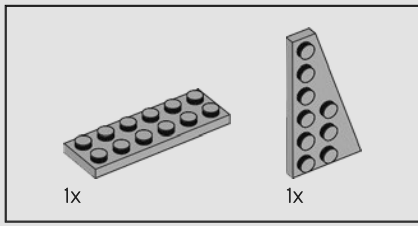

416

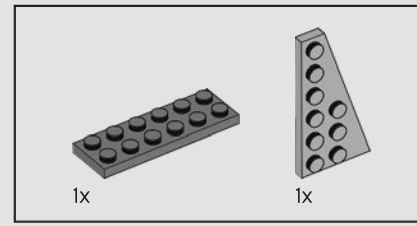
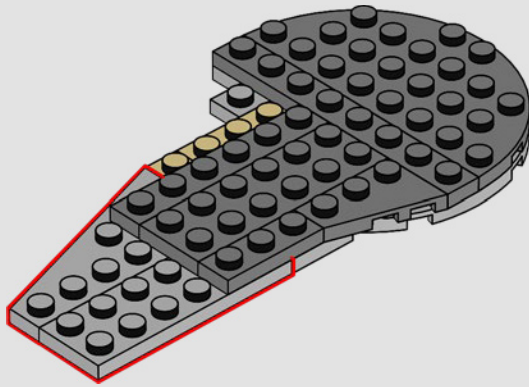

417

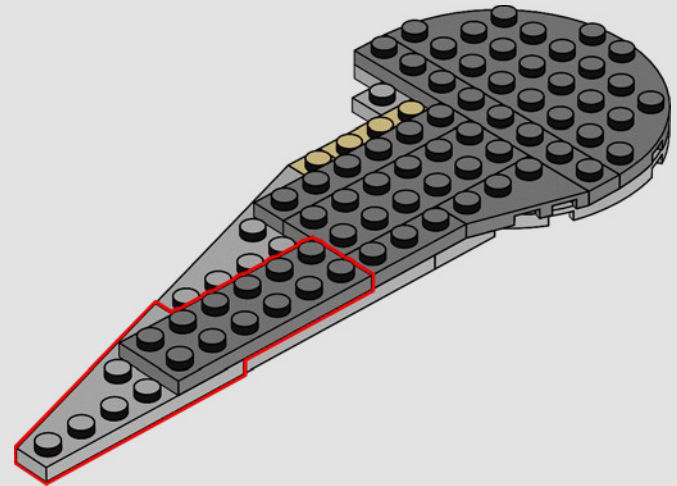

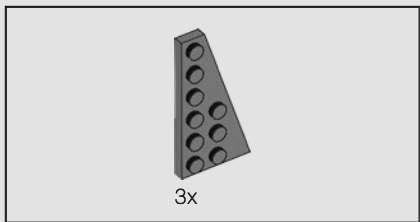

418

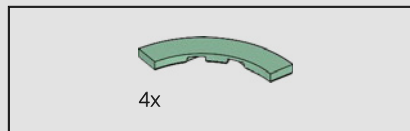
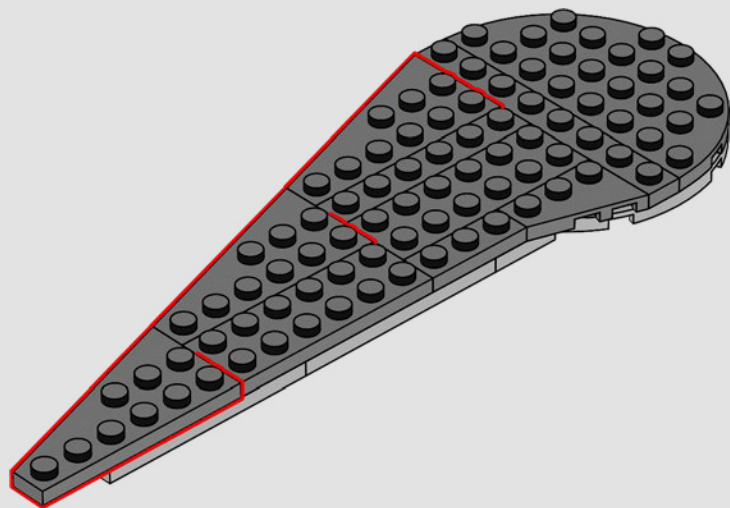

419

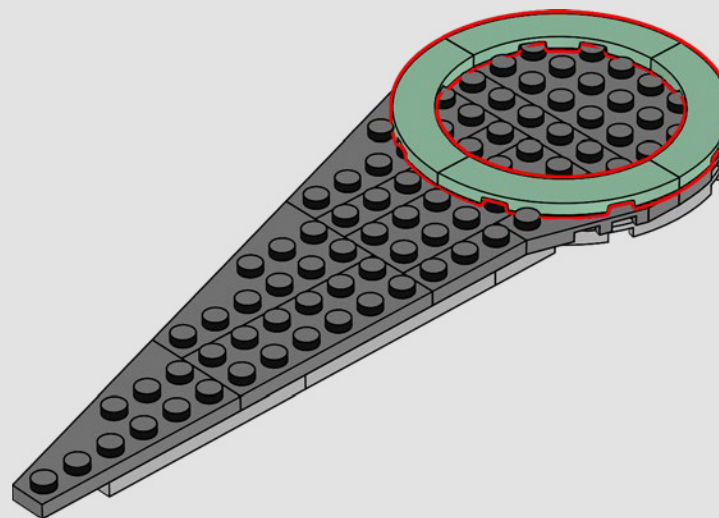

420

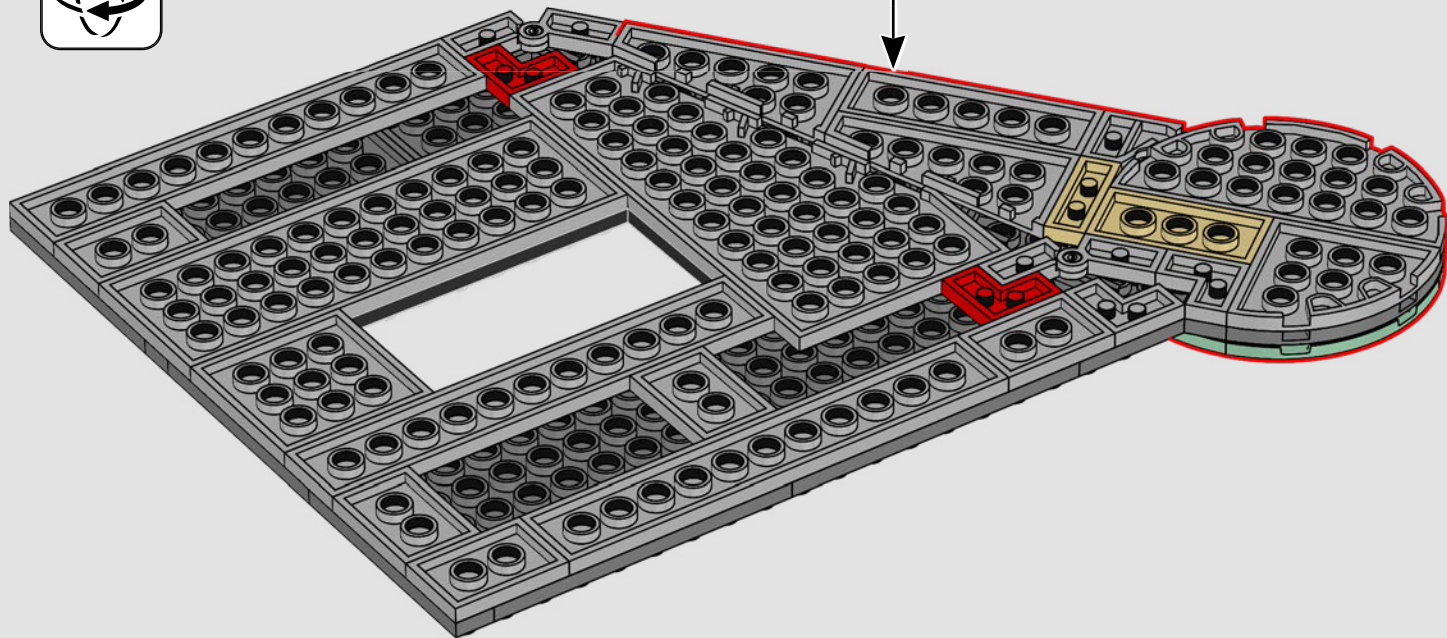



421

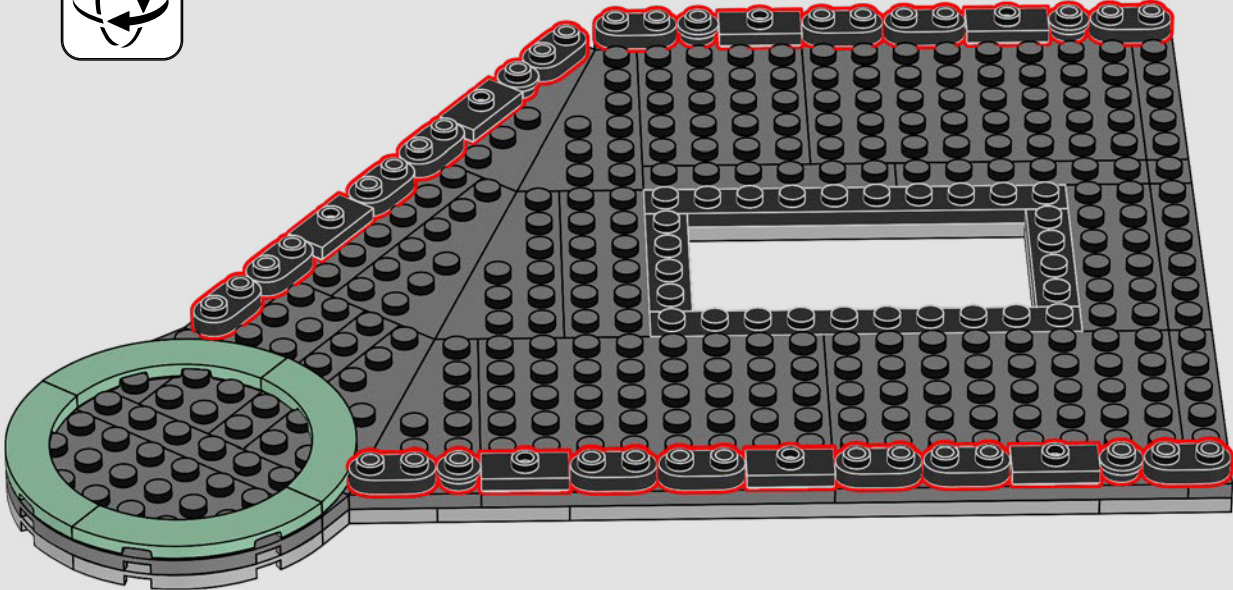

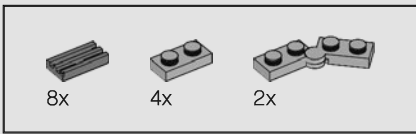

422

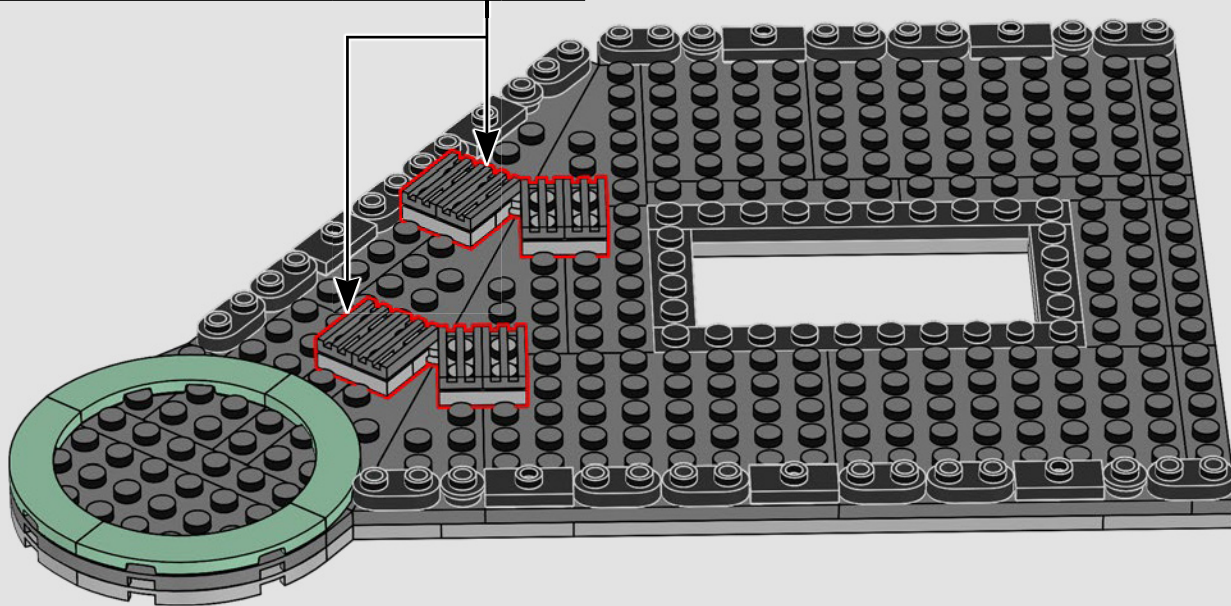
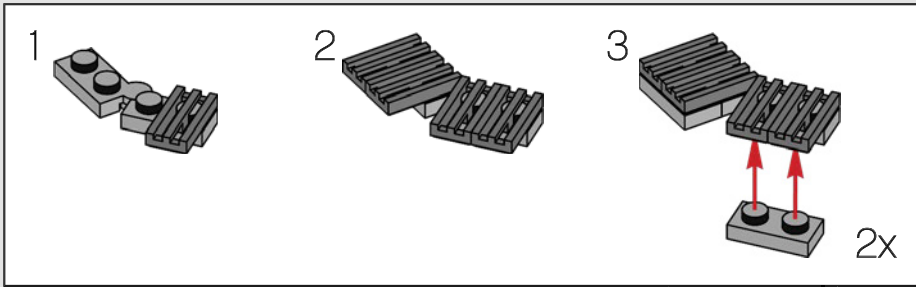



12x

423

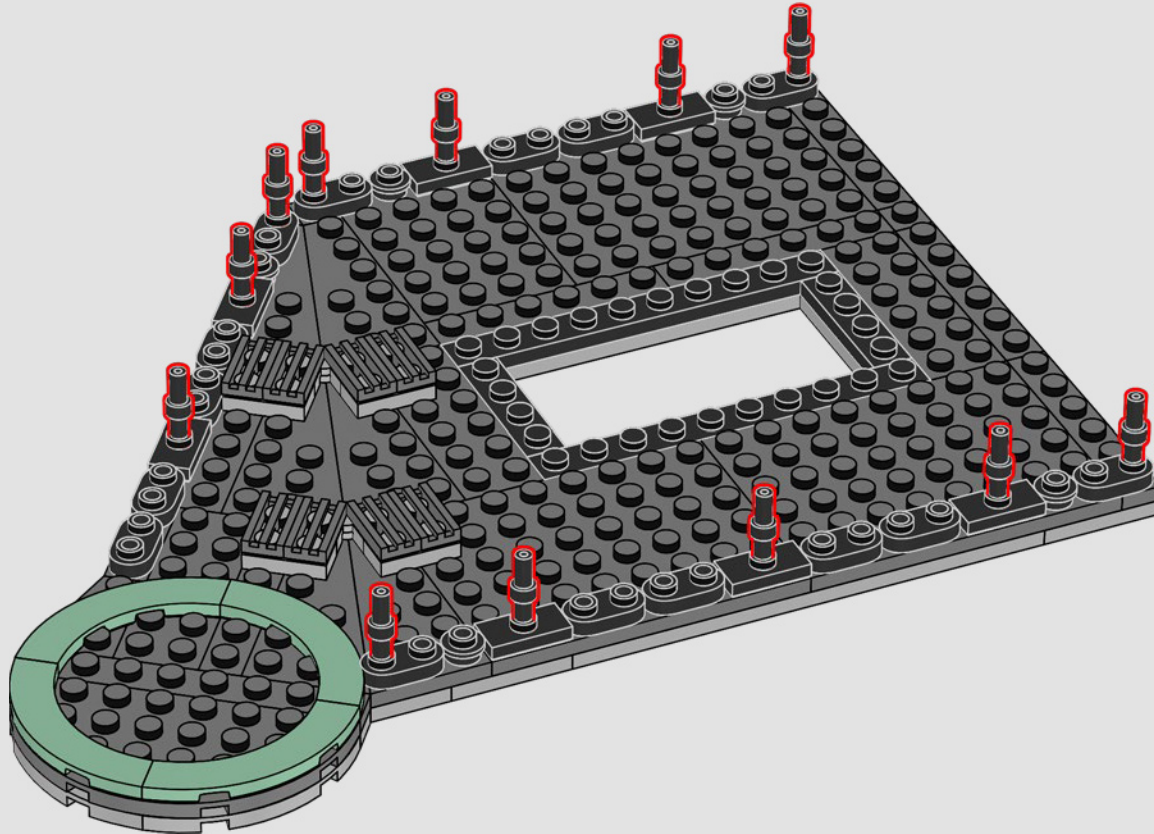





424



Die Elemente, die die geschwungenen schmiedeeisernen Details darstellen, tauchten erstmals als Schlangenkopf in den NINJAGO® Sets auf.

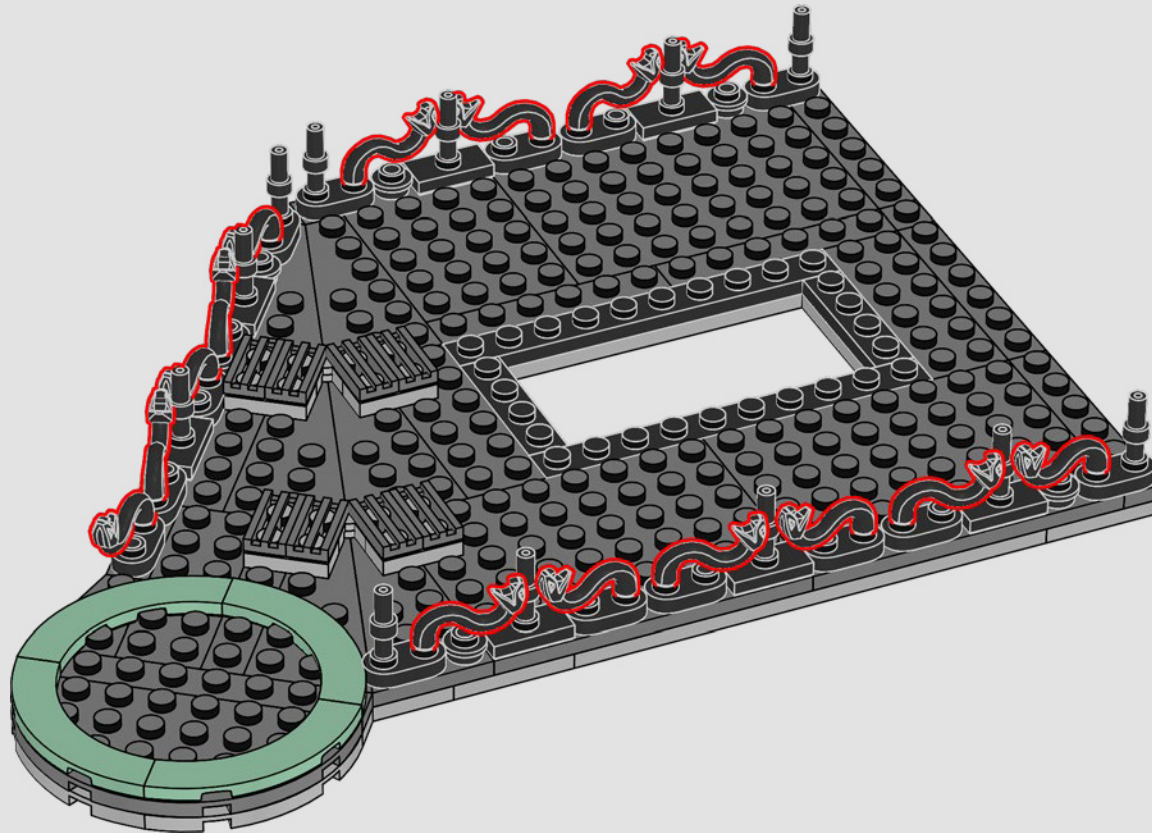

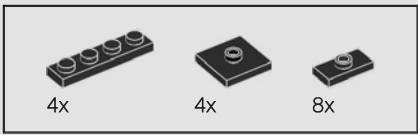

425

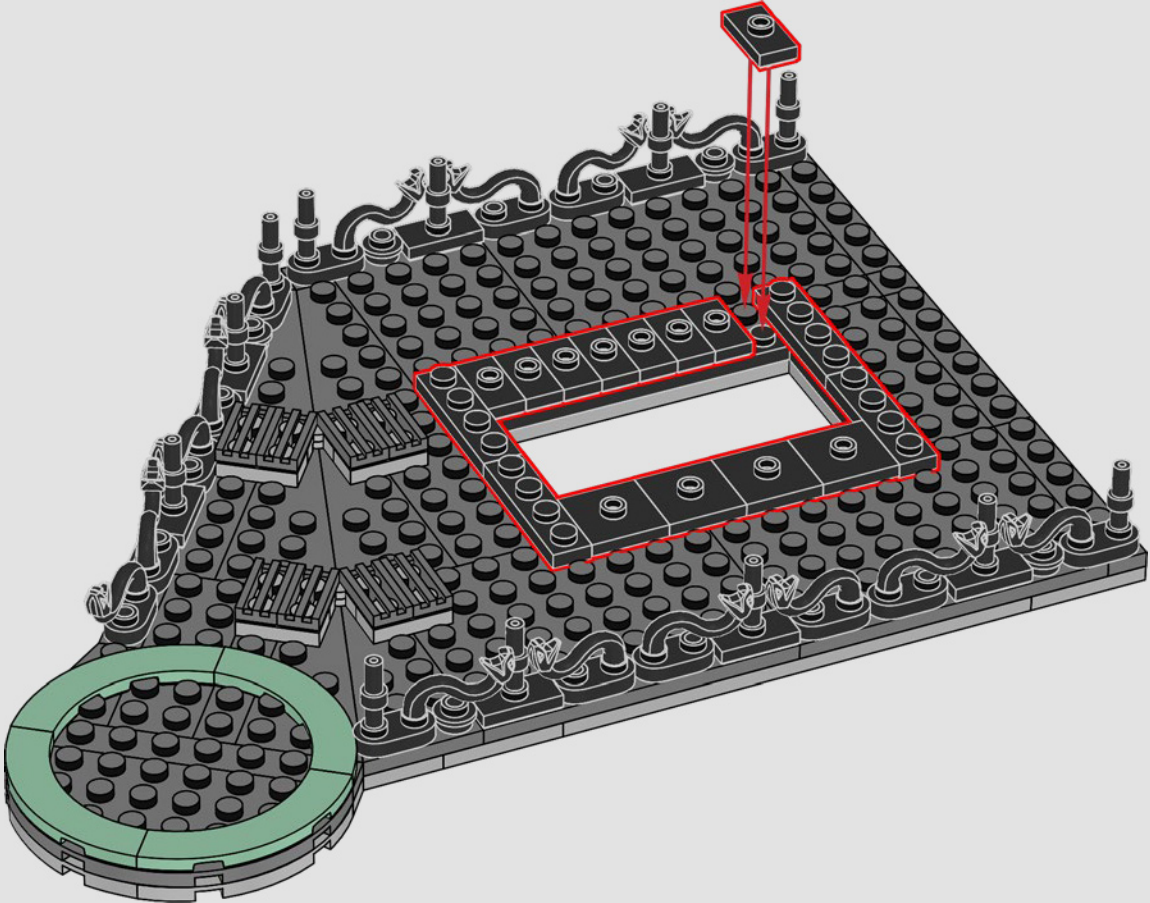

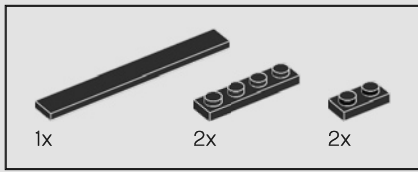

426

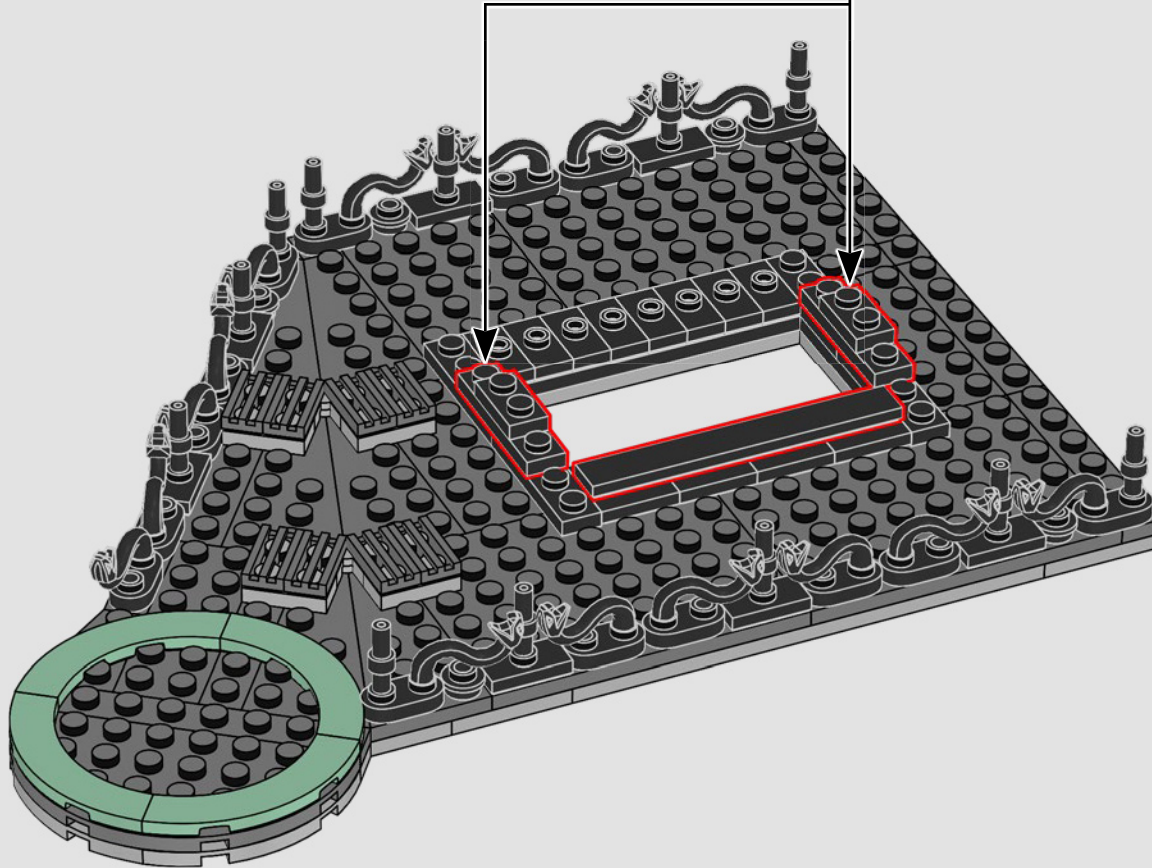
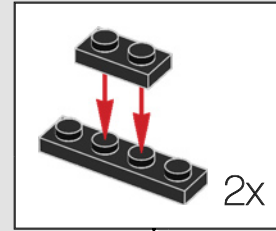



427

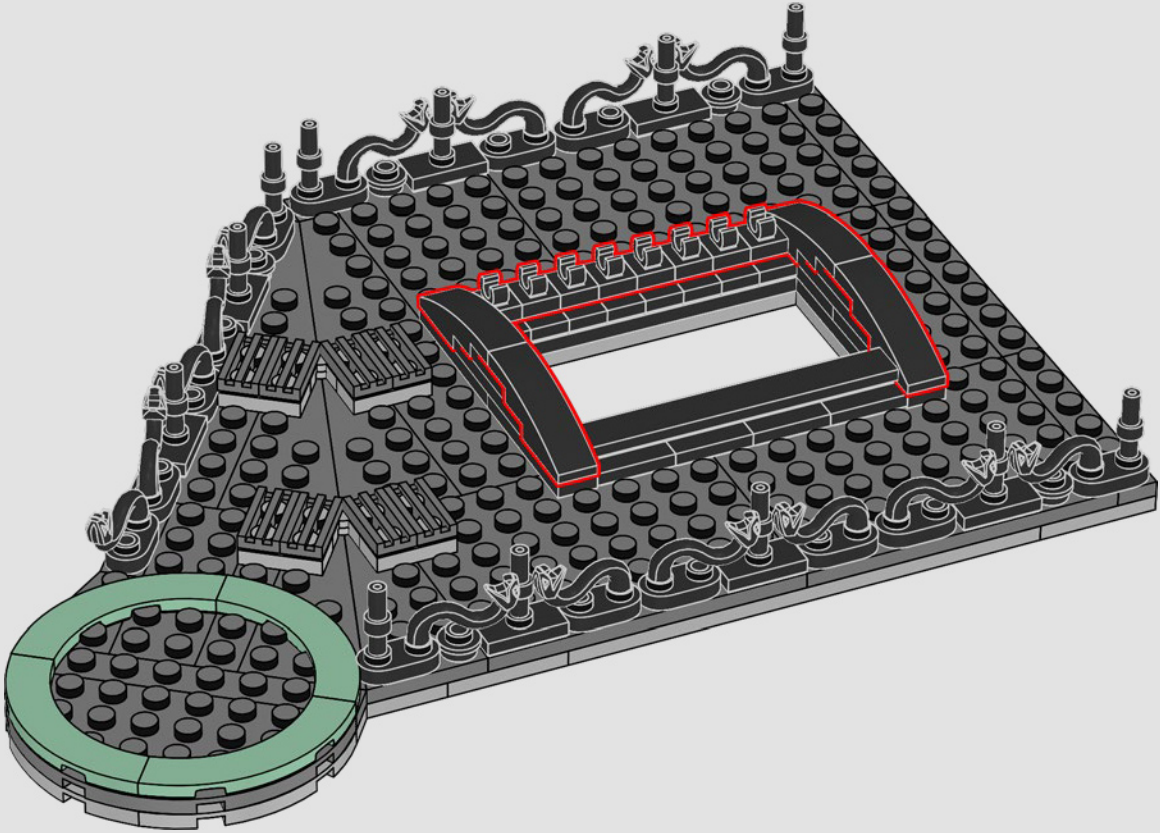

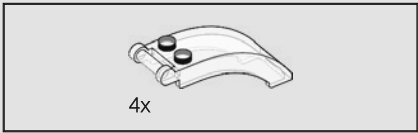

428

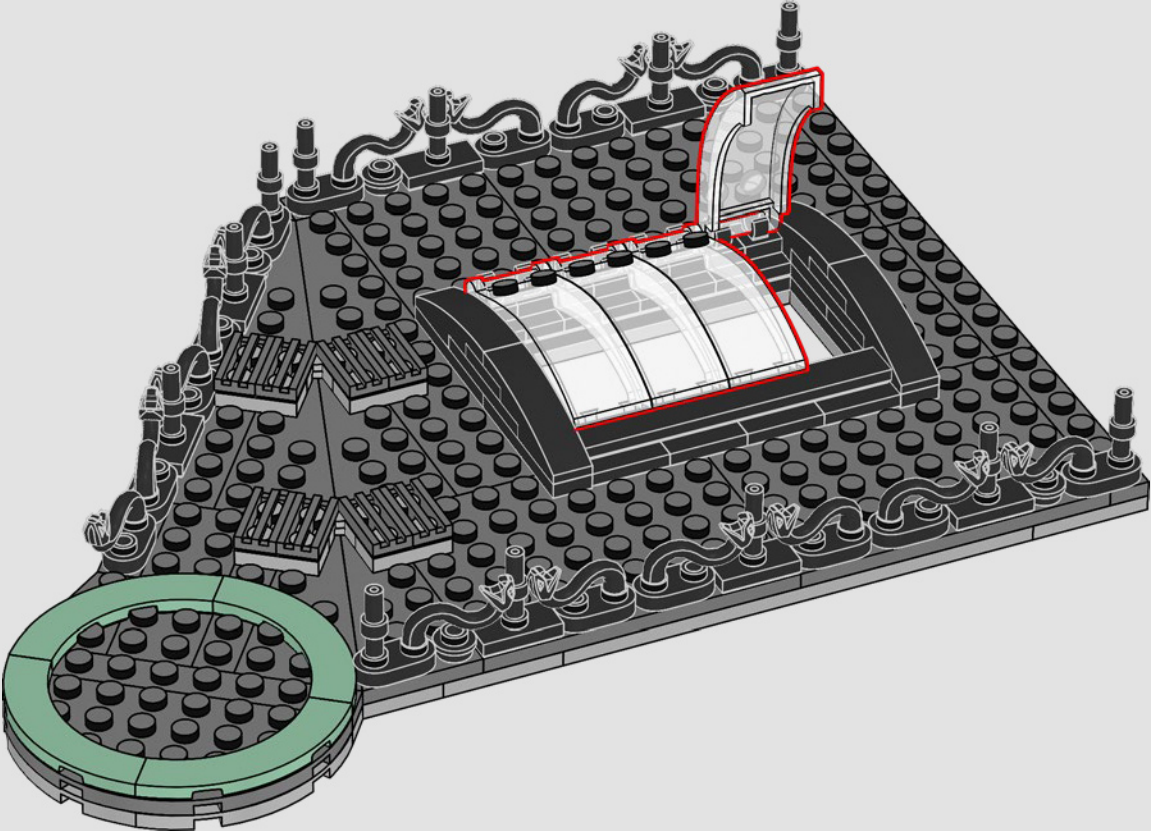

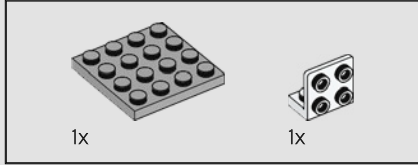
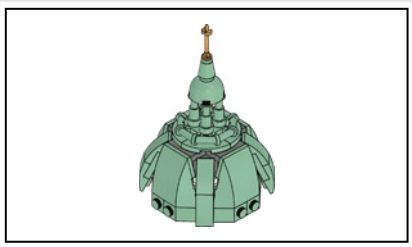

429

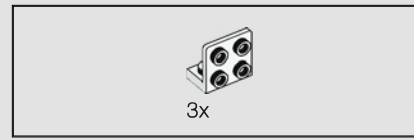
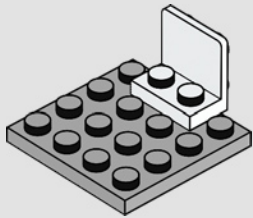

430

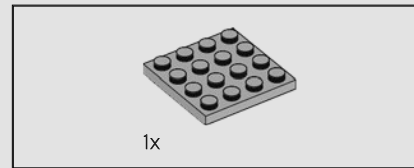
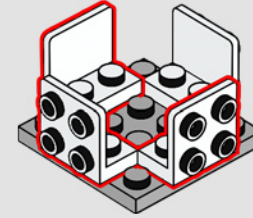

431

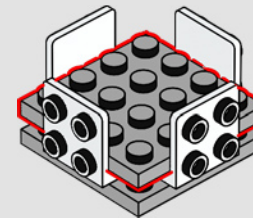

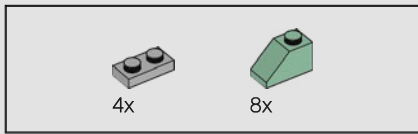

432

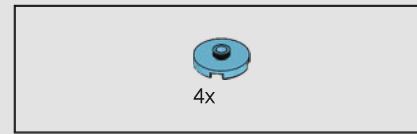
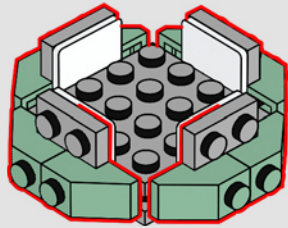

433

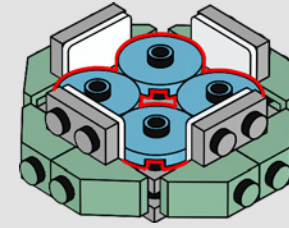

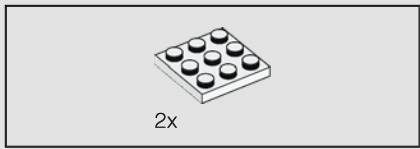

434

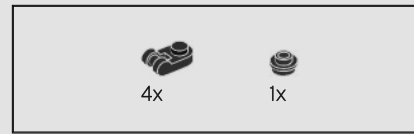
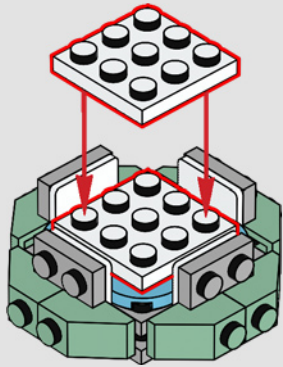

435

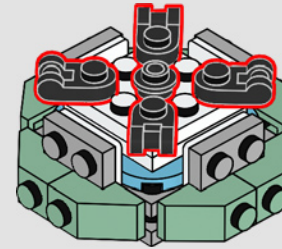



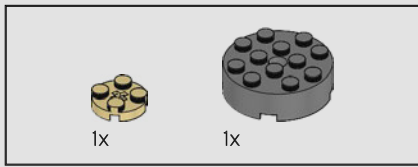

436

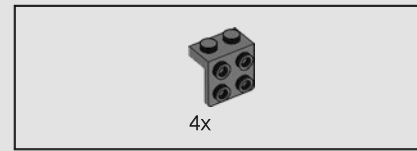
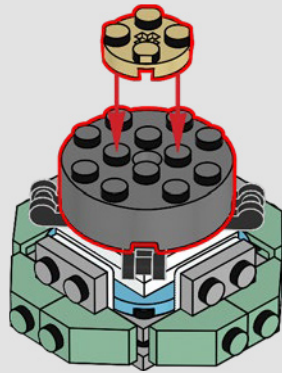

437

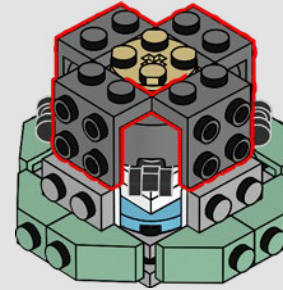

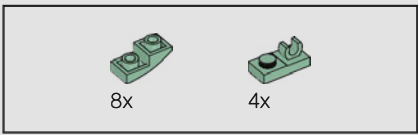

438

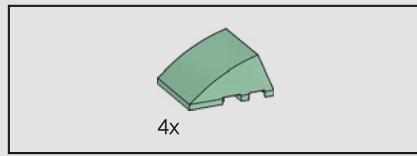
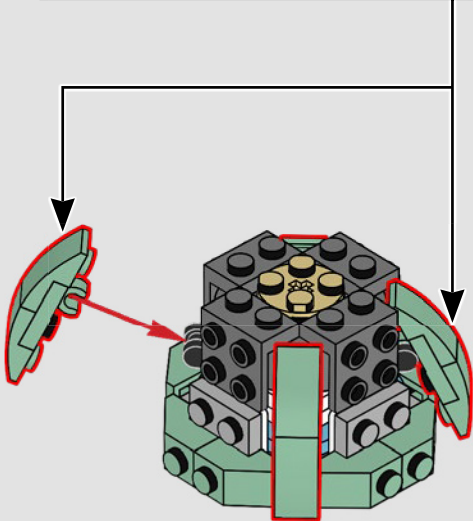
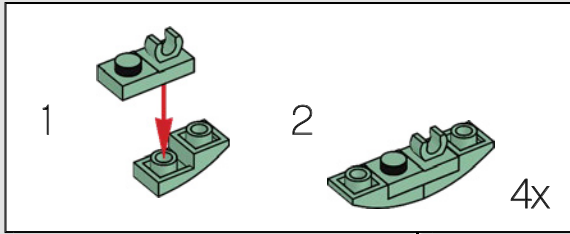

439

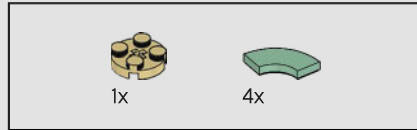
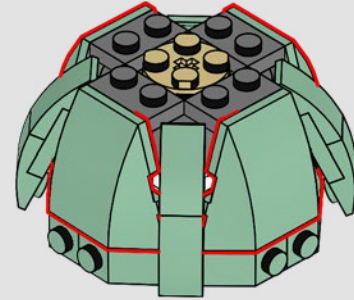

440

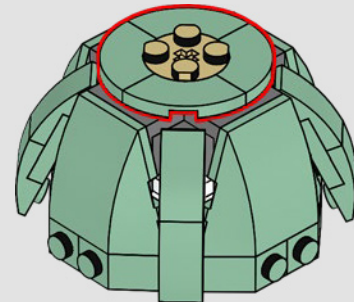

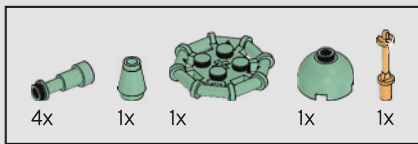

441

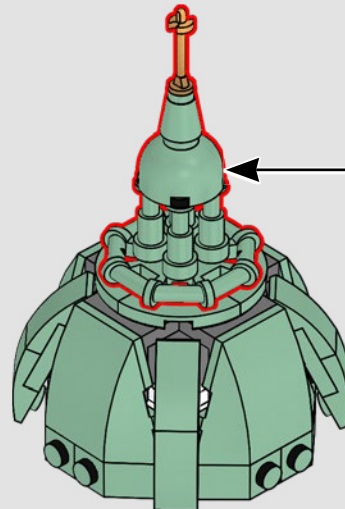
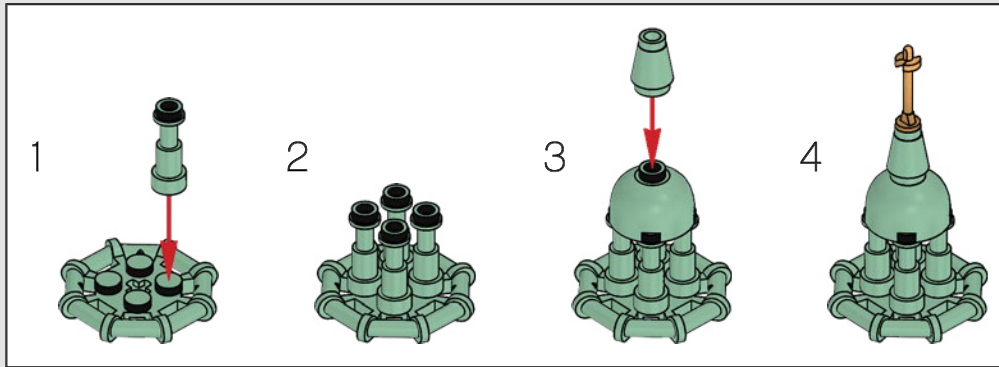

442

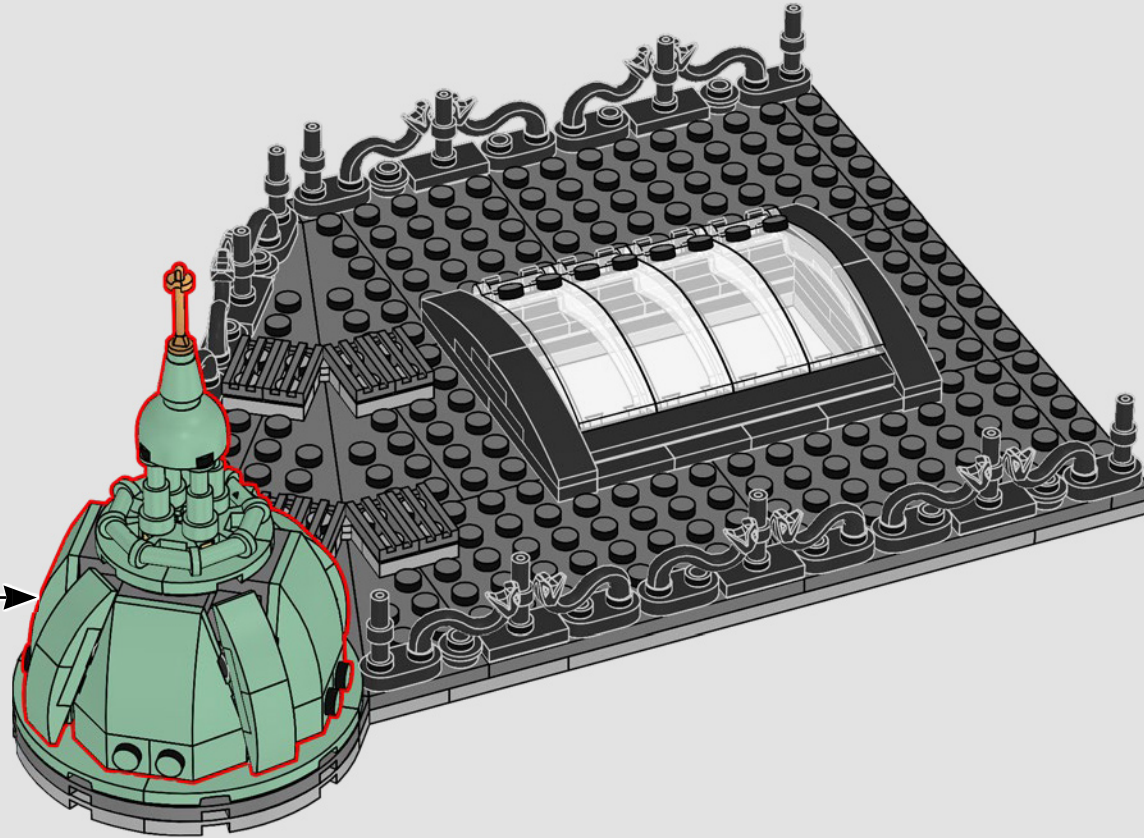

443

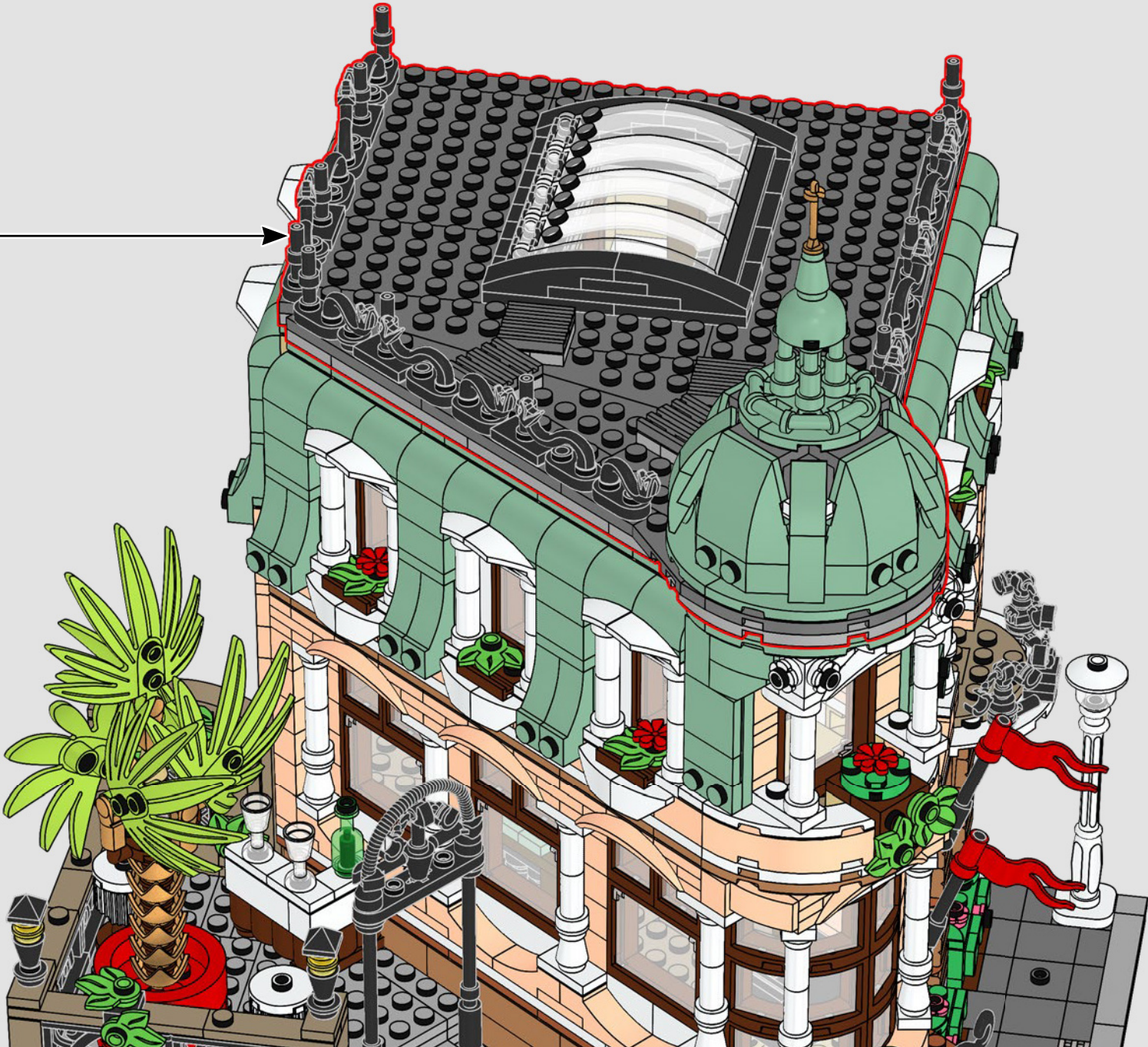

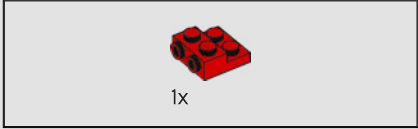
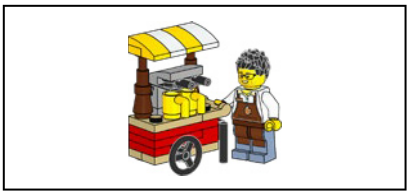

1

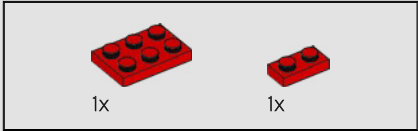
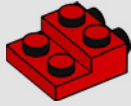

2

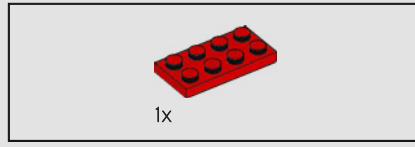
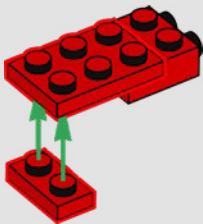

3

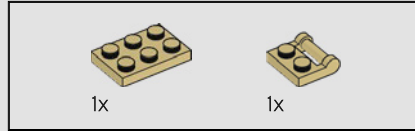
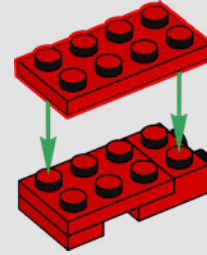

4

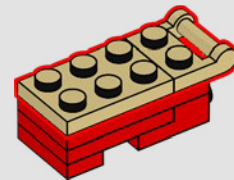



5

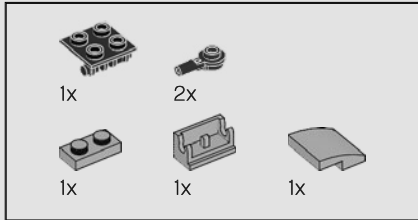
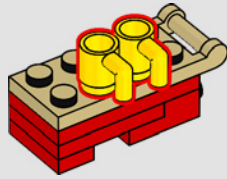

6

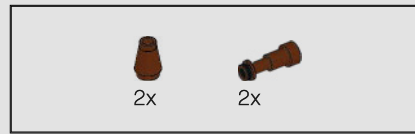
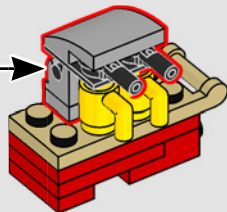
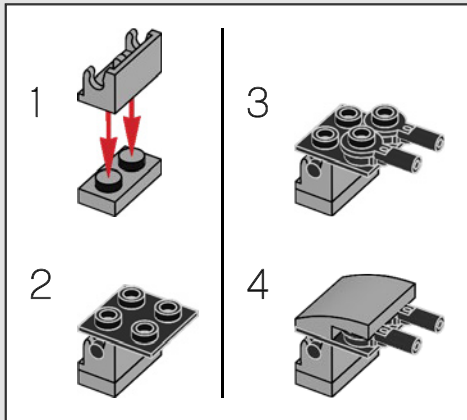

7

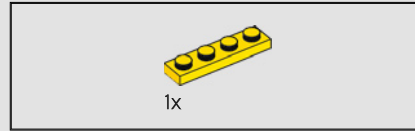
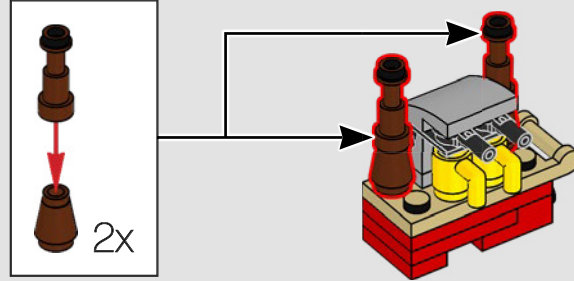

8

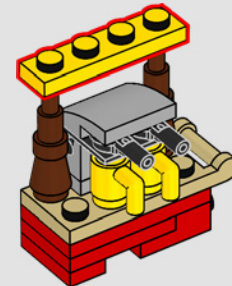

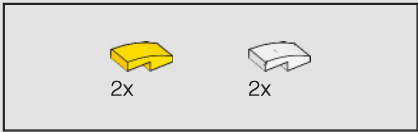

9

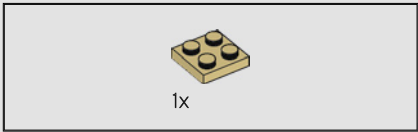
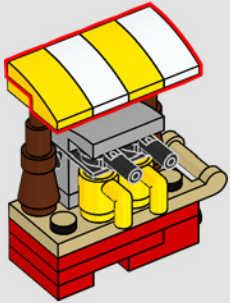

10

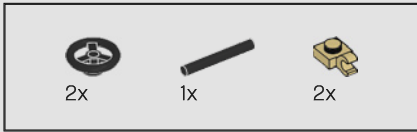
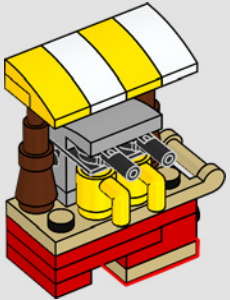

11

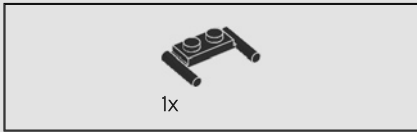
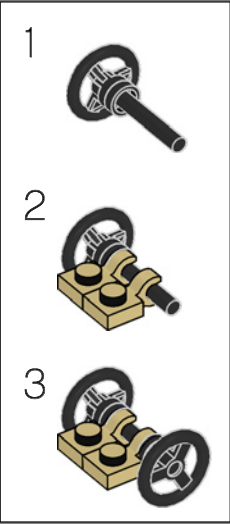
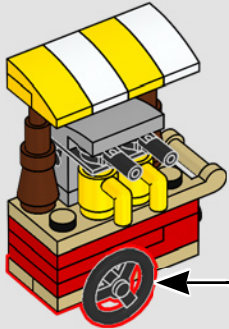

12

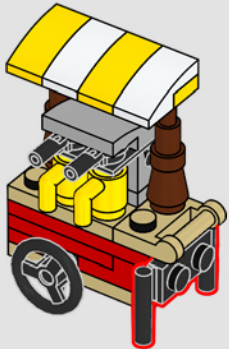

Dieser Kaffeewagen knüpft an das Set „Café Corner“ (10182) an, das allererste Modell aus der Reihe „Bauen mit Modulen“. Die Markise und die gelben Kaffeetassen sind mit den Elementen aus dem Originalset identisch.

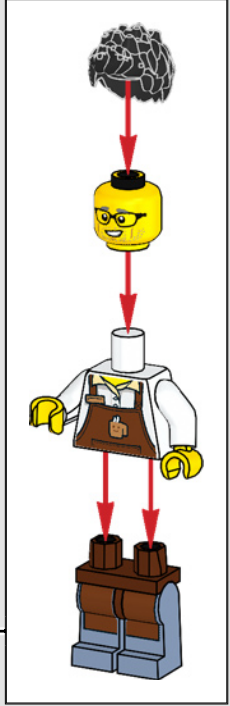







# FEEDBACK AND WIN



## FEEDBACK AND WIN

Your feedback will help shape the future development of this product series.

Please visit:

## FEEDBACK UND GEWINNEN

Dein Feedback trägt zur Weiterentwicklung dieser Produktreihe bei.

Geh auf:

## COMMENTEZ ET GAGNEZ

Vos commentaires nous aideront à concevoir les futurs produits de cette gamme.

Rendez-vous sur :

## COMENTA Y GANA

Tu opinión nos ayudará a dar forma al desarrollo de esta serie de productos en el futuro.

Visita:

## 反馈有奖

您的反馈将有助于我们在今后改进本系列产品。

请访问：

---

[LEGO.com/productfeedback](https://www.lego.com/productfeedback)

---

By completing, you will automatically enter a drawing to win a LEGO® set.

Terms & Conditions apply.

Durch Ausfüllen nimmst du automatisch an der Verlosung eines LEGO® Preises teil.

Es gelten die Teilnahmebedingungen.

En envoyant vos commentaires, vous serez automatiquement inscrit(e) à un tirage au sort qui vous permettra de remporter un prix LEGO®.

Offre soumise à conditions.

Al contestar, participarás automáticamente en el sorteo y podrás ganar un set LEGO®.

Sujeto a Términos y Condiciones.

完成我们的反馈调查，即可自动进入抽奖环节，赢取乐高®套装。

适用《条款和条件》。

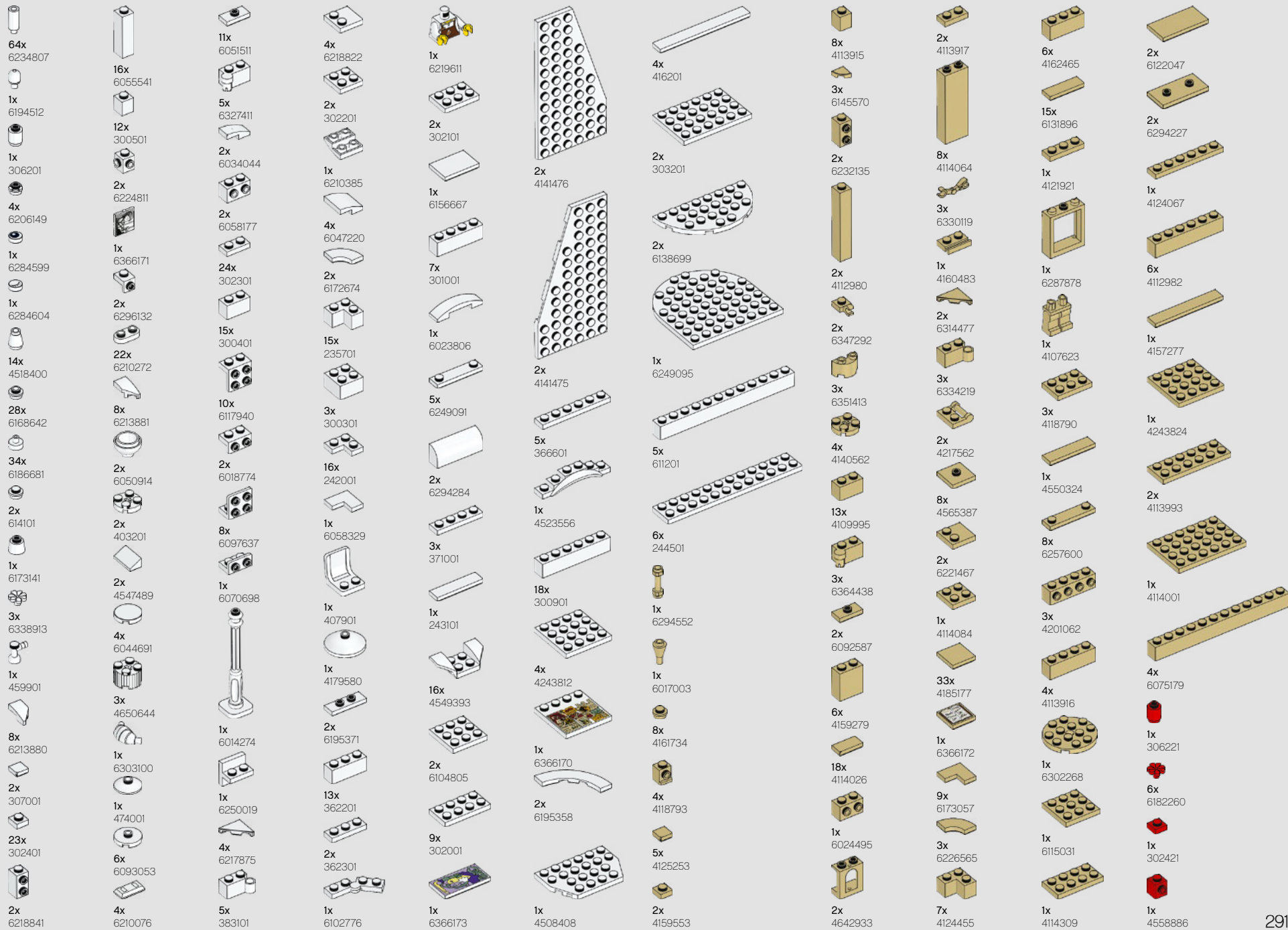

1x 302321	2x 6092582	1x 6218235	2x 6210496	1x 6224071	1x 6323420	1x 6323421	1x 6323421	1x 6092585	5x 4565323	1x 4613153	1x 6327402	1x 6357937	8x 6252258
1x 302221	1x 300423	1x 4651443	9x 6321194	12x 6371584	1x 6323421	1x 6323421	19x 6092585	1x 368026	1x 368026	11x 371026	1x 303426	6x 4616027	26x 6254552
2x 242021	1x 302323	1x 6116616	2x 6240496	1x 6173105	1x 6024730	1x 6138173	1x 6013867	1x 6013867	1x 6013867	4x 6037746	1x 303426	5x 4614158	1x 6278710
4x 4567445	2x 4558606	1x 6103171	1x 4529236	1x 6299338	1x 6024730	1x 6138173	1x 4124096	1x 4124096	1x 4124096	2x 243126	1x 395826	2x 6186009	1x 6278710
1x 6061711	3x 362223	1x 6329613	1x 6259236	4x 6308000	1x 6269081	1x 306926	5x 6052126	2x 6052126	2x 6052126	1x 243126	2x 447726	2x 6186423	2x 6251285
2x 362321	2x 4587840	1x 6288015	3x 6056234	4x 6308000	1x 6102341	2x 6147050	2x 4515368	2x 4515368	2x 4515368	1x 611517	4x 4558593	23x 6253425	2x 6251285
2x 6268946	2x 428623	1x 6211710	19x 6168646	15x 6380639	1x 6092664	3x 6000650	1x 6092664	1x 6092664	1x 6092664	4x 6138726	14x 6150607	2x 6257603	3x 6256058
1x 302121	1x 317623	2x 307024	10x 6186675	1x 6134617	1x 6092664	1x 6250020	1x 6092664	1x 6092664	1x 407926	1x 6138726	1x 403228	2x 6257603	3x 6256058
1x 4515348	4x 6102759	2x 300524	6x 614126	2x 6336977	1x 6070695	1x 6250020	2x 6057397	2x 6057397	2x 6272184	1x 6280168	1x 403228	5x 6074892	3x 6256058
1x 6313597	2x 300223	3x 6195183	3x 6278152	4x 6104209	2x 6057397	1x 6285241	1x 4105175	1x 4105175	1x 6219624	1x 302026	1x 6269971	21x 6074893	4x 6247362
1x 302021	1x 371023	2x 389924	1x 362626	2x 6281993	1x 4105175	16x 6214807	1x 6366174	1x 6366174	1x 6219624	1x 663626	1x 6261358	4x 6058089	4x 6247362
2x 614123	1x 371023	2x 6029947	2x 6312449	2x 6336977	1x 6079896	4x 6252201	2x 6195325	2x 6195325	1x 317626	1x 663626	6x 6129807	4x 6058089	7x 6253734
2x 6344028	1x 371023	1x 242024	4x 6273589	4x 6104209	19x 6210270	1x 6336989	1x 4106552	1x 4106552	2x 6116604	1x 6058118	3x 371028	6x 6253418	4x 6244793
1x 300523	1x 6262960	7x 302426	2x 6312449	1x 6079896	1x 6308032	1x 6151289	2x 249626	2x 249626	1x 6162892	1x 6344427	17x 6182261	2x 6166107	4x 6240216
3x 370023	1x 6366175	10x 6335388	4x 6273589	19x 6210270	4x 6157554	1x 6151289	1x 6093525	1x 6093525	2x 6286835	1x 346026	10x 6143431	1x 6168665	2x 6337597
292		2x 6172383	2x 6312449	4x 6273589	5x 6196548	1x 6151289	1x 6093525	1x 6093525	1x 383926	1x 416226	17x 6369194	1x 6168665	2x 6337597
		5x 6290456	2x 6170421	2x 6273589	1x 6210307	1x 9339	10x 302326	1x 302326	1x 6186698	1x 416226	2x 6248949	6x 6244796	2x 6247364

1x 6047056	12x 6055172	1x 6167936	2x 4530712	1x 6134280	8x 6083976	4x 4539114	1x 6335285	4x 4211222	8x 4565394	5x 4216668
1x 4558595	9x 6273590	5x 6001822	2x 6232137	2x 6223913	4x 4649065	2x 6311890	1x 4621543	14x 6382102	1x 6122977	1x 4211181
4x 6240467	6x 4549436	1x 6310832	8x 4251796	1x 6221730	2x 6133896	4x 6212040	4x 4529242	5x 6103004	1x 4211200	6x 6343651
								9x 6215659	1x 4211221	3x 6343651
1x 6213779	13x 6001824	2x 6175927	2x 6232137	2x 6223225	20x 6186823	2x 6341767	4x 4529242	1x 6139435	4x 4211221	6x 6343651
							9x 6215659	1x 4211242	5x 6221608	3x 4211225
3x 6213777				1x 6221729	1x 6186828	2x 4539090	1x 4211242	1x 4212744	1x 4211257	2x 4658005
				1x 6278544	6x 6299637	2x 6274681	1x 4212288	1x 4212888	2x 4211257	1x 4658005
3x 6223665				1x 6278544	2x 6223171	2x 6274681	1x 4212888	3x 6149677	2x 4211257	1x 4658005
				16x 4616578	20x 6369375	2x 6274681	1x 4212888	1x 6062574	1x 6146301	7x 4211190
3x 6223665				2x 6275088	20x 4616581	2x 6274681	1x 4212888	1x 6062574	1x 6146301	1x 4211190
				1x 6312450	6x 6360075	2x 6274681	1x 4212888	6x 6341553	16x 4211150	1x 6153594
2x 6273853				3x 6055171	28x 6278541	2x 6274681	1x 4212888	1x 4211151	20x 4211151	1x 6153594
				8x 6055222	2x 6223126	2x 6274681	1x 4212888	6x 6341553	11x 6100769	1x 6153594
2x 6273853				4x 4245570	8x 6278553	2x 6274681	1x 4212888	1x 6306775	13x 4211152	7x 4595889
				4x 4245570	5x 4655080	2x 6274681	1x 4212888	1x 6035291	8x 6058084	1x 4595889
2x 6273853				2x 4226869	6x 4245571	2x 6274681	1x 4212888	1x 6035291	2x 6310449	7x 4595889
				8x 6278553	6x 4245571	2x 6274681	1x 4212888	1x 6035291	2x 6310449	1x 4595889
2x 6249417				2x 4226869	6x 4245571	2x 6274681	1x 4212888	1x 6035291	2x 6310449	1x 4595889
				8x 6278553	6x 4245571	2x 6274681	1x 4212888	1x 6035291	2x 6310449	1x 4595889
1x 6223065				2x 4226869	6x 4245571	2x 6274681	1x 4212888	1x 6035291	2x 6310449	1x 4595889
				8x 6278553	6x 4245571	2x 6274681	1x 4212888	1x 6035291	2x 6310449	1x 4595889
2x 6337637				2x 4226869	6x 4245571	2x 6274681	1x 4212888	1x 6035291	2x 6310449	1x 4595889
				8x 6278553	6x 4245571	2x 6274681	1x 4212888	1x 6035291	2x 6310449	1x 4595889
1x 4537251				2x 4226869	6x 4245571	2x 6274681	1x 4212888	1x 6035291	2x 6310449	1x 4595889
				8x 6278553	6x 4245571	2x 6274681	1x 4212888	1x 6035291	2x 6310449	1x 4595889
1x 6192789				2x 4226869	6x 4245571	2x 6274681	1x 4212888	1x 6035291	2x 6310449	1x 4595889
				8x 6278553	6x 4245571	2x 6274681	1x 4212888	1x 6035291	2x 6310449	1x 4595889
1x 6226630				2x 4226869	6x 4245571	2x 6274681	1x 4212888	1x 6035291	2x 6310449	1x 4595889
				8x 6278553	6x 4245571	2x 6274681	1x 4212888	1x 6035291	2x 6310449	1x 4595889
1x 6226630				2x 4226869	6x 4245571	2x 6274681	1x 4212888	1x 6035291	2x 6310449	1x 4595889
				8x 6278553	6x 4245571	2x 6274681	1x 4212888	1x 6035291	2x 6310449	1x 4595889
5x 6313098				2x 4226869	6x 4245571	2x 6274681	1x 4212888	1x 6035291	2x 6310449	1x 4595889
				8x 6278553	6x 4245571	2x 6274681	1x 4212888	1x 6035291	2x 6310449	1x 4595889
1x 6366169				2x 4226869	6x 4245571	2x 6274681	1x 4212888	1x 6035291	2x 6310449	1x 4595889

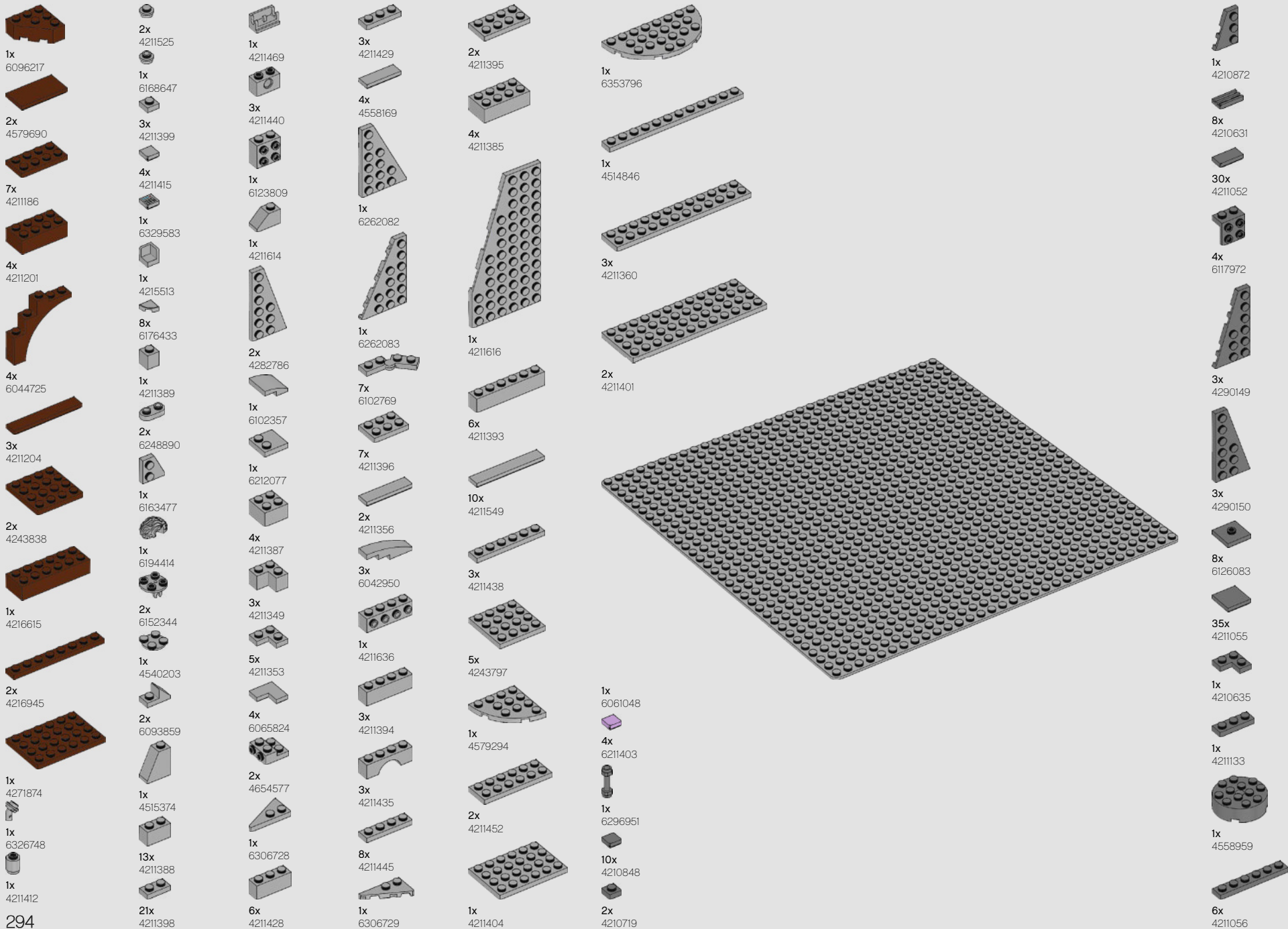

- 1x 6096217
- 2x 4579690
- 7x 4211186
- 4x 4211201
- 4x 6044725
- 3x 4211204
- 2x 4243838
- 1x 4216615
- 2x 4216945
- 1x 4271874
- 1x 6326748
- 1x 4211412

- 2x 4211525
- 1x 6168647
- 3x 4211399
- 4x 4211415
- 1x 6329583
- 1x 4215513
- 8x 6176433
- 1x 4211389
- 2x 6248890
- 1x 6163477
- 1x 6194414
- 2x 6152344
- 1x 4540203
- 2x 6093859
- 1x 4515374
- 13x 4211388
- 21x 4211398

- 1x 4211469
- 3x 4211440
- 1x 6123809
- 1x 4211614
- 2x 4282786
- 1x 6102357
- 1x 6212077
- 4x 4211387
- 3x 4211349
- 5x 4211353
- 4x 6065824
- 2x 4654577
- 1x 6306728
- 6x 4211428

- 3x 4211429
- 4x 4558169
- 1x 6262082
- 1x 6262083
- 7x 6102769
- 7x 4211396
- 2x 4211356
- 3x 6042950
- 1x 4211636
- 3x 4211394
- 3x 4211435
- 8x 4211445
- 1x 6306729

- 2x 4211395
- 4x 4211385
- 1x 4211616
- 6x 4211393
- 10x 4211549
- 3x 4211438
- 5x 4243797
- 1x 4579294
- 2x 4211452
- 1x 4211404

- 1x 6353796
- 1x 4514846
- 3x 4211360
- 2x 4211401
- 1x 6061048
- 4x 6211403
- 1x 6296951
- 10x 4210848
- 2x 4210719

- 1x 4210872
- 8x 4210631
- 30x 4211052
- 4x 6117972
- 3x 4290149
- 3x 4290150
- 8x 6126083
- 35x 4211055
- 1x 4210635
- 1x 4211133
- 1x 4558959
- 6x 4211056

4x 4211002  
 1x 4210998  
 1x 4211115  
 1x 6141856  
 3x 4210794  
 1x 6107399  
 1x 6092833  
 1x 4586410  
 38x 6369191  
 31x 6357797  
 1x 6275872  
 57x 6369188  
 43x 6369189

2x 6357796  
 2x 6343511  
 14x 6325881  
 1x 6297283  
 5x 6357794  
 14x 6369190  
 35x 6378419  
 9x 6369187  
 4x 6369192  
 1x 6170470  
 1x 6292254  
 4x 6252838  
 6x 6296657  
 5x 6209691

4x 4529247  
 1x 6190252  
 5x 6186672  
 5x 4523159  
 1x 6284379  
 6x 6257048  
 2x 6167585  
 2x 4490599  
 1x 6245261  
 1x 6092594  
 2x 6022033  
 5x 6093529  
 3x 6147169  
 4x 6226437  
 6x 6251021  
 5x 4519970

6x 4566688  
 2x 6046943  
 4x 6058221  
 17x 6058257  
 1x 4538950  
 1x 6179803  
 2x 6047037  
 4x 6272145  
 1x 6167928  
 2x 6313874  
 3x 6252667  
 2x 6328181  
 4x 6226792  
 1x 6295366  
 4x 4518687

5x 6300103  
 4x 6167641  
 26x 6057986  
 1x 6167690  
 7x 6215606  
 3x 6177146  
 7x 6314190  
 41x 4656783  
 6x 6021997  
 4x 6186400  
 2x 4568955

17x 6223183  
 6x 6102998  
 8x 6218359  
 47x 6099341  
 1x 6295464  
 4x 6106193  
 2x 6387478  
 1x 6345302  
 3x 6102990  
 4x 6102994  
 1x 6177535  
 6x 6192922

4x 4633691  
 4x 4619636  
 1x 4611884  
 3x 4655243  
 4x 6136419  
 4x 6331949

4x 6119126  
 1x 4624705  
 1x 6253666  
 2x 6361352  
 8x 6251591  
 6x 6295242  
 1x 6240515

Customer Service  
 Kundenservice  
 Service Consommateurs  
 Servicio Al Consumidor  
 LEGO.com/service or dial  
 : 00800 5346 5555  
 : 1-800-422-5346

