



Booklet available in English on  
Heft in deutscher Sprache erhältlich auf  
Livret disponible en français sur  
Libretto disponibile in italiano su  
Folleto disponible en español en  
如需中文版手册, 请访问





# WELCOME

What started as a nights and weekends passion project for our designers in 2007 has now grown into a vibrant downtown filled with beautiful architecture, rich interiors, clever brick usage and an impressive population of happy minifigures. And what better way to celebrate 15 years of Modular Building than by creating one of the models most-often requested by fans.

Welcome to the beautiful, historic **Boutique Hotel!** Inspired by turn-of-the-century European architecture, the unique wedge-shaped structure showcases a myriad of elegant forms and delicate details. It's also packed with small stories and subtle references to earlier models in the Modular Building range. See how many you can spot!





*From left to right:*

Michael Psiaki  
Astrid Graabæk  
Wesley Alan Talbott  
Torben Kidde Skov  
Anderson Ward Grubb  
Chris McVeigh  
Jamie Berard

It's been an exciting 15 years of Modular Building! Here are all the models and many of the designers who made it happen.



Anderson Ward Grubb  
Designer of the 10297 Boutique Hotel



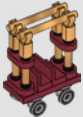
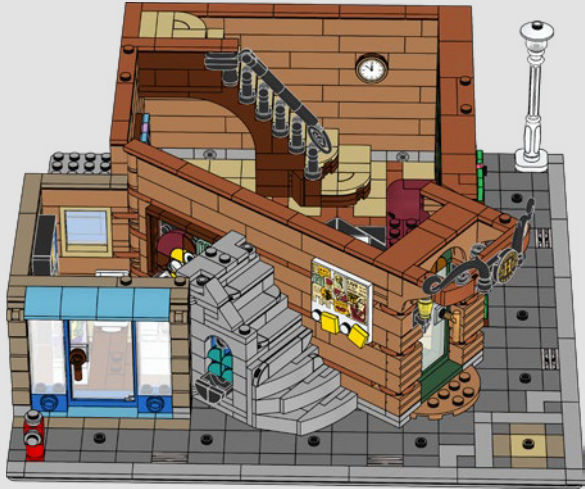
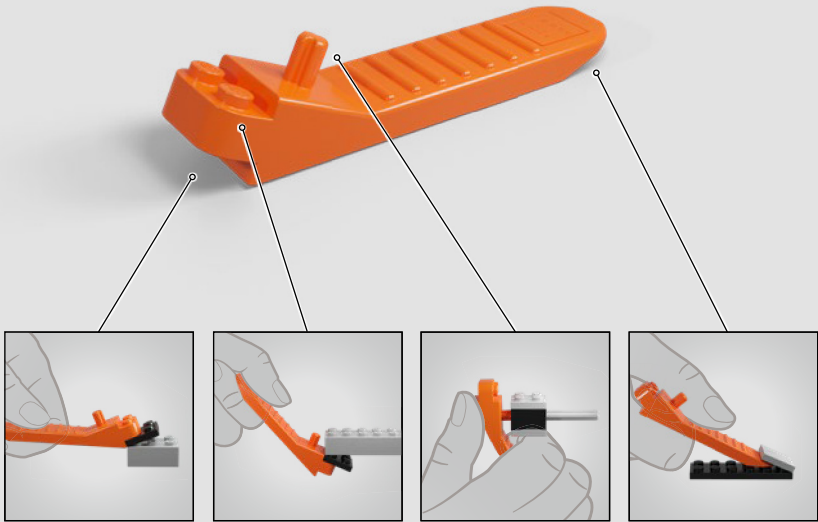
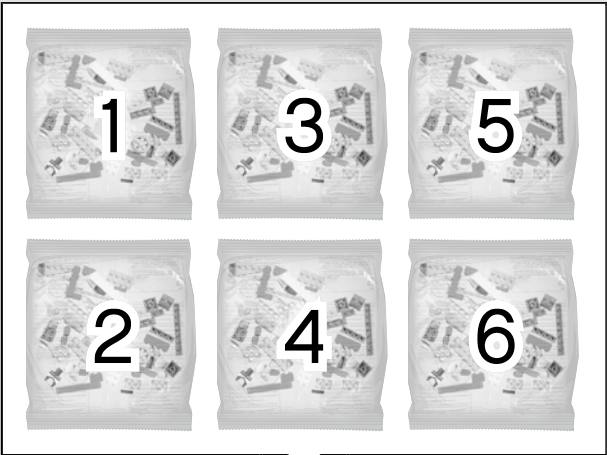

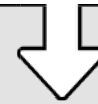
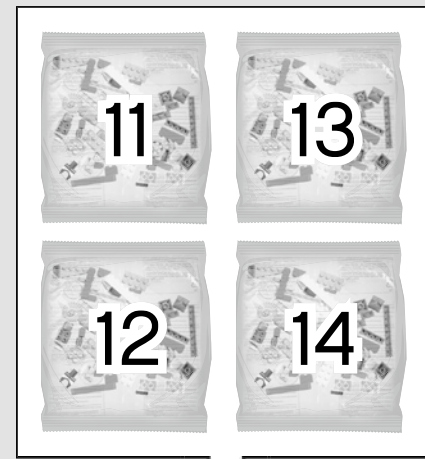
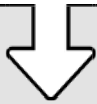
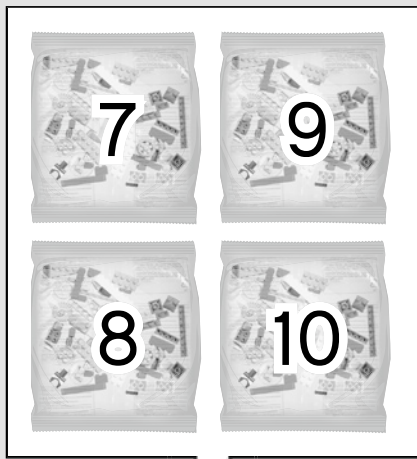

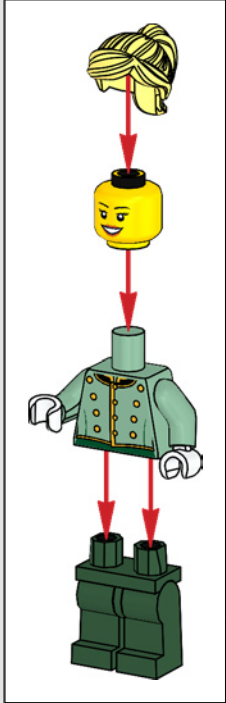
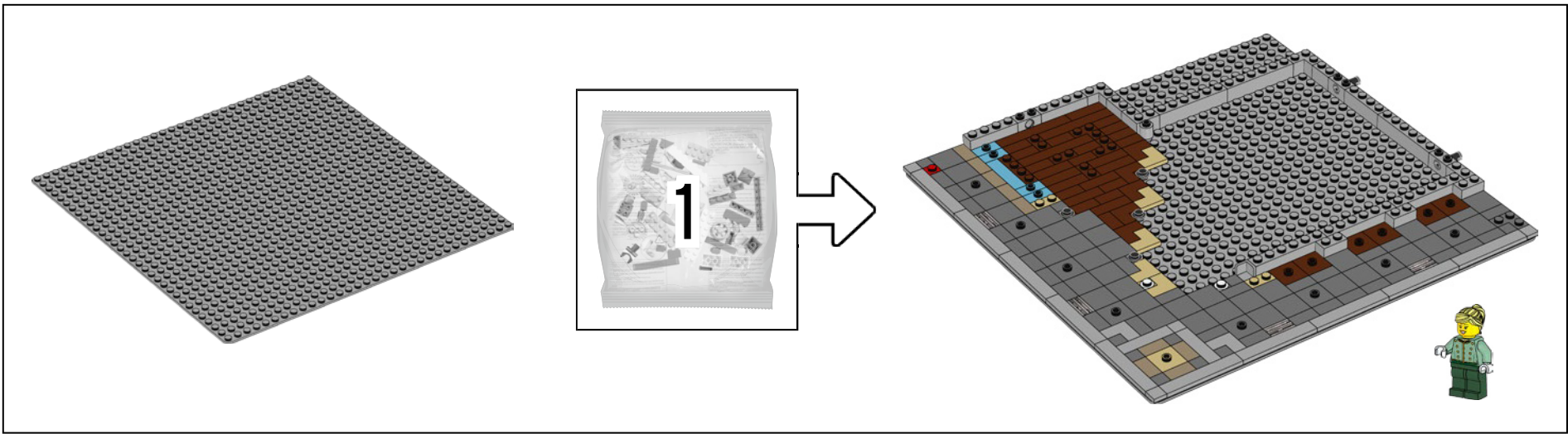

Looking for things to do during your stay?  
Just ask the Receptionist about her favourite  
shop within the 10211 Grand Emporium set,  
or the best meal at Chez Albert.

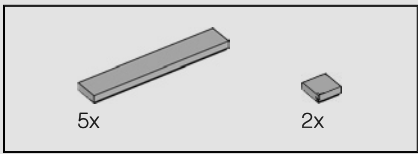

1

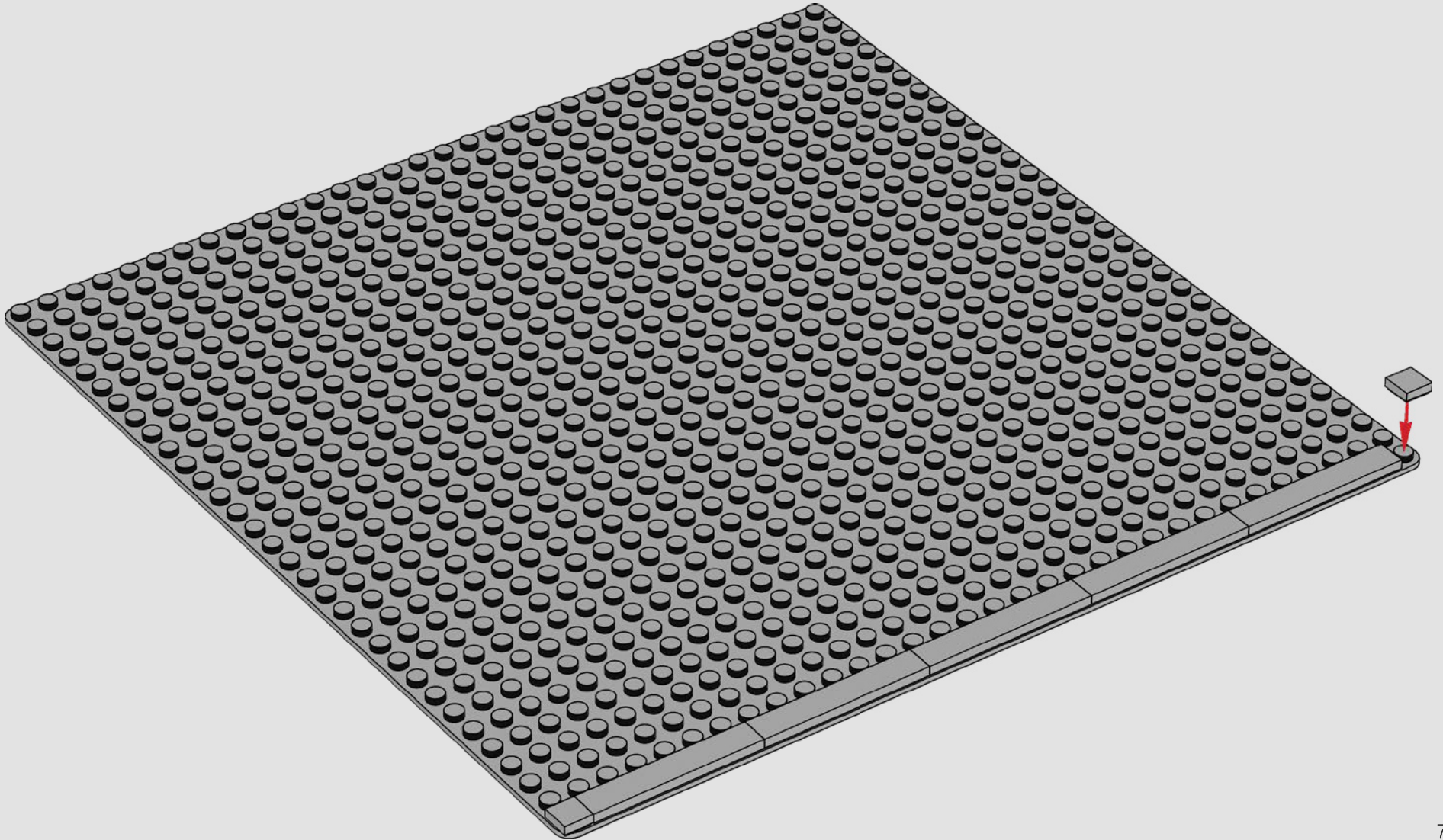

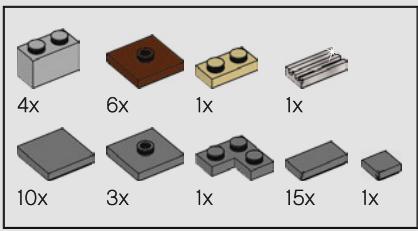

2

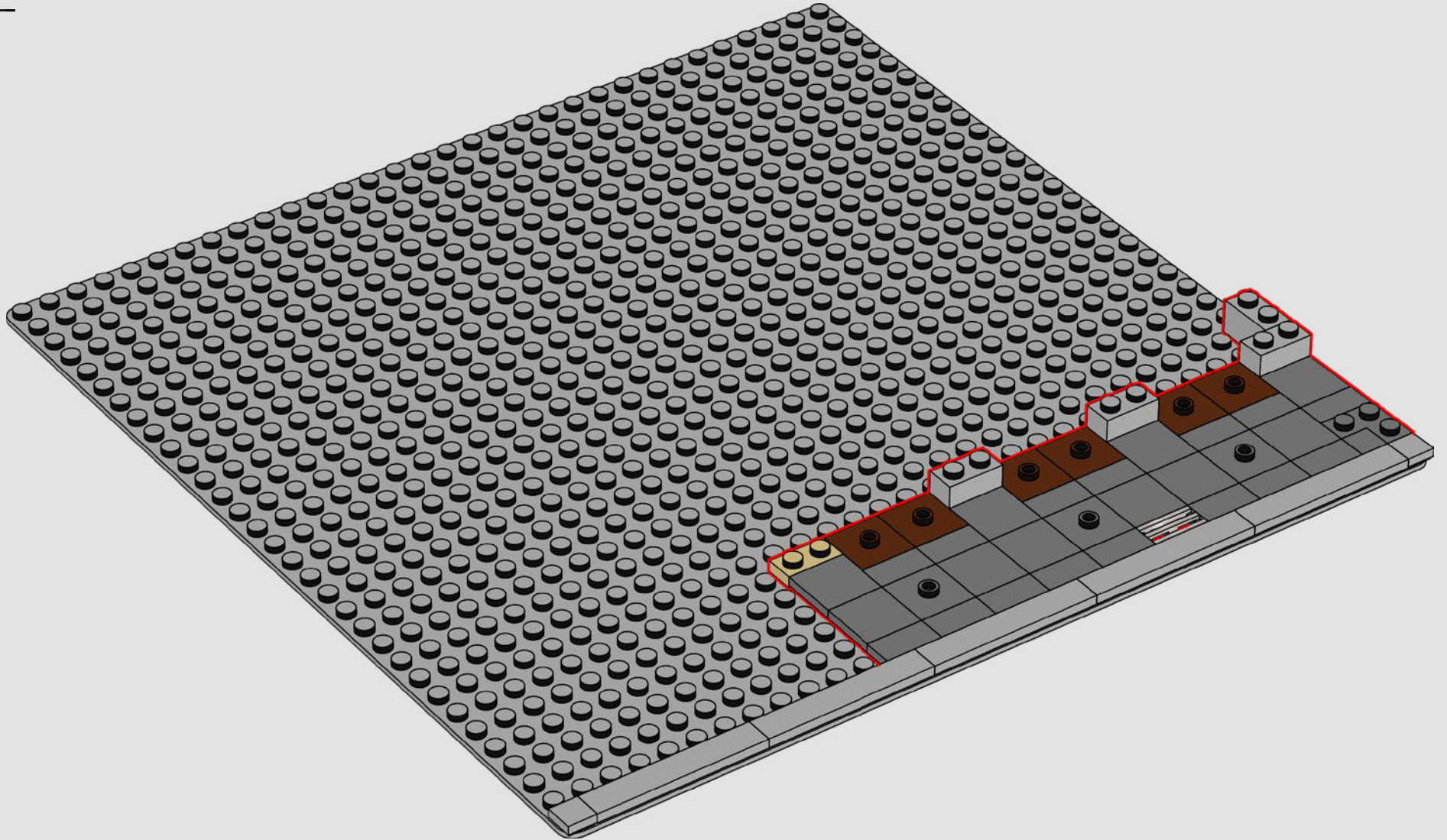



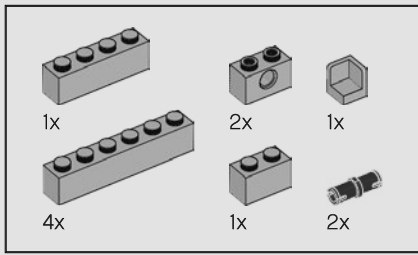

3

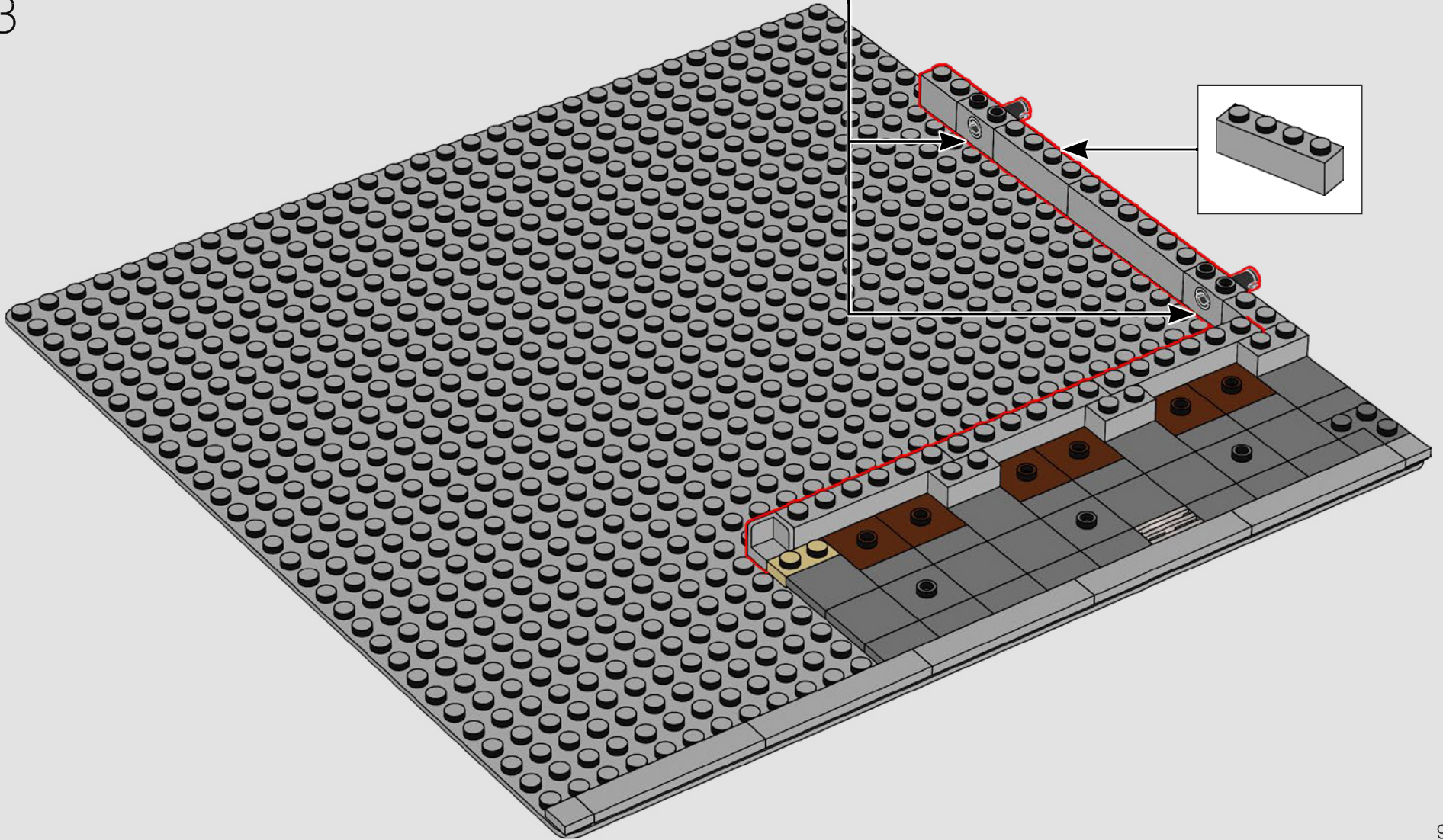
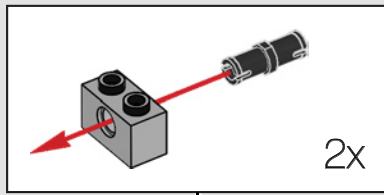

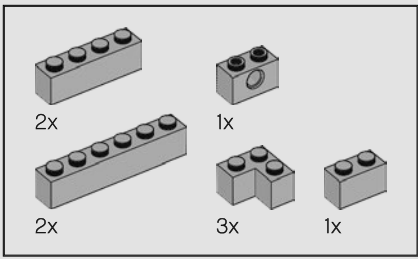

4

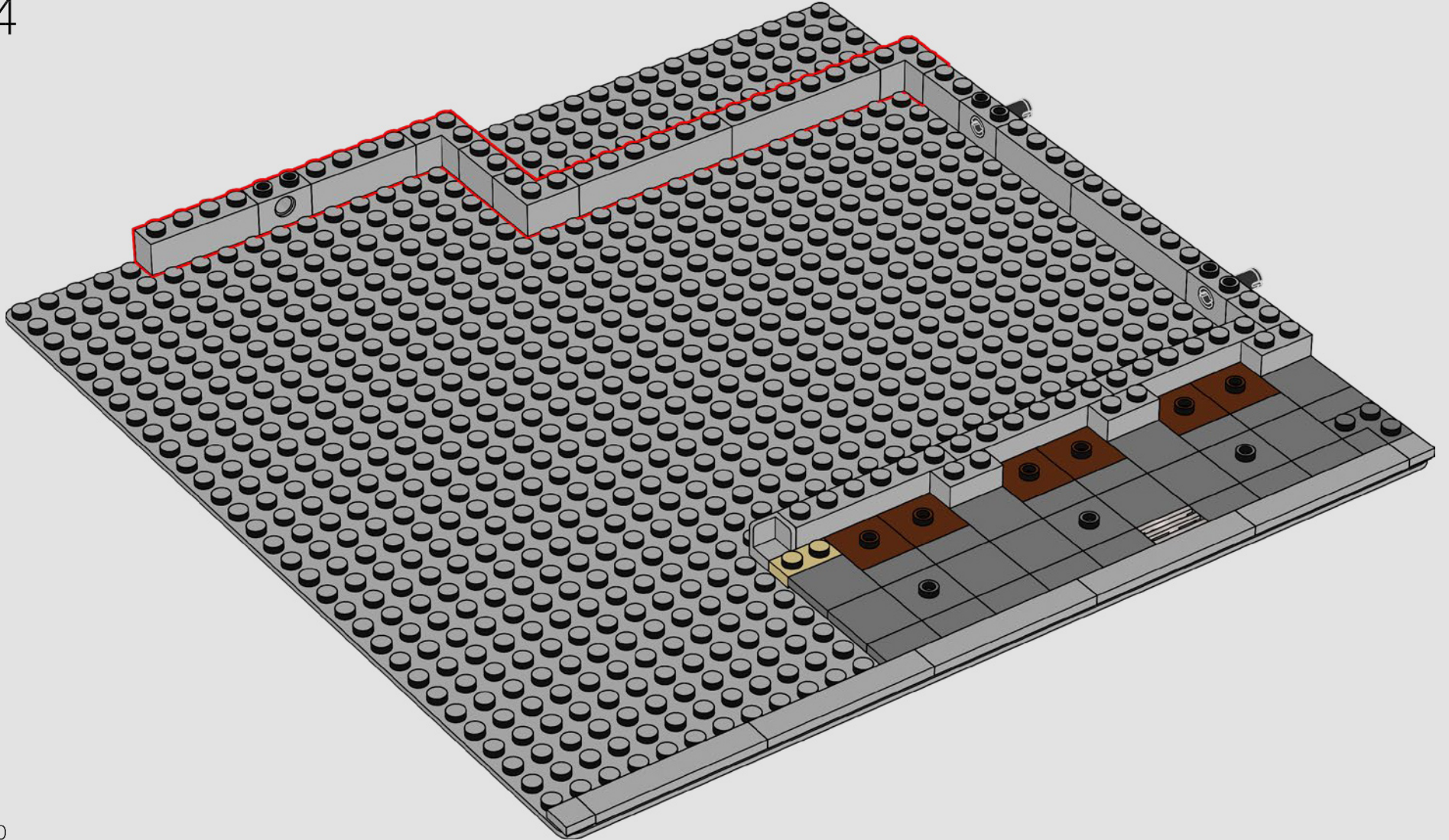

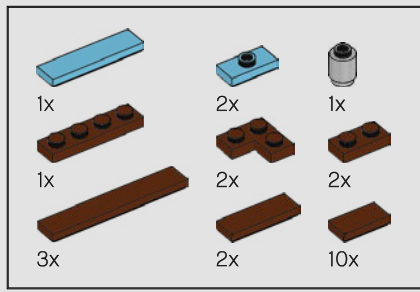

5

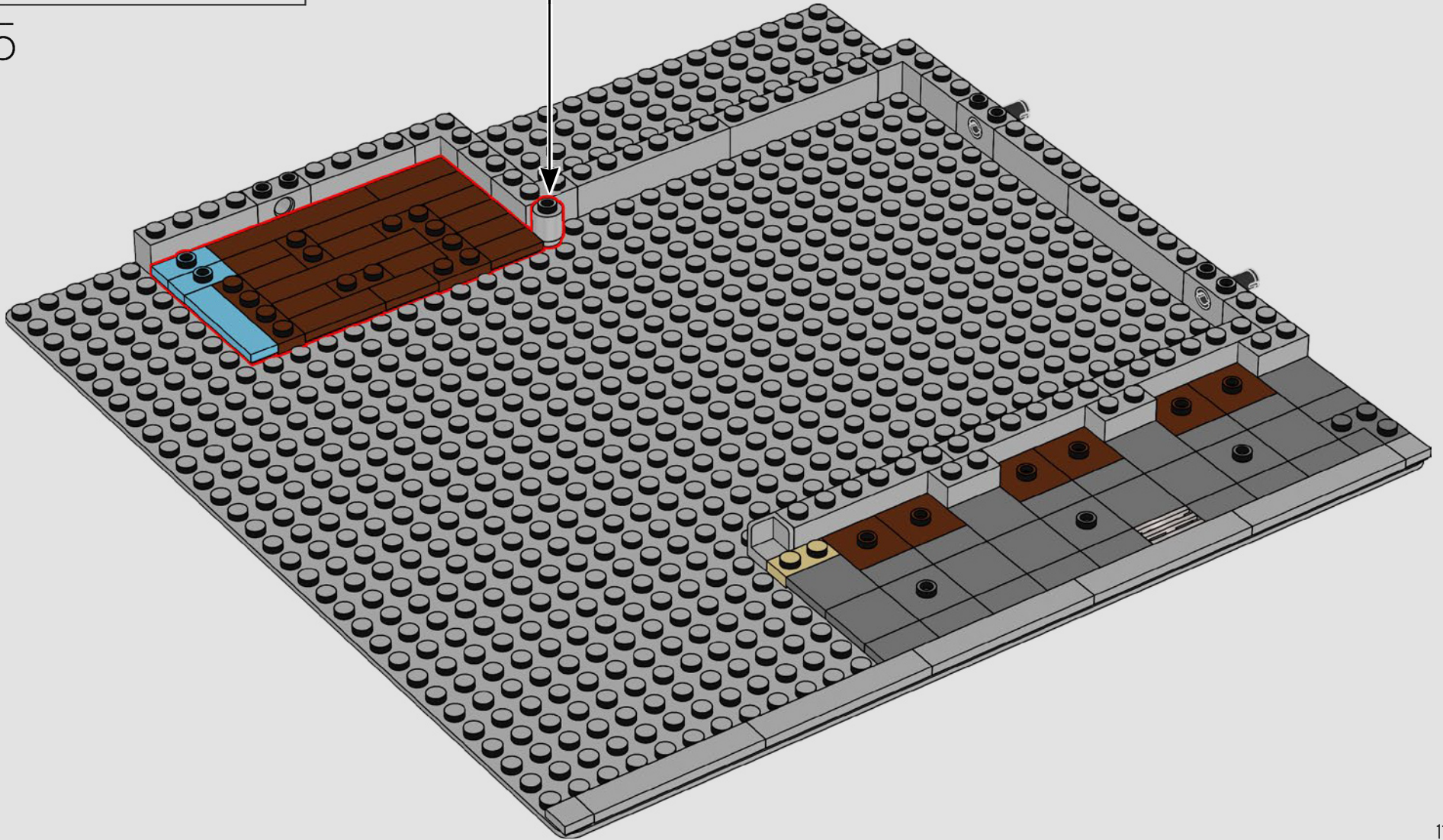
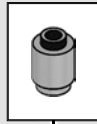

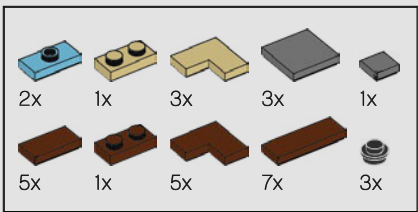

6

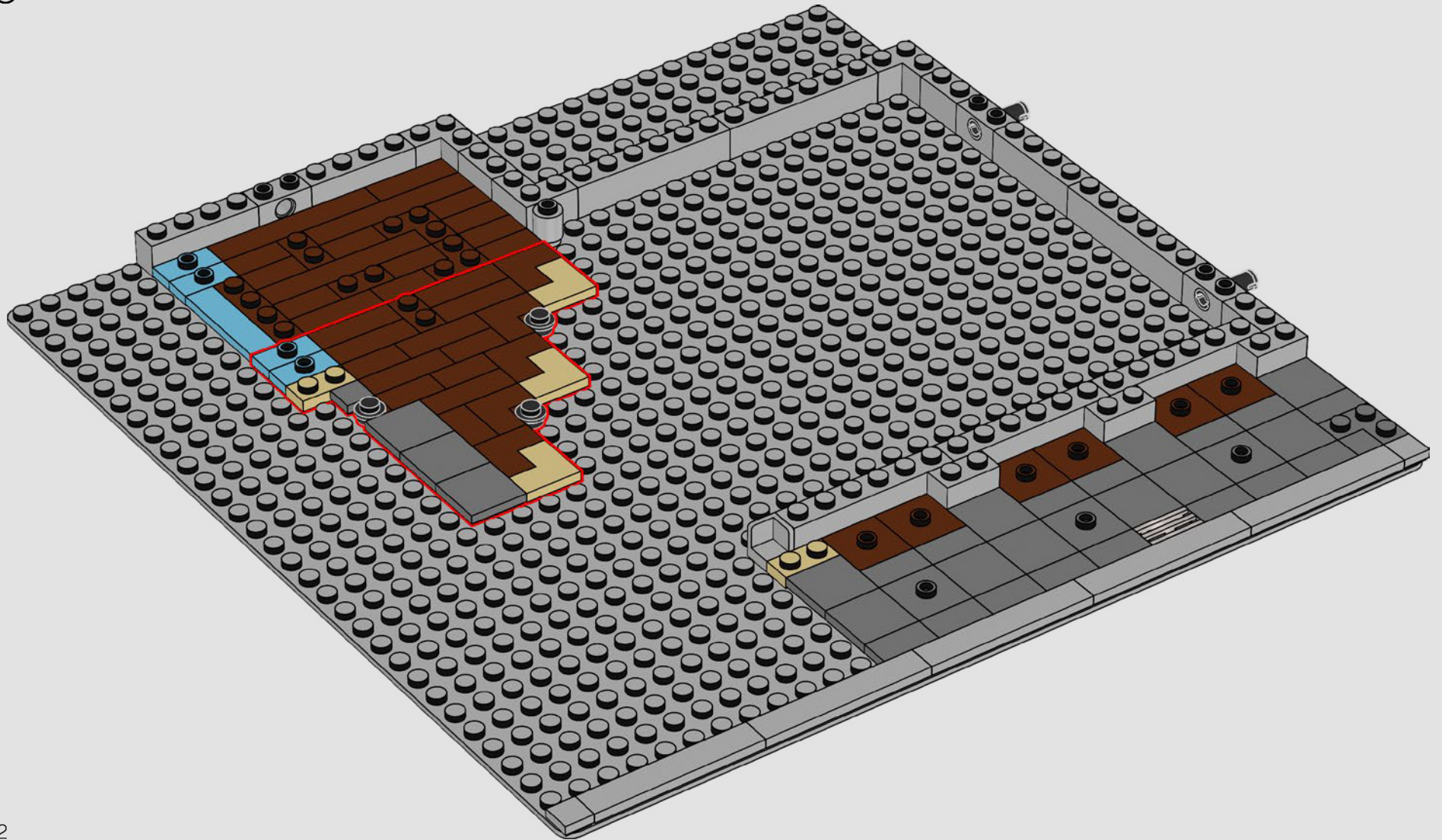

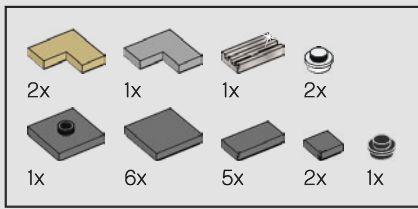

7

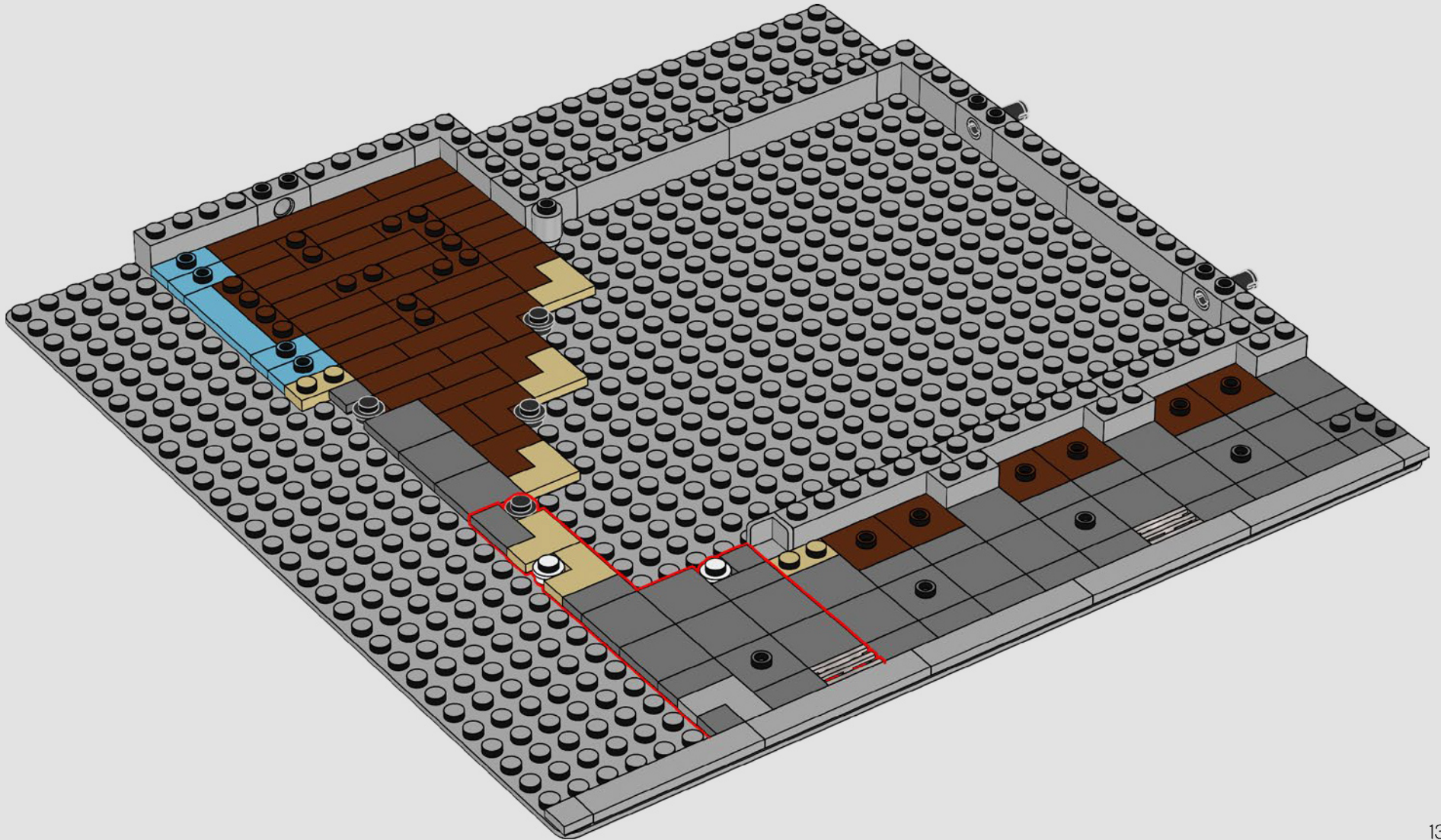

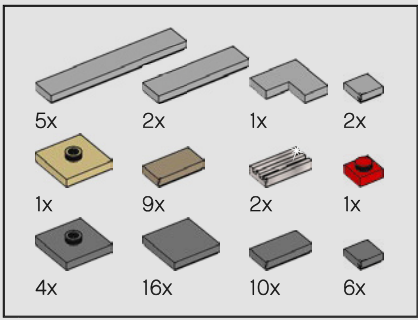

8

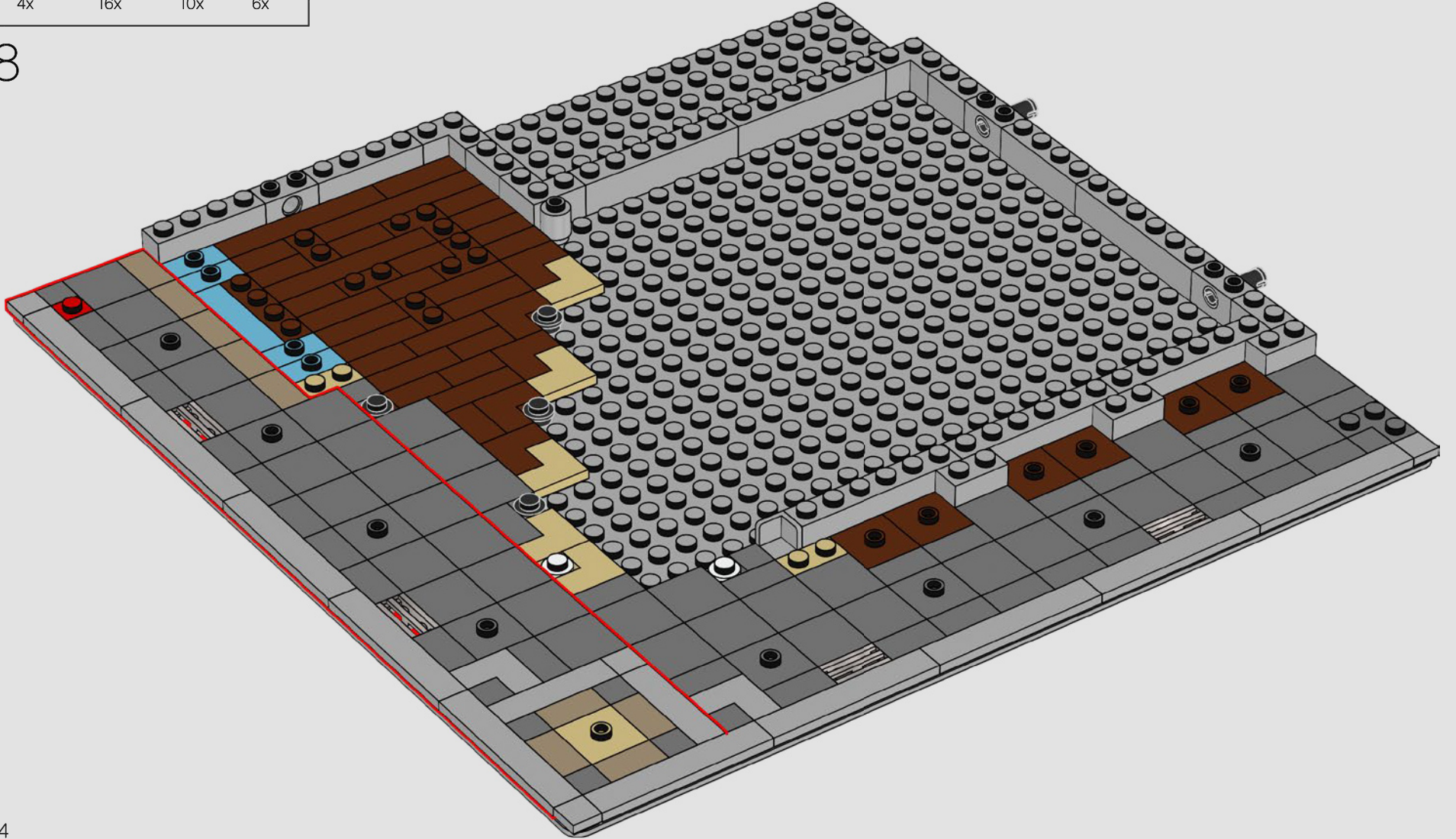

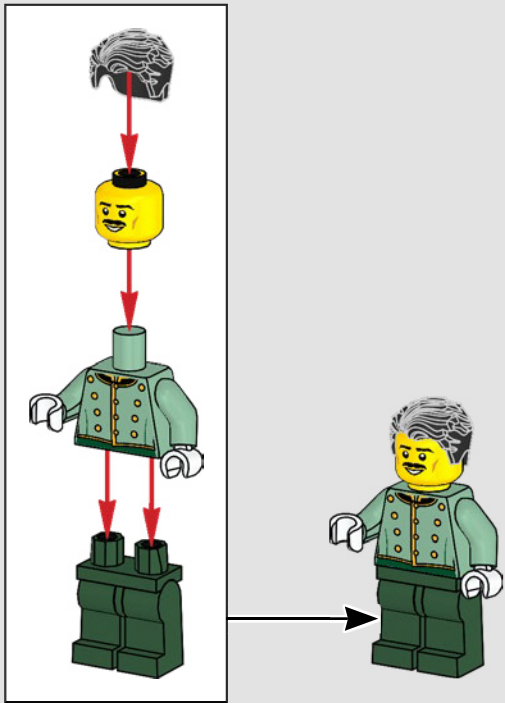
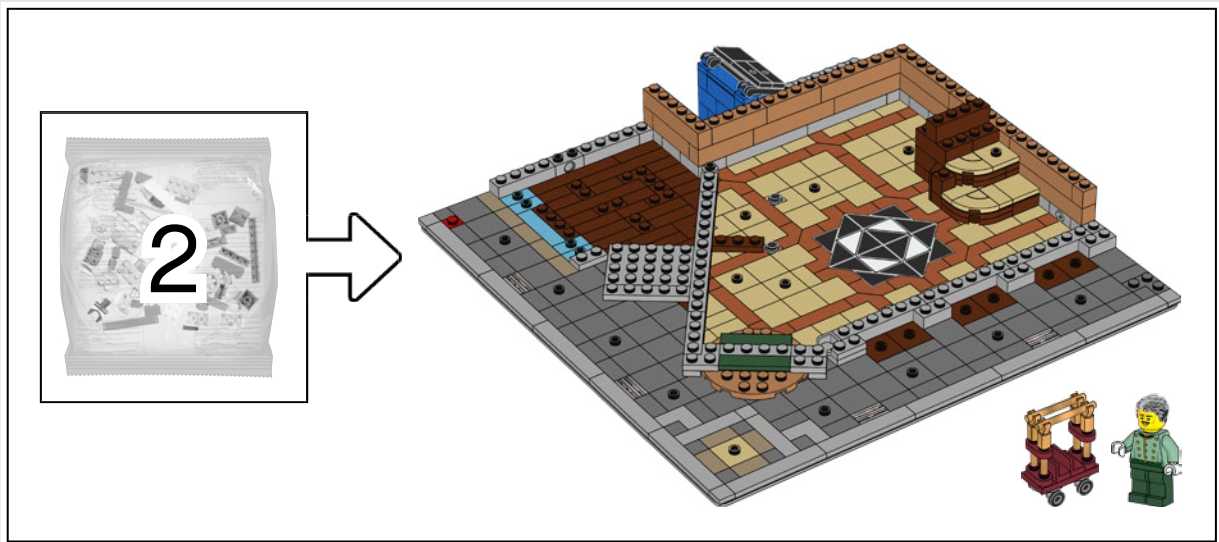

The Bellboy will happily help carry your luggage up the Hotel's stairs to your room.

Don't forget to give him a tip! 15

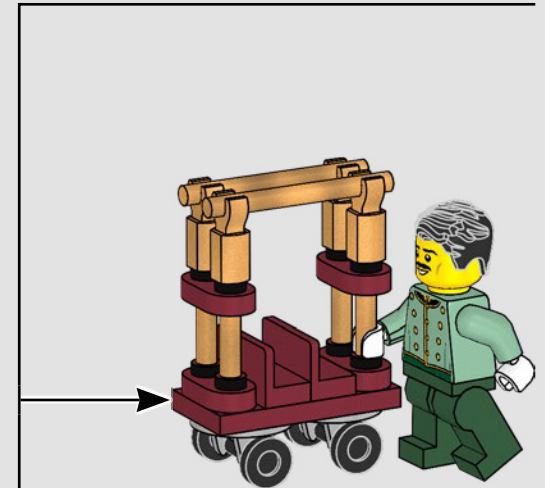
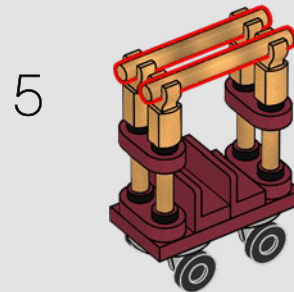
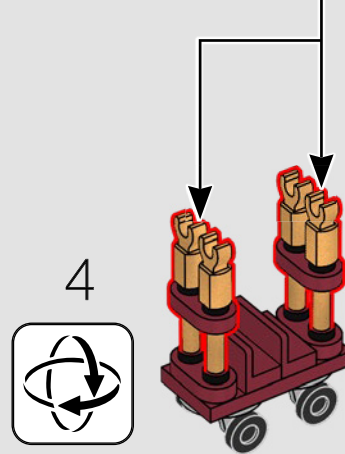
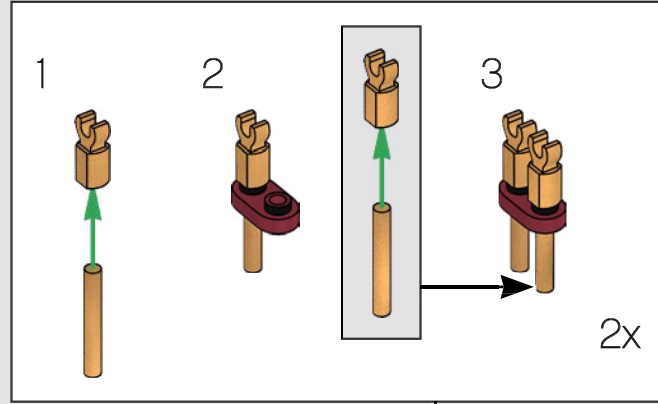
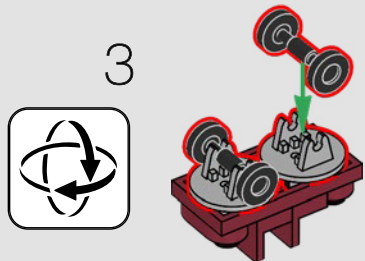
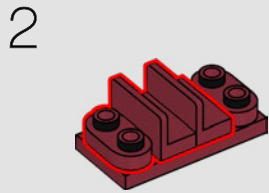
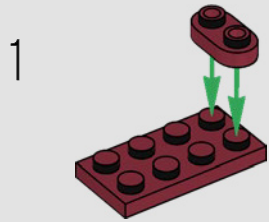
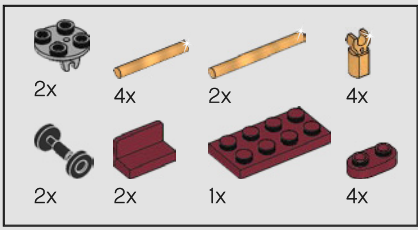



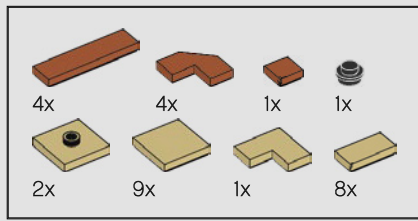

9

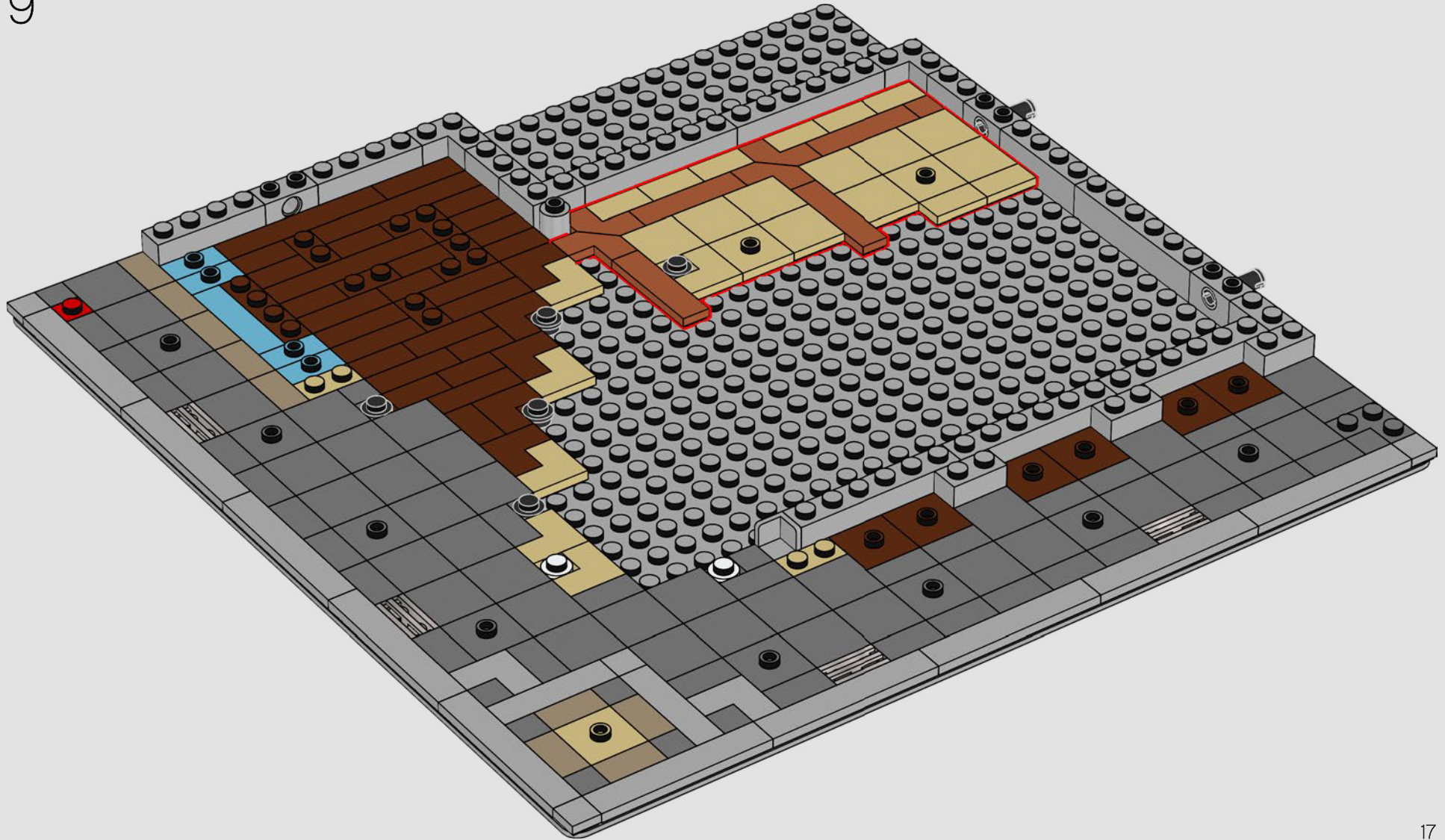



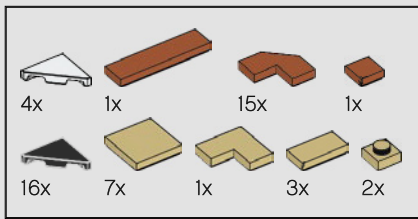

11

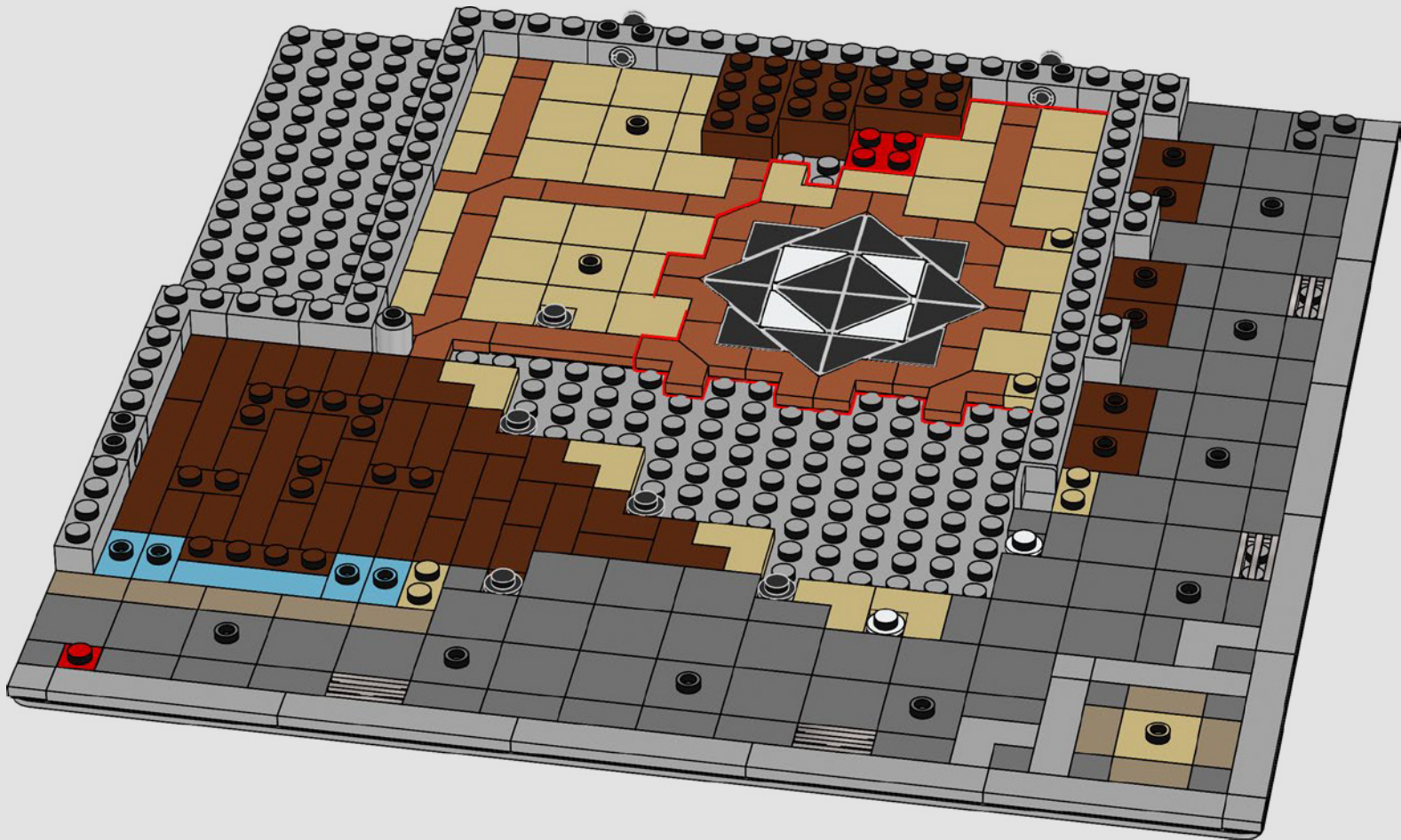

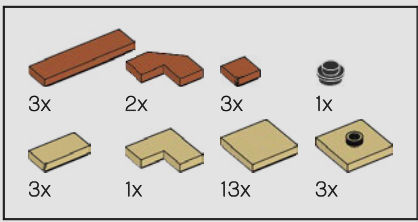

12

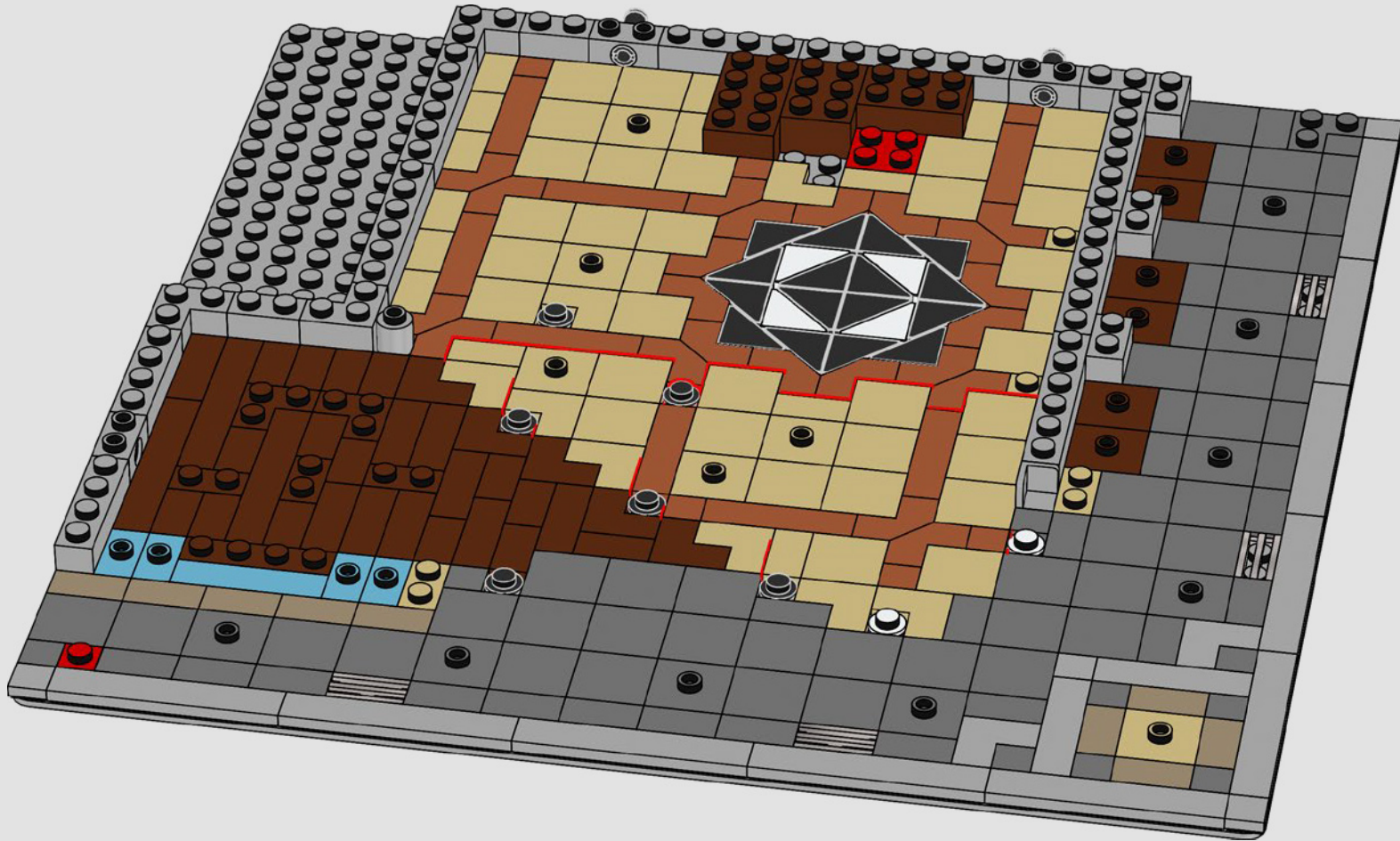

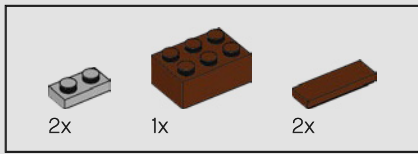

13

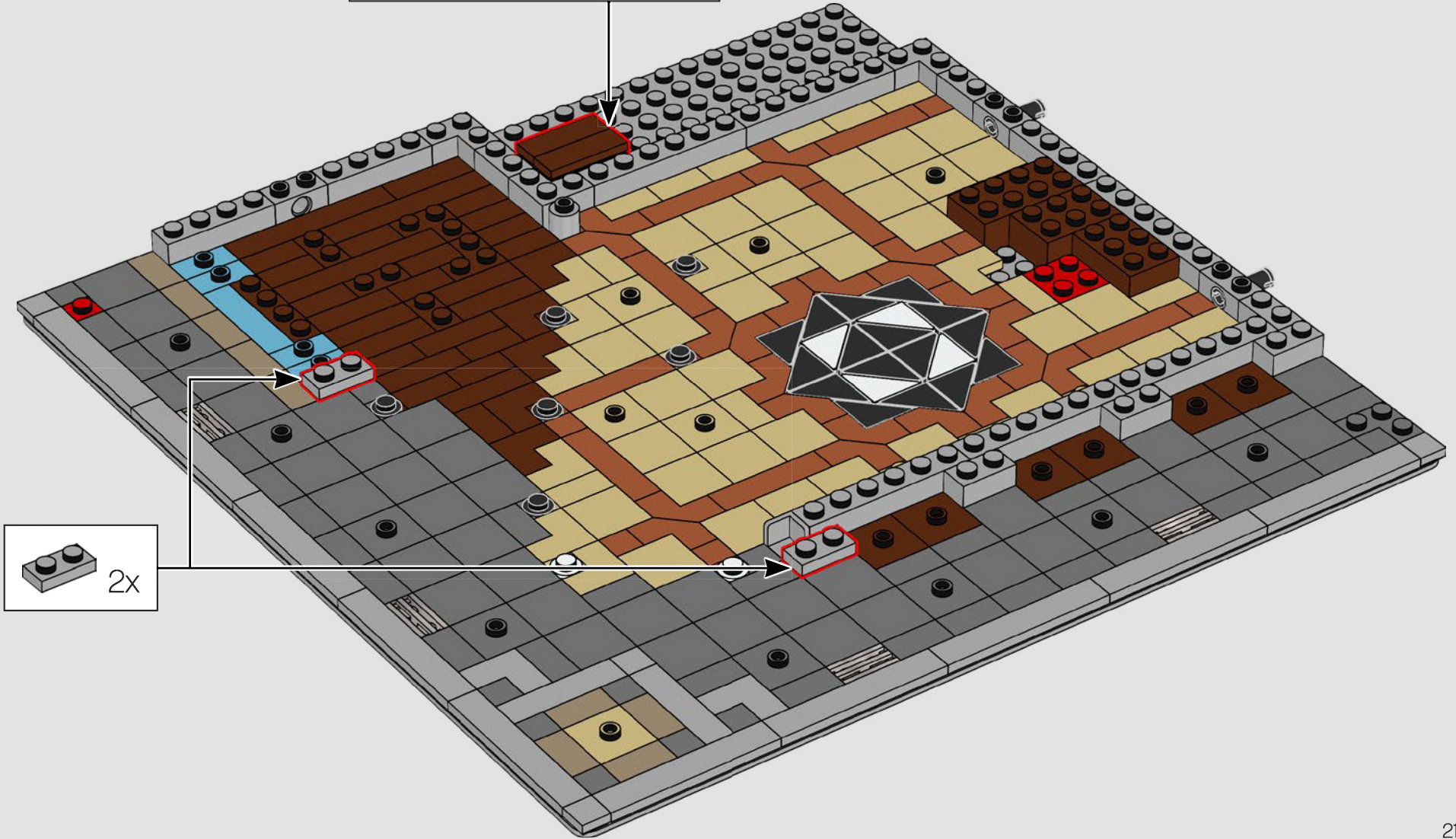
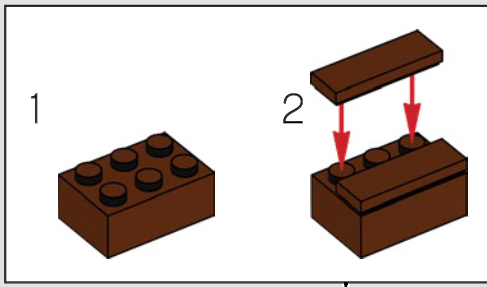

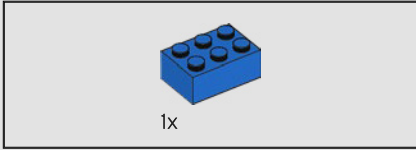
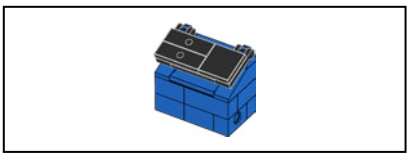

14

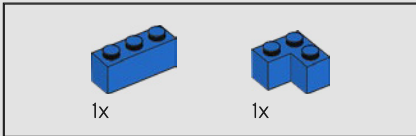
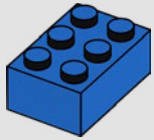

15

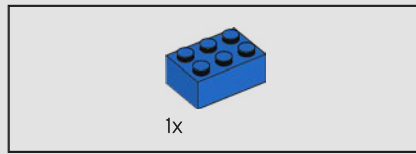
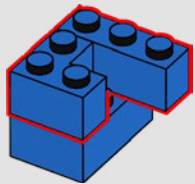

16

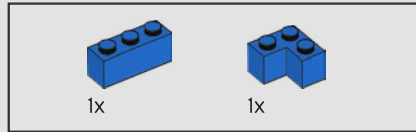
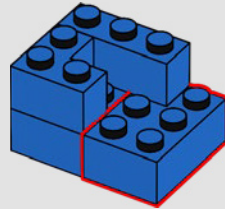

17

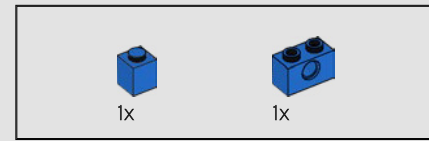
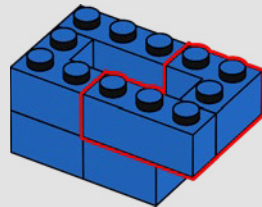

18

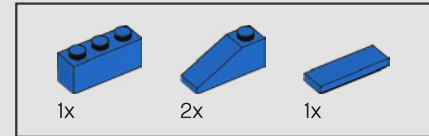
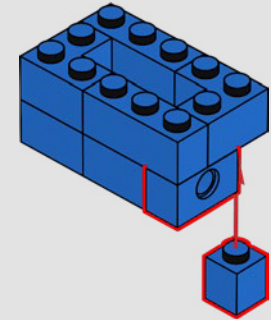

19

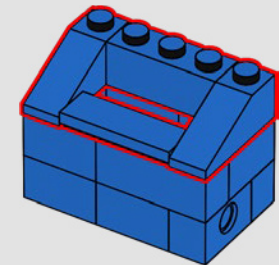

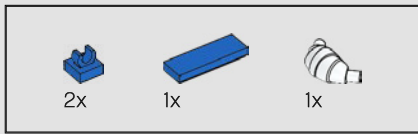

20

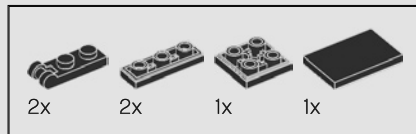
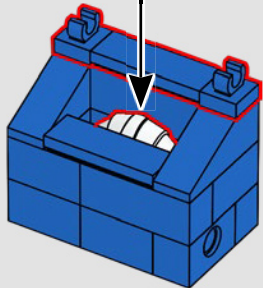

21

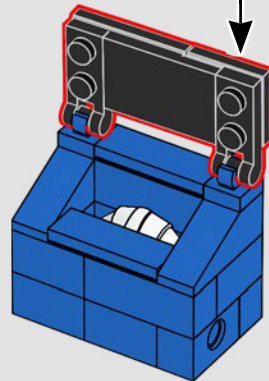
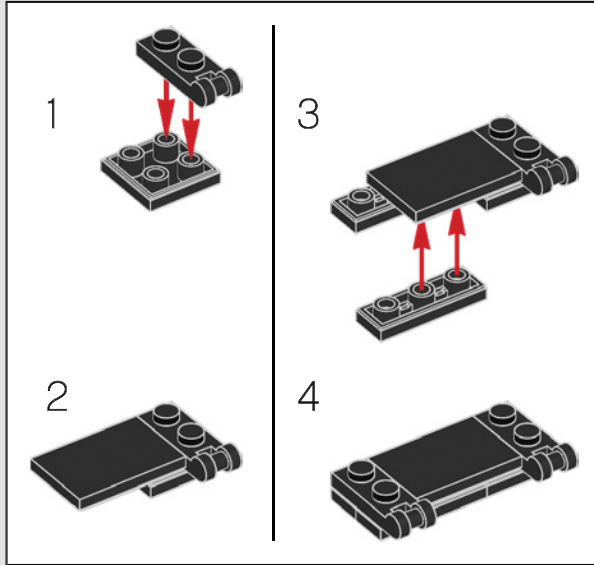

22

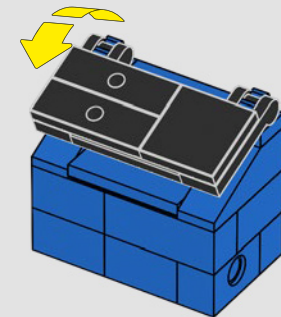

This croissant was found at the Parisian Restaurant in the 10243 set ... but why would anyone want a mouldy white croissant?

23

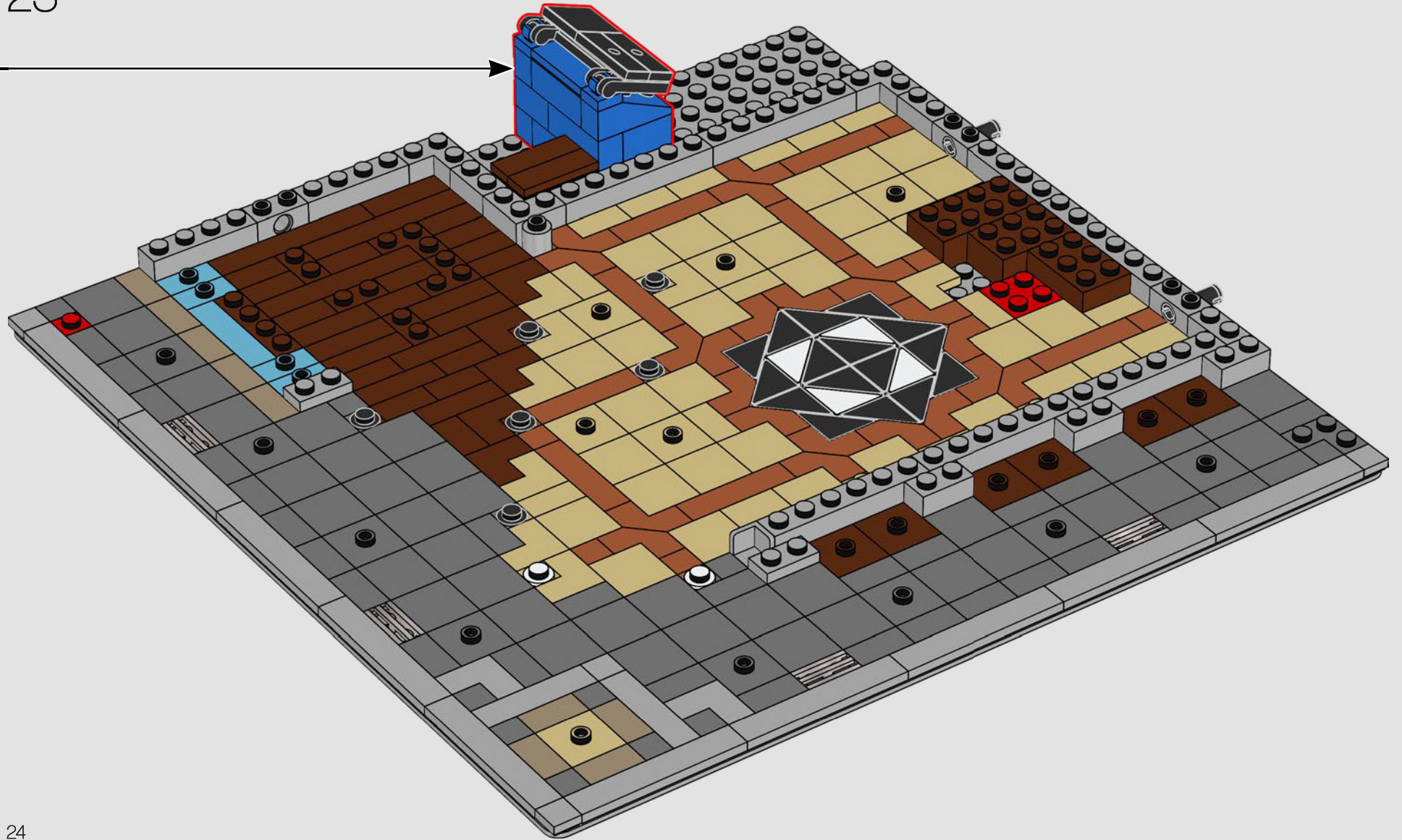

24



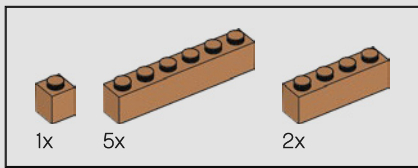

24

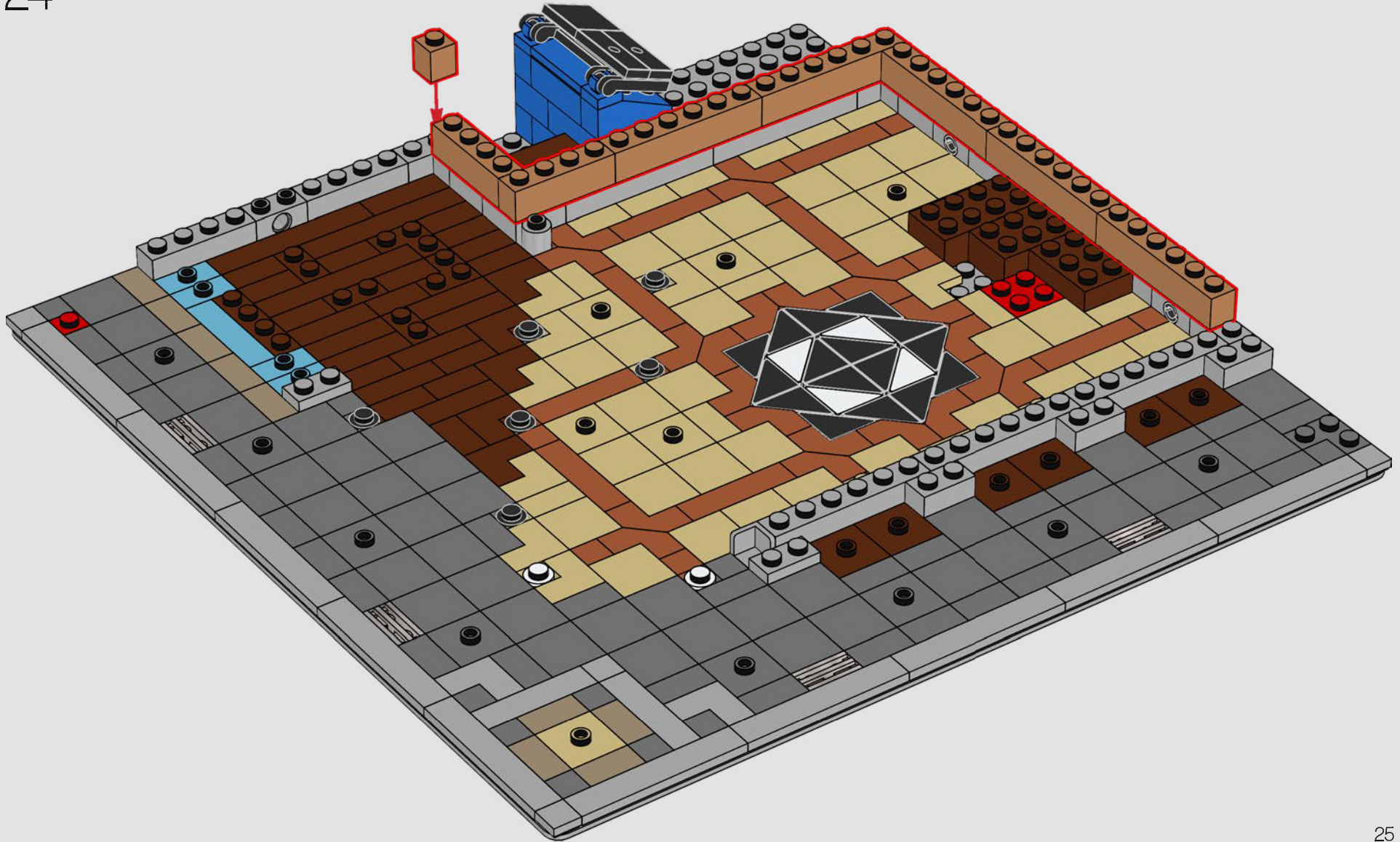

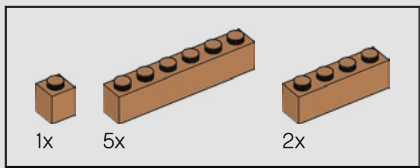

25

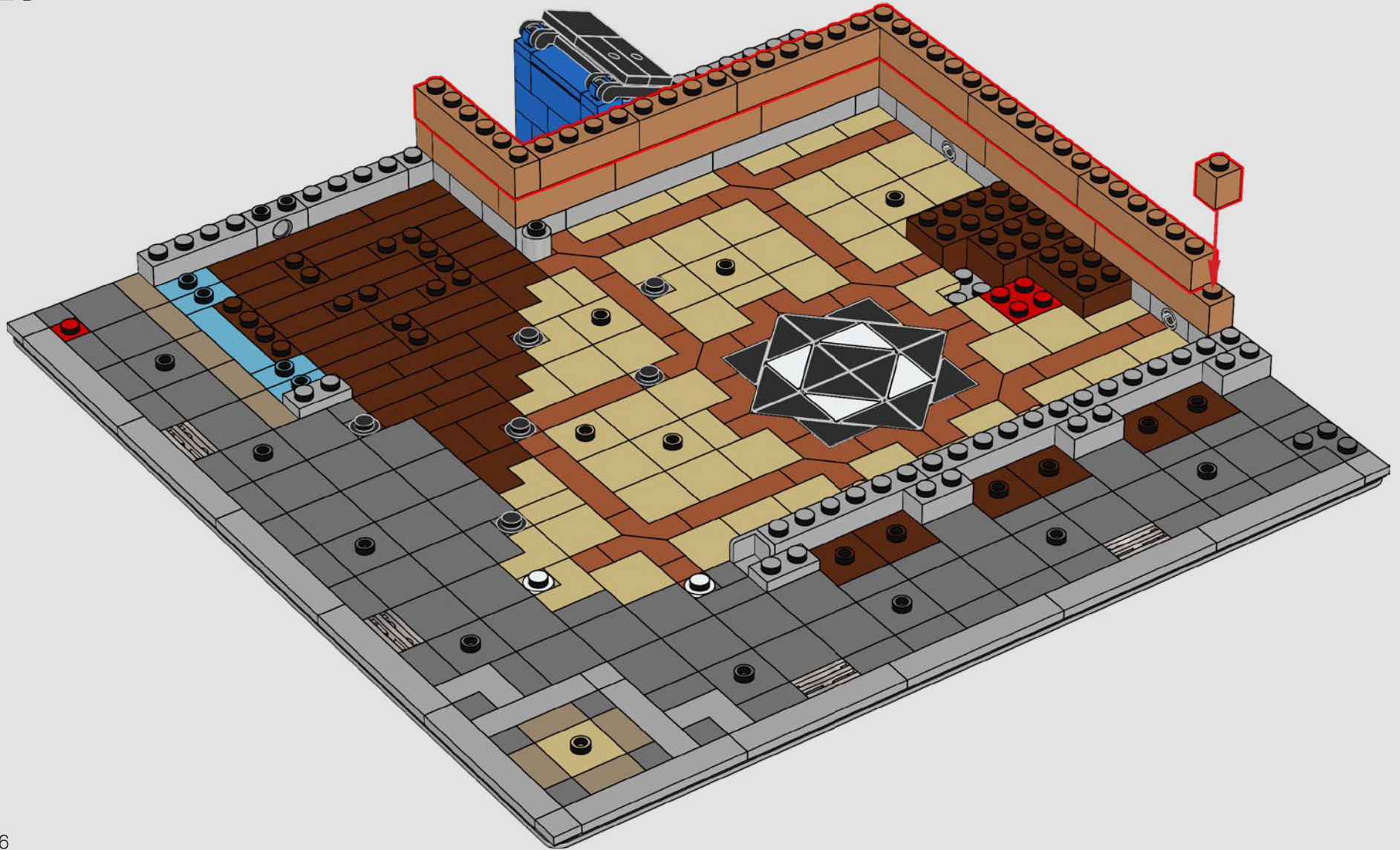

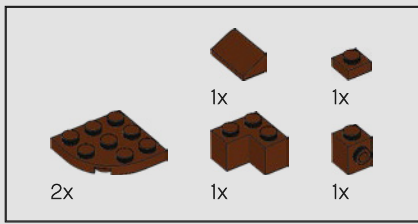

26

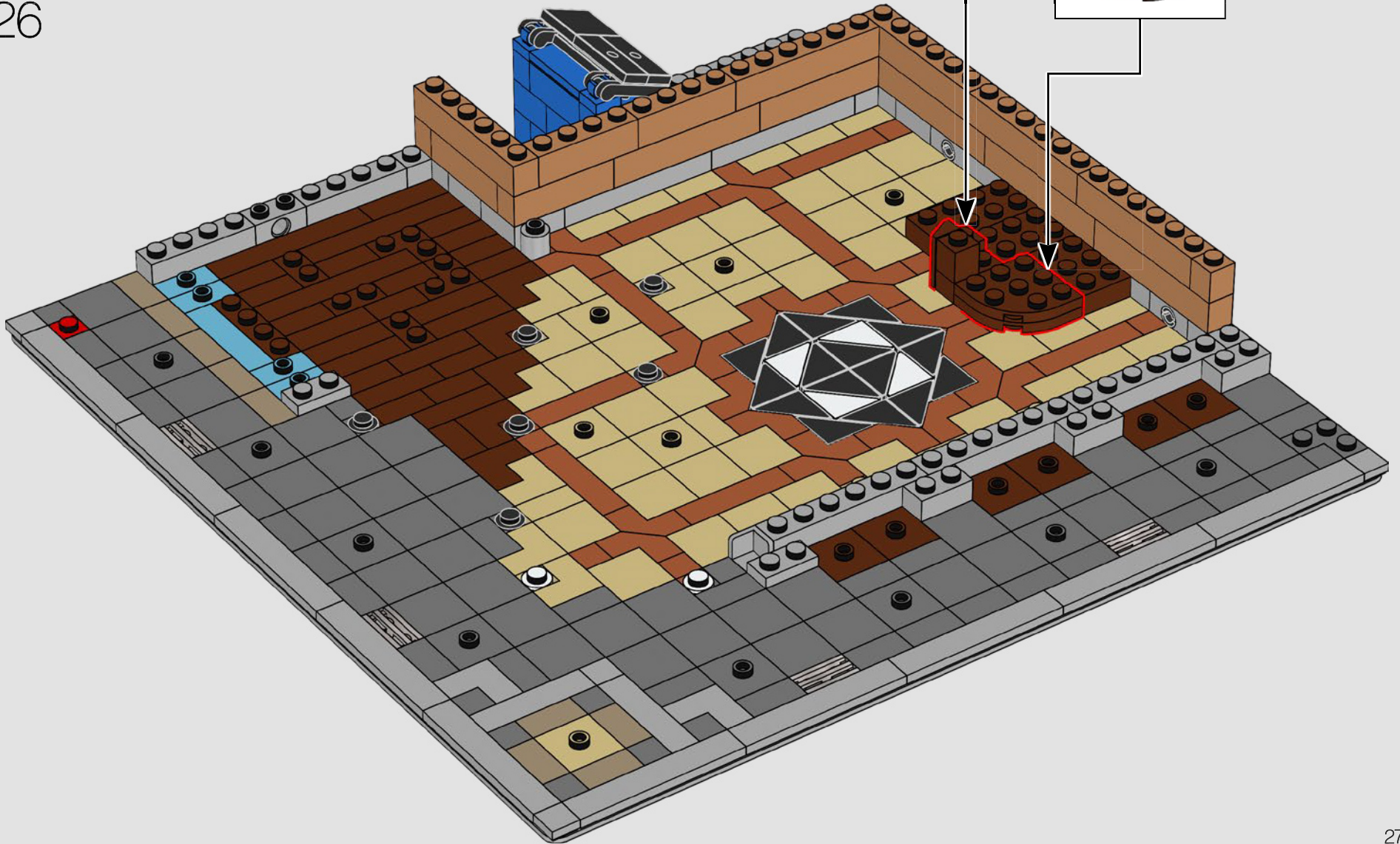
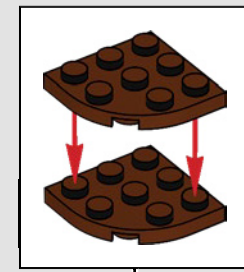
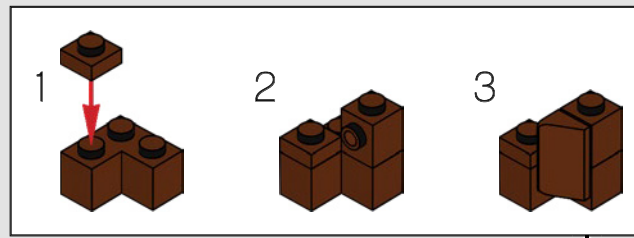

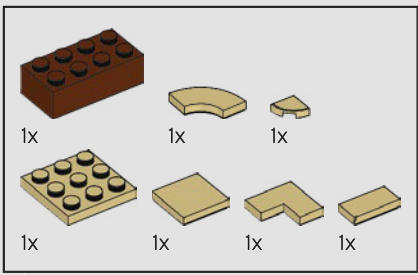

27

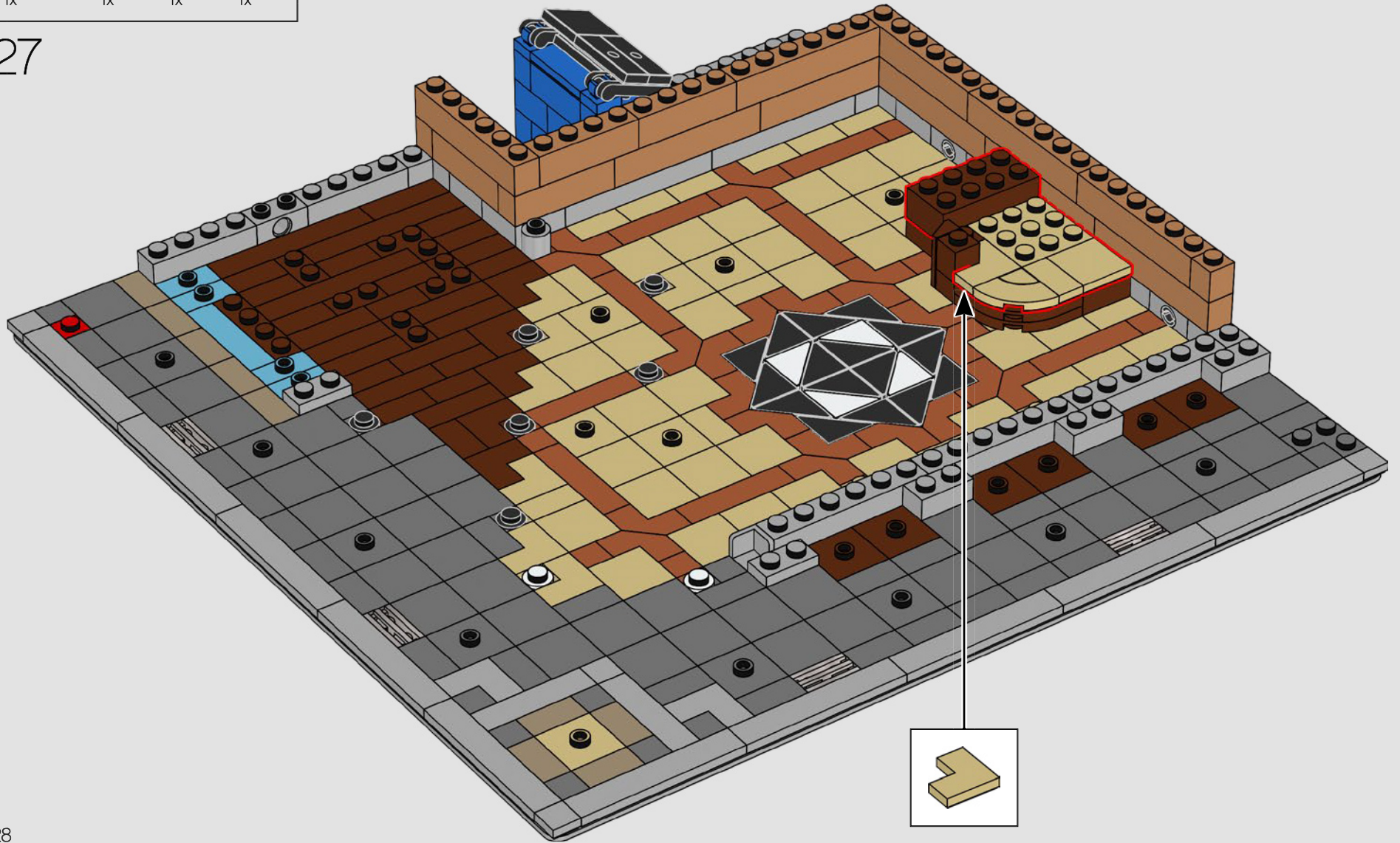

28

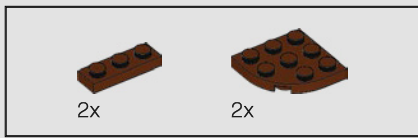

28

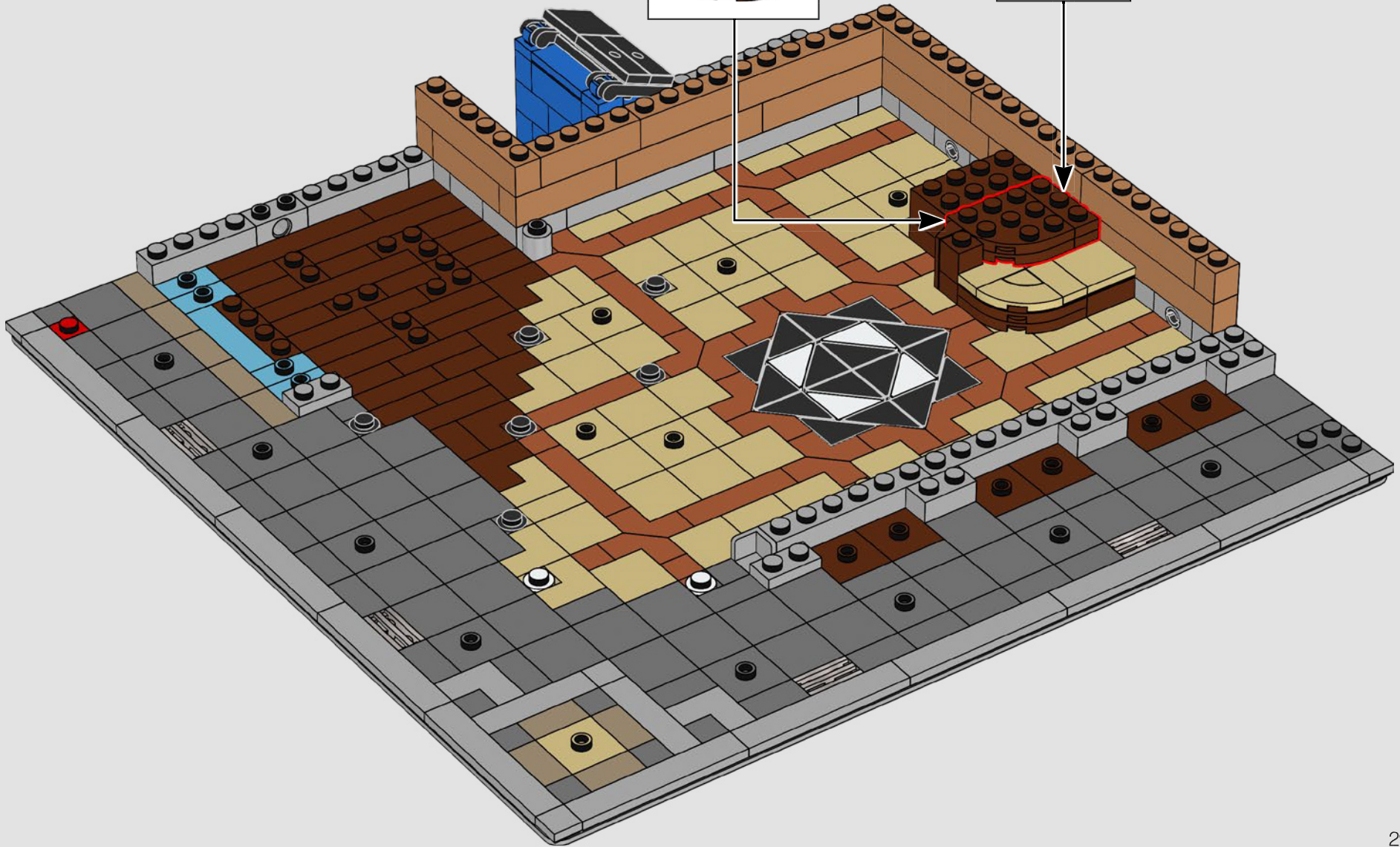
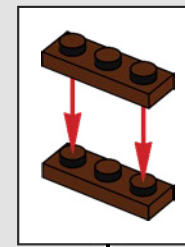
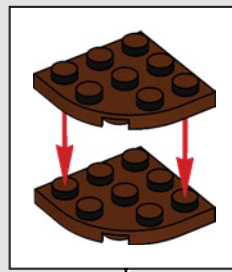

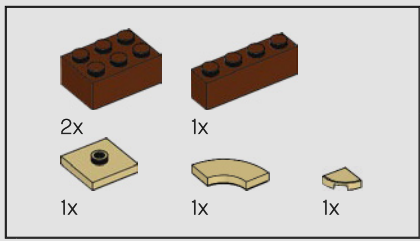

29

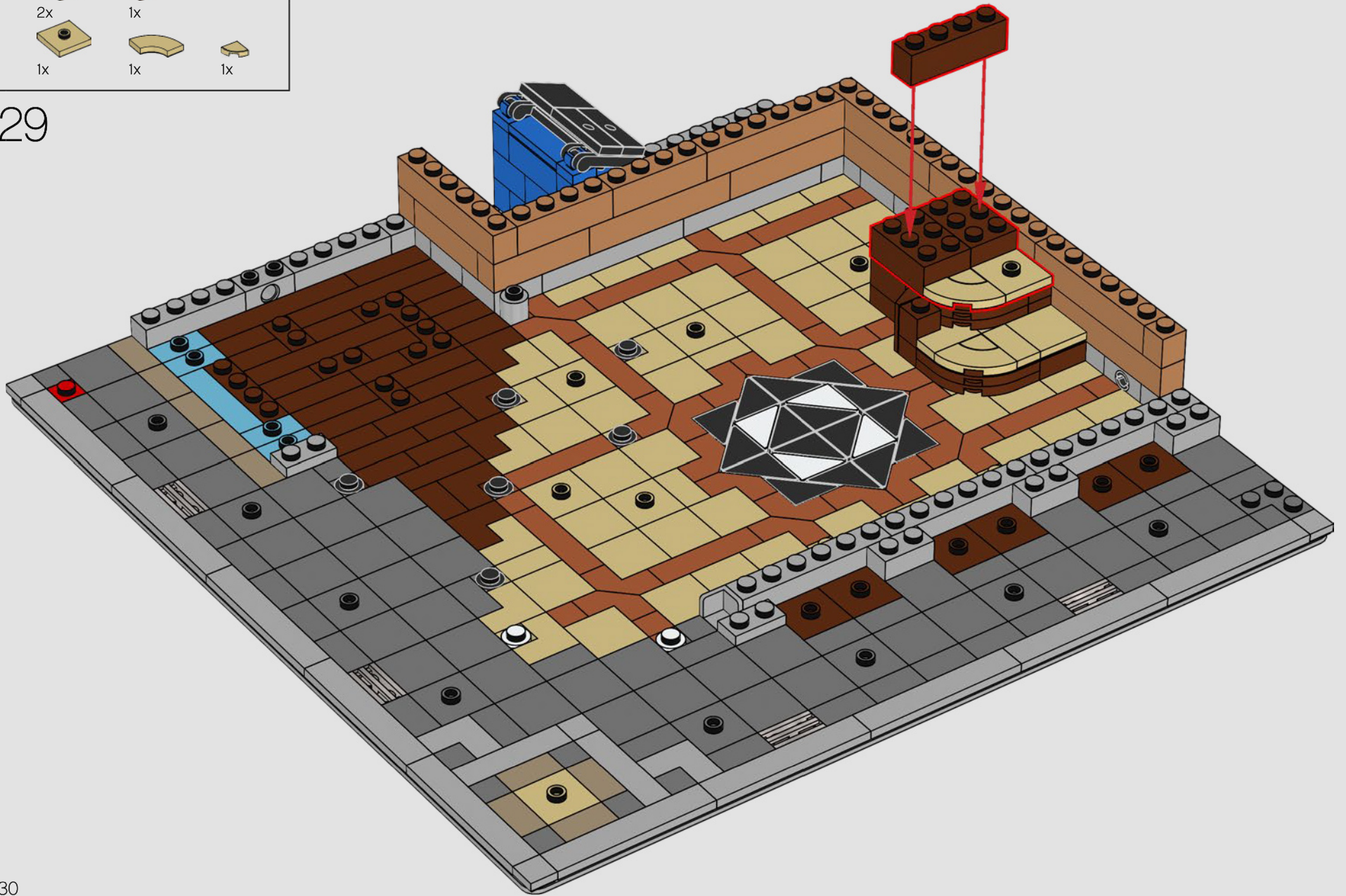

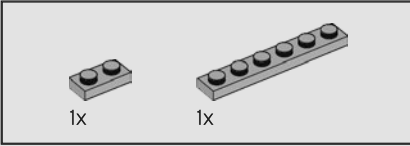
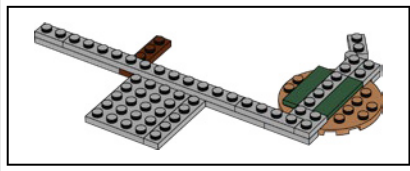

30

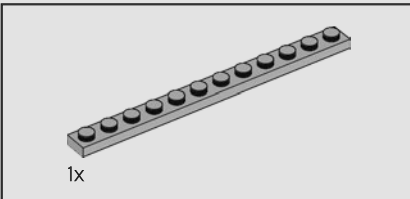
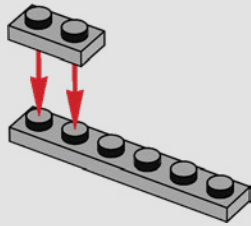

31

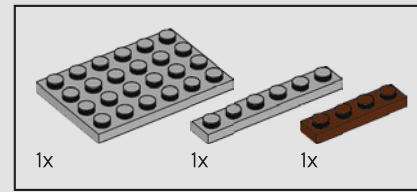
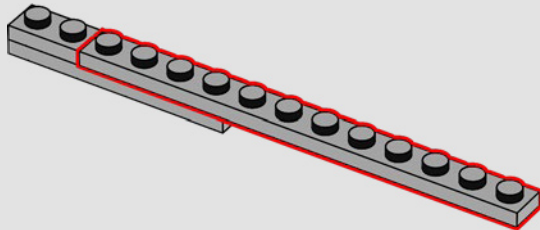

32

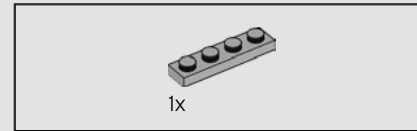
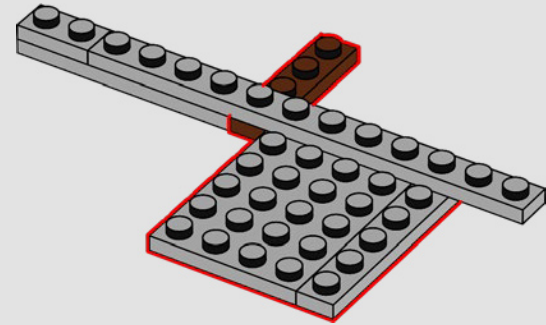

33

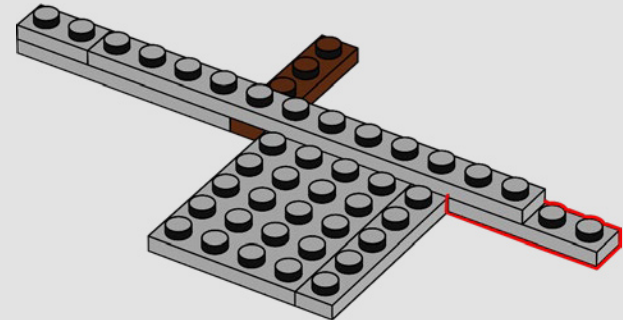

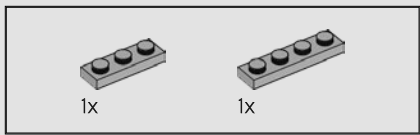

34

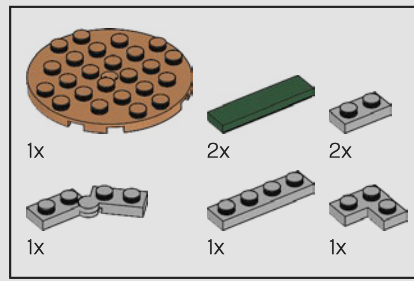
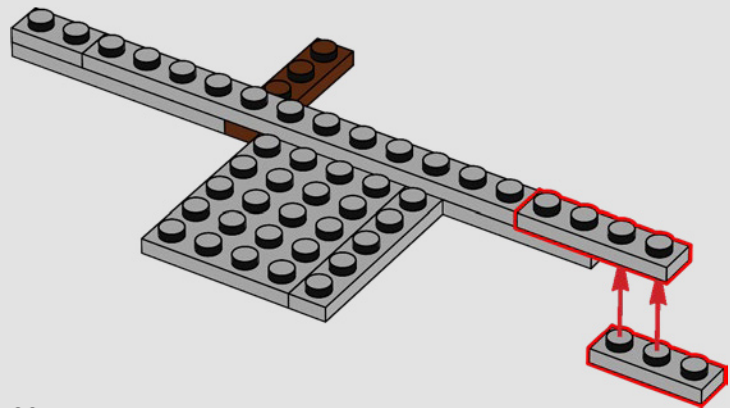

35

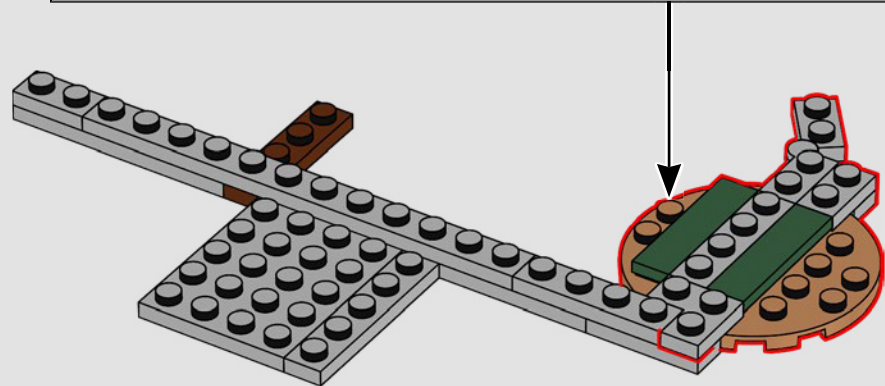
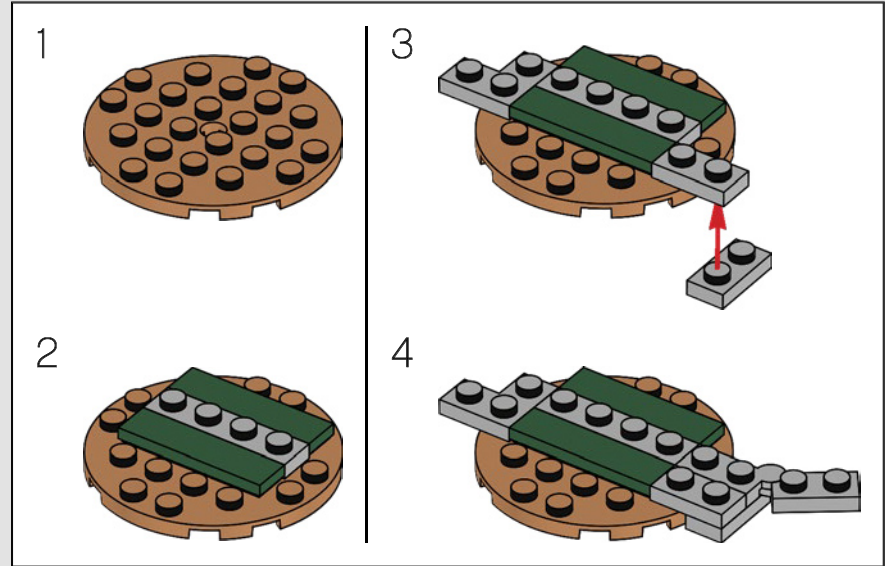



36

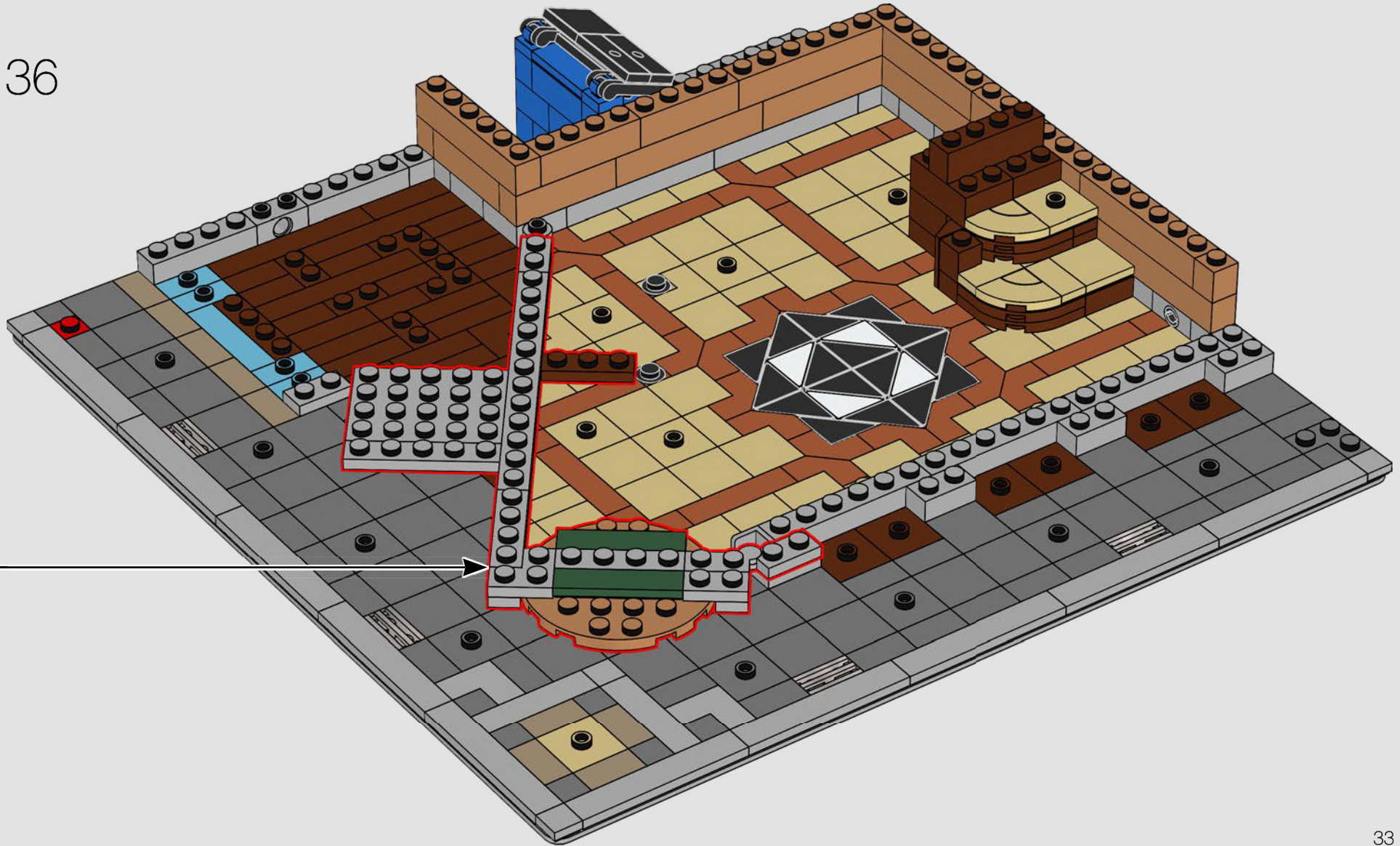

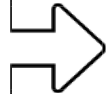

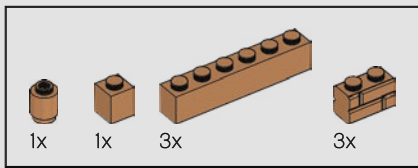

37

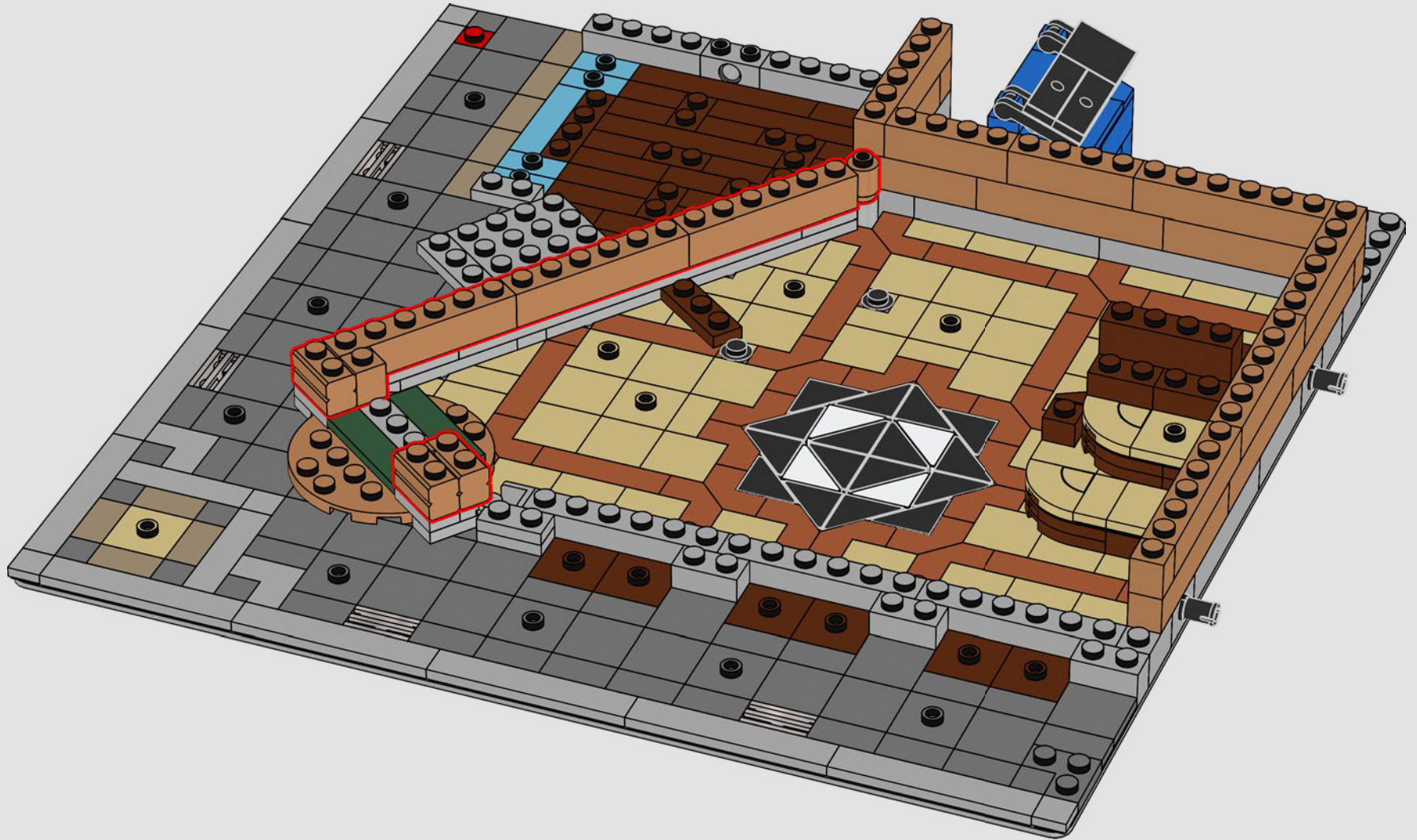

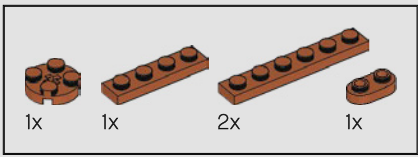

38

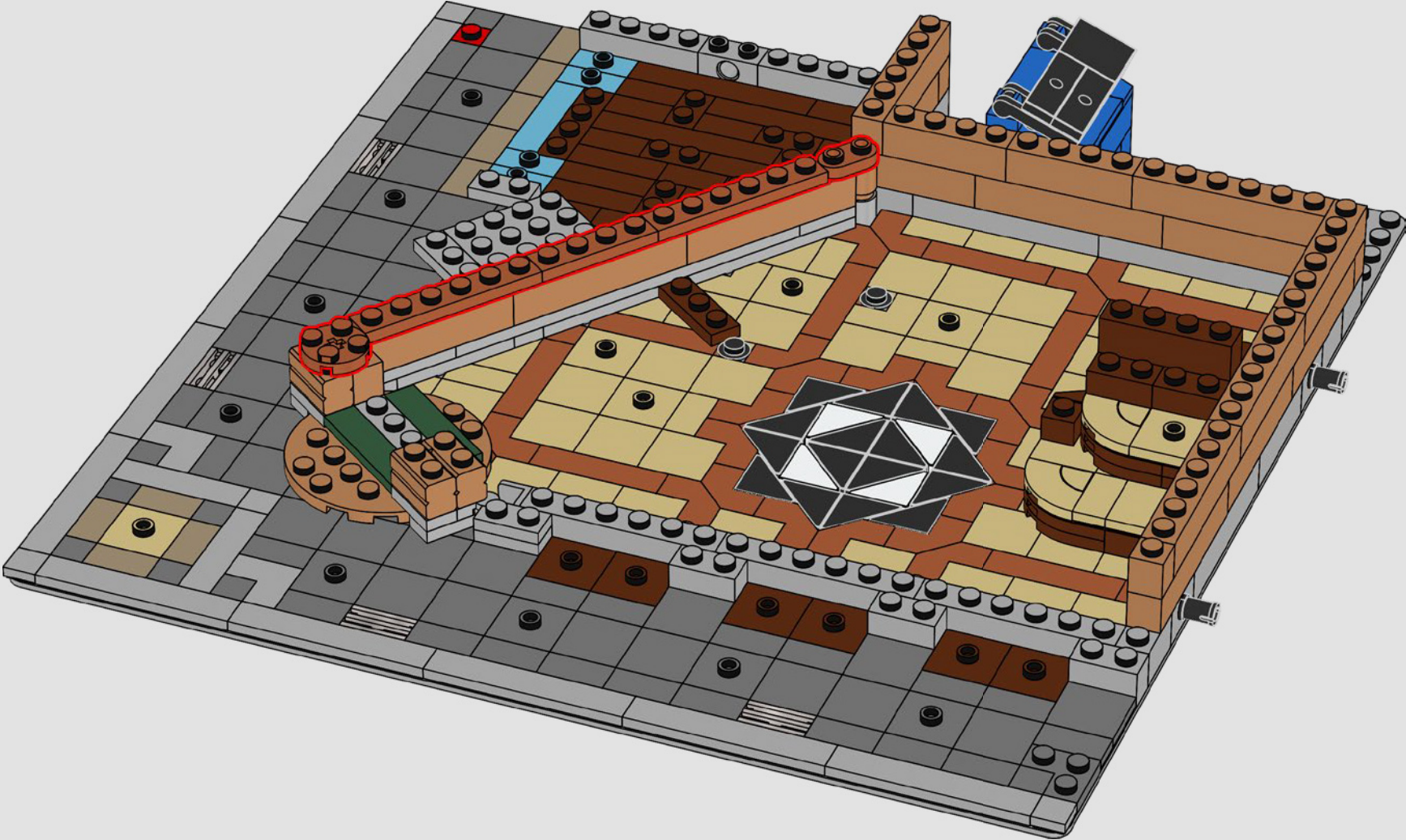

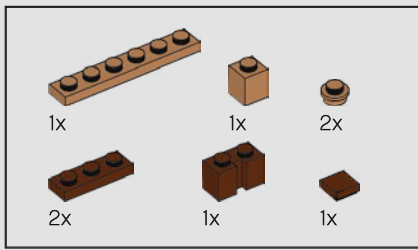

39

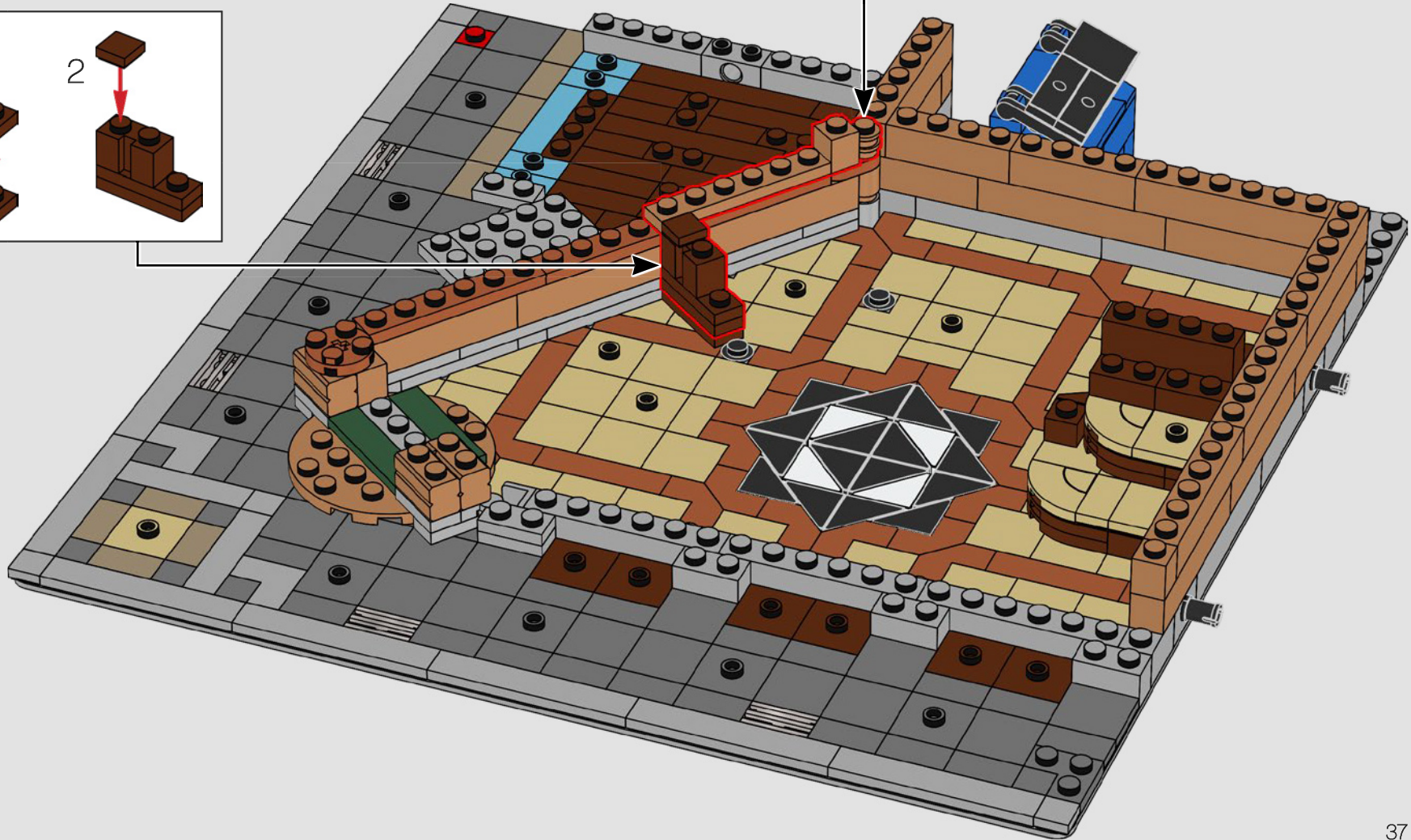
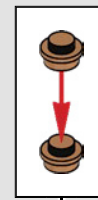
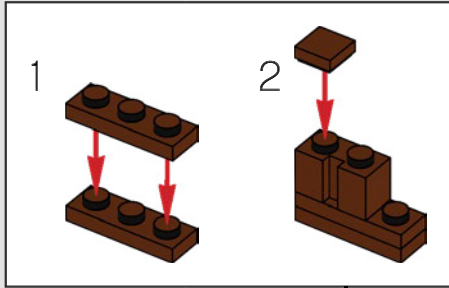

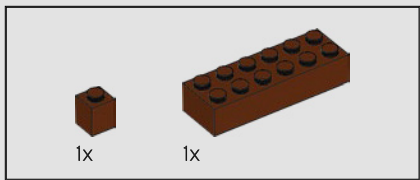

40

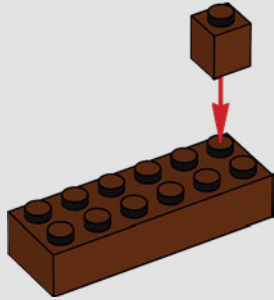

41

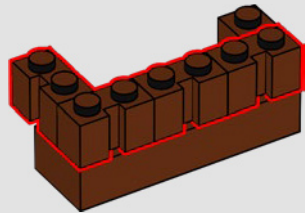

42

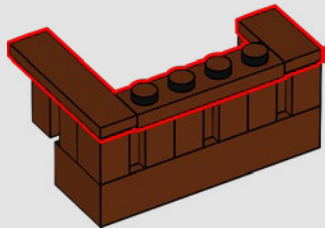

Many of the guests who've stayed in this hotel are residents of earlier Modular sets!  
Can you identify them?



43

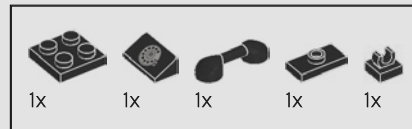
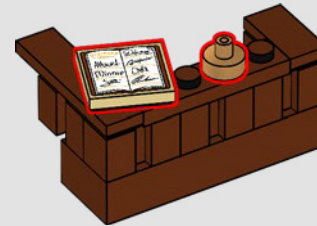

44

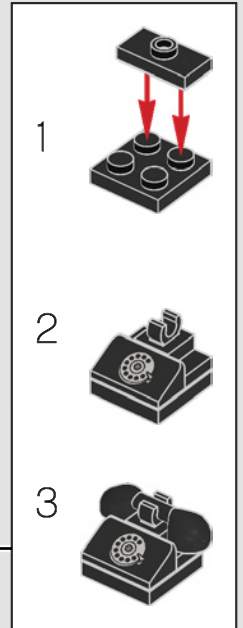
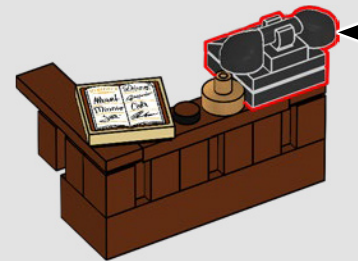



The Receptionist enjoys calling her friend the Lieutenant in the 10278 Police Station set on this phone.

45

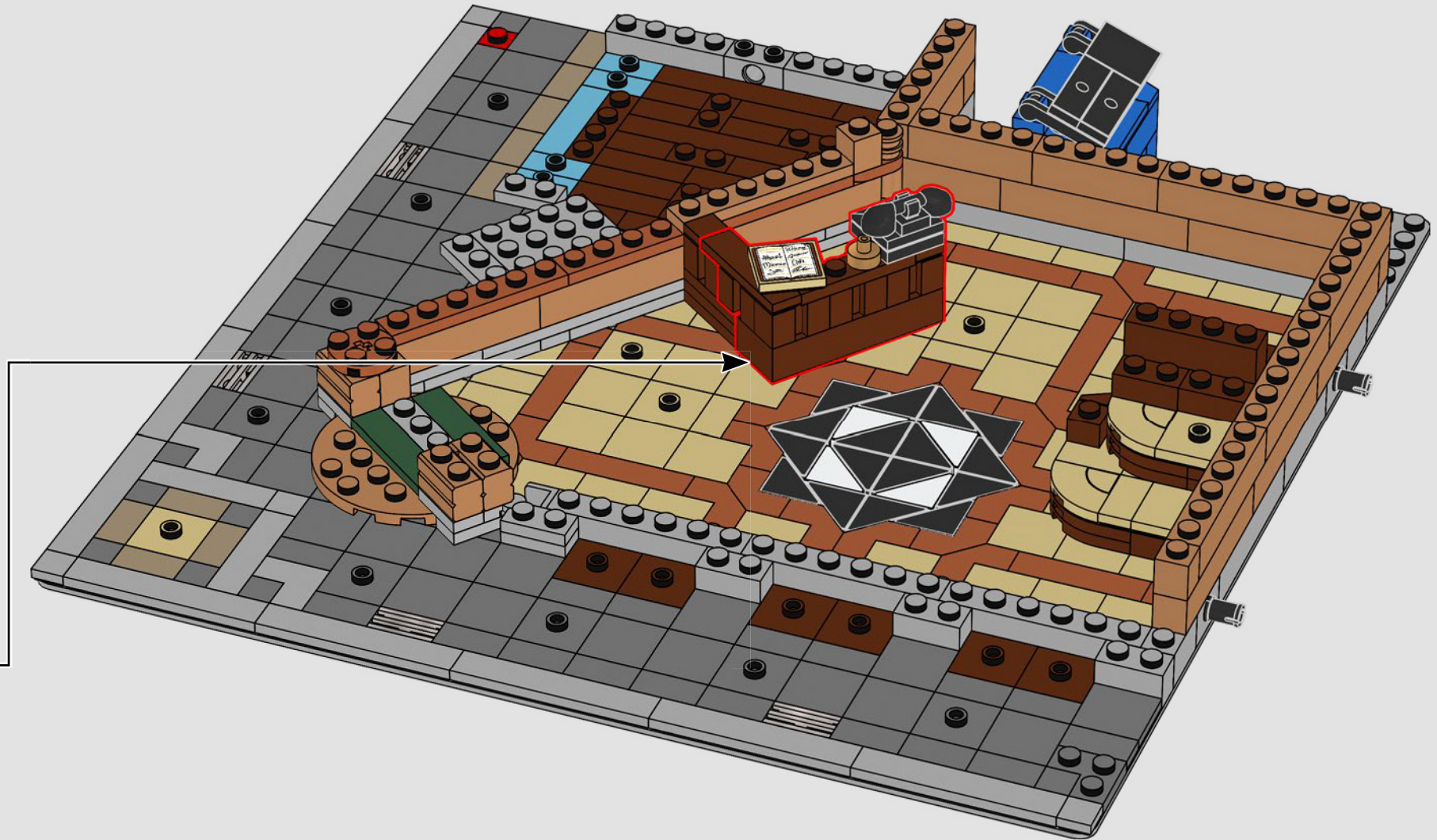

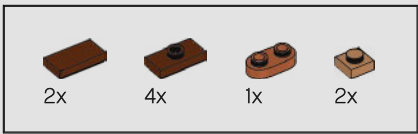

46

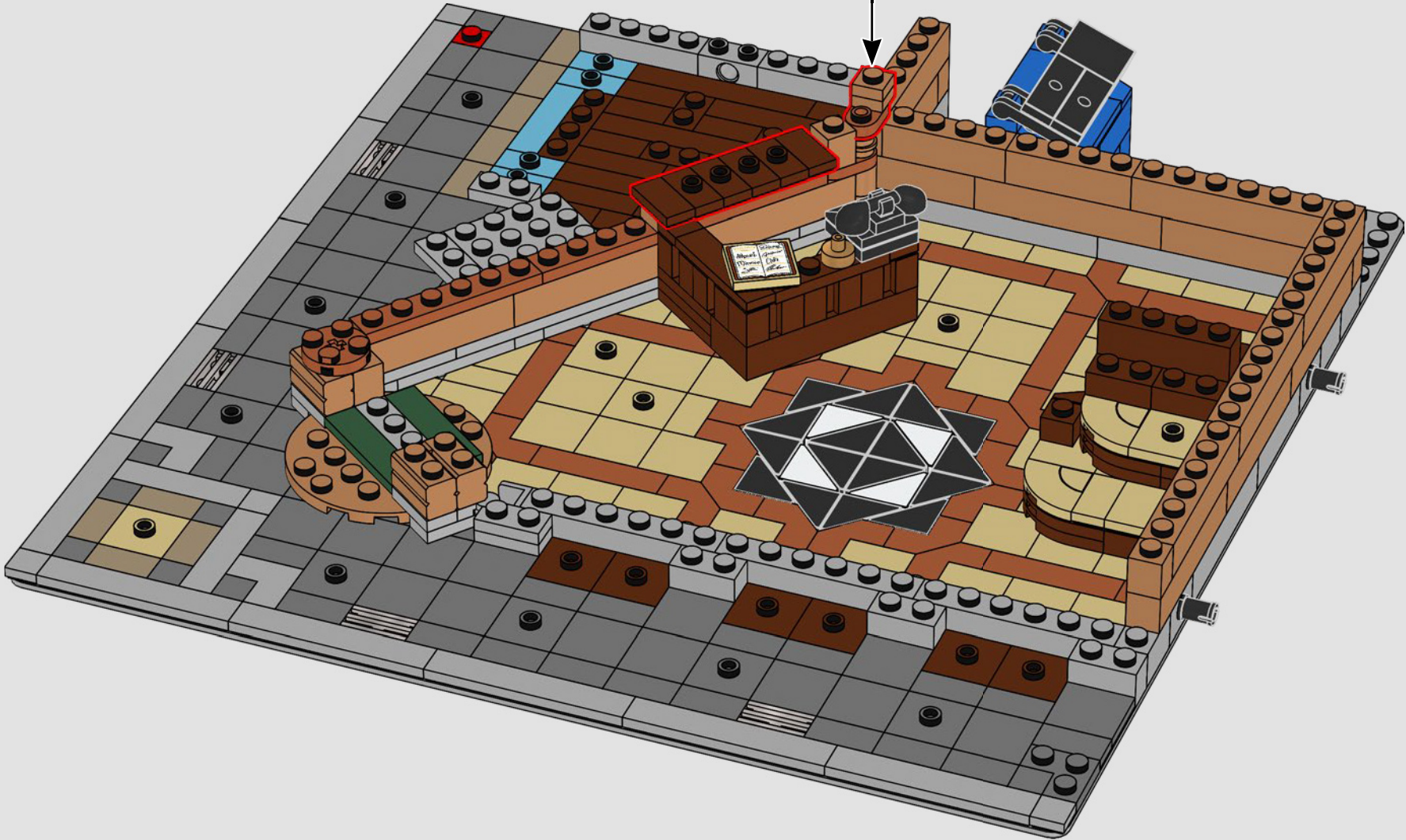
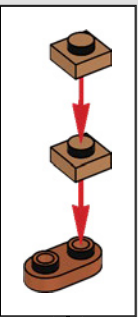



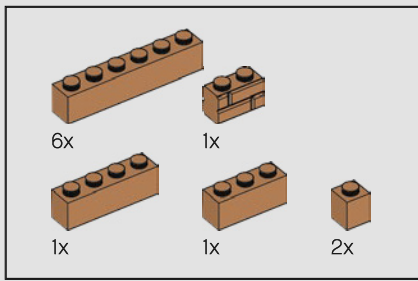

47

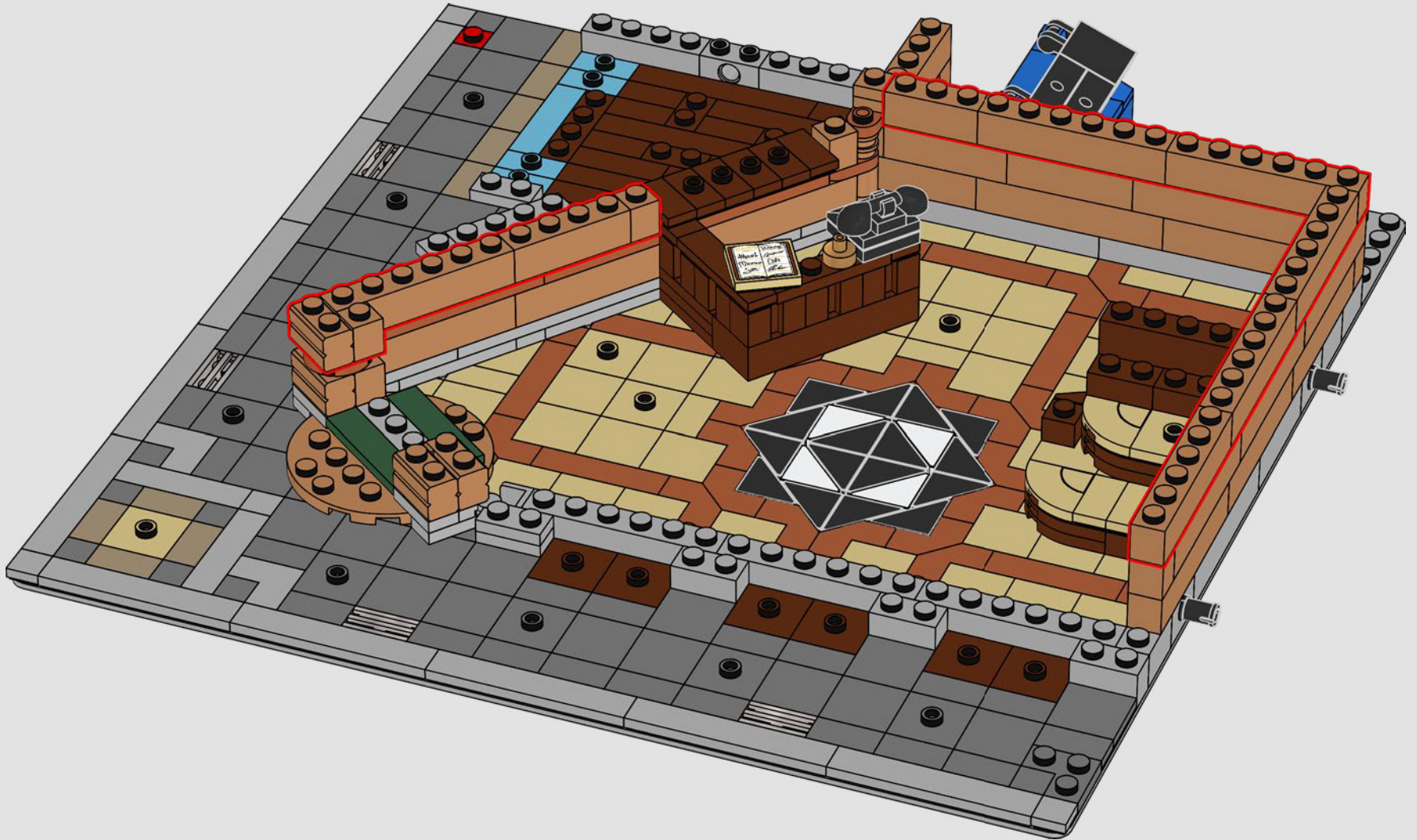

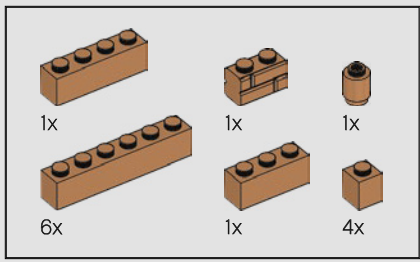

48

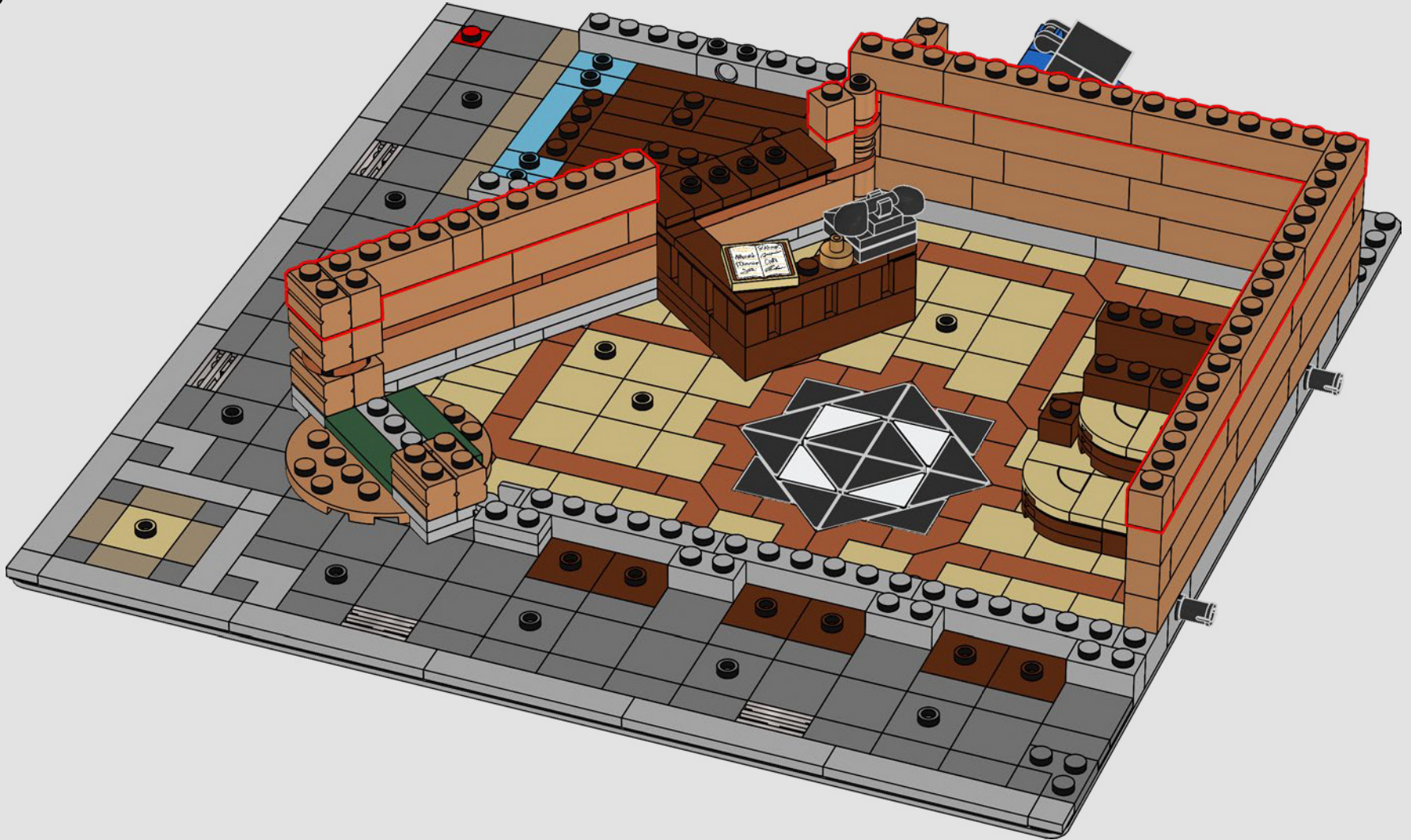

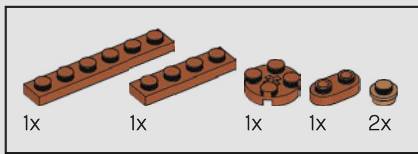

49

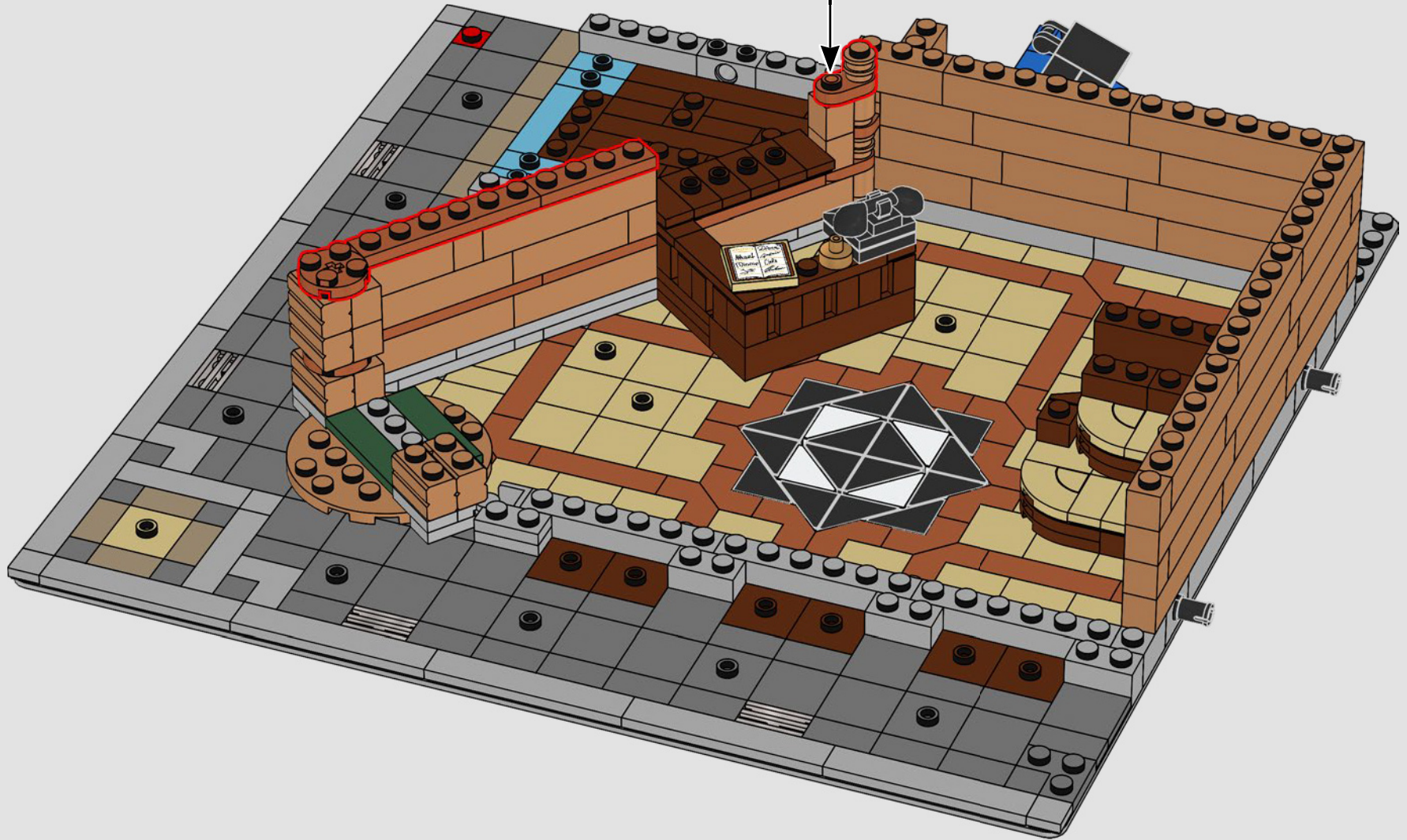
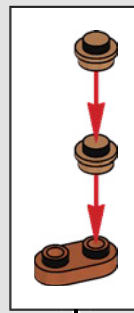

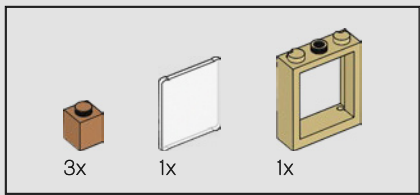

50

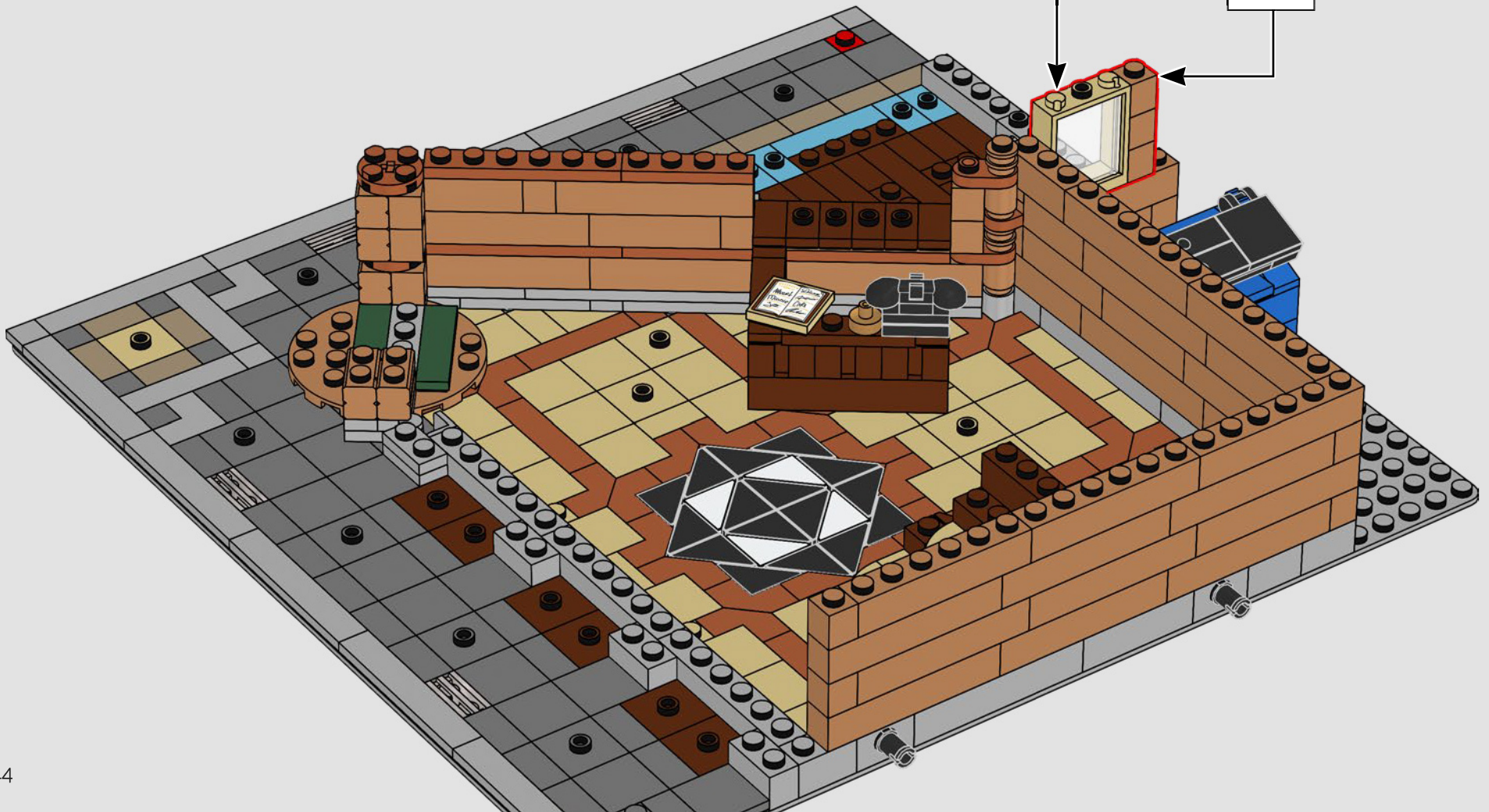
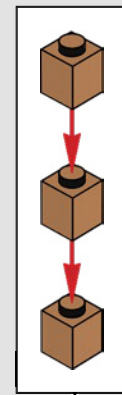
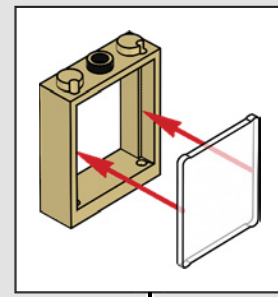

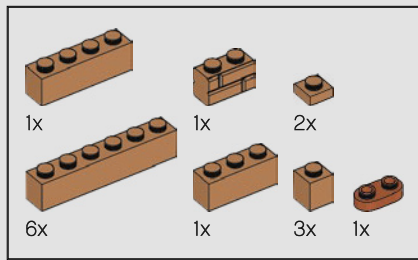

51

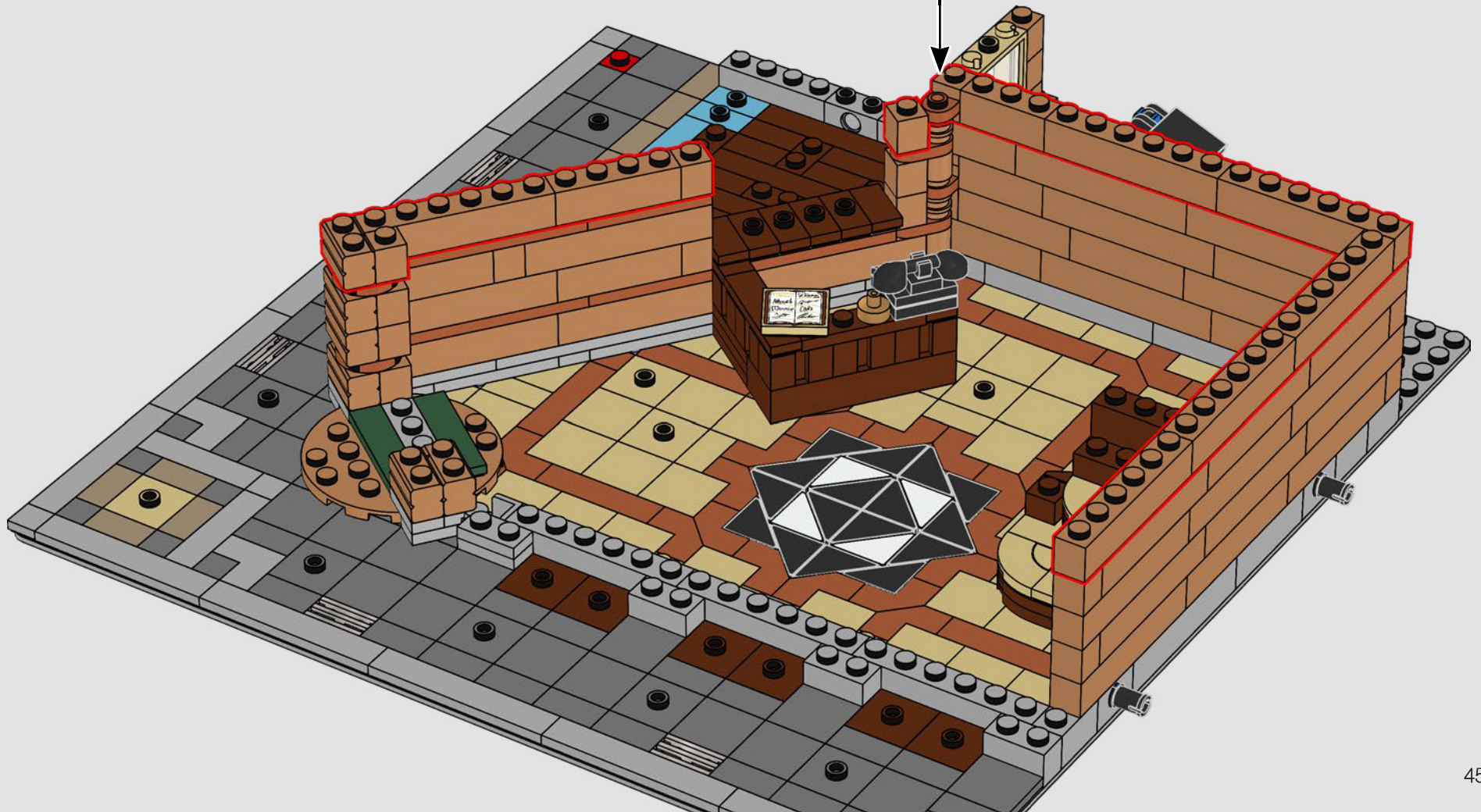
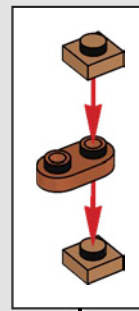

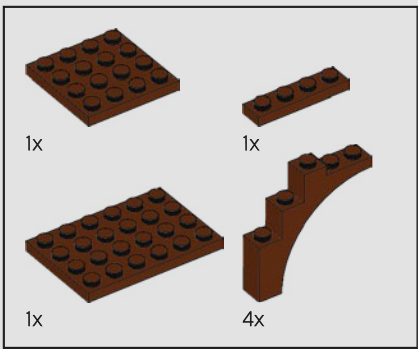

52

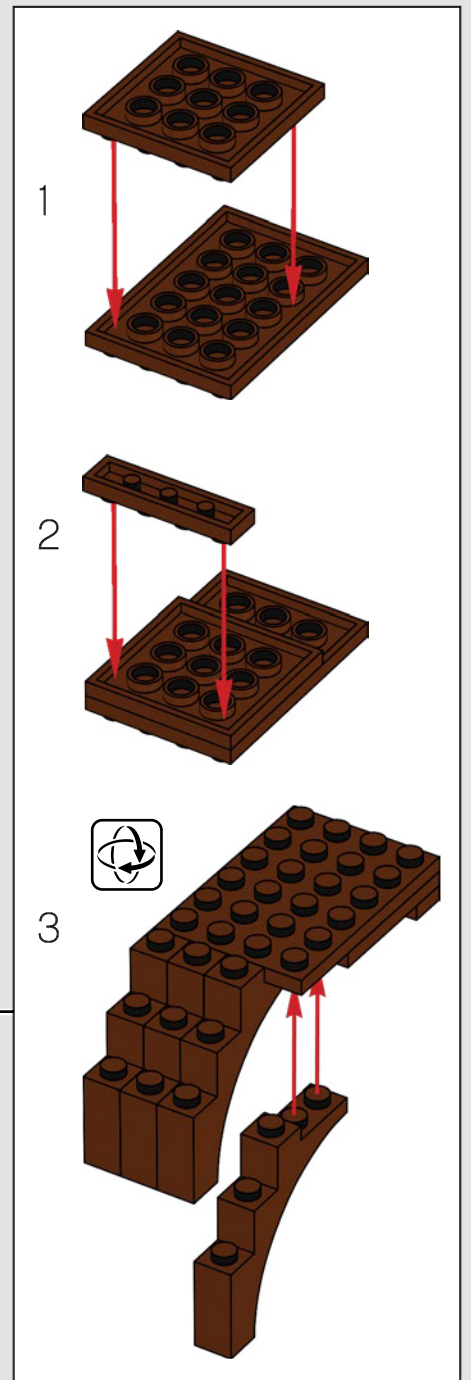
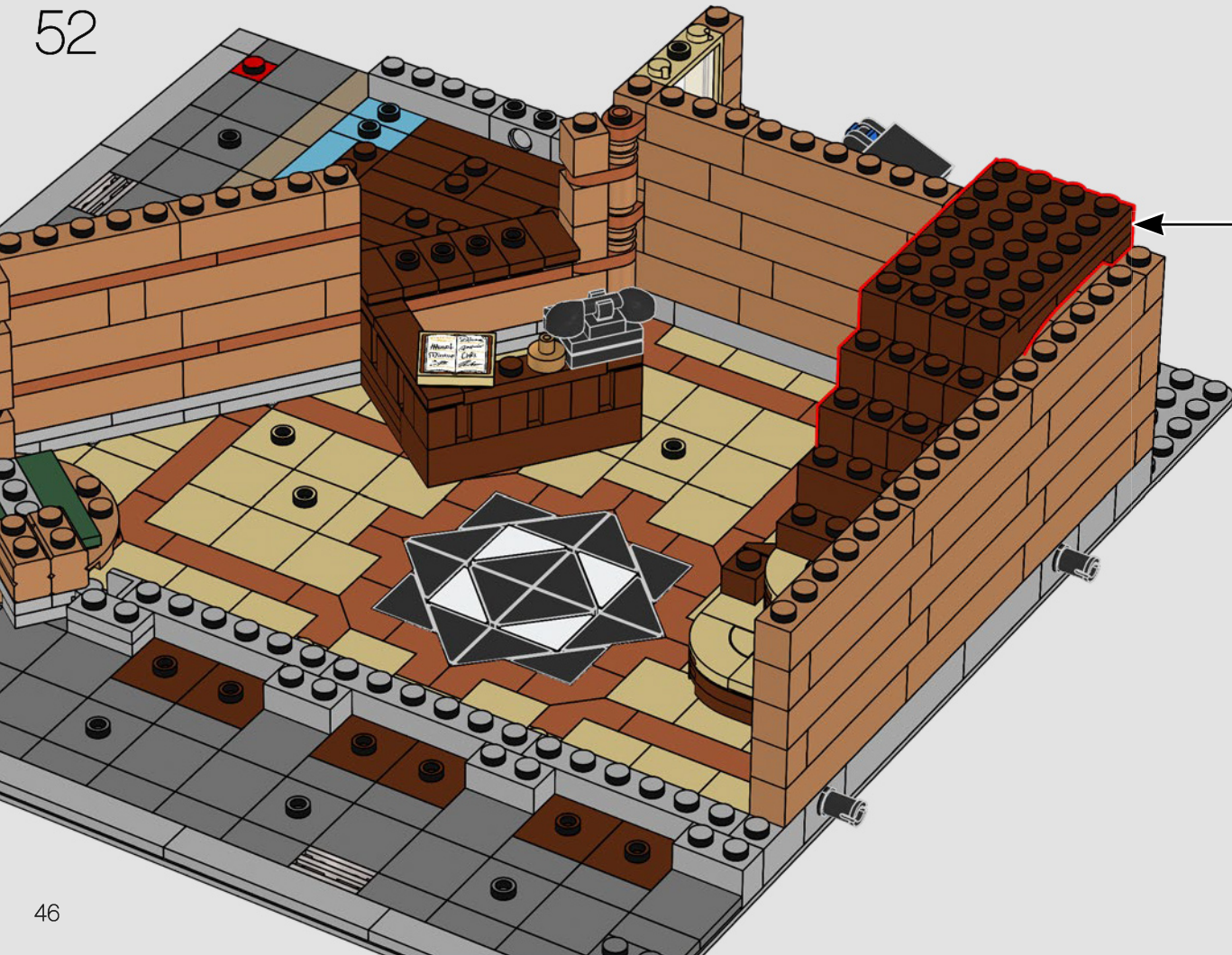

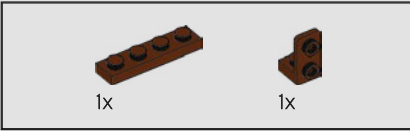

53

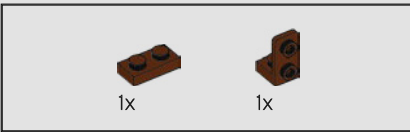
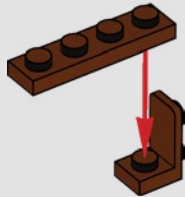

54

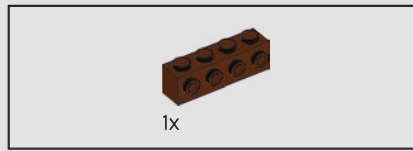
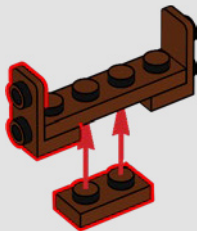

55

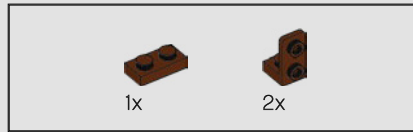
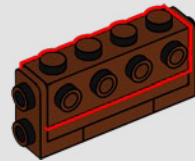

56

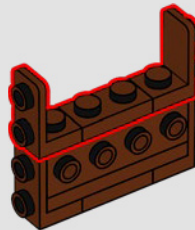

57

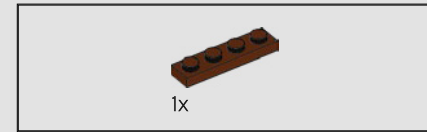
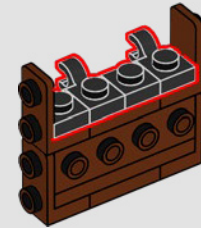

58

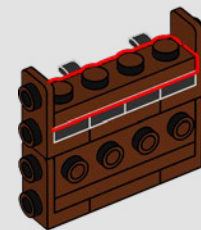



59

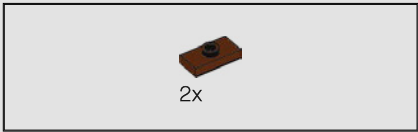
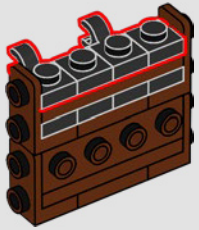

60

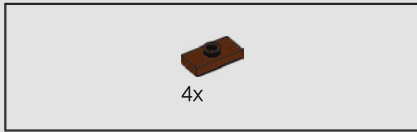
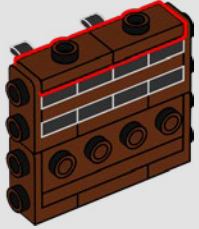

61

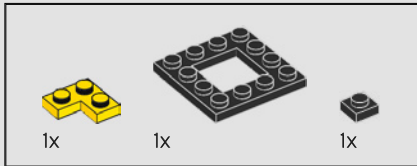
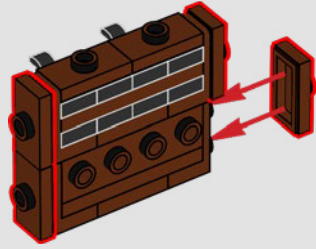

62

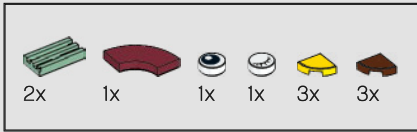
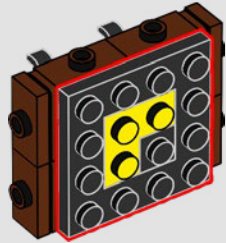

63

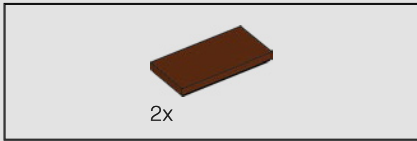
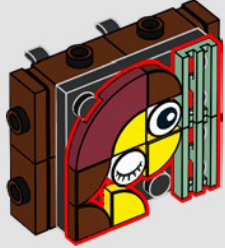

64

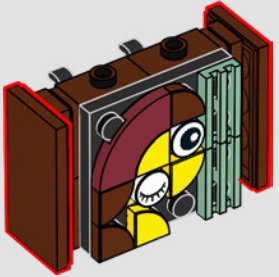



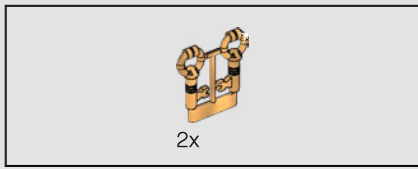

65

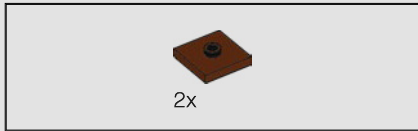
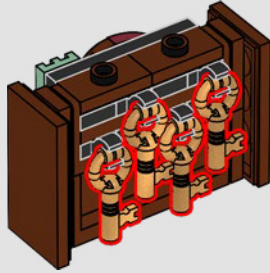

66

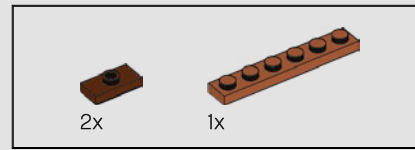
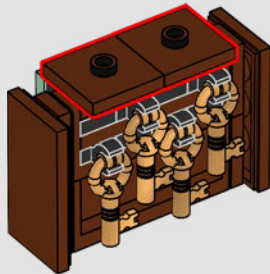

67

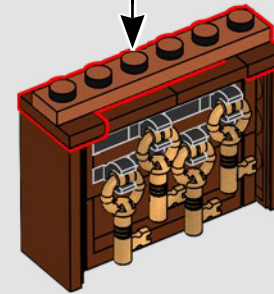
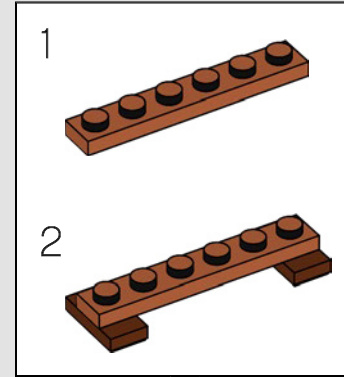

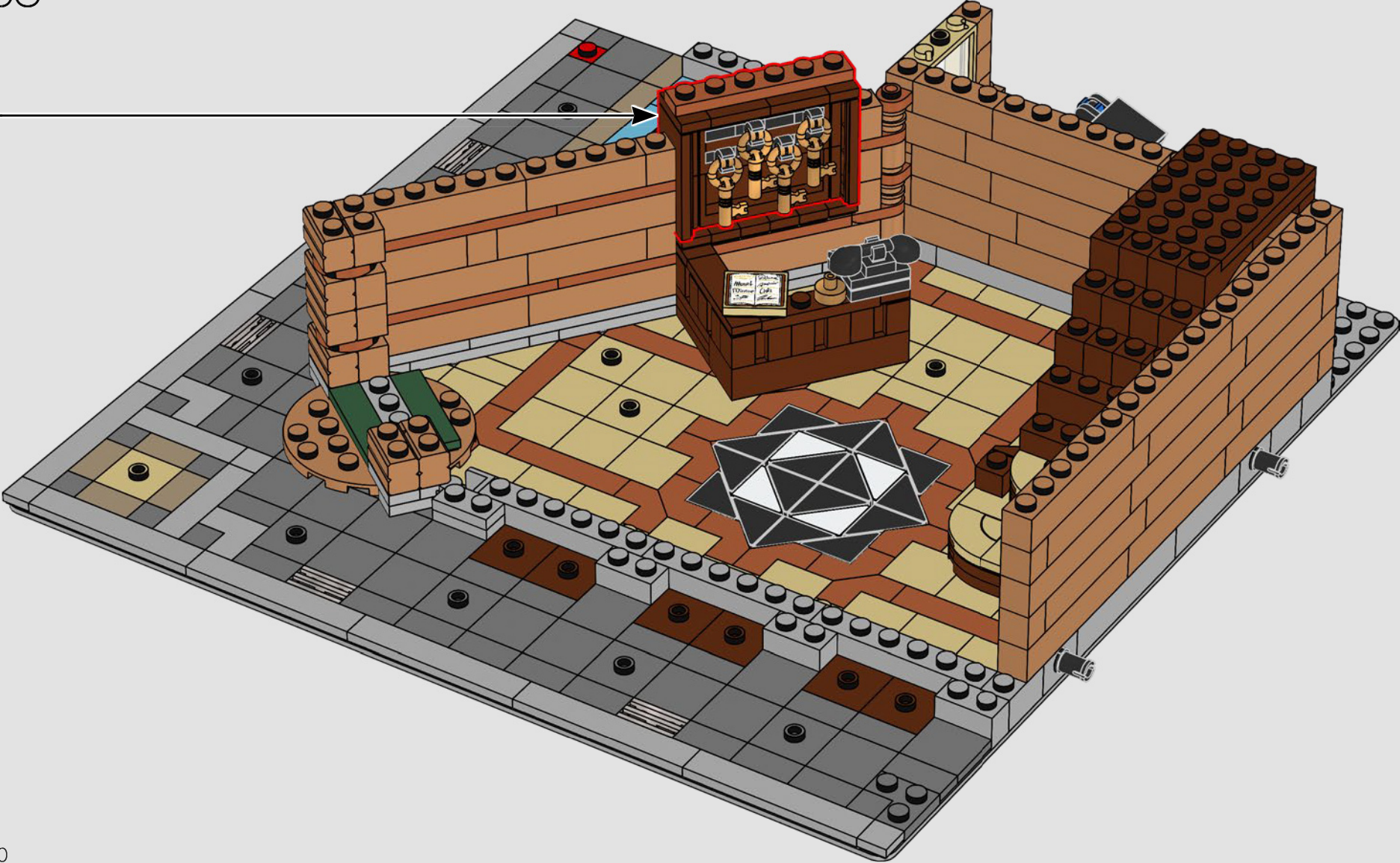

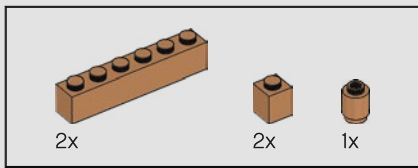

69

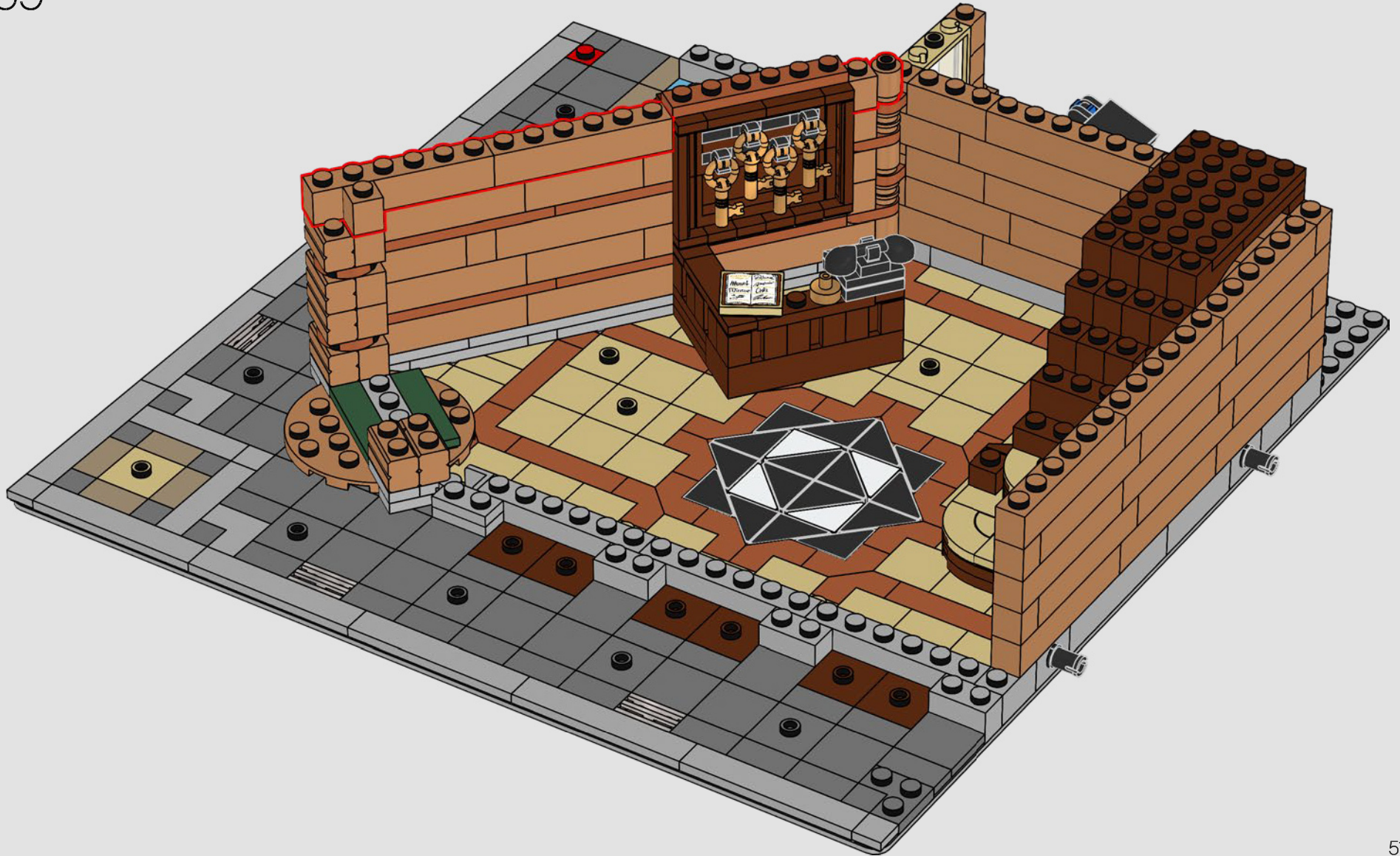

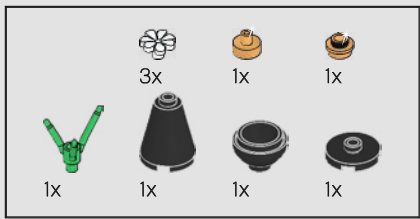

70

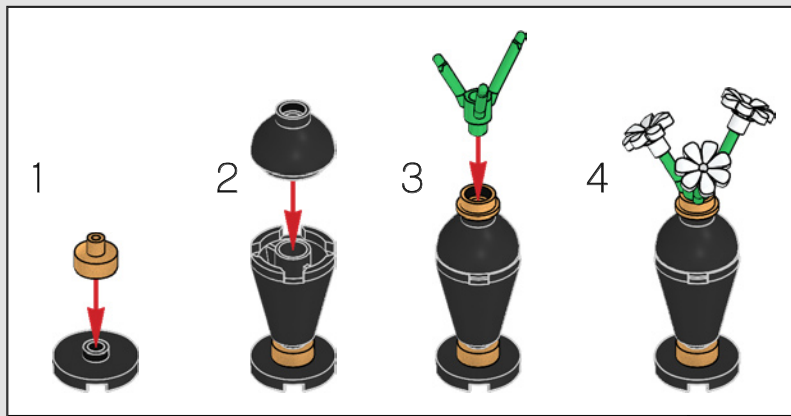

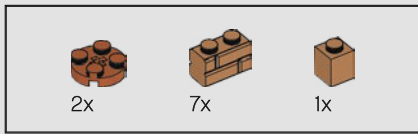

71

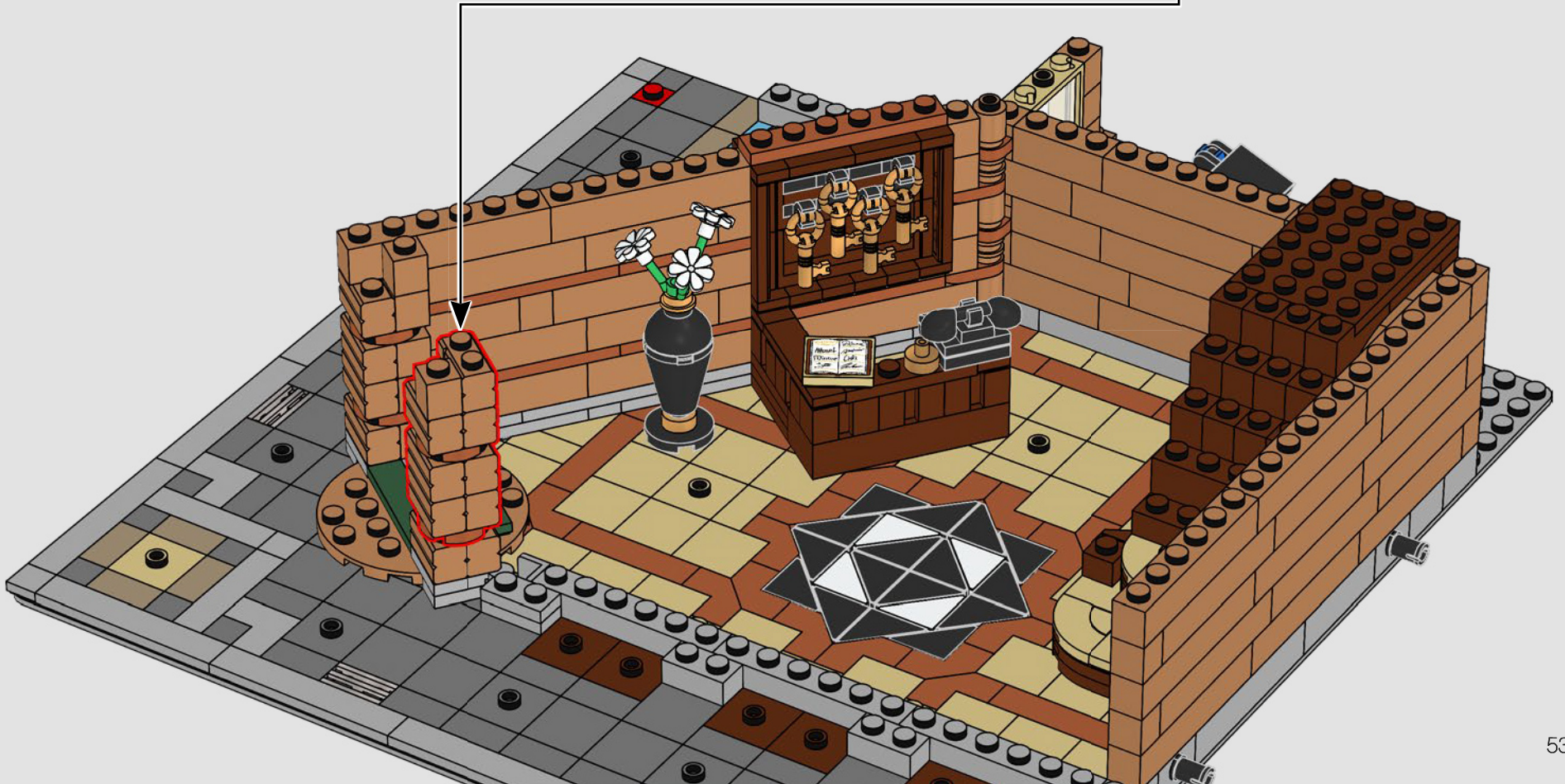
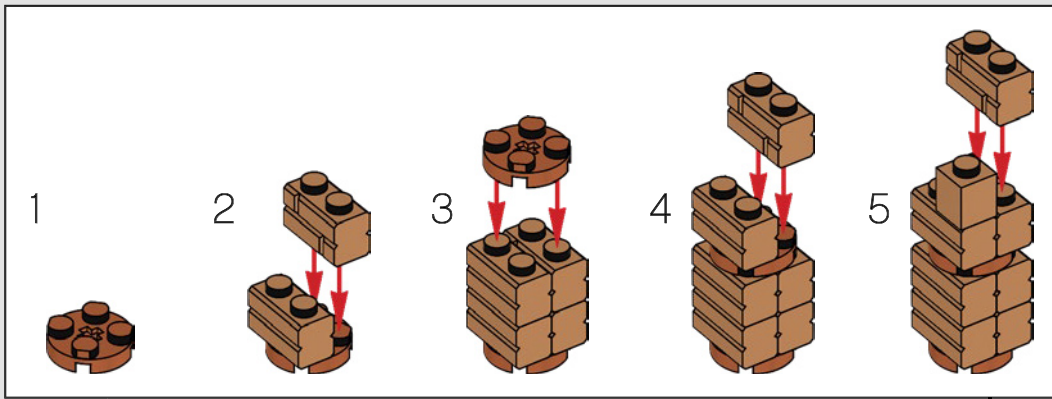

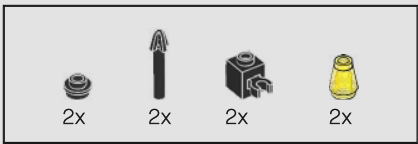

72

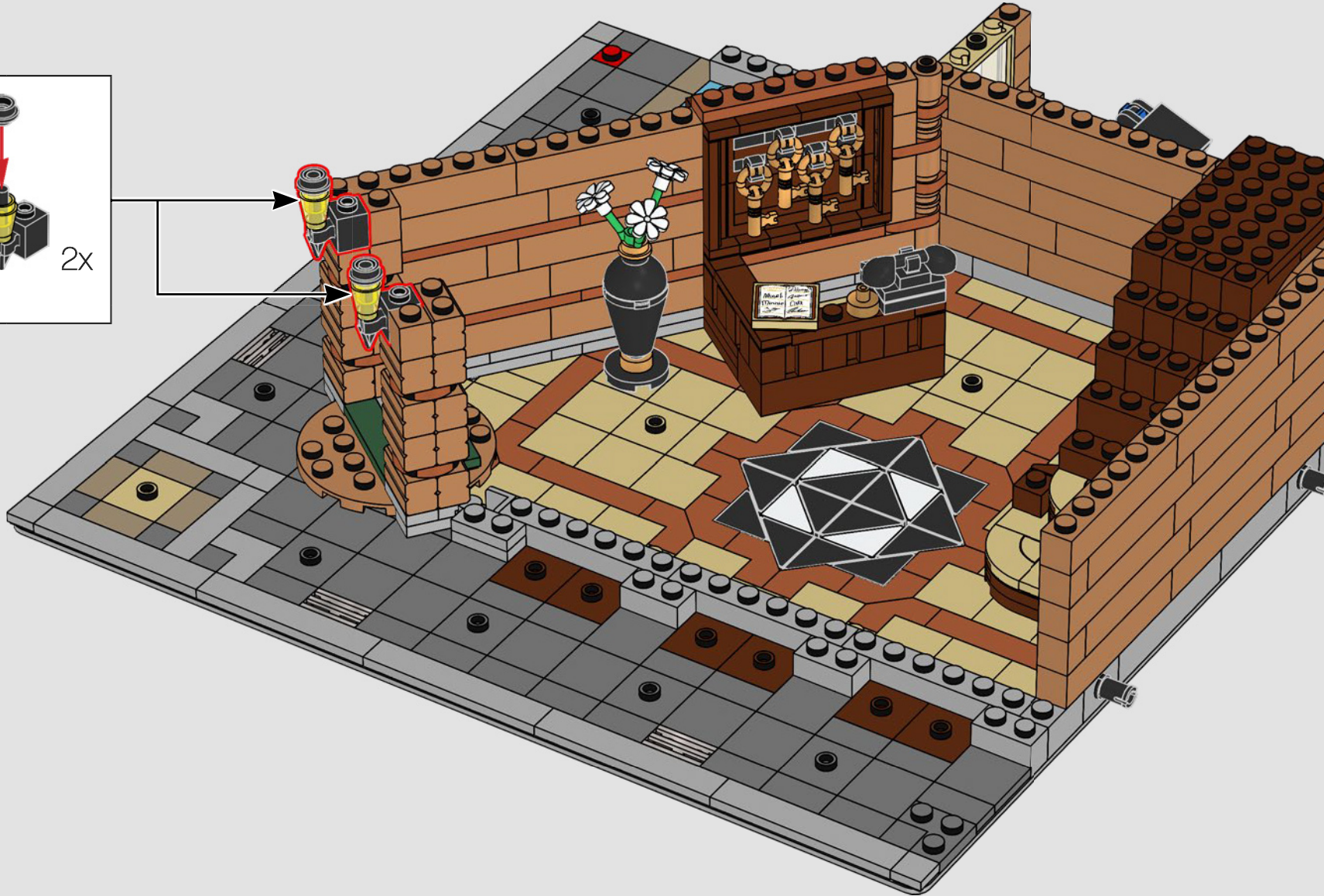
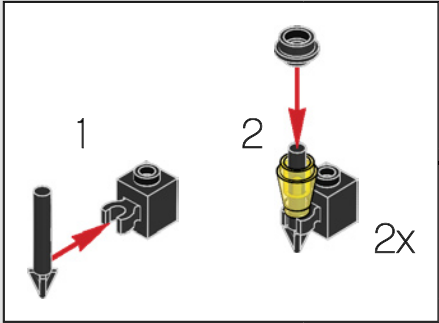

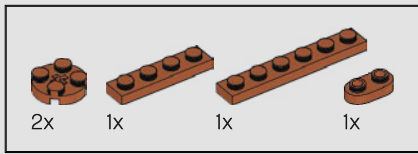

73

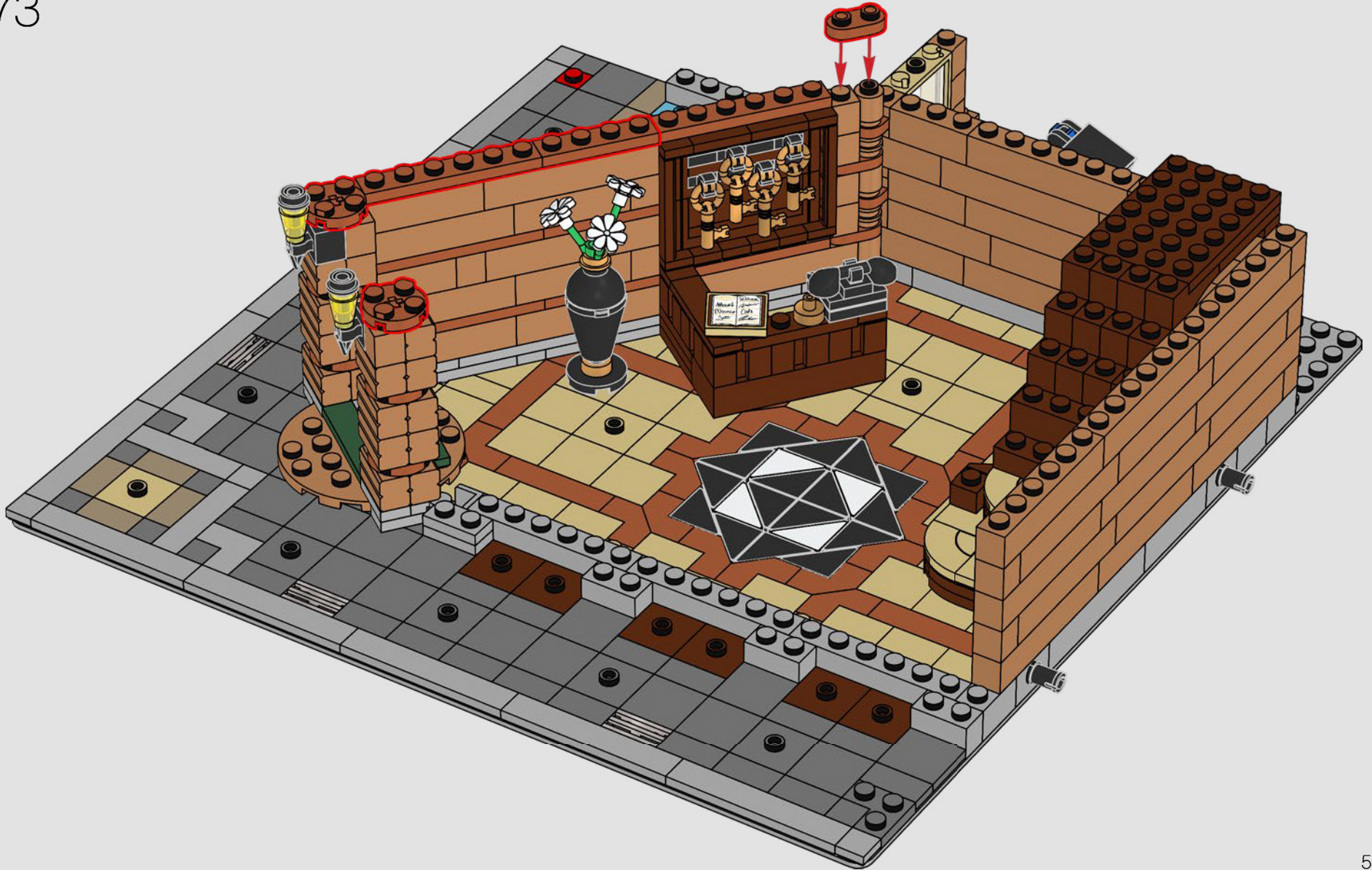

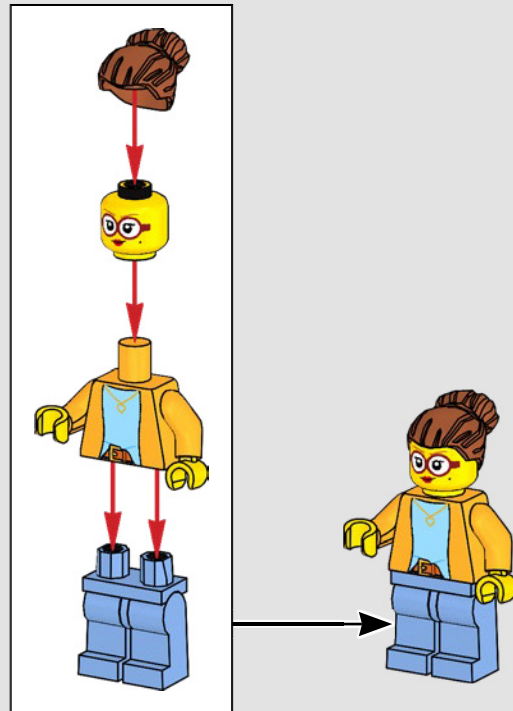



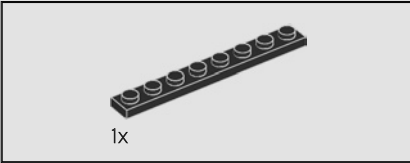
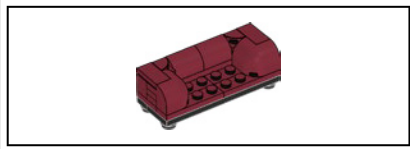

74

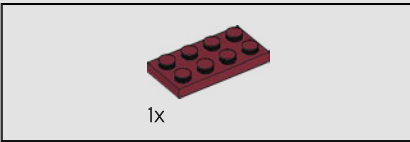
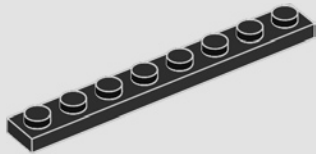

75

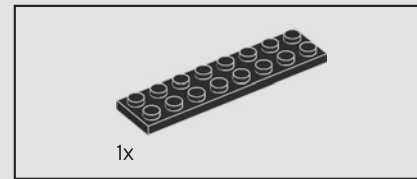
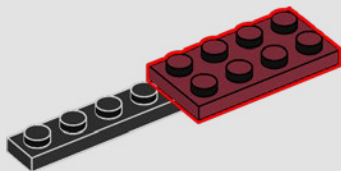

76

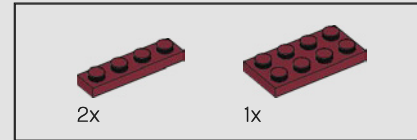
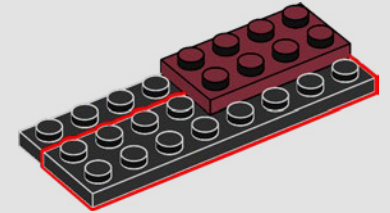

77

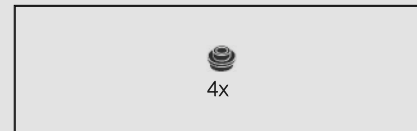
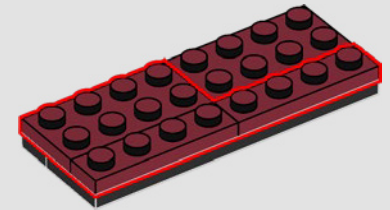

78

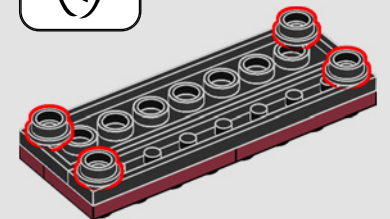
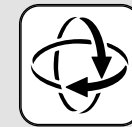

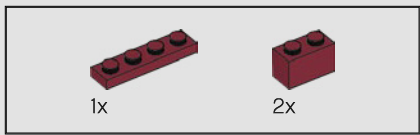

79

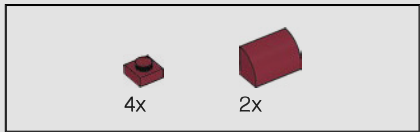
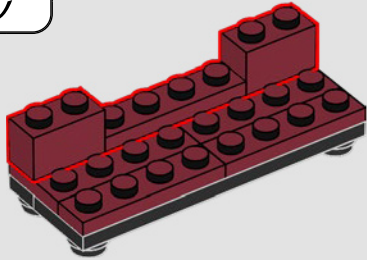

80

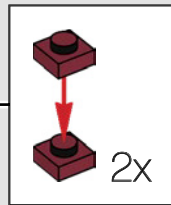
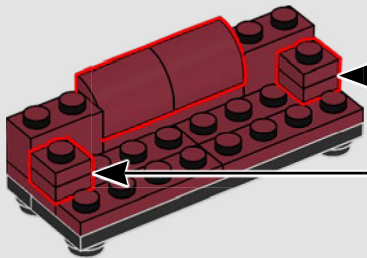

81

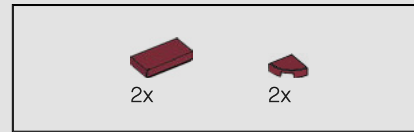
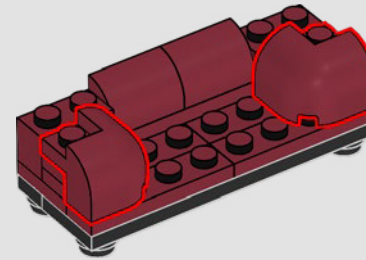

82

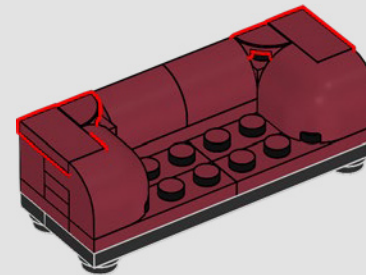



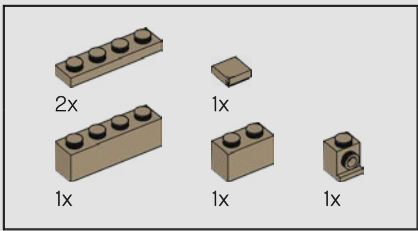

84

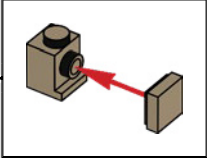
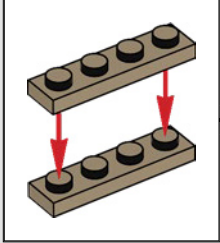
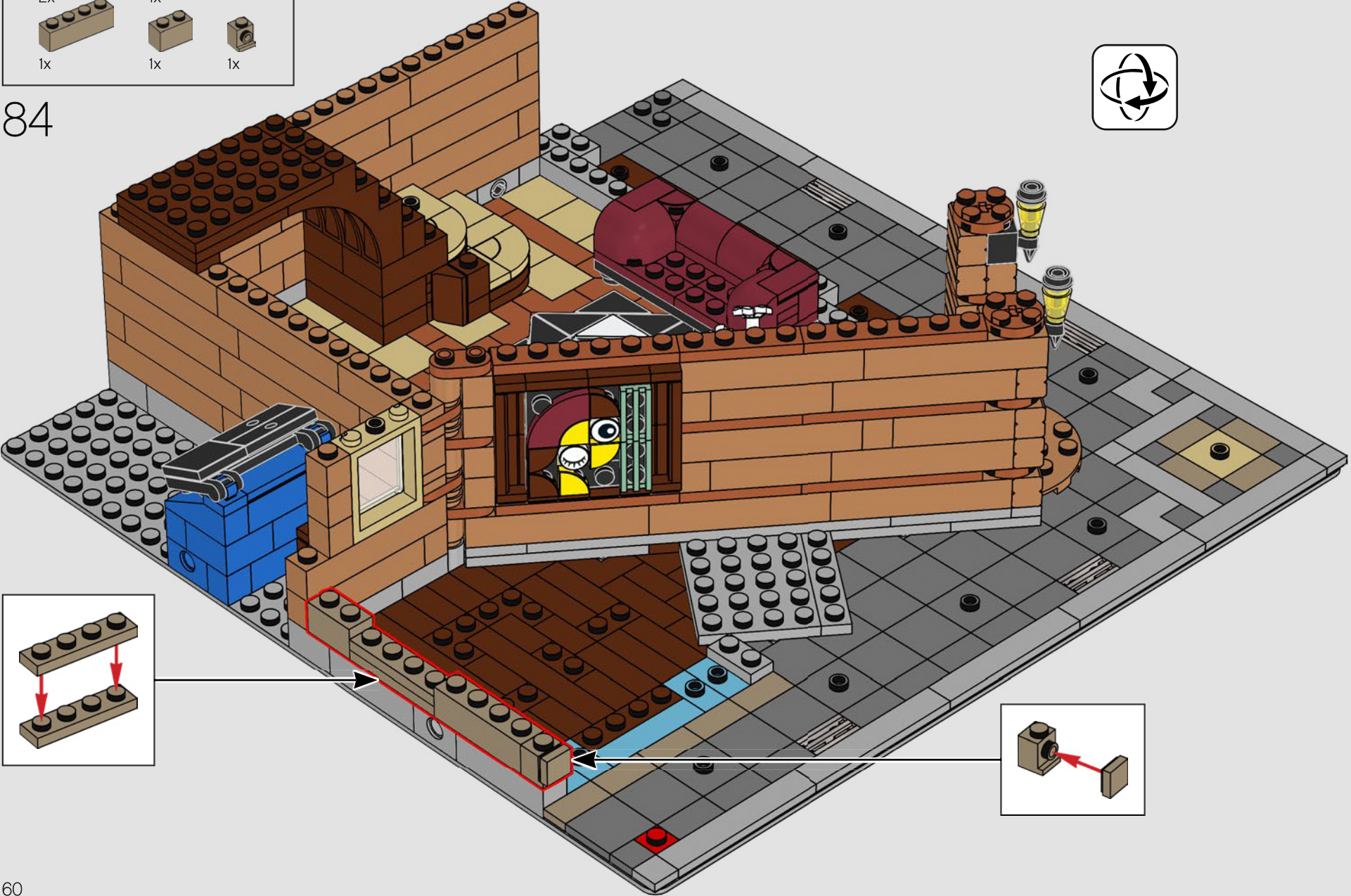

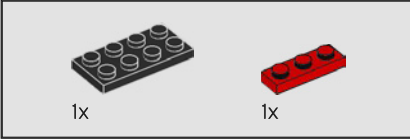

85

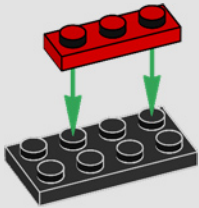

86

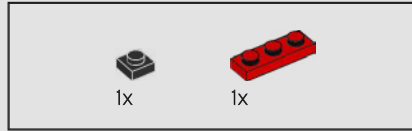
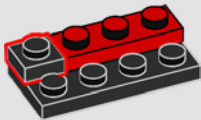

87

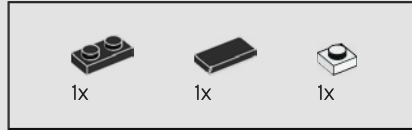
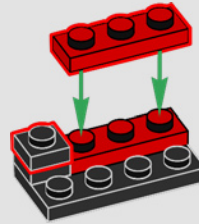

88

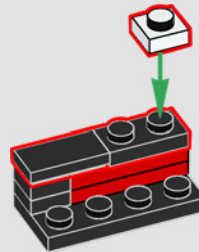

89

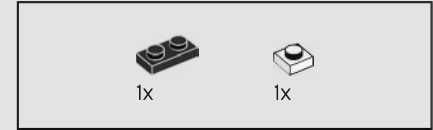
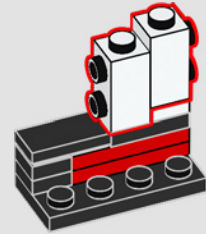

90

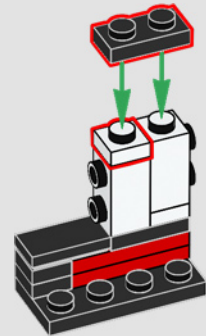



91

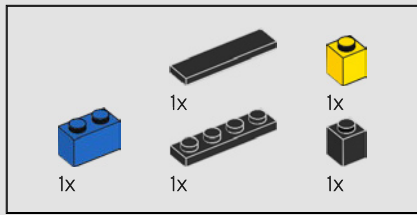
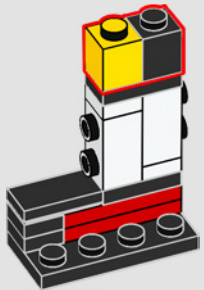

92

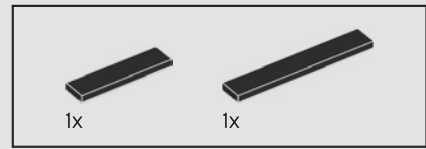
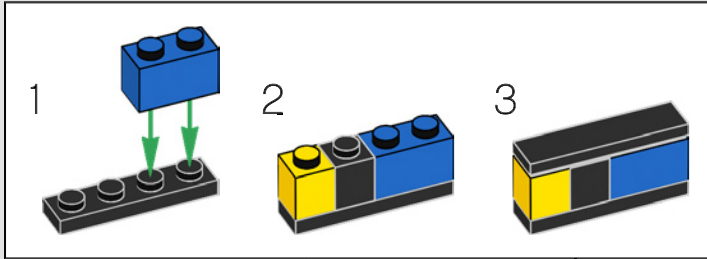

93

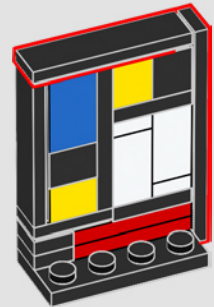

94

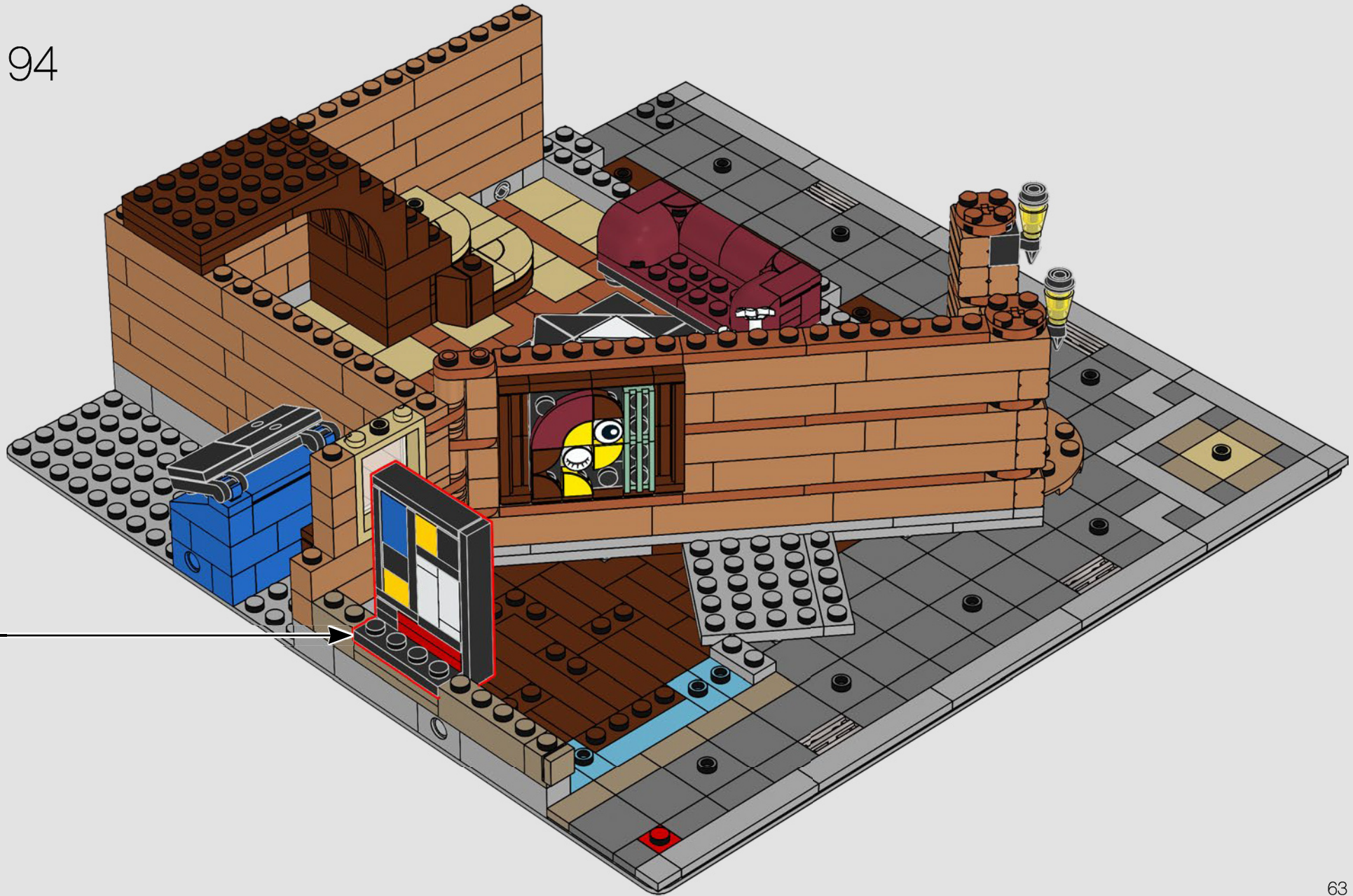

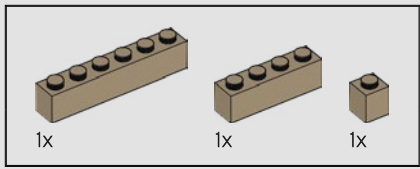

95

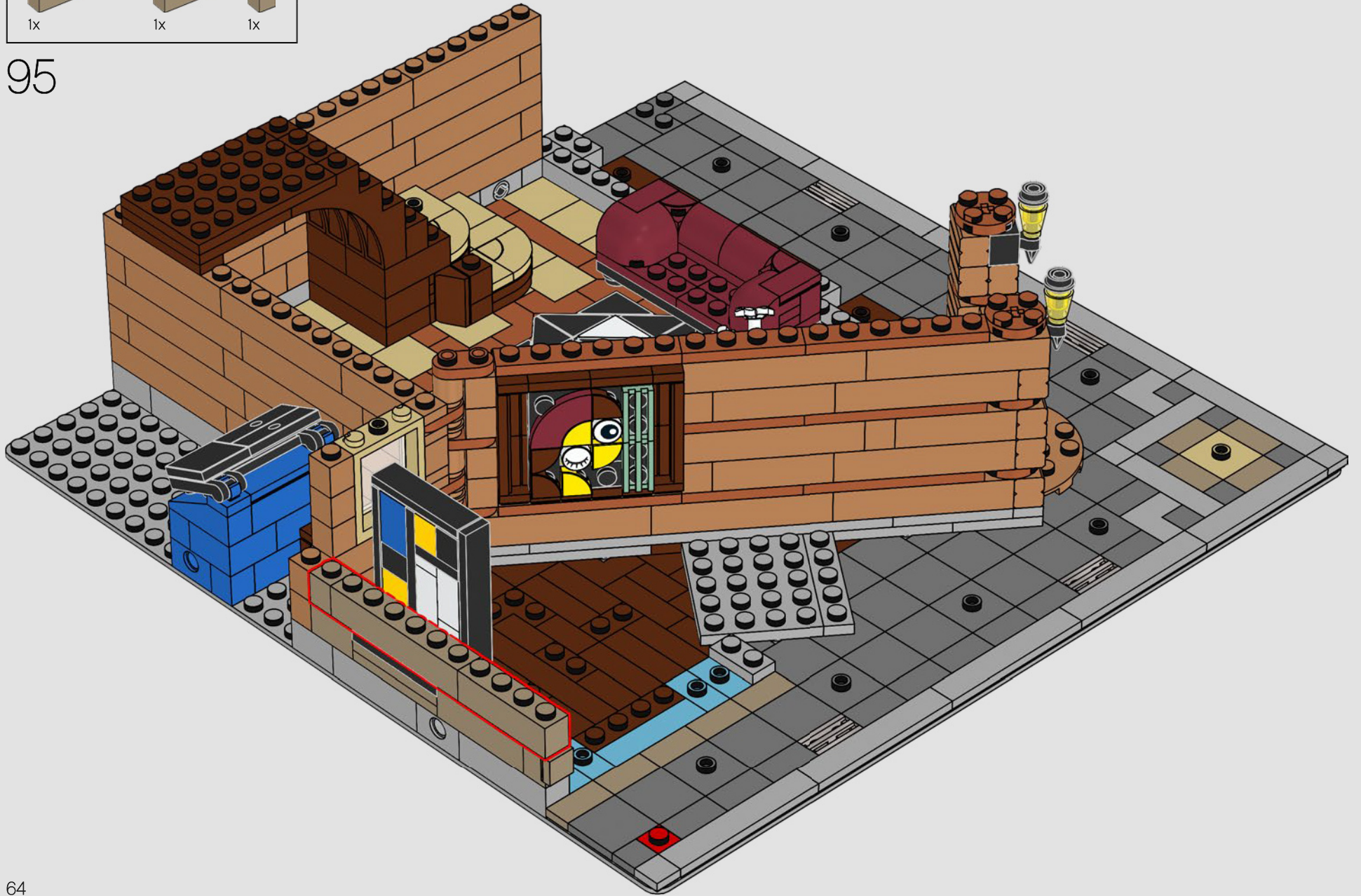



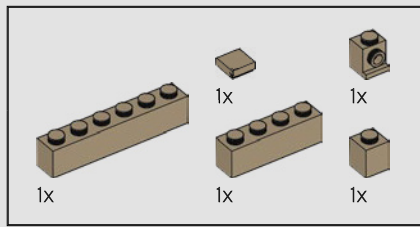

96

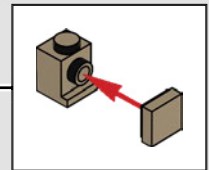
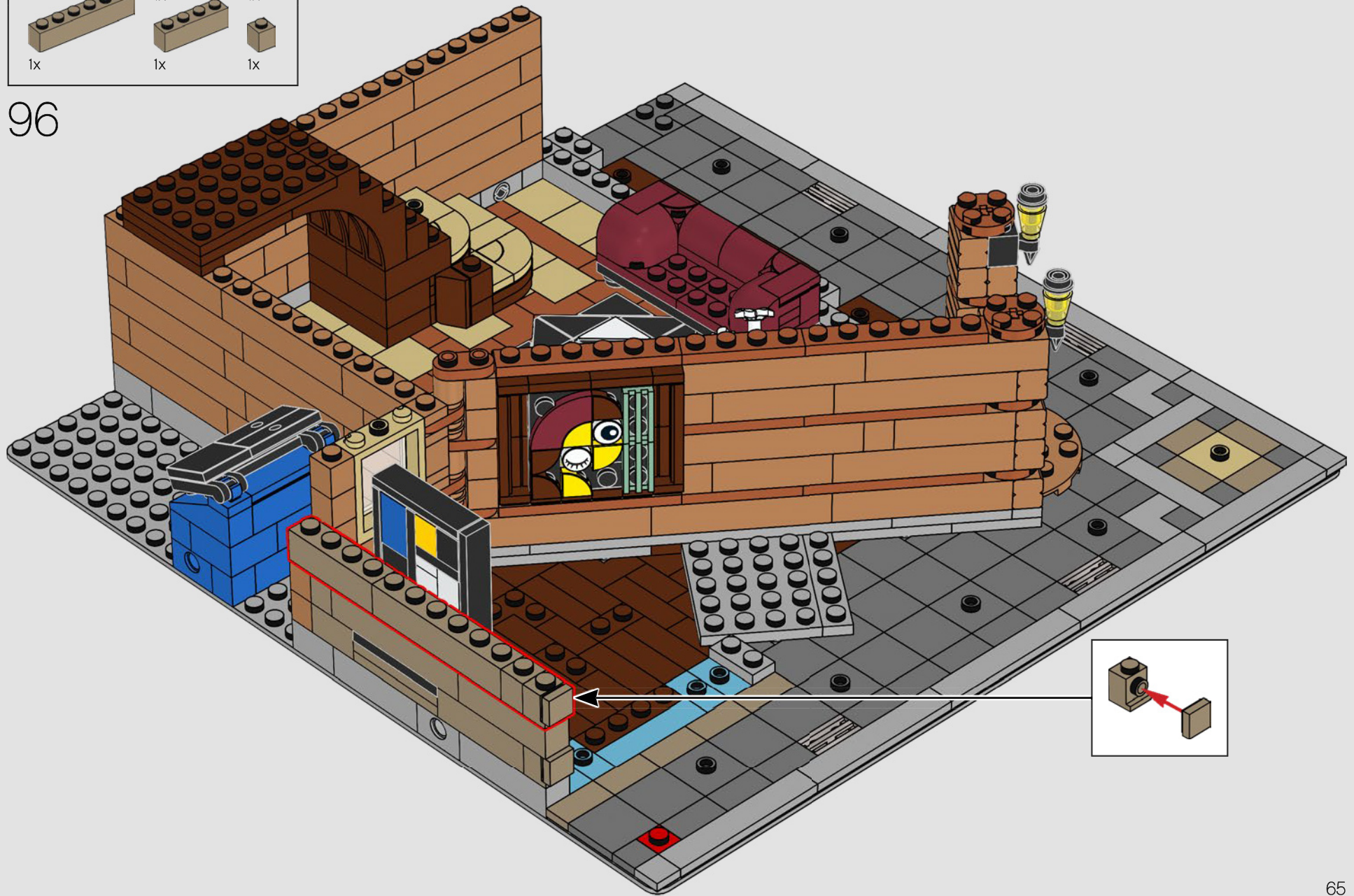

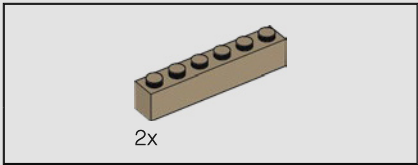

97

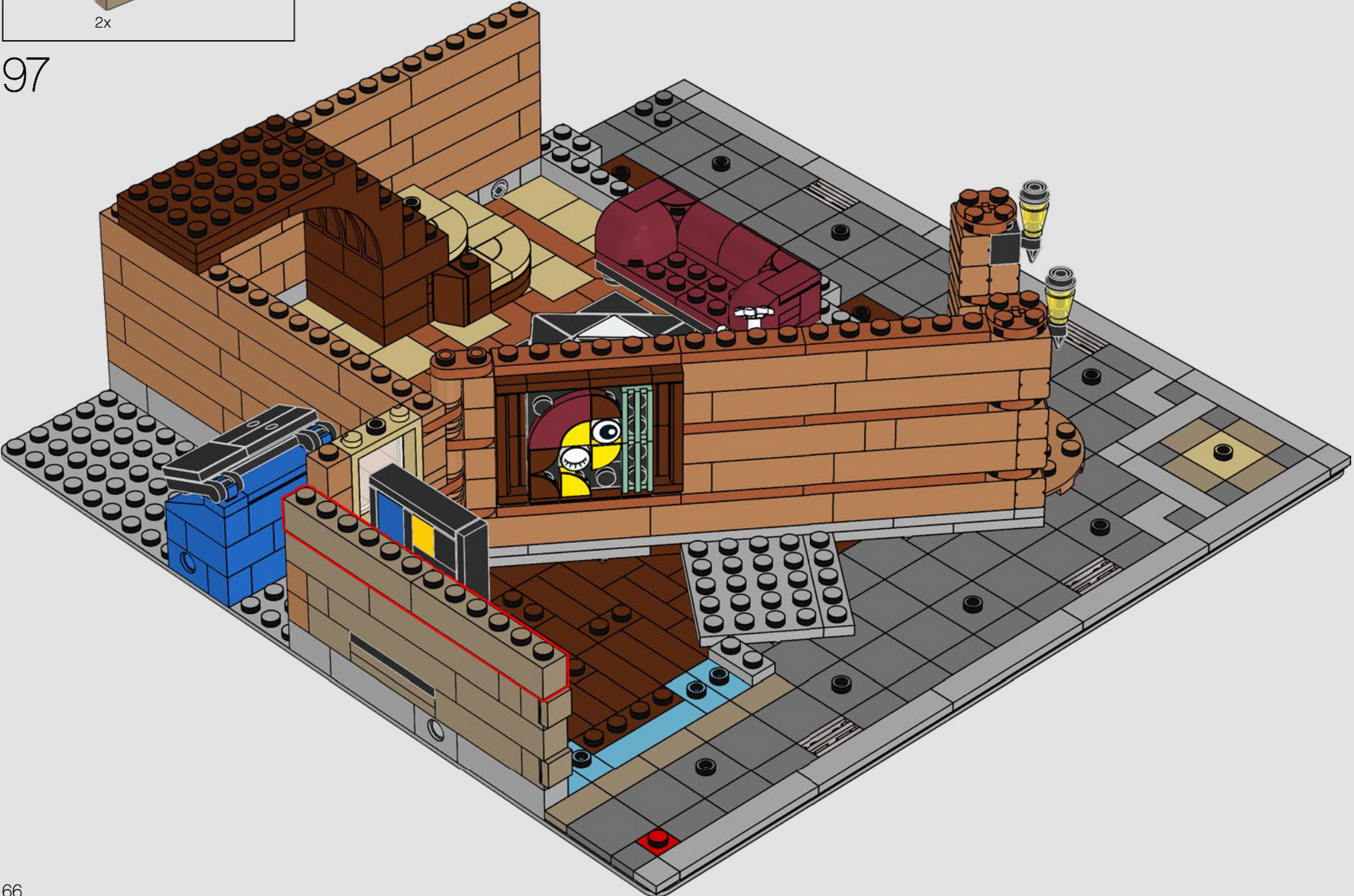

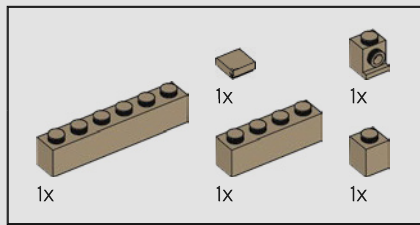

98

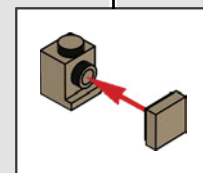
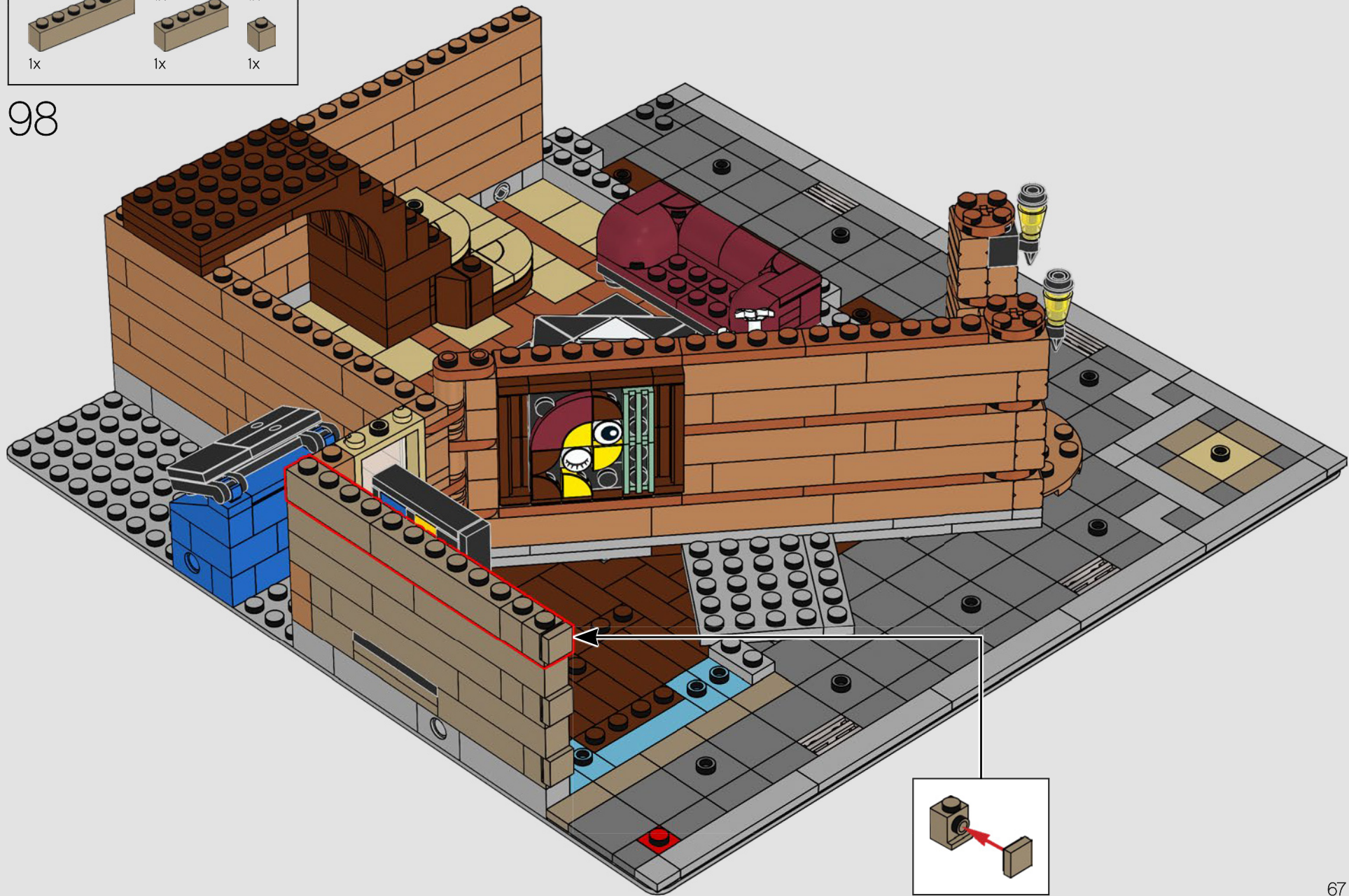

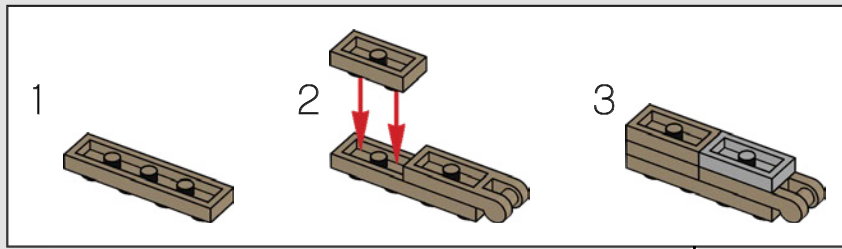
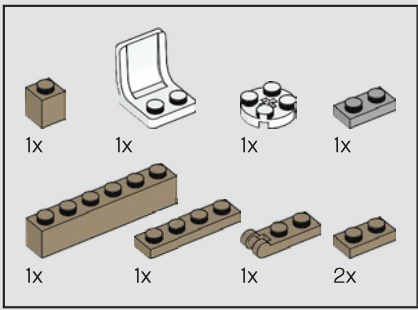

99



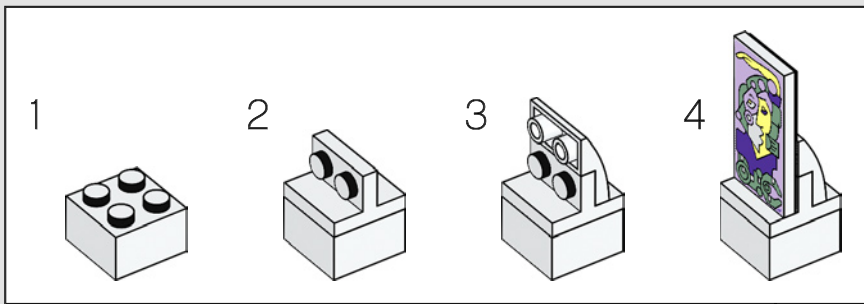
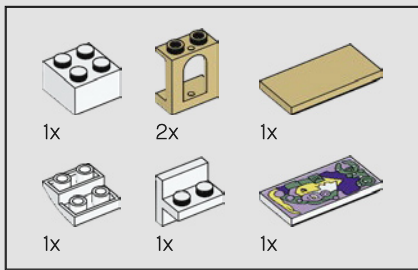

100

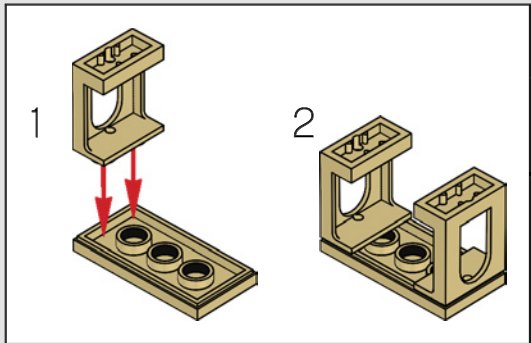

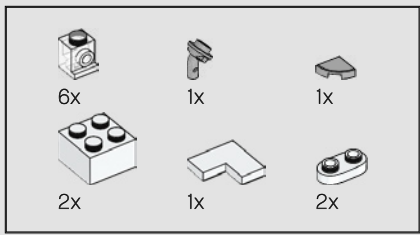

101

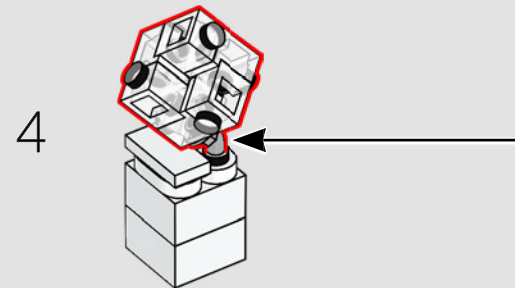
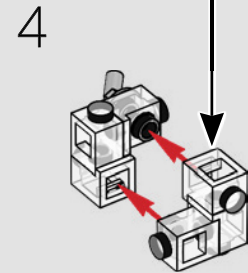
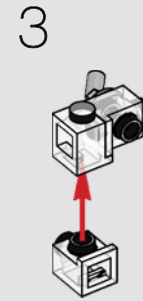
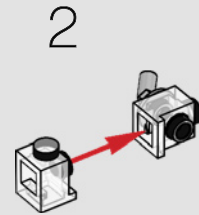
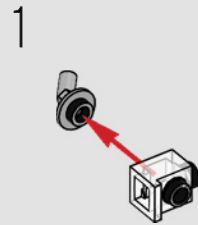
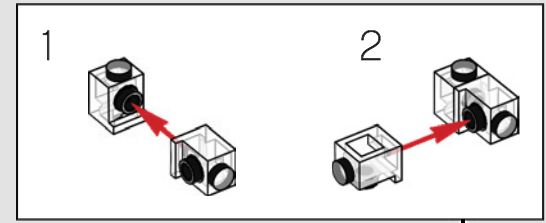
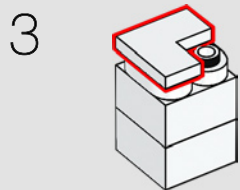
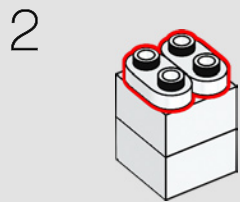
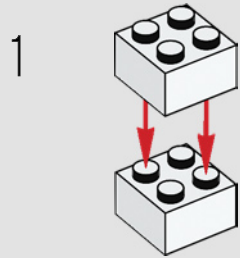

The Gallery Owner is very excited to debut her collection of Cubist Art! Her favourite piece, though, isn't Cubist – it's just an expertly made cube.

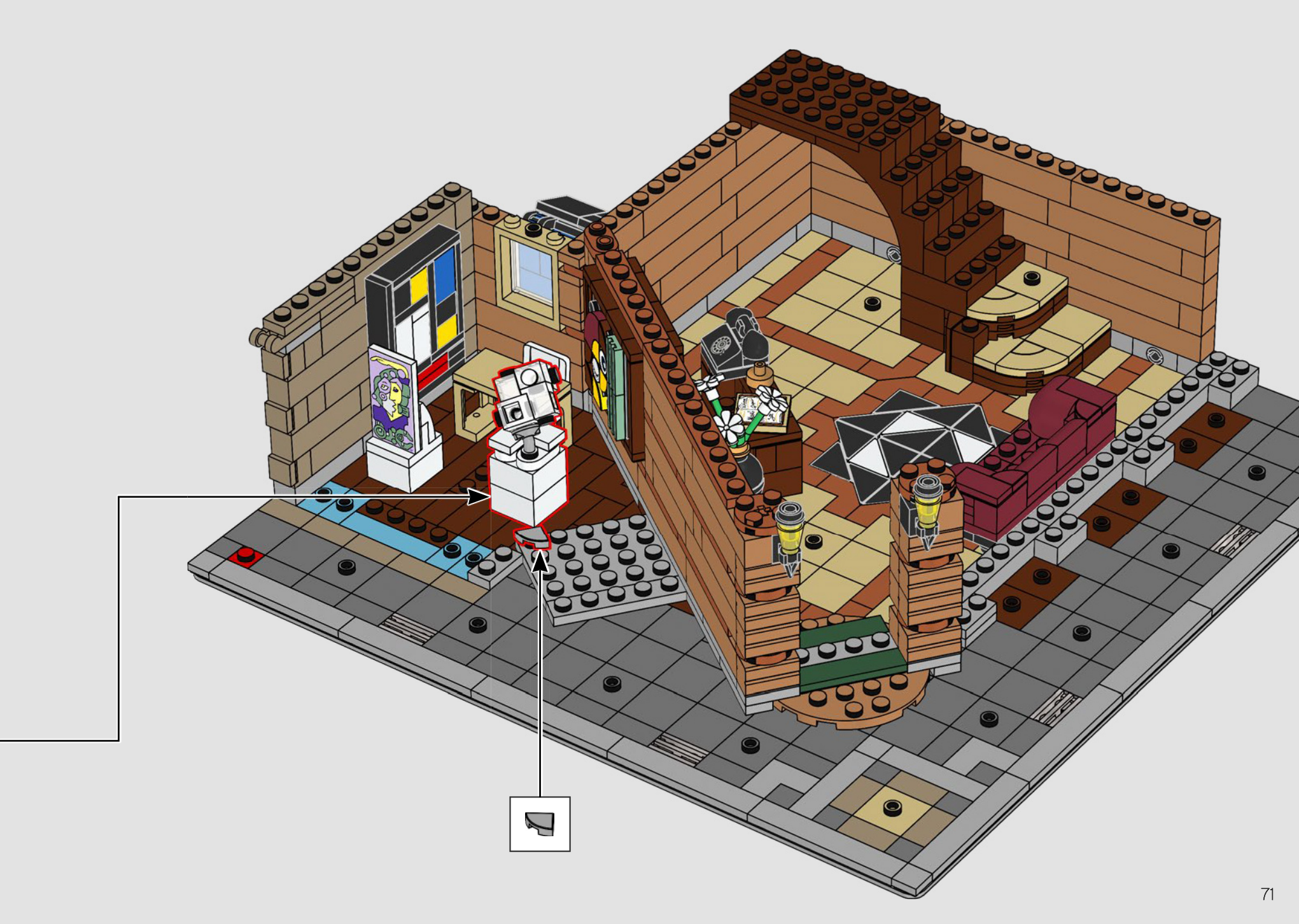

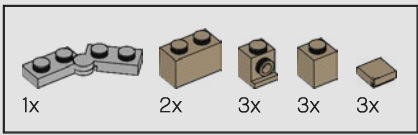

102

1

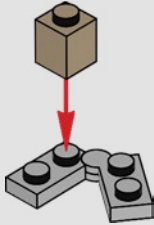

2

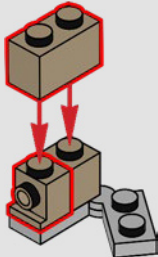

3

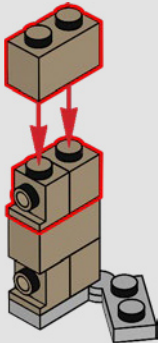

4

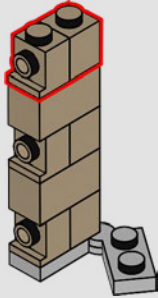

5

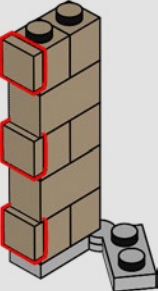



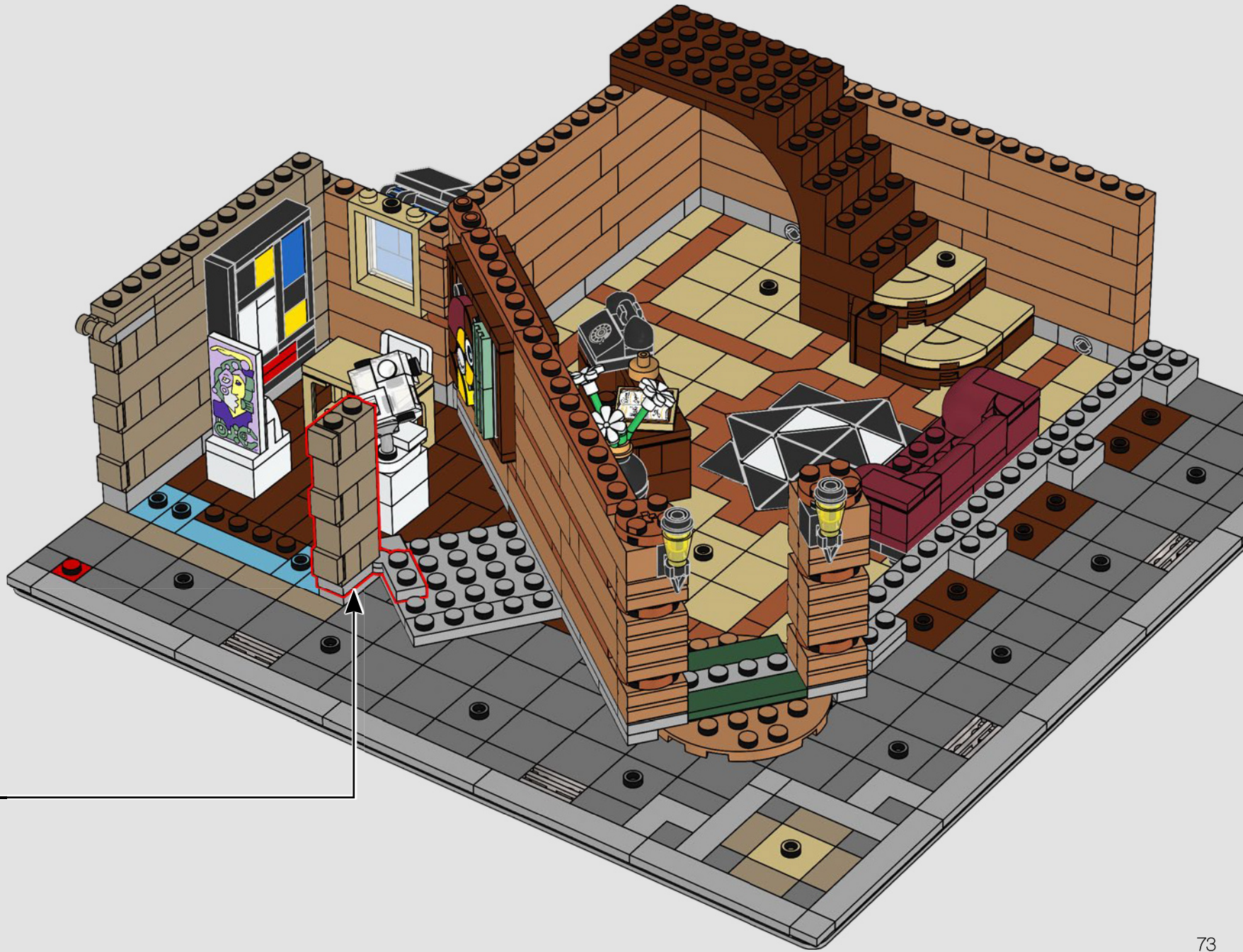

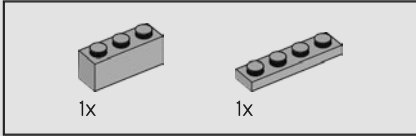
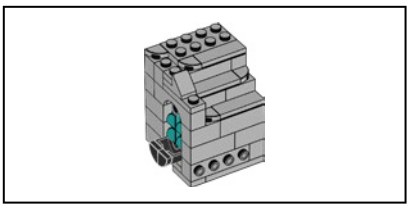

103

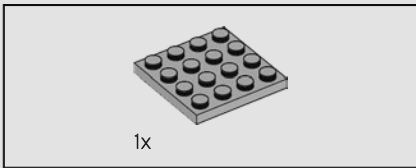
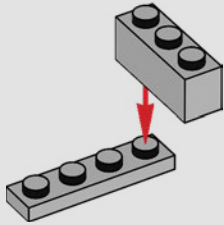

104

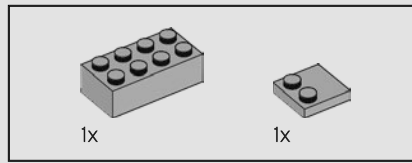
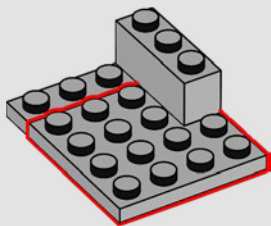

105

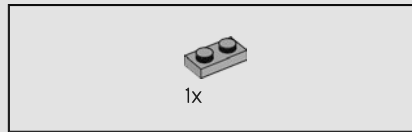
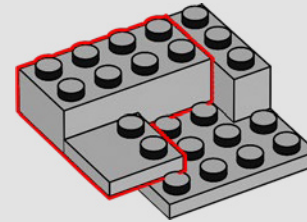

106

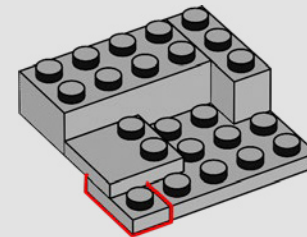

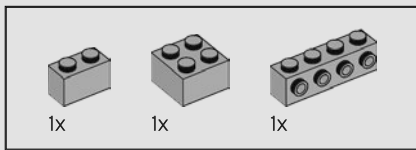

107

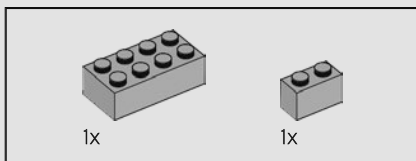
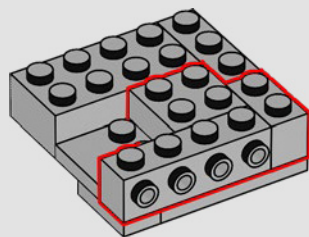

108

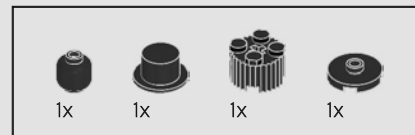
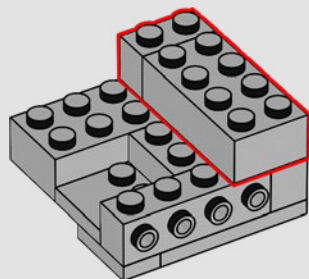

109

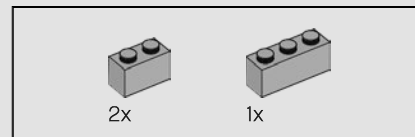
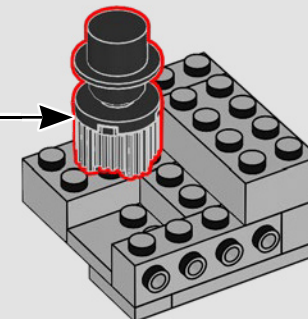
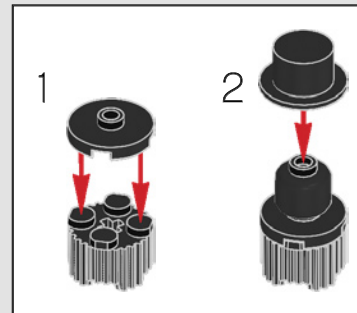

110

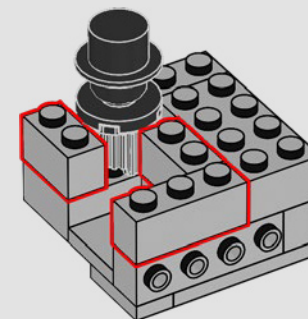

This bust is by the same artist who carved the white bust in the lobby of the 10224 Town Hall set.

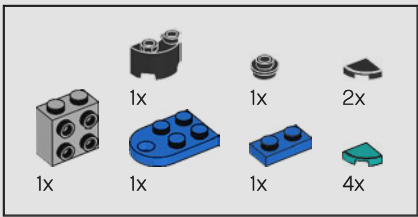

111

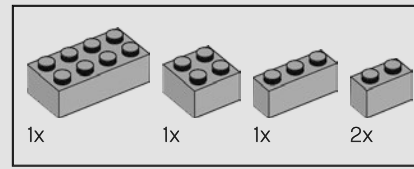
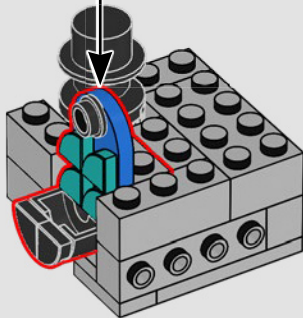
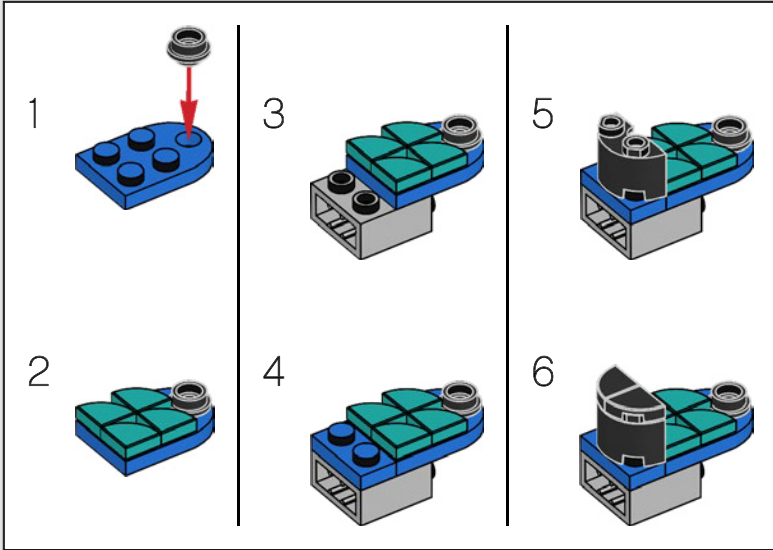

112

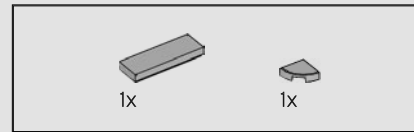
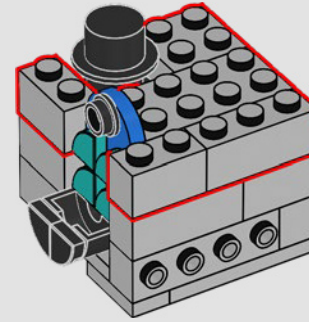

113

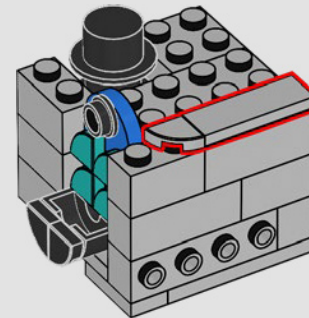

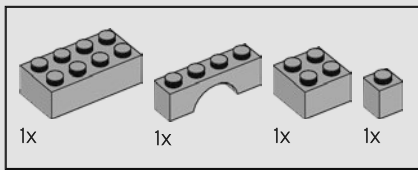

114

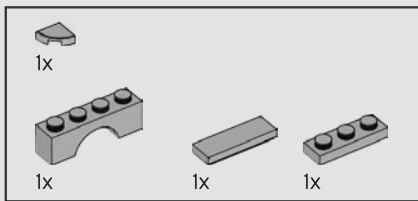
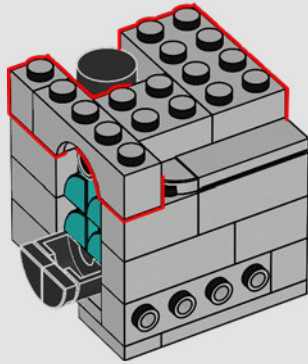

115

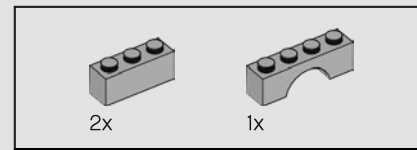
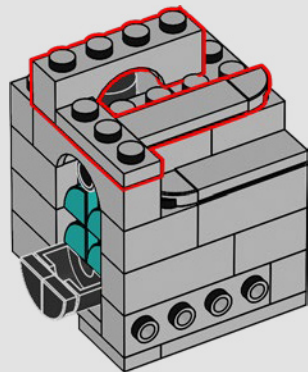

116

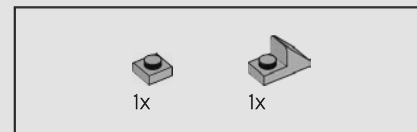
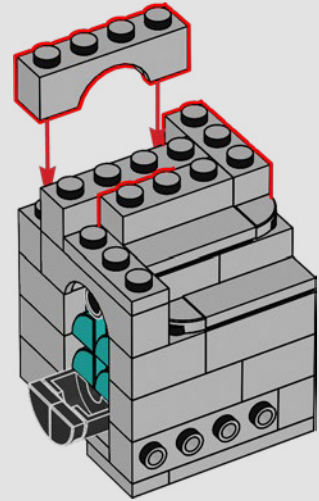

117

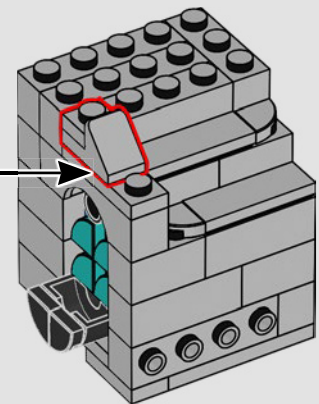
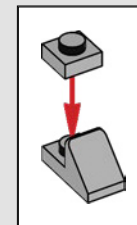

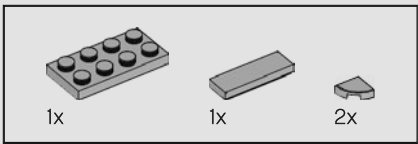

118

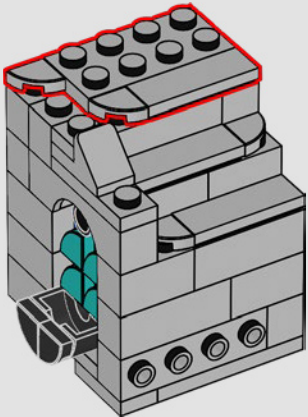

119



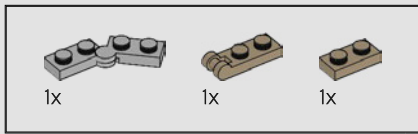

120

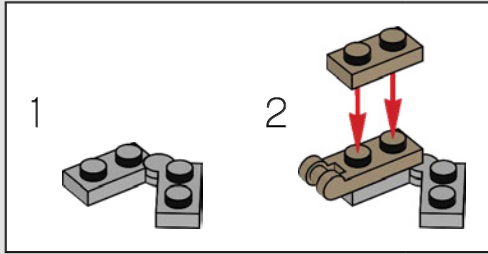

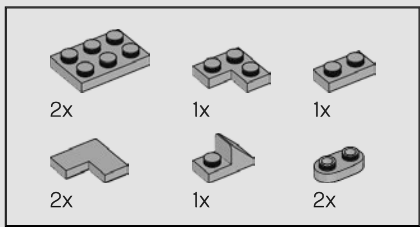

121

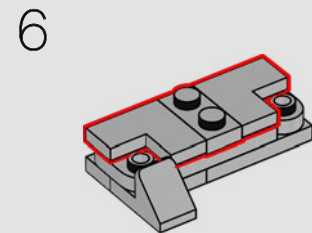
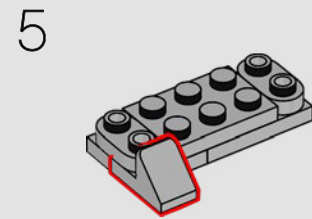
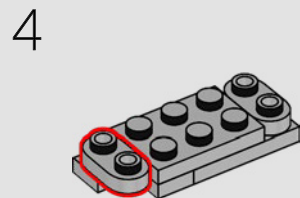
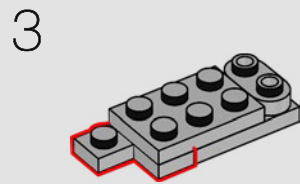
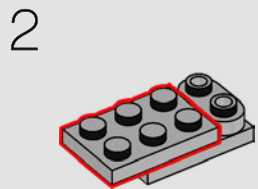
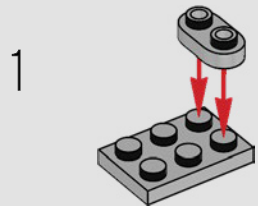



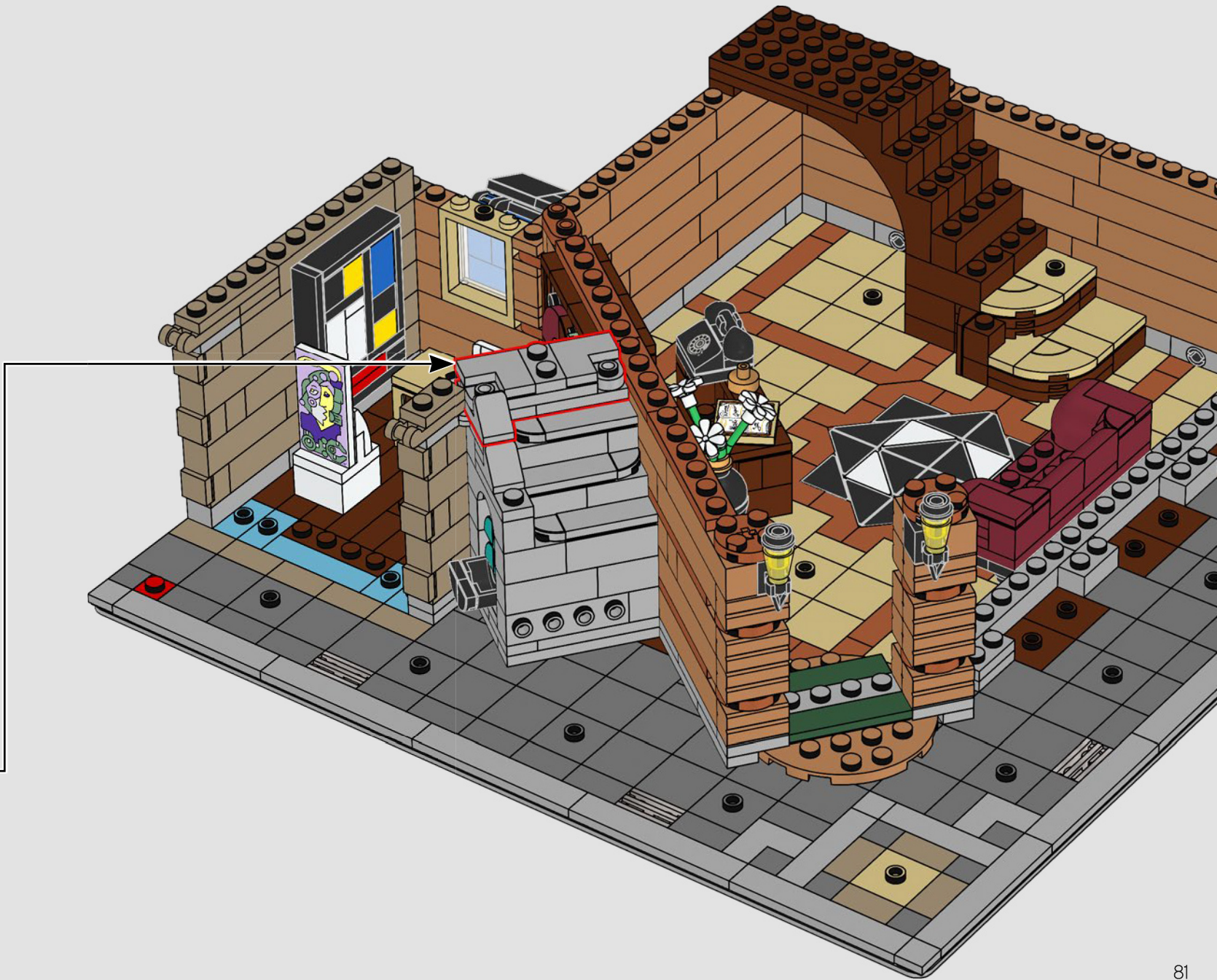

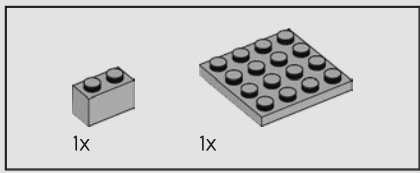

122

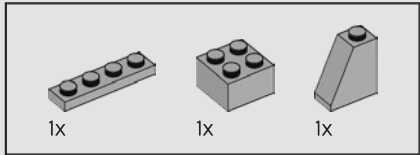
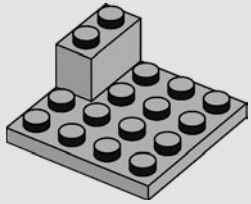

123

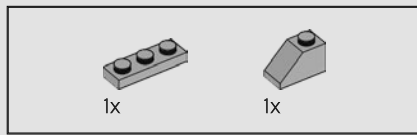
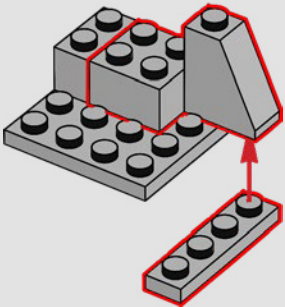

124

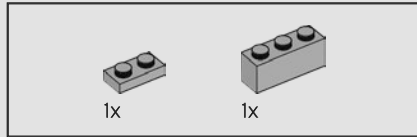
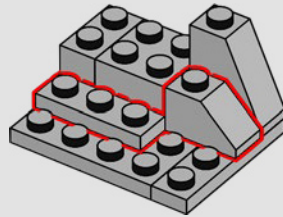

125

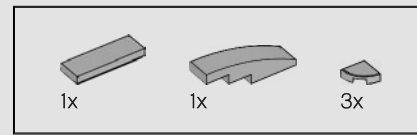
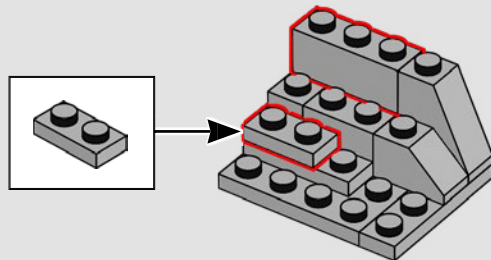

126

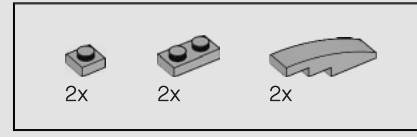
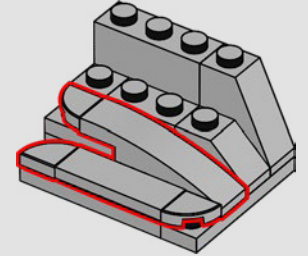

127

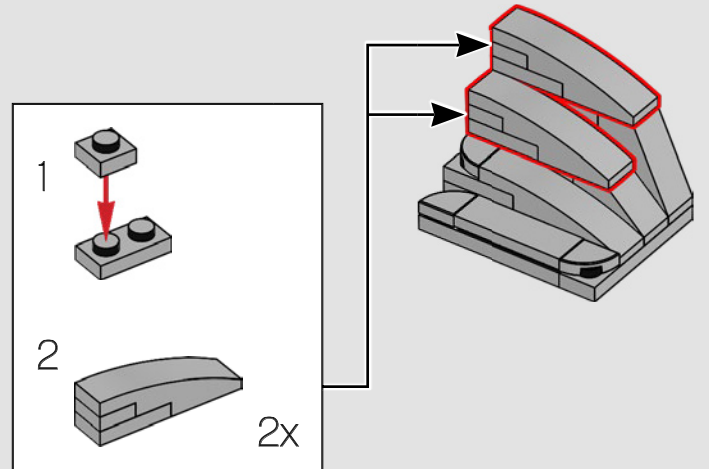

128

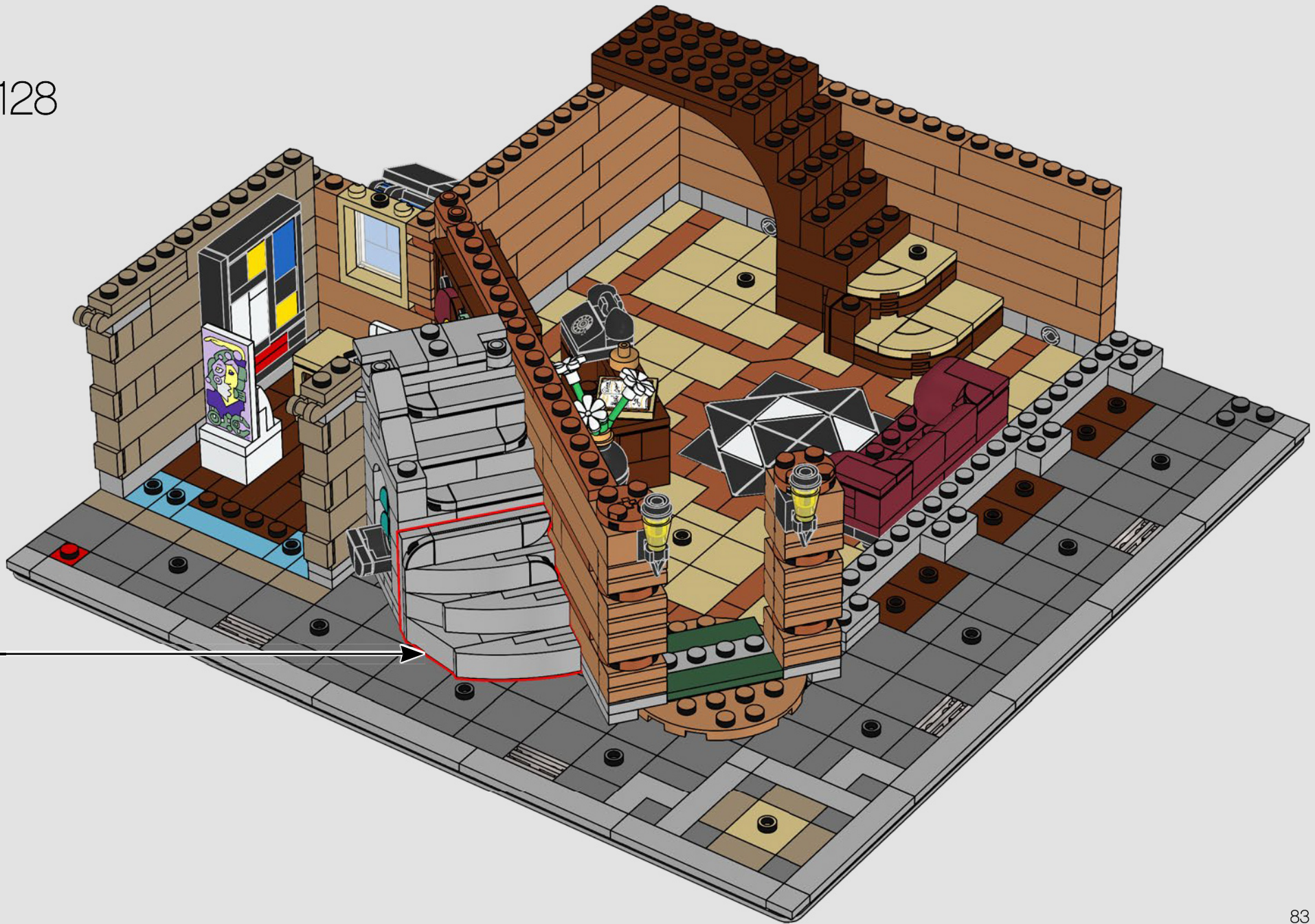

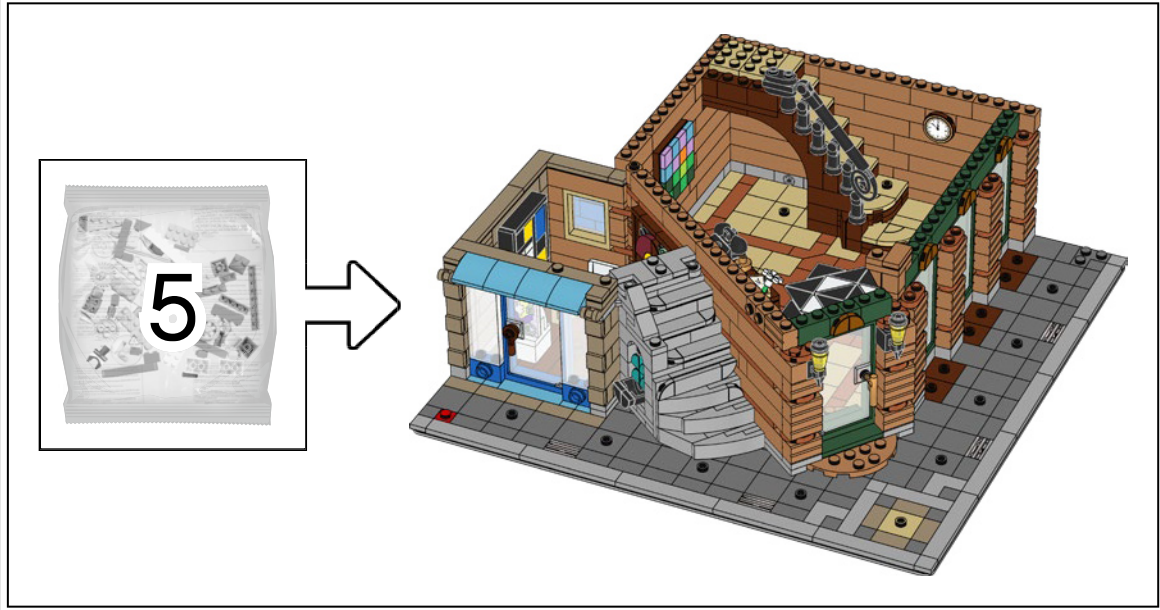

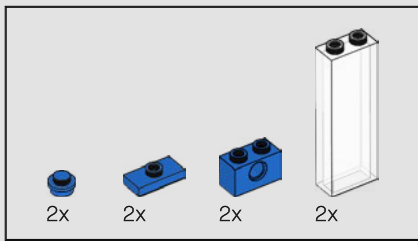

129

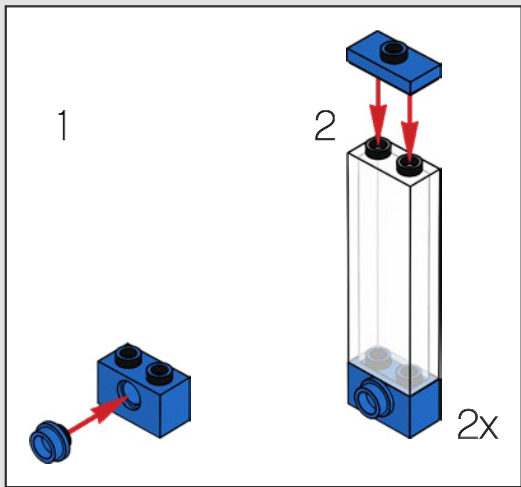

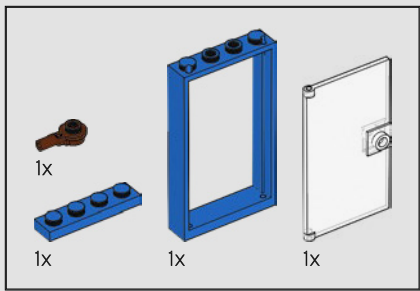

130

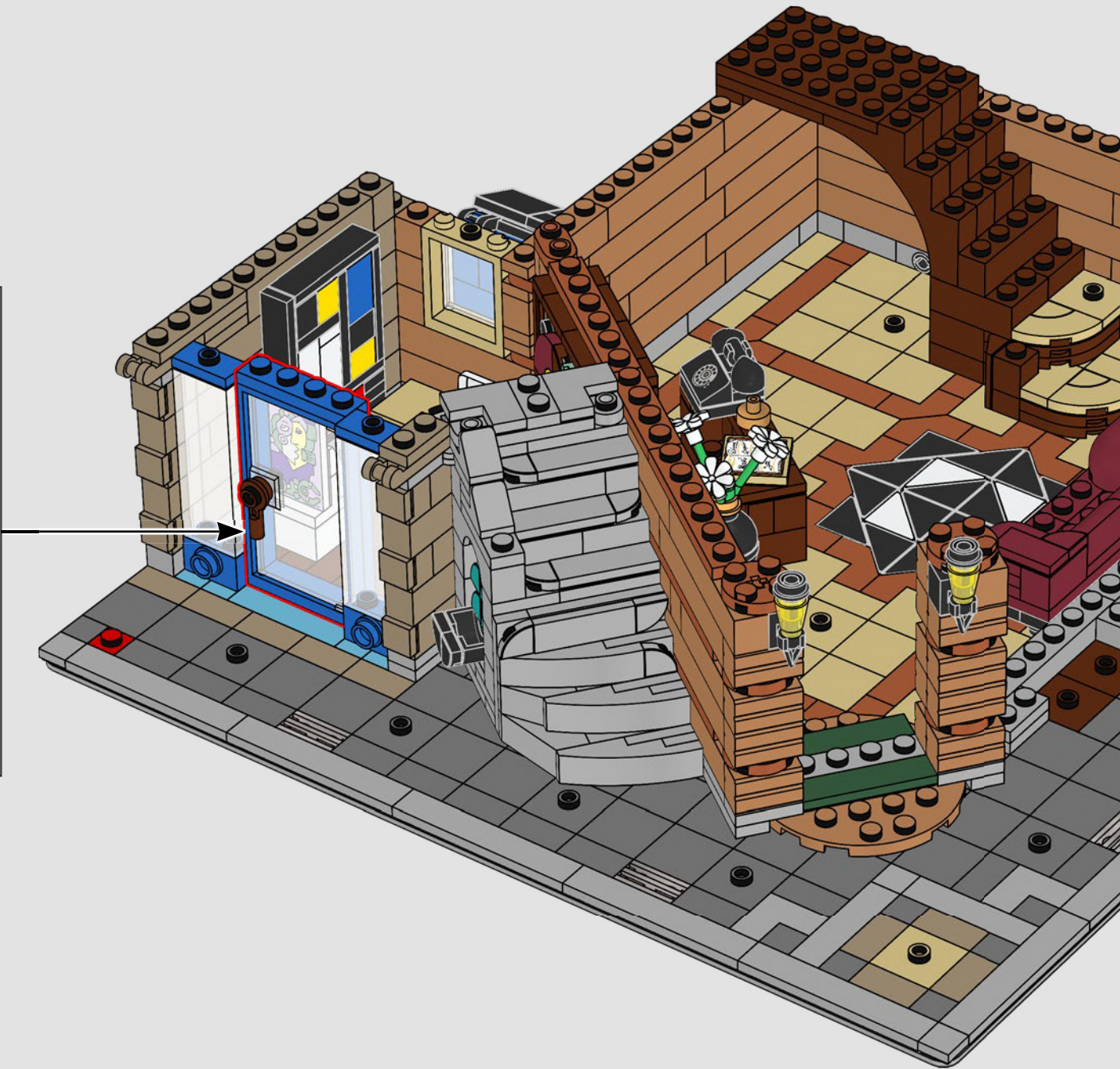
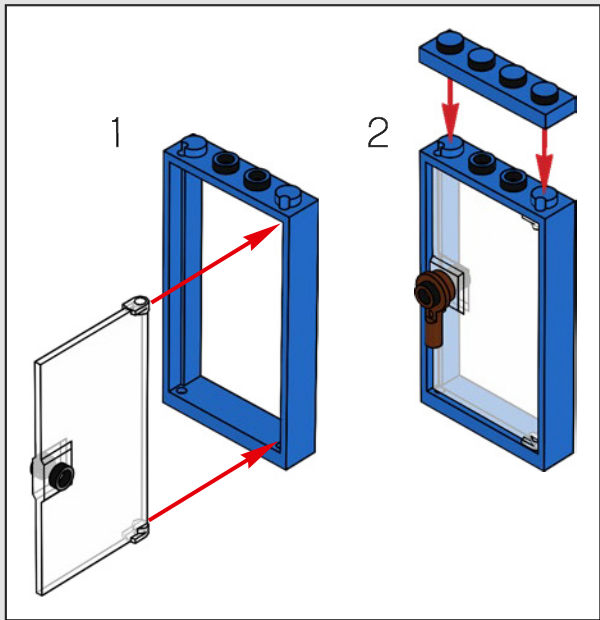

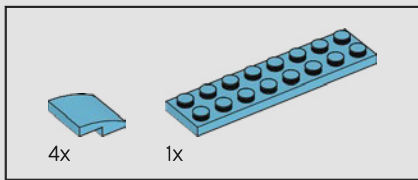

131

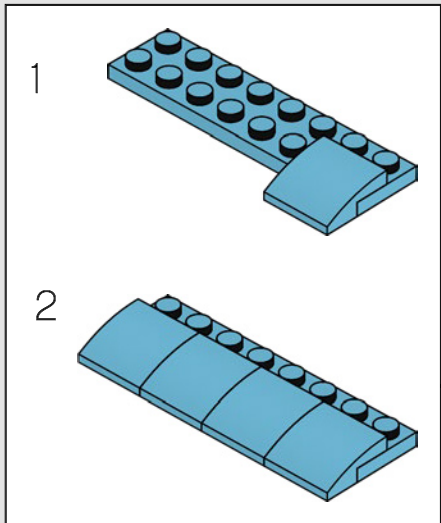

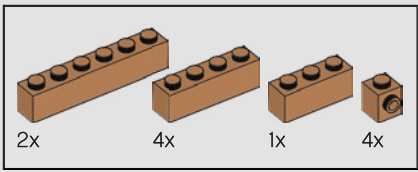

132





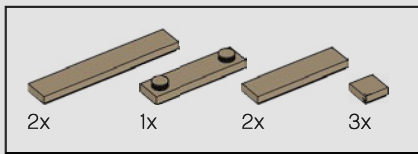

133



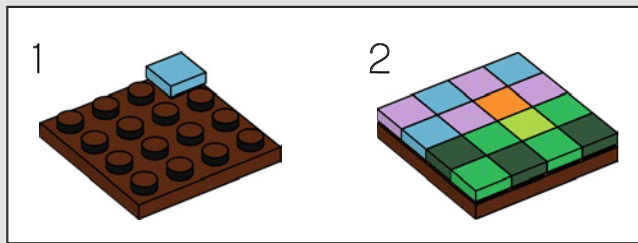
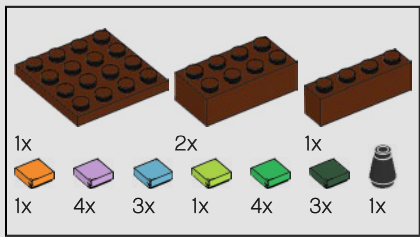

134



This painting is by the Artist whose studio is in the loft of the 10243 Parisian Restaurant set.

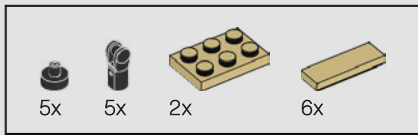

135

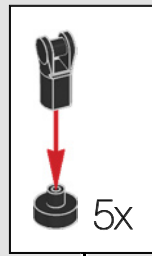



136

1

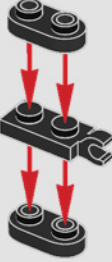

2

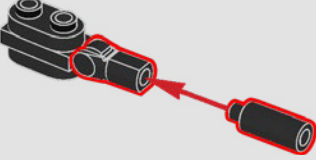

3

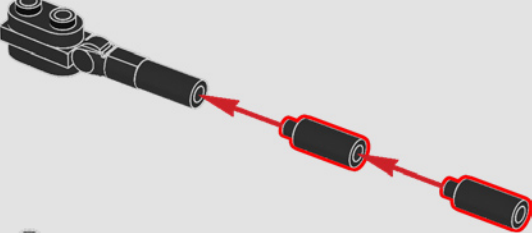

4

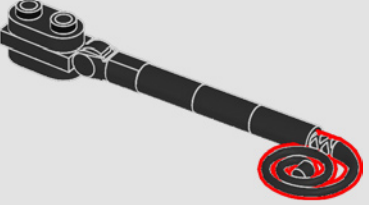

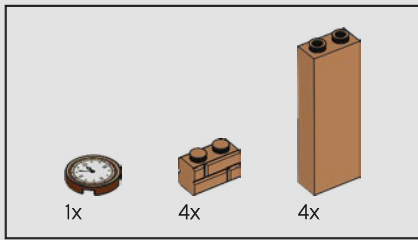

137

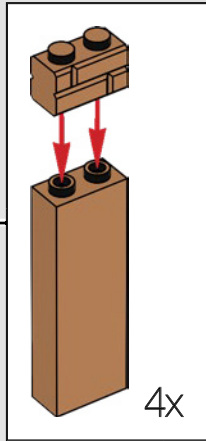

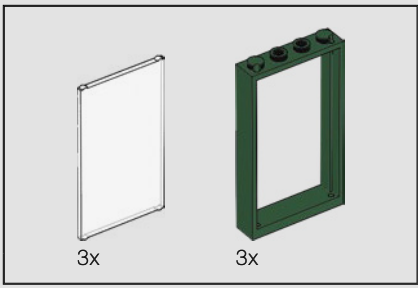

138

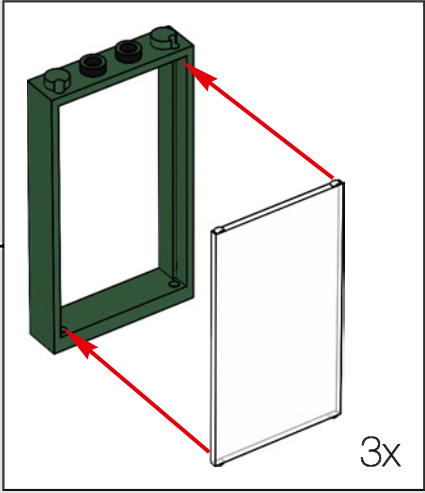

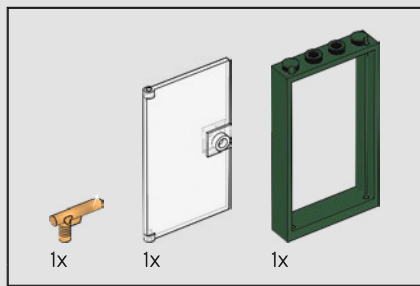

139

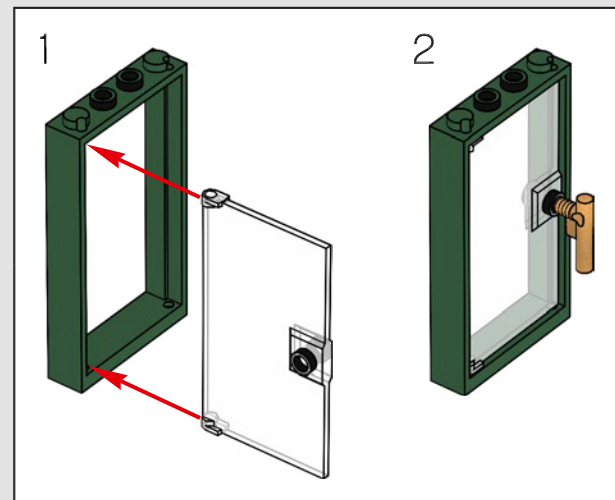

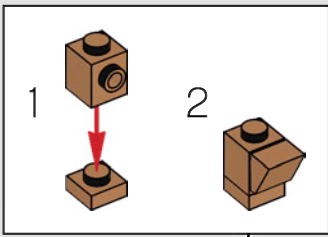
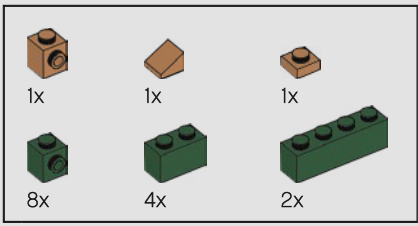

140









141



-  12x
-  20x
-  1x
-  1x
-  1x

142

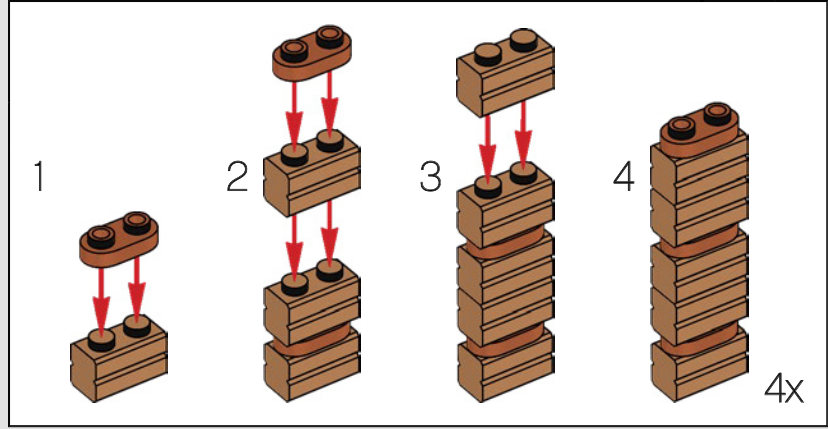
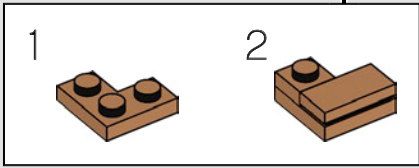

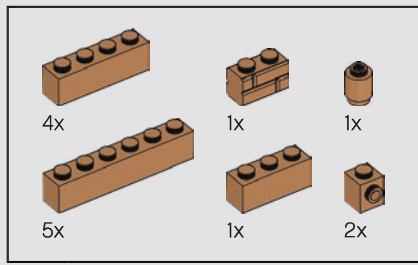

143



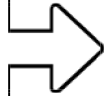

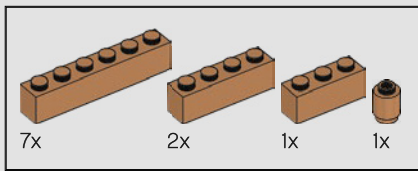

144



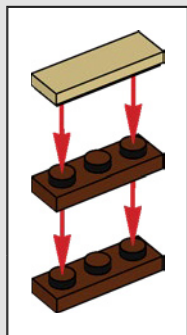
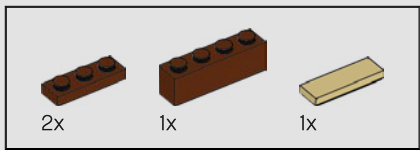

145



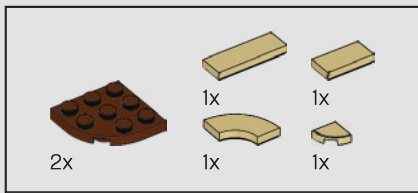

146

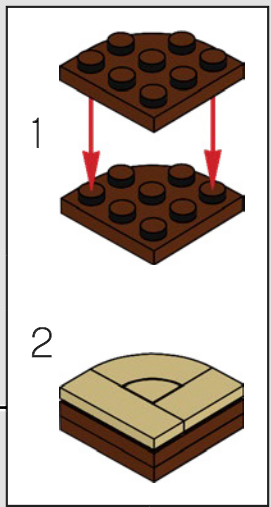

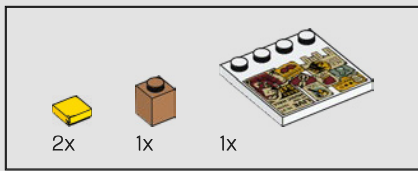

147

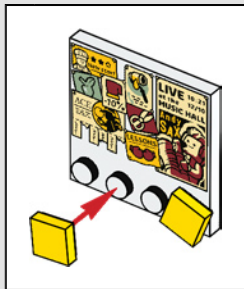

★ ★ ★ ★ ★  
 The posts on this Notice Board all advertise goods and services from elsewhere in previous Modular sets. See if you can recognise the references!

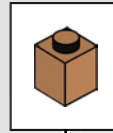



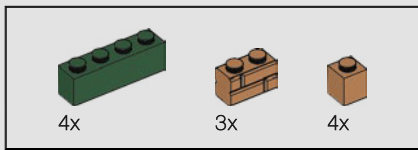

148

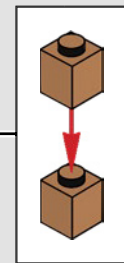

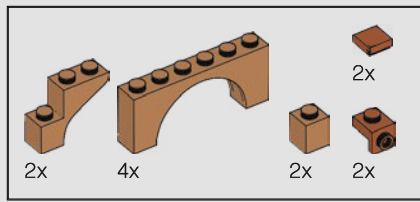

149

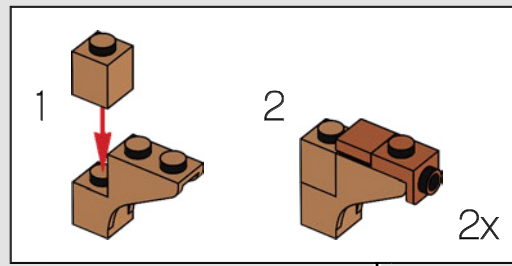

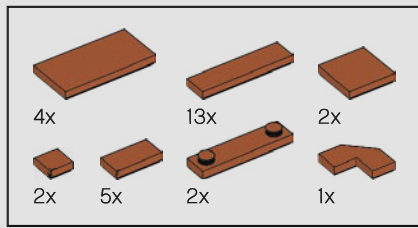

150



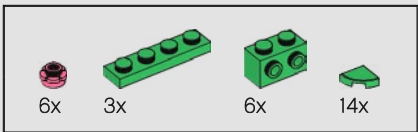

151

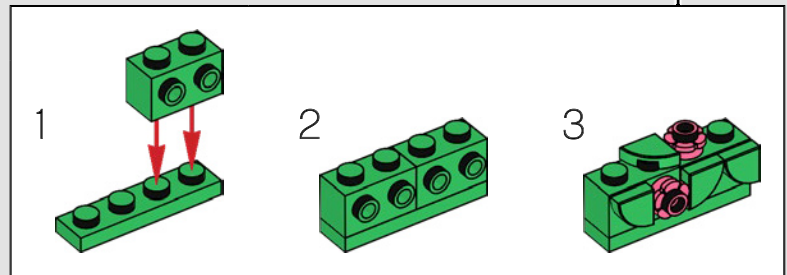
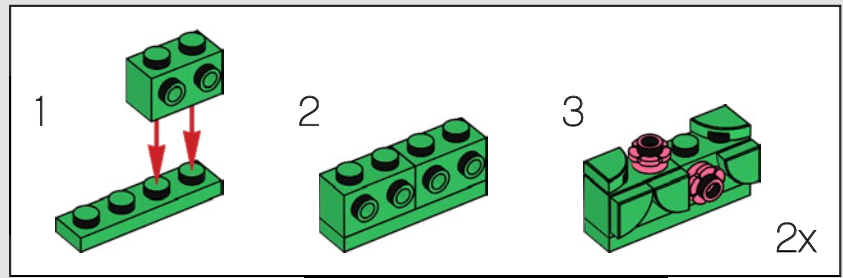

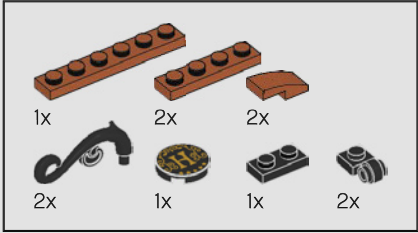
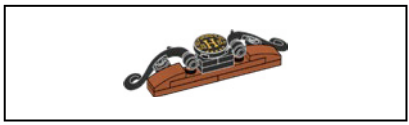

152

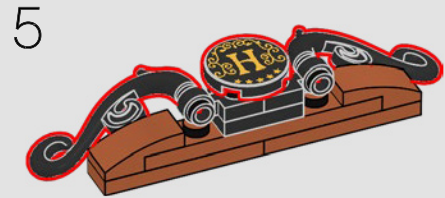
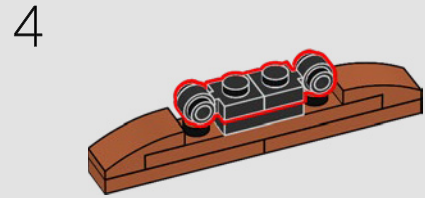
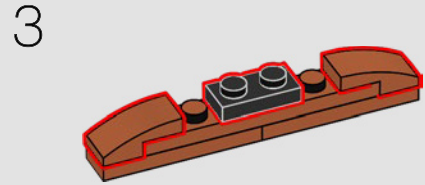
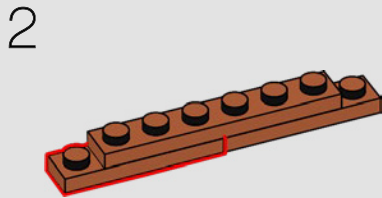
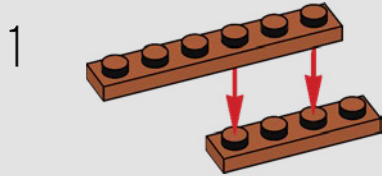



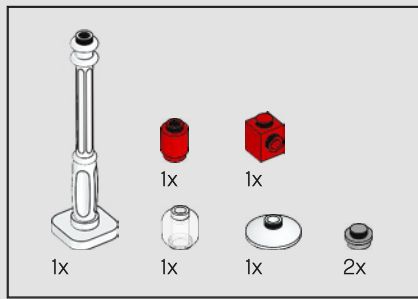

153

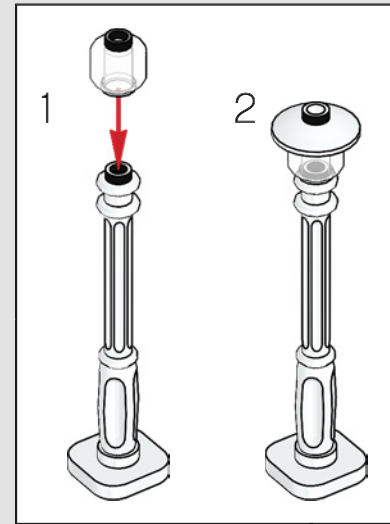
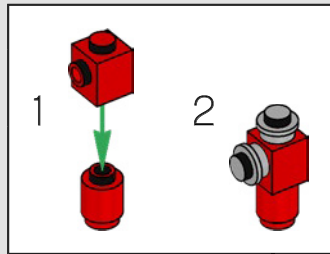

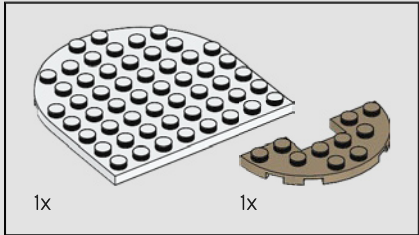
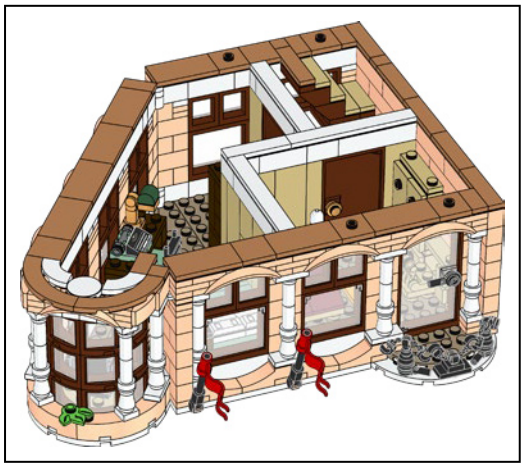
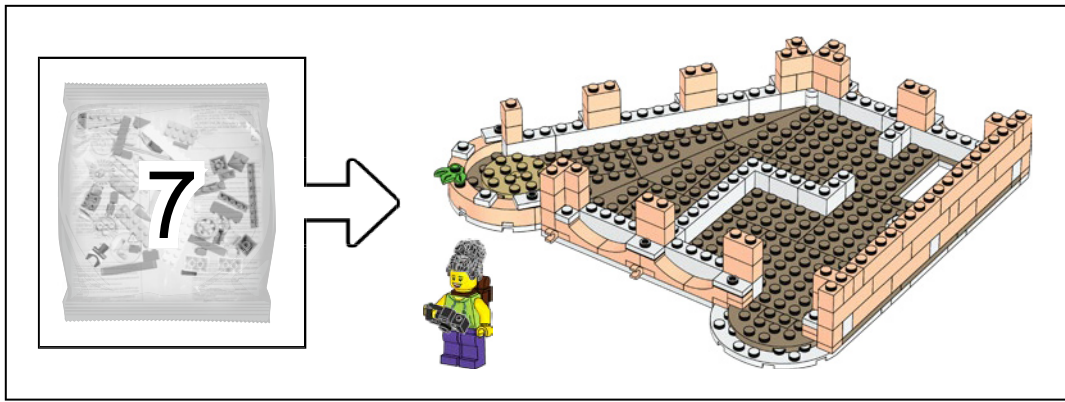

154

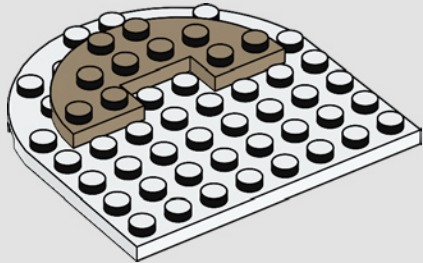

The Backpacker is travelling the world!  
She's doing it on a budget, so is staying  
in the Hotel's Economy room.

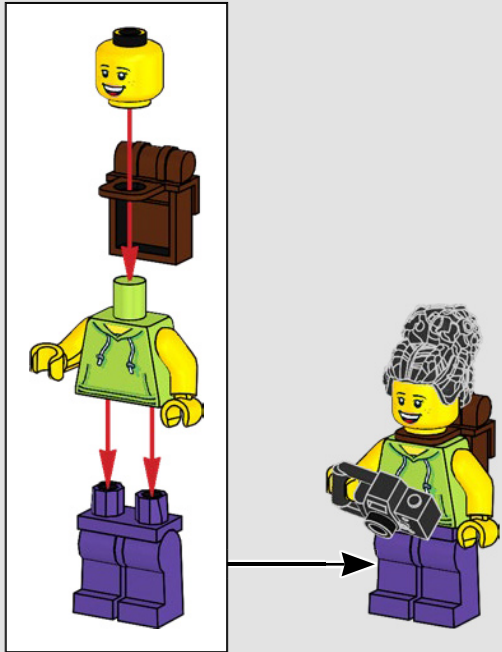



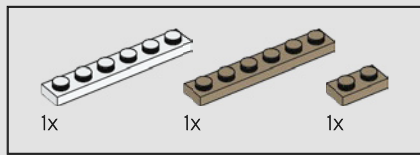

155

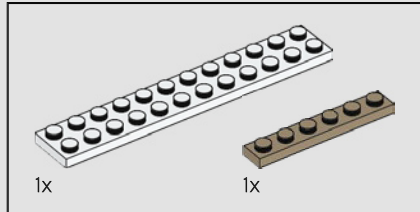
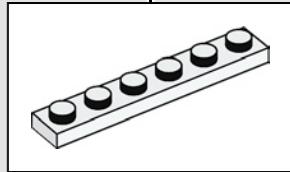
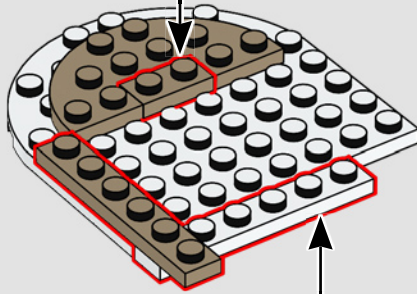
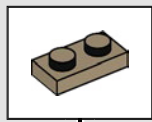

156

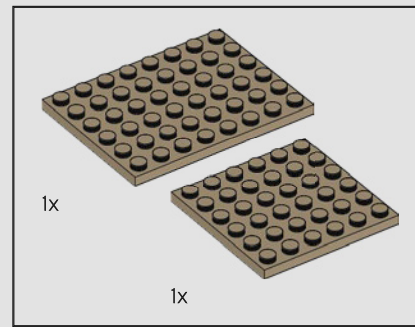
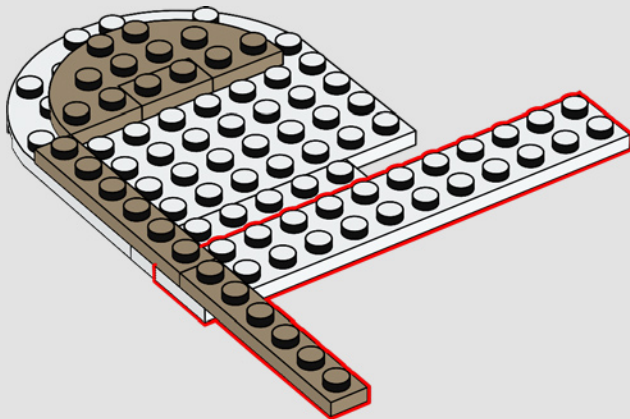

157

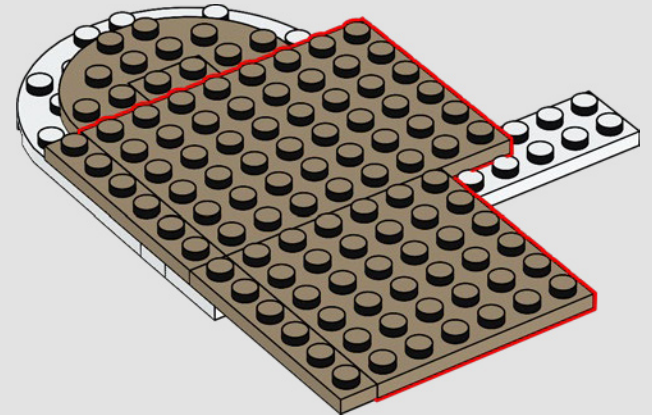

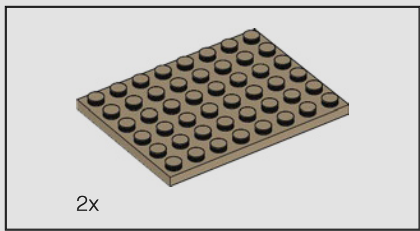

158

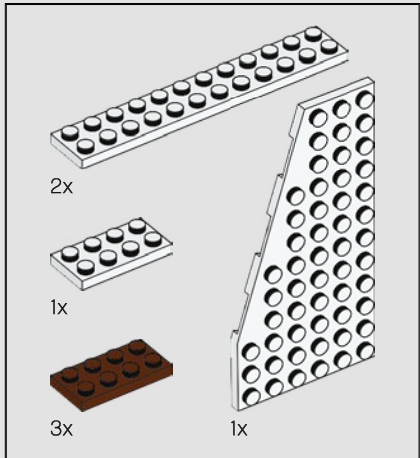
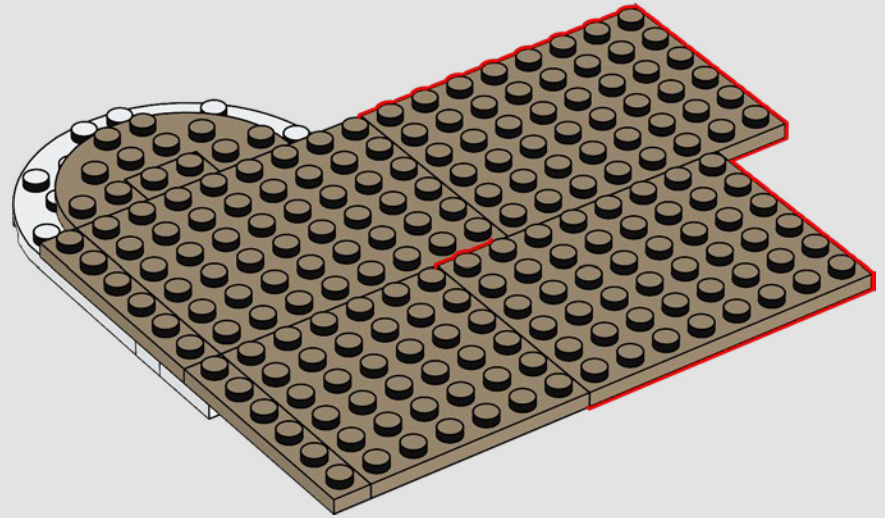

159

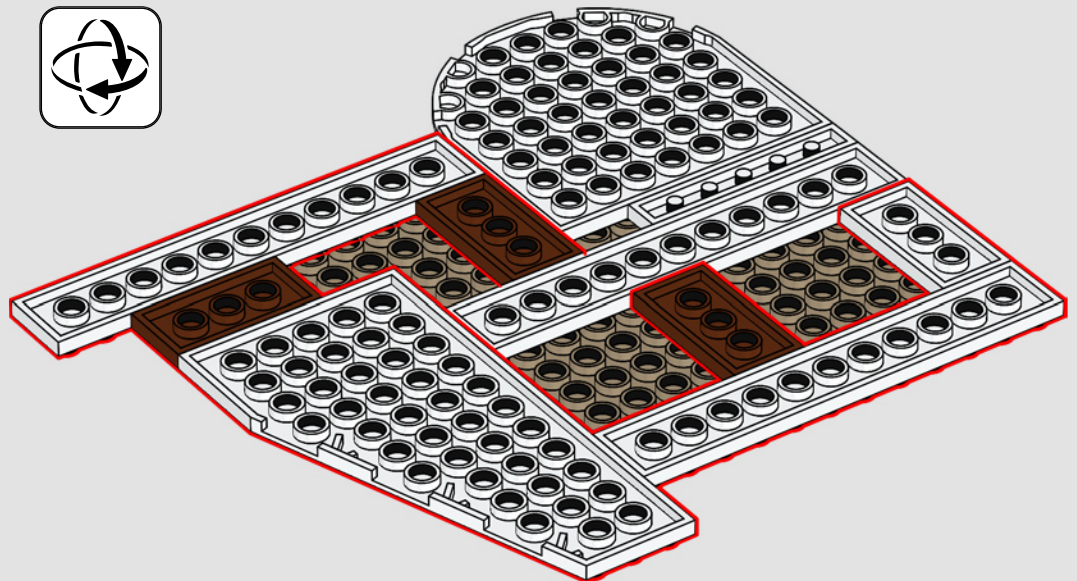
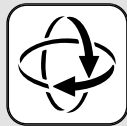

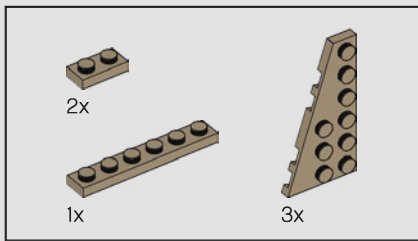

160

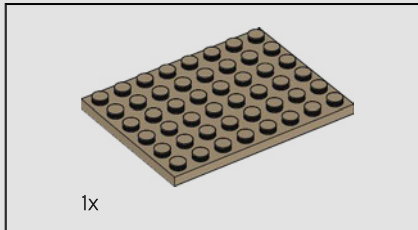
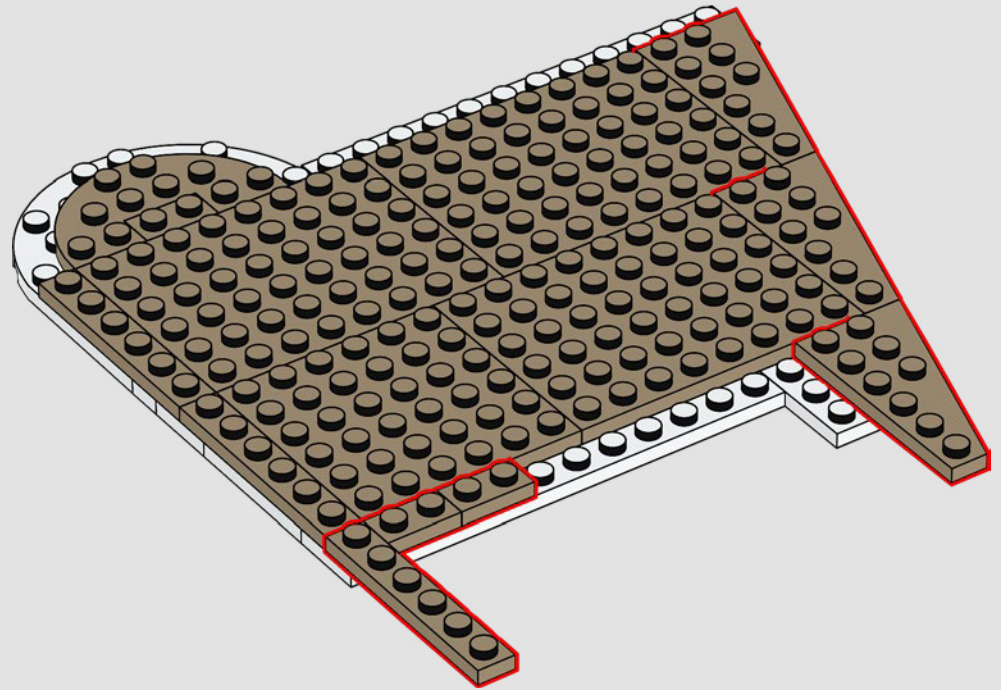

161

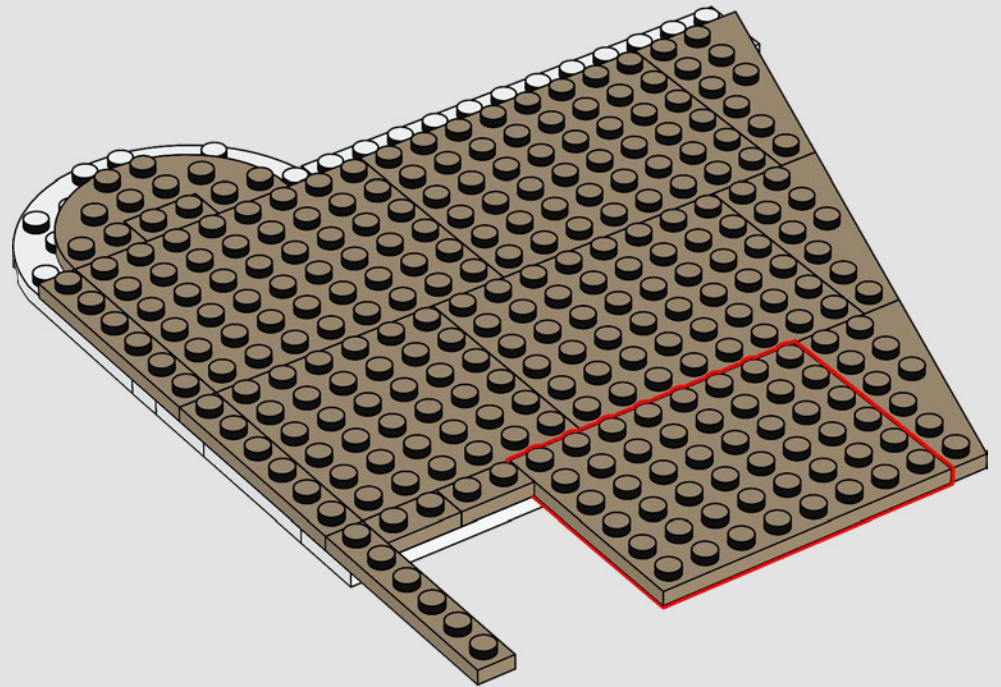

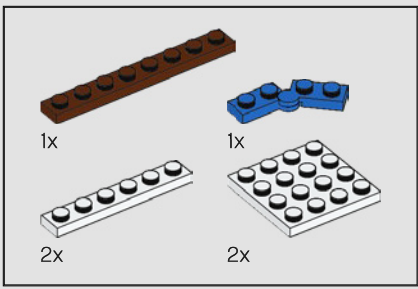

162

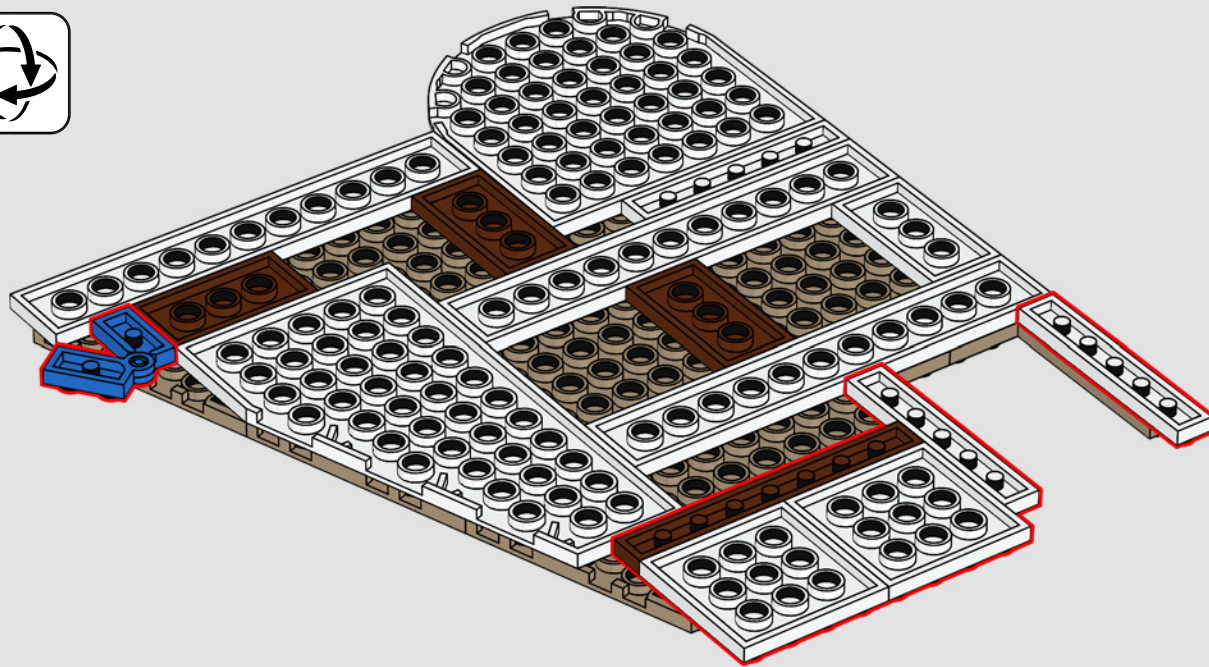

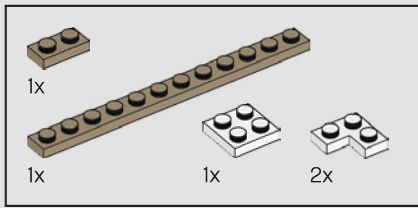

163

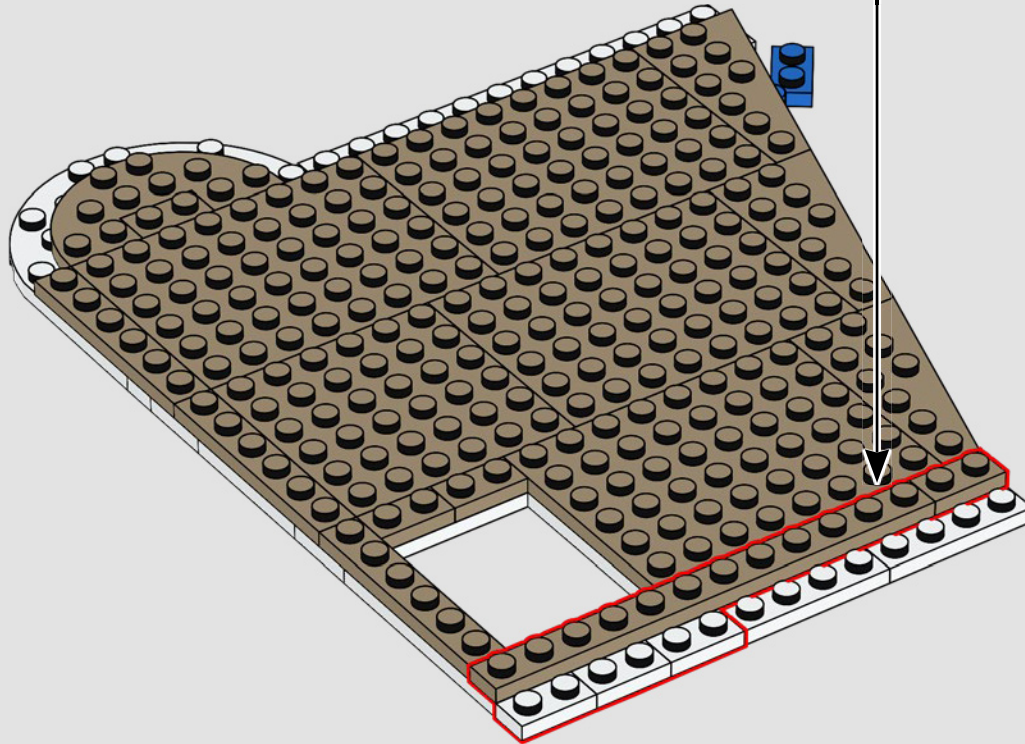
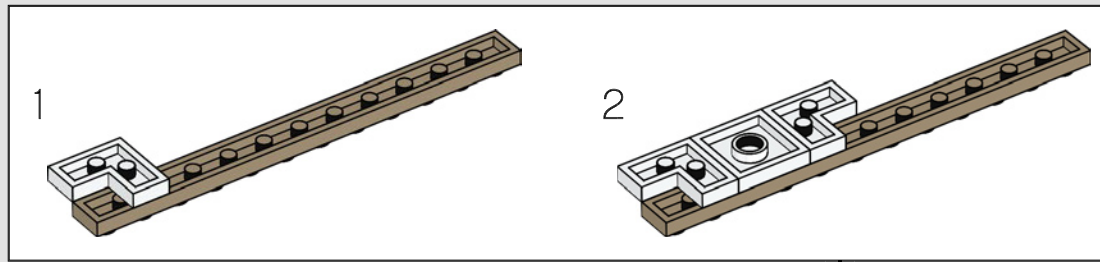

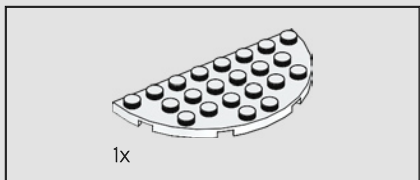

164

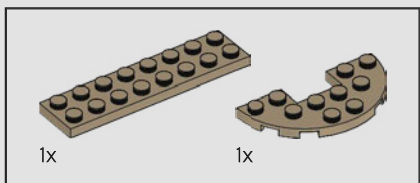
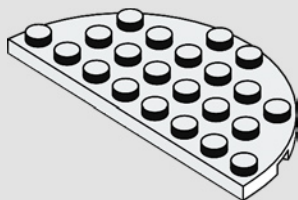

165

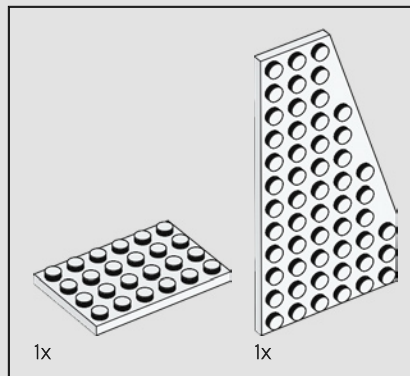
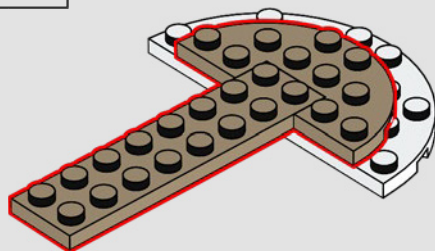

166

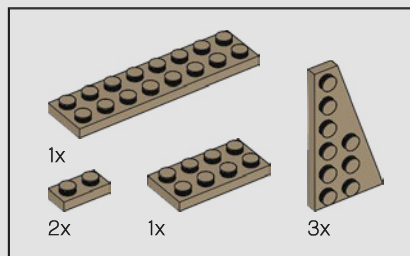
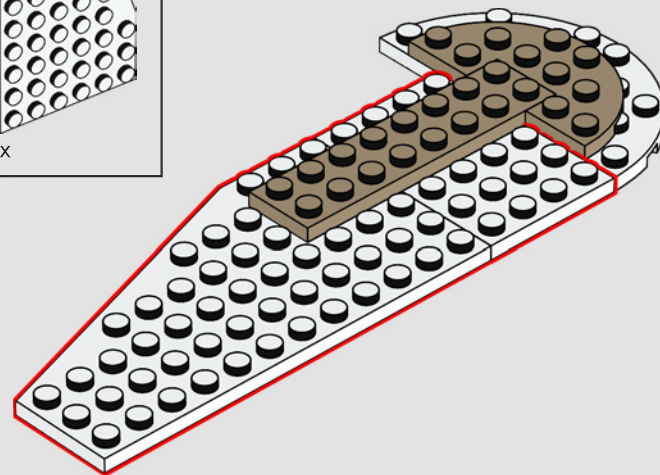

167

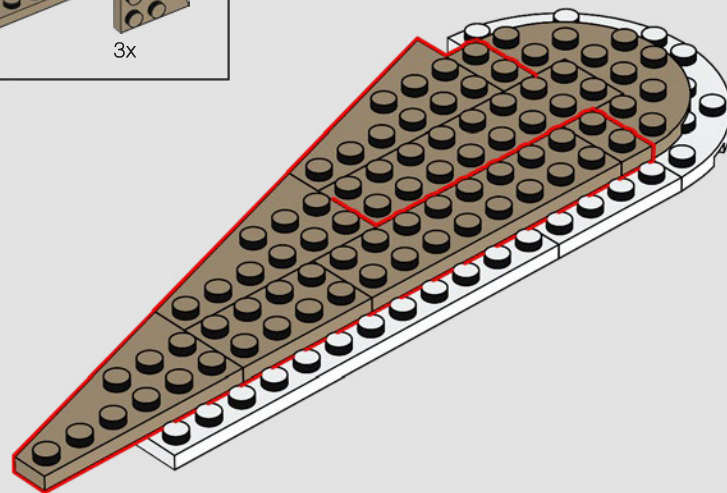

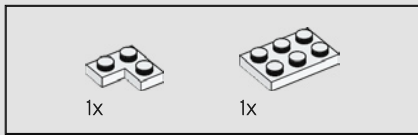

168

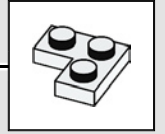
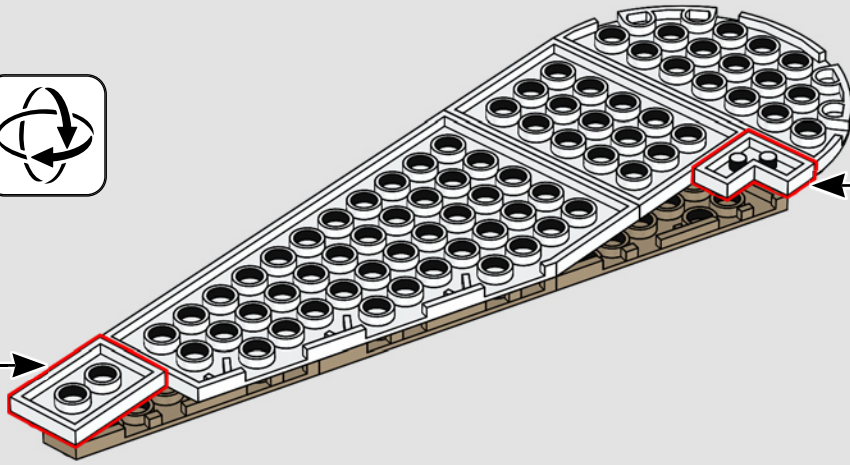
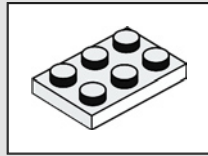

169

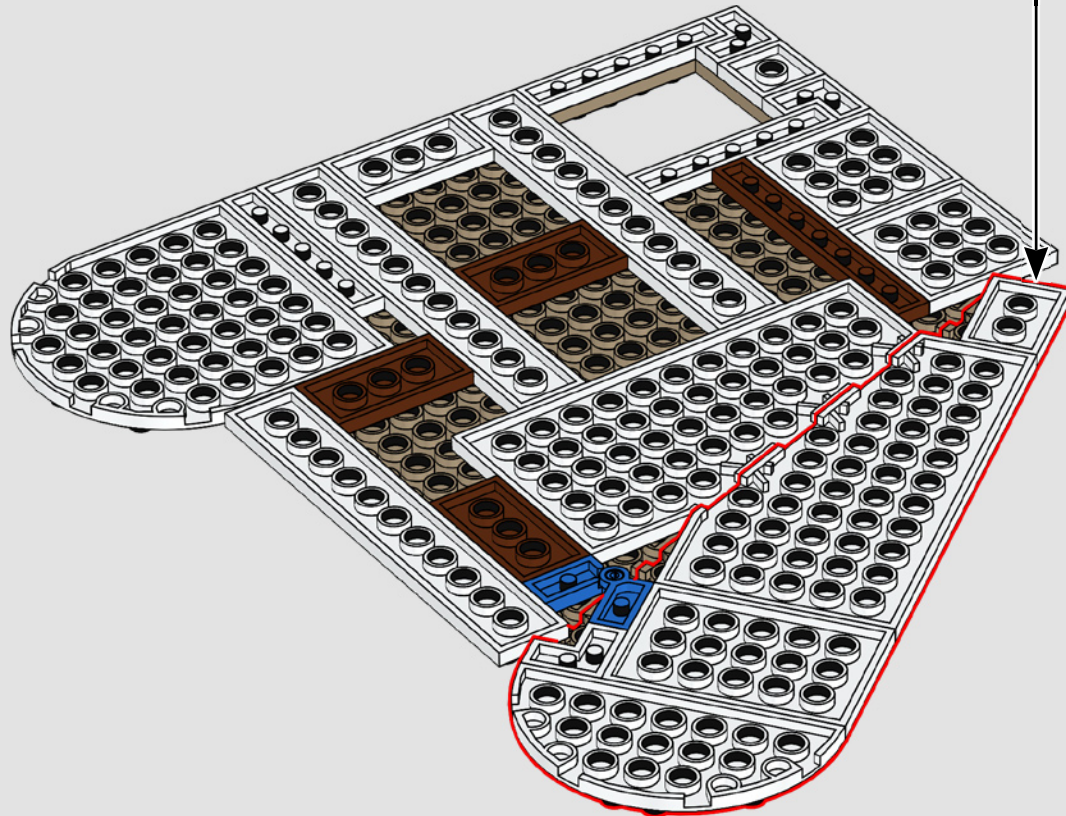

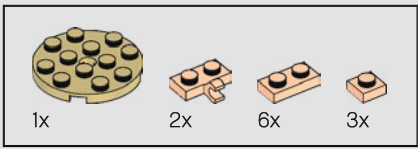

170

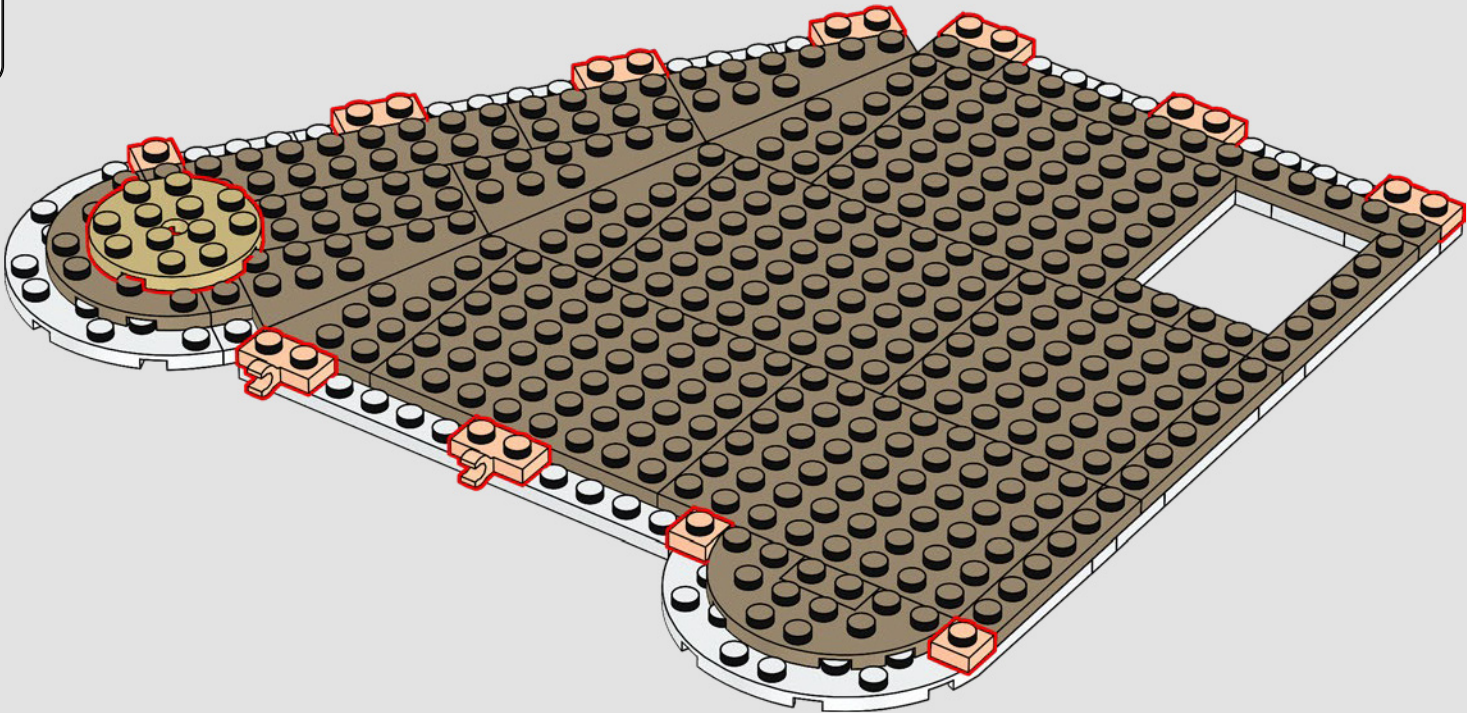



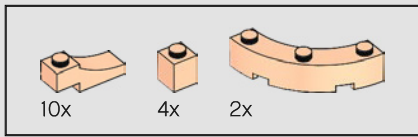

171

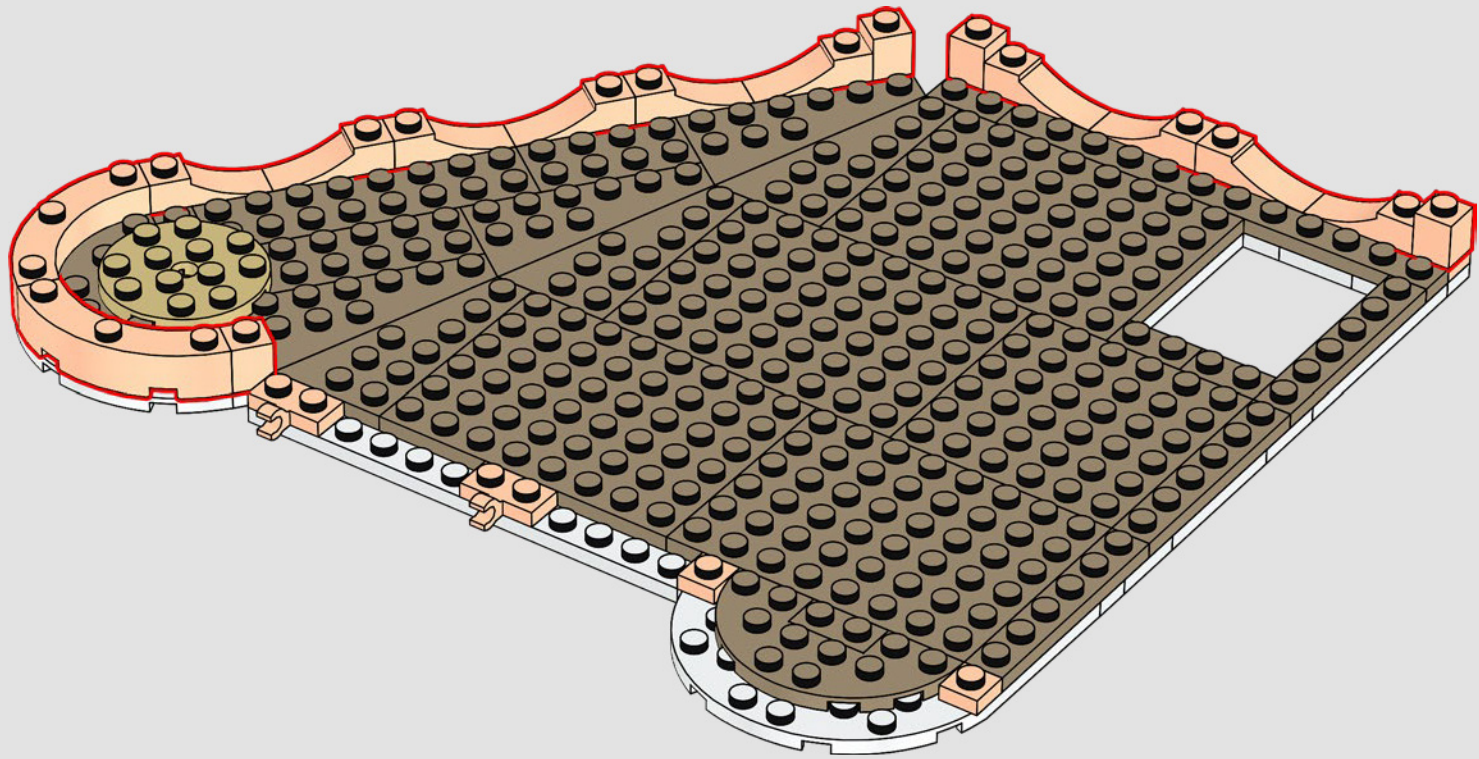

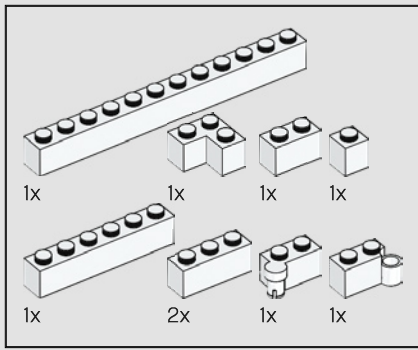

172

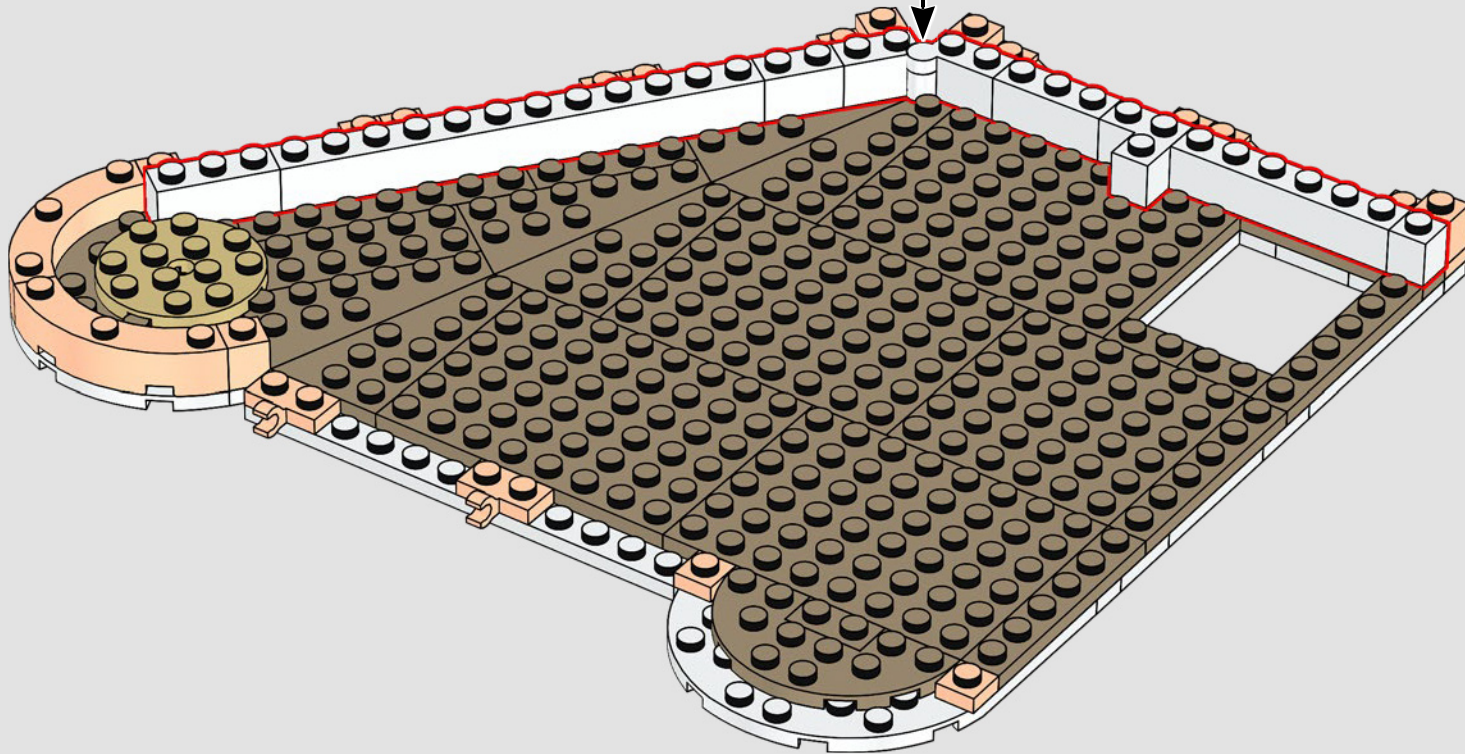
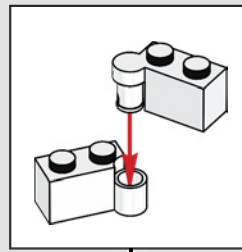

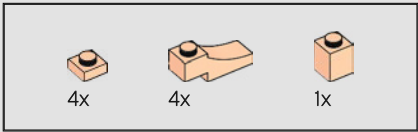

173

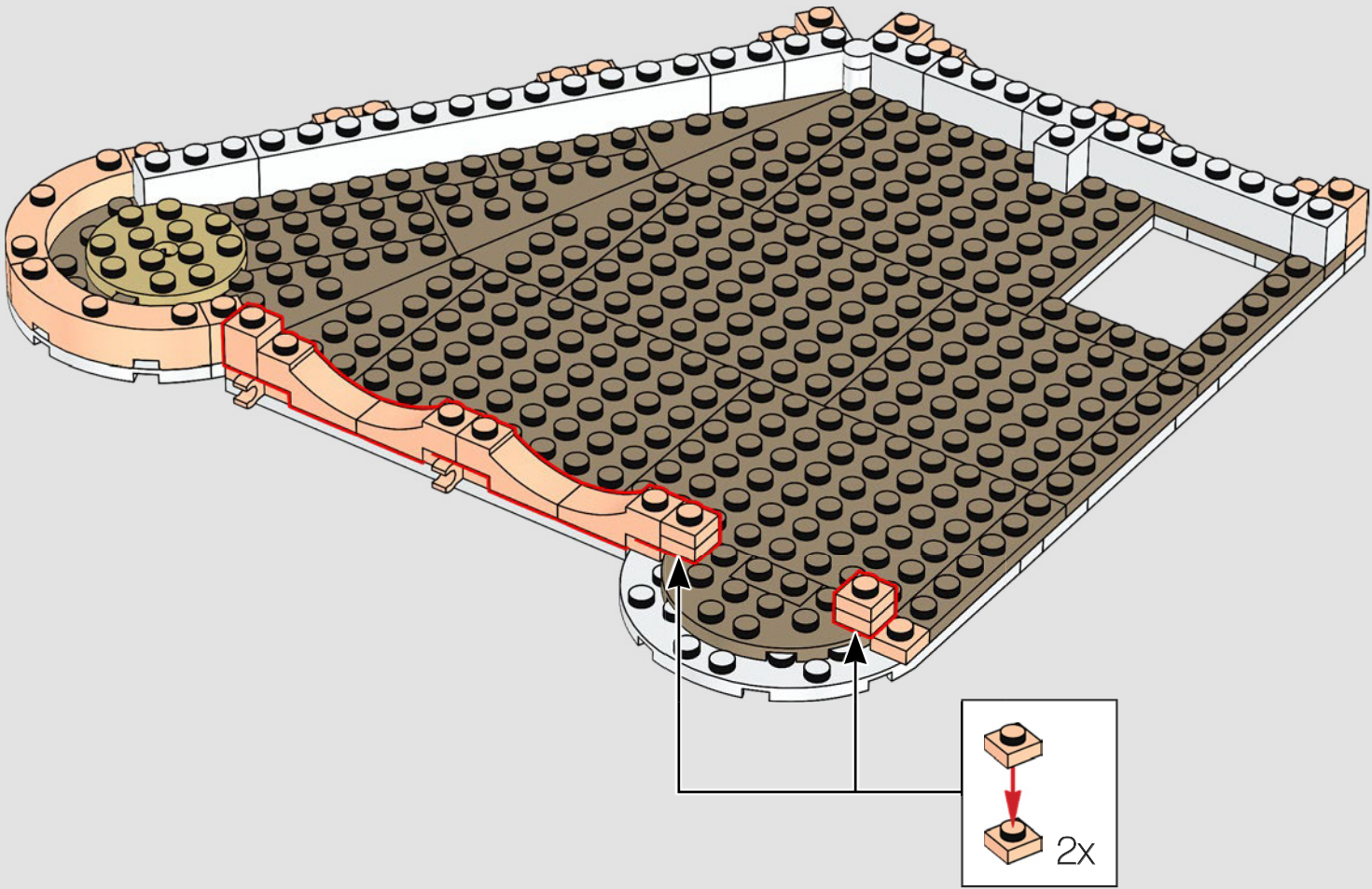

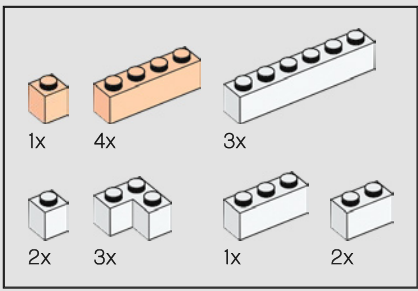

174

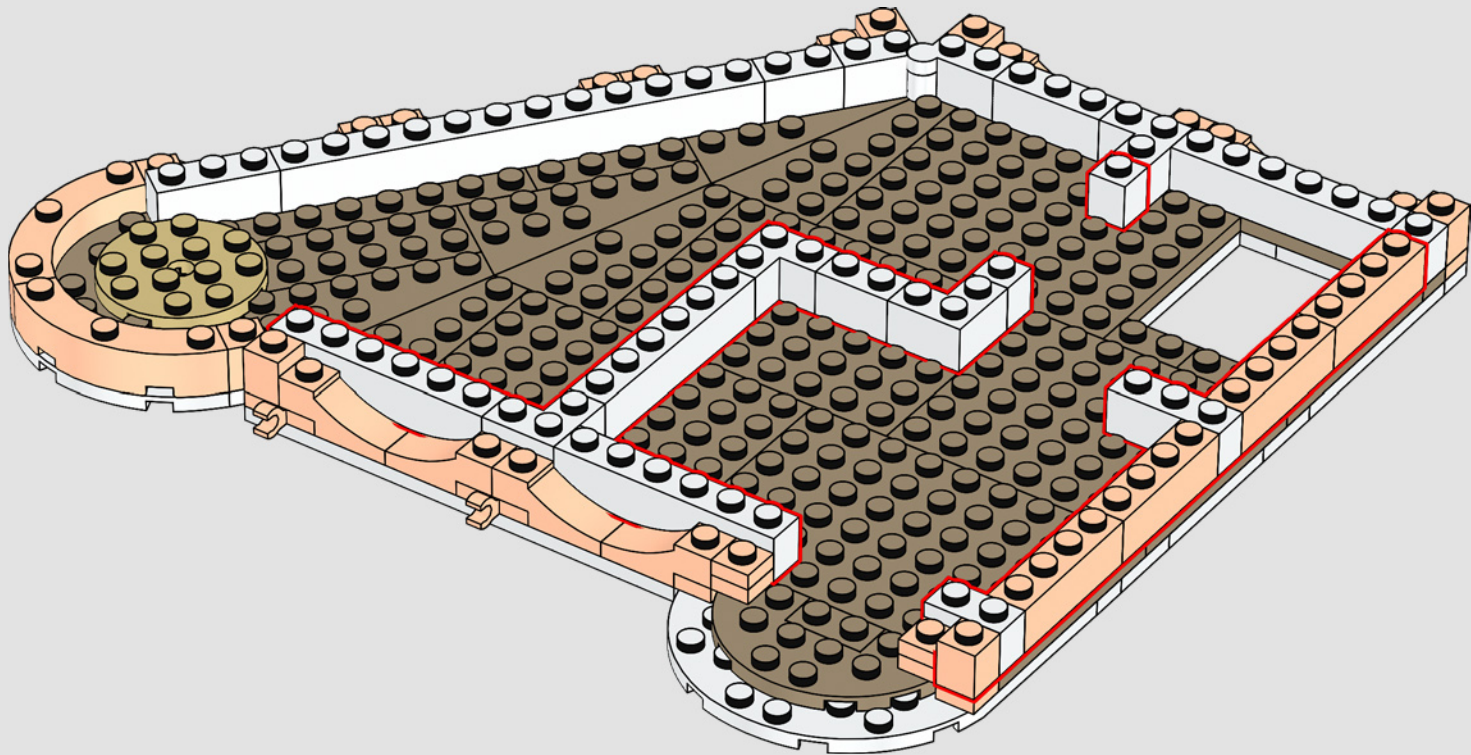

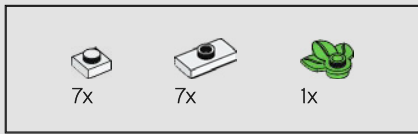

175

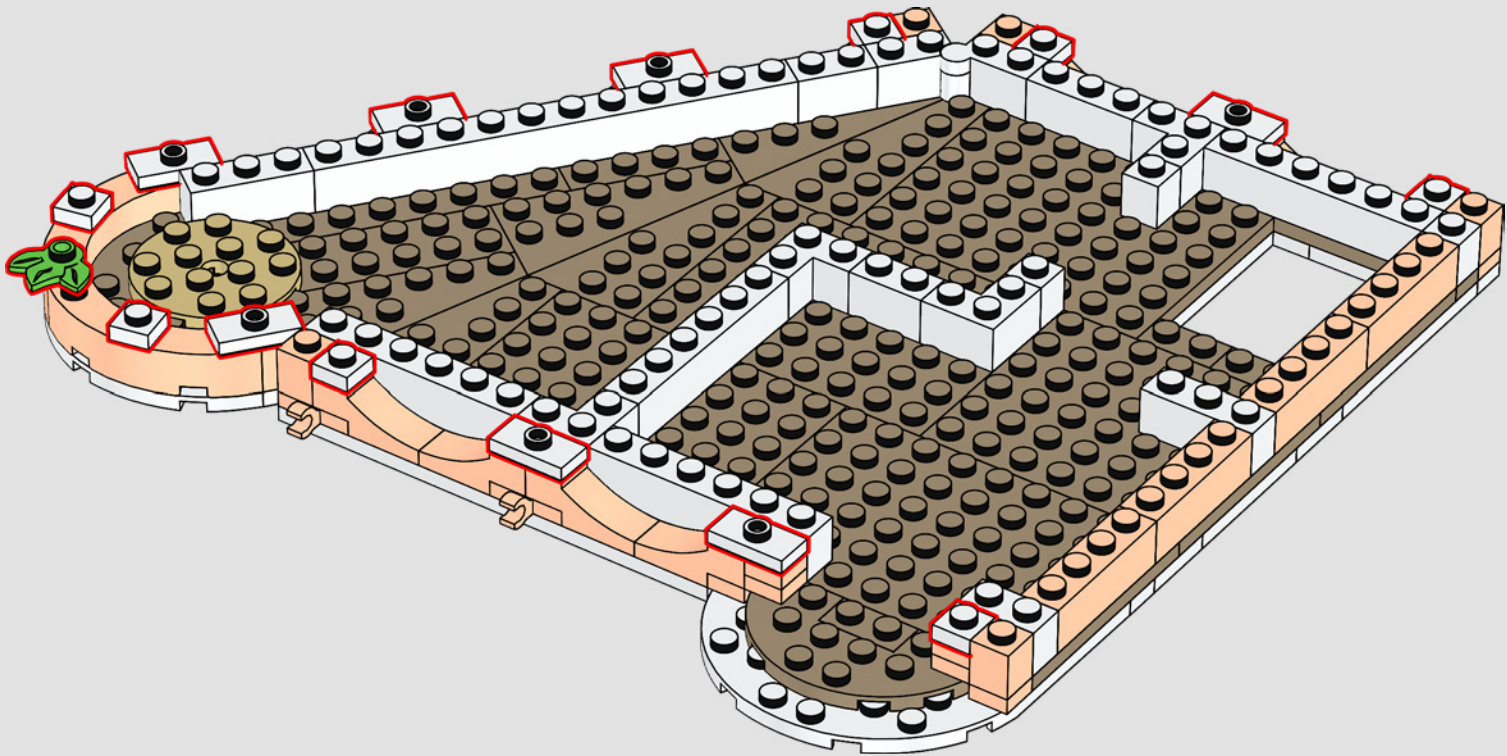

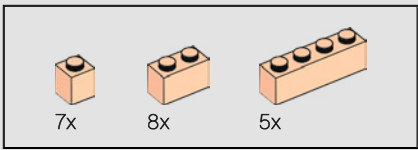

176

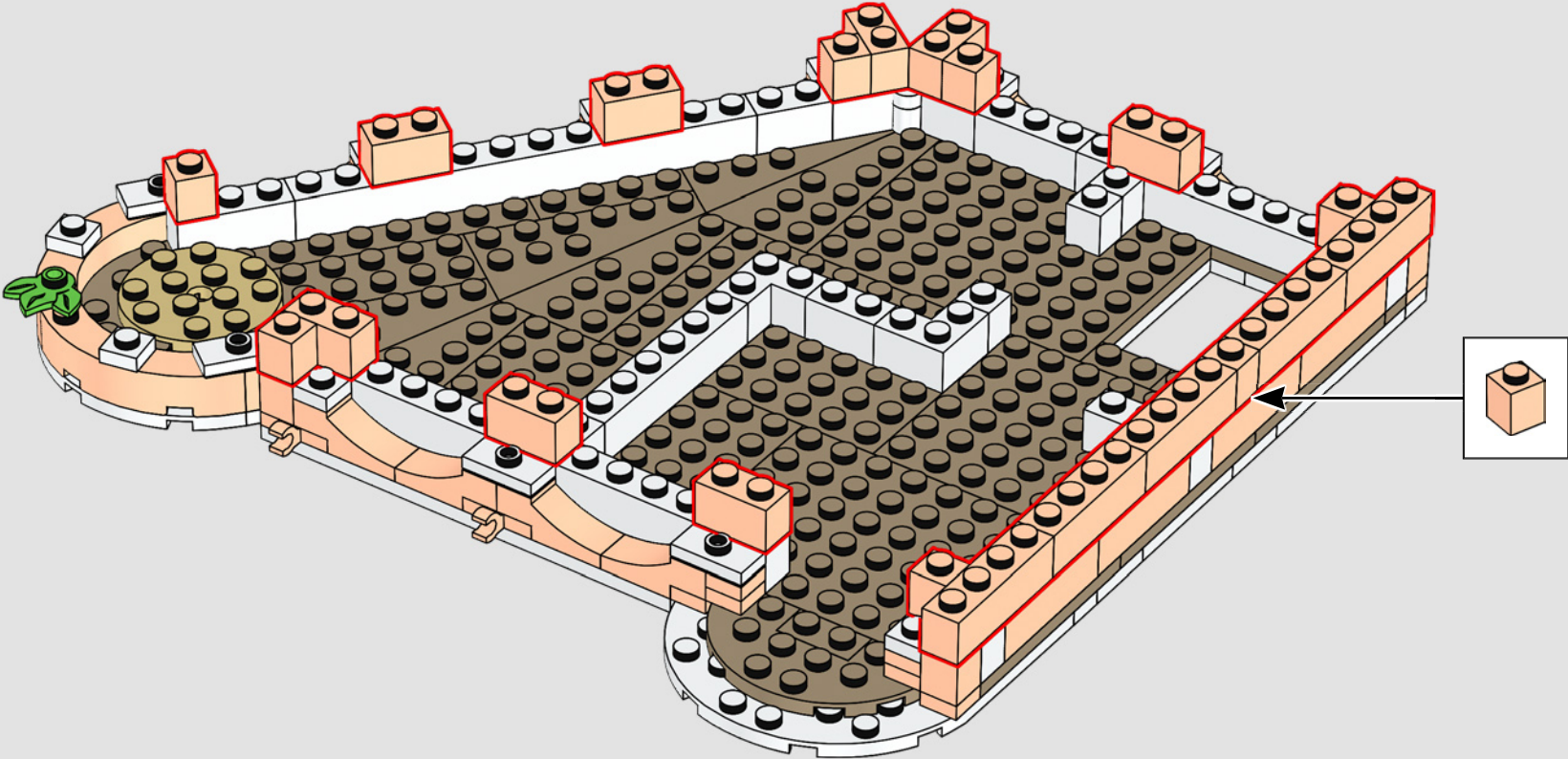

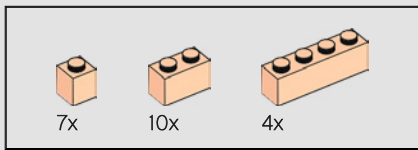

177

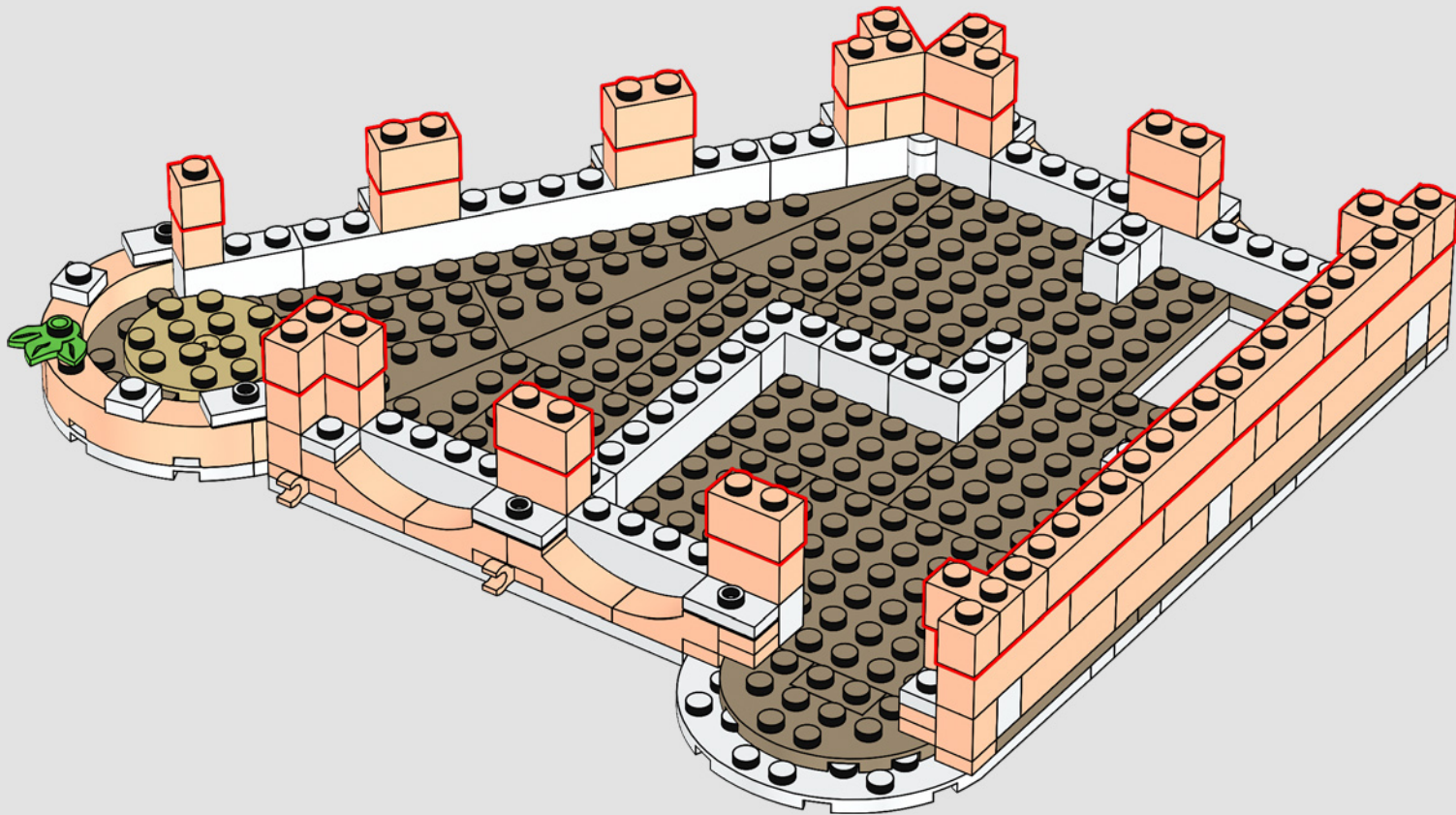

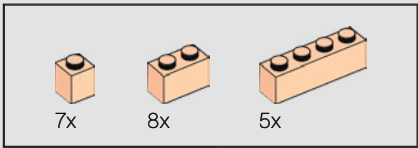
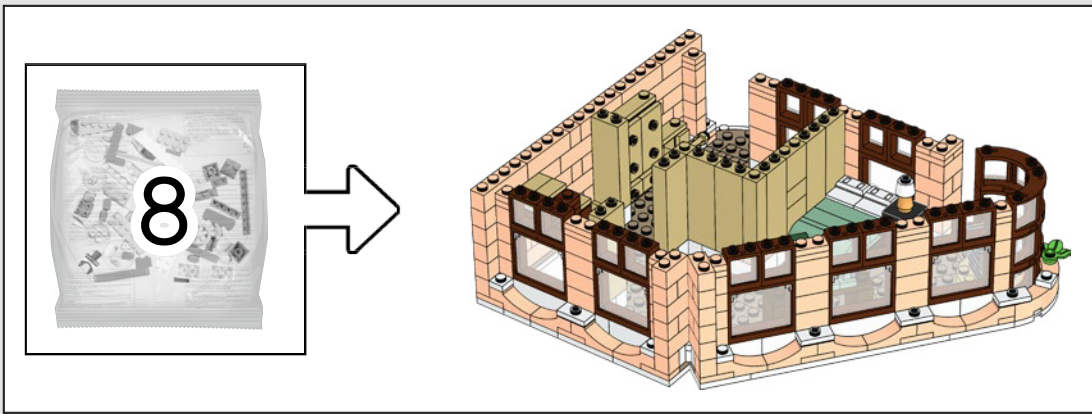

178

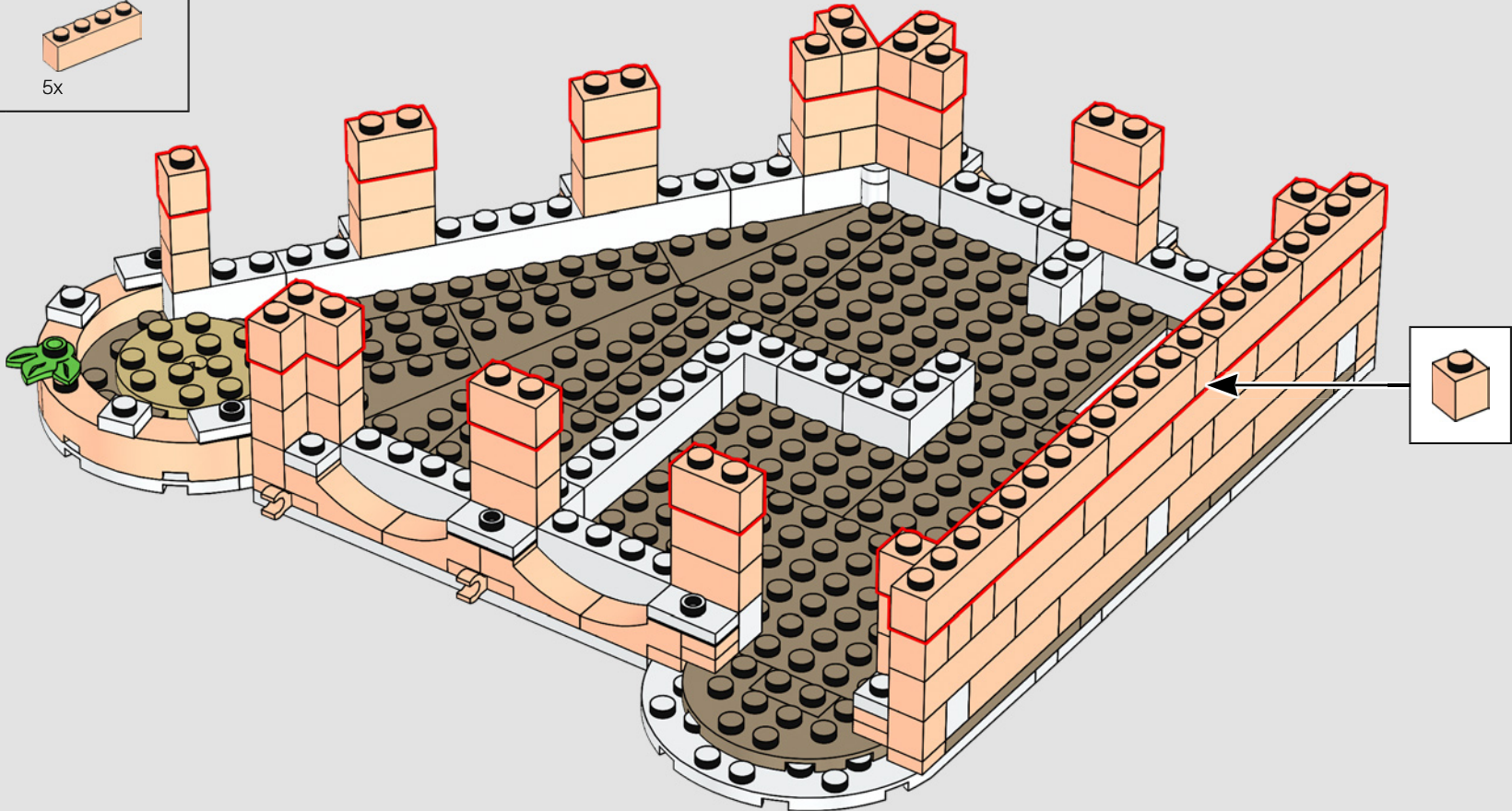



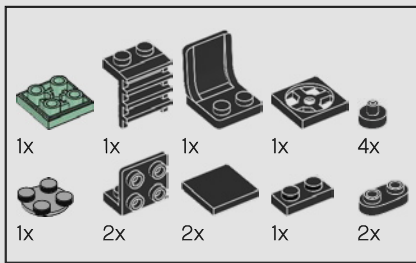

179

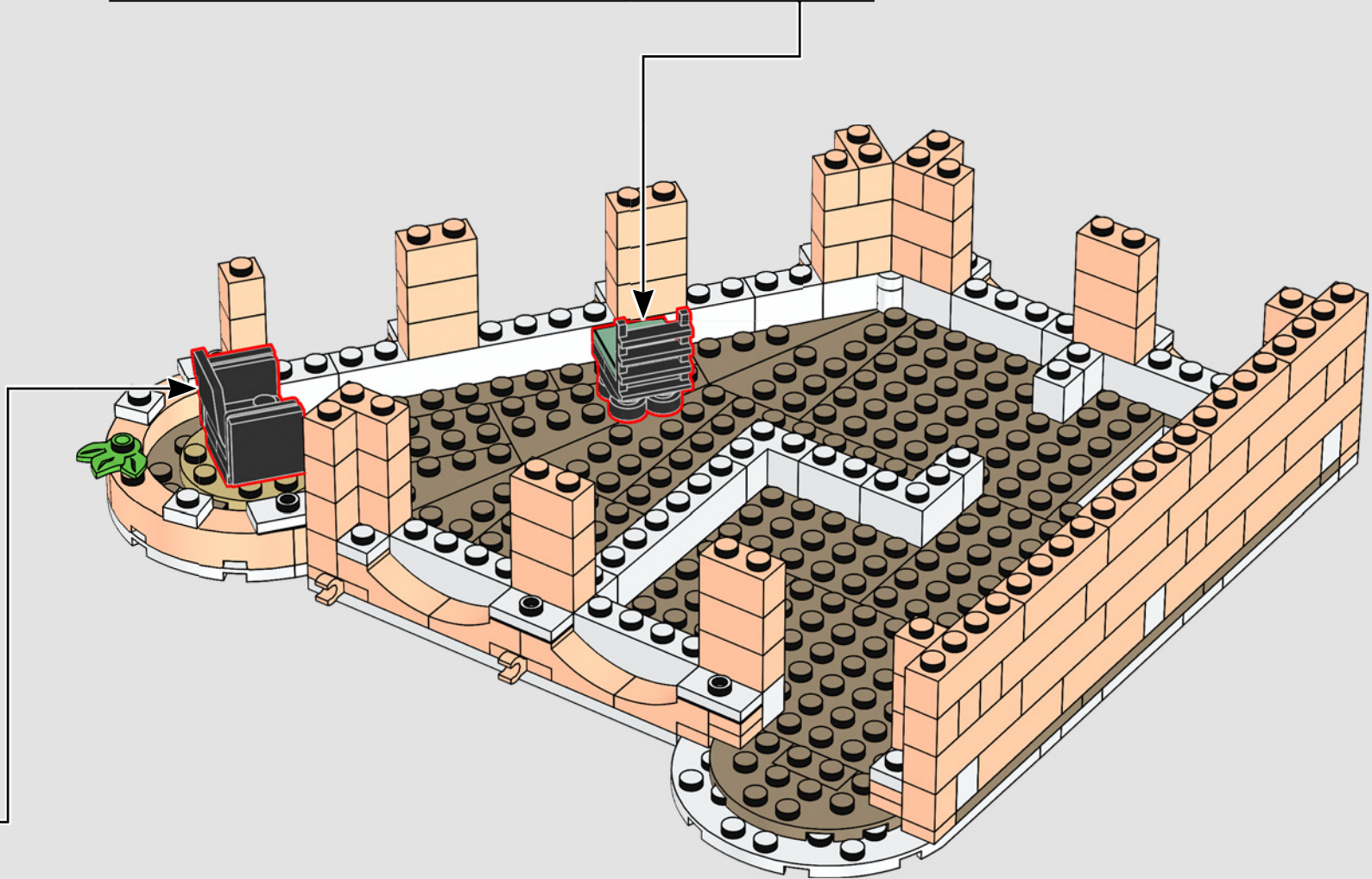
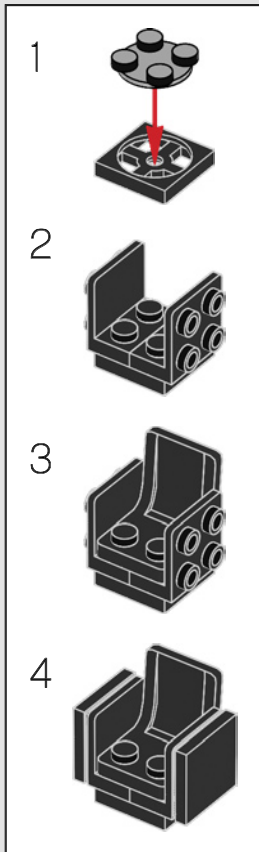
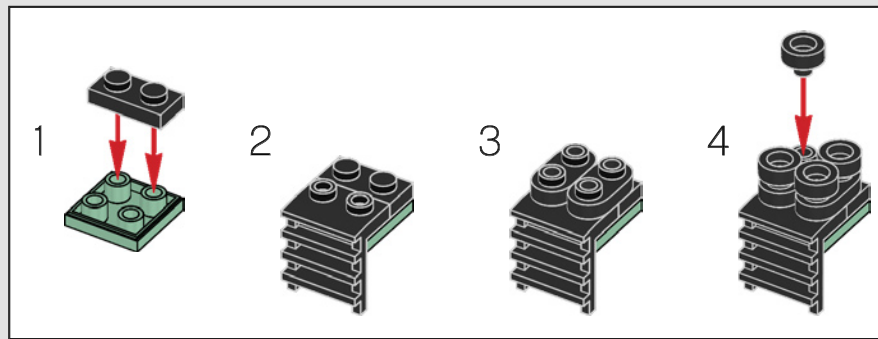

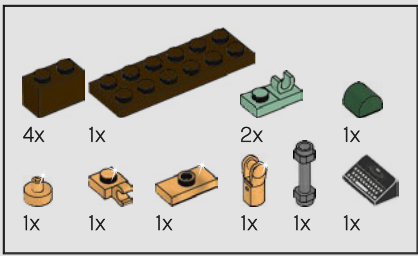

180

1

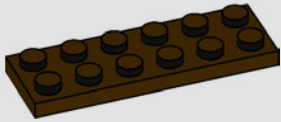

2

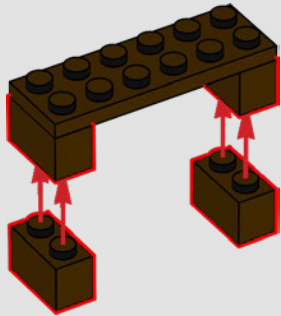

3

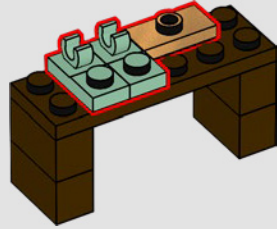

4

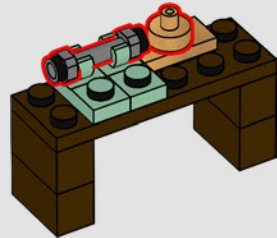

5

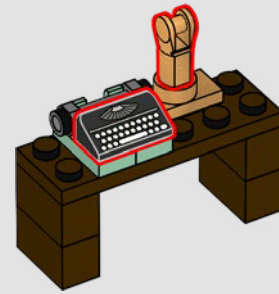

6

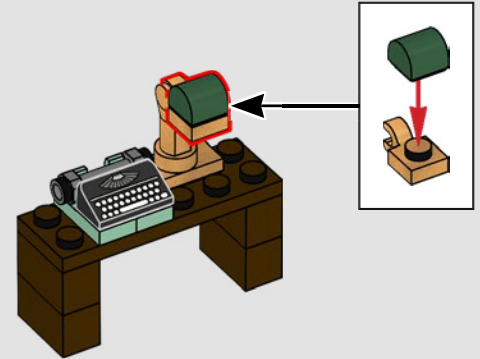

The local typewriter company has recently made sales to both the Hotel and to the 10278 Police Station set.

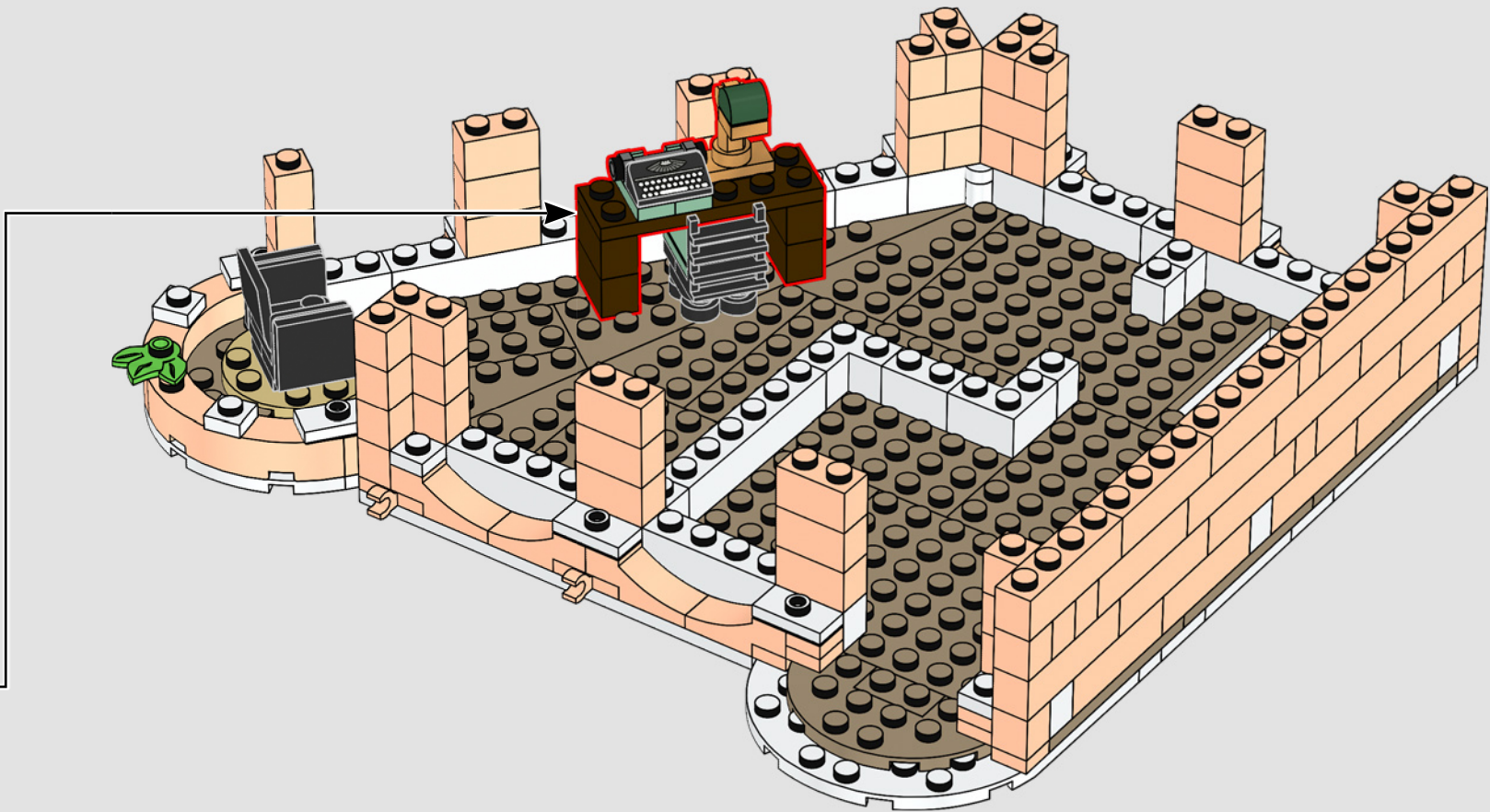

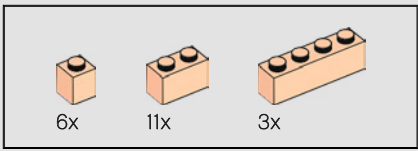

181

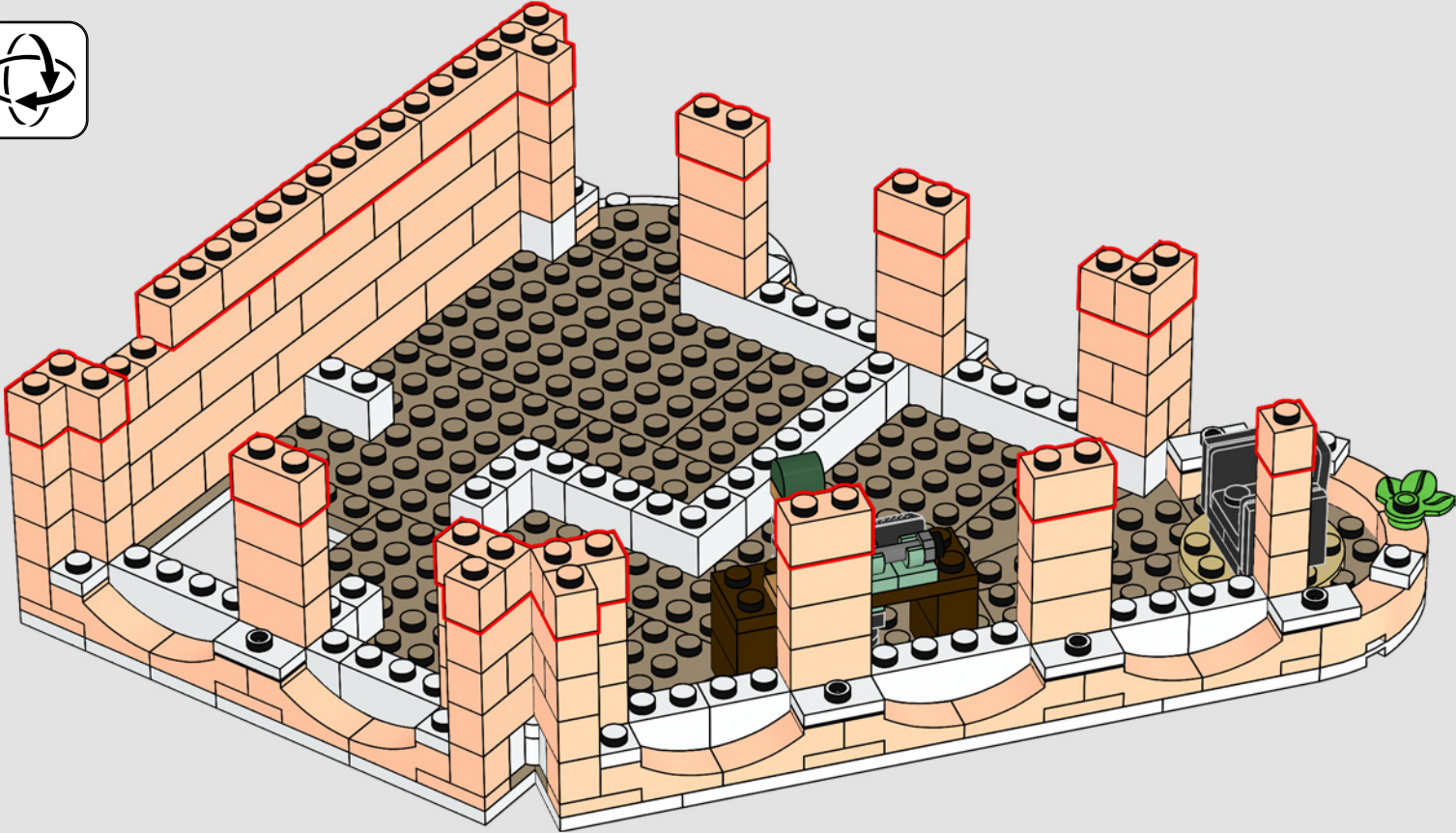

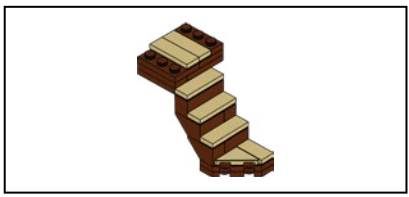

182

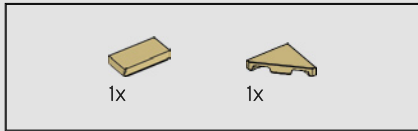
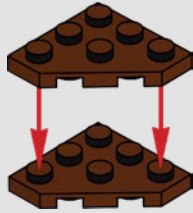

183

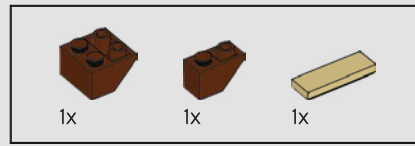

184

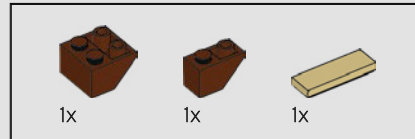
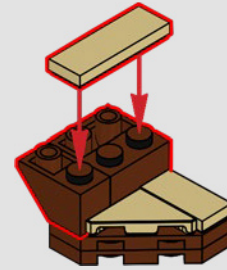

185

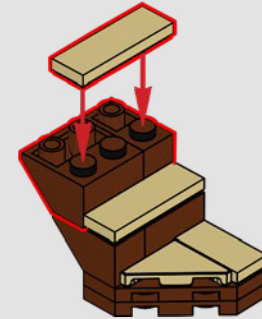

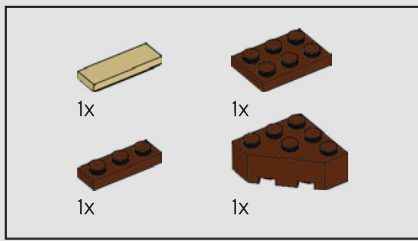

186

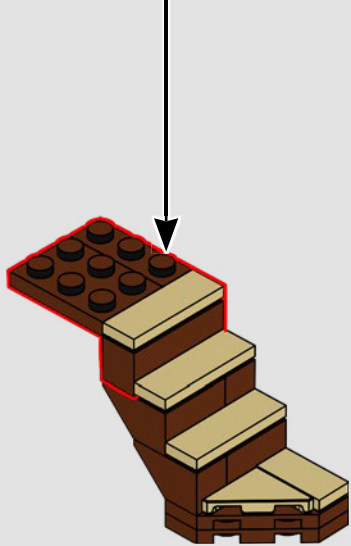
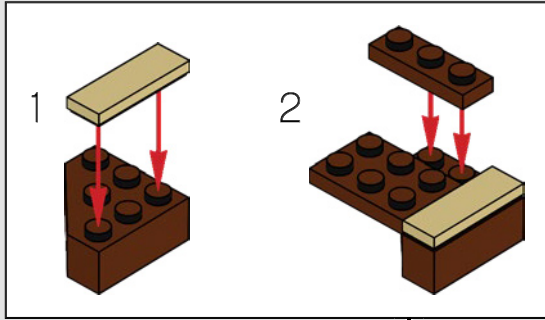

187

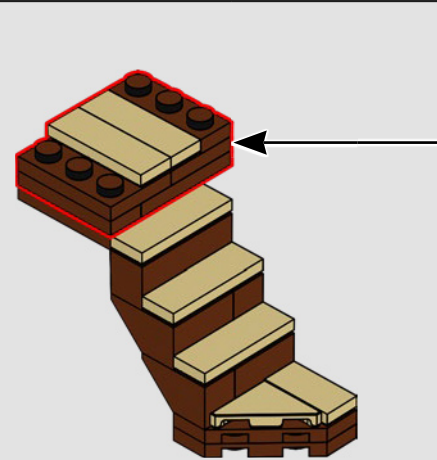
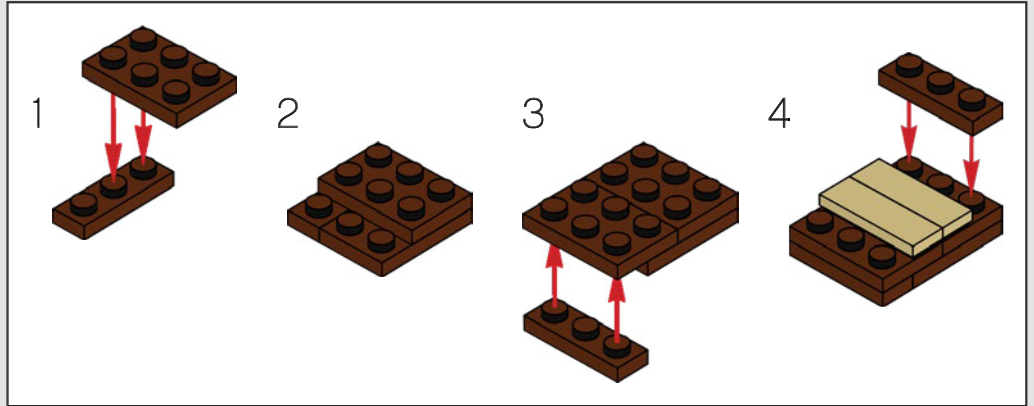

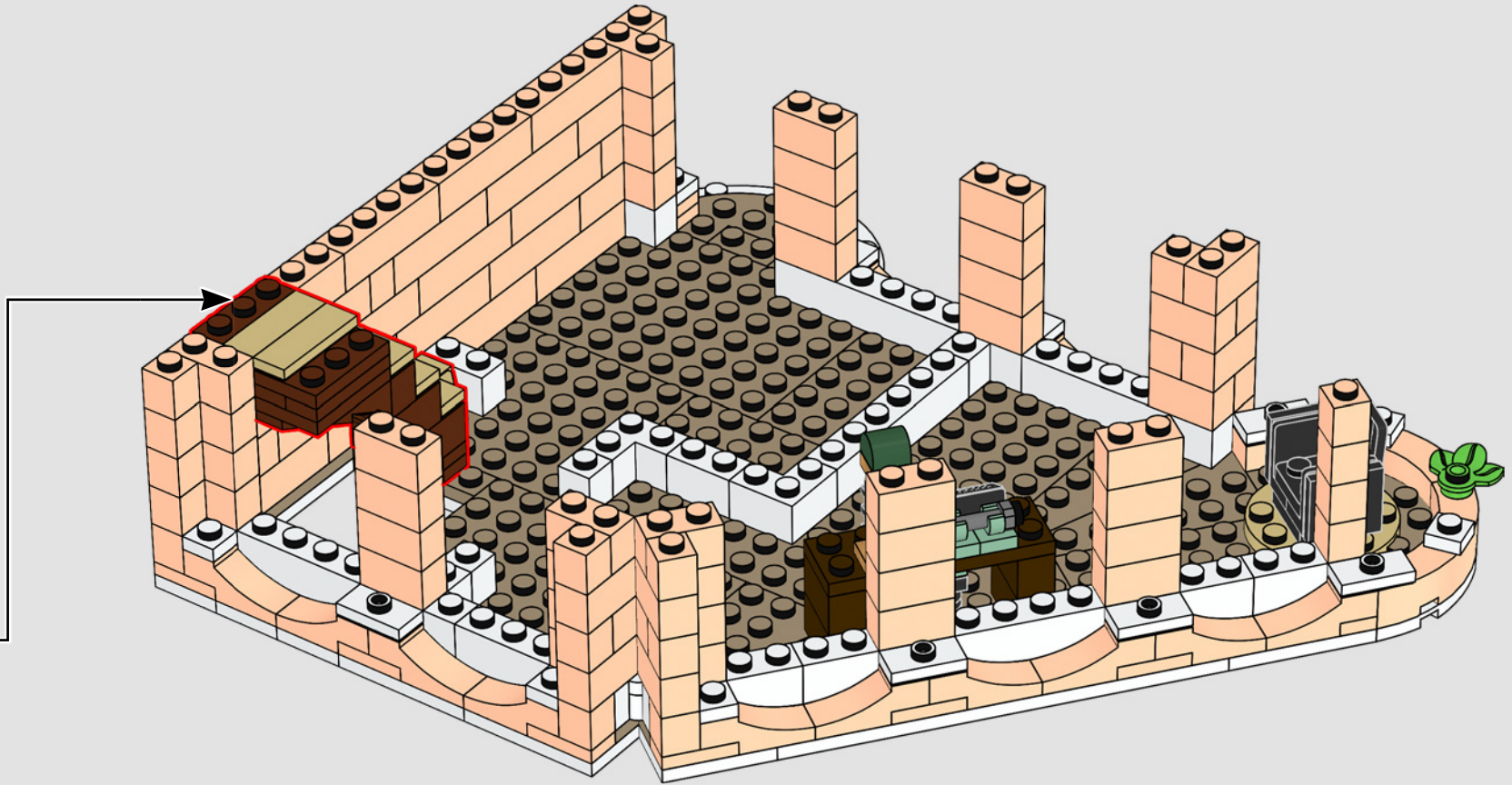

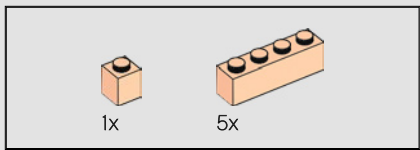

189

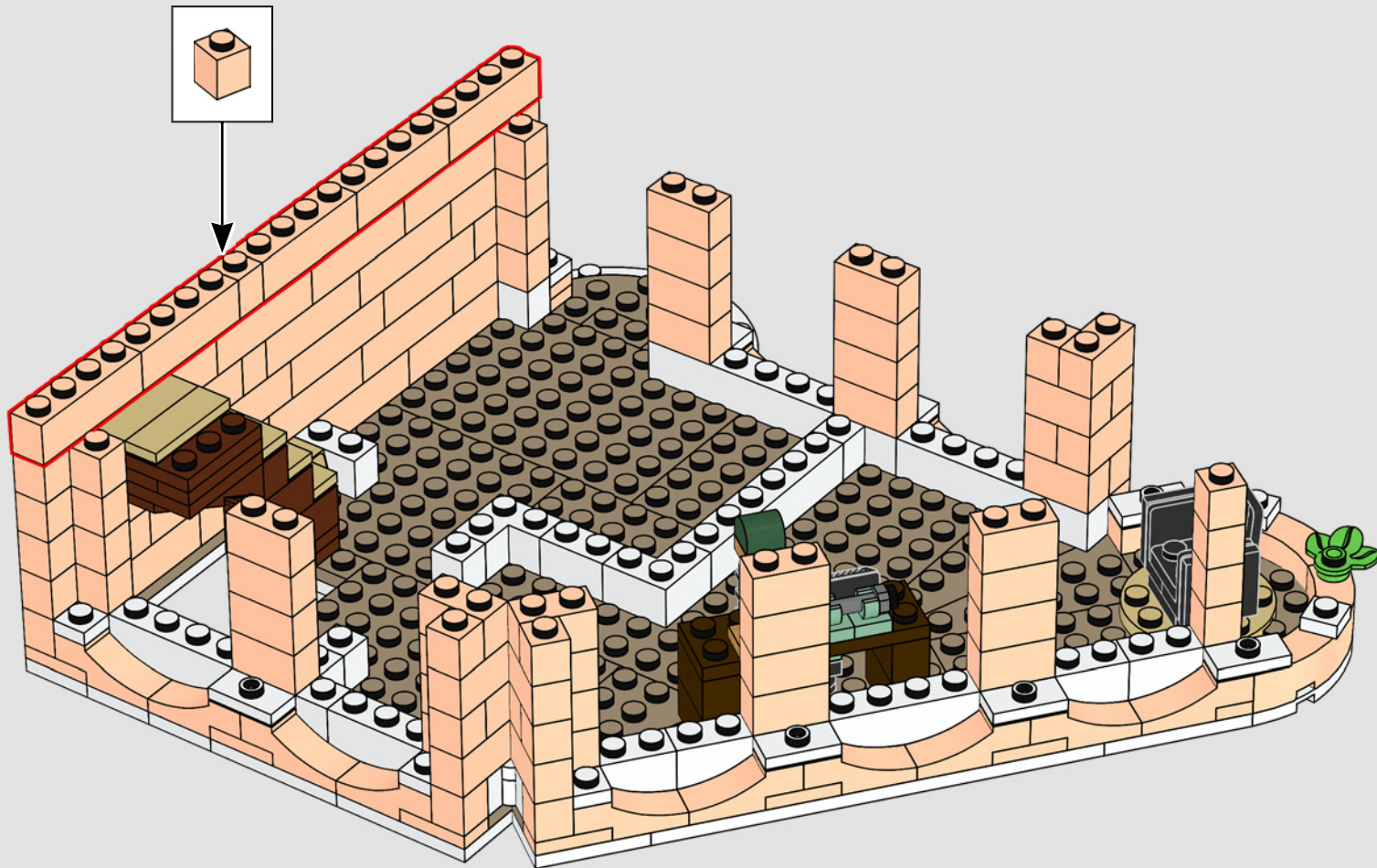



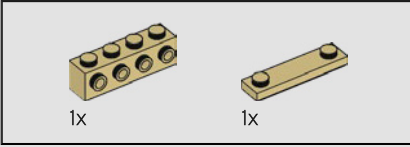
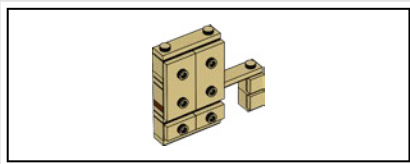

190

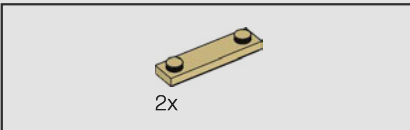
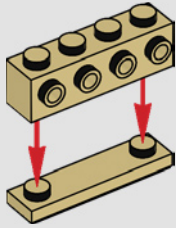

191

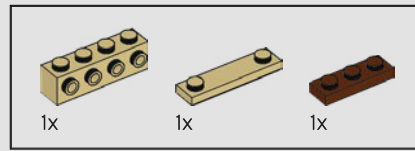
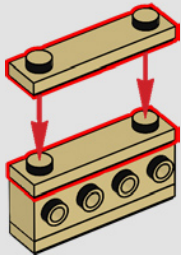

192

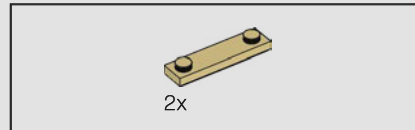
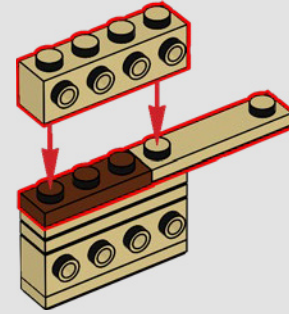

193

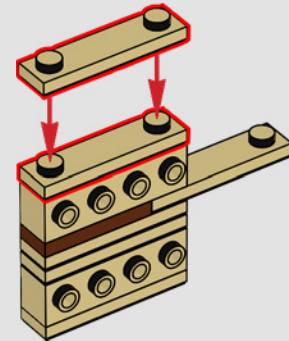

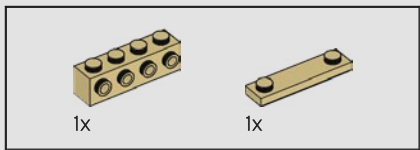

194

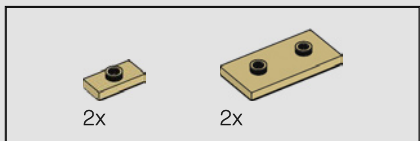
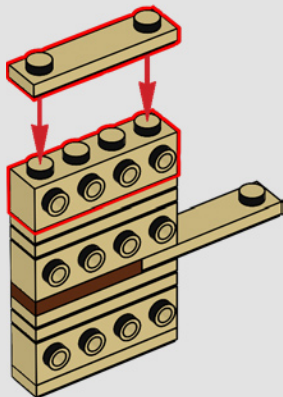

195

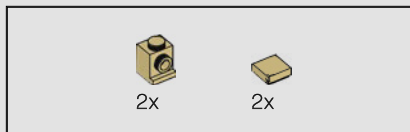
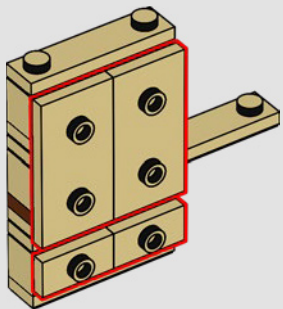

196

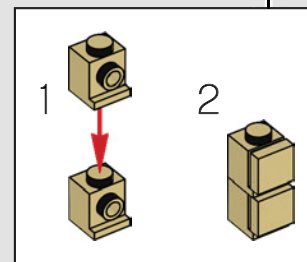
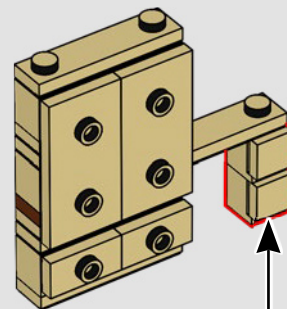

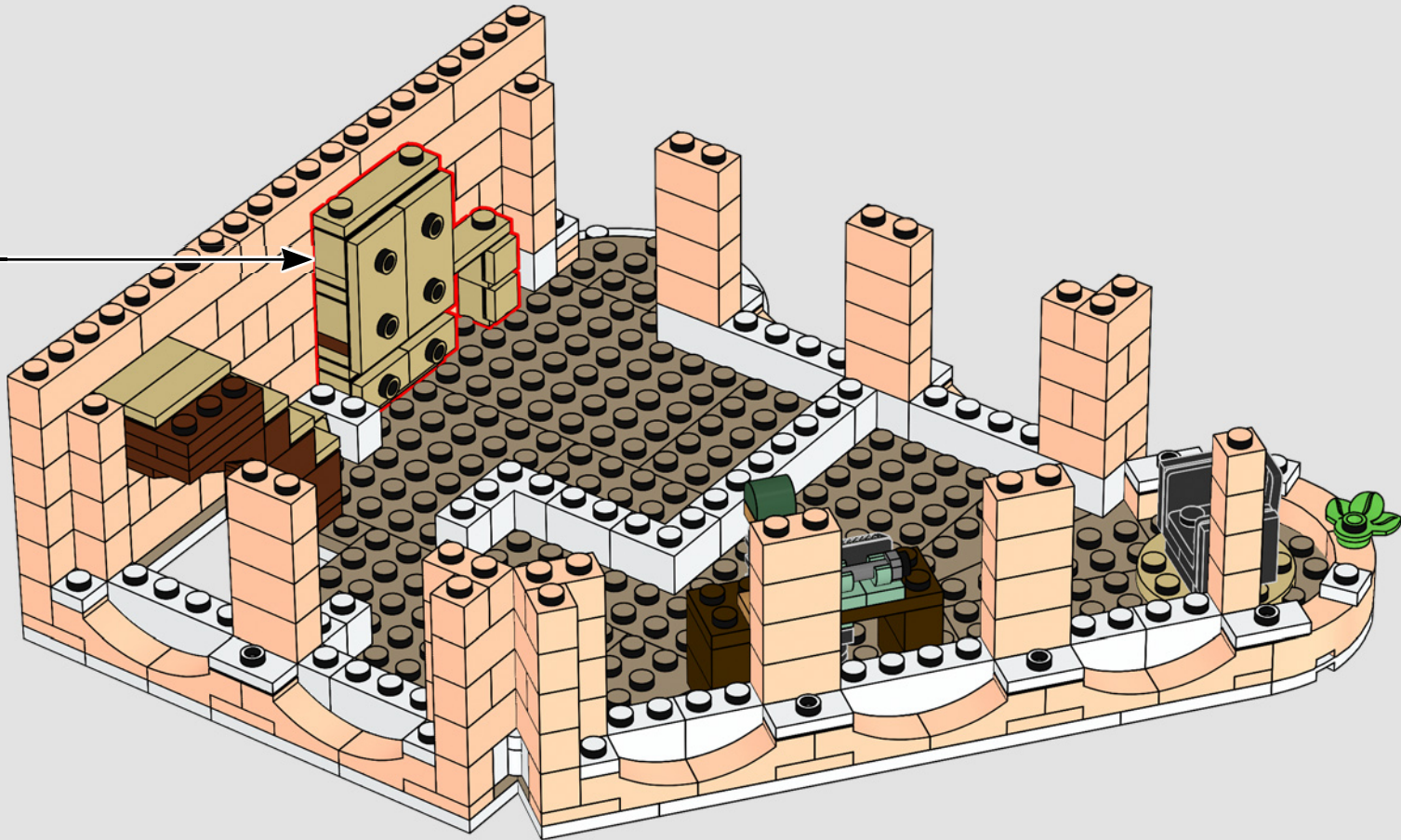

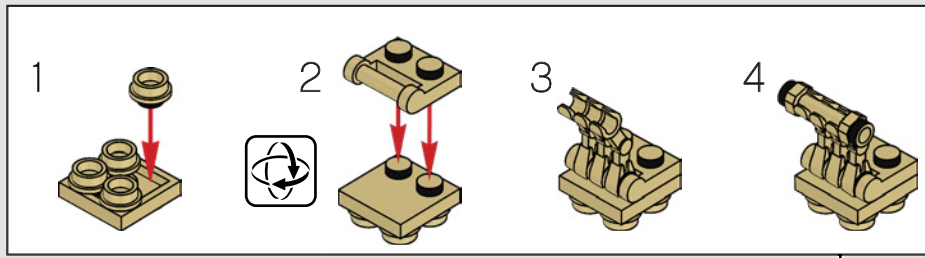
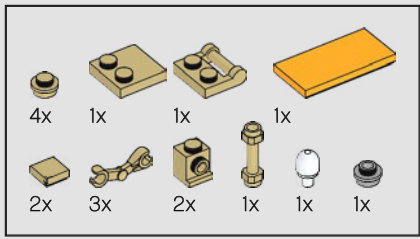

198

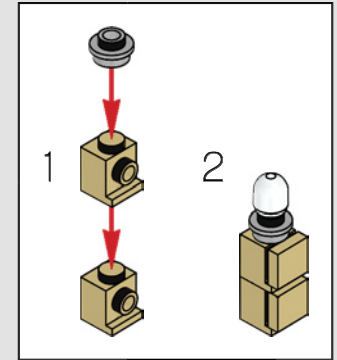
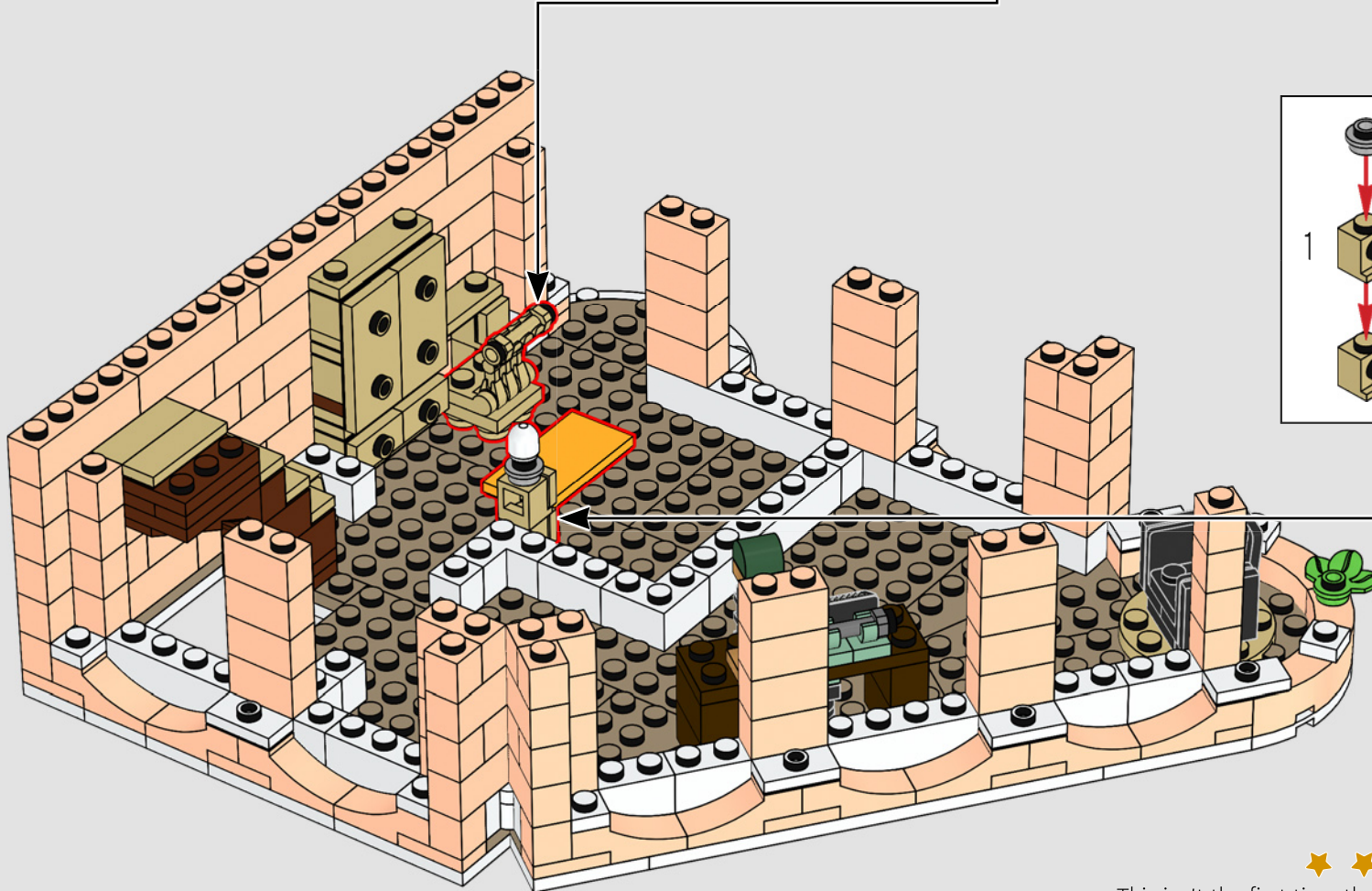

This isn't the first time these robot arms have been used in a modular model... you can also find them forming the railing of the balcony in the 10190 Market Street set.

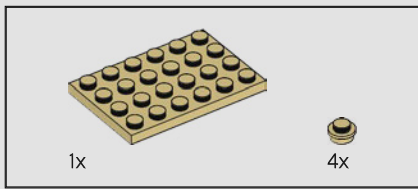

199

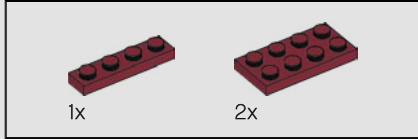
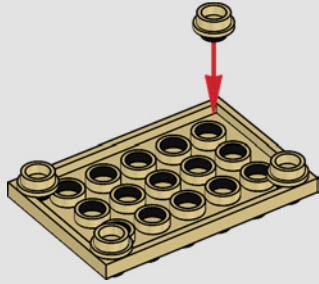

200

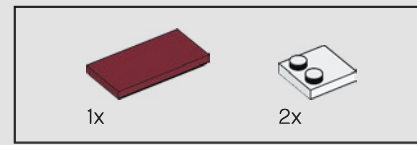
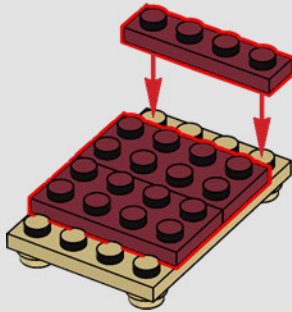

201

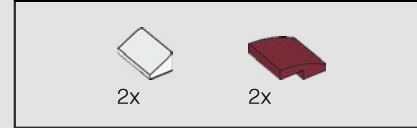
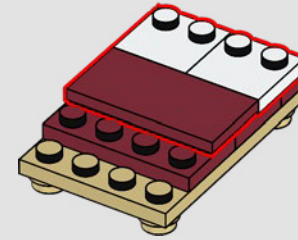

202

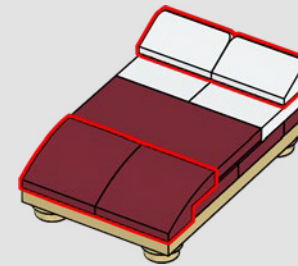

203

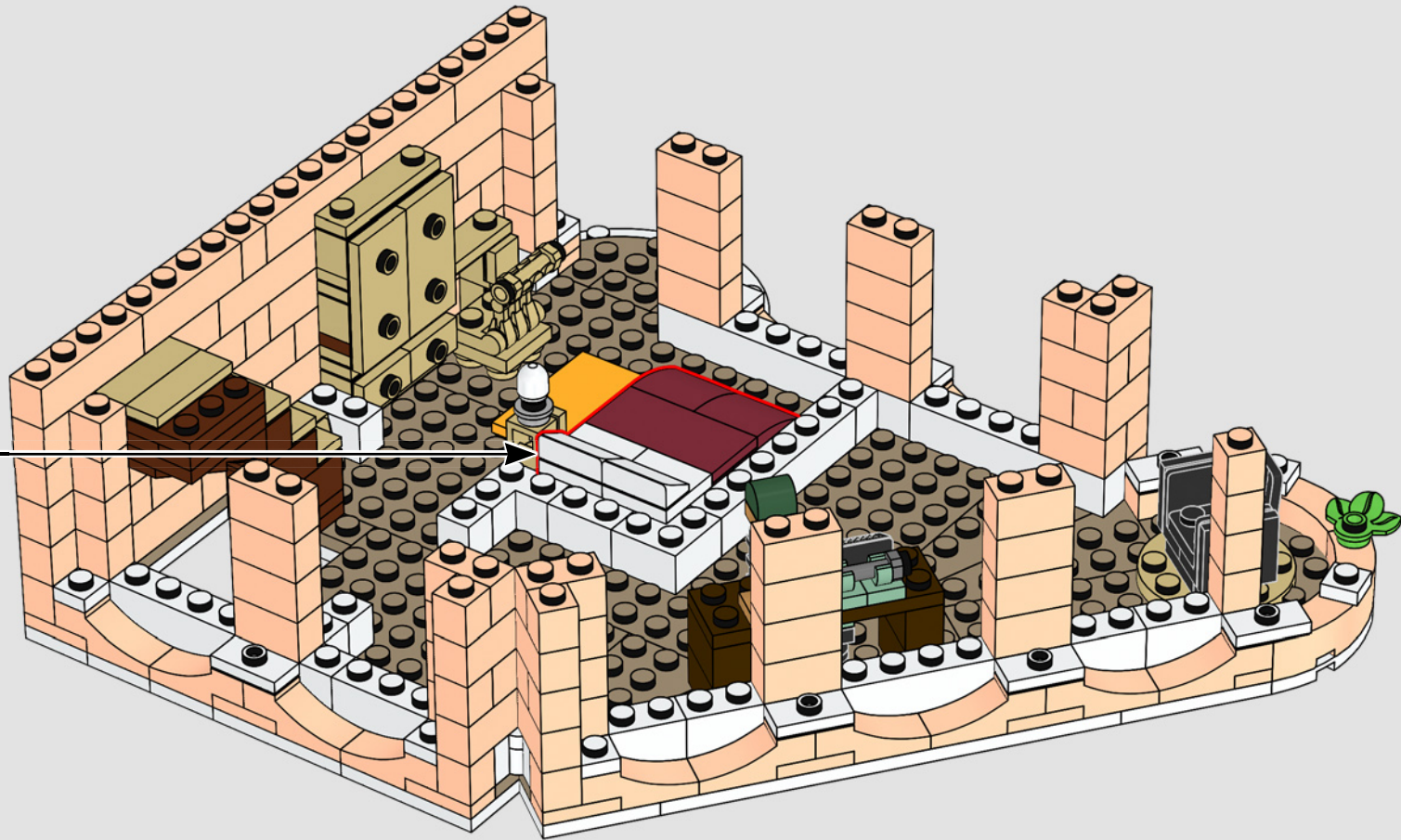

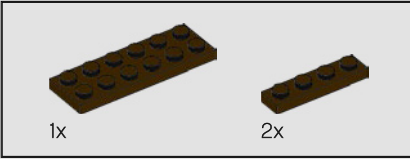
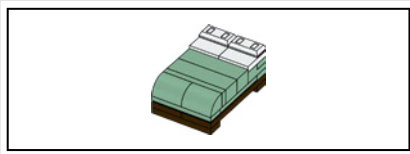

204

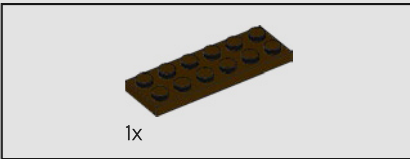
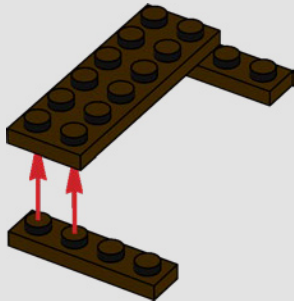

205

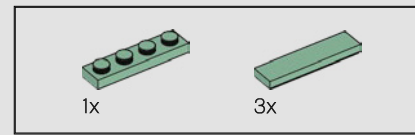
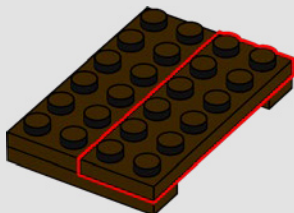

206

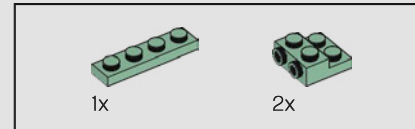
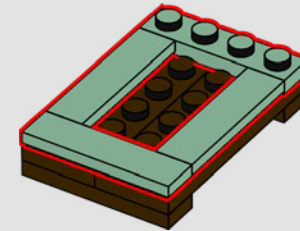

207

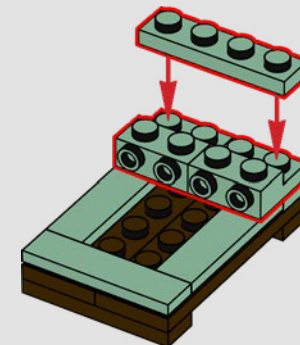





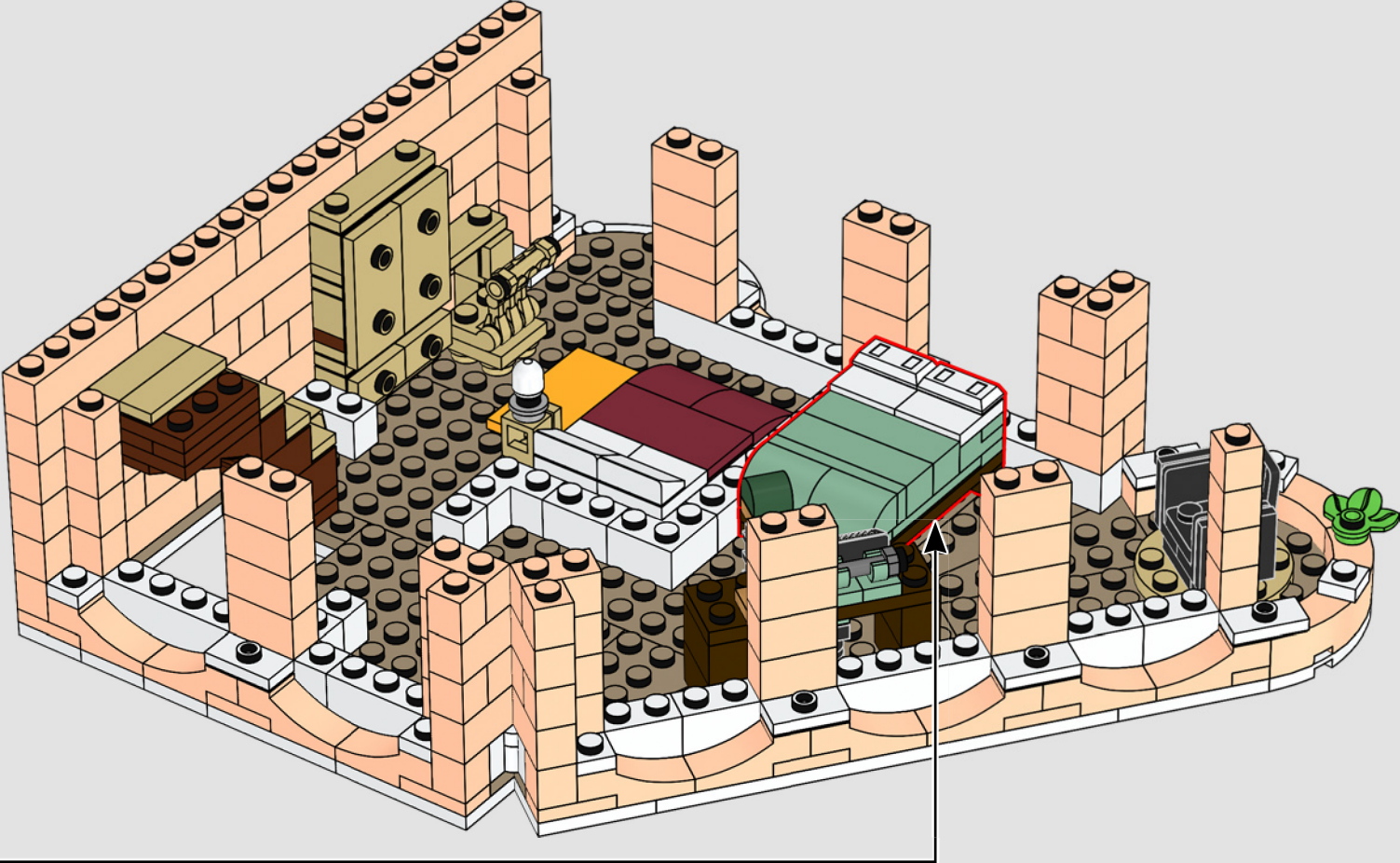

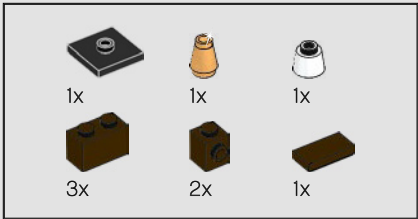

212

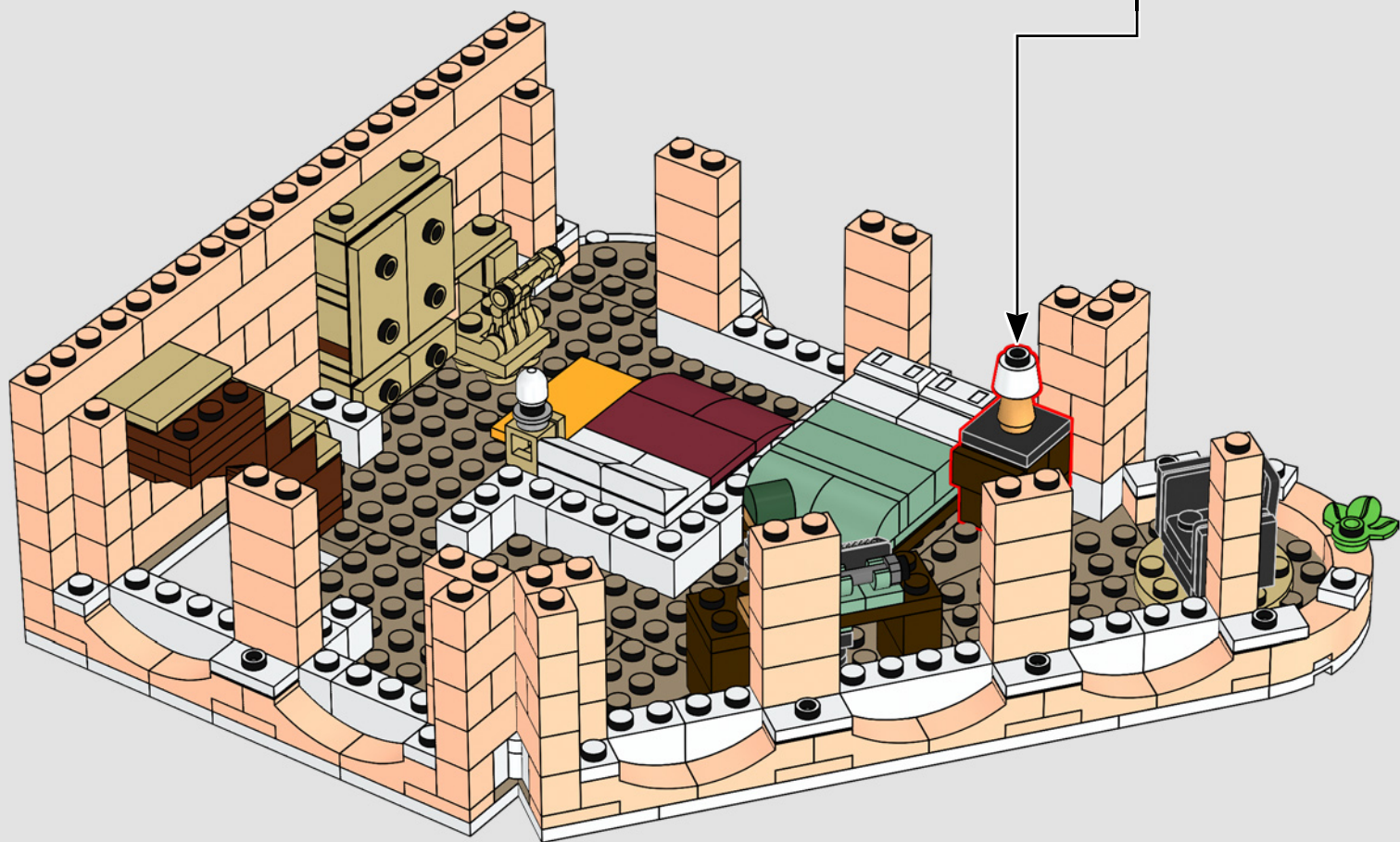
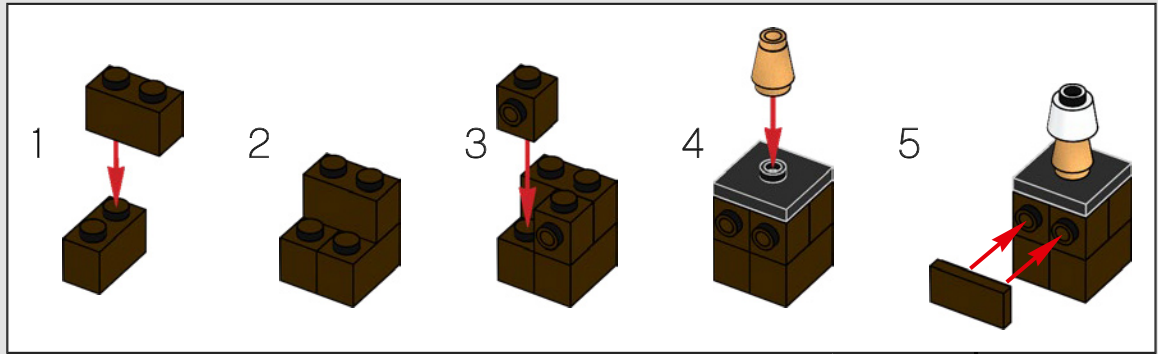

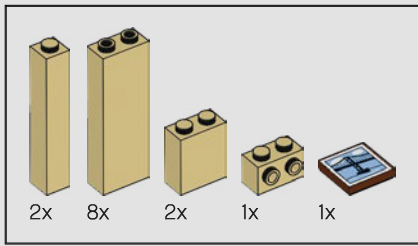

213

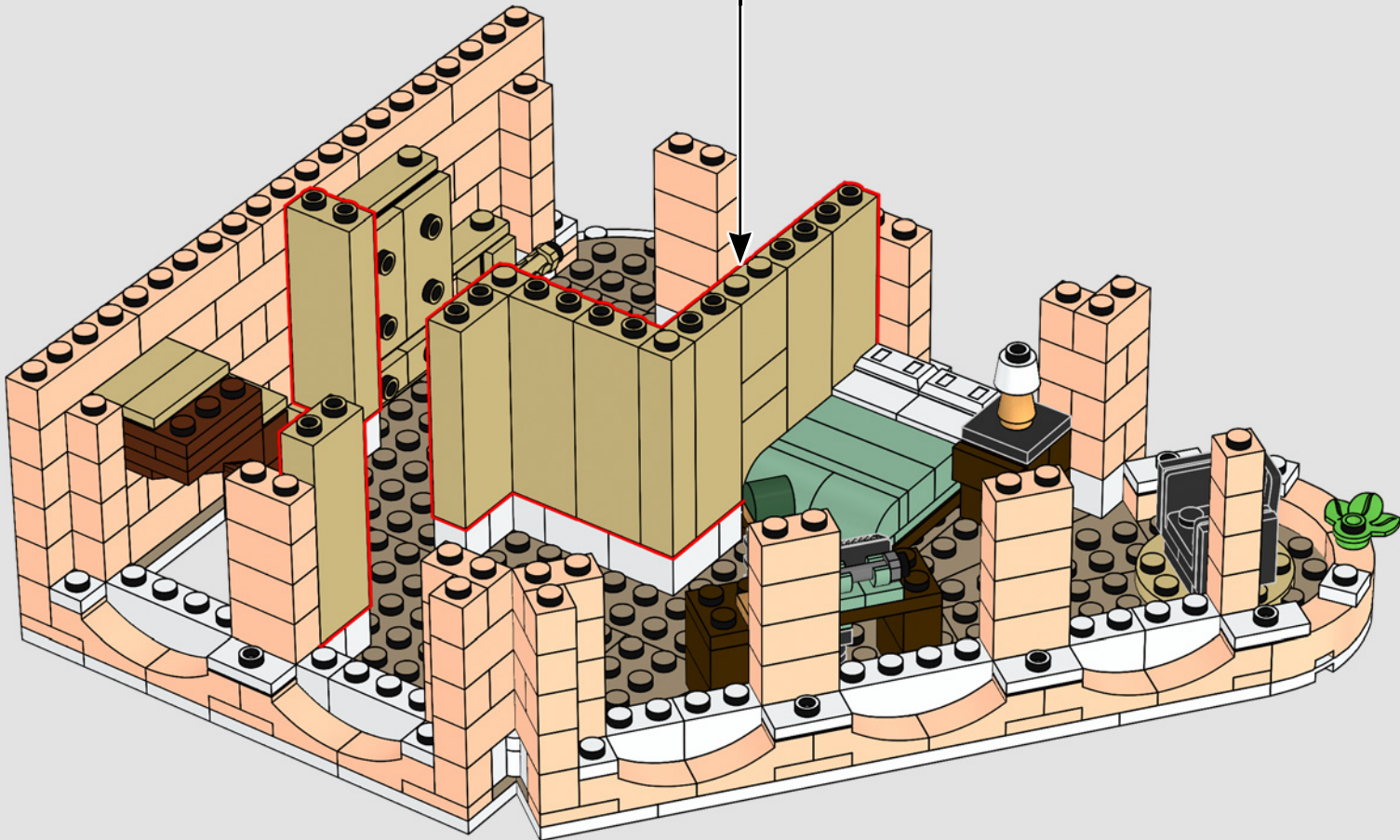
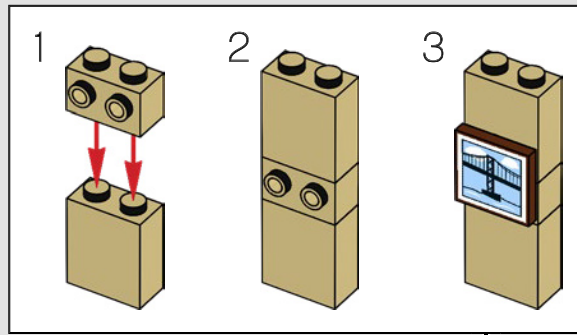

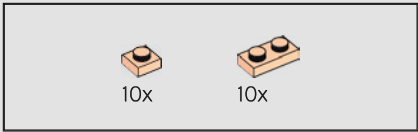

214

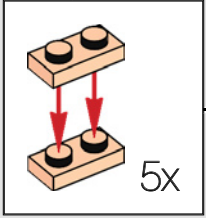
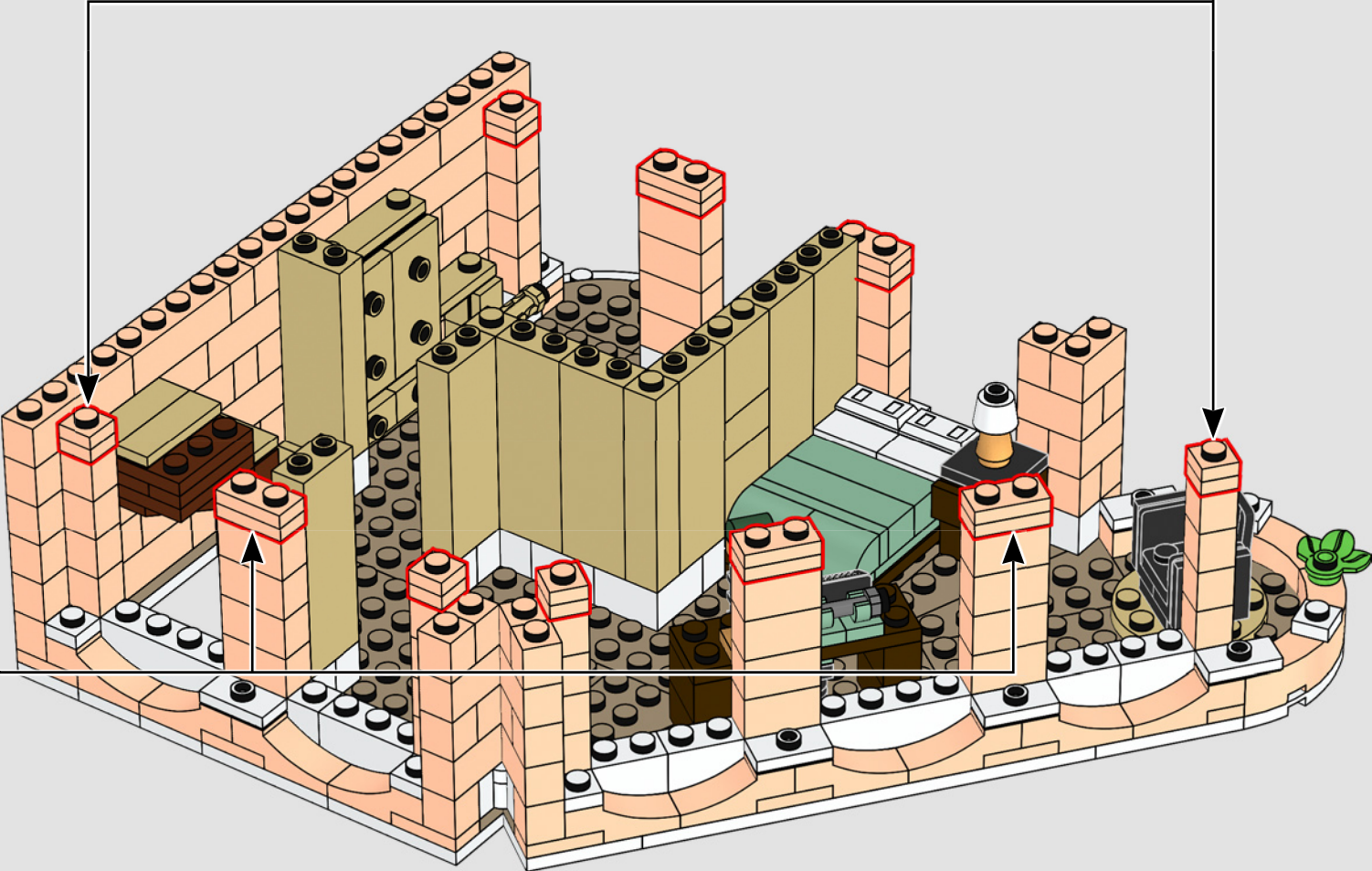
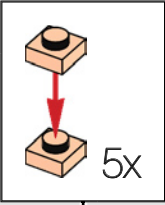

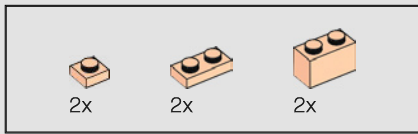

215

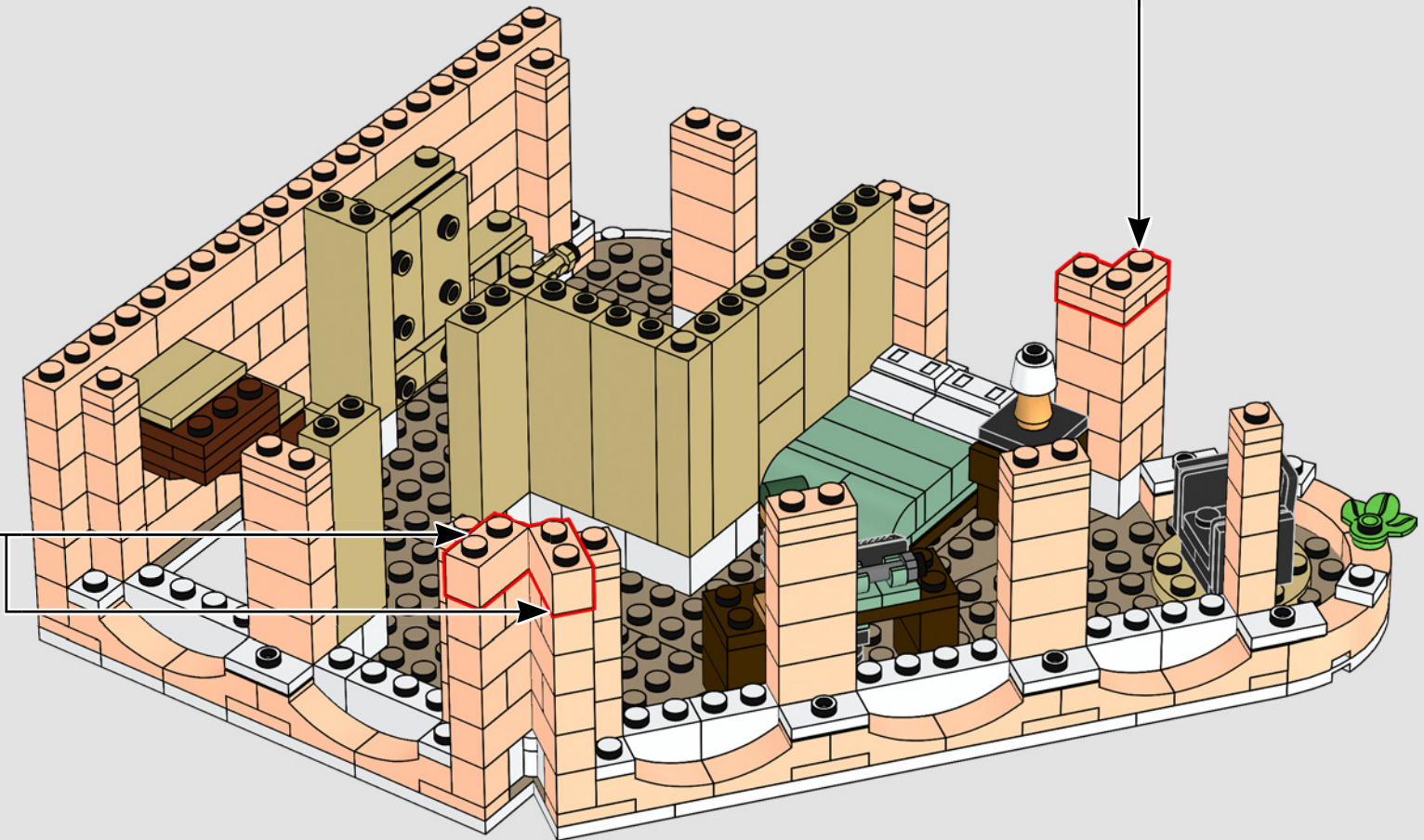
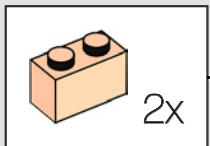
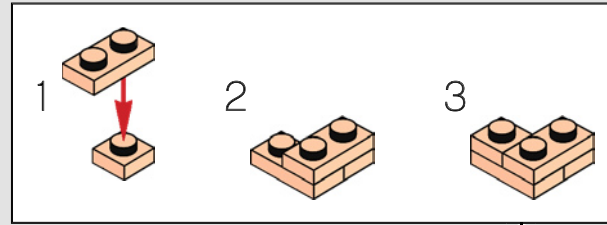

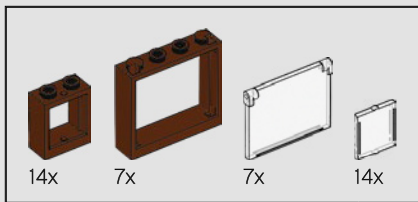

216

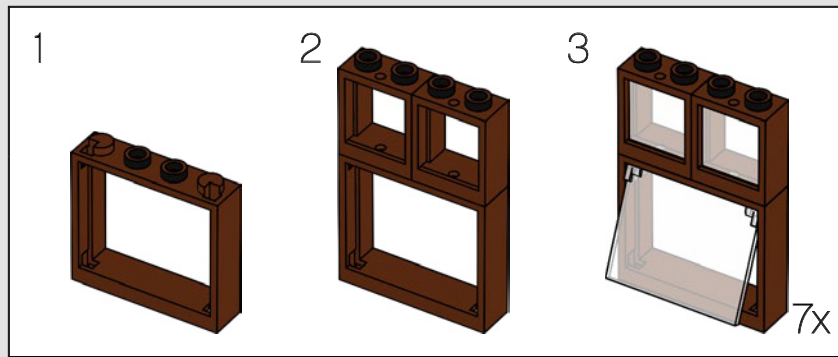

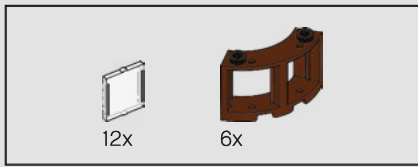

217

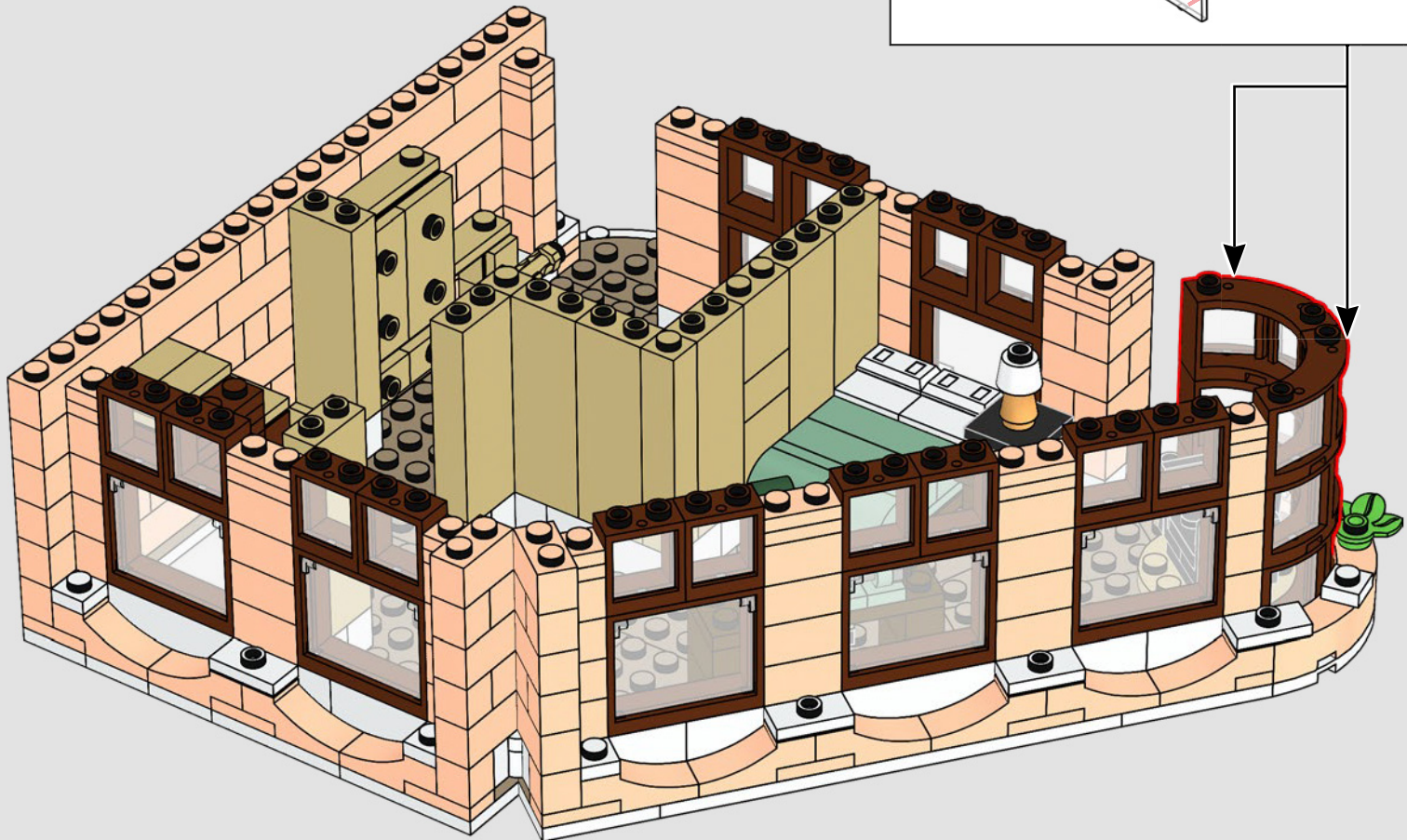
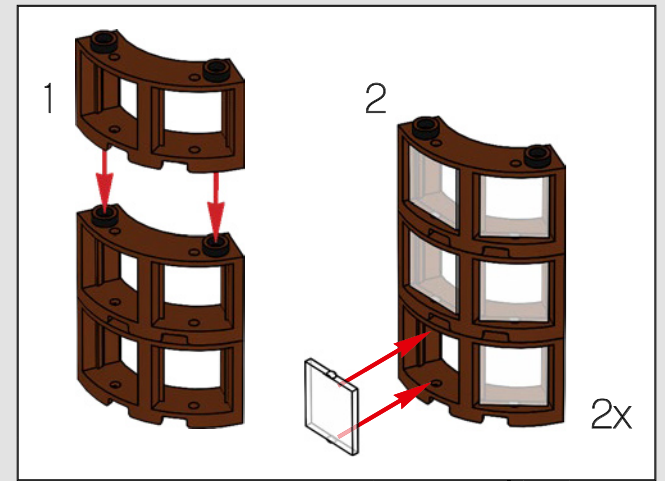

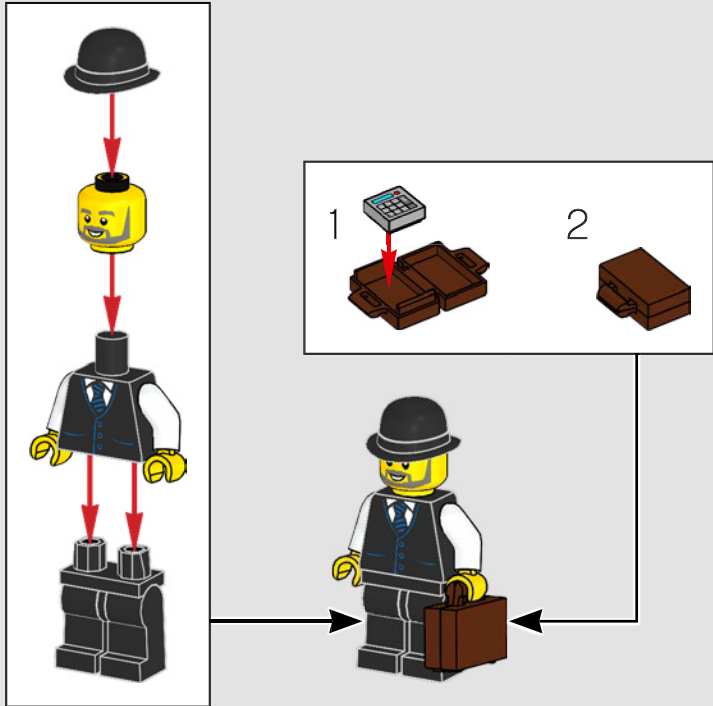
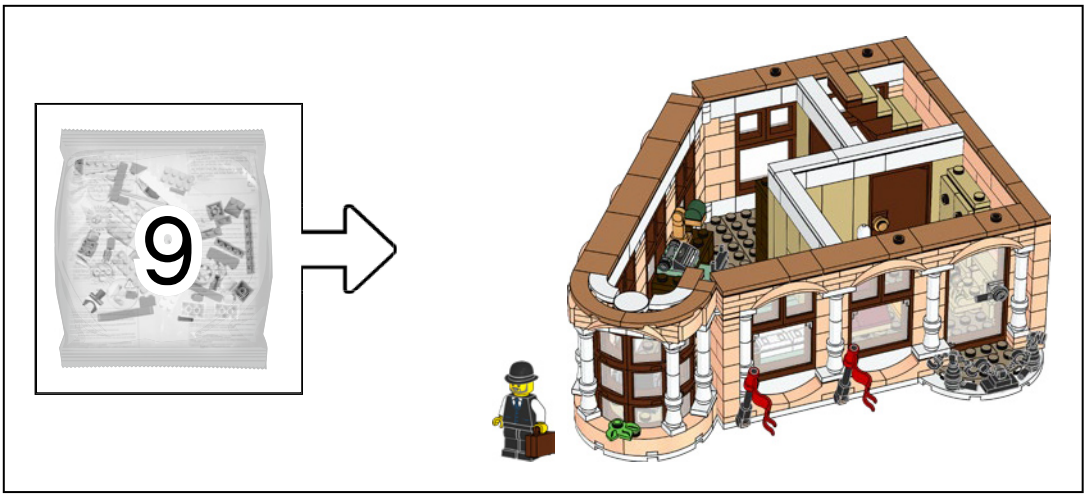

The Accountant is in town to assist with the sale of the Art Gallery's masterpieces. However, he's also been asked to audit the accounts from the 10251 Brick Bank set.



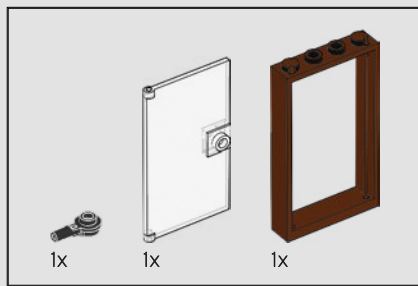

218

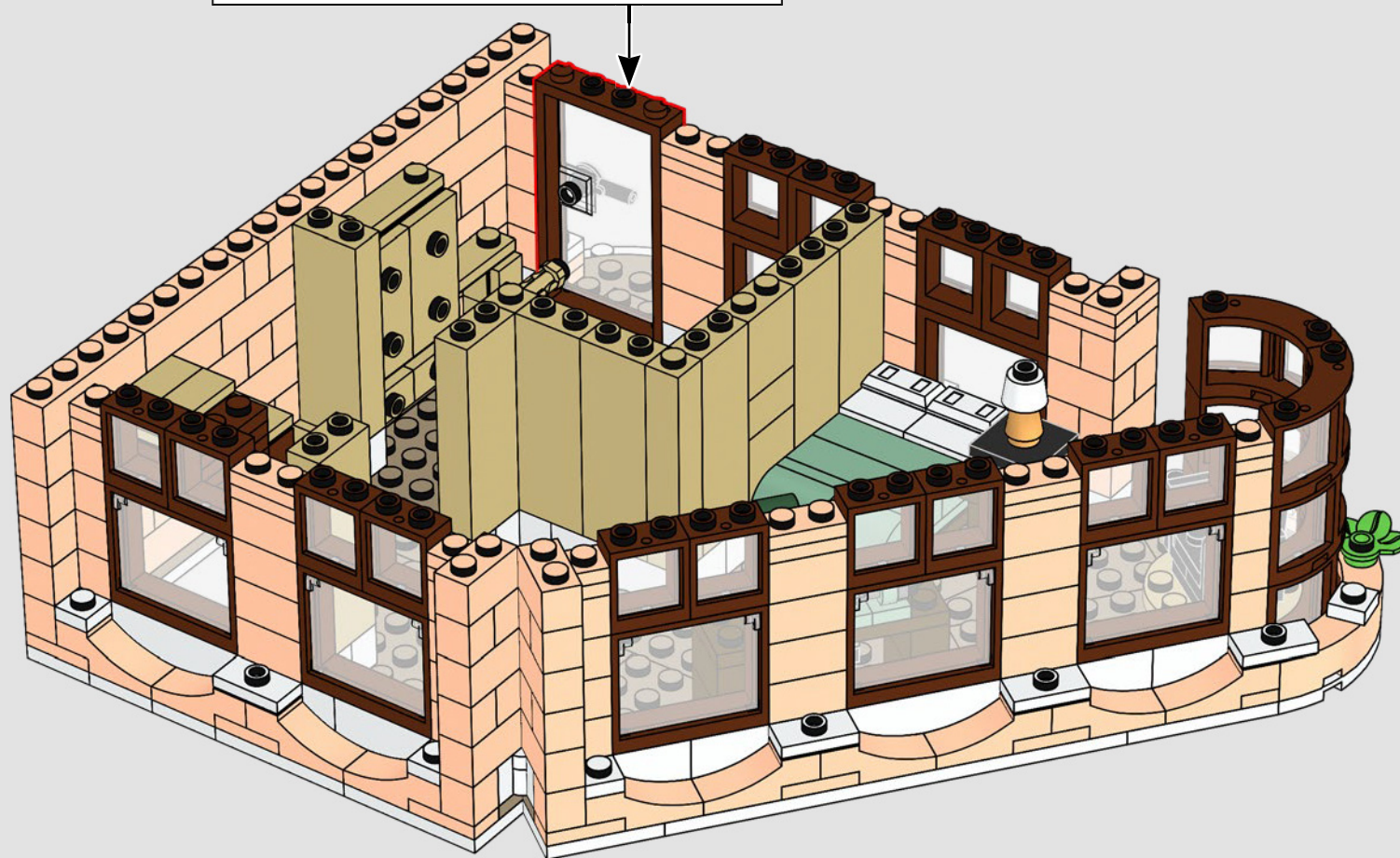
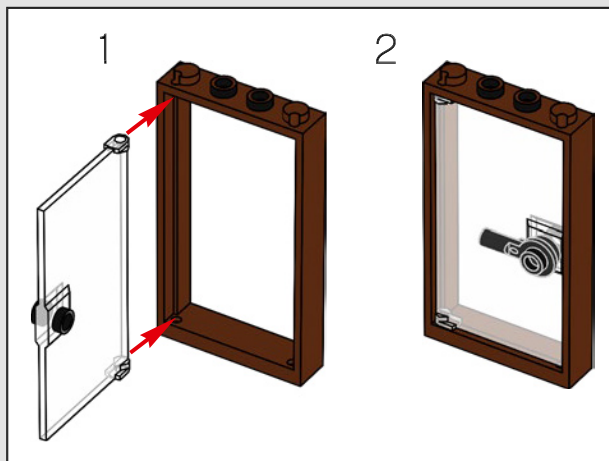

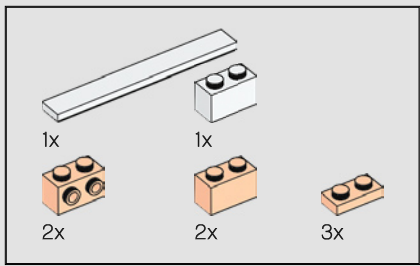

219

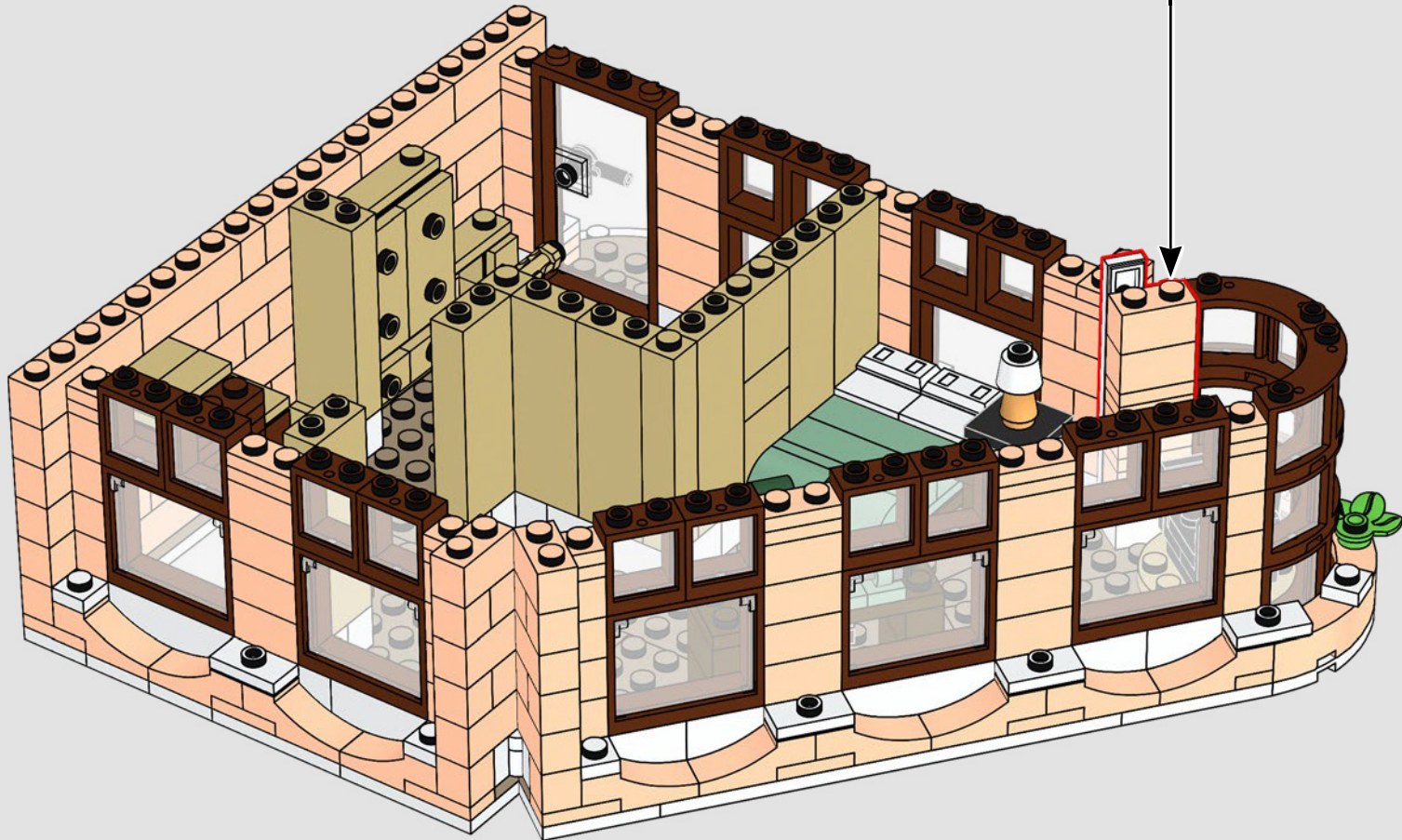
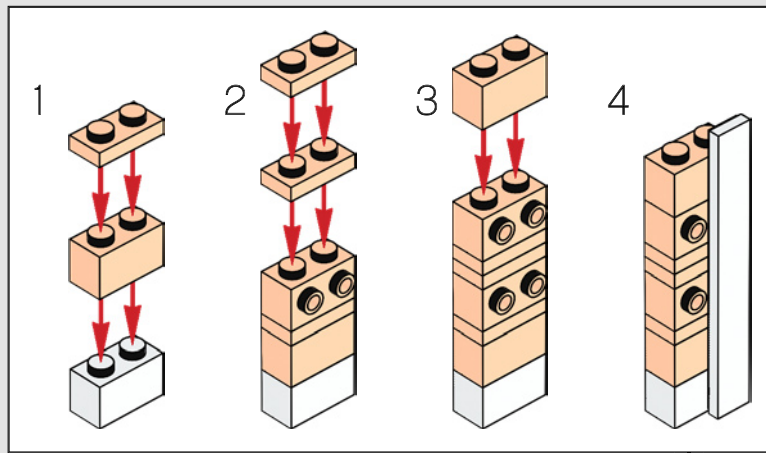

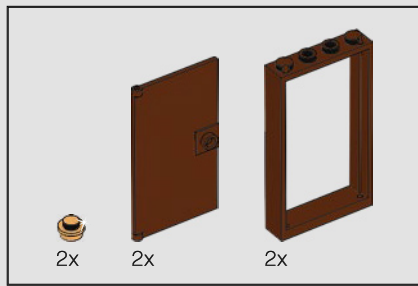

220

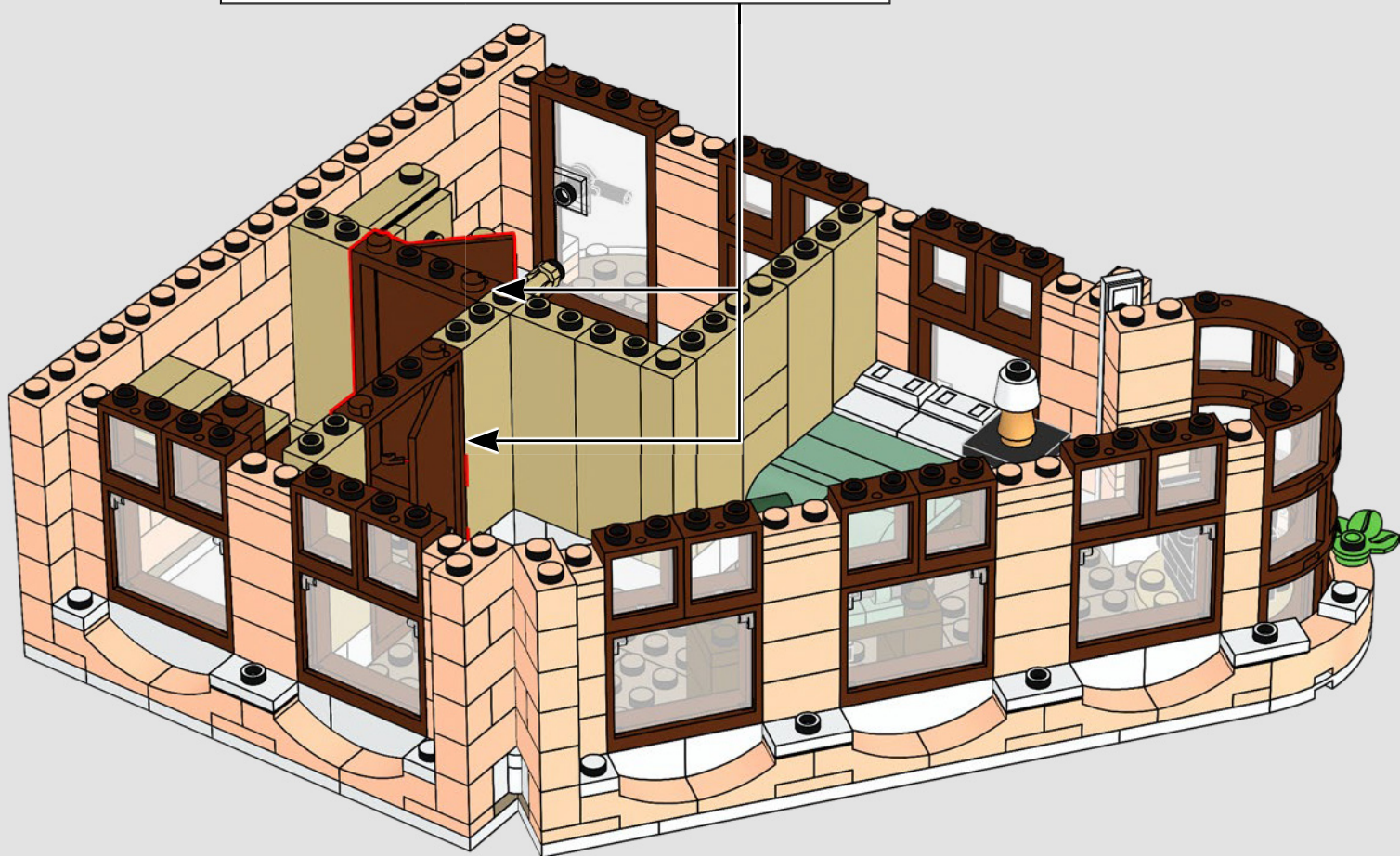
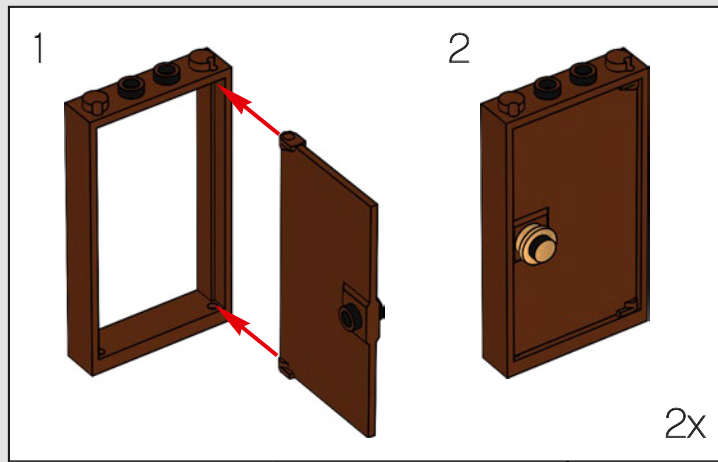

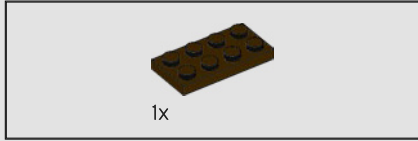
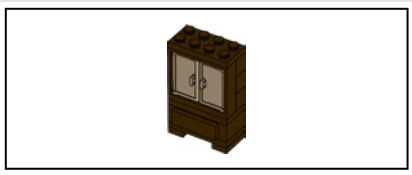

221

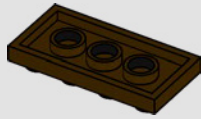

222

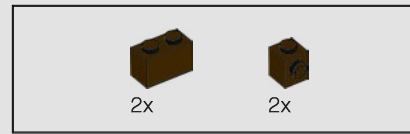
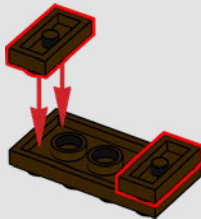

223

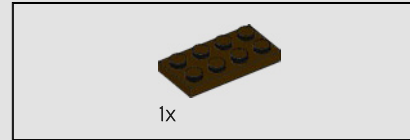
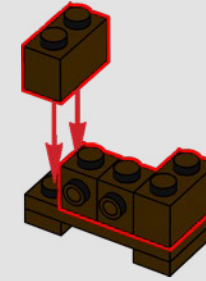
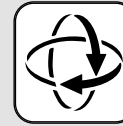

224

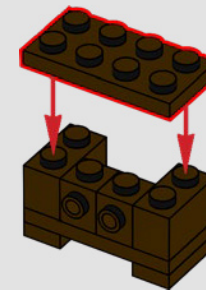

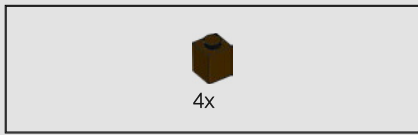

225

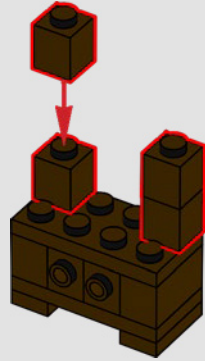

226

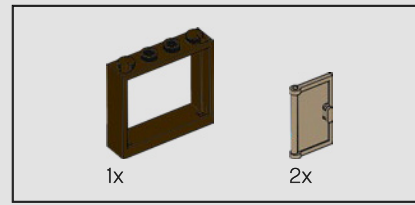
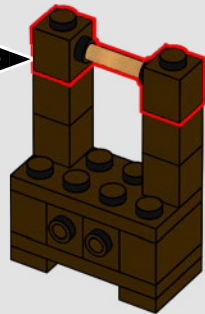
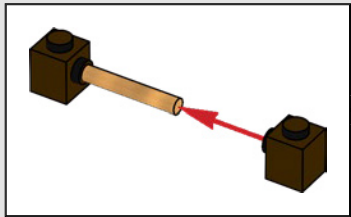

227

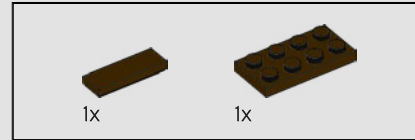
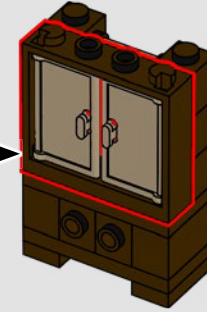
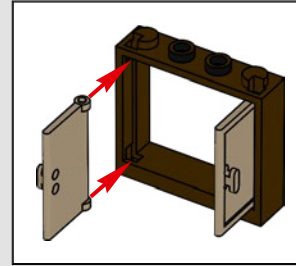

228

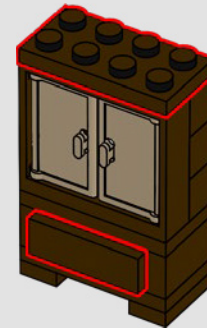

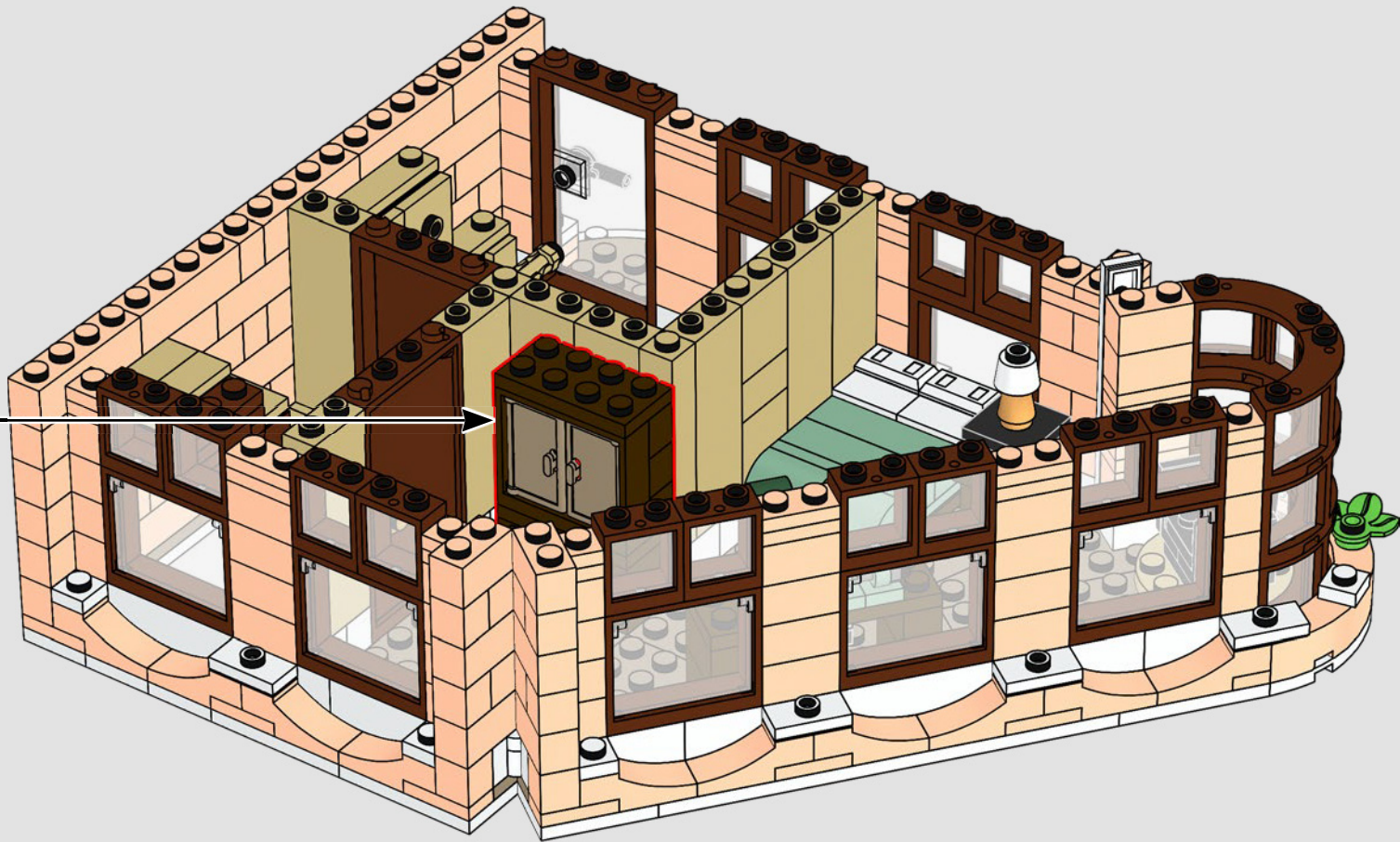



230

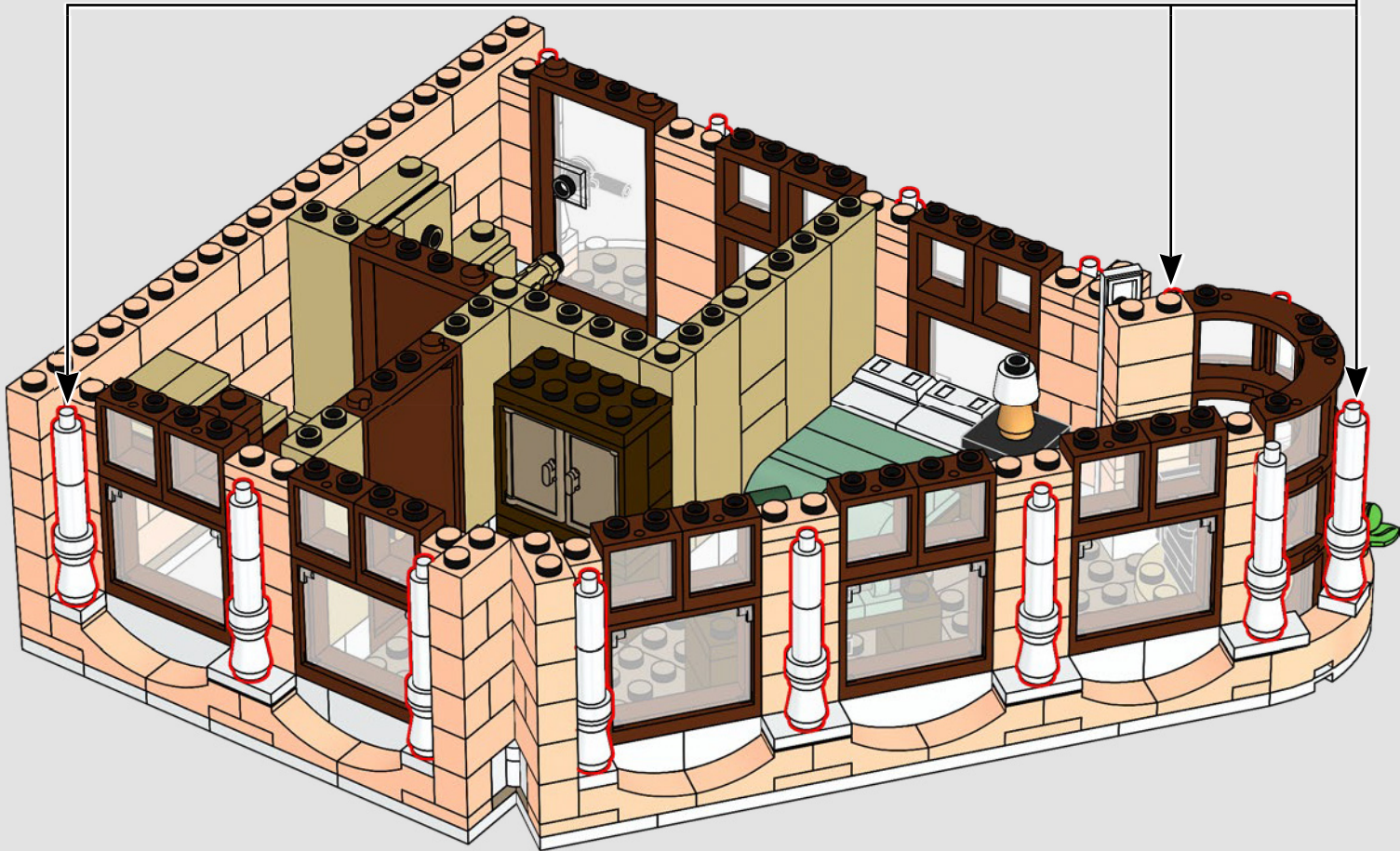
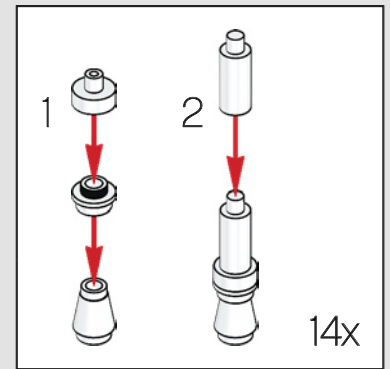

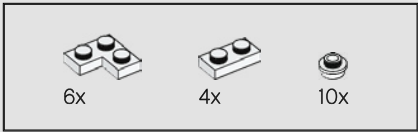

231

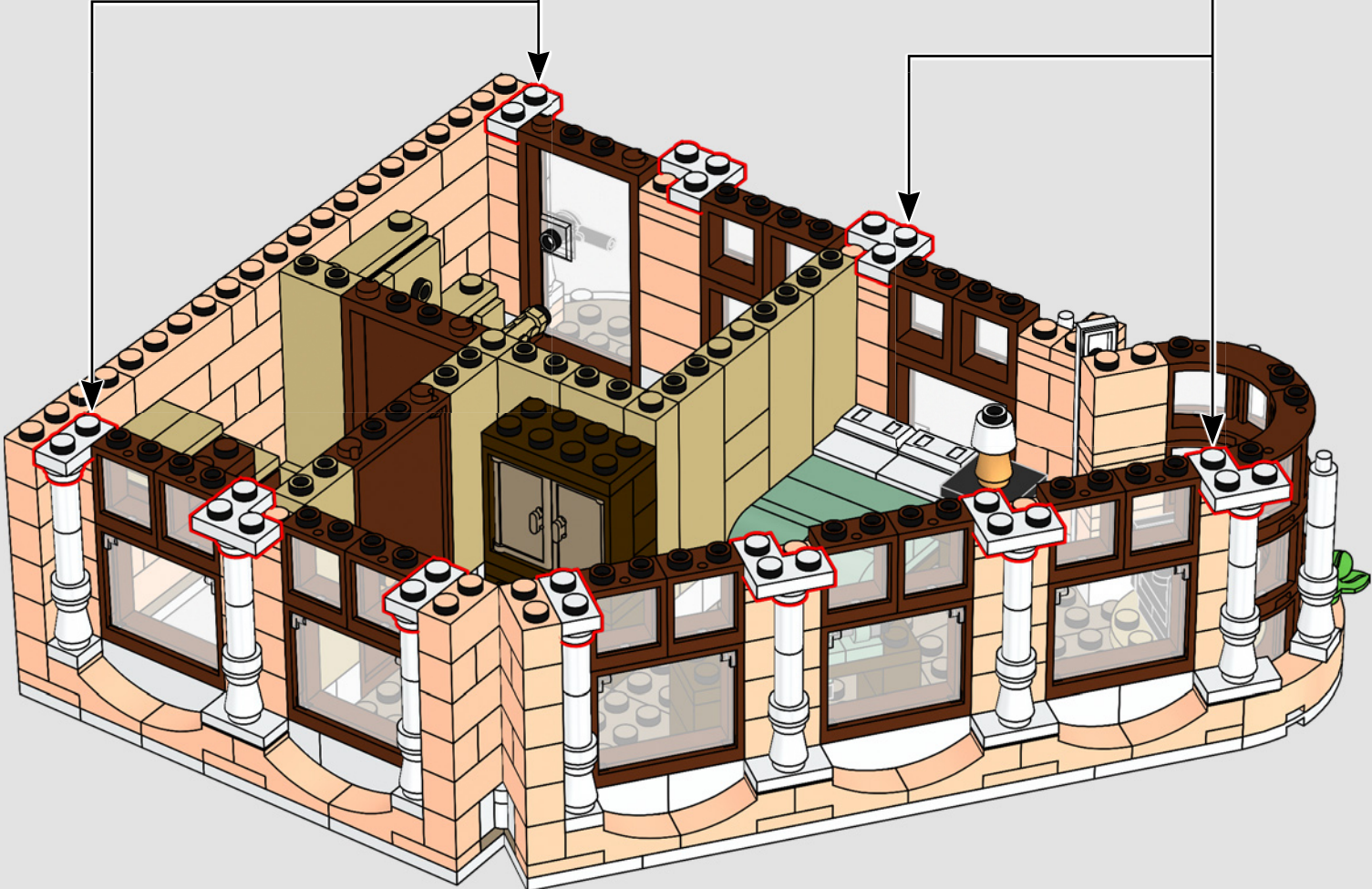
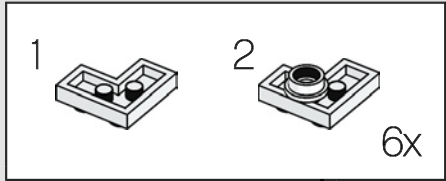
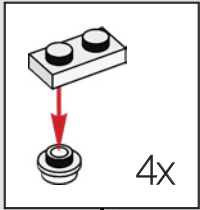



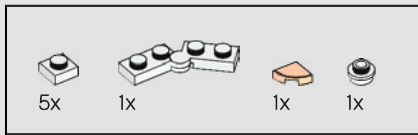

232

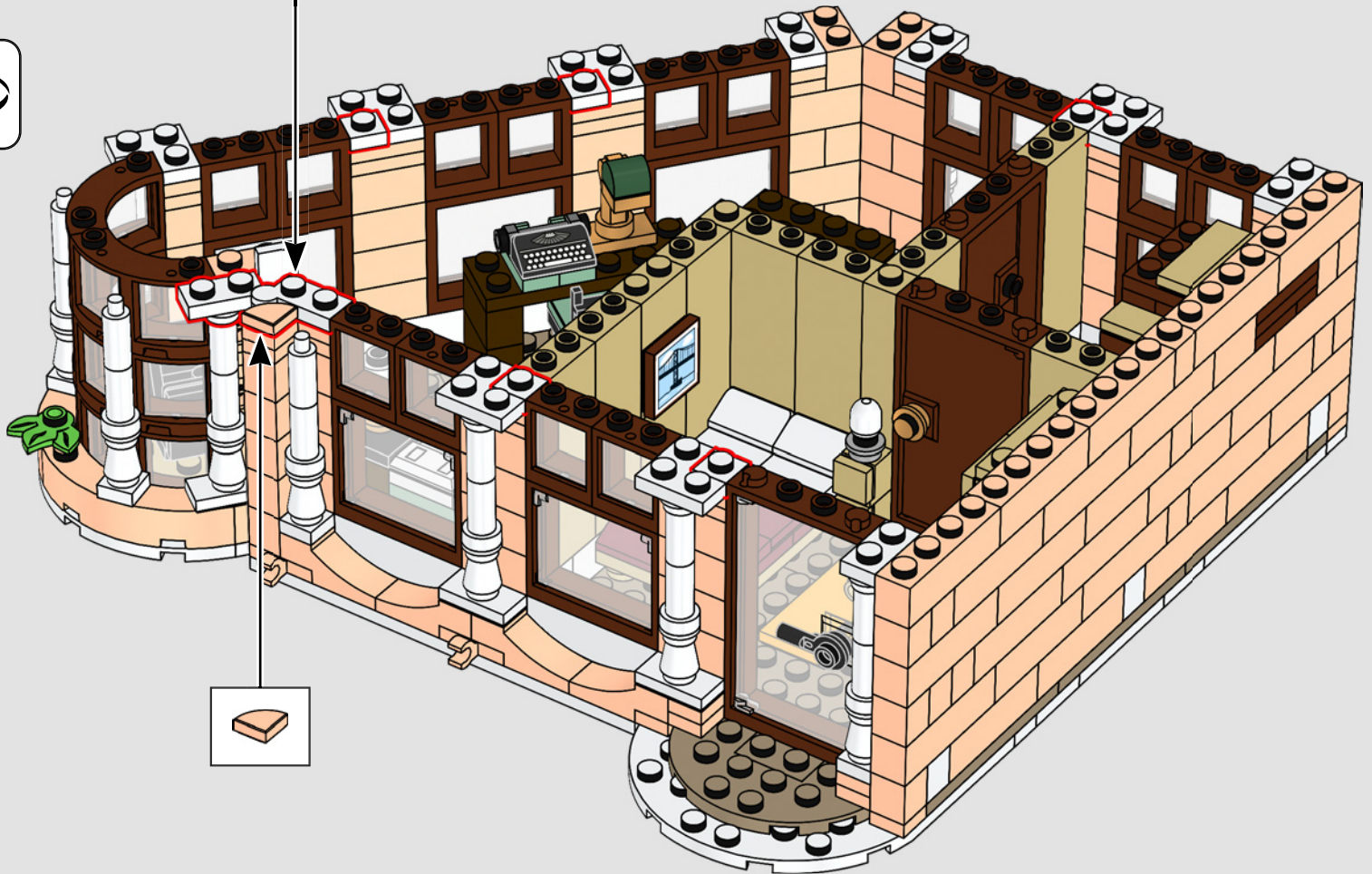
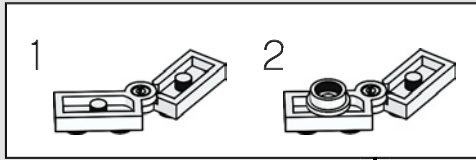

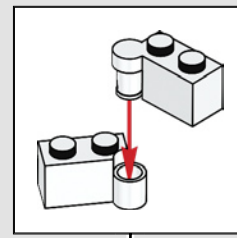
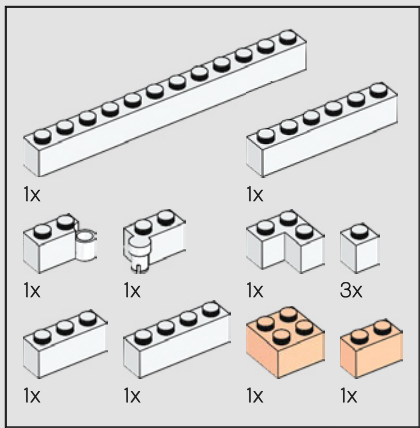

233

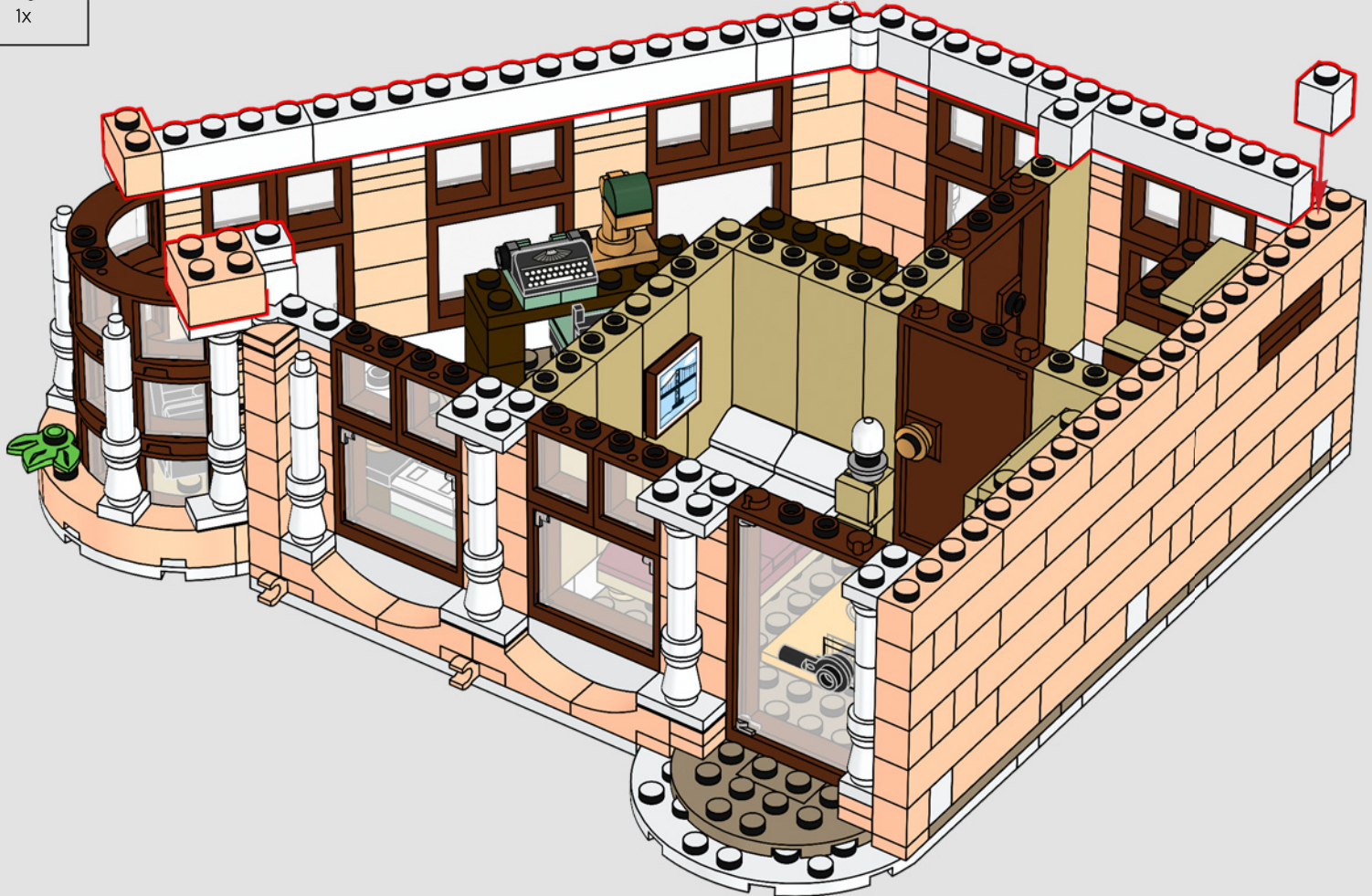

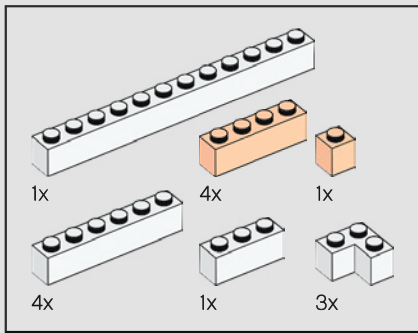

234



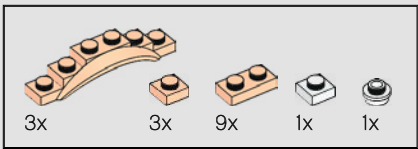

235

1

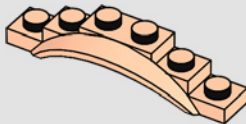

2

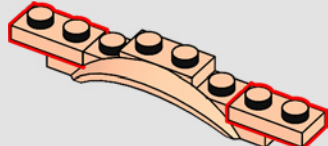

3

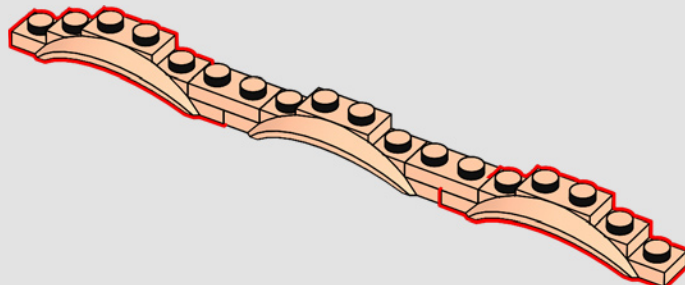

4

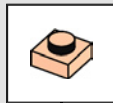
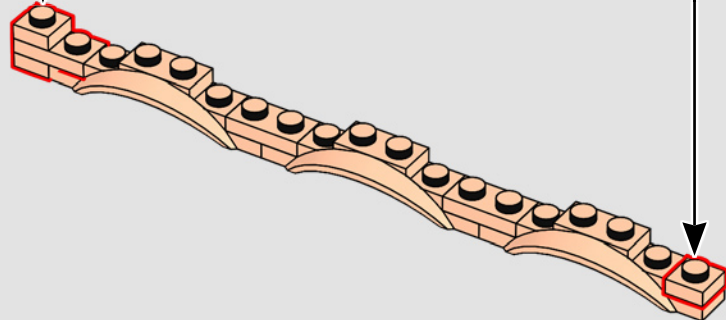
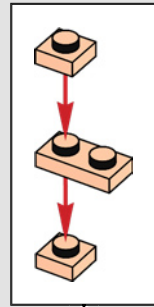

5

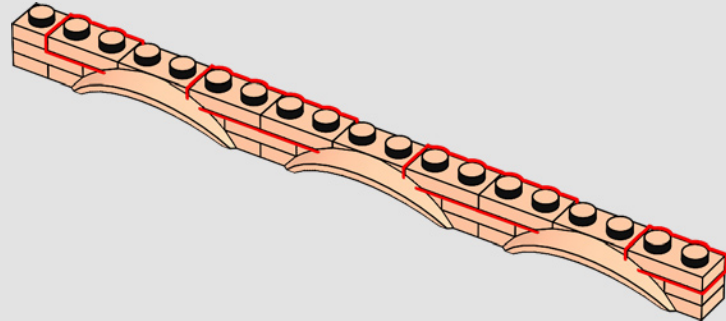

6

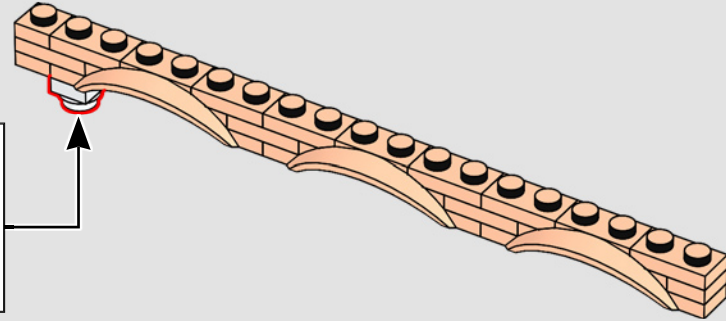
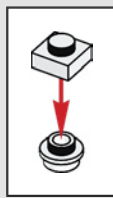

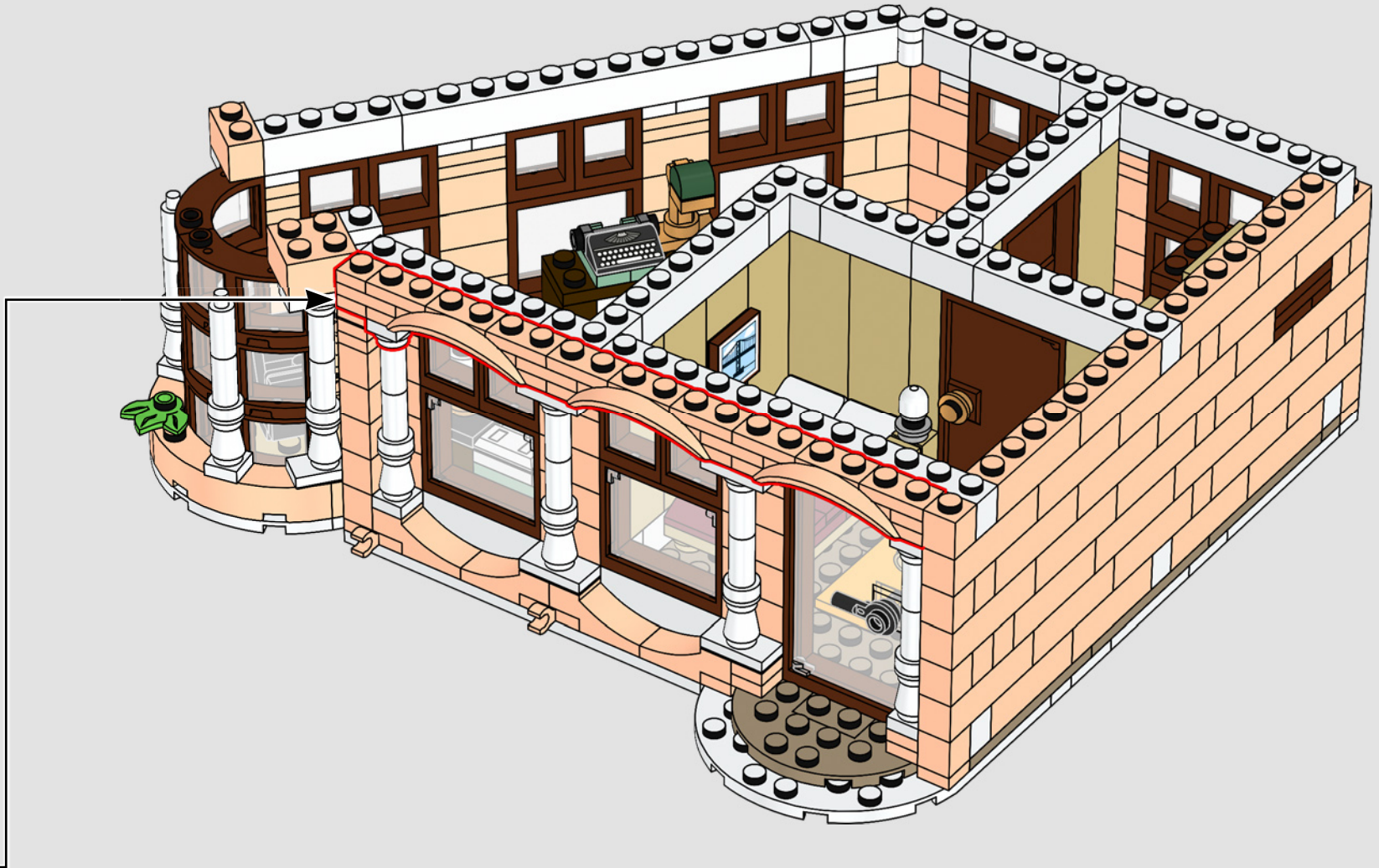

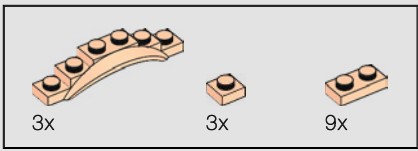

236

1

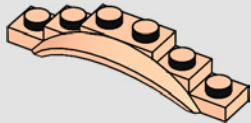

2

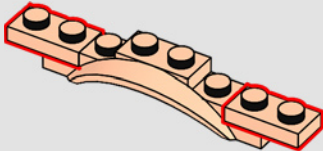

3

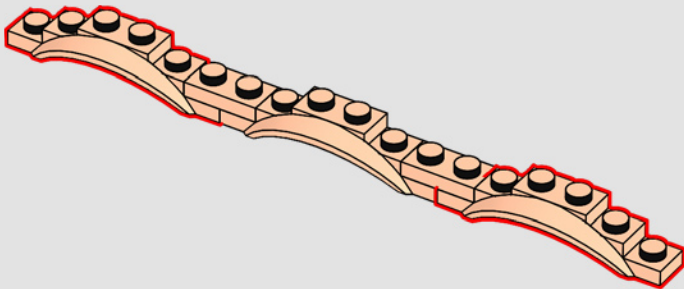

4

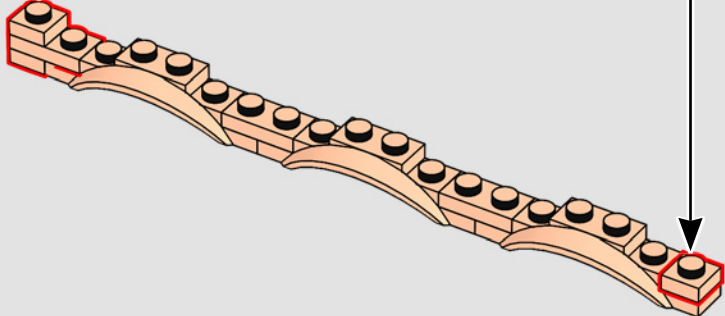
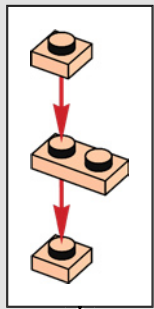

5

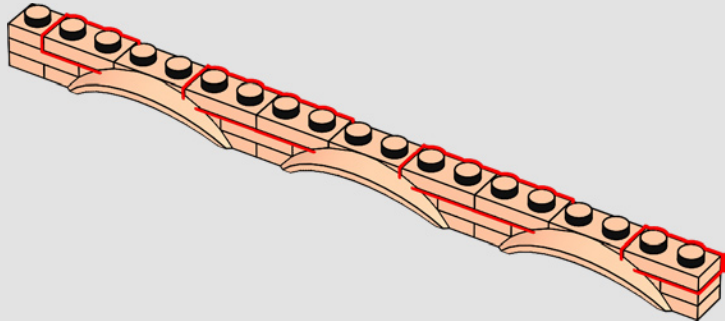

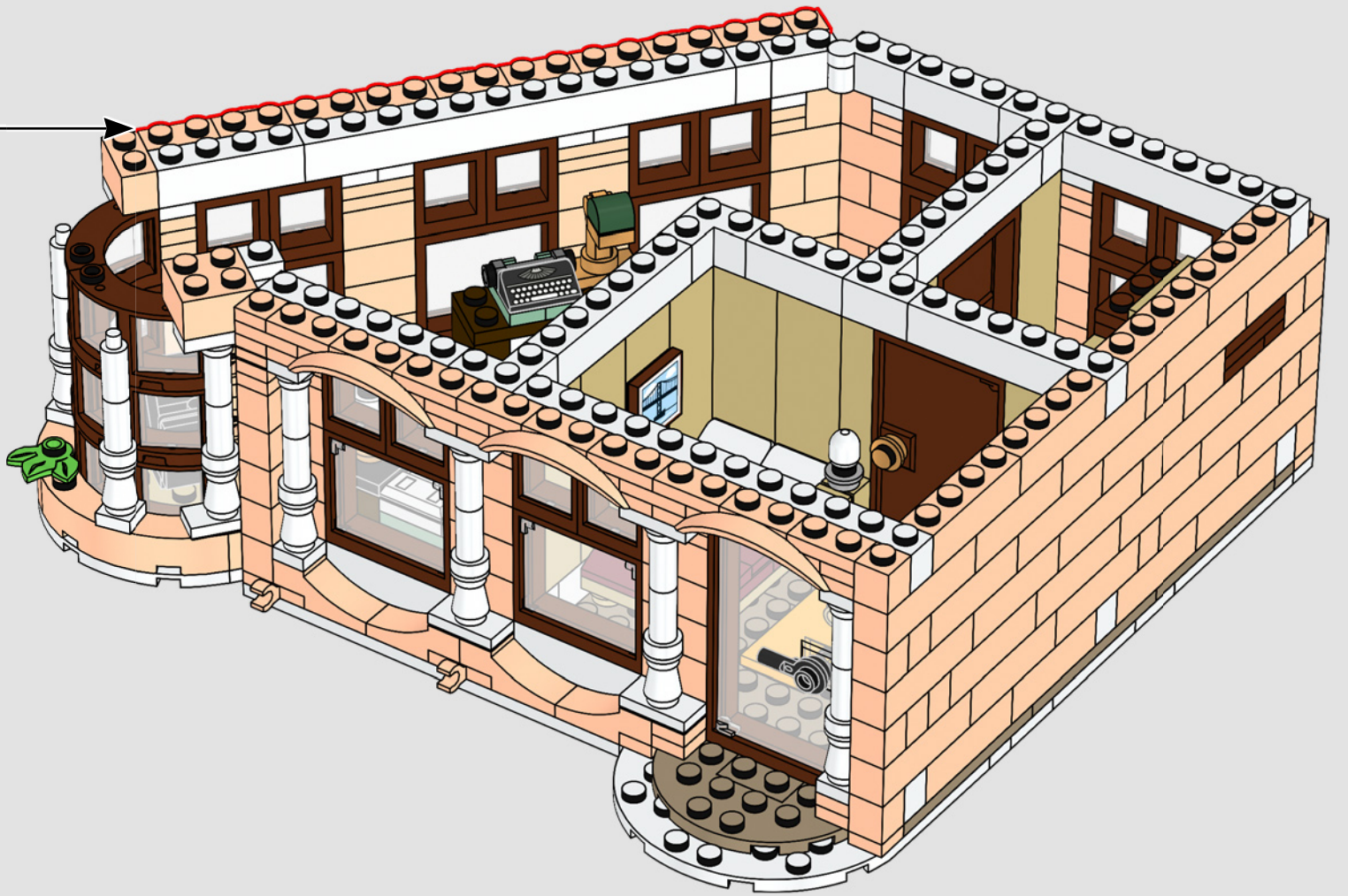

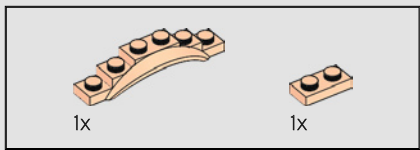

237

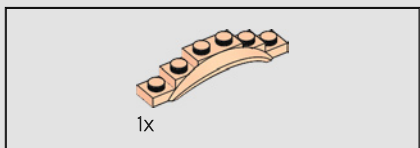
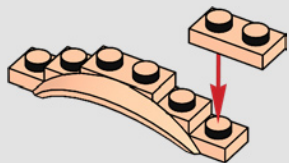

238

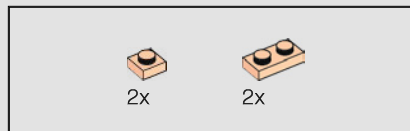
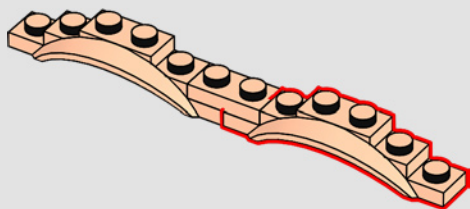

239

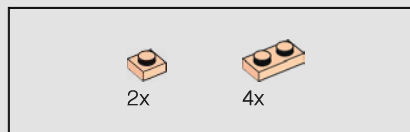
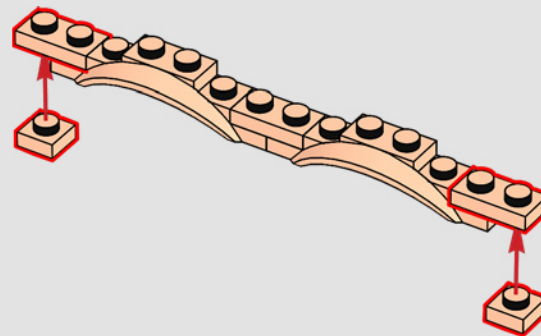

240

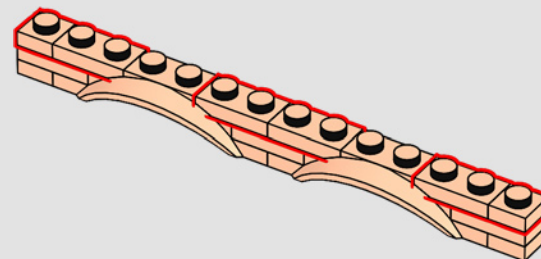



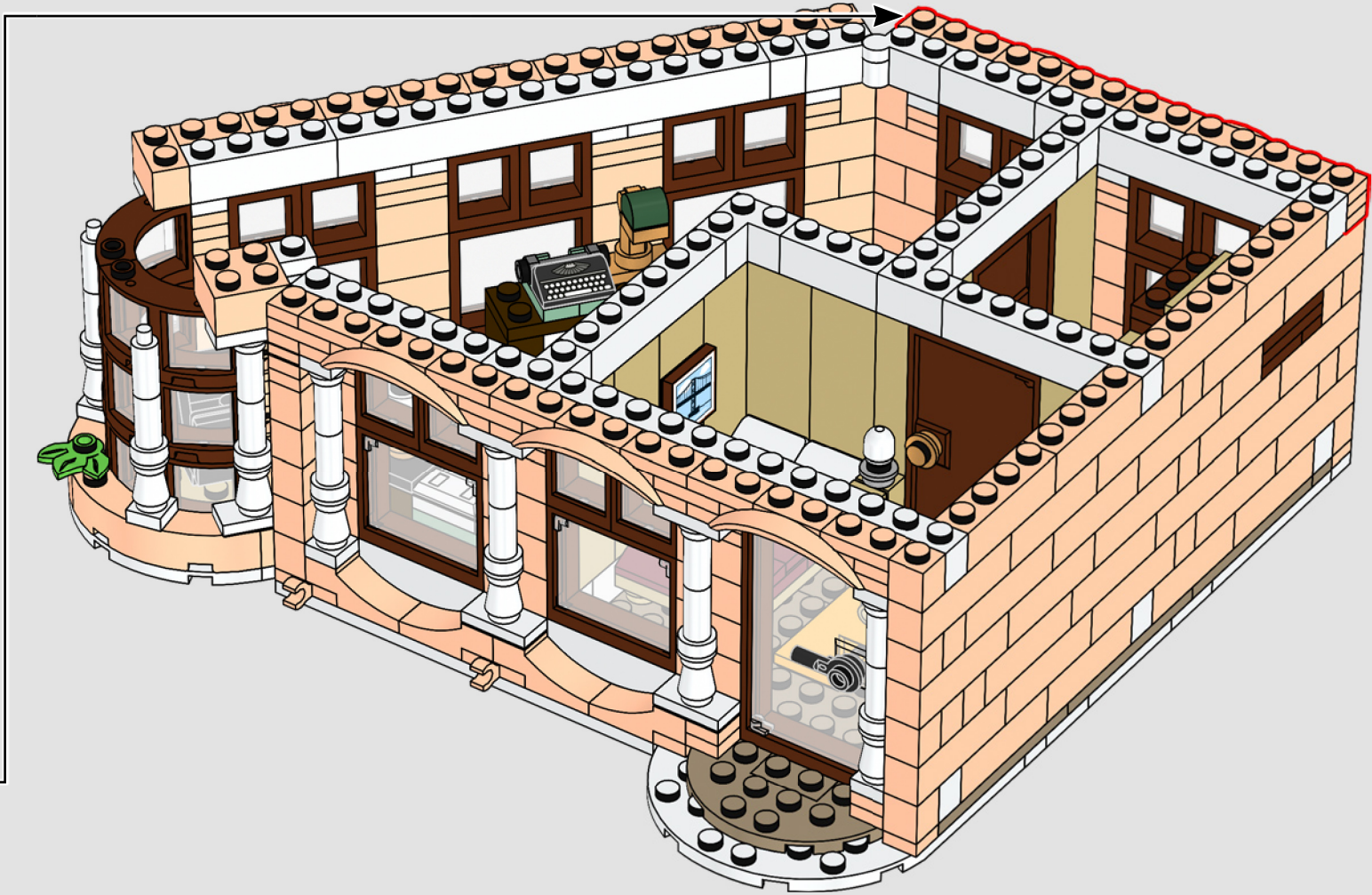

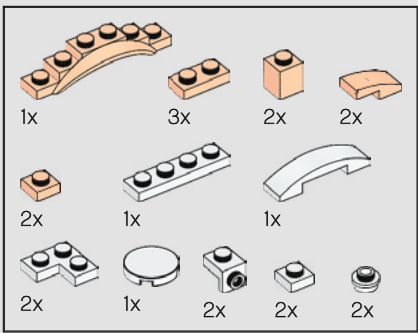

242

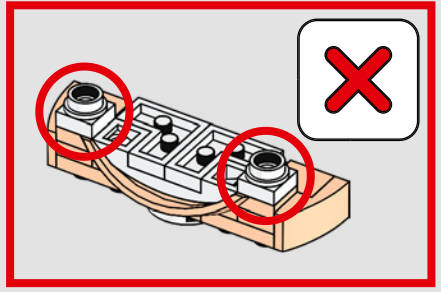
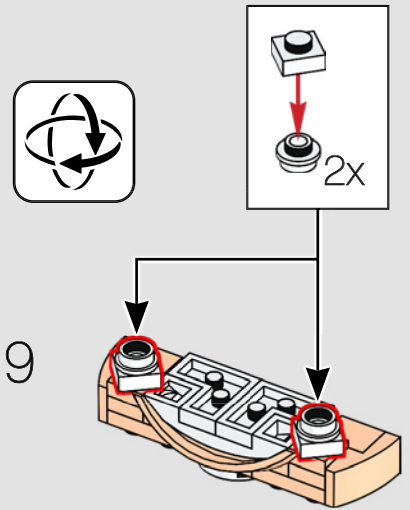
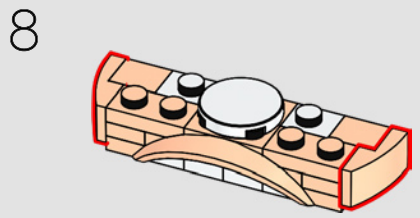
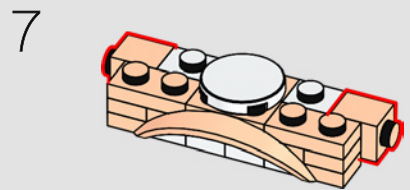
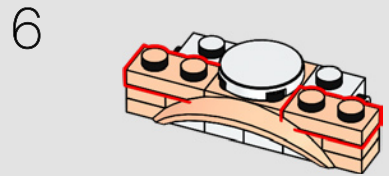
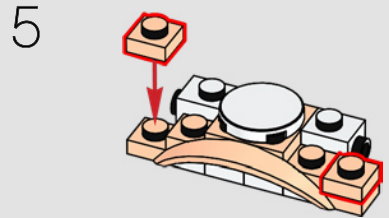
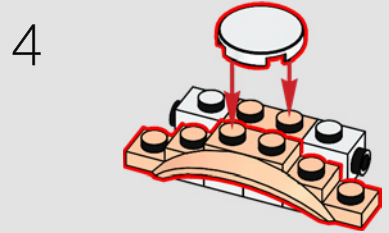
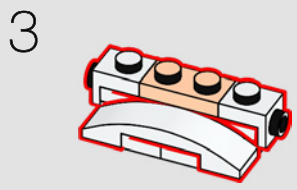
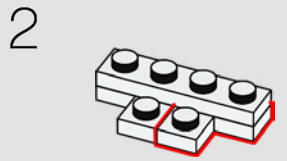
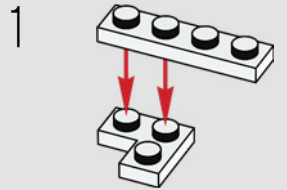

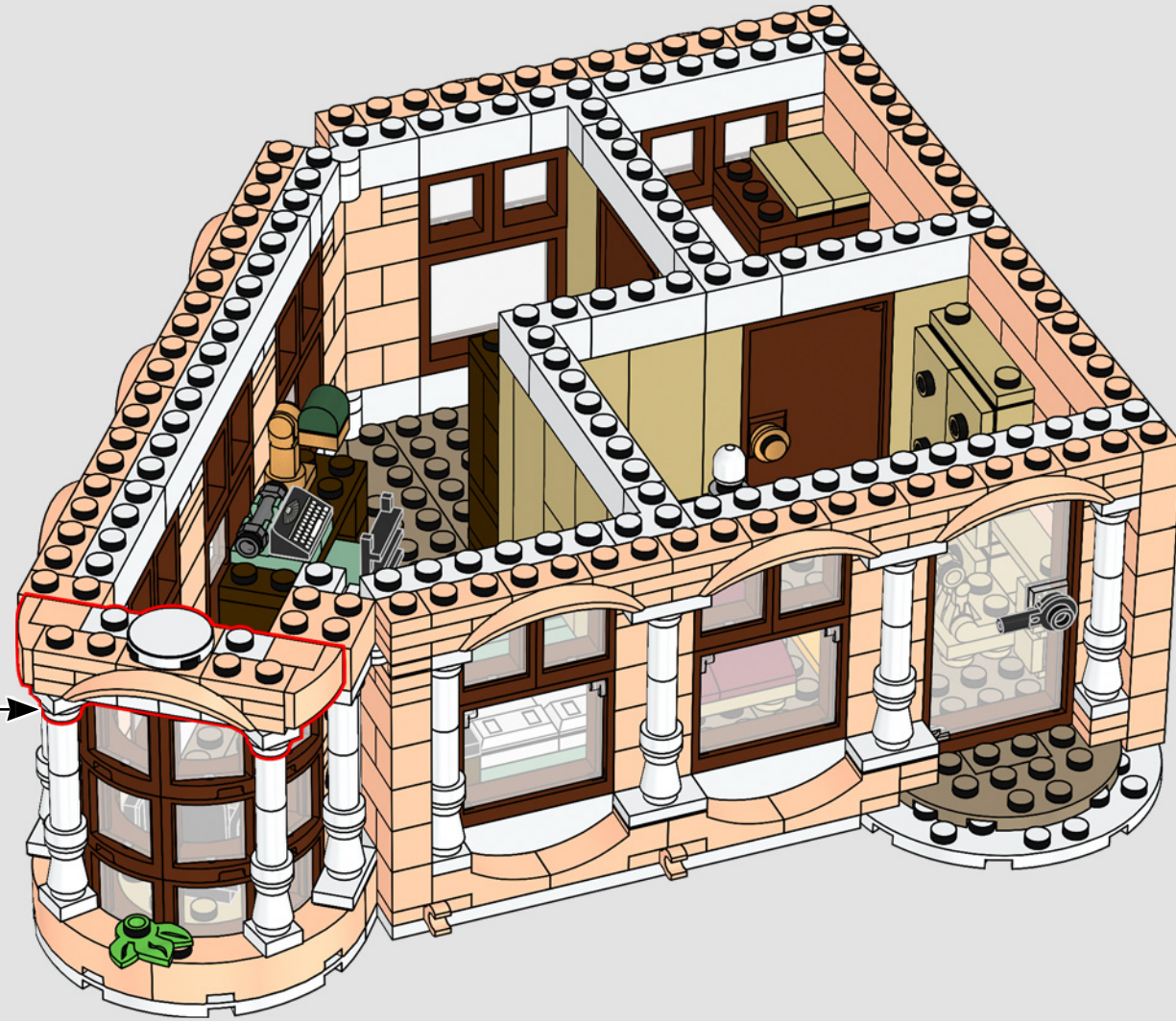

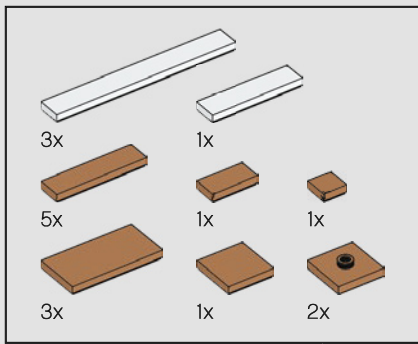

243



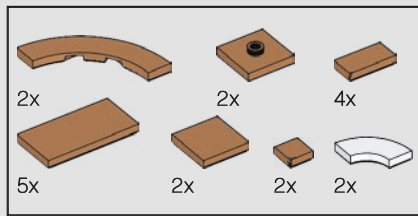

244

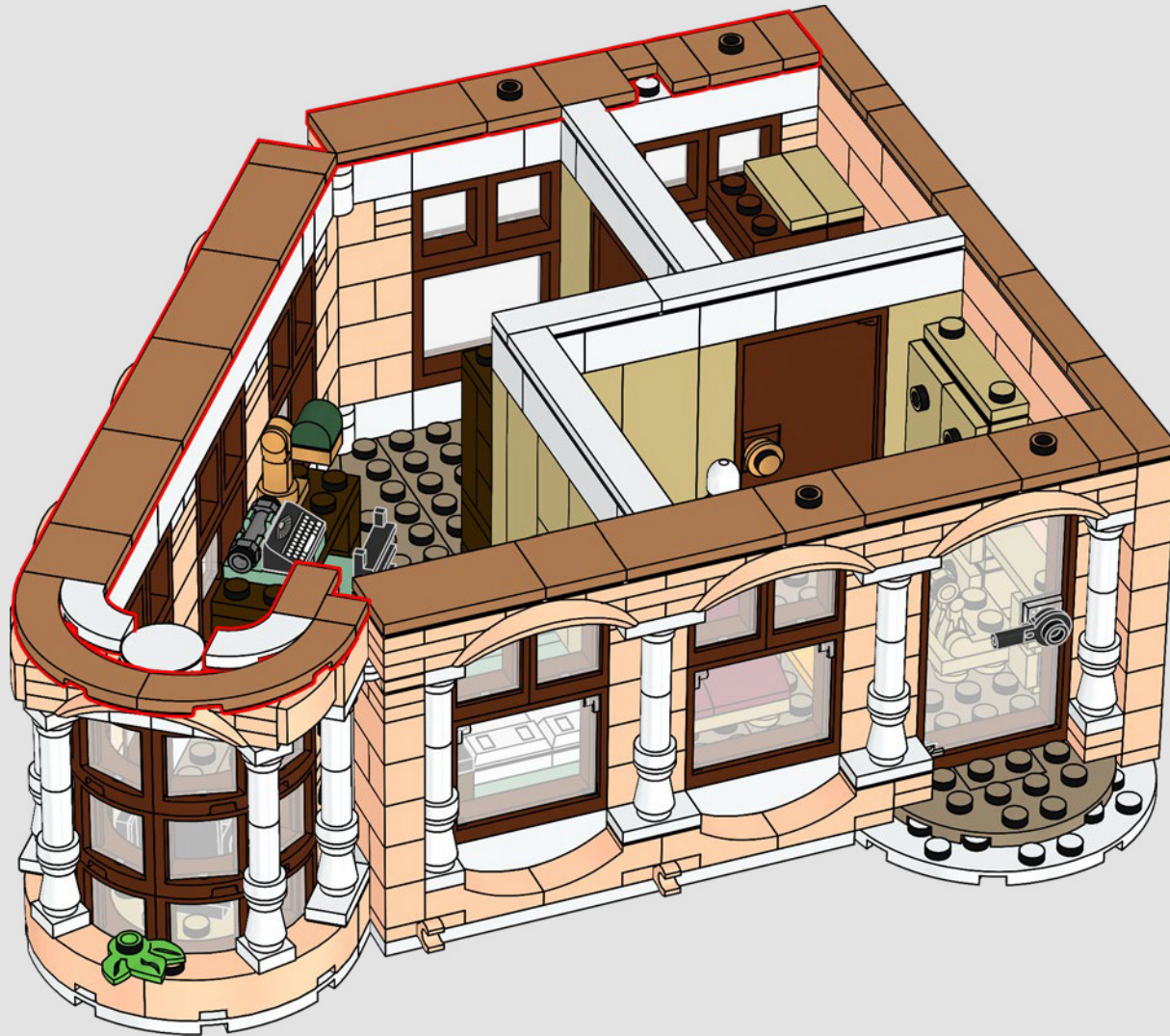

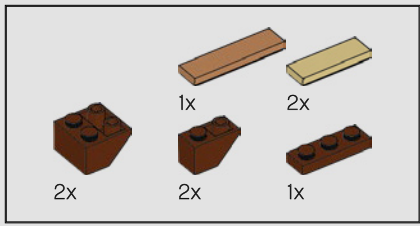

245

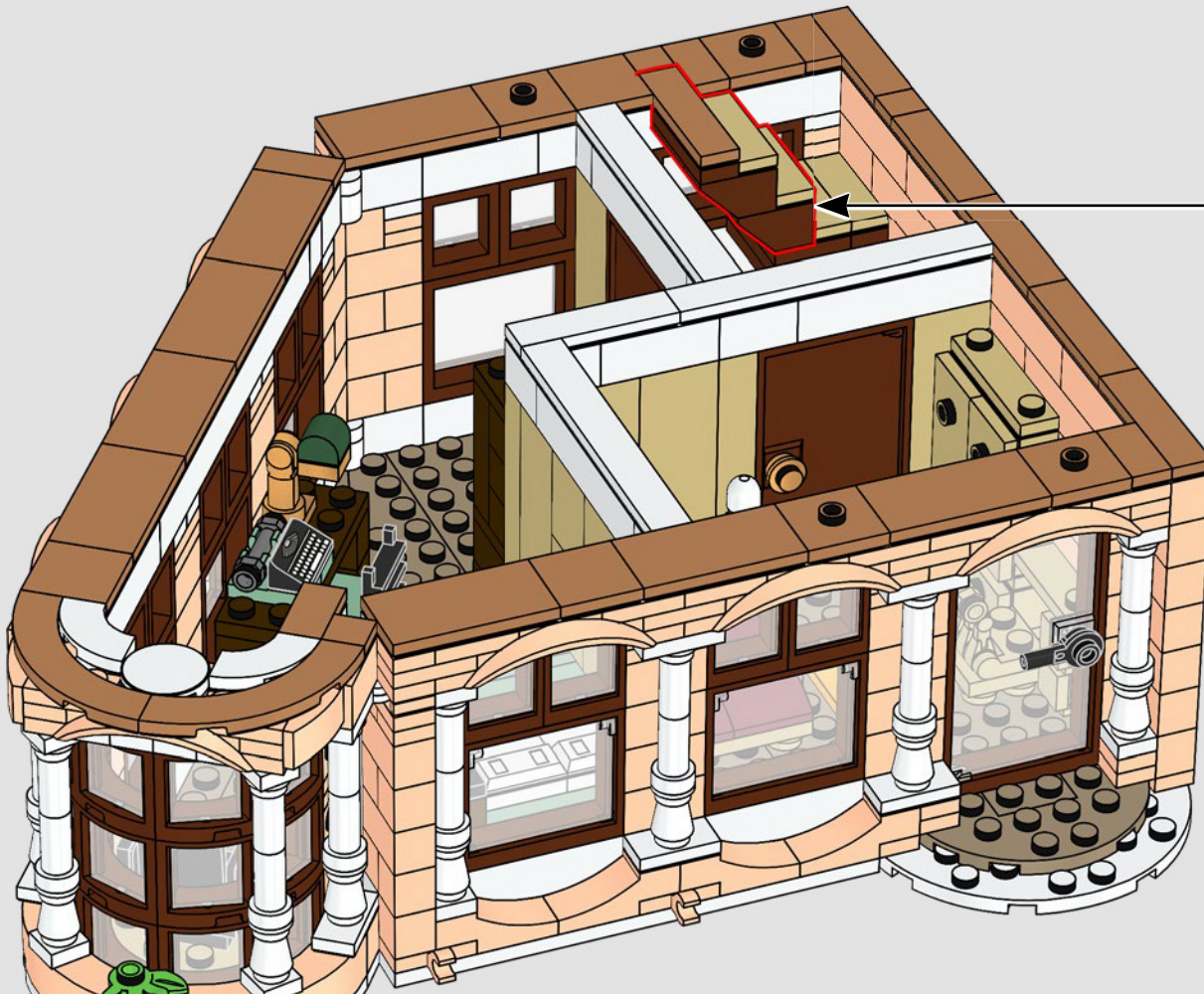
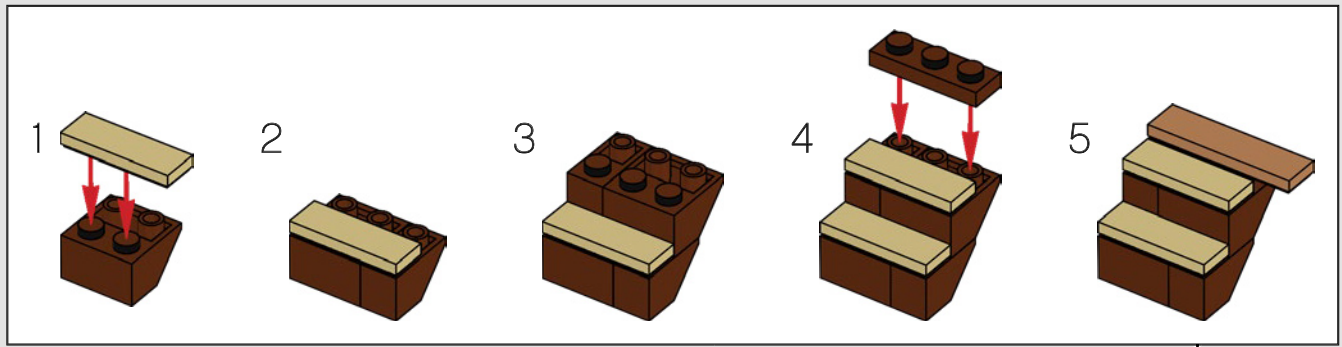

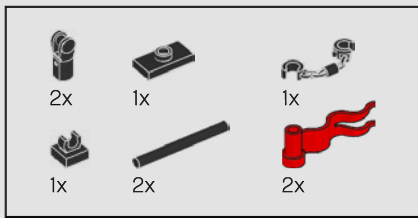

246

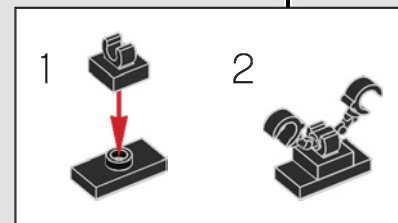
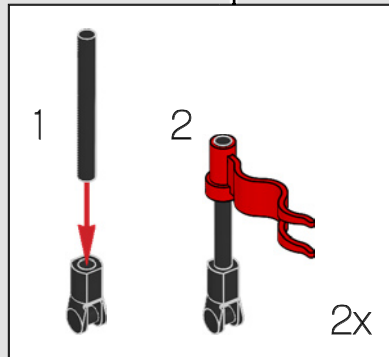



247



Minifigure skeleton legs were first used as a balcony detail in the 10185 Greengrocer set.

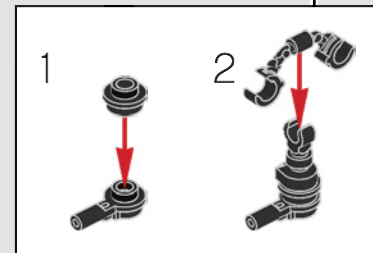
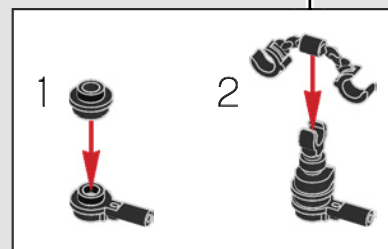





10

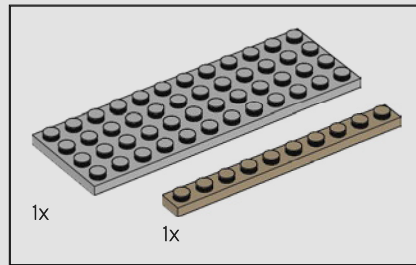
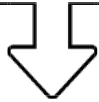

249

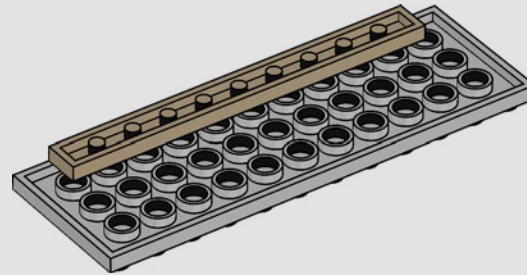

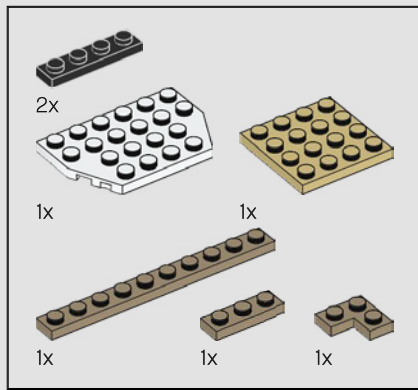

250

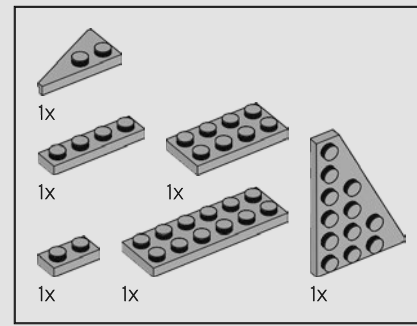
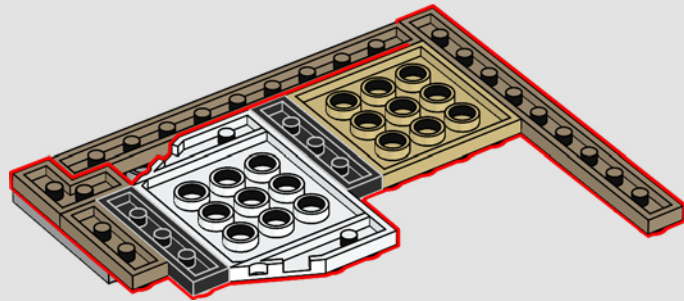

251

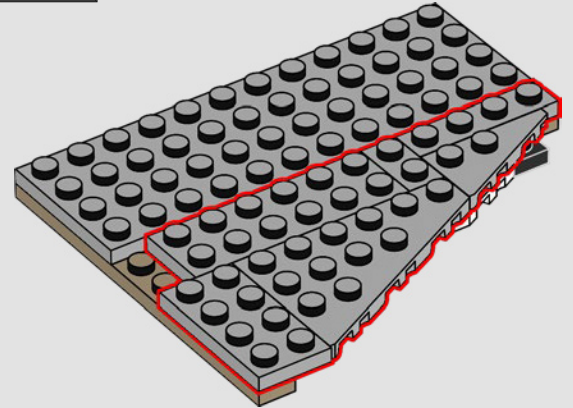
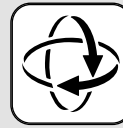

252

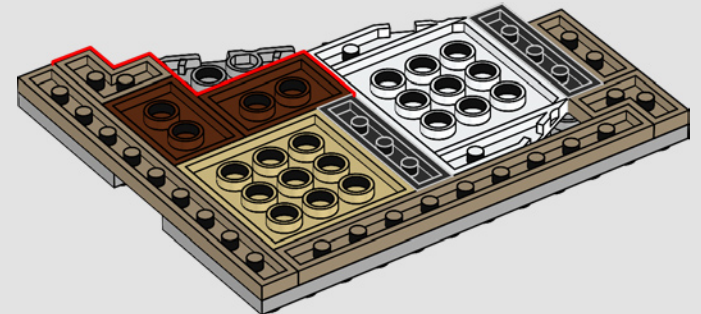
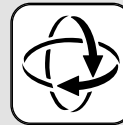

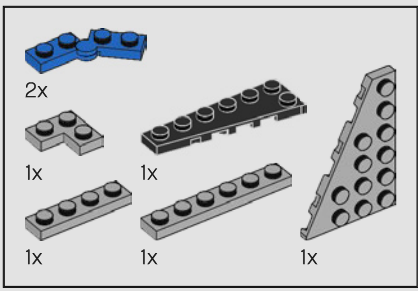

253

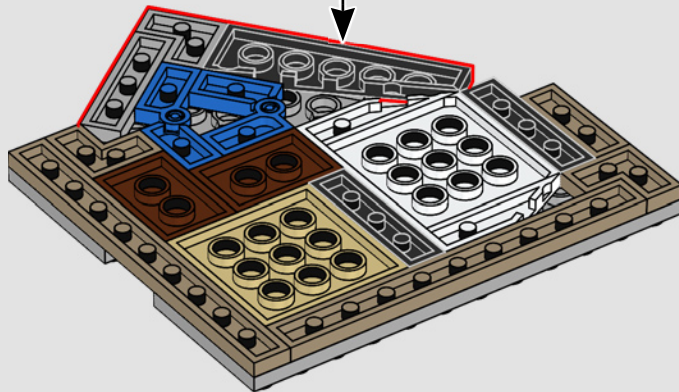
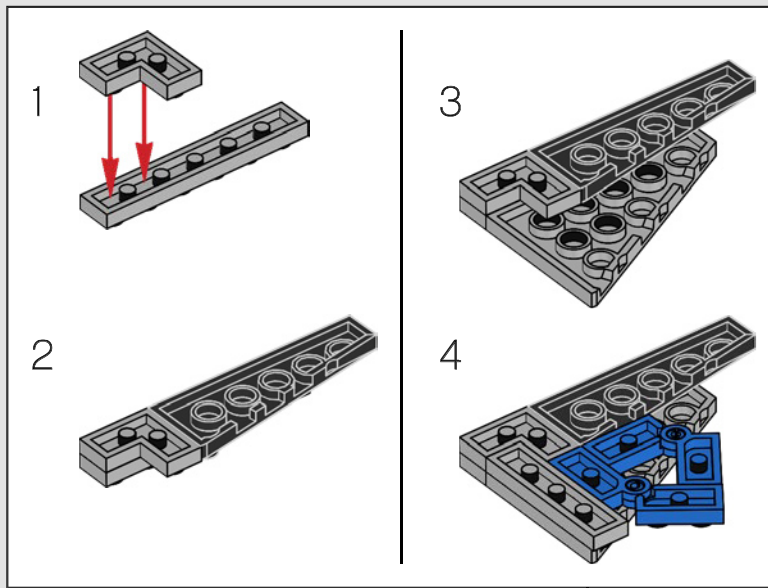

The terrace is built using reflected triangle geometry. Combined with the Hotel building itself, this creates Pythagorean triangles that align perfectly with the LEGO® grid system.

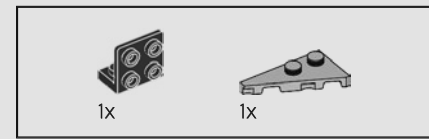

254

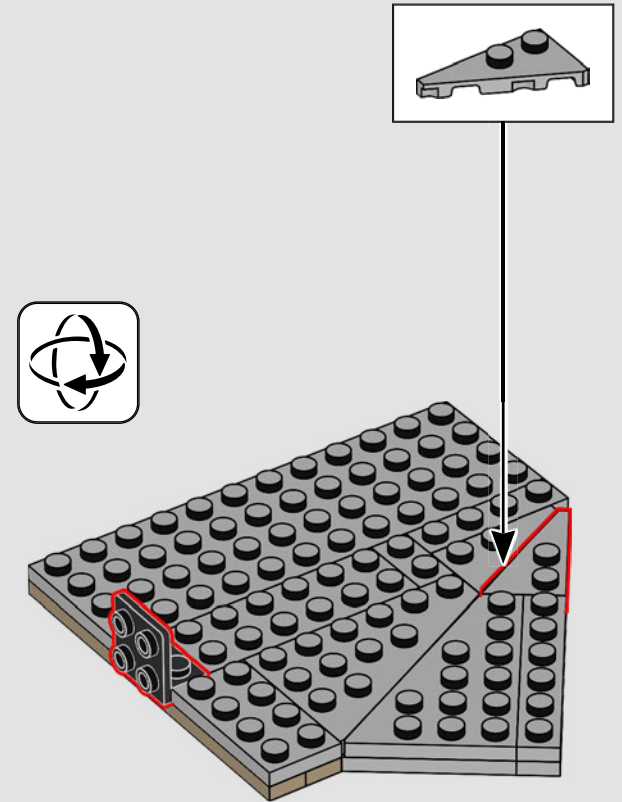

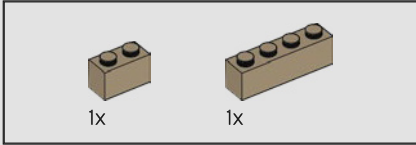

255

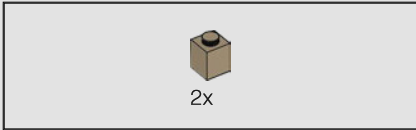
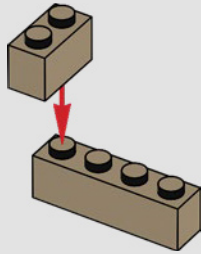

256

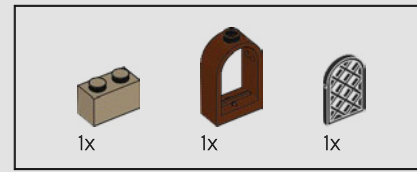
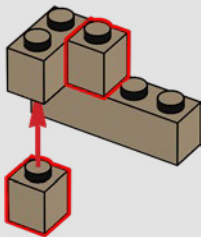

257

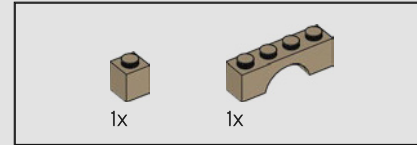
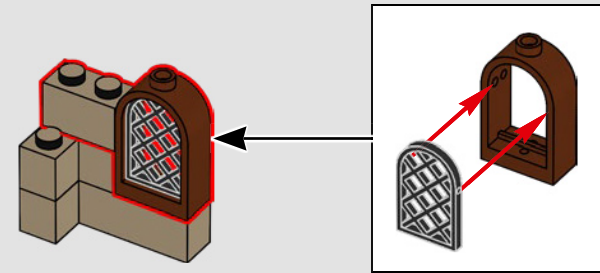

258

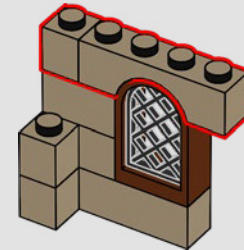

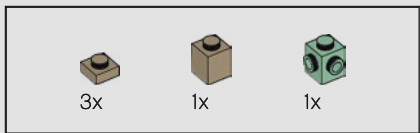

259

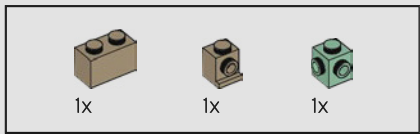
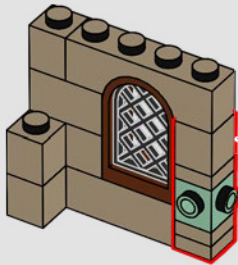
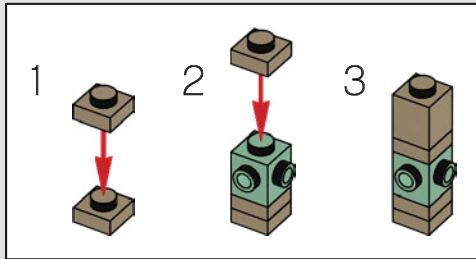

260

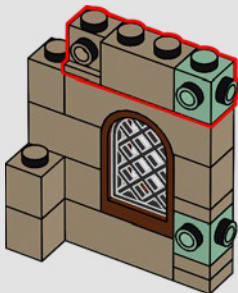

261

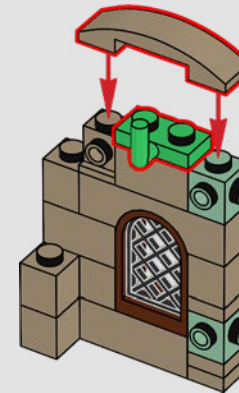

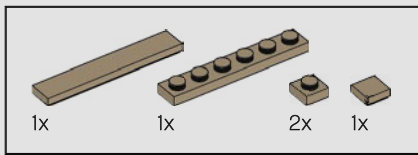

262

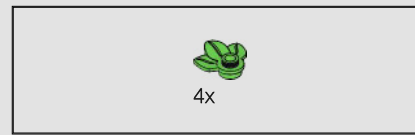
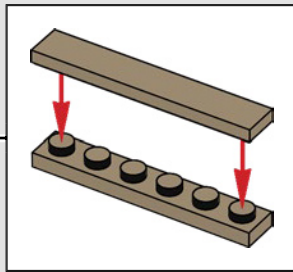
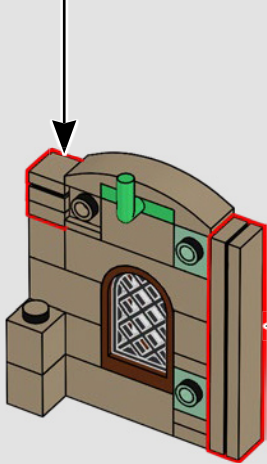
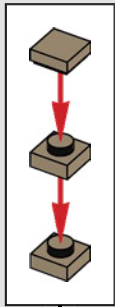

263

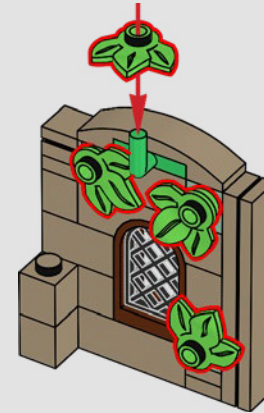

264

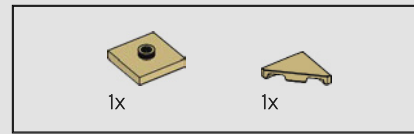
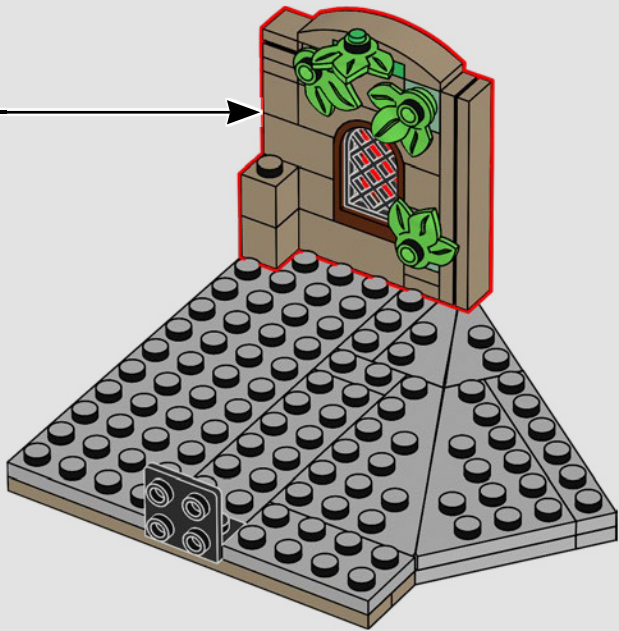

265

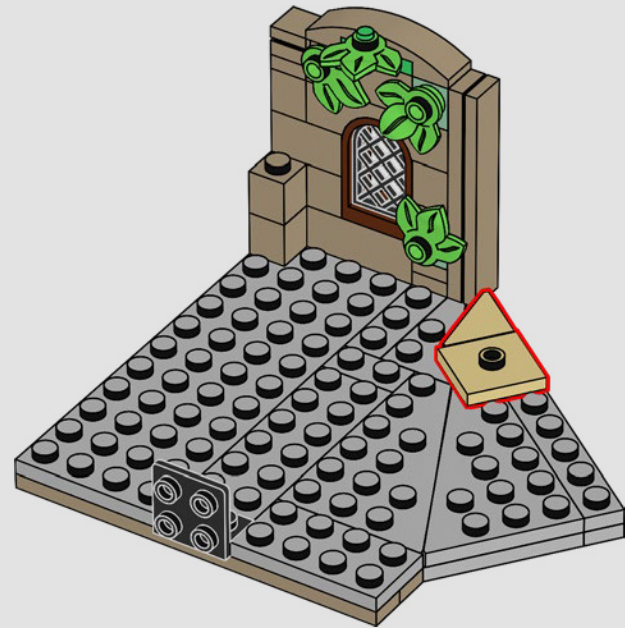



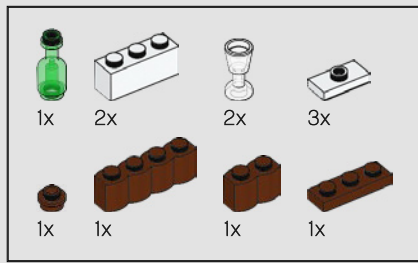

266

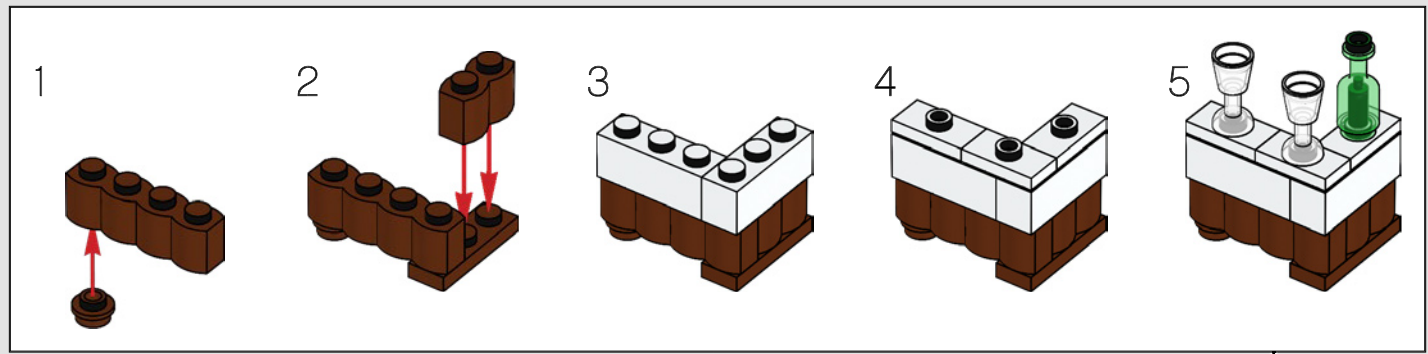

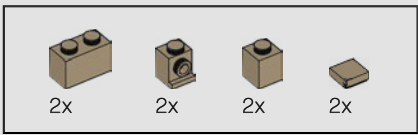

267

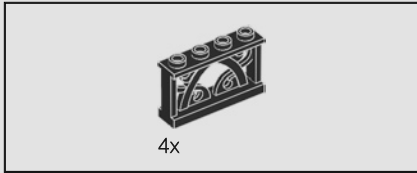
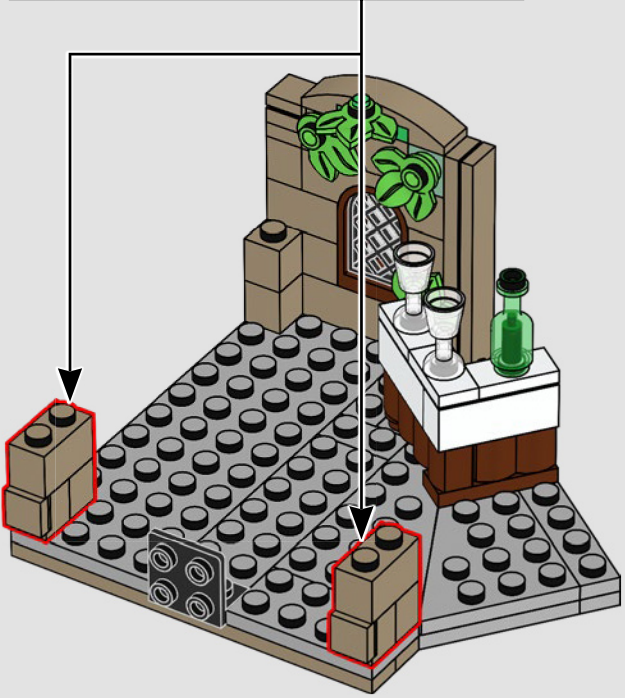
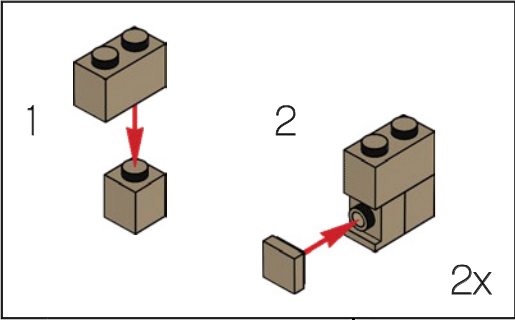

268



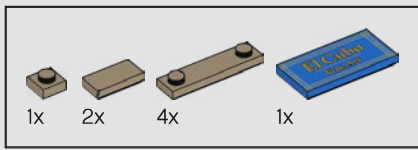

269

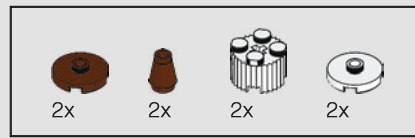
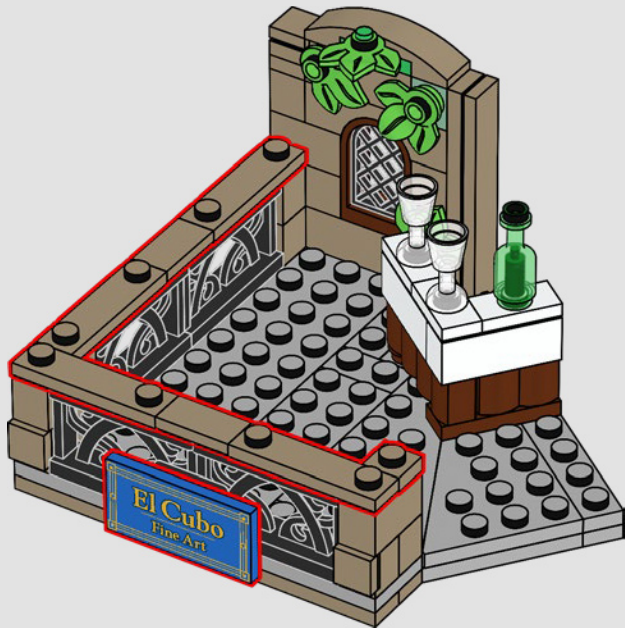

270

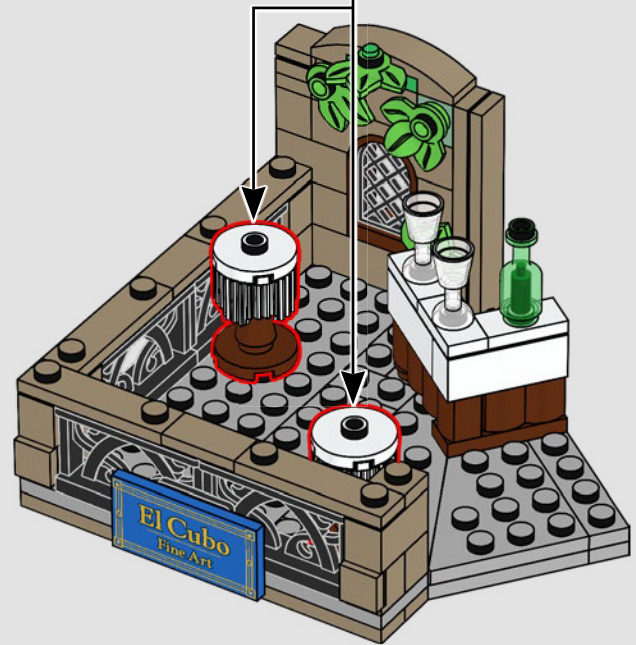
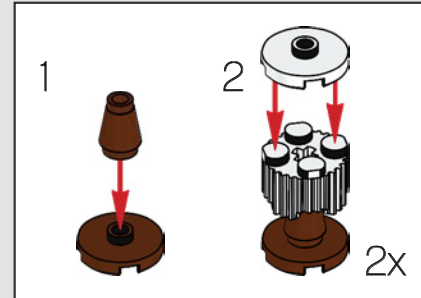

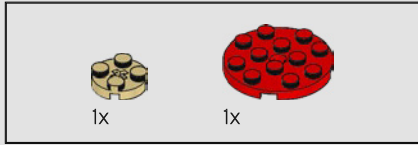

271

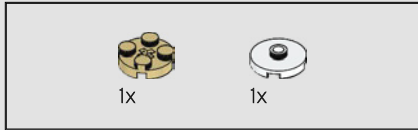

272

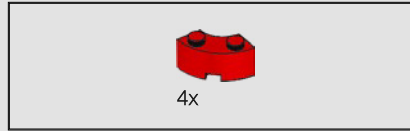
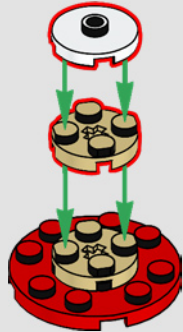

273

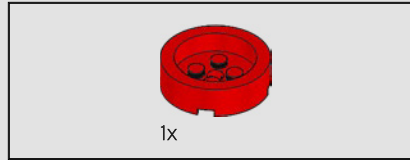
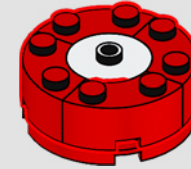

274

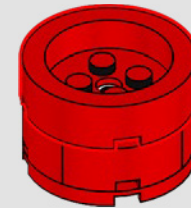

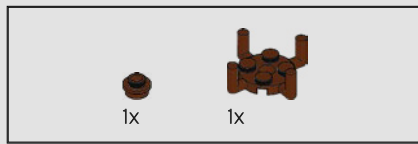

275

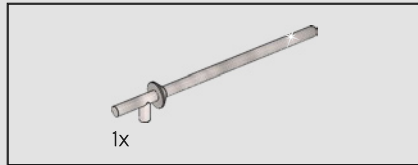
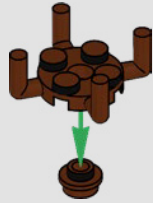

276

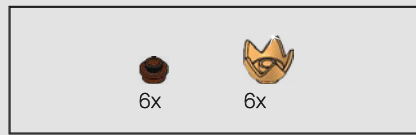
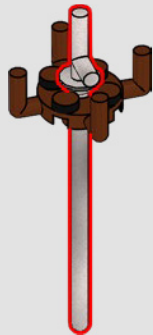

277

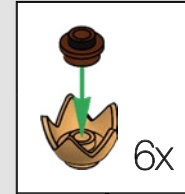

278

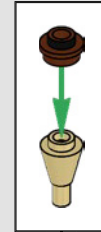

279



280

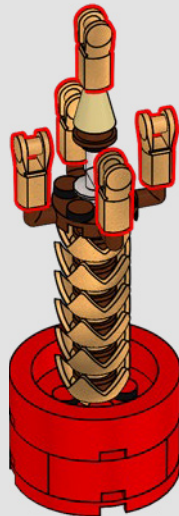

281

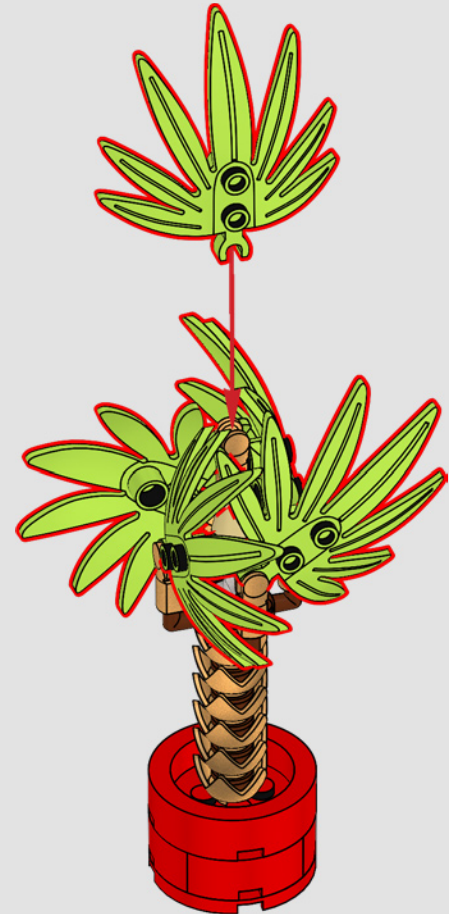
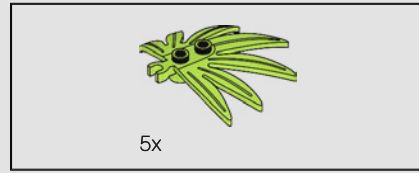

The elements used to make the trunk of the palm tree first appeared as the crown of Queen Watevra Wa'nabe from *The LEGO® Movie 2™*.

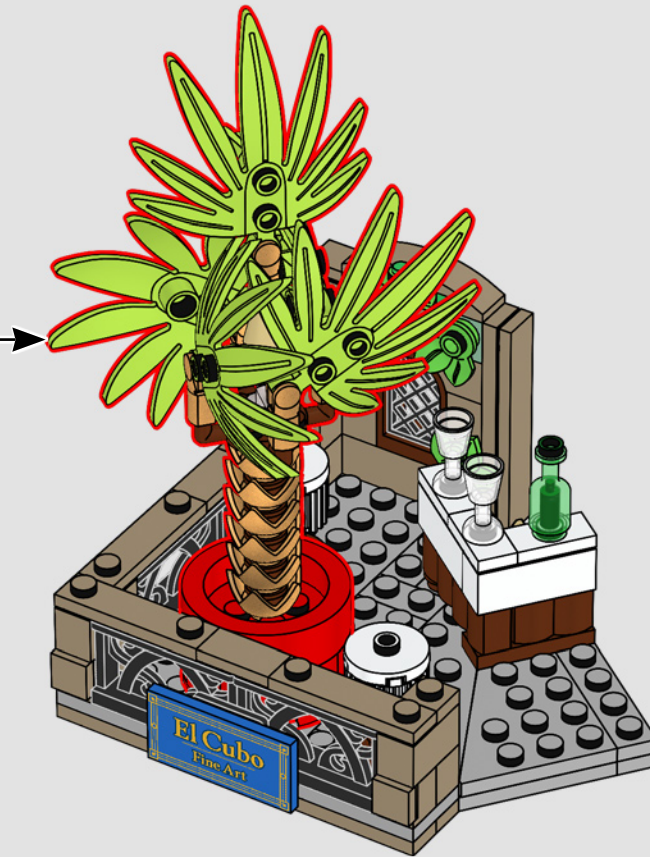

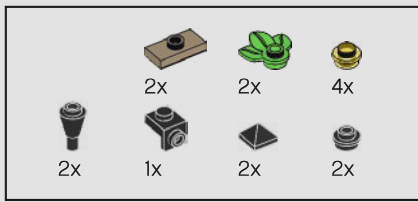

283

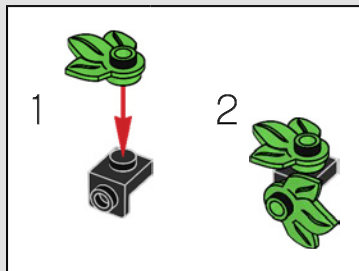
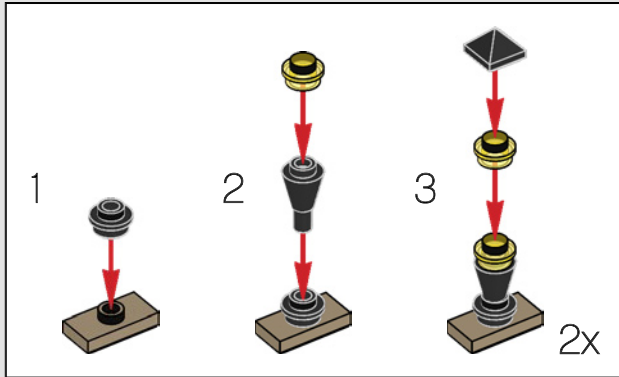



284



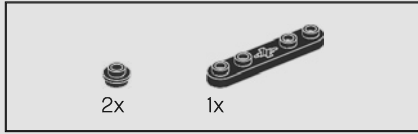
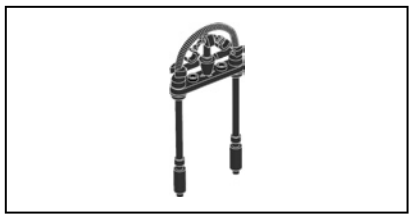

285

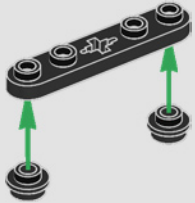

286

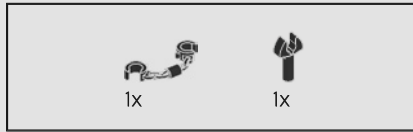
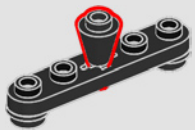

287

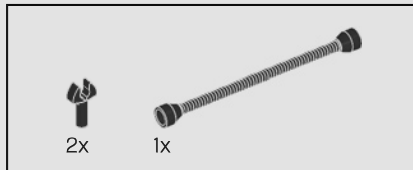
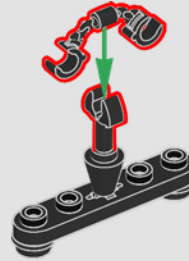

288

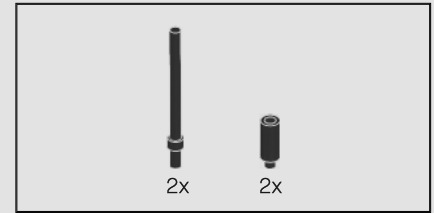
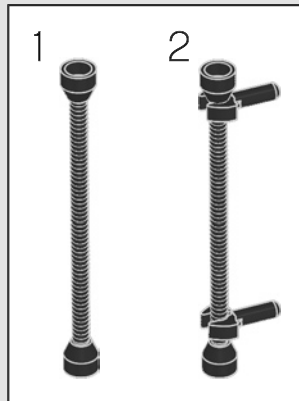

289

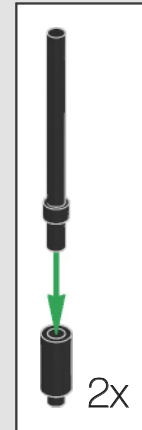
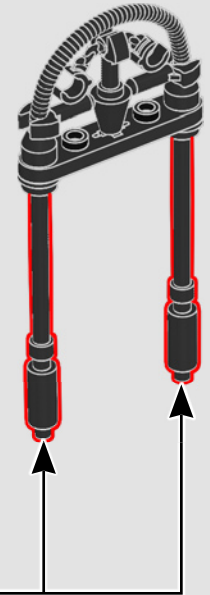



A wrought-iron gate first appeared in the 10190 Market Street set. It was notable for its use of minifigure whips to make organic curving details.

290



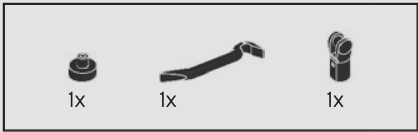

291

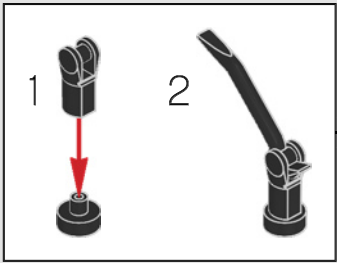

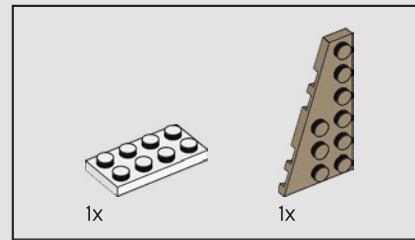
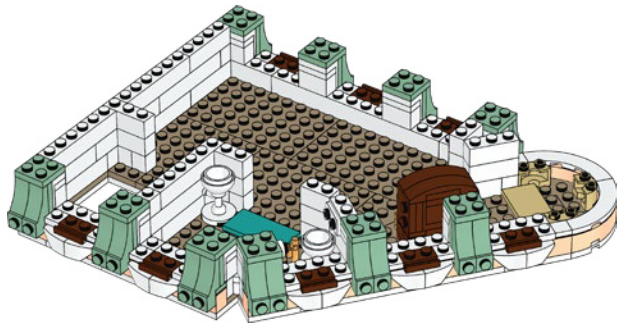
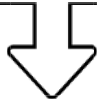

292

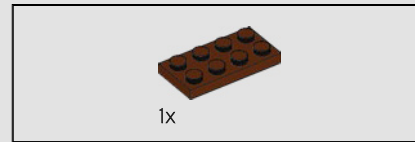
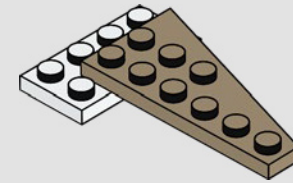

293



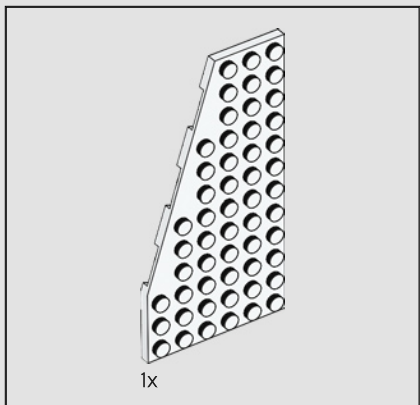

294

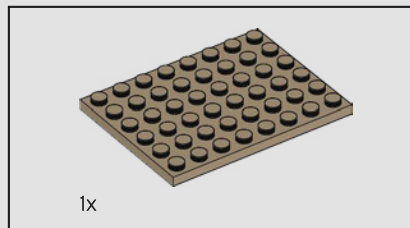
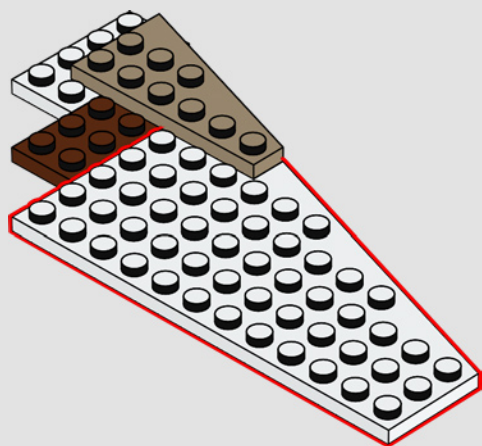

295

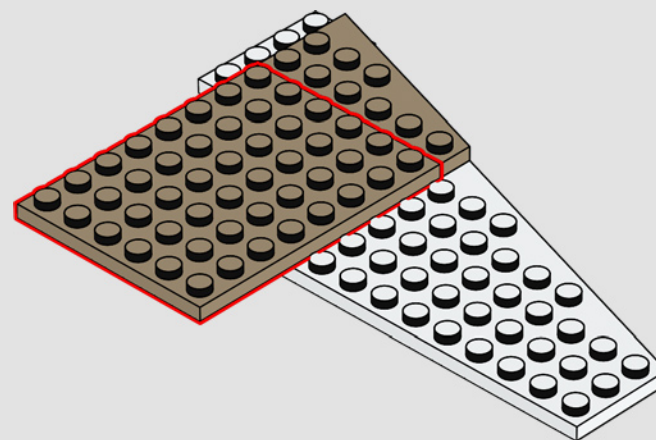

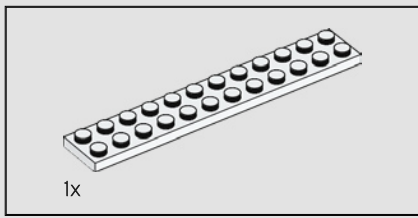

296

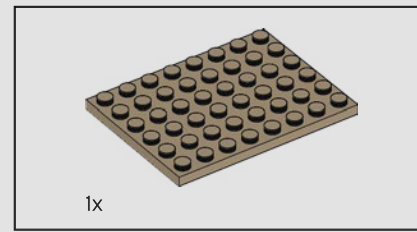
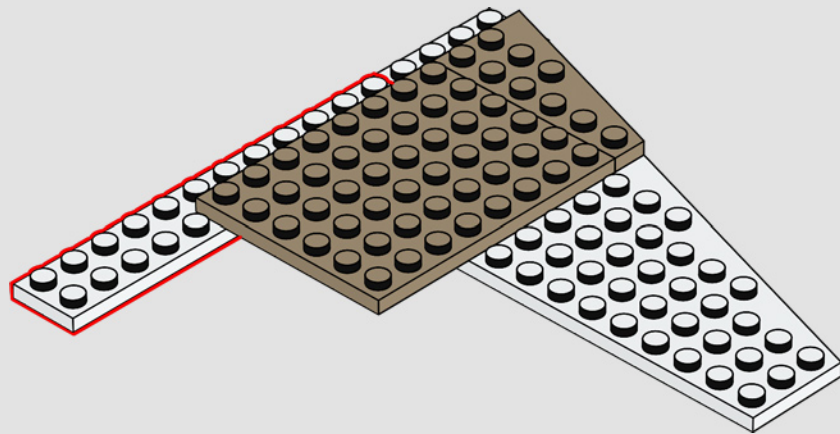

297

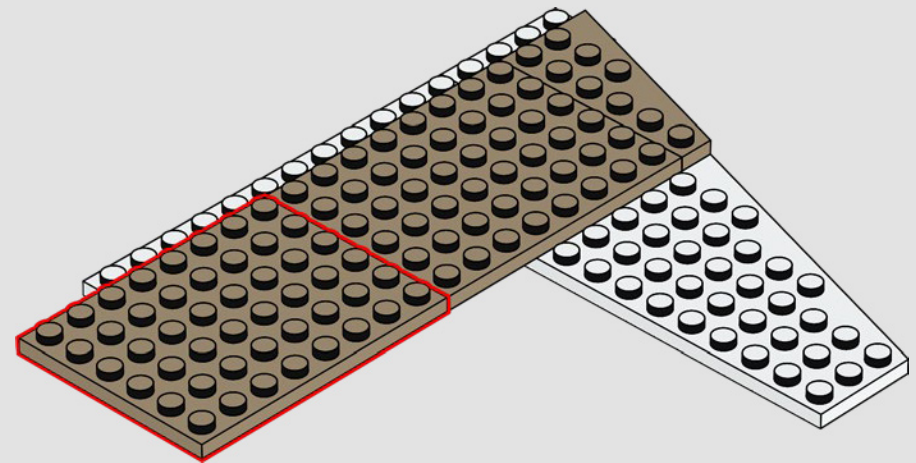

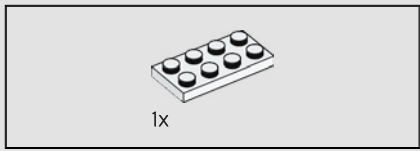

298

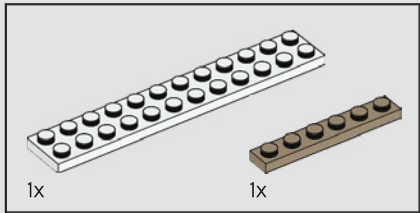
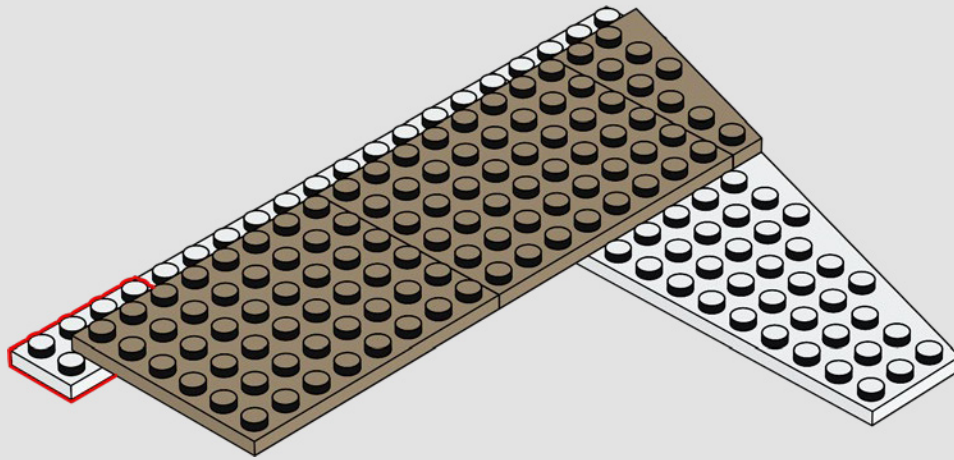

299

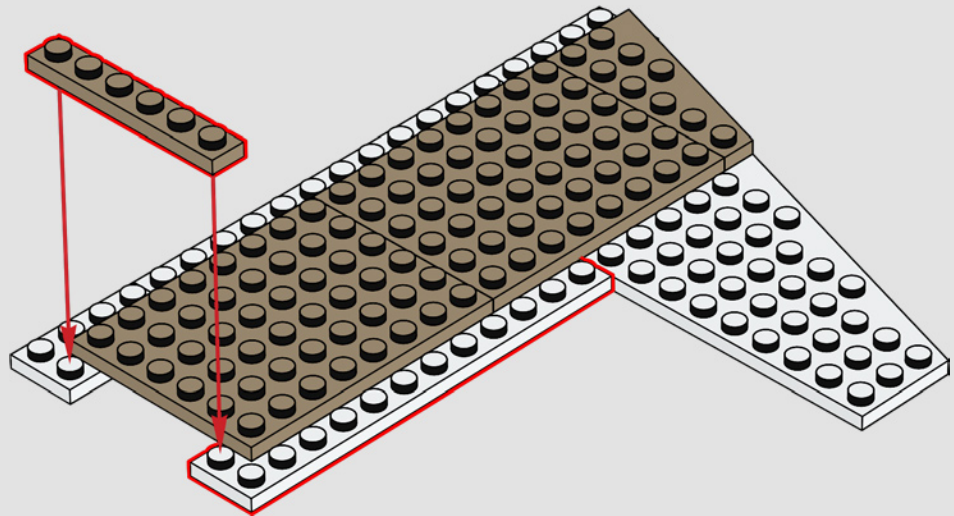



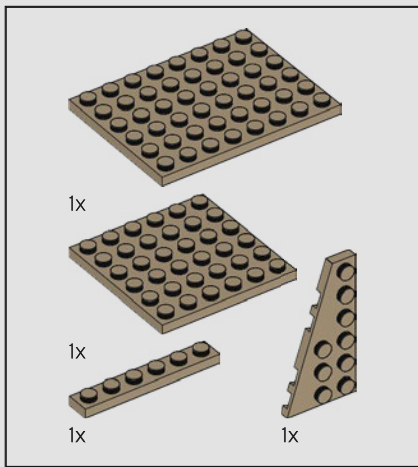

300

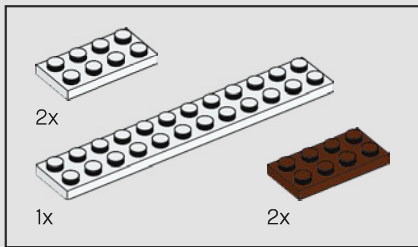
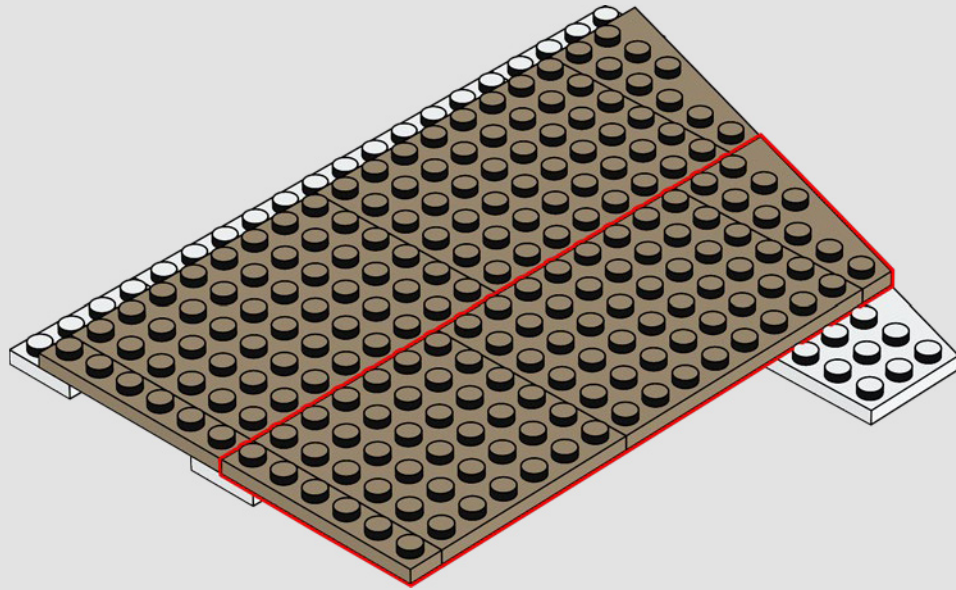

301

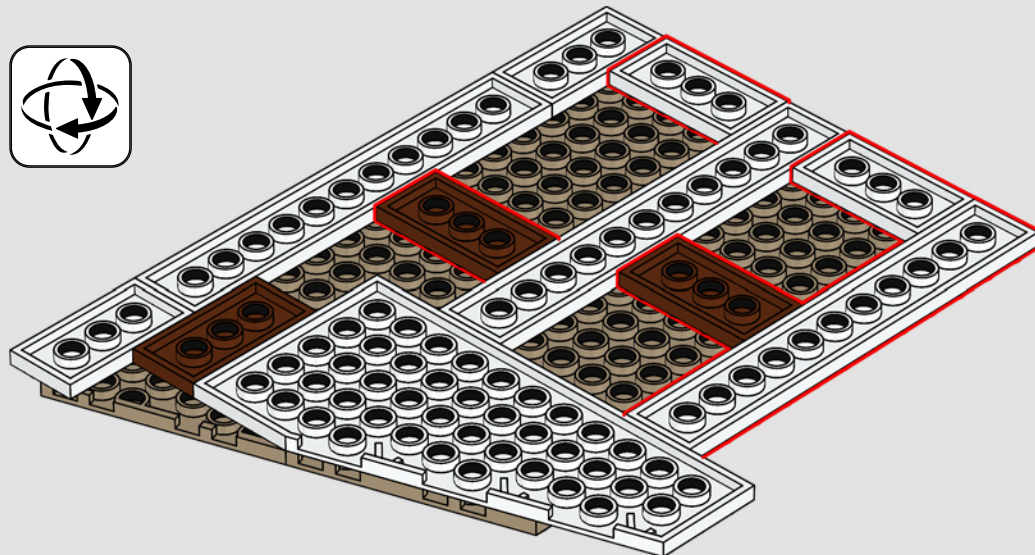

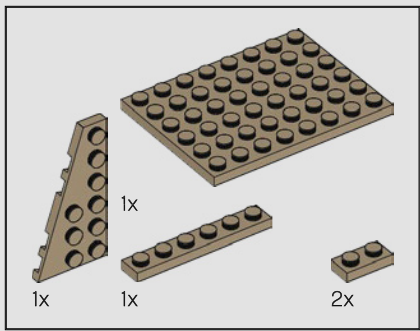

302

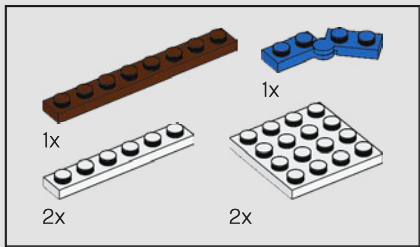
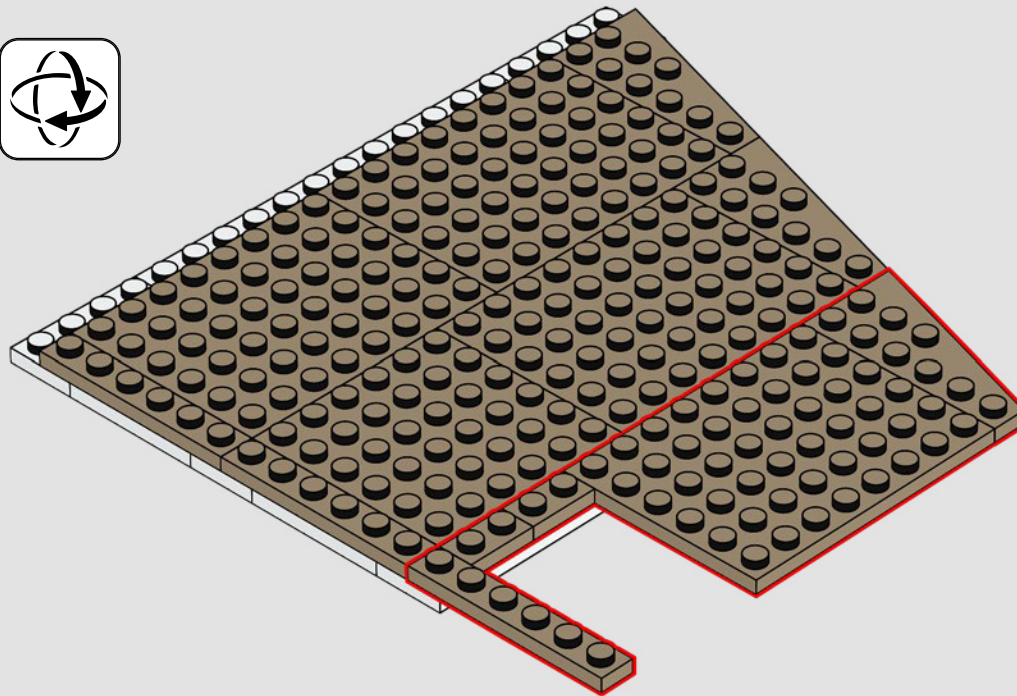

303

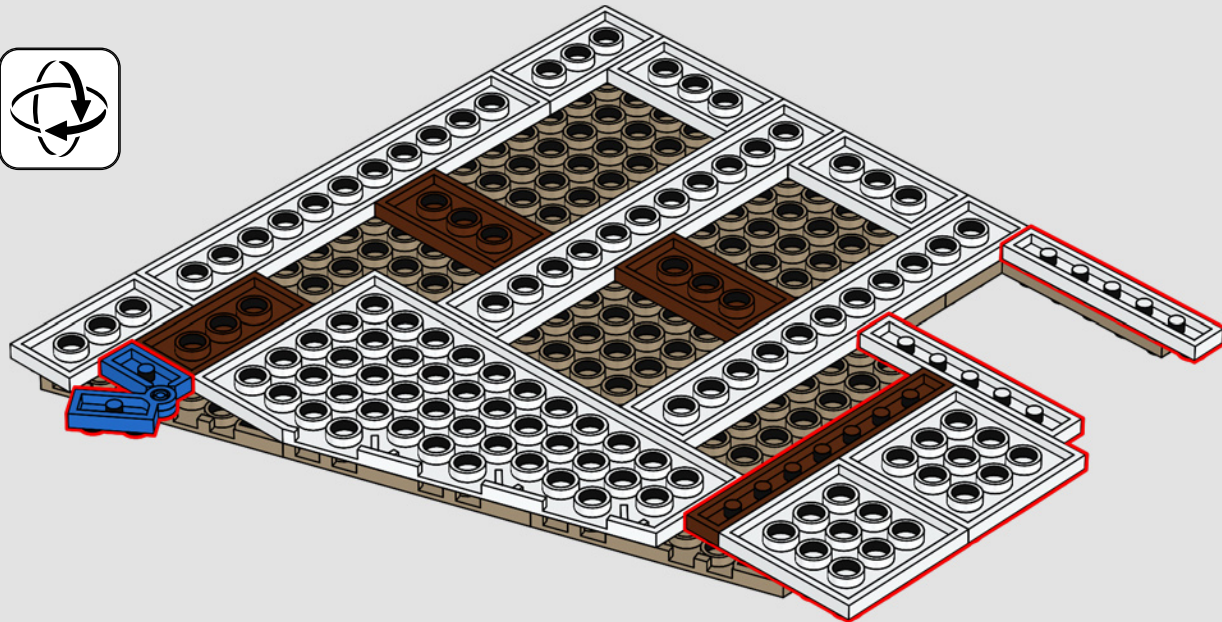
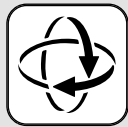

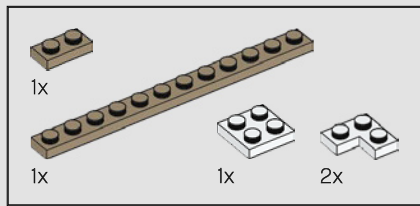

304

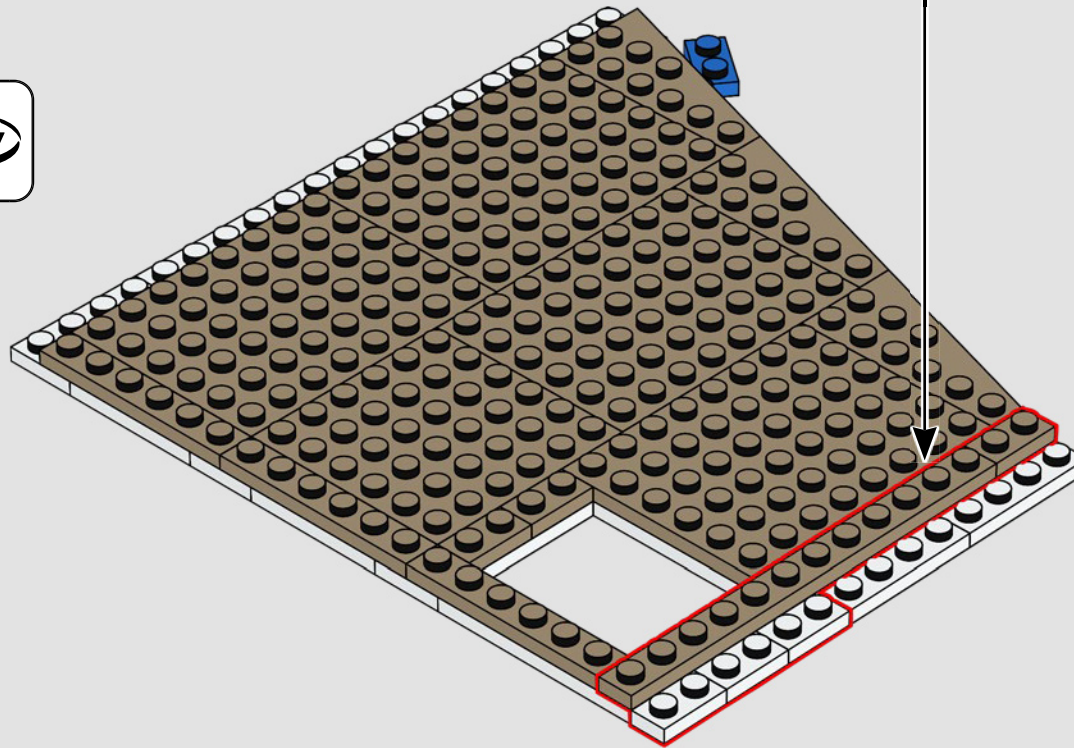
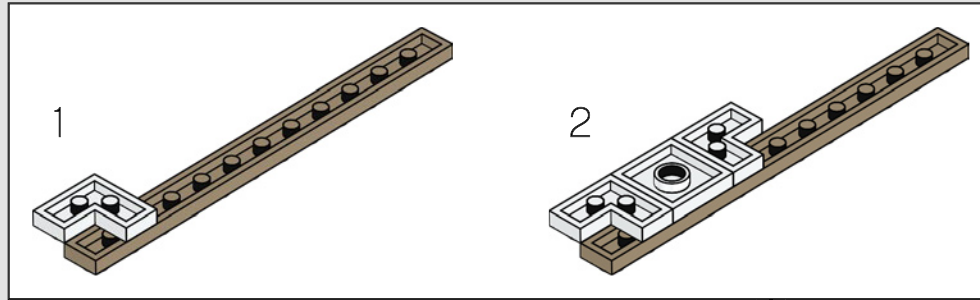

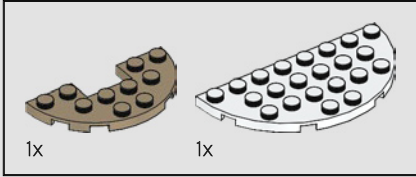
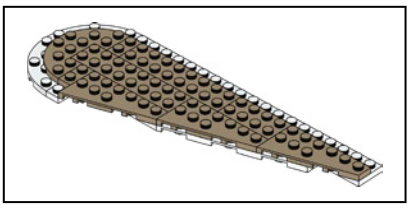

305

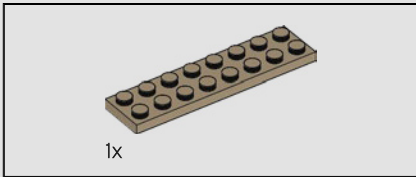
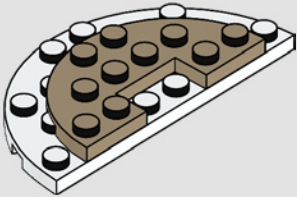

306

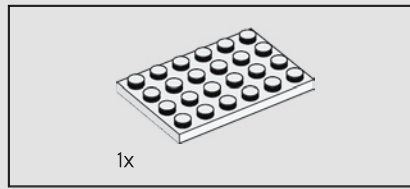
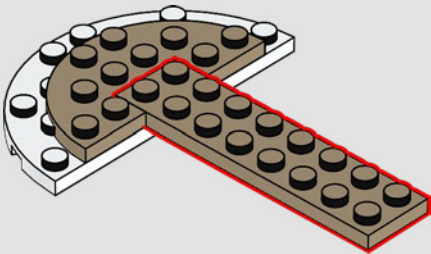

307

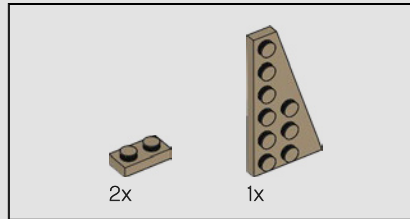
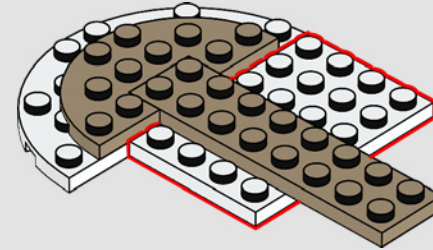

308

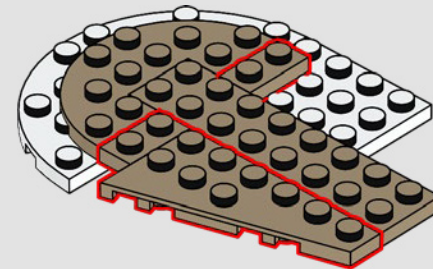

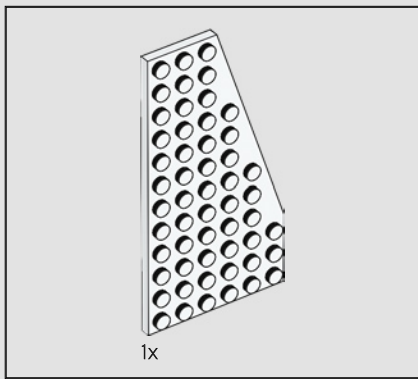

309

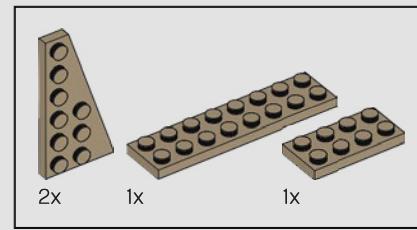
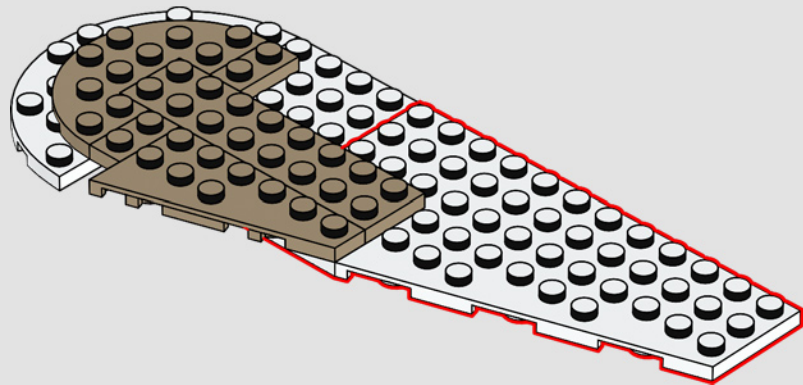

310

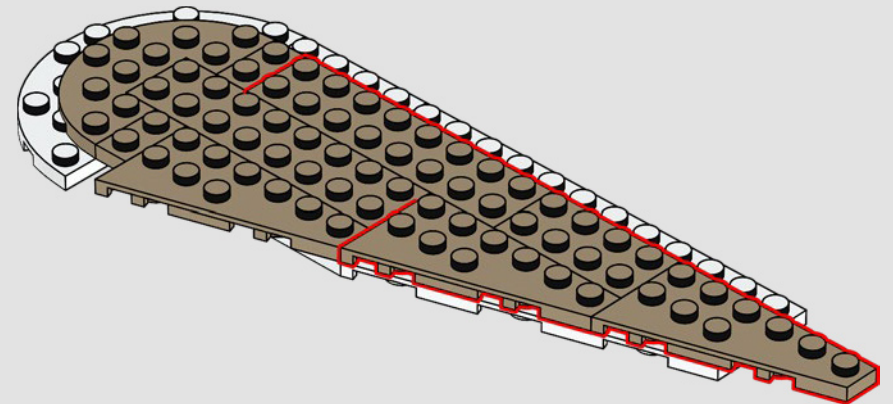

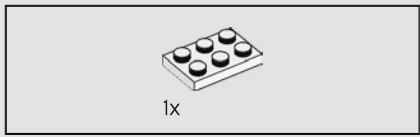

311

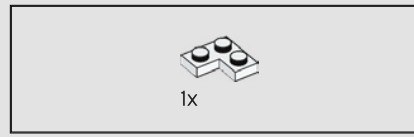
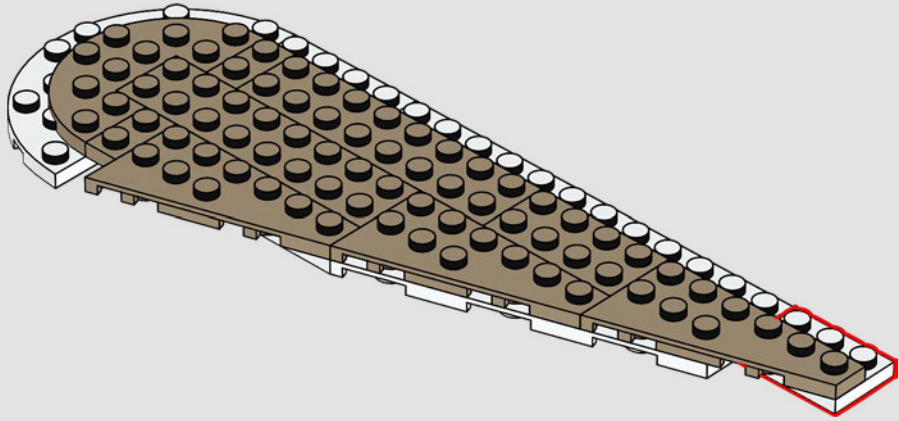

312

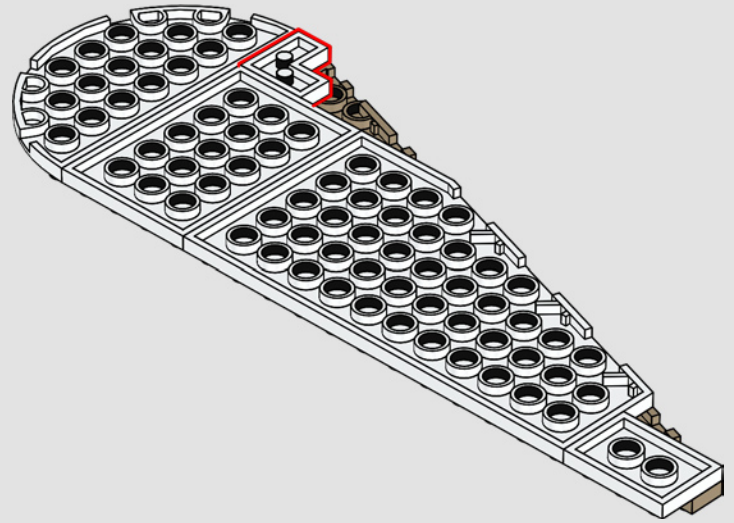
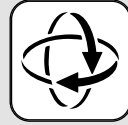

313

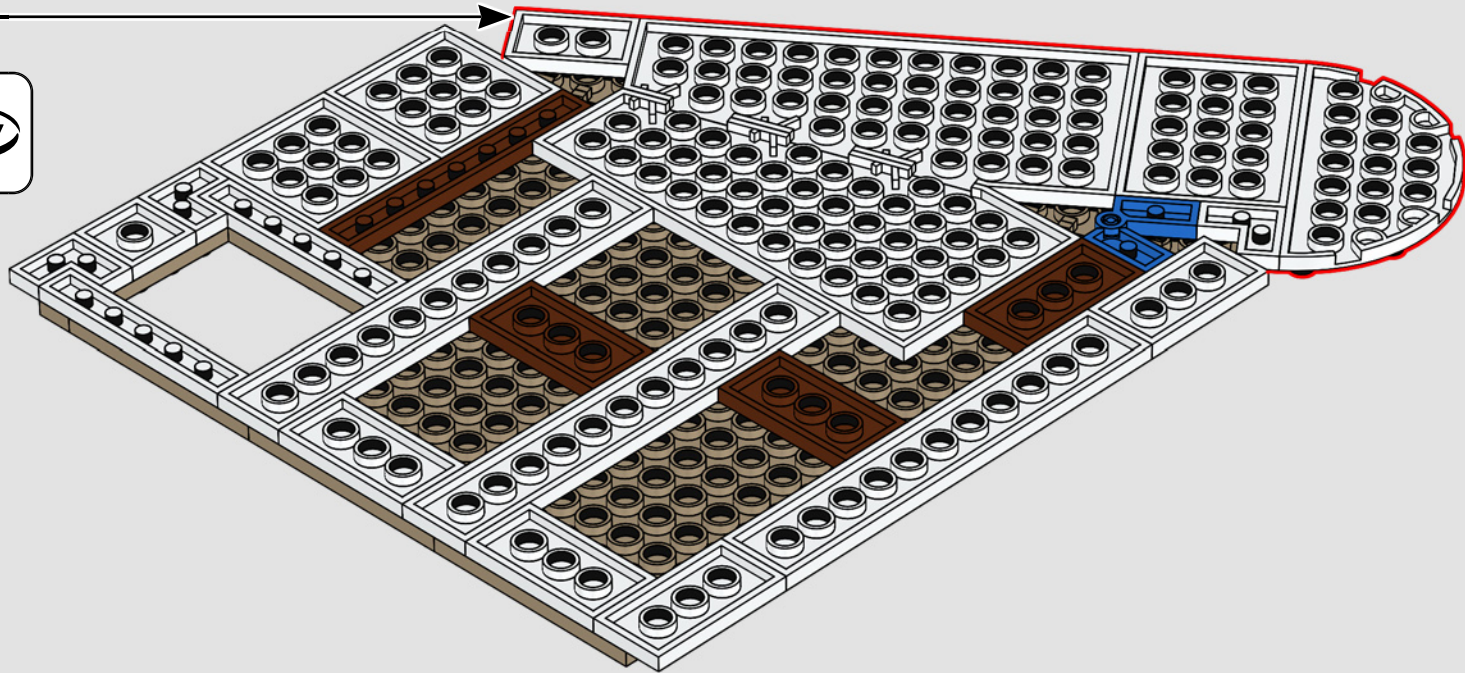

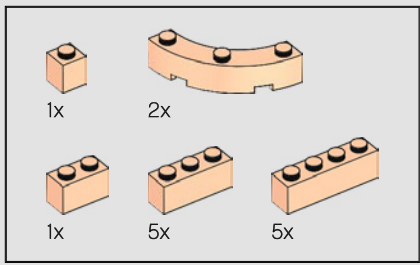

314

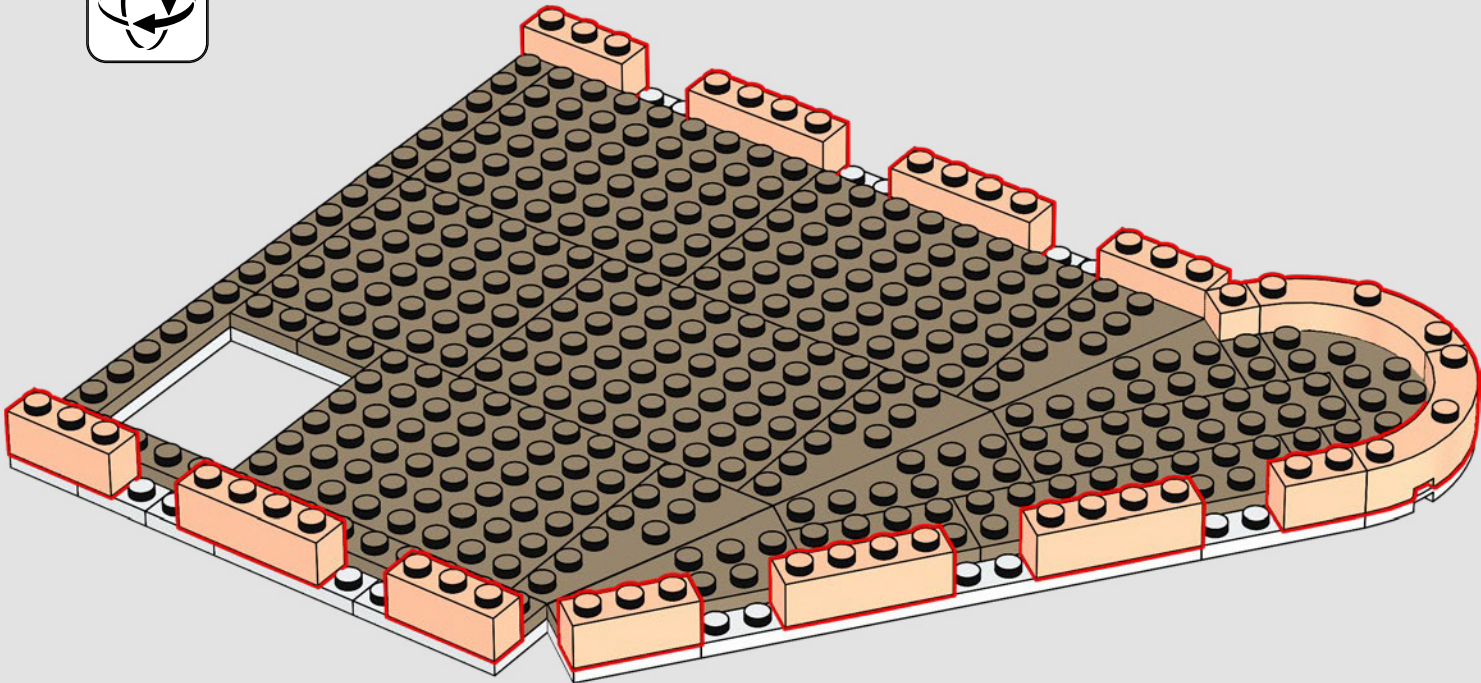



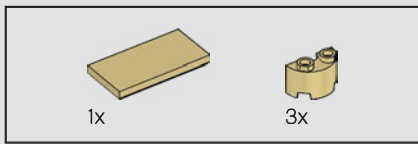

315

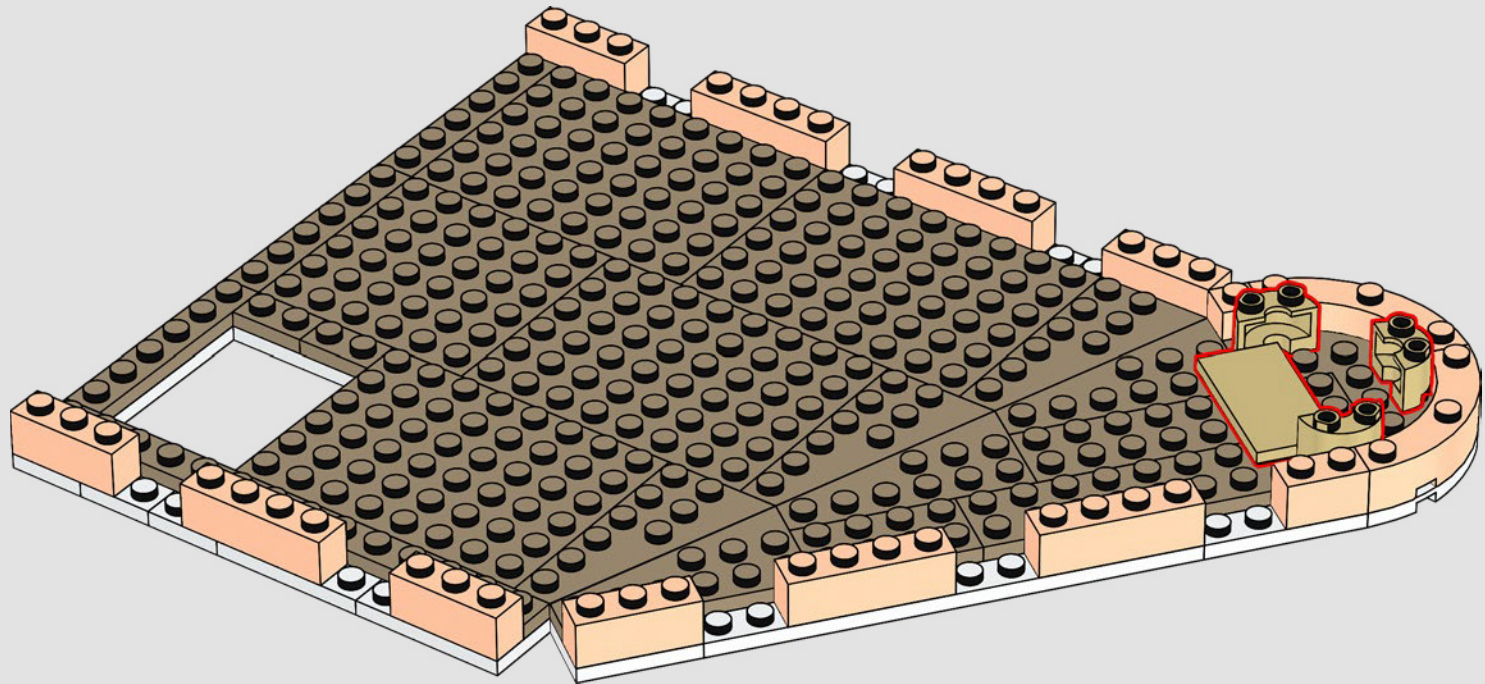

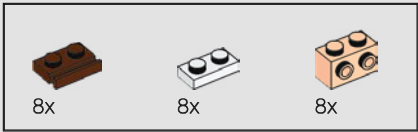

316

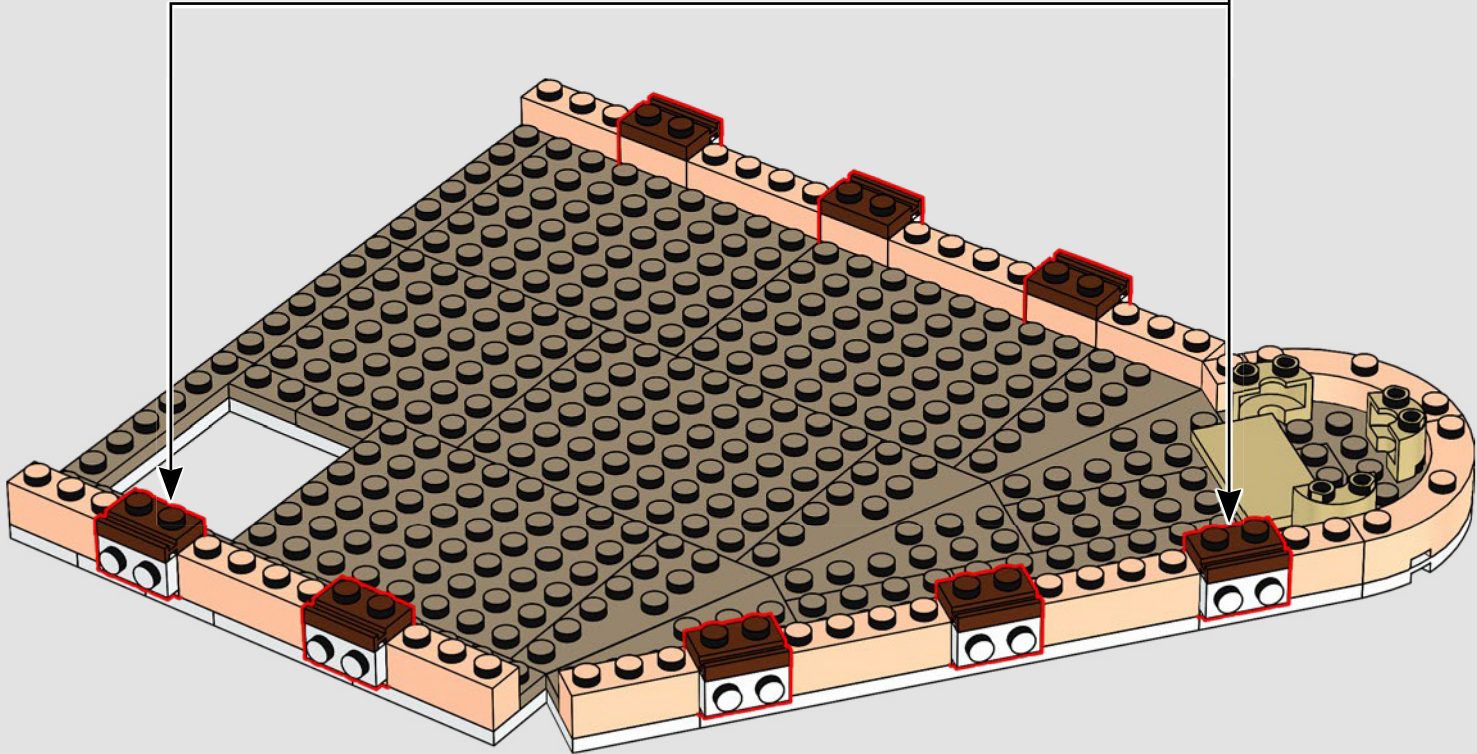
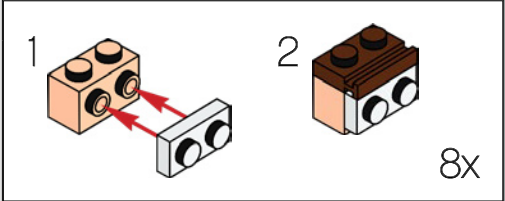

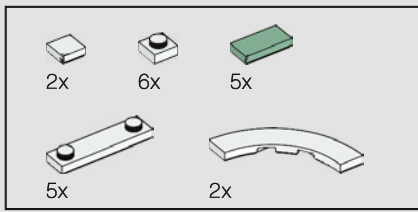

317

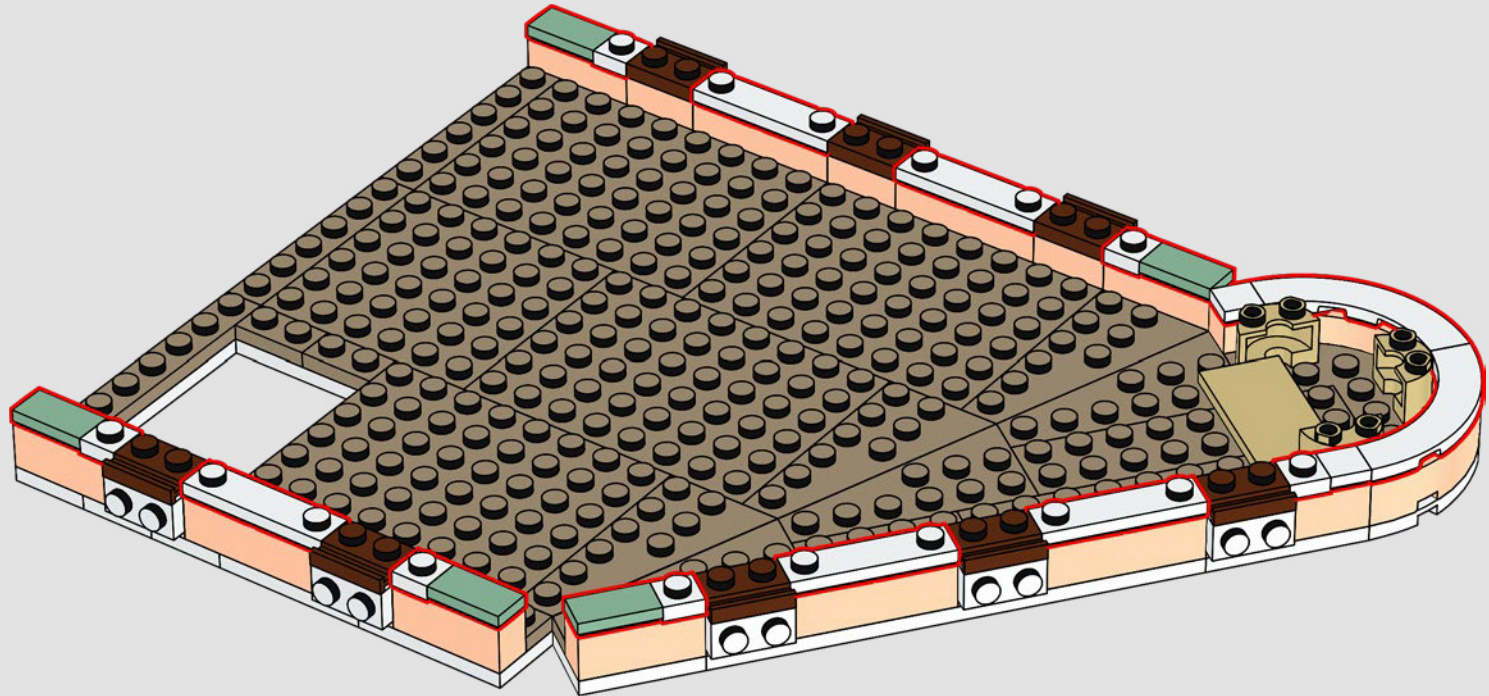

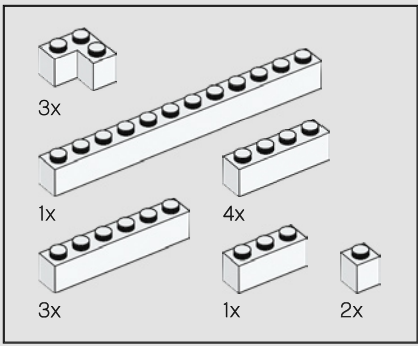

318

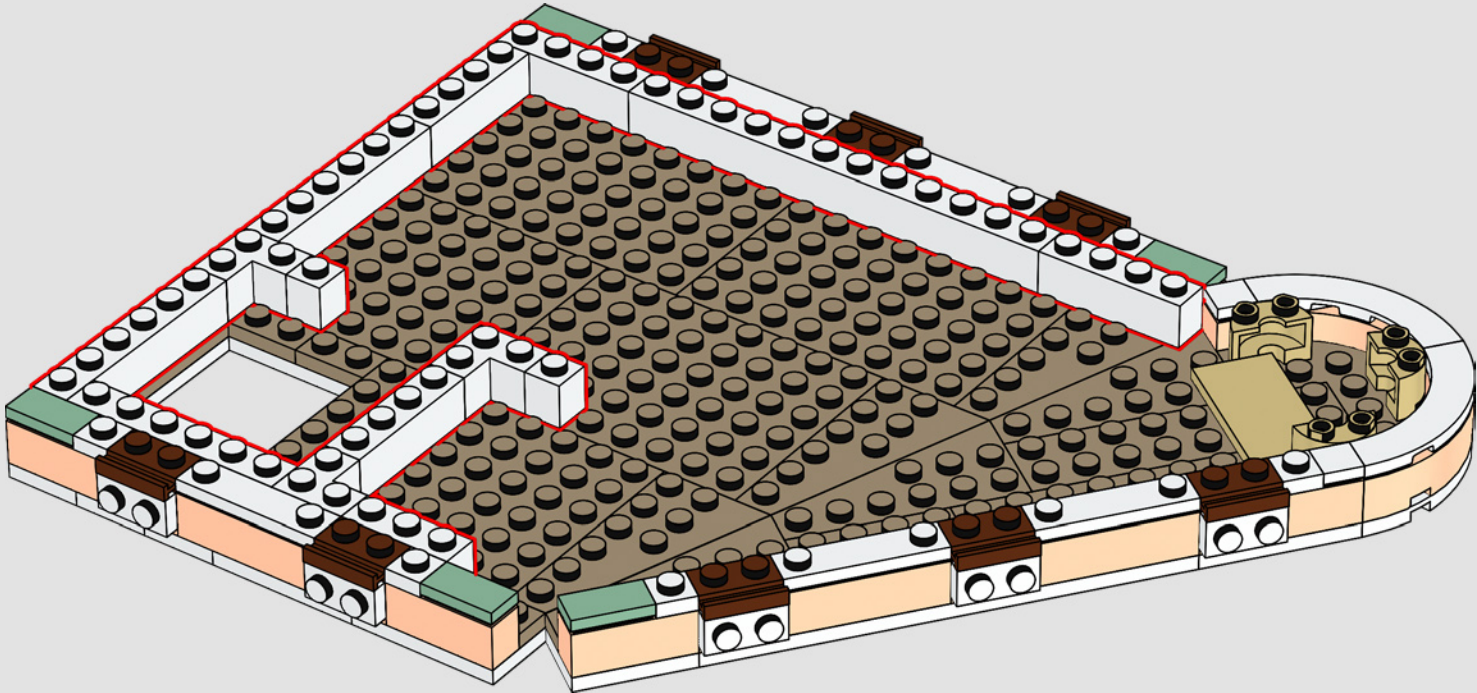

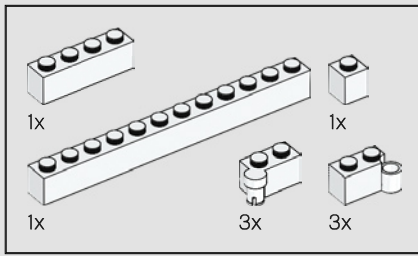

319

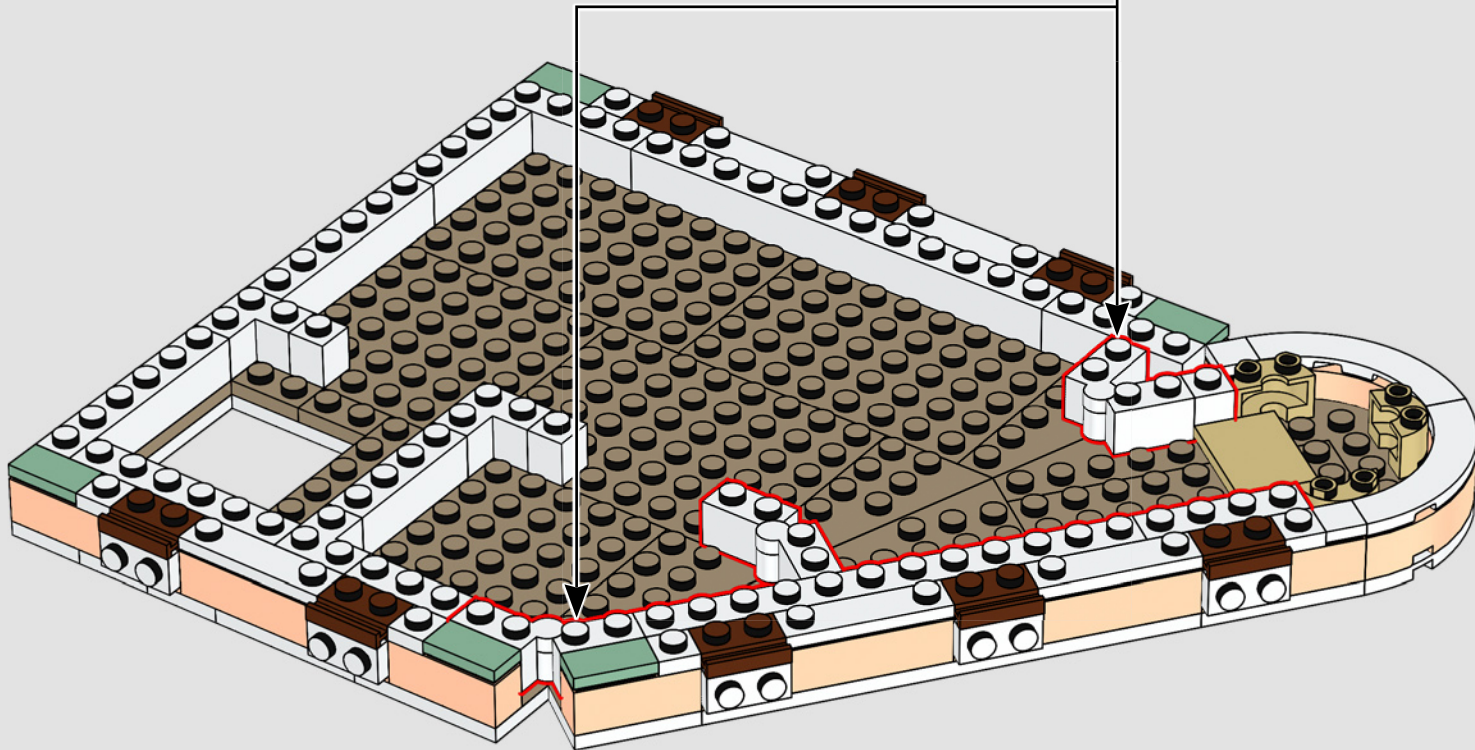
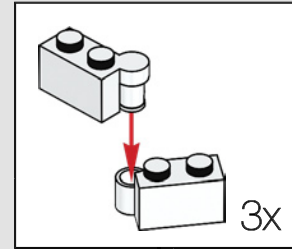

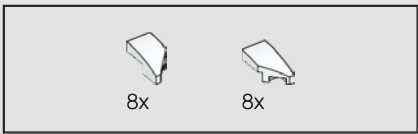

320

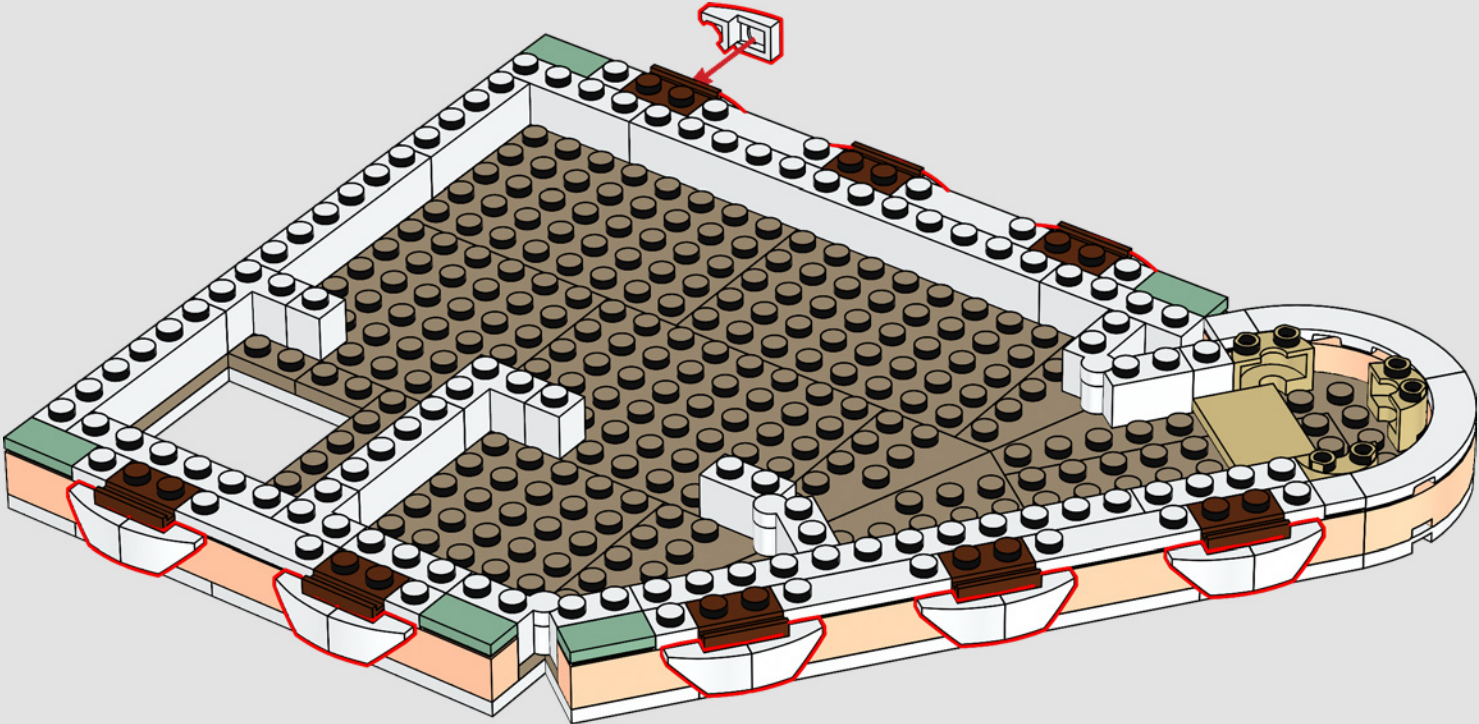

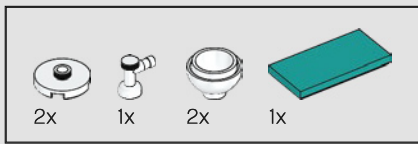

321

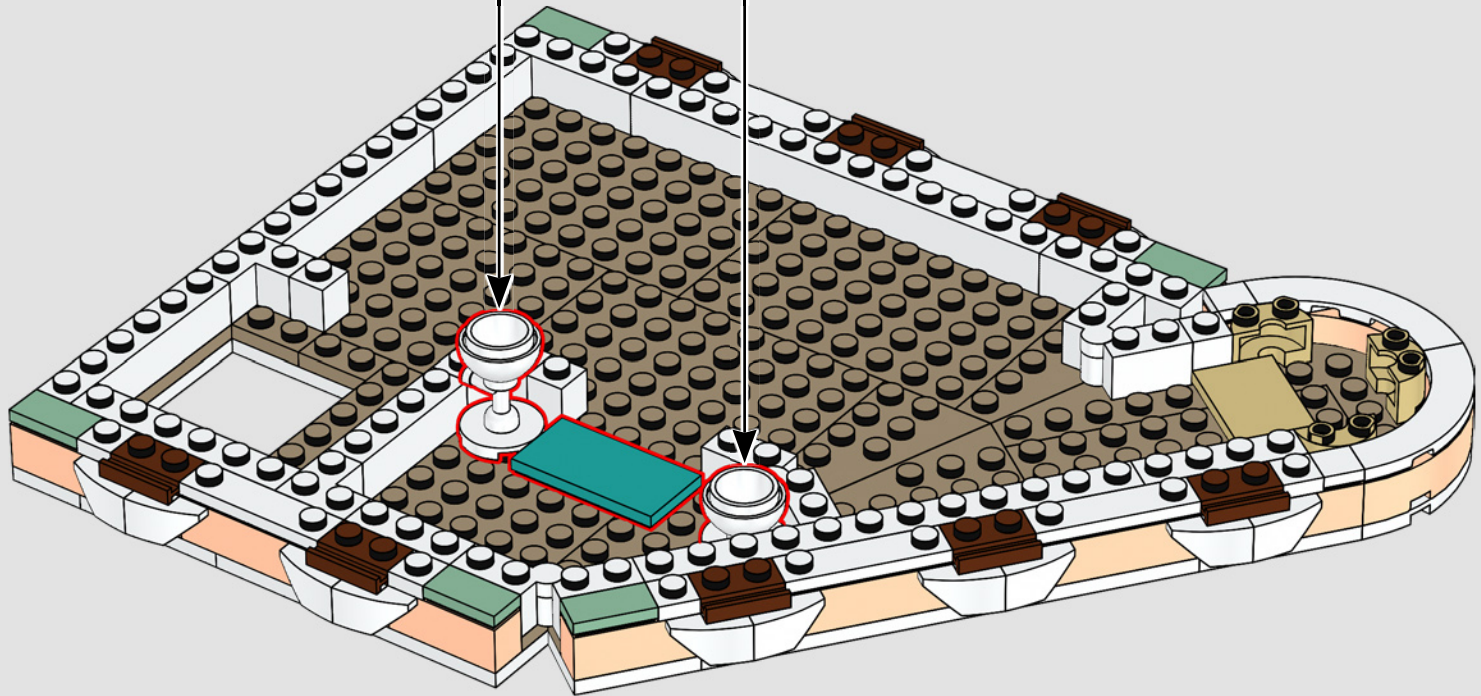
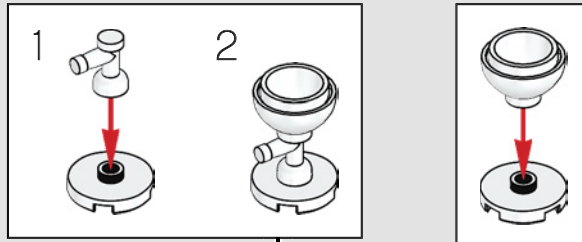





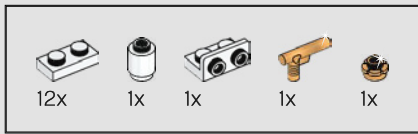

323

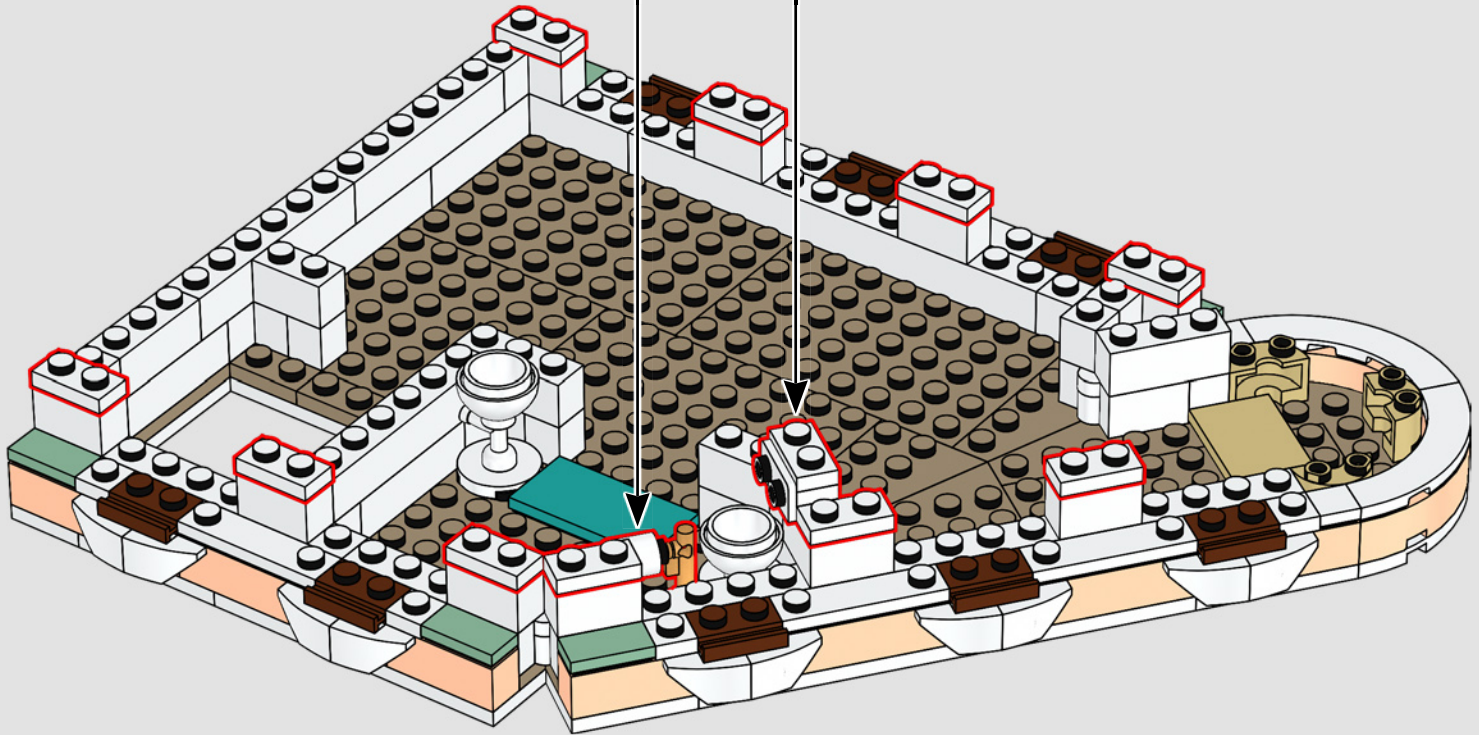
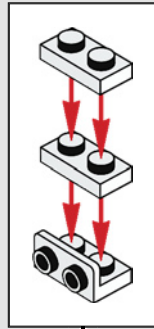
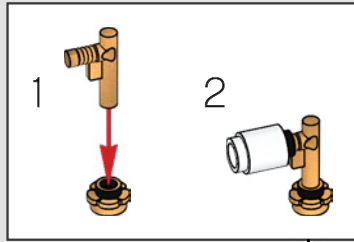

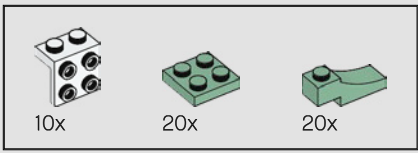

324

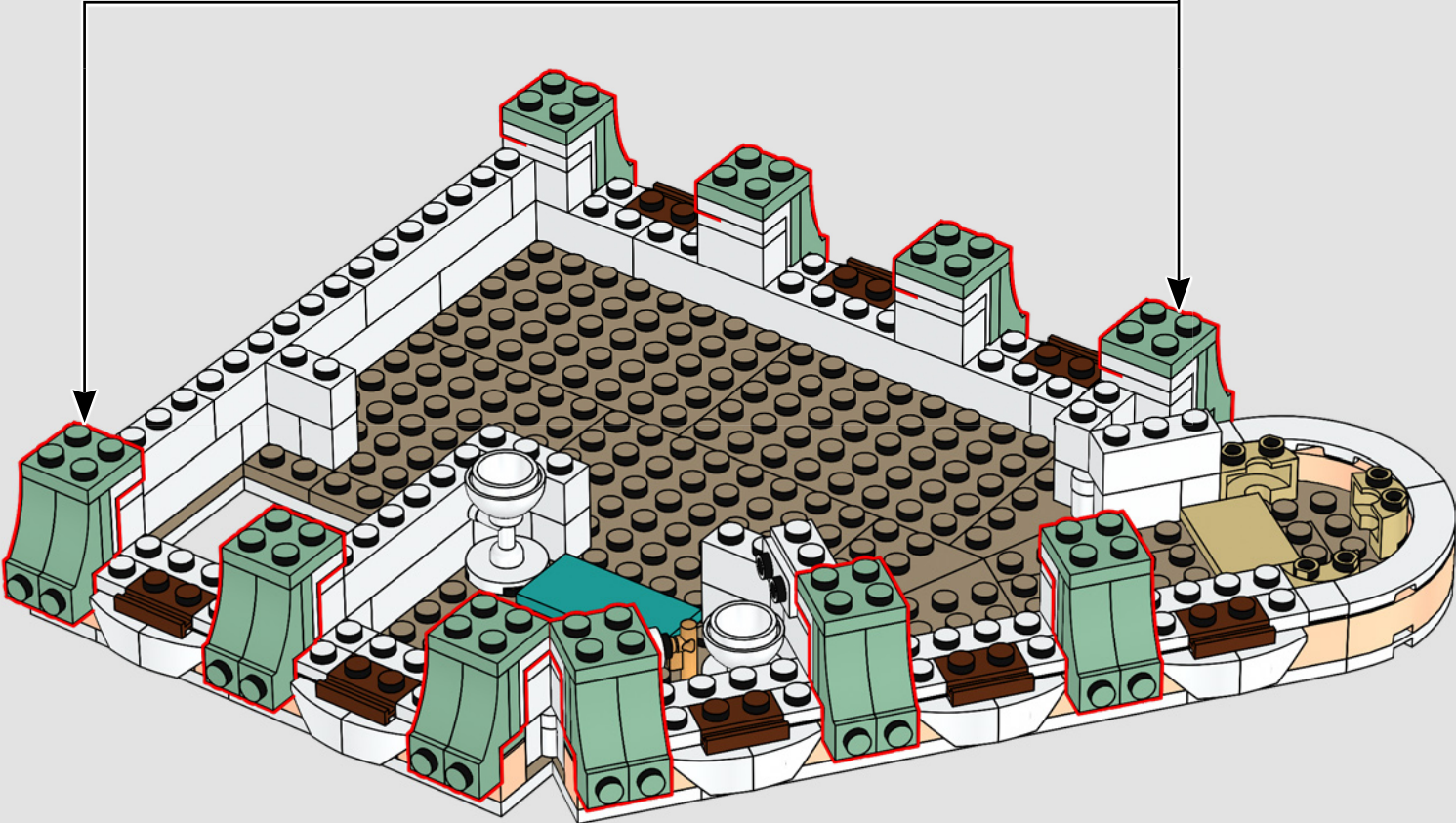
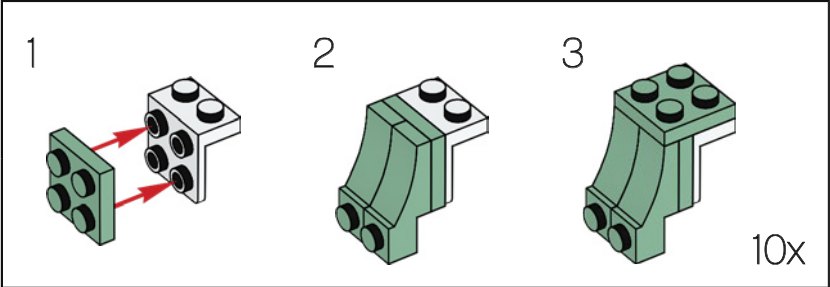

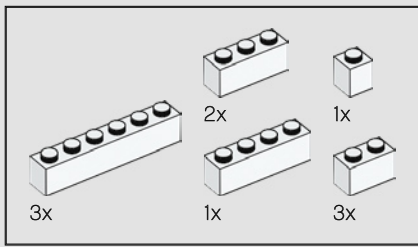

325

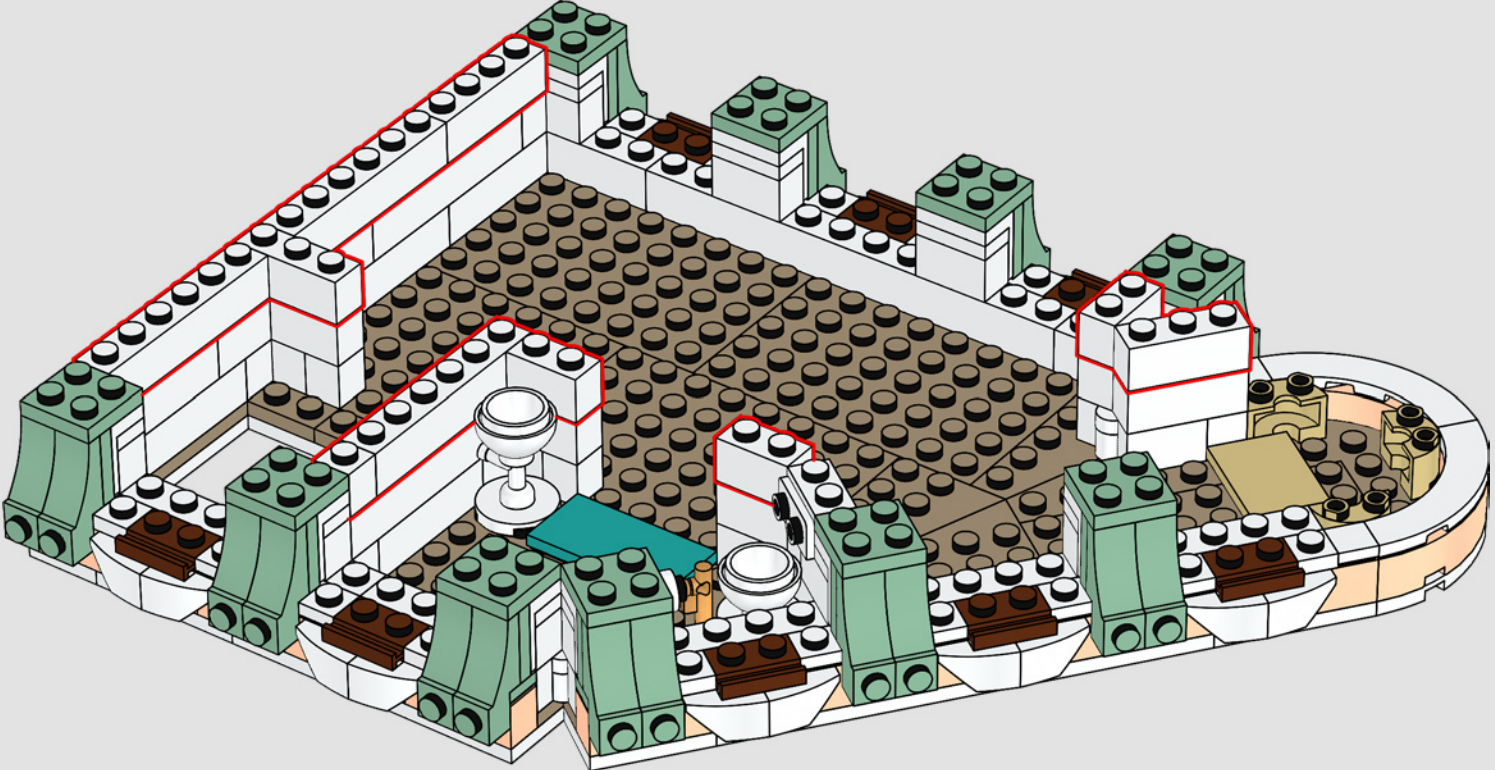

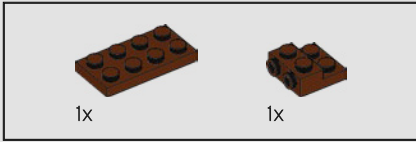

326

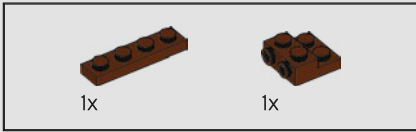
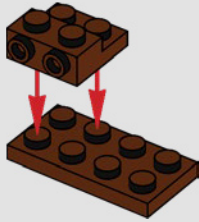

327

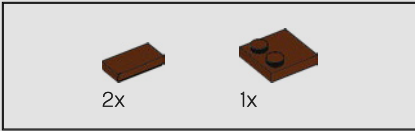
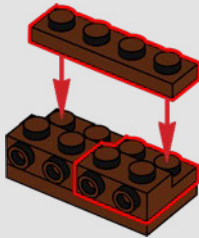

328

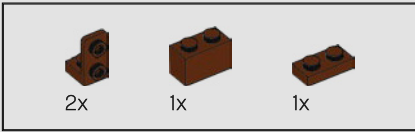
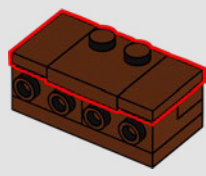

329

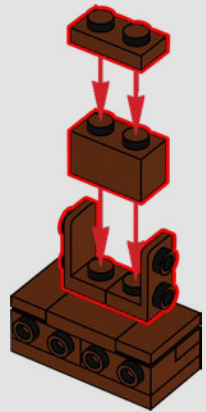

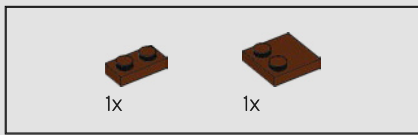

330

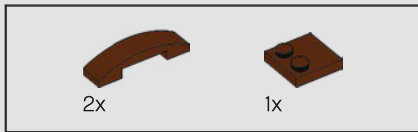
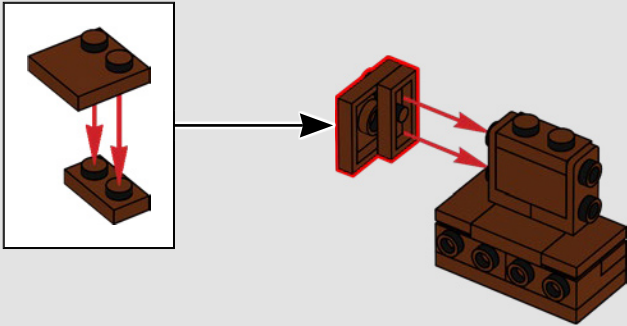

331

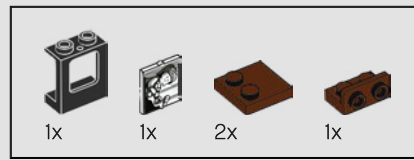
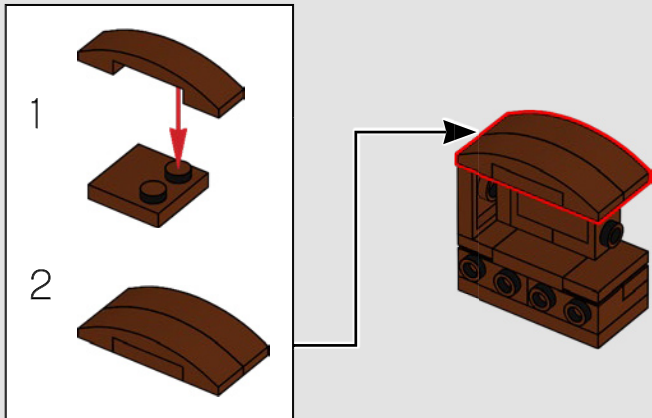

332

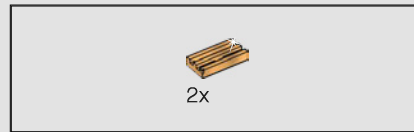
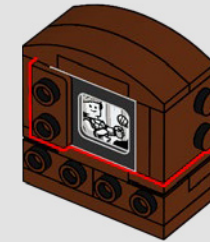
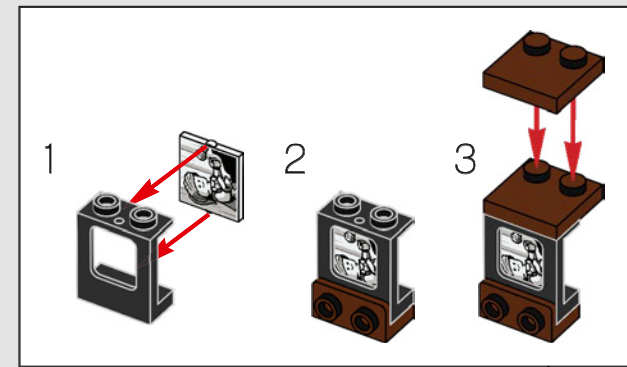

333



334

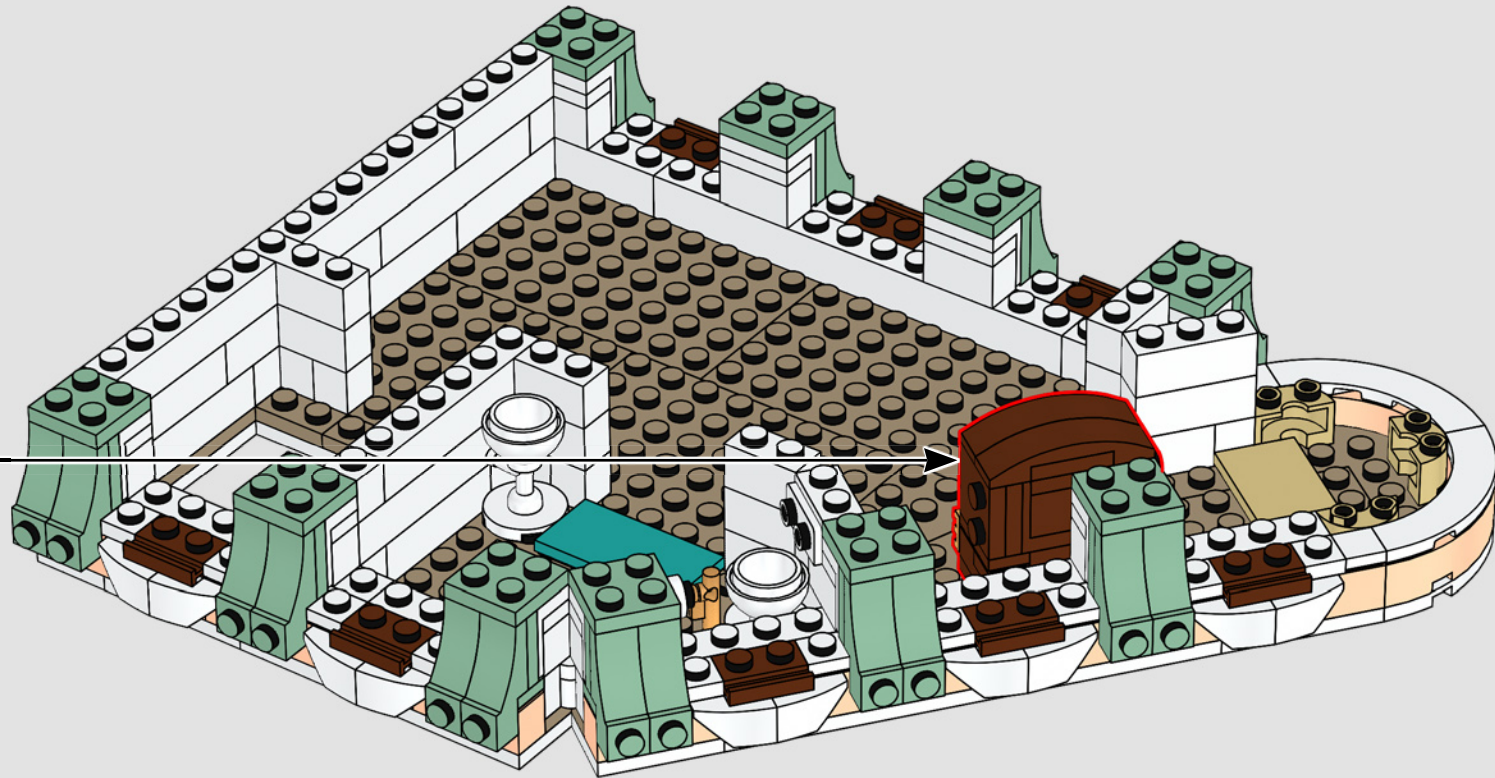



The Globetrotter has been all over the world, but always loves to come back to the Boutique Hotel for a relaxing stay.

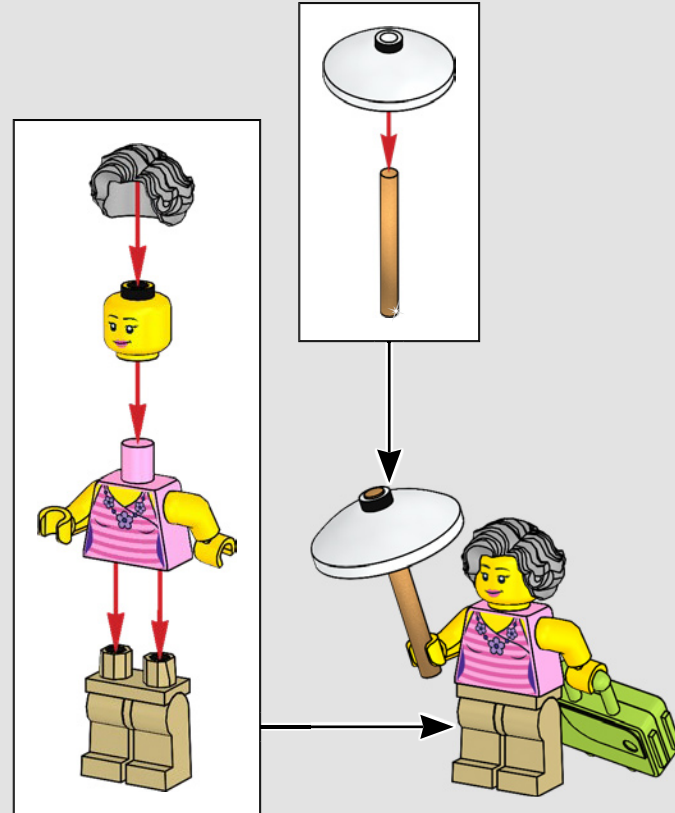
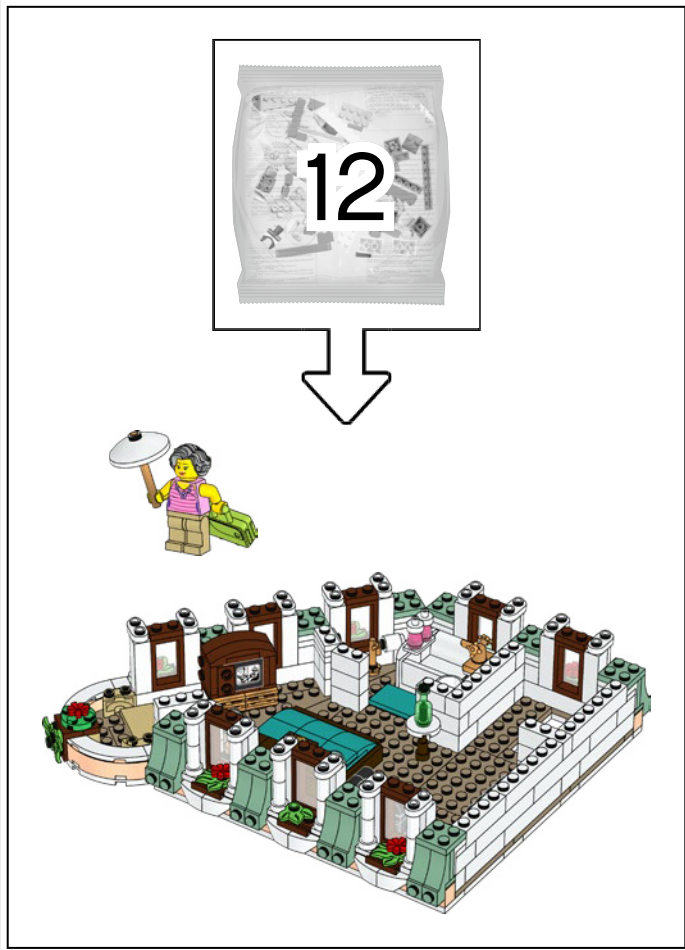

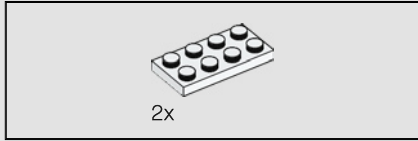
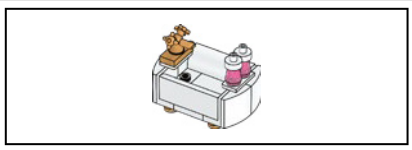

2x

335

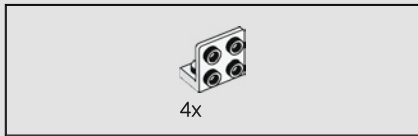
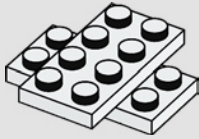

4x

336

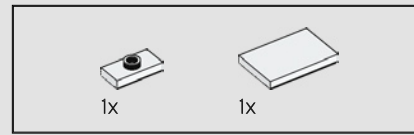
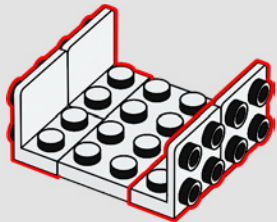

1x

1x

337

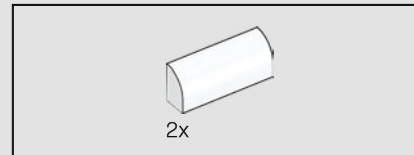
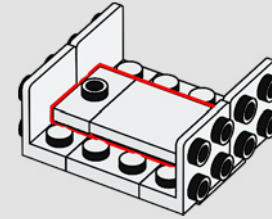

2x

338

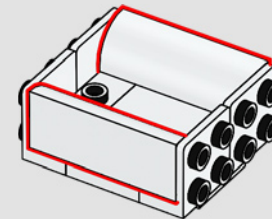



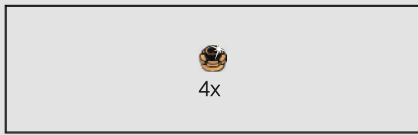

339

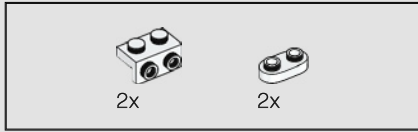
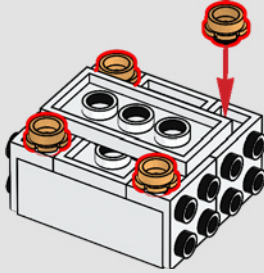

340

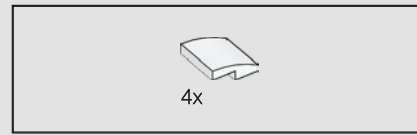
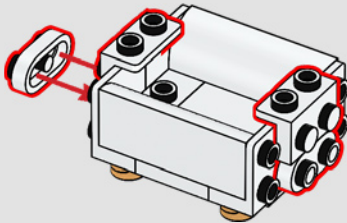

341

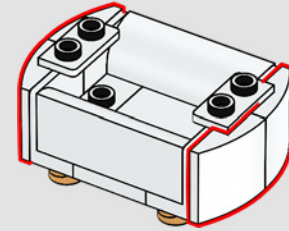

342

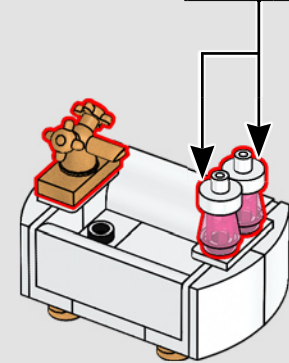
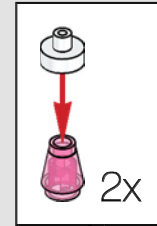

343

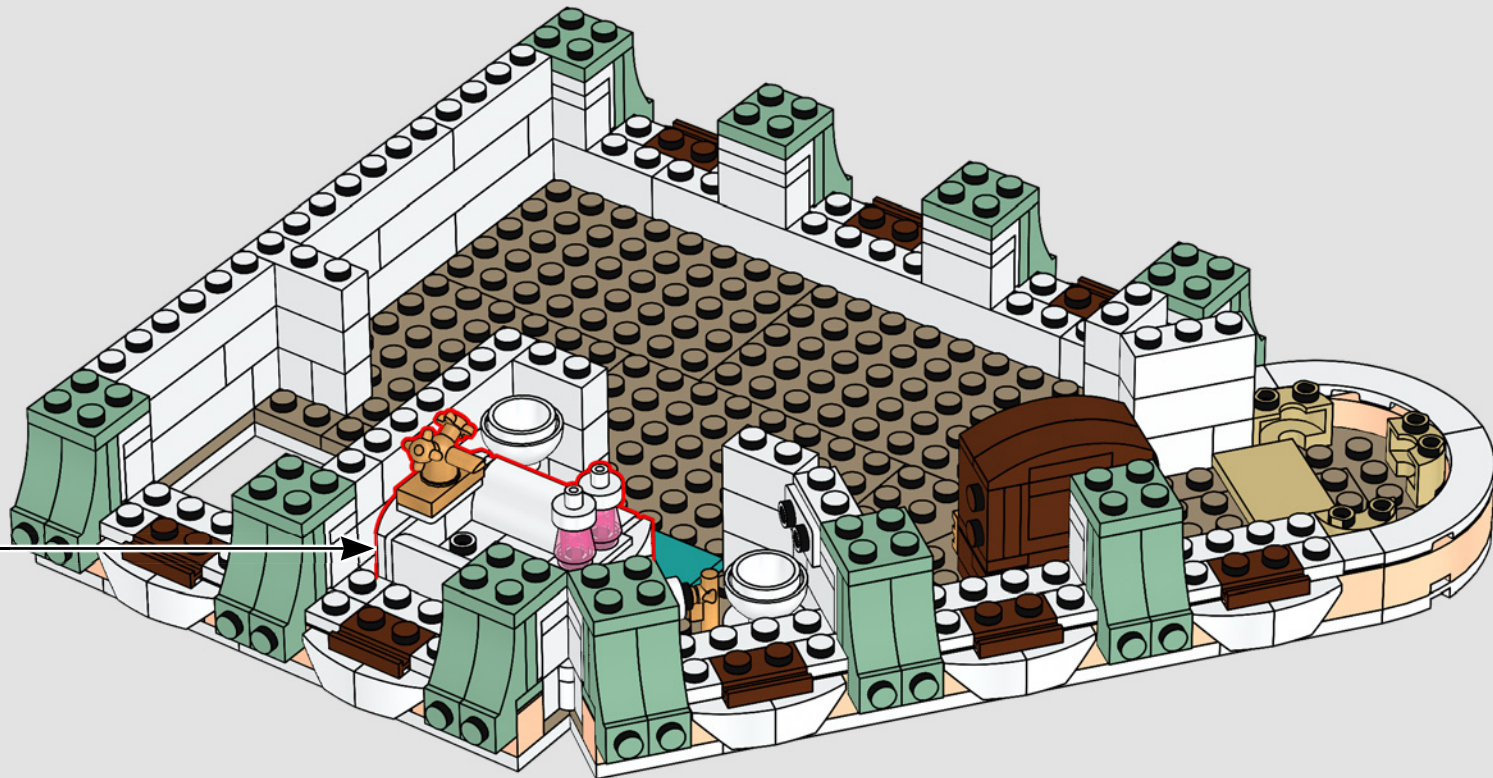

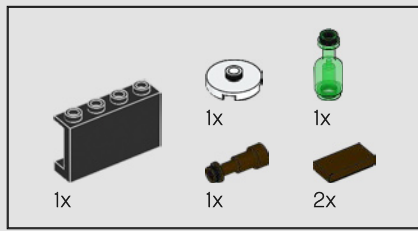

344

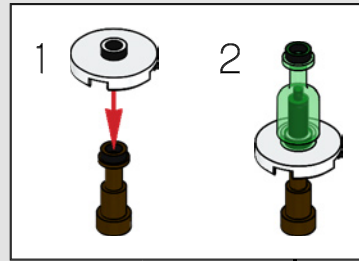

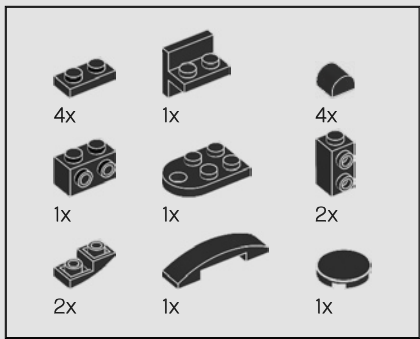

345

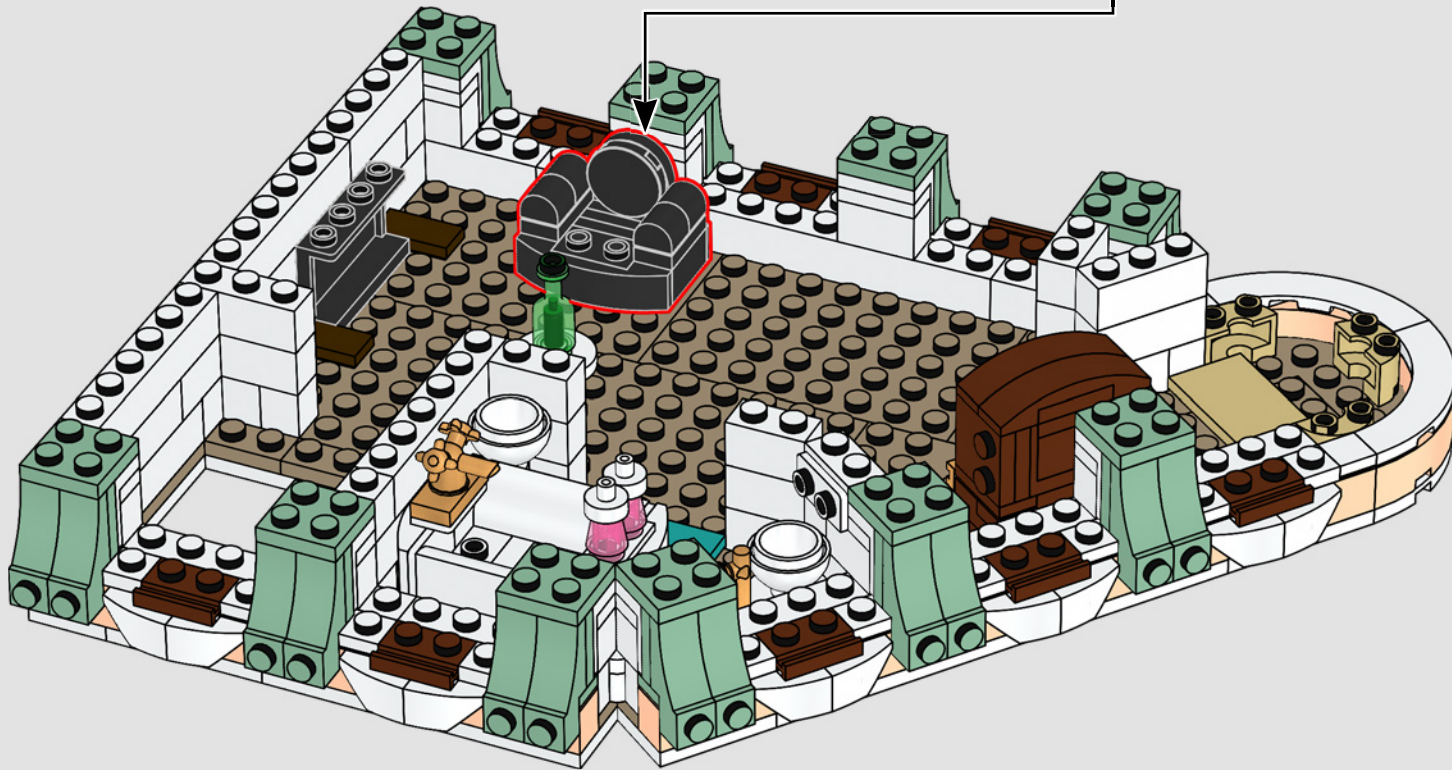
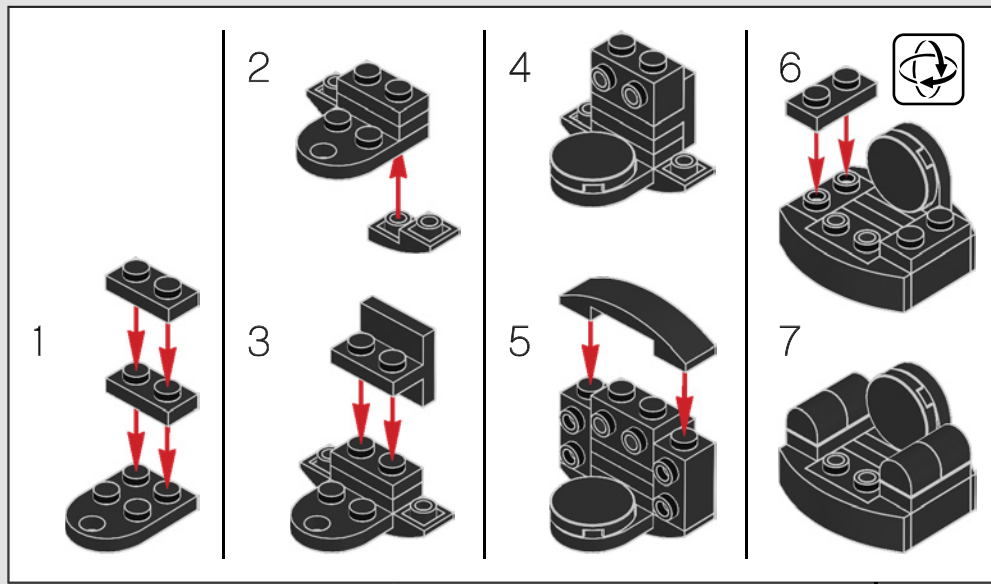



The lampshade element here is actually a cupcake element from LEGO® Friends.

346

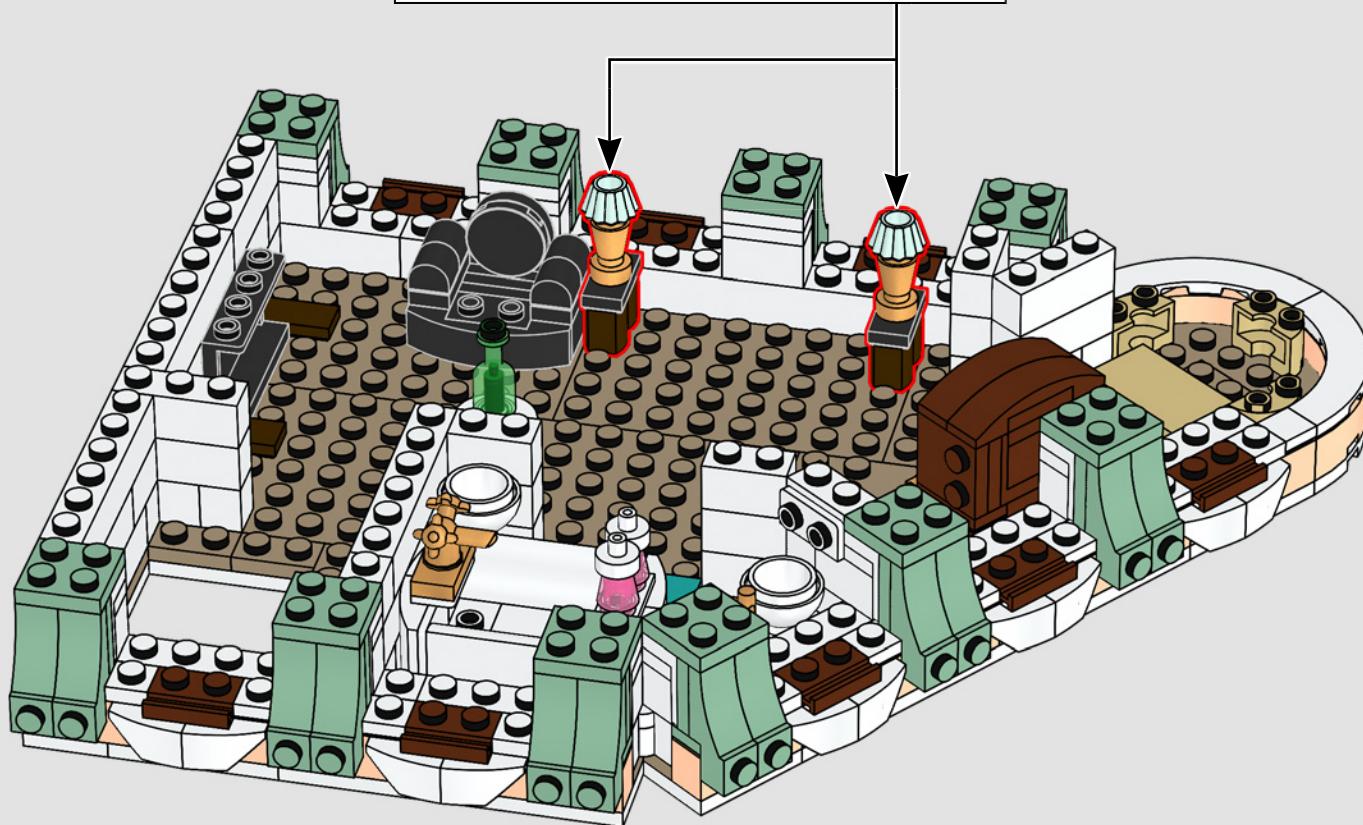
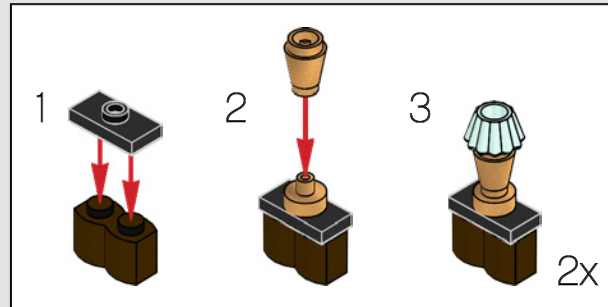

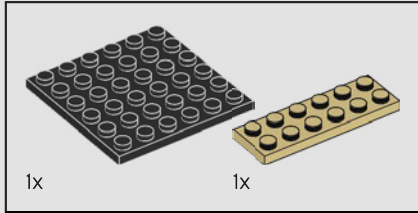
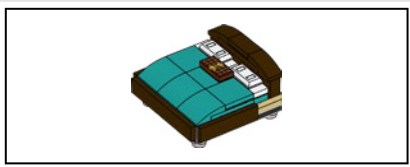

347

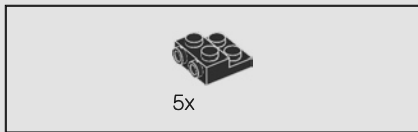
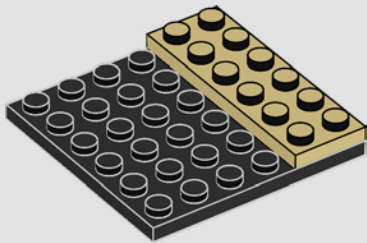

348

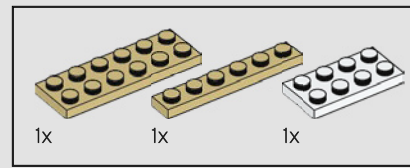
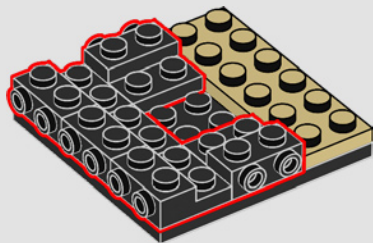

349

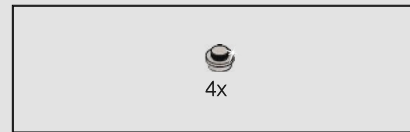
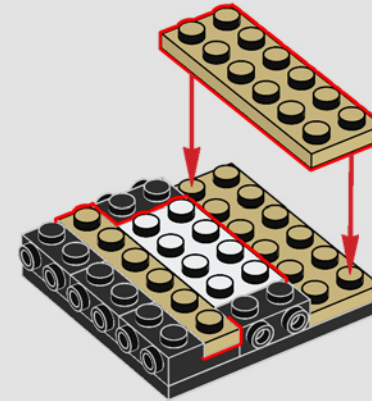

350

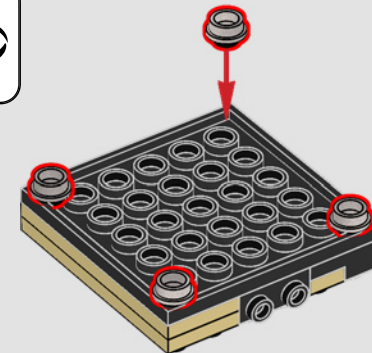
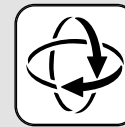

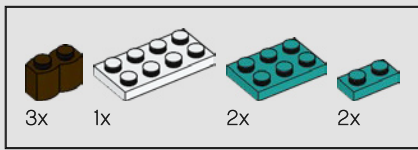

351

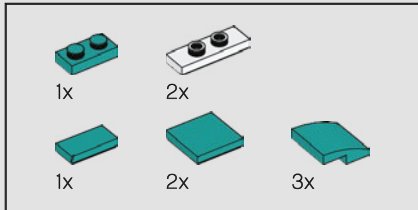
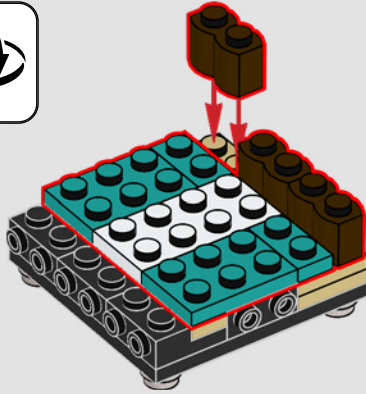

352

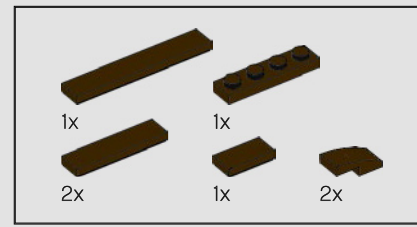
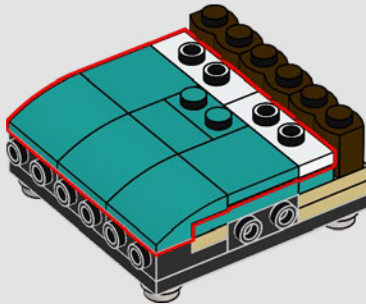

353

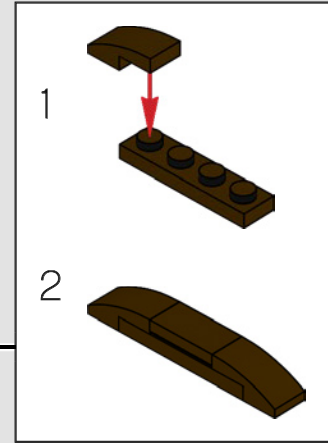
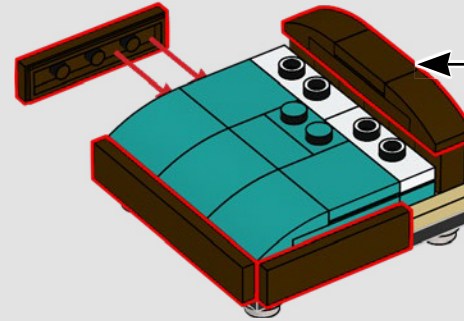

354

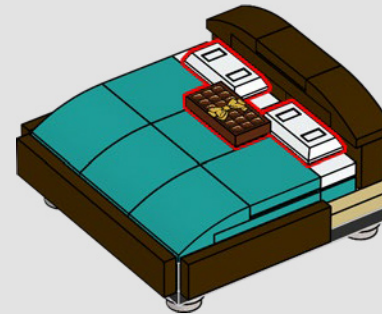

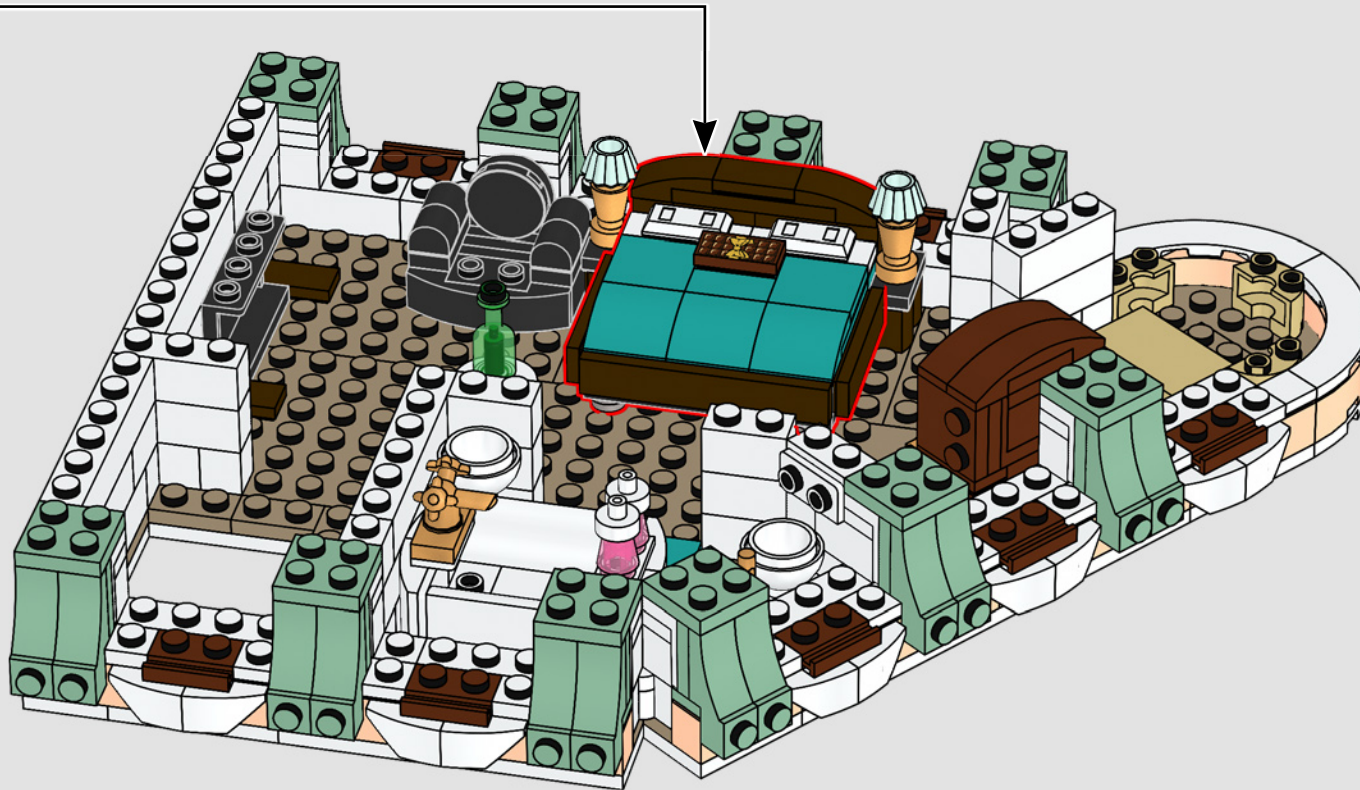



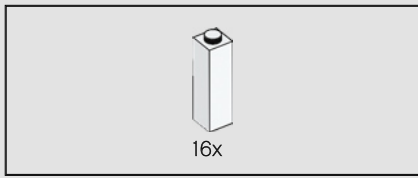

356

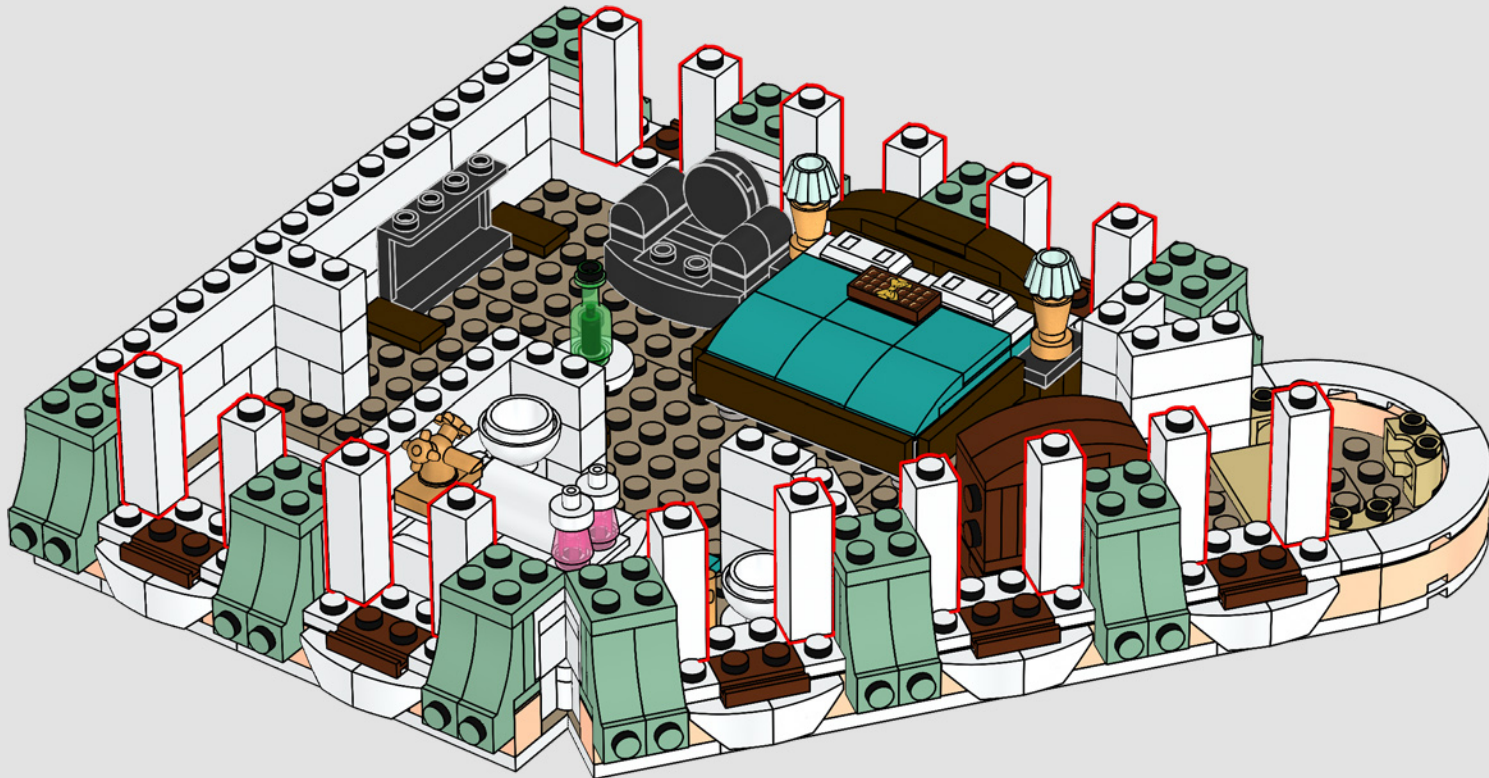

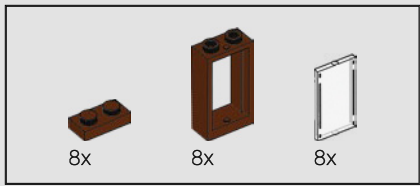

357

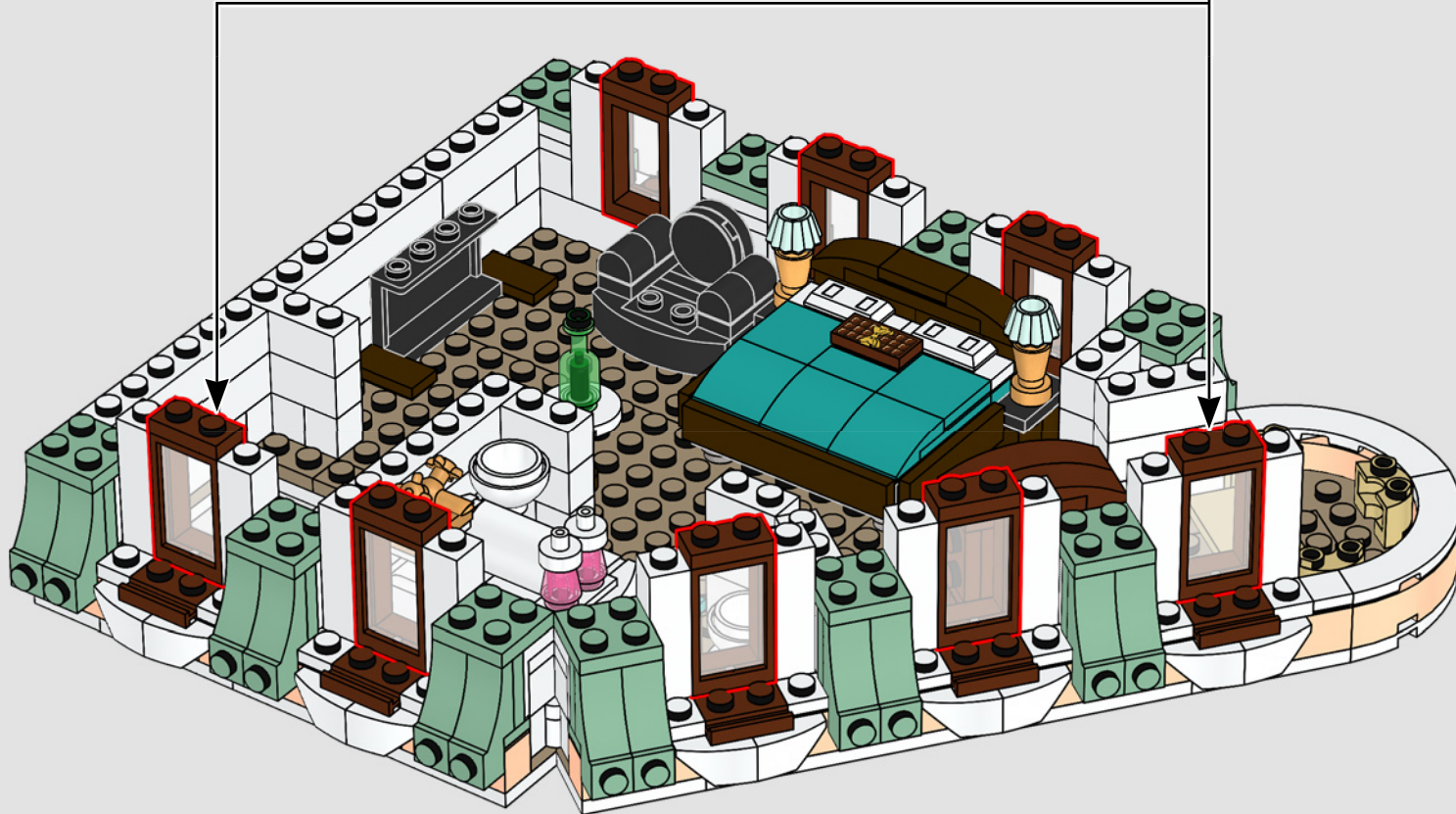
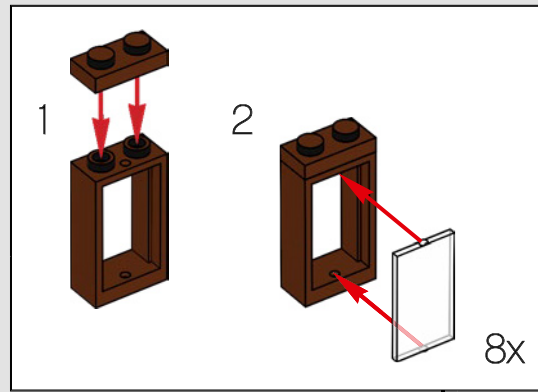

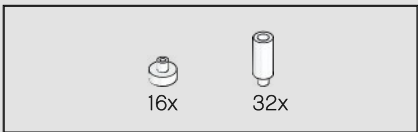

358

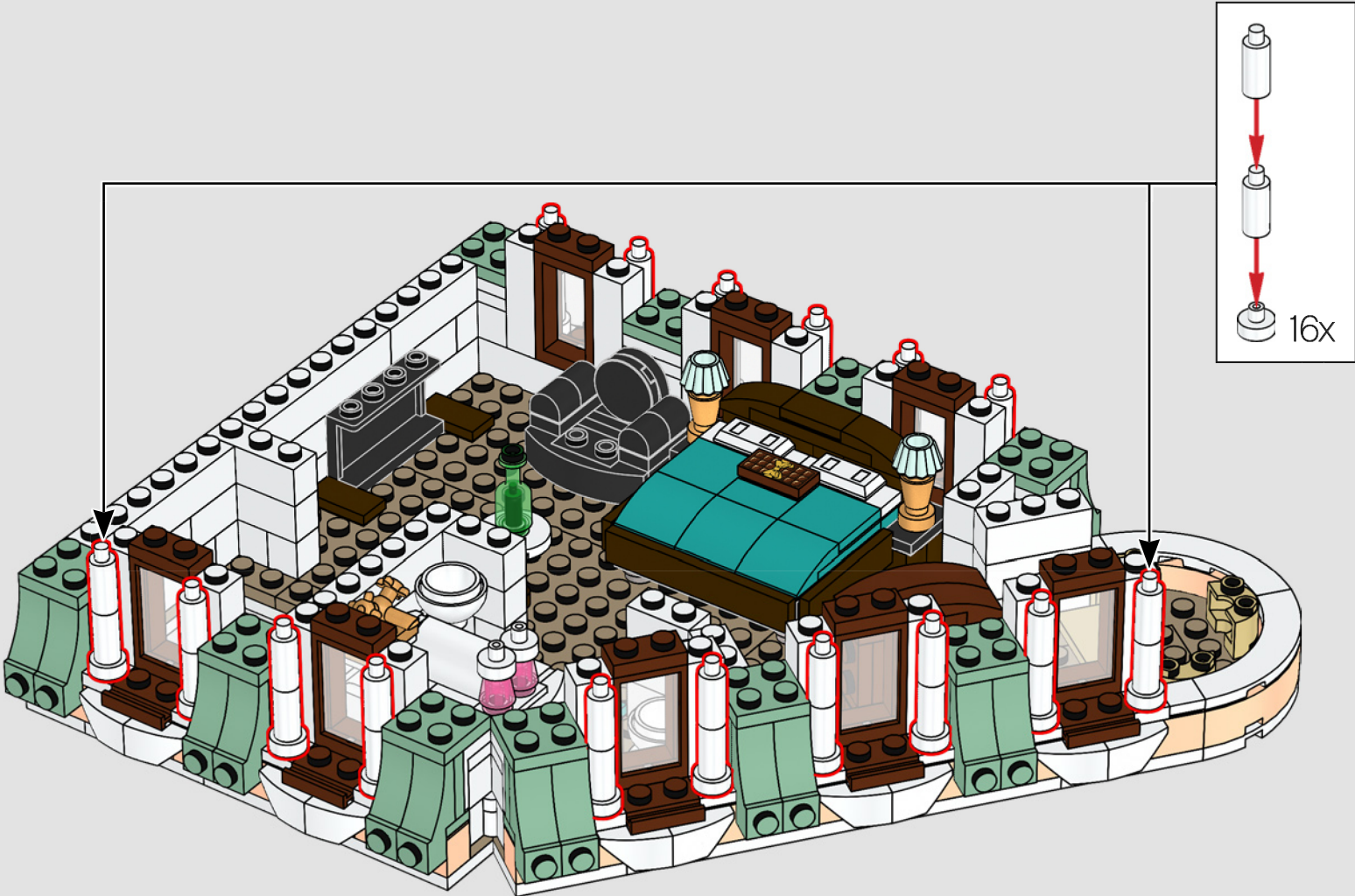





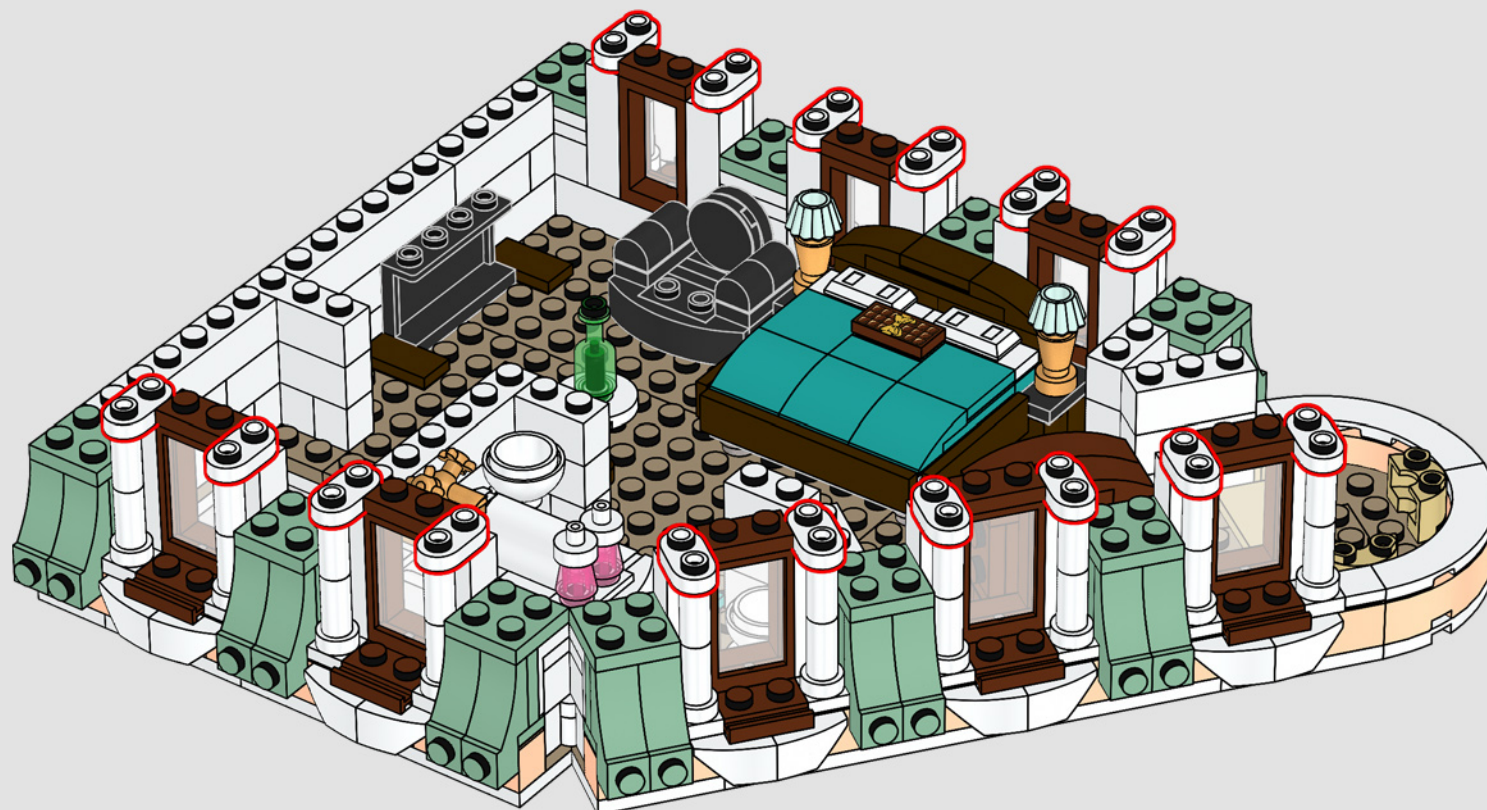

16x

359



3x  5x 

360

  
↓  
 3x

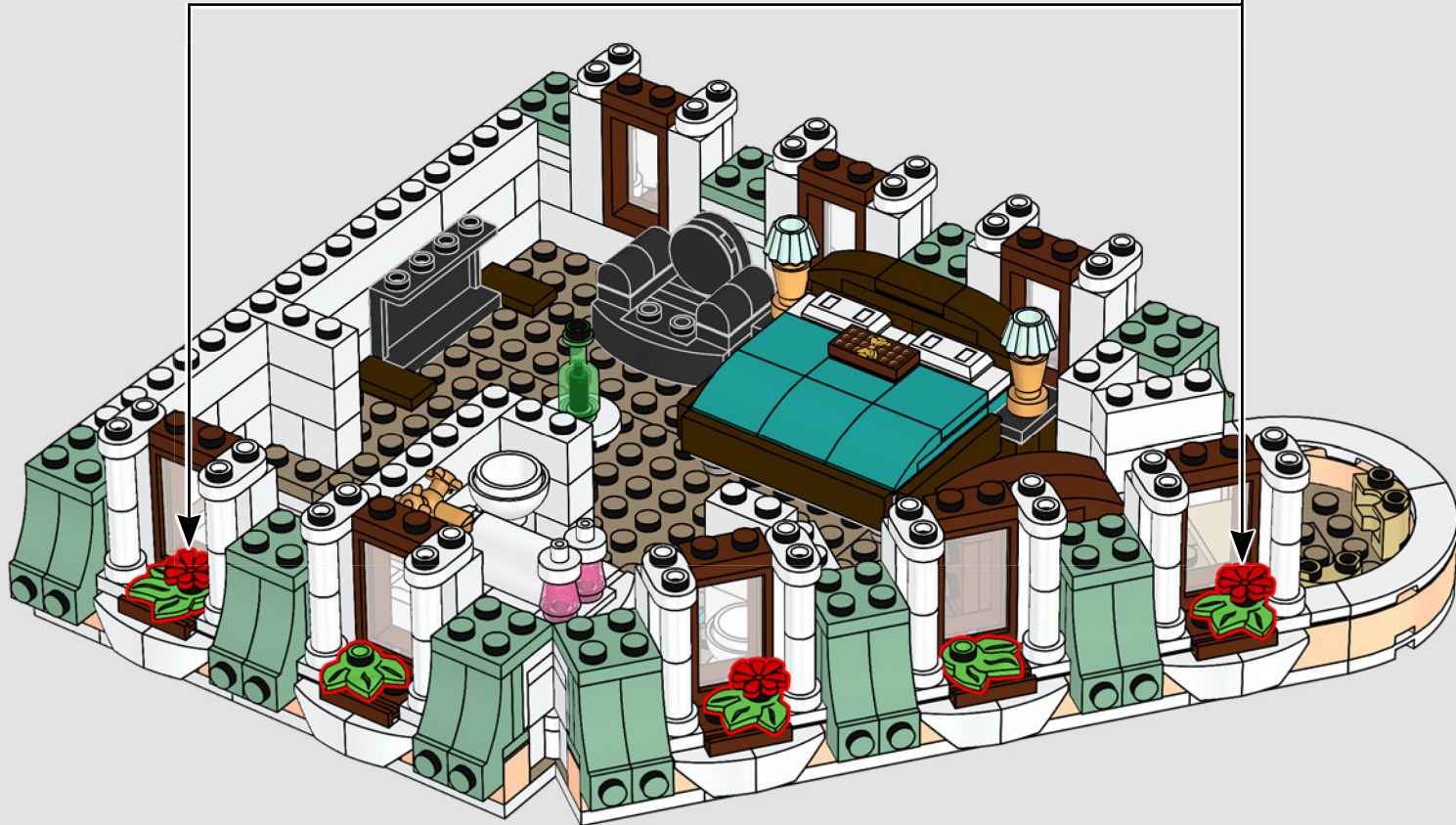

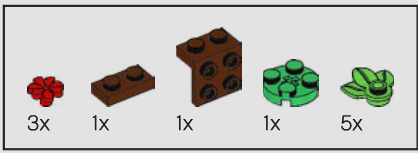

361

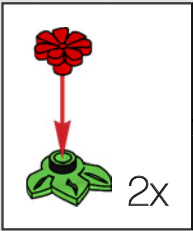
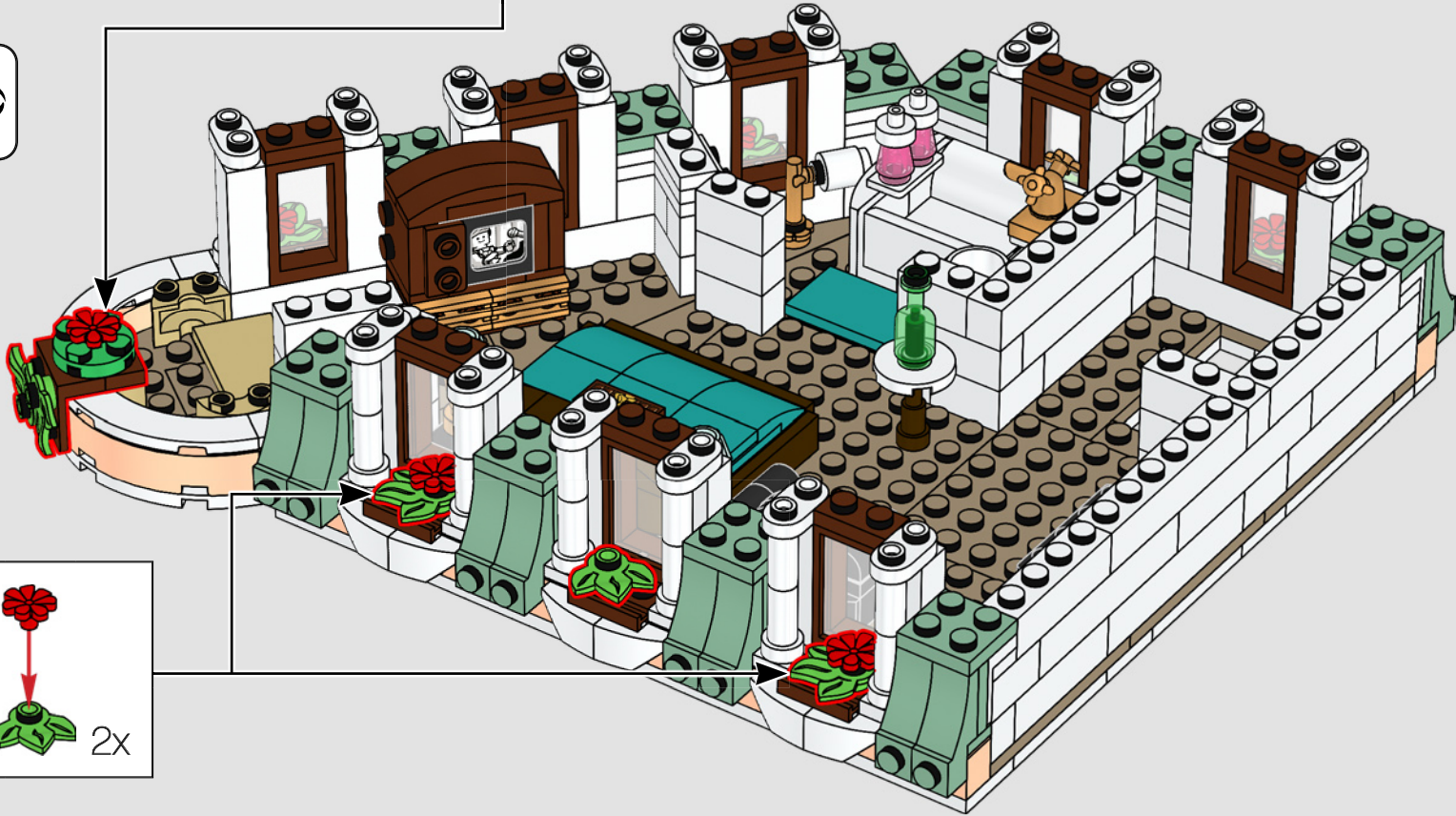
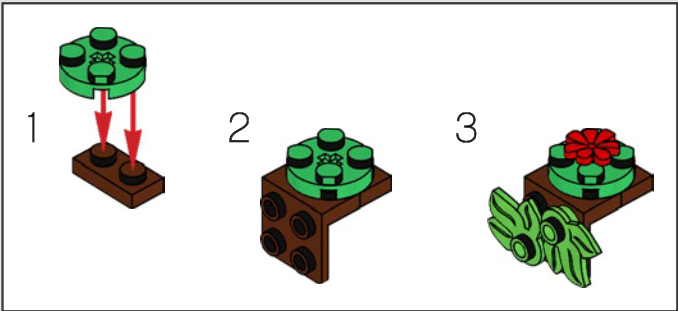

13

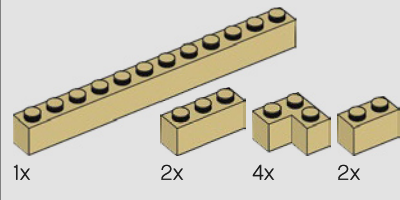

362

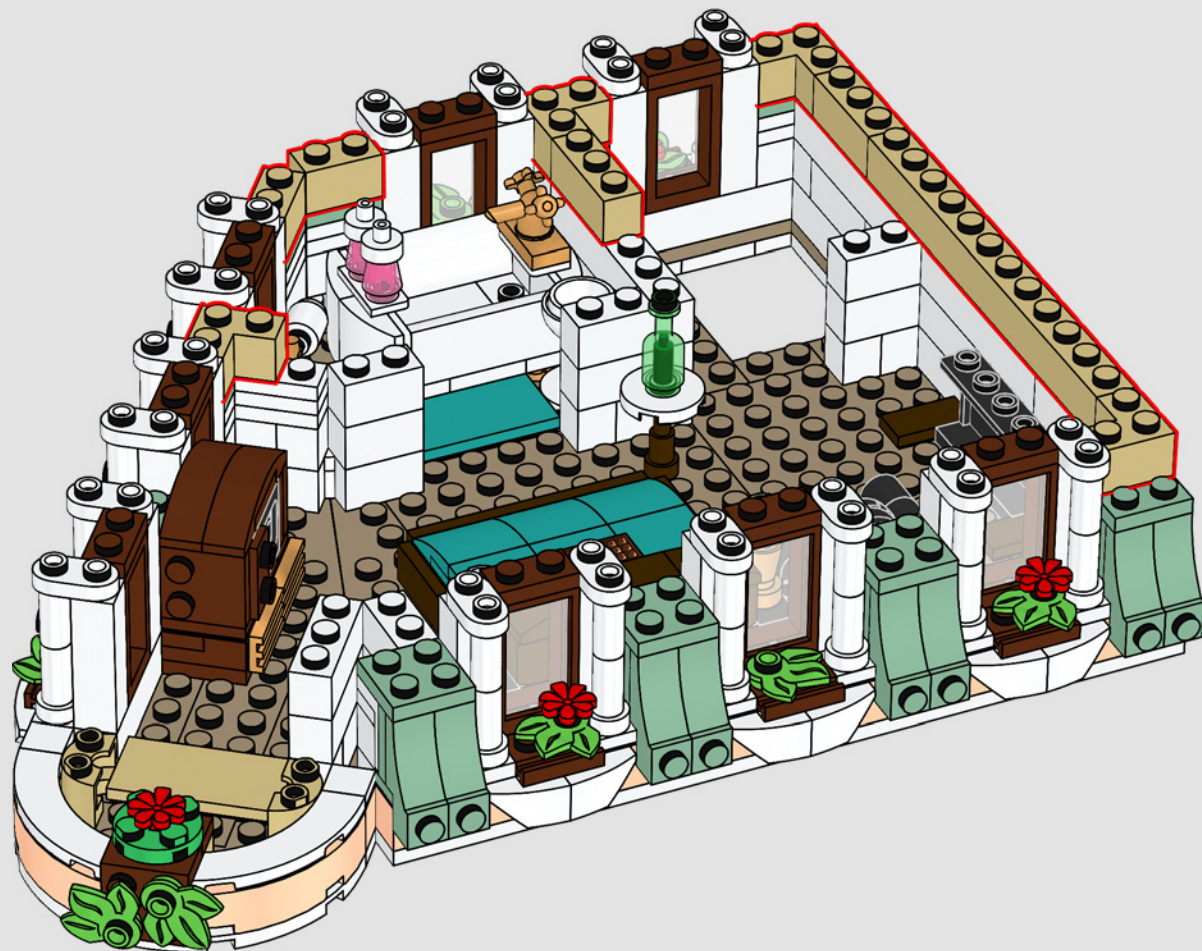

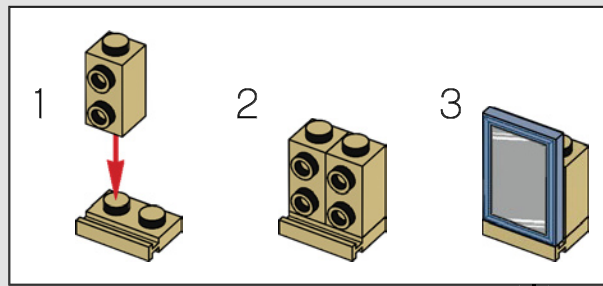
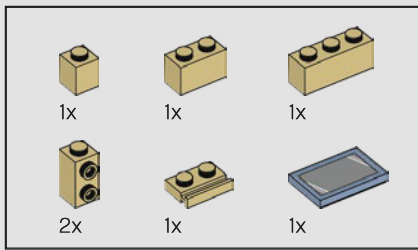

363

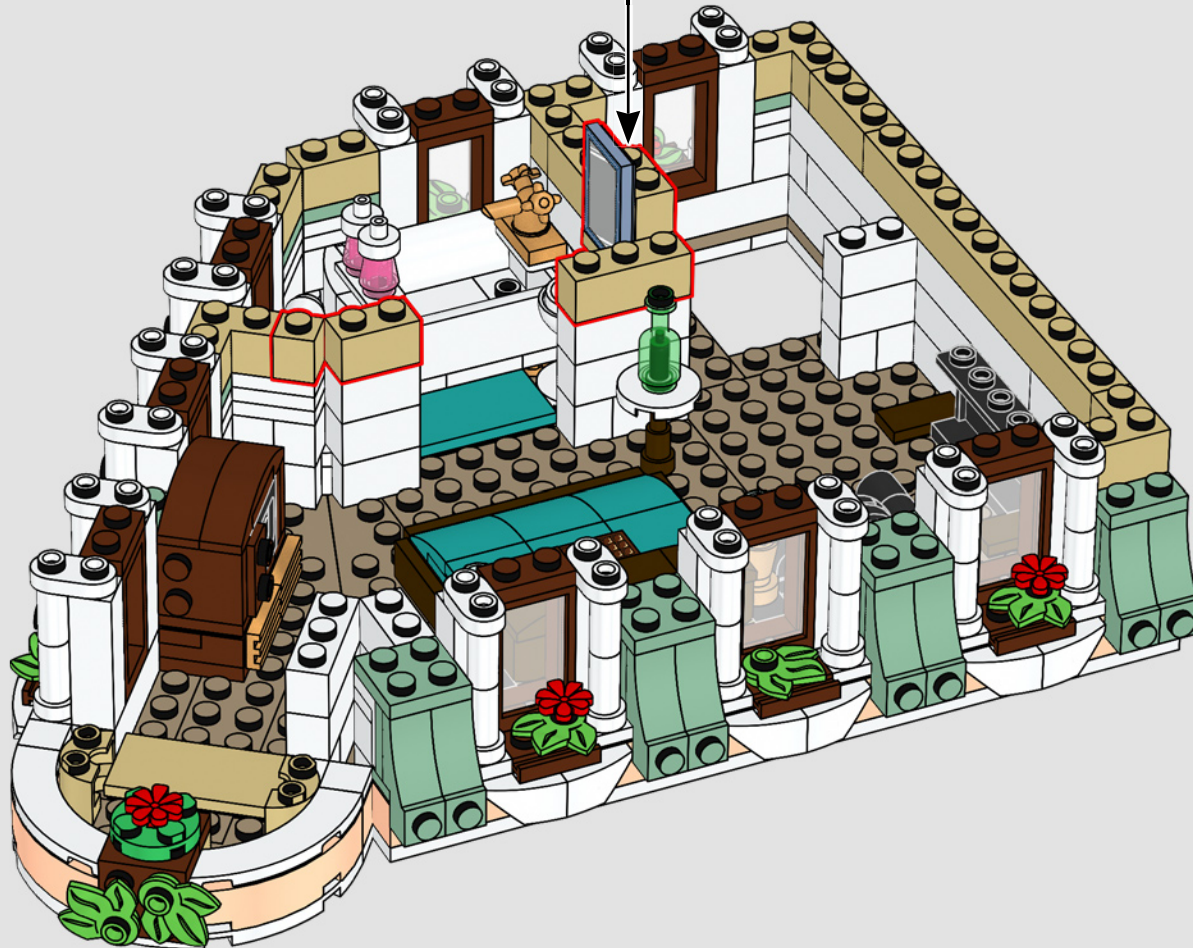



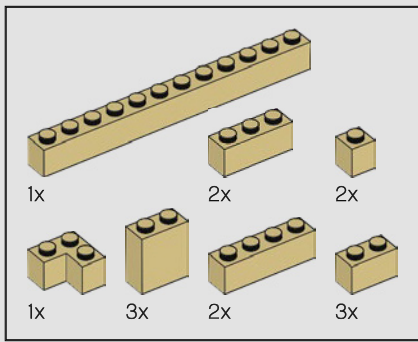

364



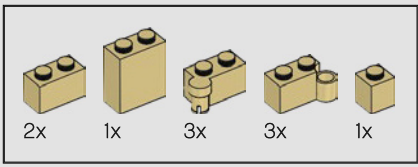

365

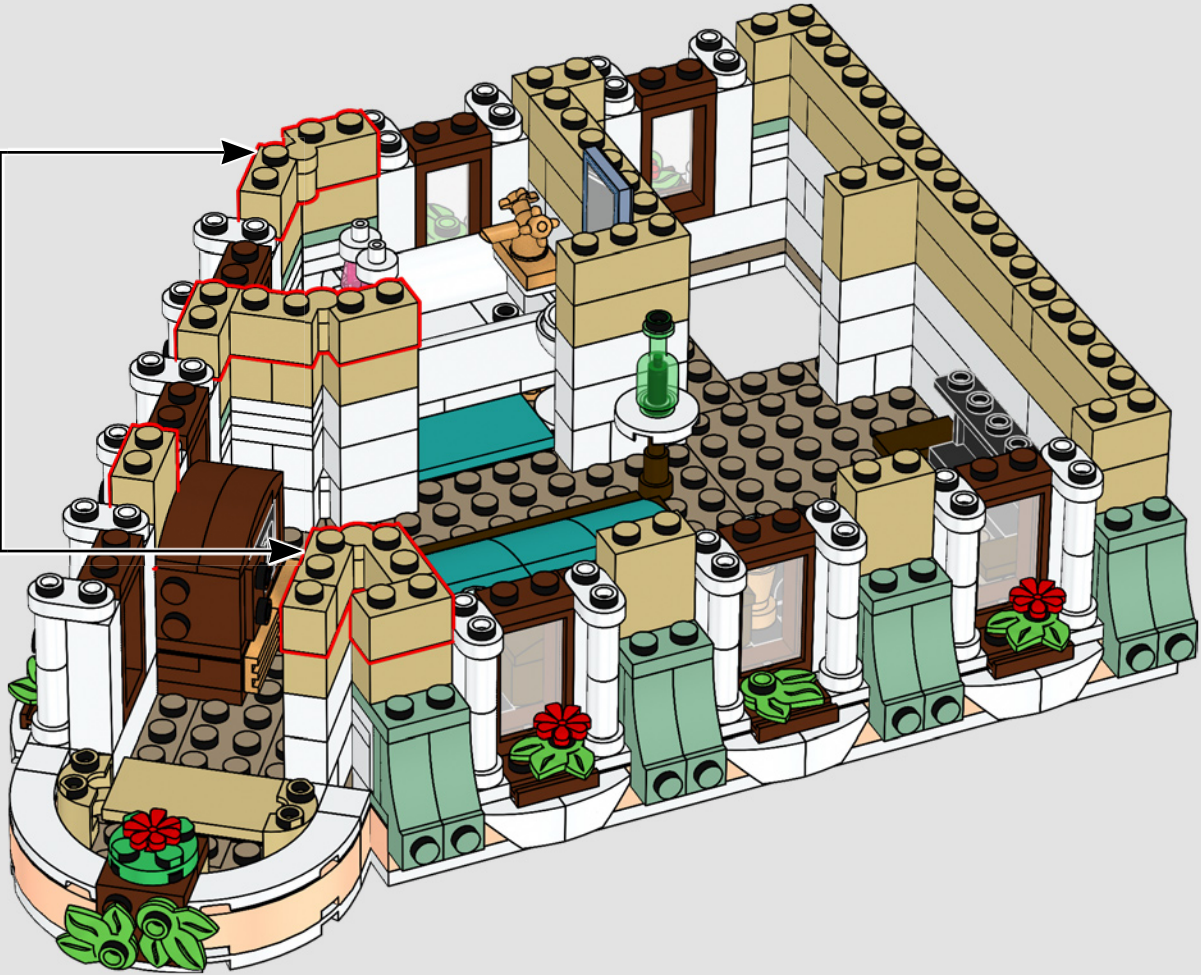
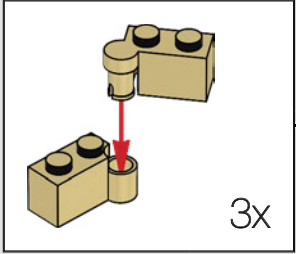

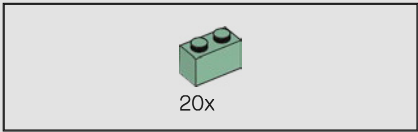

366

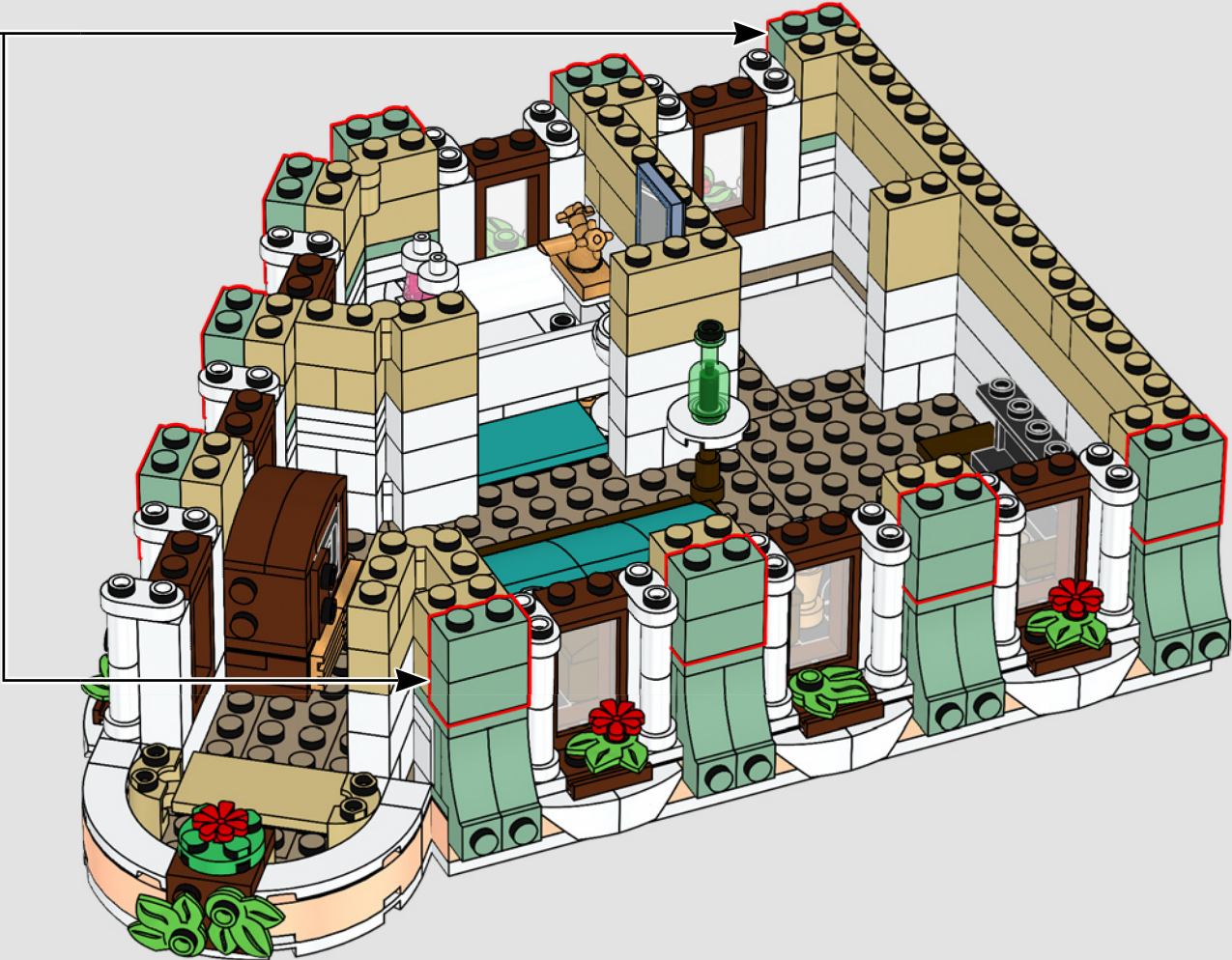
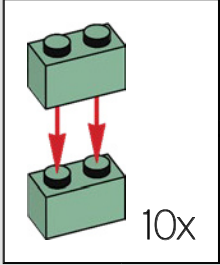

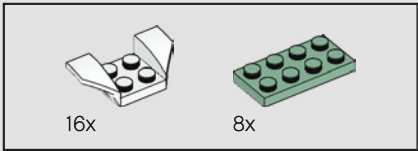

367

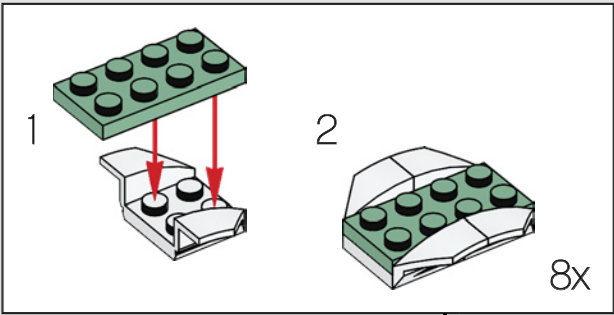

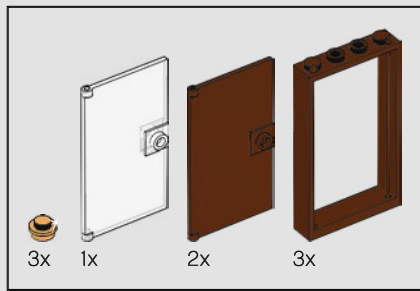

368

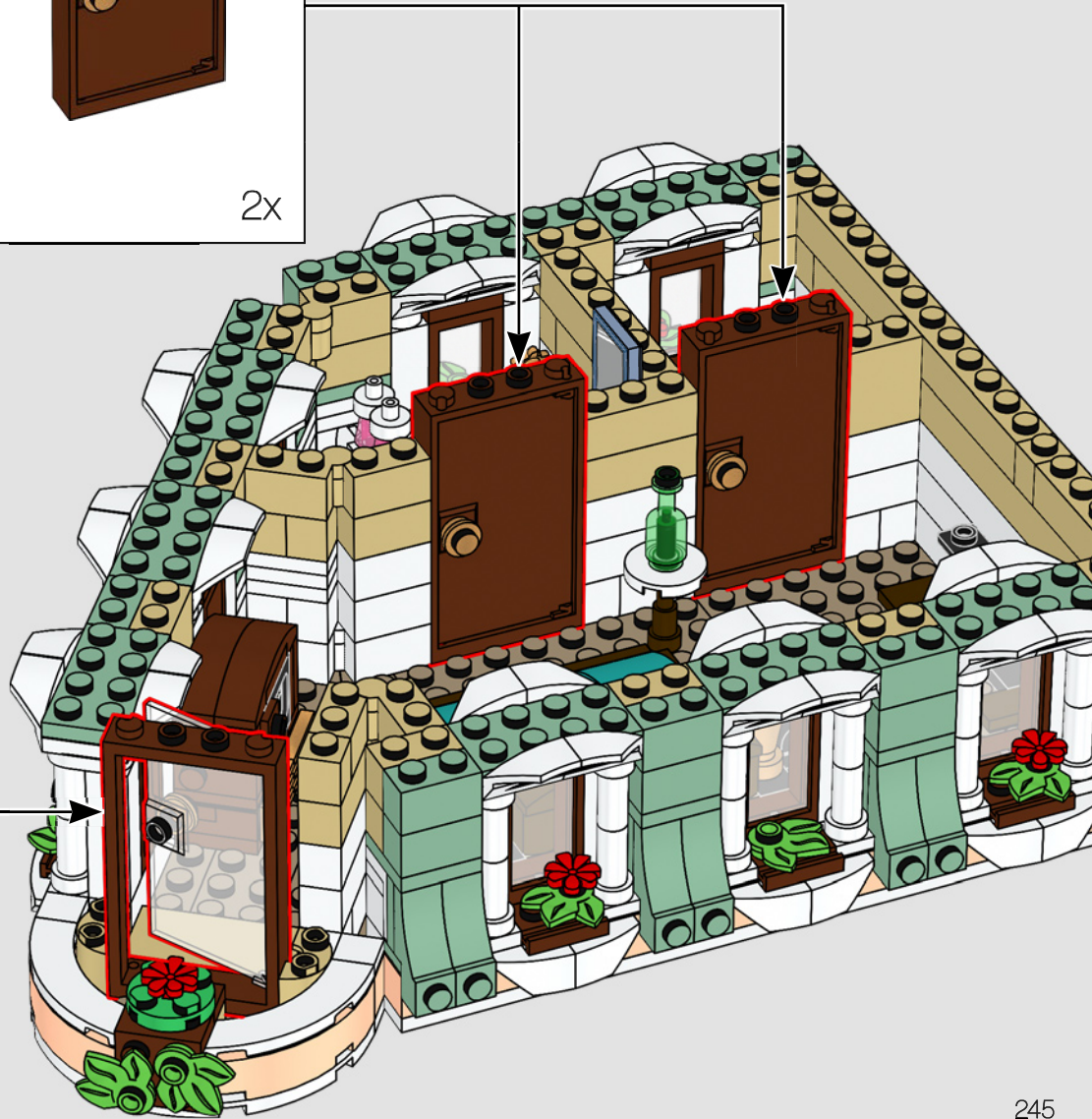
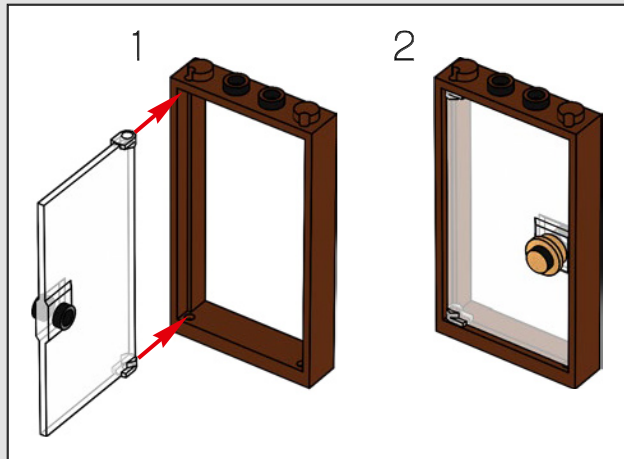
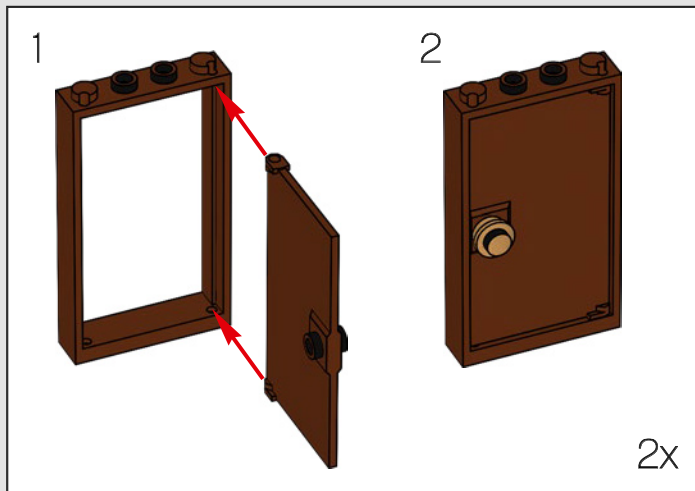

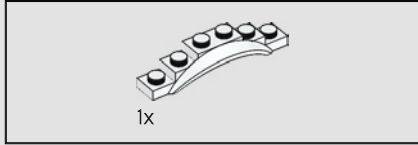
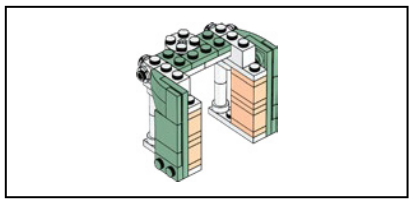

369

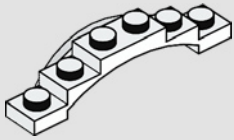

370

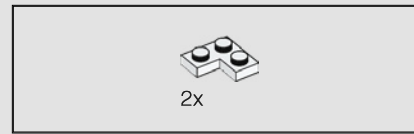
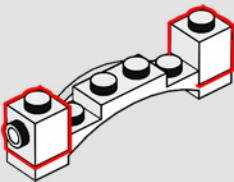

371

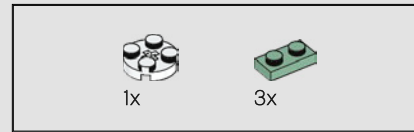
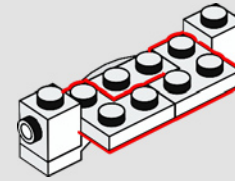

372

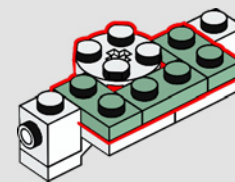



373

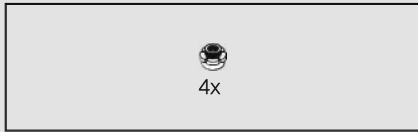
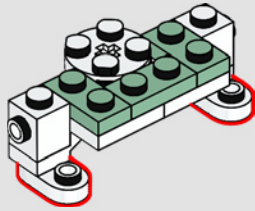

374

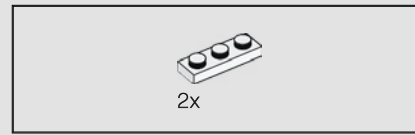
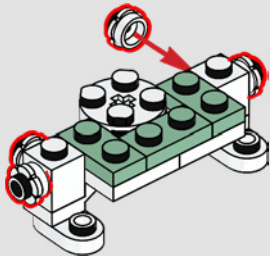

375

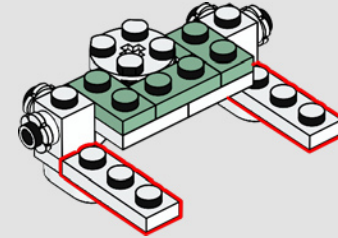

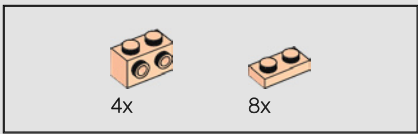

376

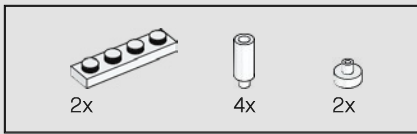
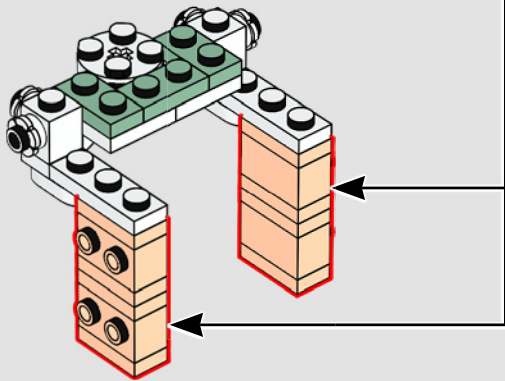
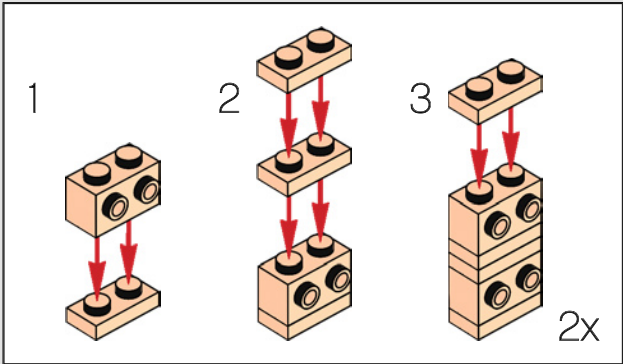

377

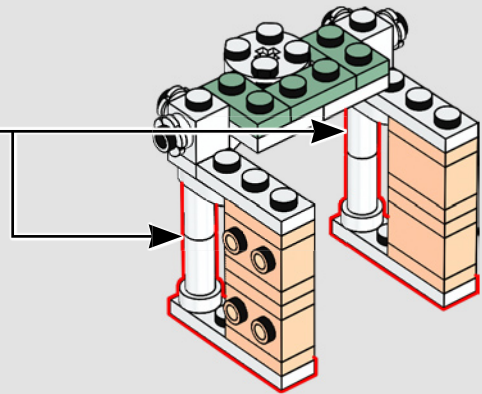
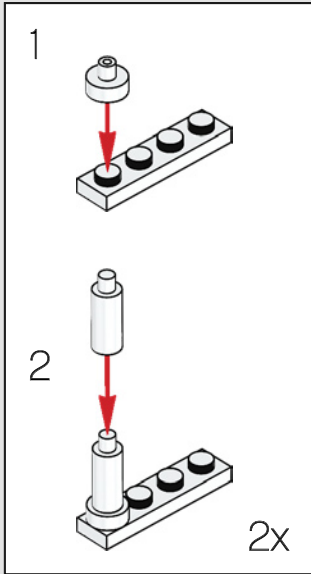



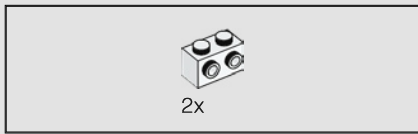

378

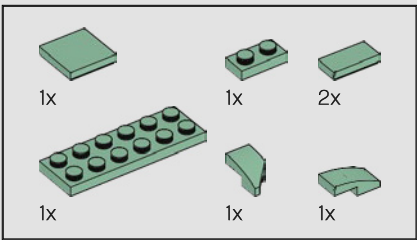
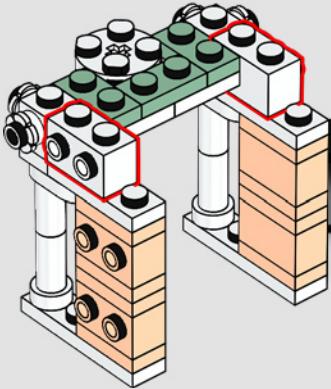

379

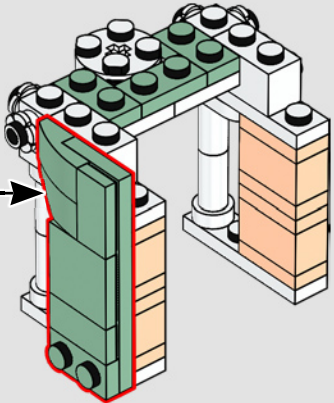
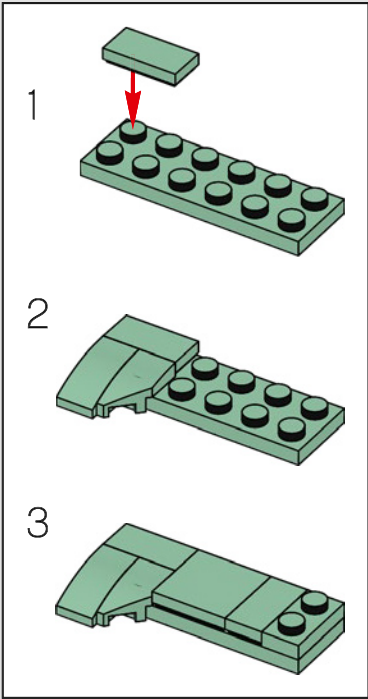

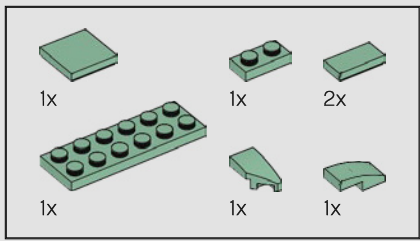

380

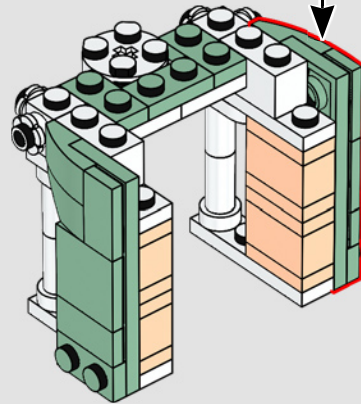
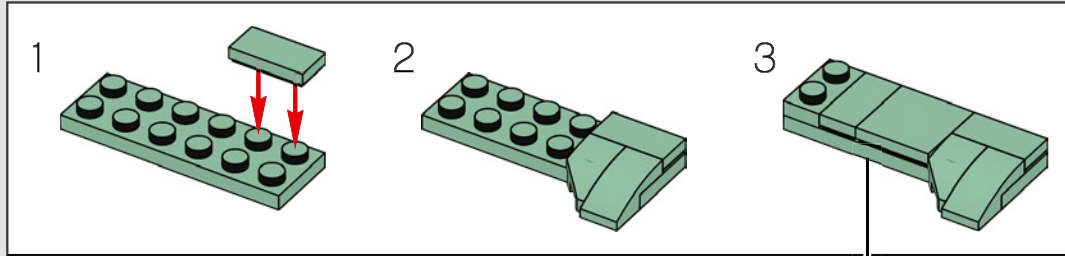

381



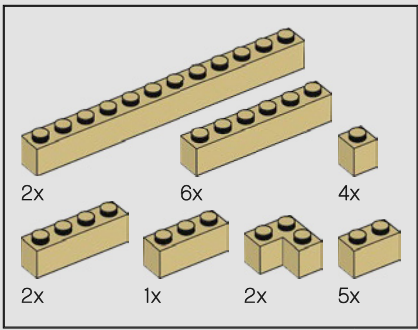

382

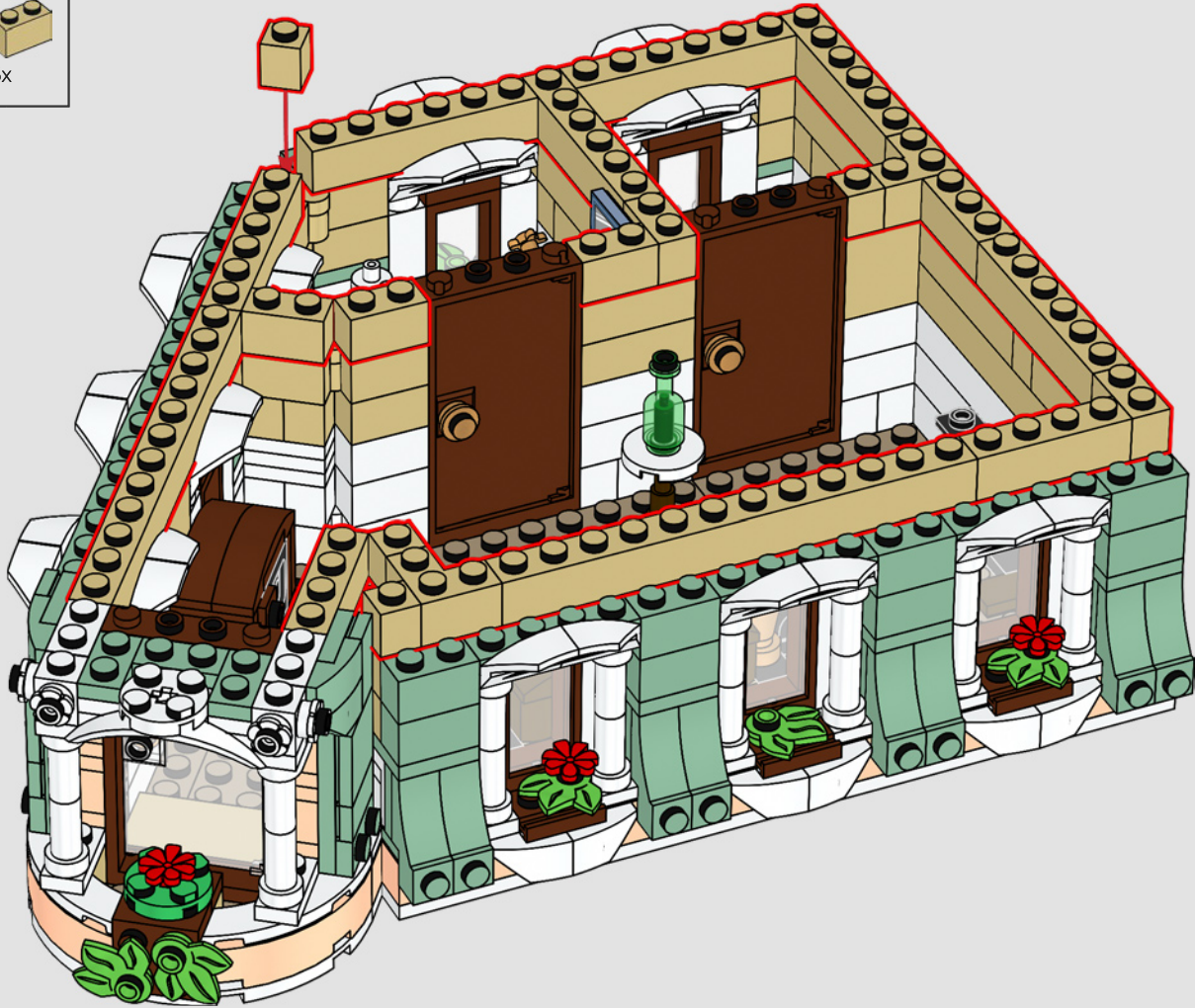

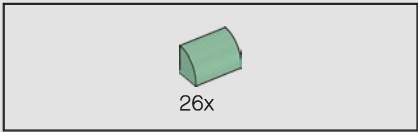

383



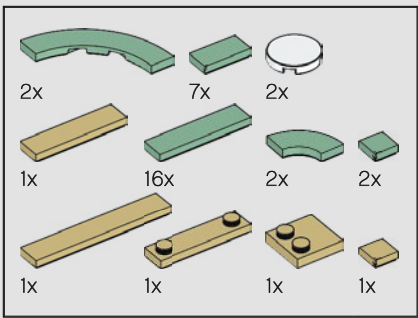

384

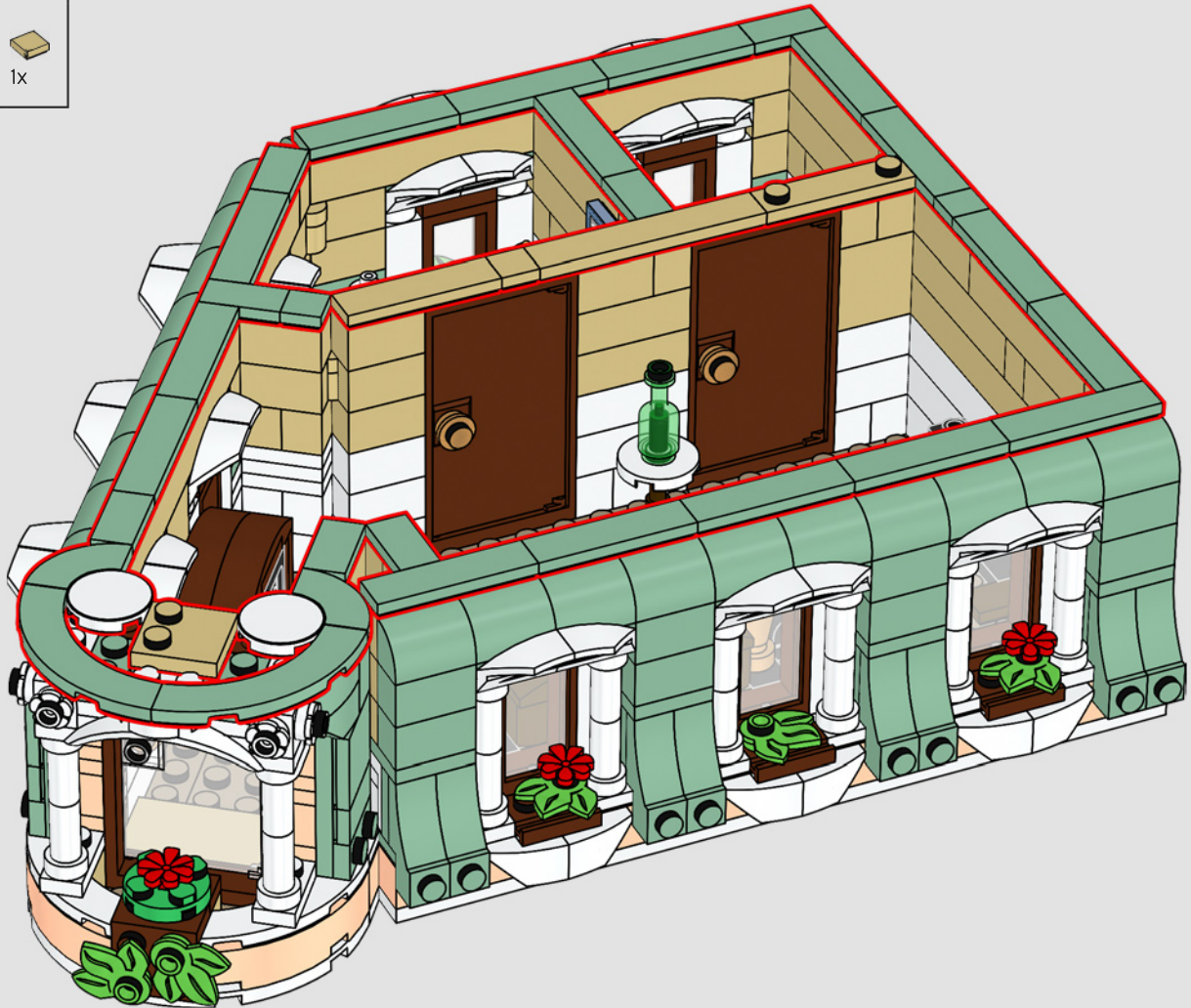

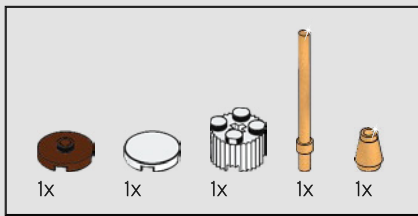

385

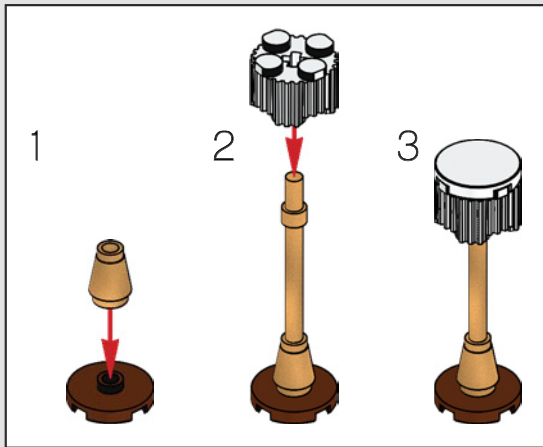

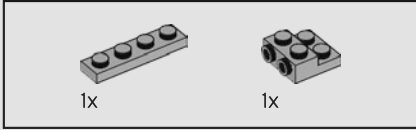
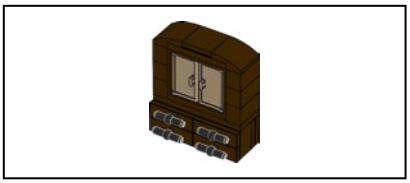

386

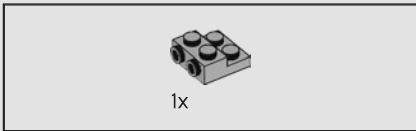
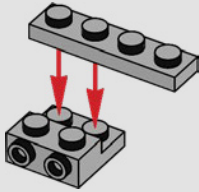

387

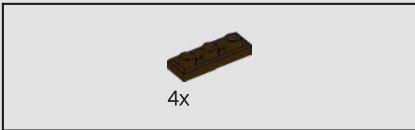
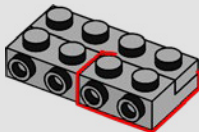

388

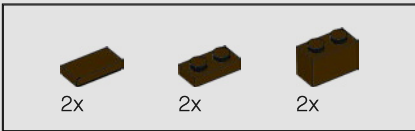
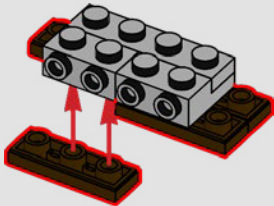

389

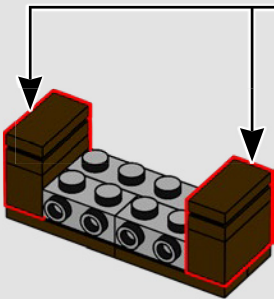
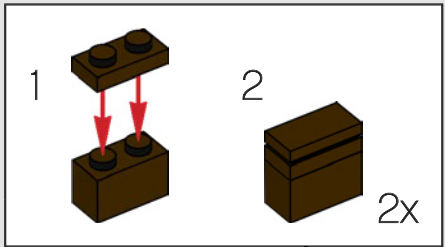



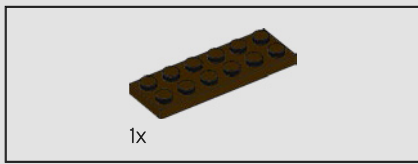

390

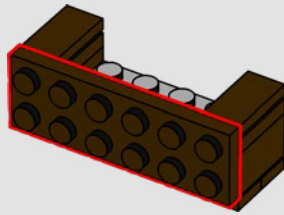

391

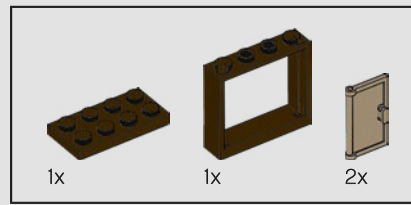
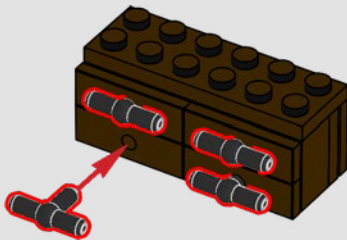

392

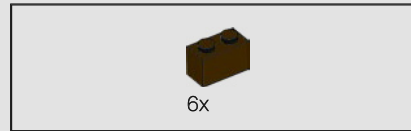
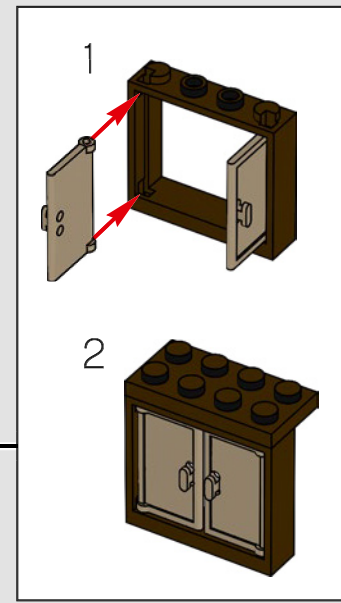
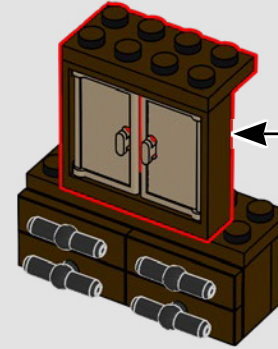

393

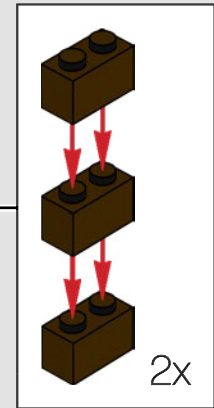
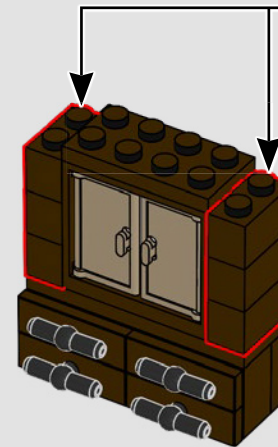

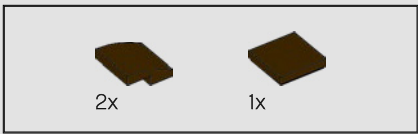

394

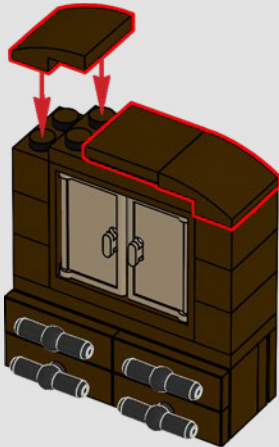

395



396

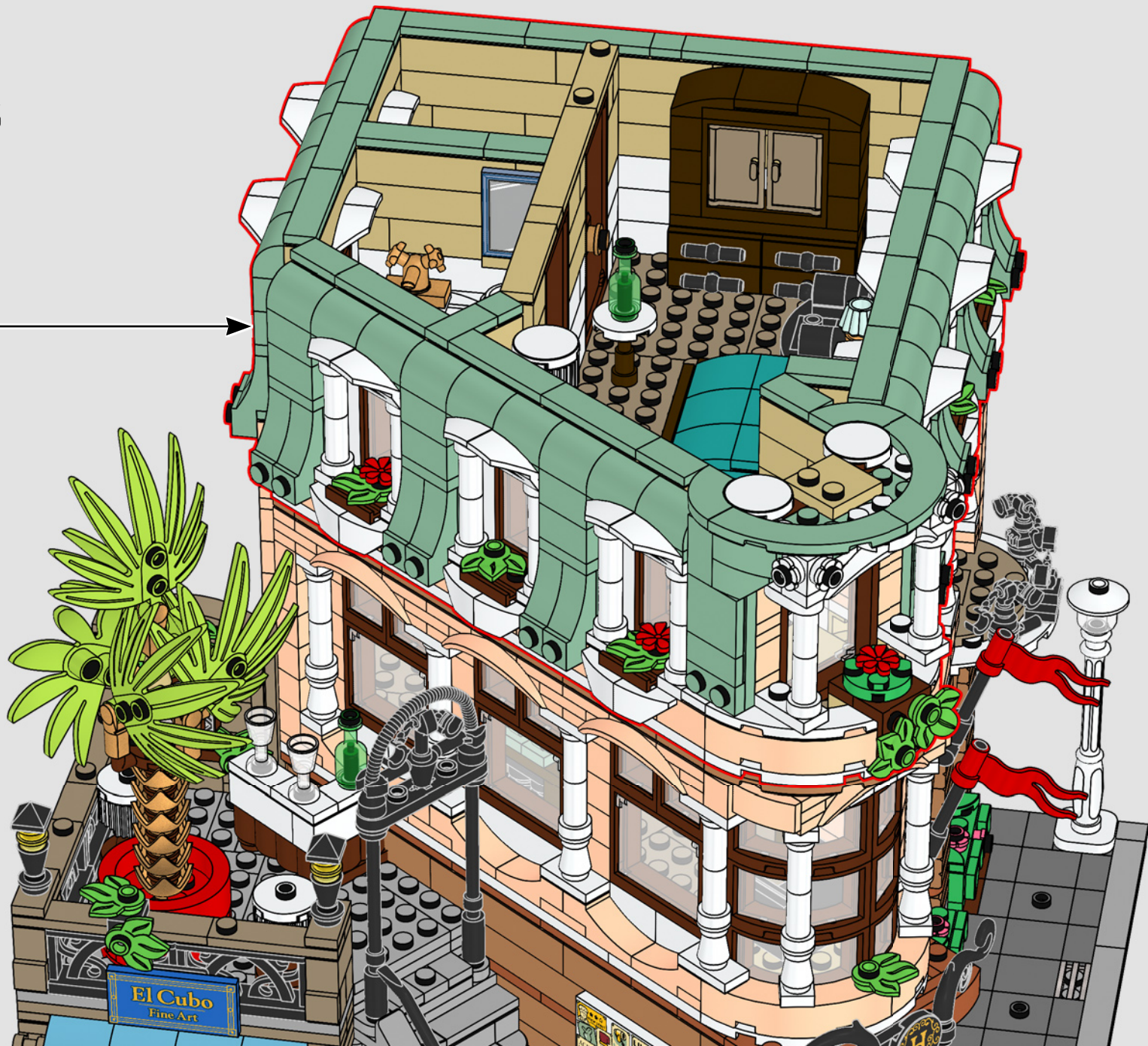

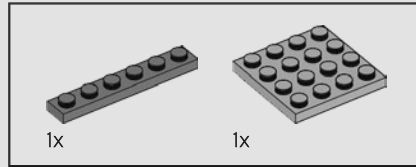
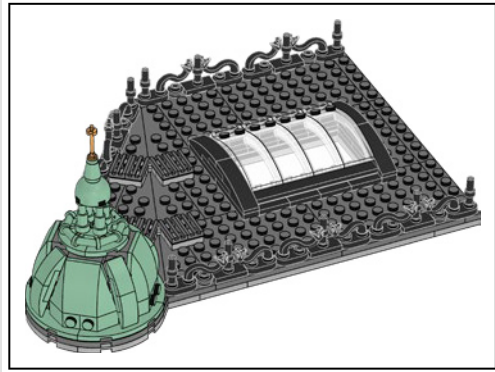
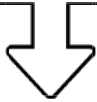

397

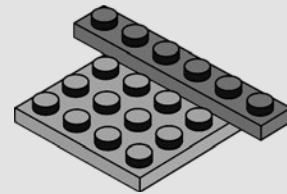

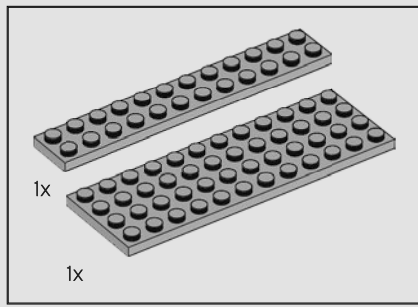

398

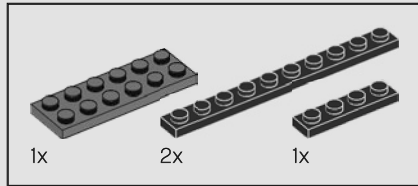
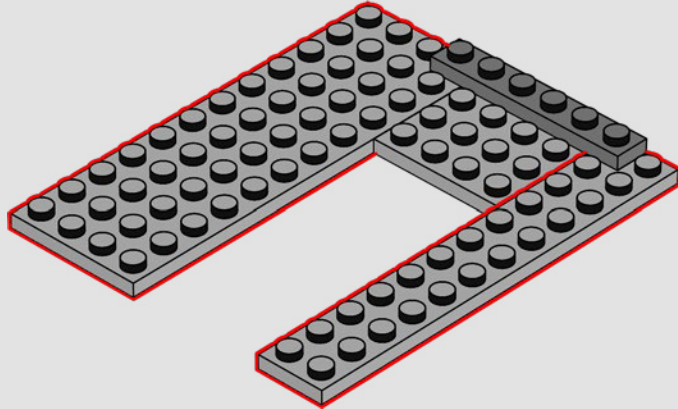

399

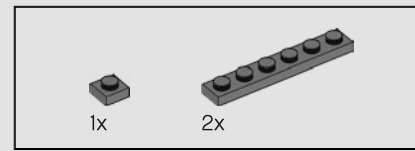
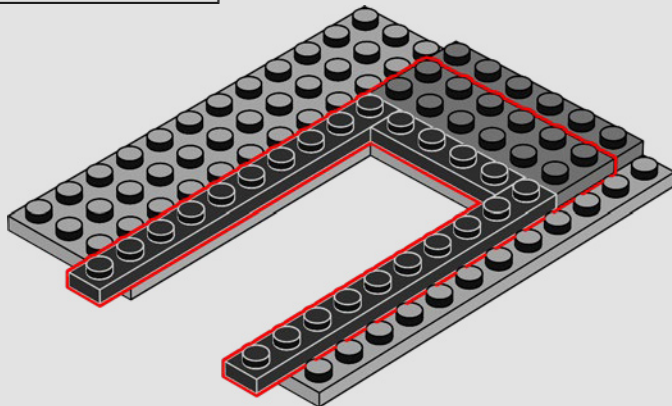

400

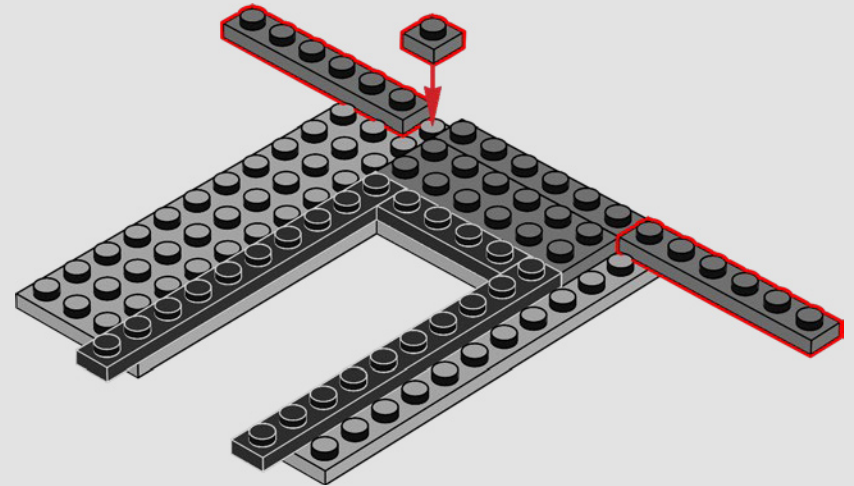

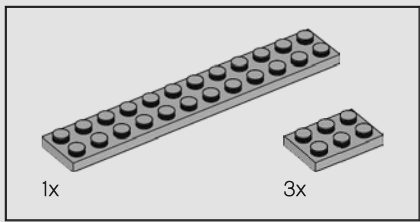

401

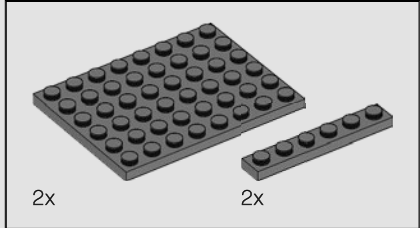
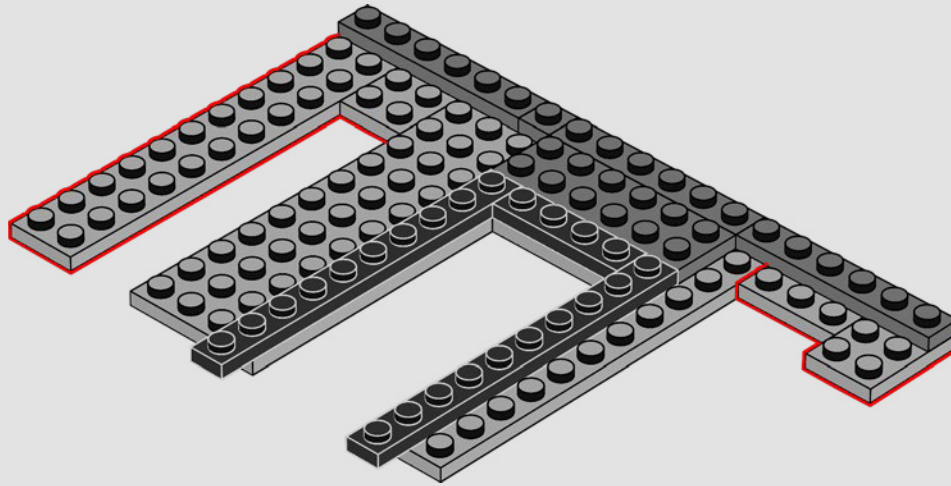

402

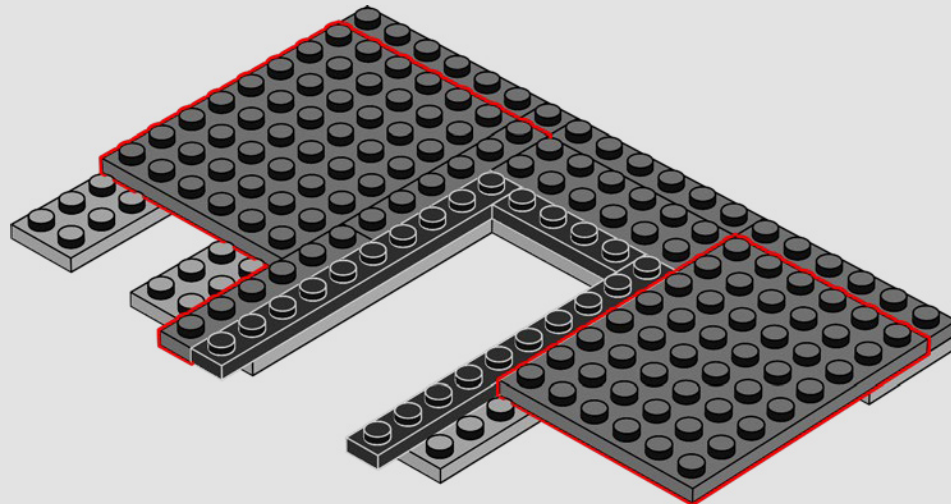

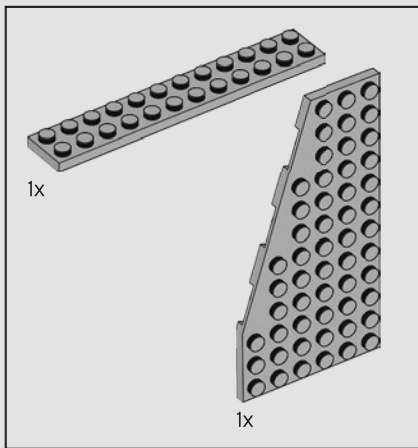

403

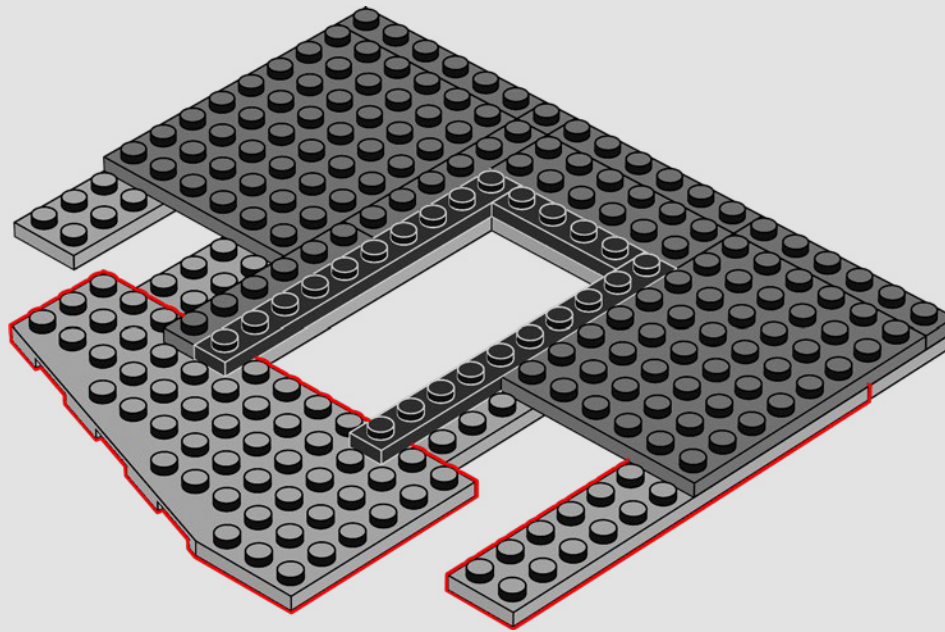

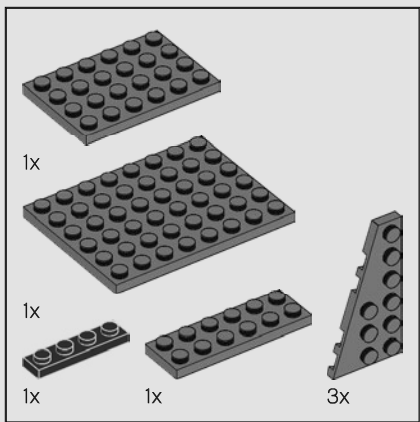

404

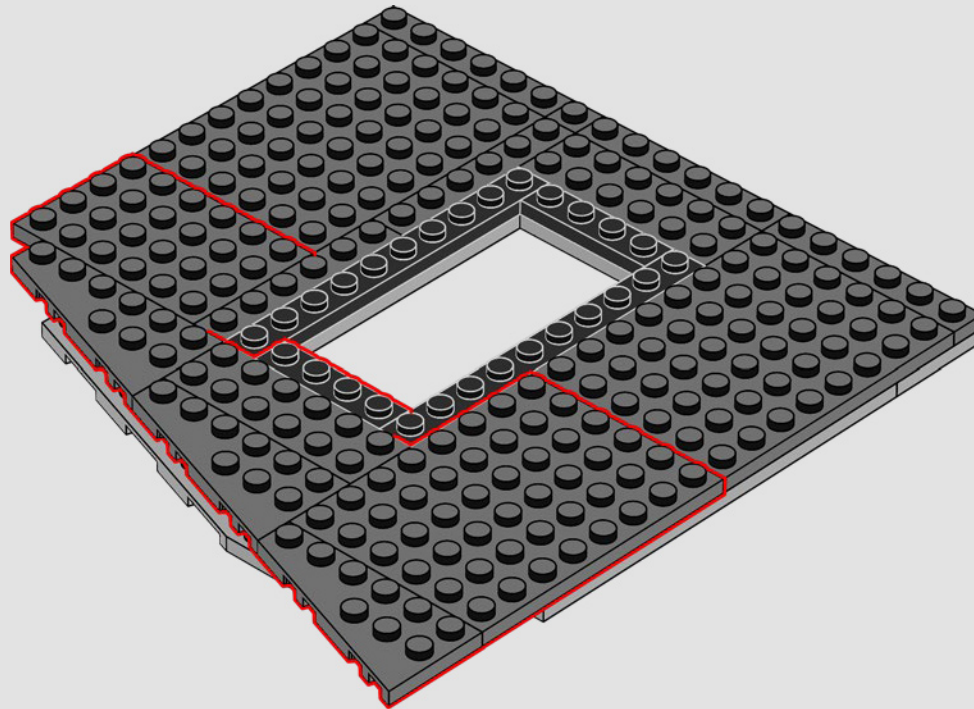



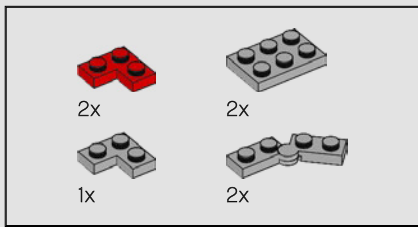

405

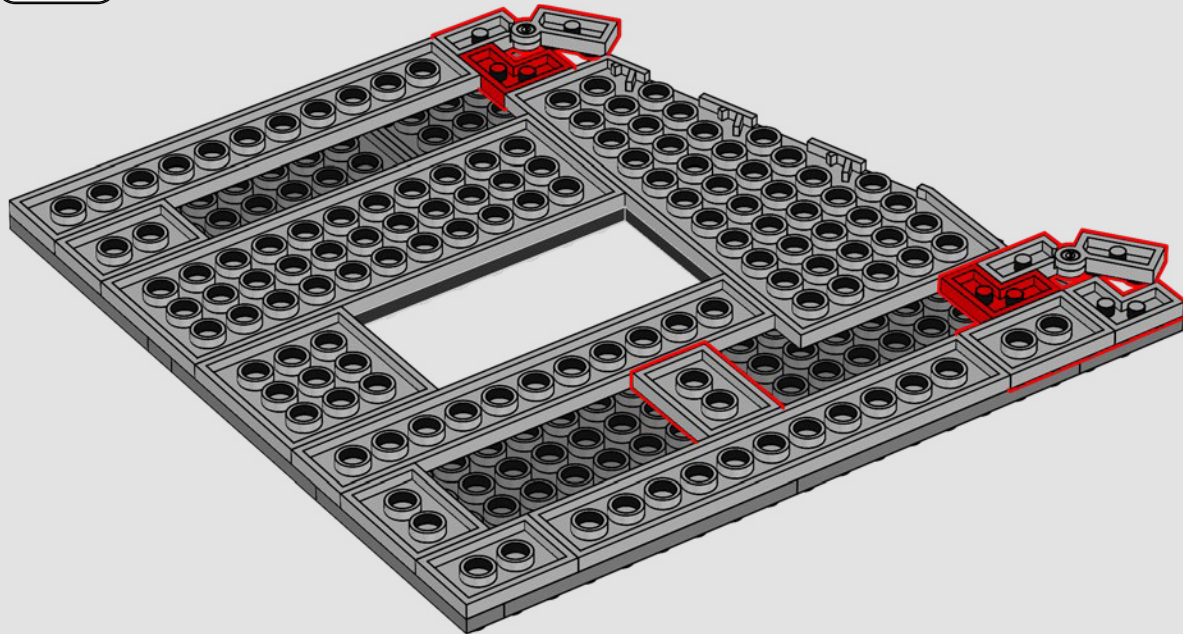



1x

406

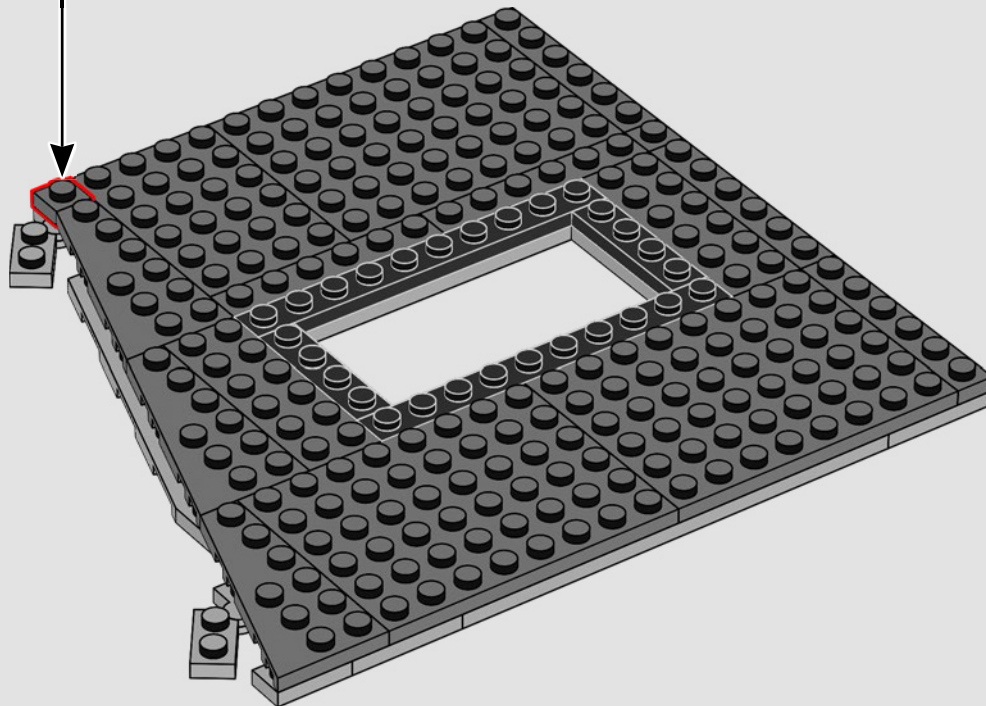
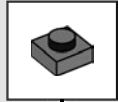

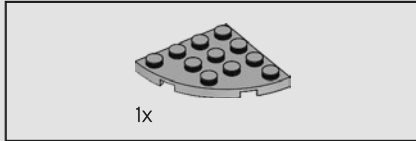
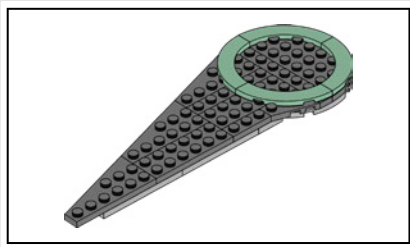

407

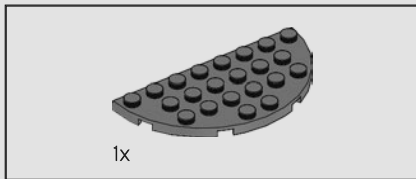
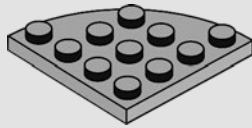

408

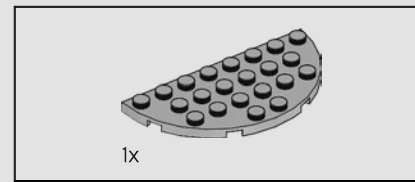
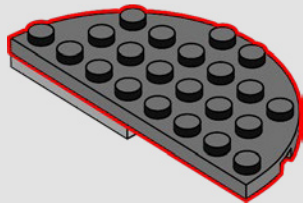

409

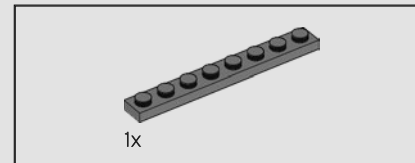
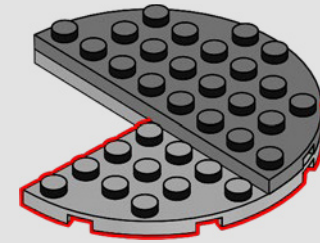

410

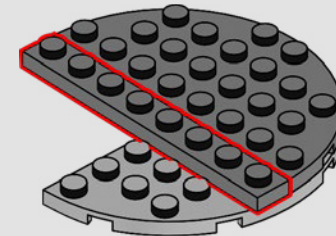

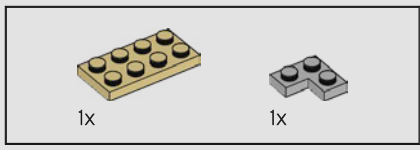

411

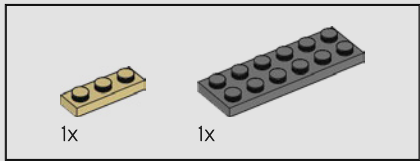
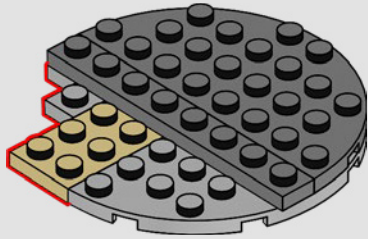

412

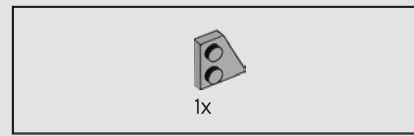
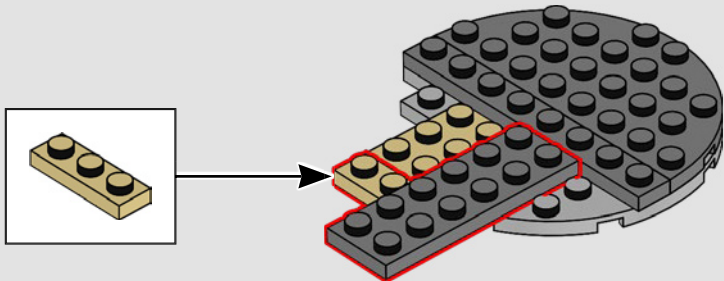

413

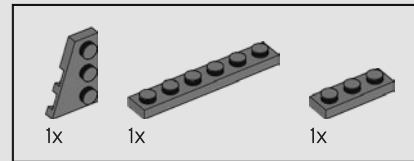
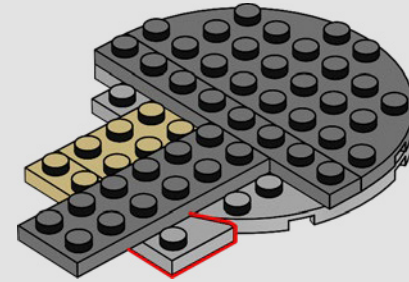

414

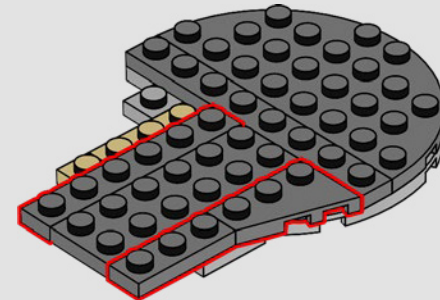

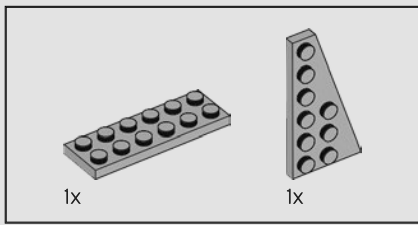

415

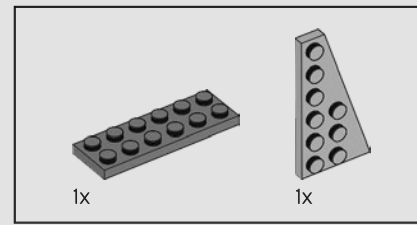
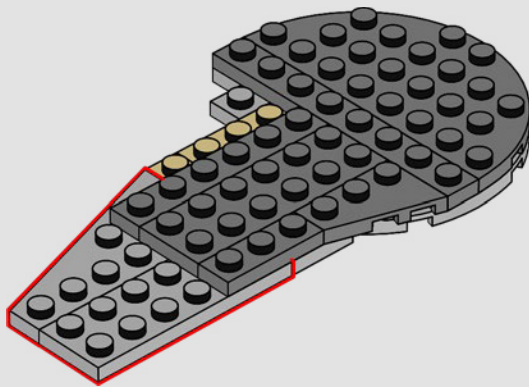

416

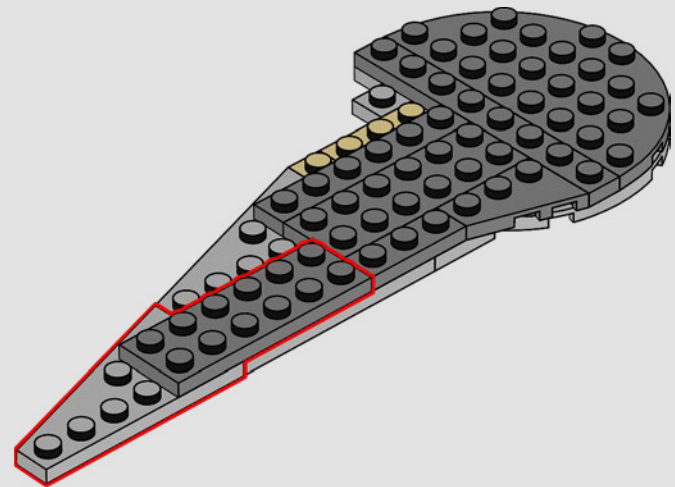

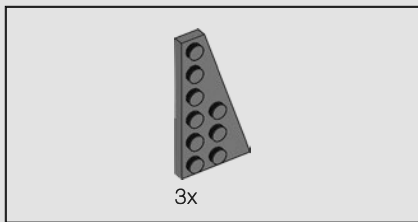

417

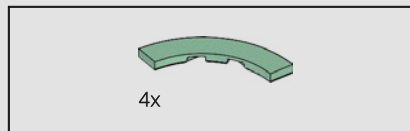
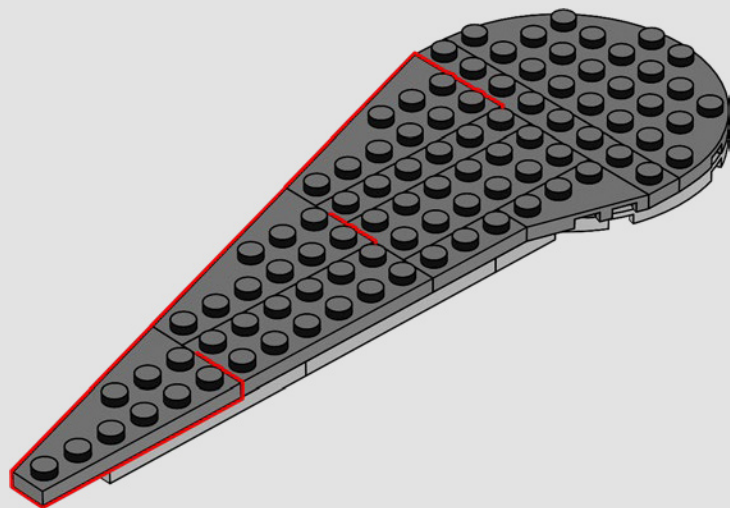

418

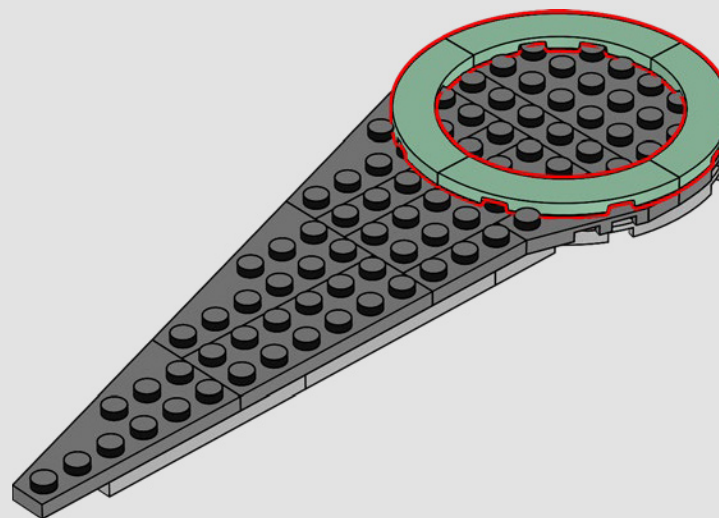

419

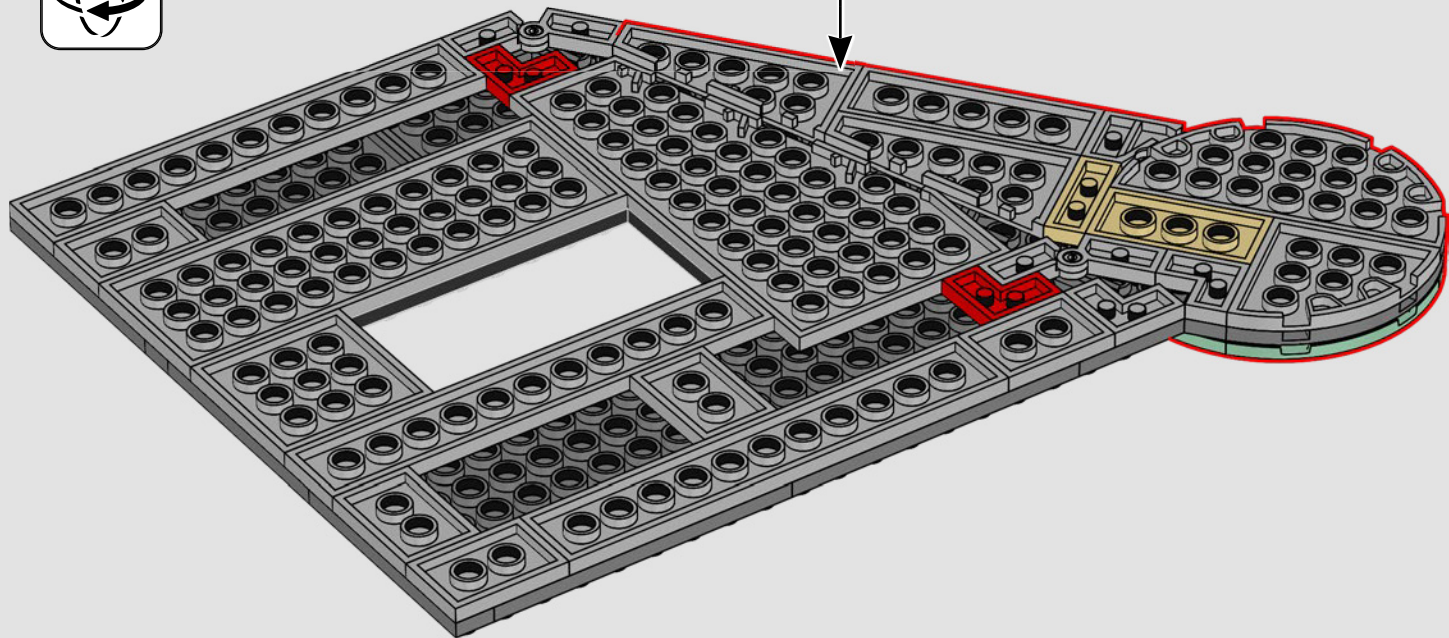



420

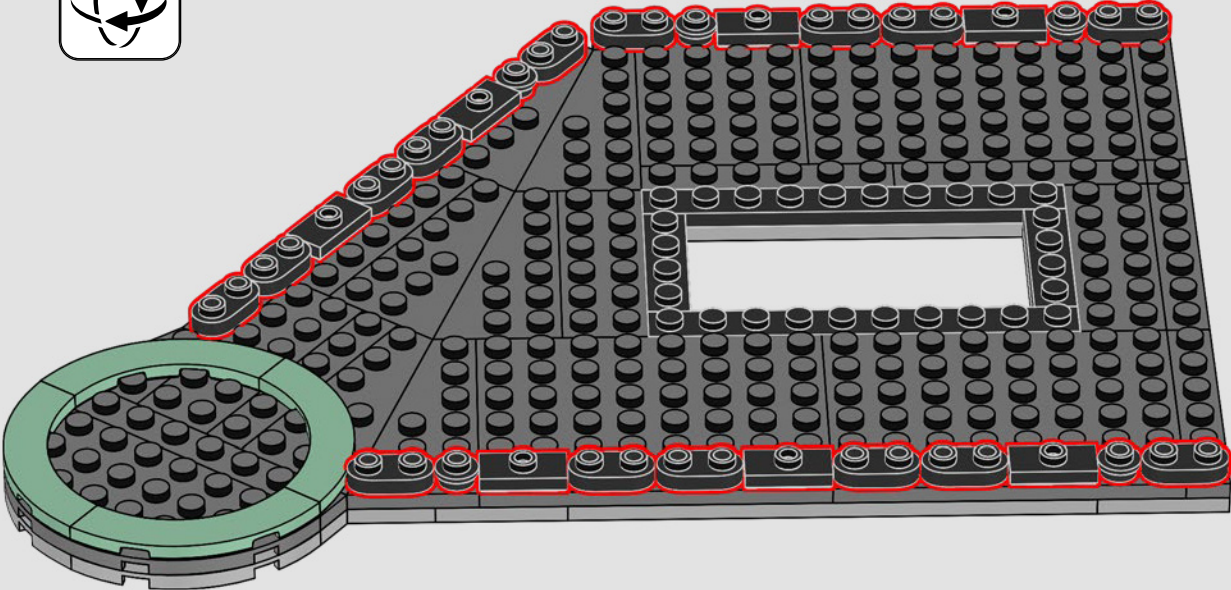



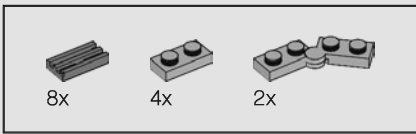

421

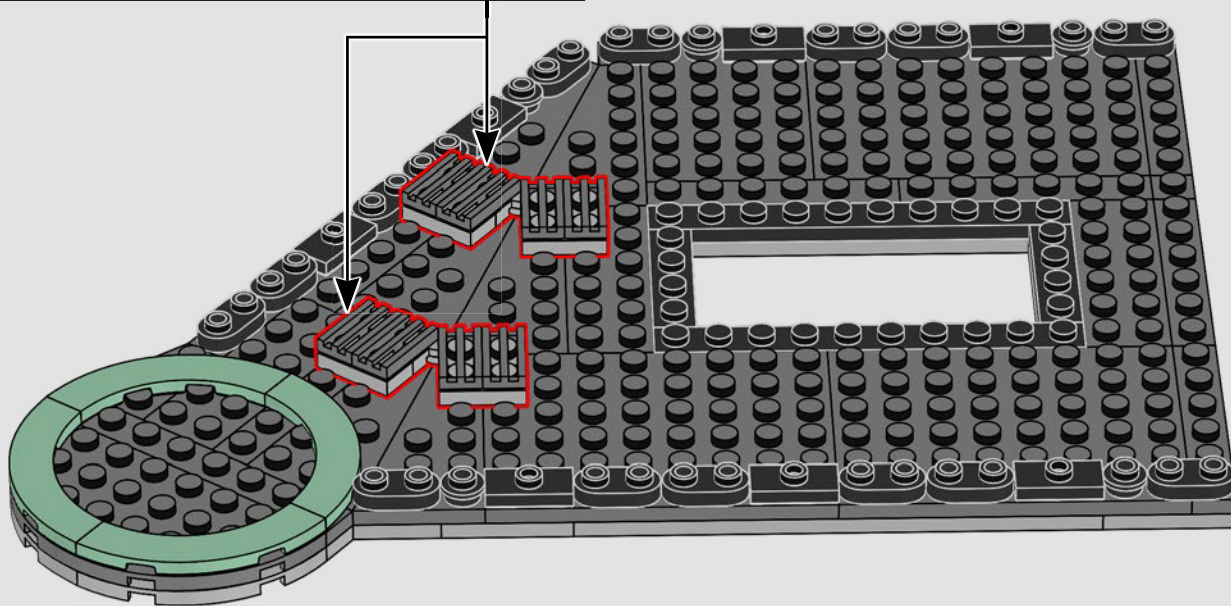
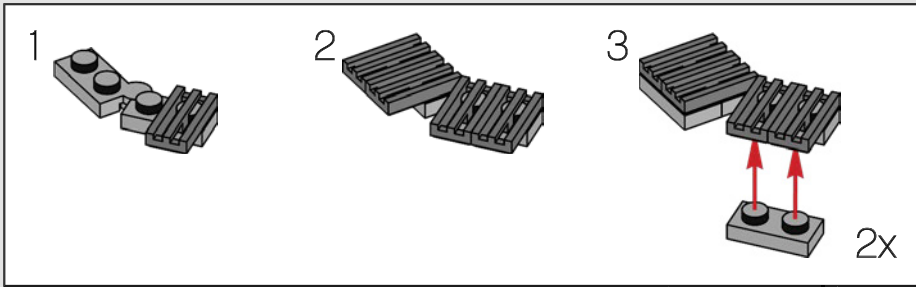



12x

422

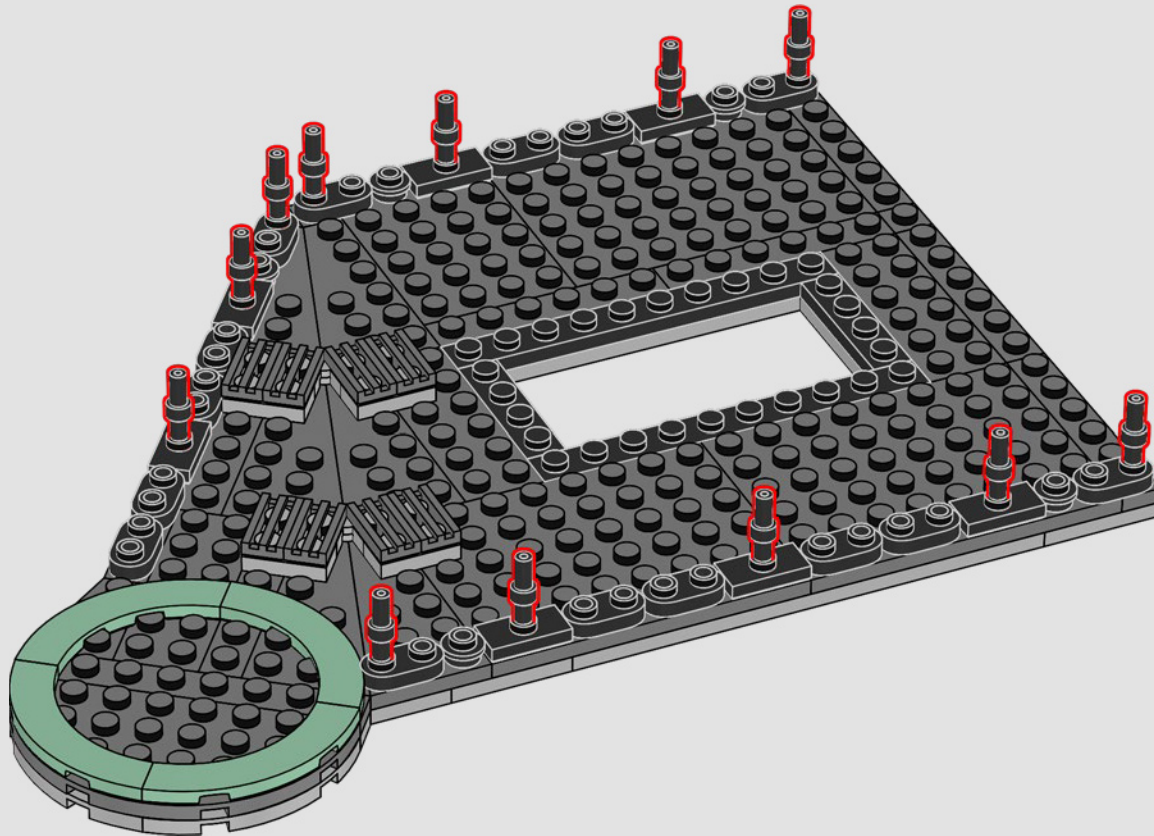



423



The elements used to make the curves of this wrought-iron detailing first appeared in NINJAGO® sets as a Snake Head.

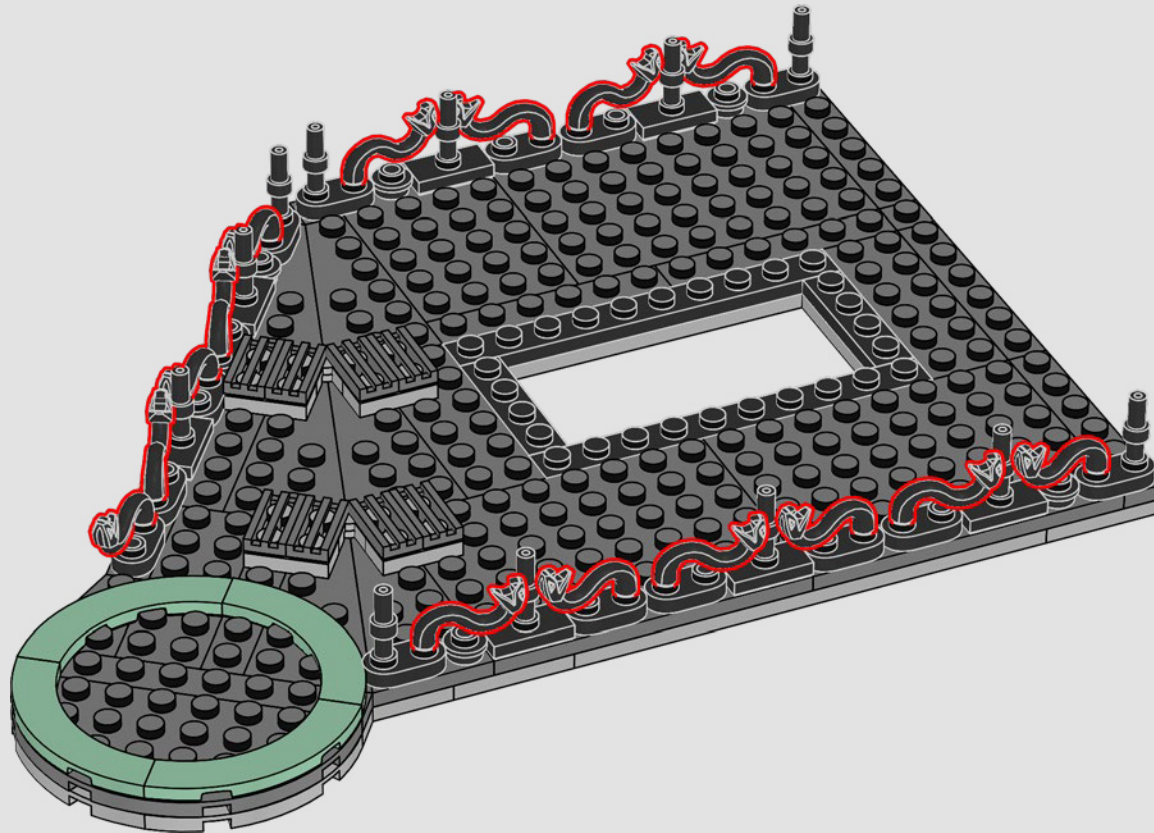

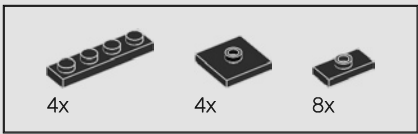

424

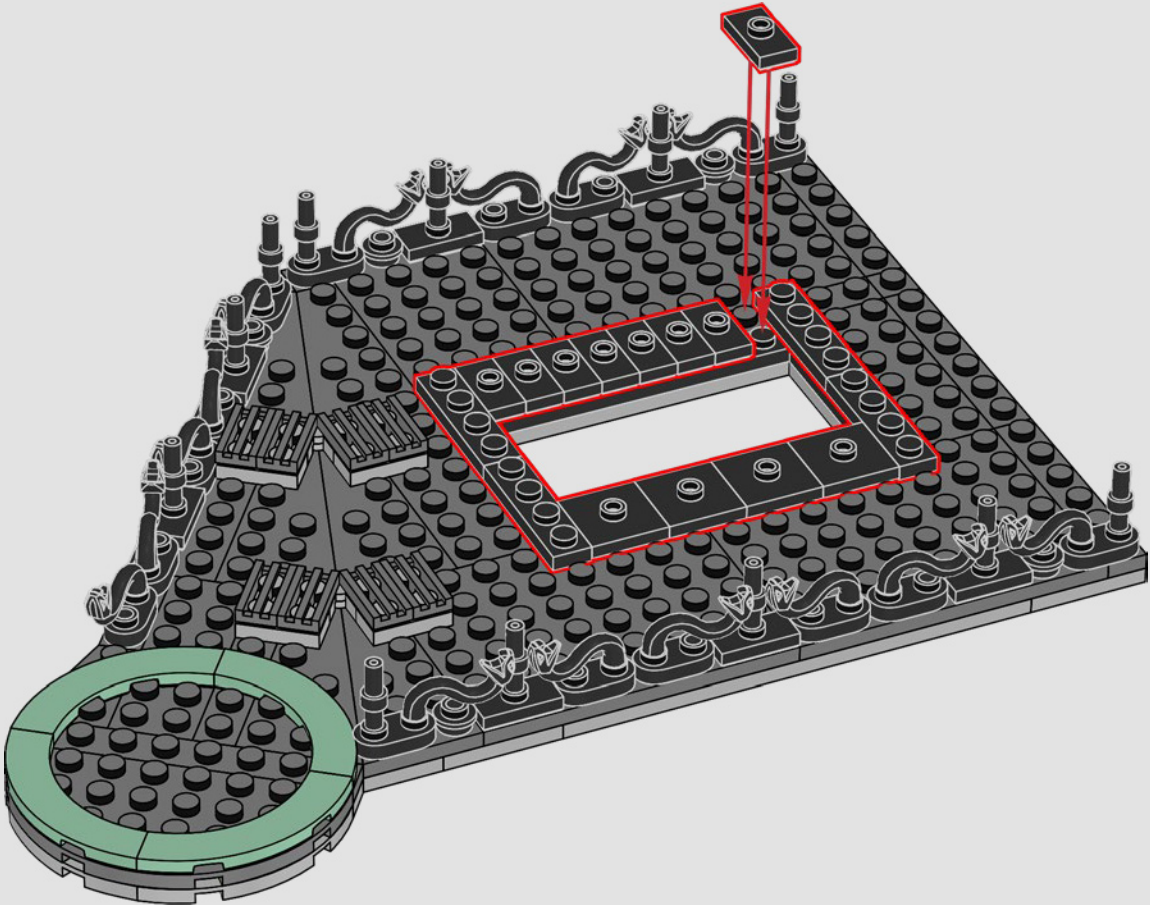

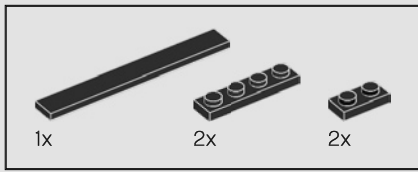

425

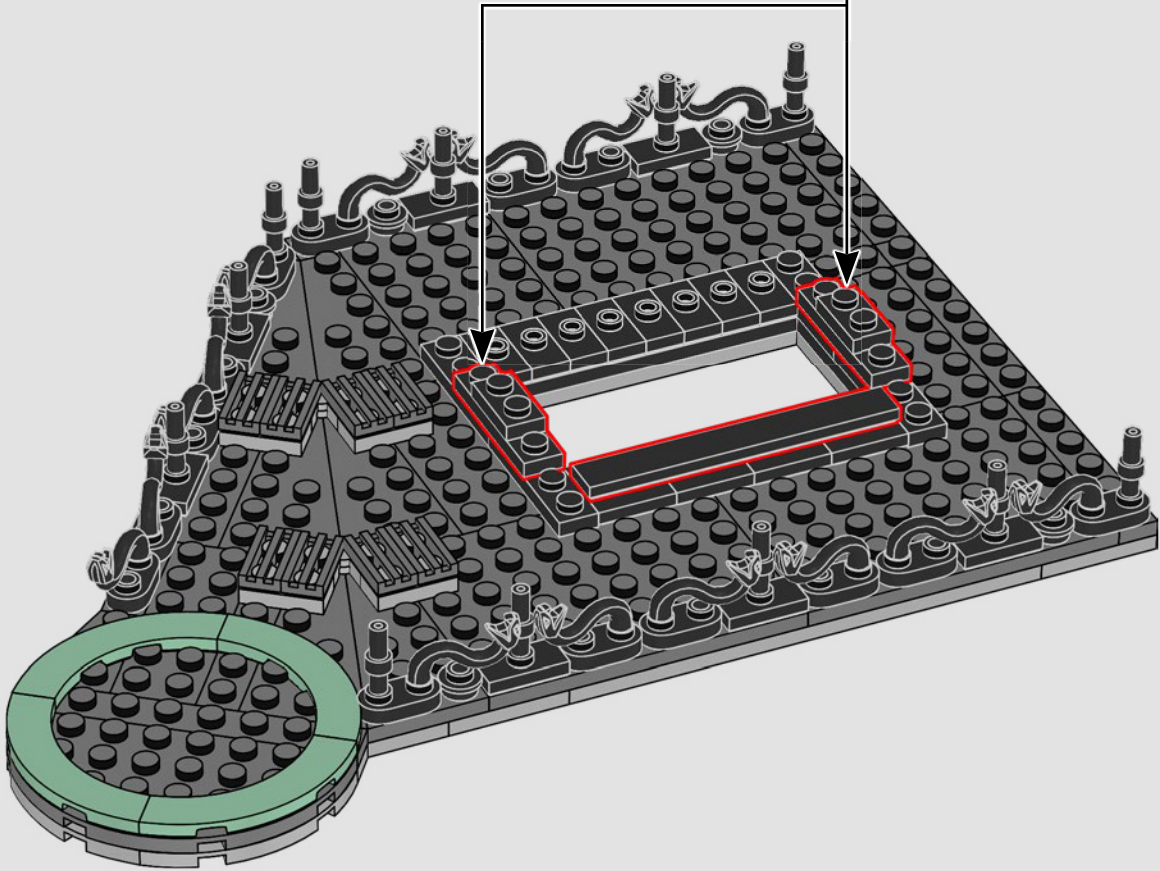
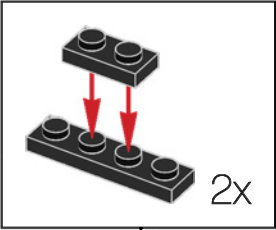



426

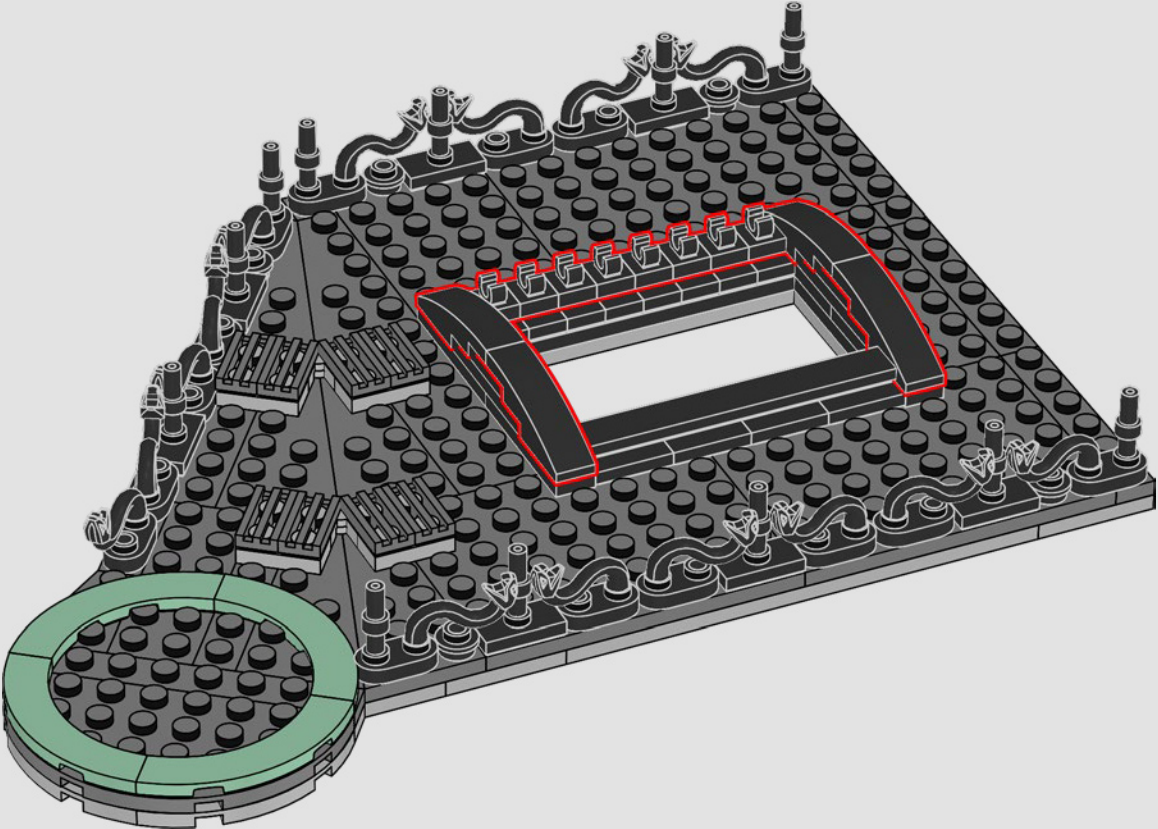

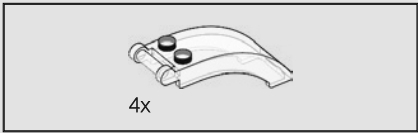

427

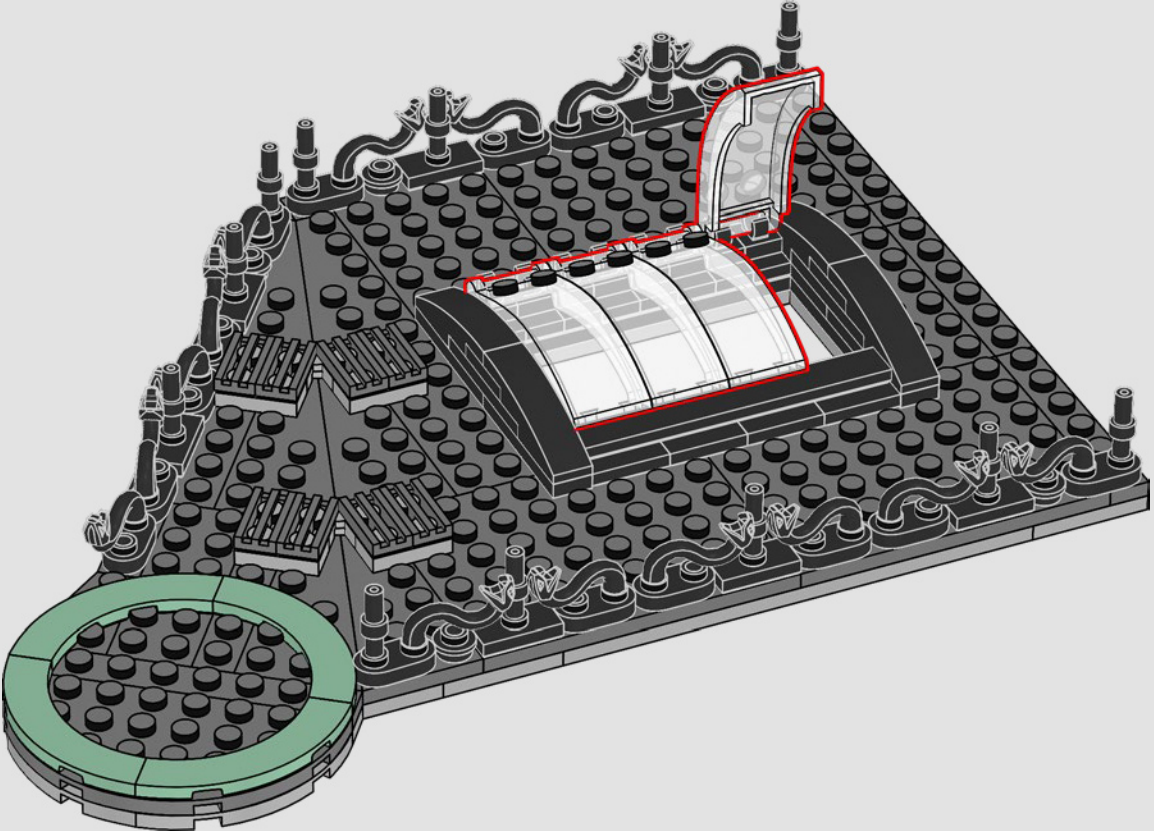

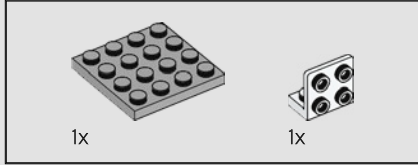
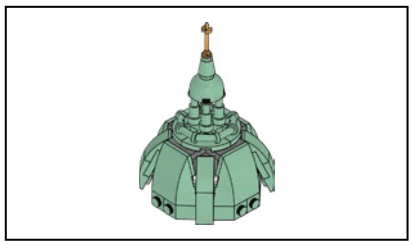

428

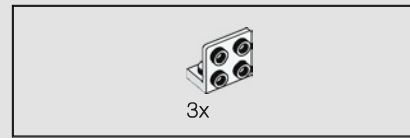
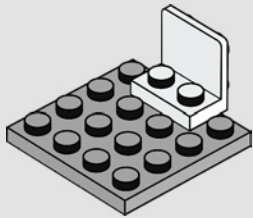

429

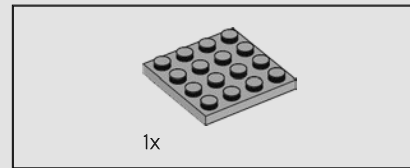
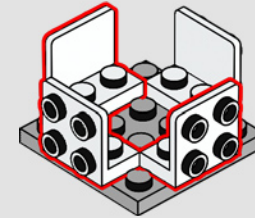

430

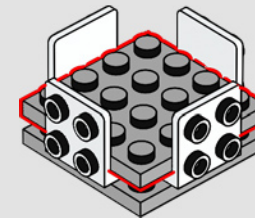



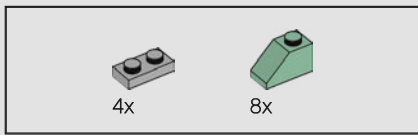

431

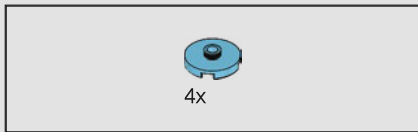
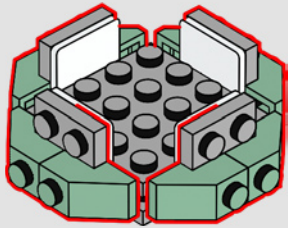

432

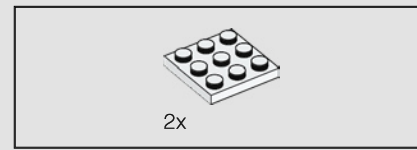
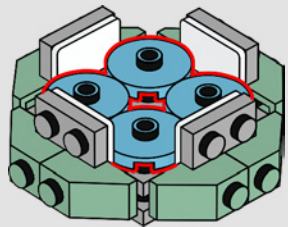

433

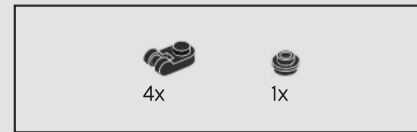
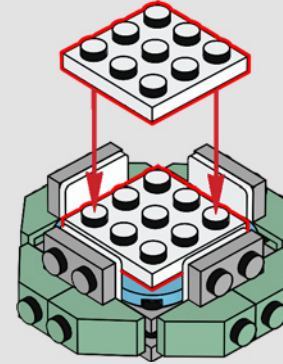

434

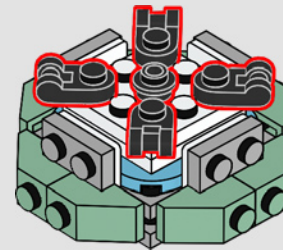

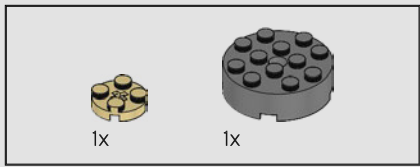

435

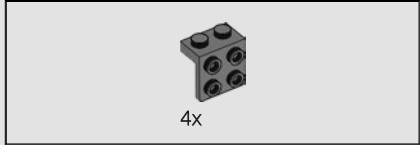
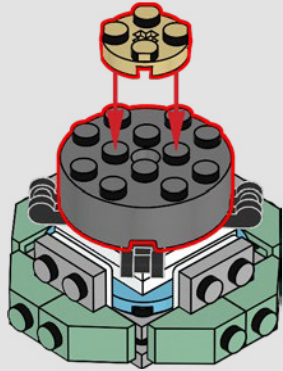

436

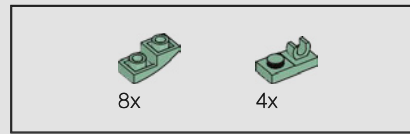
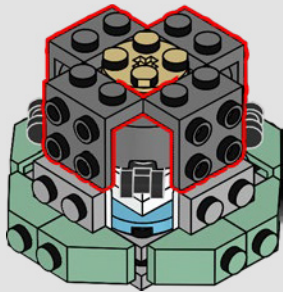

437

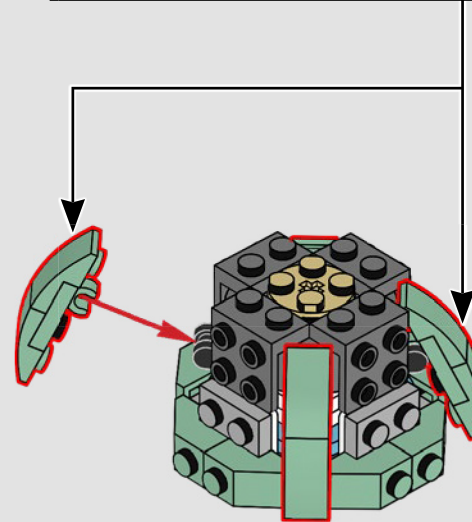
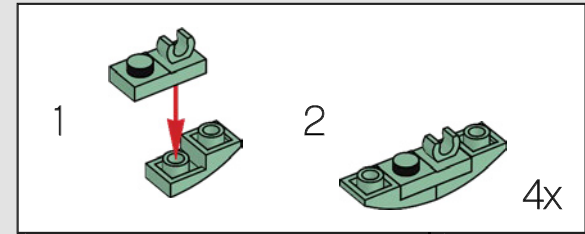

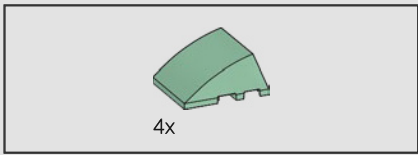

438

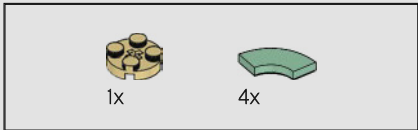
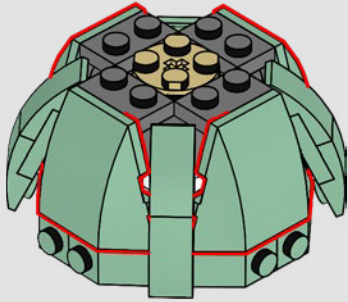

439

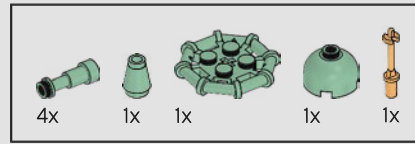
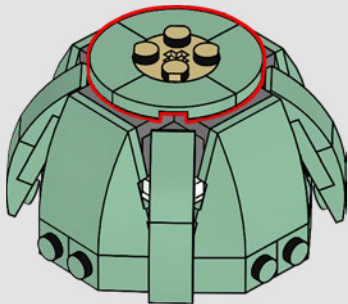

440

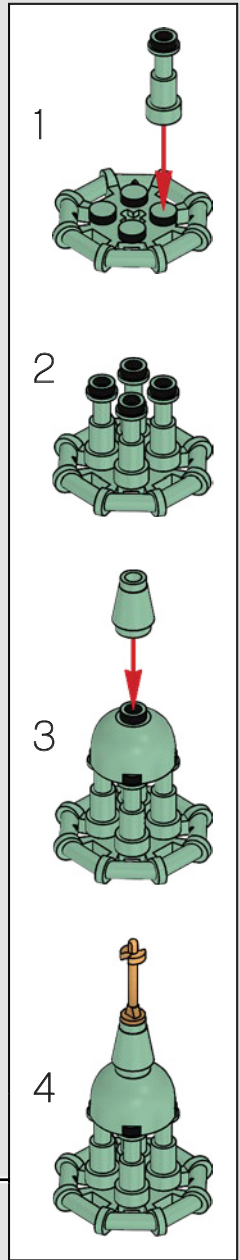
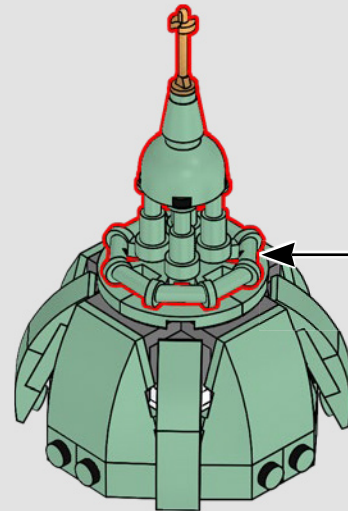

441

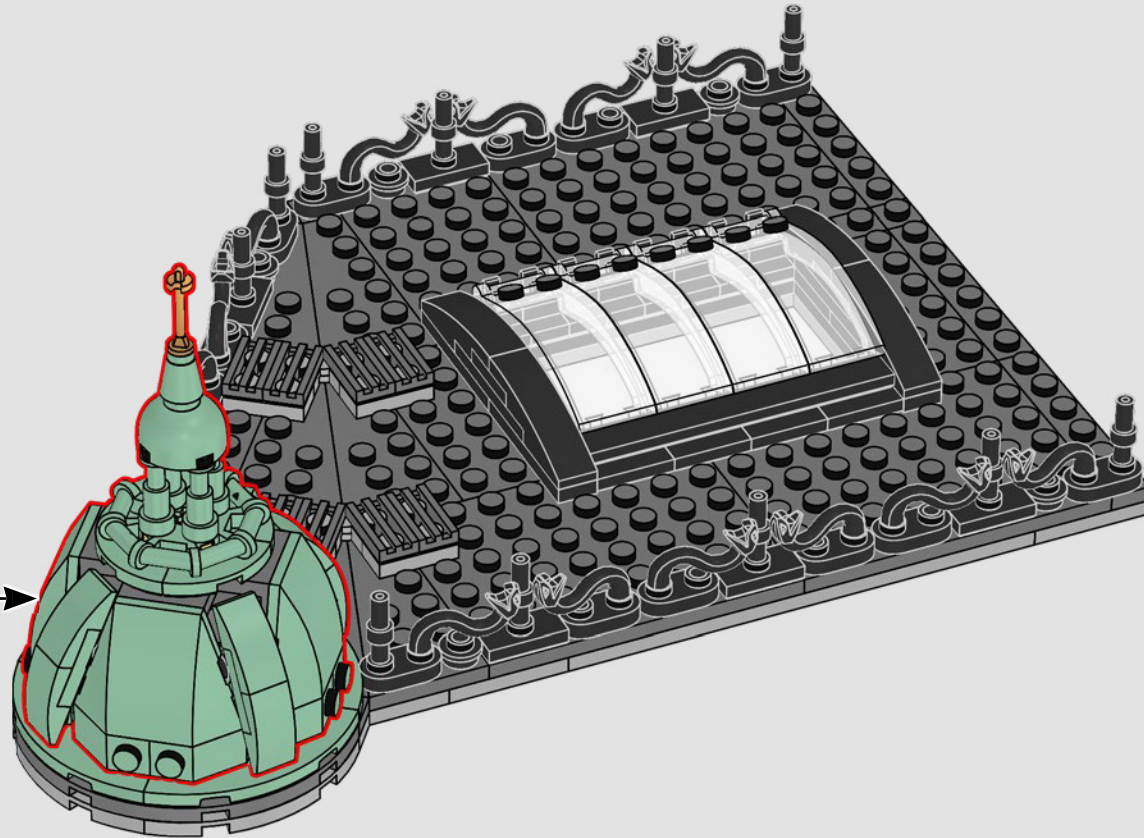

442

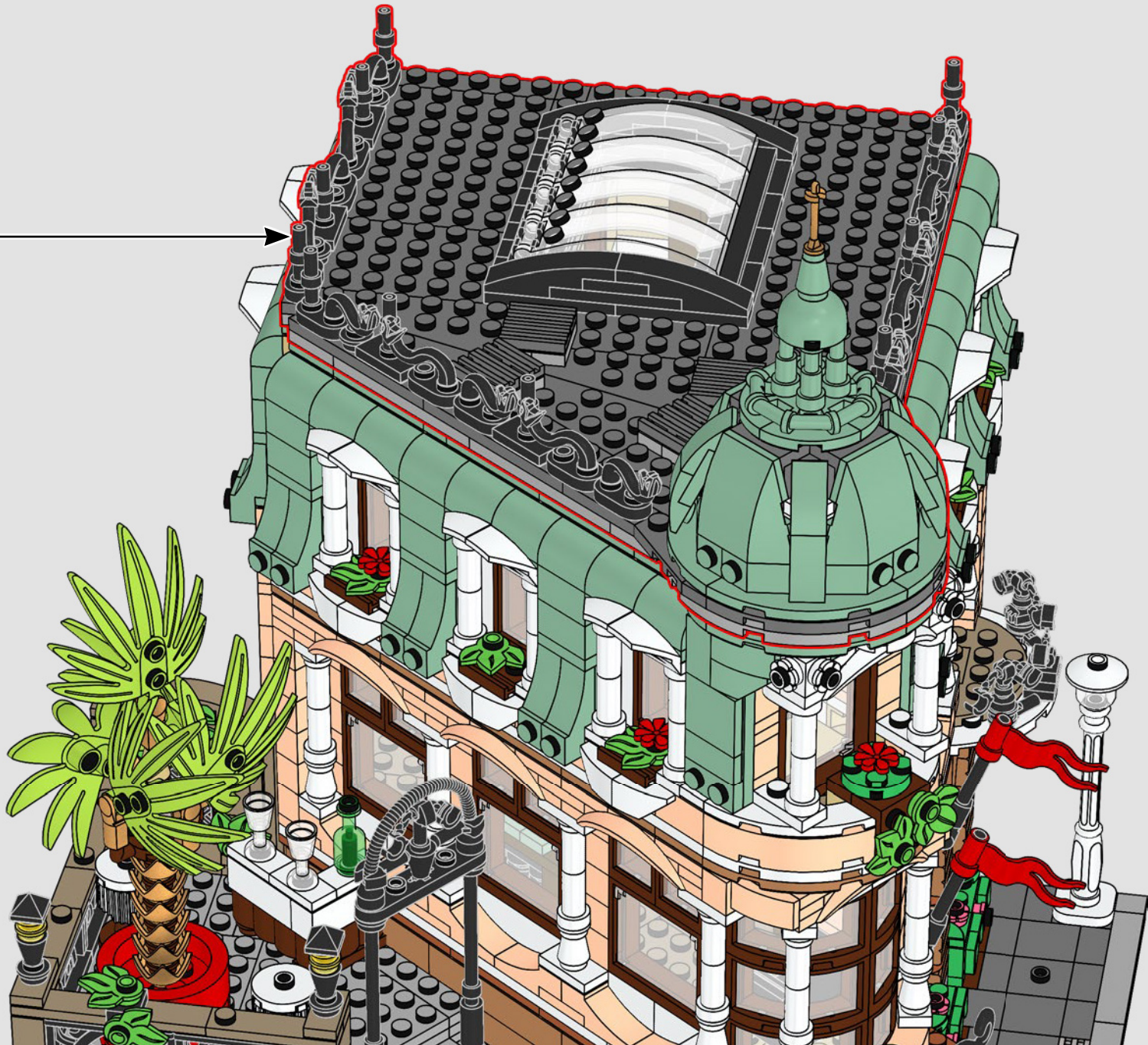

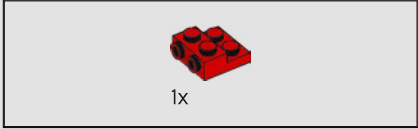

1

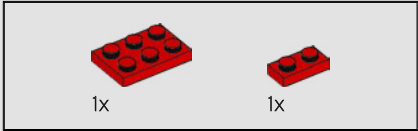
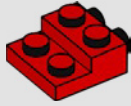

2

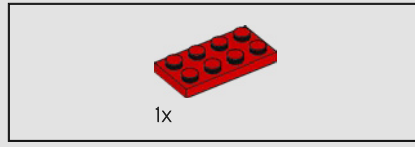
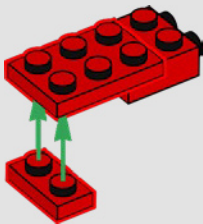

3

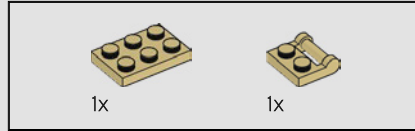
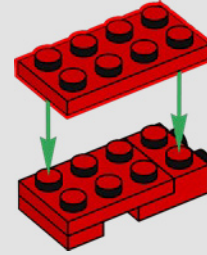

4

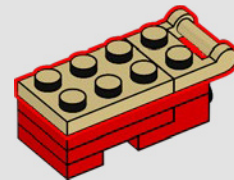



5

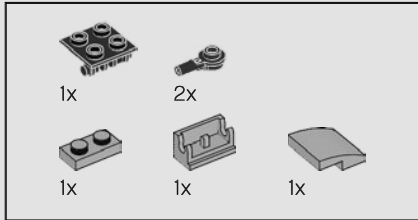
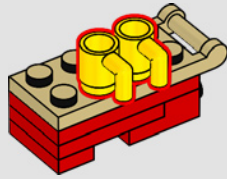

6

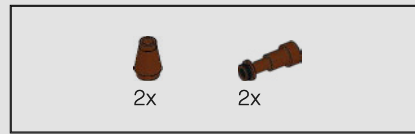
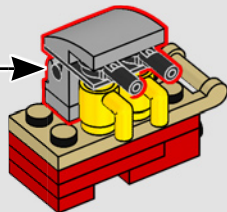
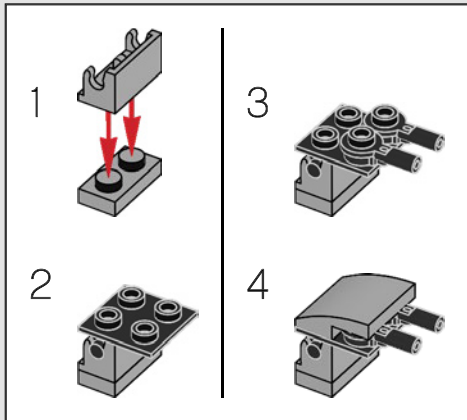

7

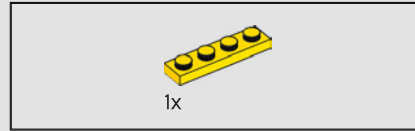
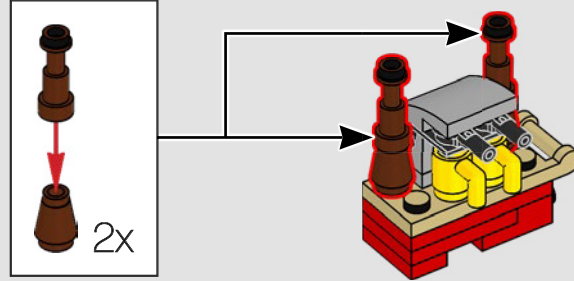

8

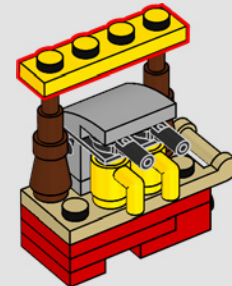

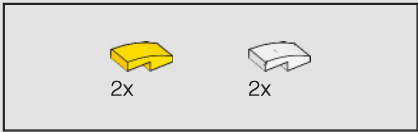

9

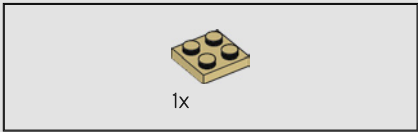
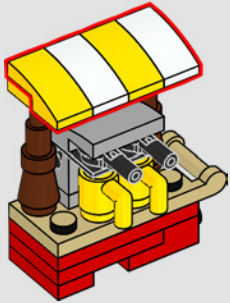

10

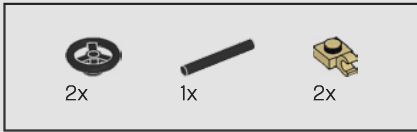
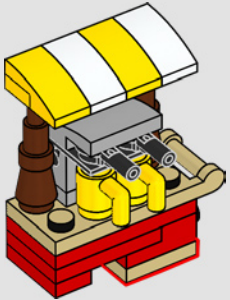

11

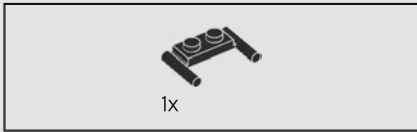
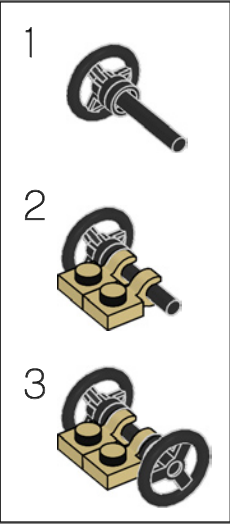
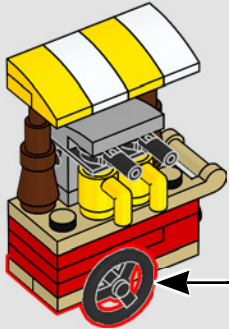

12

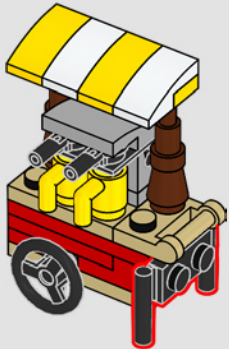

This coffee cart is the mobile extension of the 10182 Café Corner set, the very first Modular Building. Its awning and yellow coffee cups match the ones from the original building.

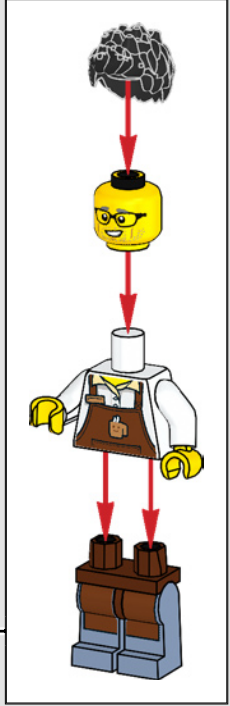







# FEEDBACK AND WIN



## FEEDBACK AND WIN

Your feedback will help shape the future development of this product series.

Please visit:

## FEEDBACK UND GEWINNEN

Dein Feedback trägt zur Weiterentwicklung dieser Produktreihe bei.

Geh auf:

## COMMENTEZ ET GAGNEZ

Vos commentaires nous aideront à concevoir les futurs produits de cette gamme.

Rendez-vous sur :

## COMENTA Y GANA

Tu opinión nos ayudará a dar forma al desarrollo de esta serie de productos en el futuro.

Visita:

## 反馈有奖

您的反馈将有助于我们在今后改进本系列产品。

请访问：

[LEGO.com/productfeedback](https://www.lego.com/productfeedback)

By completing, you will automatically enter a drawing to win a LEGO® set.

Terms & Conditions apply.

Durch Ausfüllen nimmst du automatisch an der Verlosung eines LEGO® Preises teil.

Es gelten die Teilnahmebedingungen.

En envoyant vos commentaires, vous serez automatiquement inscrit(e) à un tirage au sort qui vous permettra de remporter un prix LEGO®.

Offre soumise à conditions.

Al contestar, participarás automáticamente en el sorteo y podrás ganar un set LEGO®.

Sujeto a Términos y Condiciones.

完成我们的反馈调查，即可自动进入抽奖环节，赢取乐高®套装。

适用《条款和条件》。

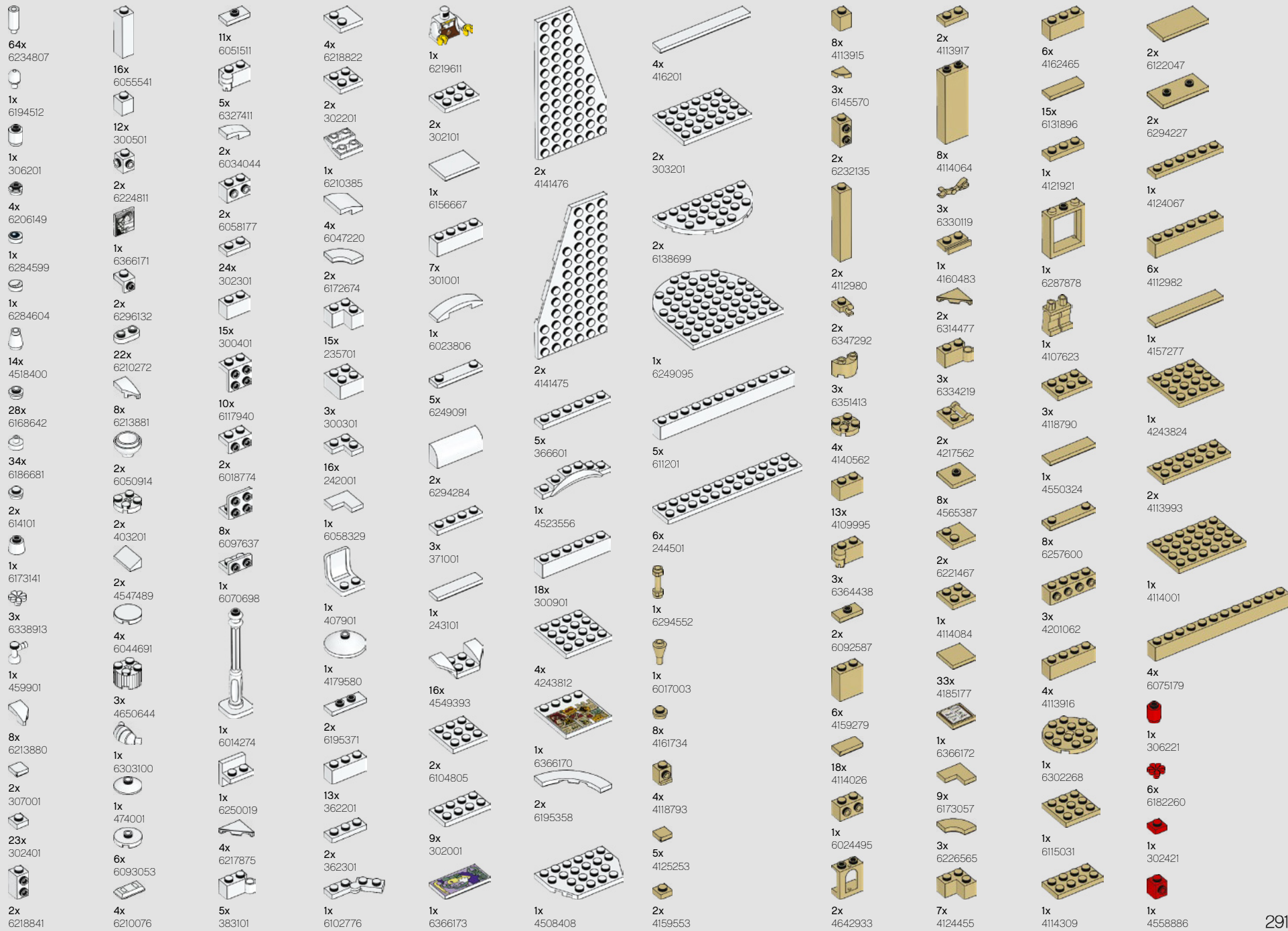

1x 302321	2x 6092582	1x 6218235	2x 6210496	1x 6224071	1x 6323420	1x 4539128	5x 4565323	1x 4613153	1x 6327402	1x 6357937	8x 6252258
1x 302221	1x 300423	1x 4651443	9x 6321194	12x 6371584	1x 6323421	19x 6092585	1x 368026	11x 371026	1x 303426	6x 4616027	26x 6254552
2x 242021	1x 302323	1x 6116616	2x 6240496	1x 6173105	1x 6024730	1x 6138173	1x 6013867	4x 6037746	1x 303426	5x 4614158	1x 6278710
4x 4567445	2x 4558606	1x 6103171	1x 4529236	1x 6299338	1x 6024730	1x 306926	1x 4124096	2x 243126	1x 395826	2x 6186009	1x 6278710
1x 6061711	3x 362223	1x 6288015	3x 6056234	4x 6308000	1x 6102341	2x 6147050	5x 6052126	1x 6115117	2x 447726	2x 6186423	2x 6251285
2x 362321	2x 4587840	1x 6211710	19x 6168646	15x 6380639	1x 6092664	3x 6000650	2x 4515368	4x 6138726	4x 4558593	23x 6253425	2x 6251285
2x 6268946	2x 428623	2x 307024	10x 6186675	1x 6134617	1x 6092664	1x 6250020	1x 4515368	1x 407926	14x 6150607	2x 6257603	3x 6256058
1x 302121	1x 317623	1x 300524	6x 614126	2x 6336977	1x 6070695	1x 6250020	1x 407926	2x 6272184	1x 403228	5x 6074892	3x 6256058
1x 4515348	4x 6102759	3x 6195183	3x 6278152	4x 6104209	2x 6057397	1x 6285241	2x 6272184	1x 6280168	1x 6269971	1x 6074893	4x 6247362
1x 6313597	2x 300223	2x 389924	1x 362626	2x 6281993	1x 4105175	16x 6214807	1x 6219624	1x 302026	1x 6261358	21x 6074893	4x 6247362
1x 302021	1x 371023	2x 6029947	2x 6312449	1x 6079896	1x 6366174	4x 6252201	1x 317626	1x 663626	1x 6261358	4x 6058089	7x 6253734
2x 614123	1x 371023	1x 242024	4x 6273589	19x 6210270	2x 6195325	1x 6336989	2x 6116604	1x 6058118	6x 6129807	6x 6253418	4x 6244793
2x 6344028	1x 371023	1x 371024	2x 300526	1x 6308032	1x 4106552	1x 6151289	1x 6162892	1x 6344427	3x 371028	2x 6166107	4x 6240216
1x 300523	1x 6262960	7x 302426	4x 6157554	4x 6157554	2x 249626	1x 6093525	2x 6286835	1x 346026	17x 6182261	10x 6143431	4x 6240216
3x 370023	1x 6366175	10x 6335388	5x 6196548	5x 6196548	1x 9339	1x 6093525	1x 383926	1x 416226	17x 6369194	17x 6369194	2x 6337597
292		2x 6172383	2x 6170421	1x 6210307	10x 302326	2x 306826	1x 6186698	1x 416226	2x 6248949	1x 6168665	2x 6337597
		5x 6290456	2x 6228987	2x 6279875		1x 302226				6x 6244796	2x 6247364

1x 6047056	12x 6055172	1x 6167936	2x 4530712	1x 6134280	8x 6083976	4x 4539114	1x 6335285	4x 4211222	8x 4565394	5x 4216668
1x 4558595	9x 6273590	5x 6001822	2x 6232137	2x 6223913	4x 4649065	2x 6311890		14x 6382102	1x 6122977	1x 4211181
4x 6240467	6x 4549436	1x 6310832	8x 4251796	1x 6221730	2x 6133896	4x 6212040	1x 4621543	5x 6103004	1x 4211200	1x 4211181
1x 6213779	13x 6001824	2x 6175927	2x 6275088	2x 6223225	20x 6186823	2x 6341767	4x 4529242	1x 6139435	4x 4211221	6x 6343651
3x 6213777		5x 6257599	1x 6312450	1x 6221729	1x 6186828	2x 4539090	9x 6215659	1x 4211242	5x 6221608	3x 4211225
3x 6223665	4x 6334209	2x 6257599	3x 4626904	1x 6278544	6x 6299637	2x 6274681	1x 4212242	1x 4221744	2x 4211257	2x 4658005
3x 6223665	2x 6092591	5x 6257599	3x 4626904	1x 6278544	2x 6223171	2x 6274681	1x 4212288	1x 4211288	2x 6146301	1x 4211194
2x 6273853	8x 4521914	3x 4626904	3x 6055171	1x 6278544	20x 6369375	2x 4539102	3x 6149677	1x 6062574	1x 6313506	7x 4211190
2x 6273853	11x 4496699	2x 4267874	8x 6055222	16x 4616578	2x 6385228	2x 6107758	1x 4211499	16x 4211509	11x 6100769	1x 6153594
2x 6249417	14x 4528604	3x 6096108	4x 4245570	20x 4616581	2x 6385228	2x 6107758	1x 4211499	20x 4211515	13x 4211152	7x 4595889
1x 6223065	8x 4521914	2x 4267874	4x 4245570	6x 6360075	2x 6385228	2x 6107758	1x 4211499	16x 4211515	11x 6100769	1x 6153594
2x 6337637	11x 4496699	3x 6096108	4x 4245570	28x 6278541	1x 6223219	1x 6172632	6x 6341553	20x 4211515	13x 4211152	7x 4595889
1x 4537251	6x 6002849	3x 4507047	2x 4226869	2x 6223126	3x 6100234	3x 6100234	1x 6306775	16x 4211515	13x 4211152	7x 4595889
2x 6337637	14x 4528604	3x 6096108	4x 4245570	2x 6223126	3x 6100234	3x 6100234	1x 6306775	16x 4211515	13x 4211152	7x 4595889
1x 4537251	6x 6002849	3x 4507047	2x 4226869	2x 6223126	3x 6100234	3x 6100234	1x 6306775	16x 4211515	13x 4211152	7x 4595889
1x 6192789	14x 4528604	3x 6096108	4x 4245570	2x 6223126	3x 6100234	3x 6100234	1x 6306775	16x 4211515	13x 4211152	7x 4595889
1x 6192789	6x 6002851	7x 6015424	6x 4245571	8x 6278553	19x 6192923	4x 4539061	1x 6035291	2x 6310449	4x 6248918	6x 6262952
1x 6192789	6x 6002851	7x 6015424	6x 4245571	8x 6278553	19x 6192923	4x 4539061	1x 6035291	2x 6310449	4x 6248918	6x 6262952
1x 6226630	2x 4550168	6x 4247151	4x 6262972	5x 4655080	2x 4521947	1x 6186003	1x 6268828	1x 617976	1x 6268857	6x 4283660
1x 6226630	2x 4550168	6x 4247151	4x 6262972	5x 4655080	2x 4521947	1x 6186003	1x 6268828	1x 617976	1x 6268857	6x 4283660
1x 6226630	2x 4550168	6x 4247151	4x 6262972	5x 4655080	2x 4521947	1x 6186003	1x 6268828	1x 617976	1x 6268857	6x 4283660
5x 6313098	2x 6135607	6x 4247151	4x 6262972	5x 4655080	2x 4521947	1x 6186003	1x 6268828	1x 617976	1x 6268857	6x 4283660
1x 6366169	1x 6132768	4x 4246957	2x 4543949	6x 6177823	8x 6249817	5x 4539071	1x 4211180	8x 4645103	1x 6120224	2x 6075207

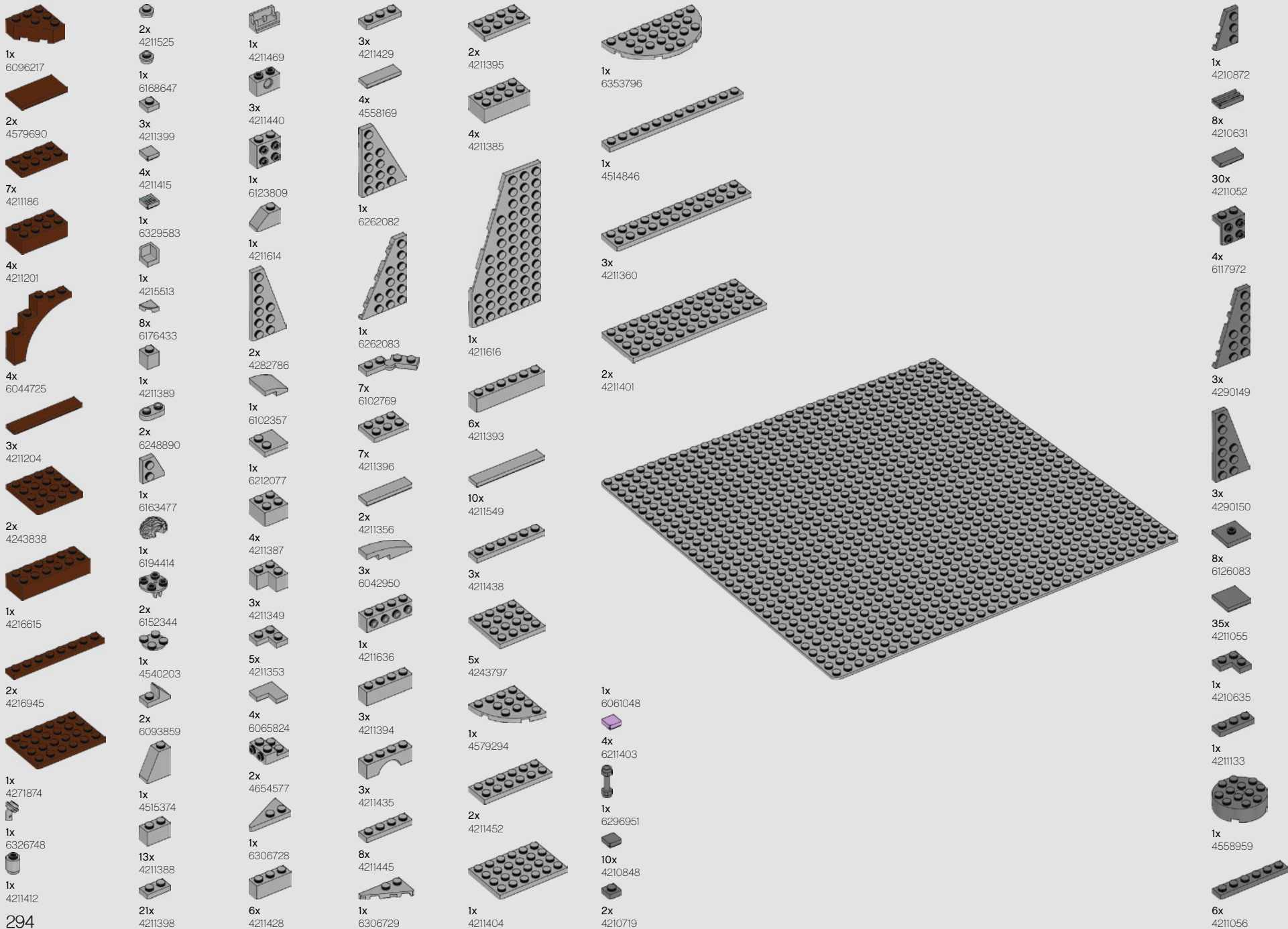

4x 4211002  
 1x 4210998  
 1x 4211115  
 1x 6141856  
 3x 4210794  
 1x 6107399  
 1x 6092833  
 1x 4586410  
 38x 6369191  
 31x 6357797  
 1x 6275872  
 57x 6369188  
 43x 6369189

2x 6357796  
 2x 6343511  
 14x 6325881  
 1x 6297283  
 5x 6357794  
 14x 6369190  
 35x 6378419  
 9x 6369187  
 4x 6369192  
 1x 6170470  
 1x 6292254  
 4x 6252838  
 6x 6296657  
 5x 6209691

4x 4529247  
 1x 6190252  
 5x 6186672  
 5x 4523159  
 1x 6284379  
 6x 6257048  
 2x 6167585  
 2x 4490599  
 1x 6245261  
 1x 6092594  
 2x 6022033  
 5x 6093529  
 3x 6147169  
 4x 6226437  
 6x 6251021  
 5x 4519970

6x 4566688  
 2x 6046943  
 4x 6058221  
 17x 6058257  
 1x 4538950  
 1x 6179803  
 2x 6047037  
 4x 6272145  
 1x 6167928  
 2x 6313874  
 3x 6252667  
 2x 6328181  
 4x 6226792  
 1x 6295366  
 4x 4518687

5x 6300103  
 4x 6167641  
 26x 6057986  
 1x 6167690  
 7x 6215606  
 3x 6177146  
 7x 6314190  
 41x 4656783  
 6x 6021997  
 4x 6186400  
 2x 4568955

17x 6223183  
 6x 6102998  
 8x 6218359  
 47x 6099341  
 1x 6295464  
 4x 6106193  
 2x 6387478  
 1x 6345302  
 3x 6102990  
 4x 6102994  
 1x 6177535  
 6x 6192922

4x 4633691  
 4x 4619636  
 1x 4611884  
 3x 4655243  
 4x 6136419  
 4x 6331949

4x 6119126  
 1x 4624705  
 1x 6253666  
 2x 6361352  
 8x 6251591  
 6x 6295242  
 1x 6240515

Customer Service  
 Kundenservice  
 Service Client  
 Assistenza clienti  
 Atención al cliente  
 Serviço de Apoio ao Consumidor  
 Ügyfélszolgálat  
 Klientu apkalpošanas dienests  
 Serviciul pentru clienți  
 客户服务  
 소비자서비스  
 고객 서비스  
 LEGO.com/service

10278

10297

10270

