



CREATOR



10244



 [LEGO.com](https://www.lego.com)

EXPERT

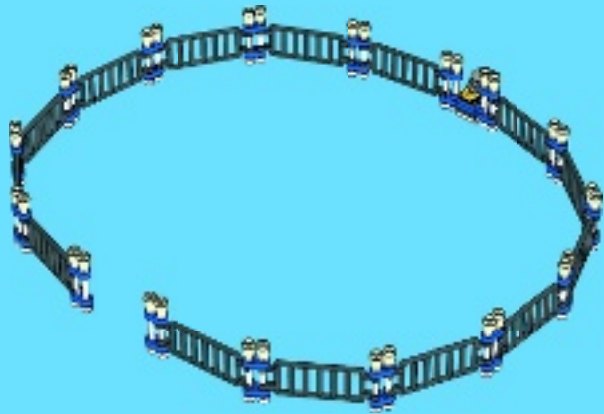
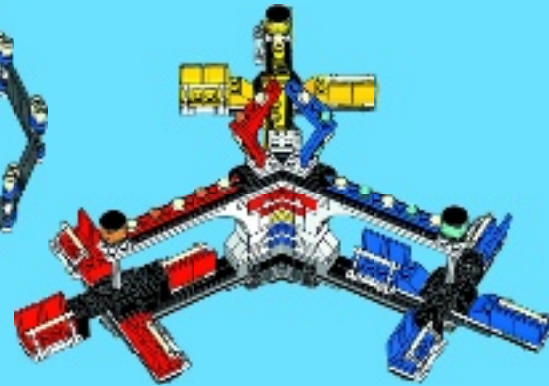
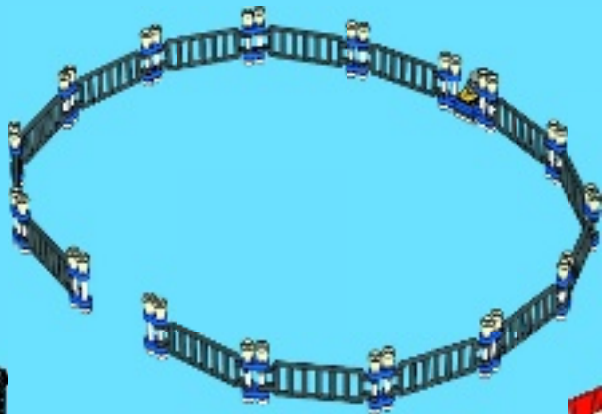

1x

1



2x

2





3

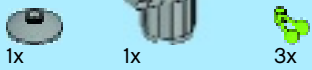
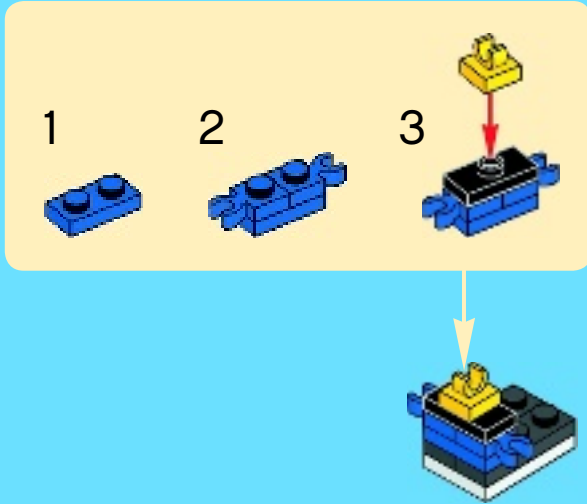

4

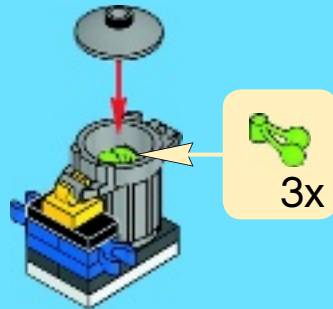

5

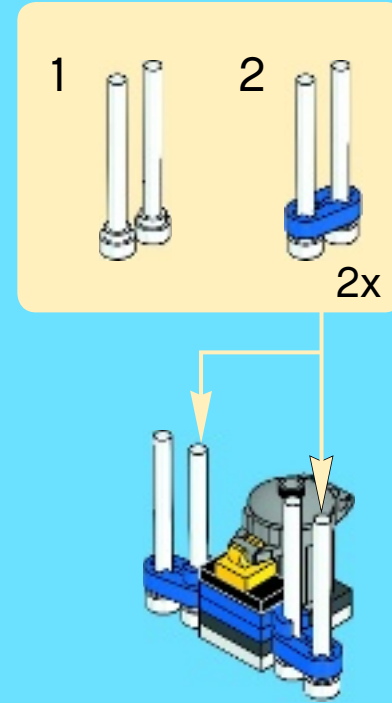

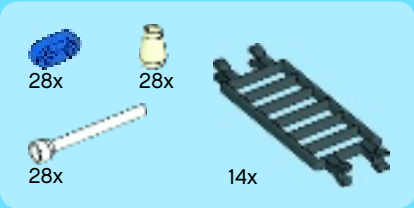

6

1



2



3

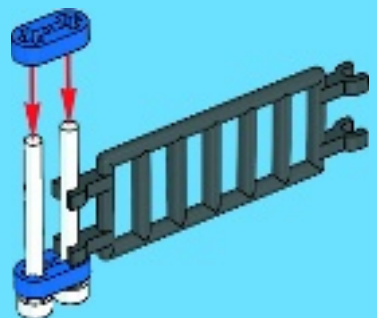

4

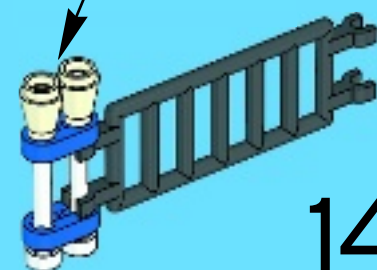

14x

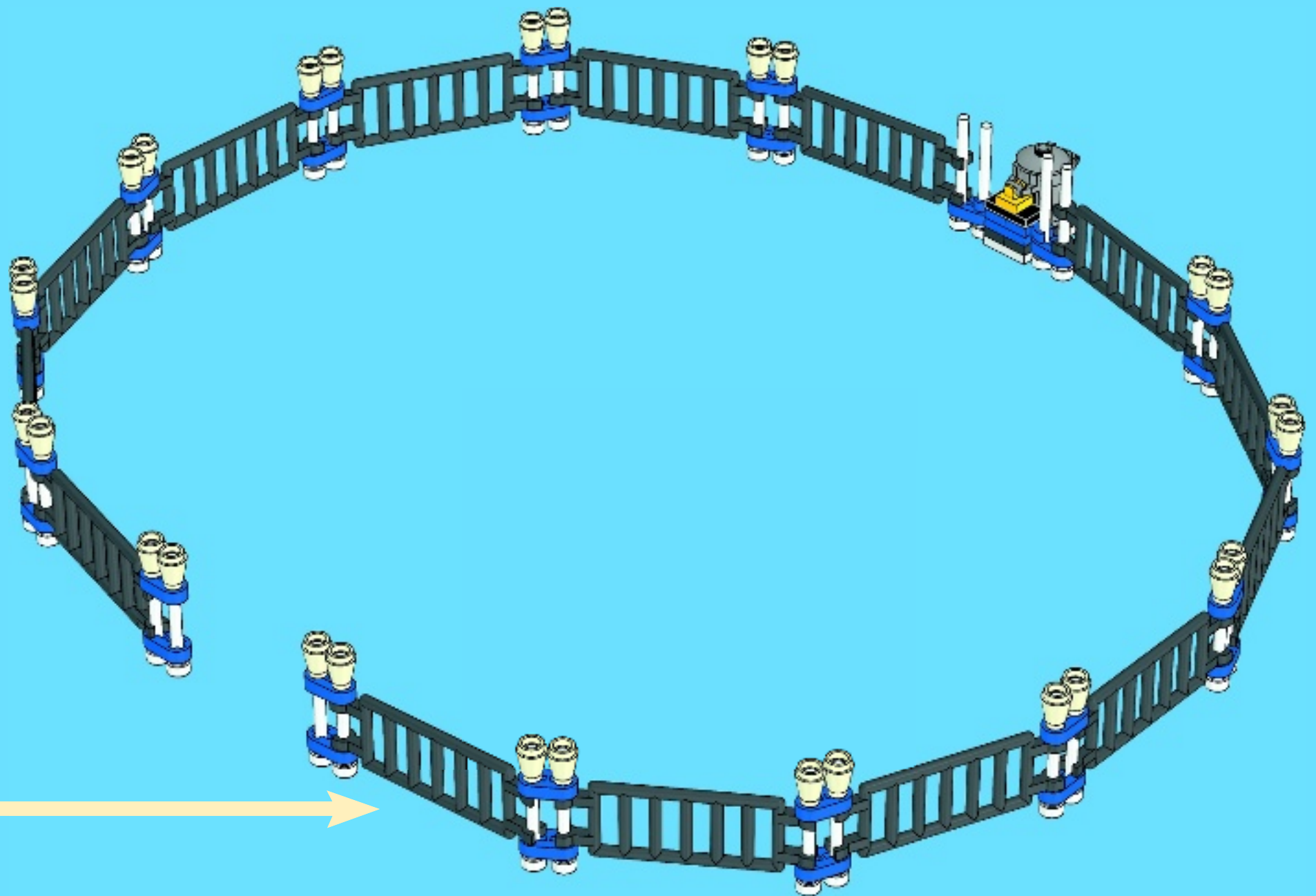



2x



4x

7

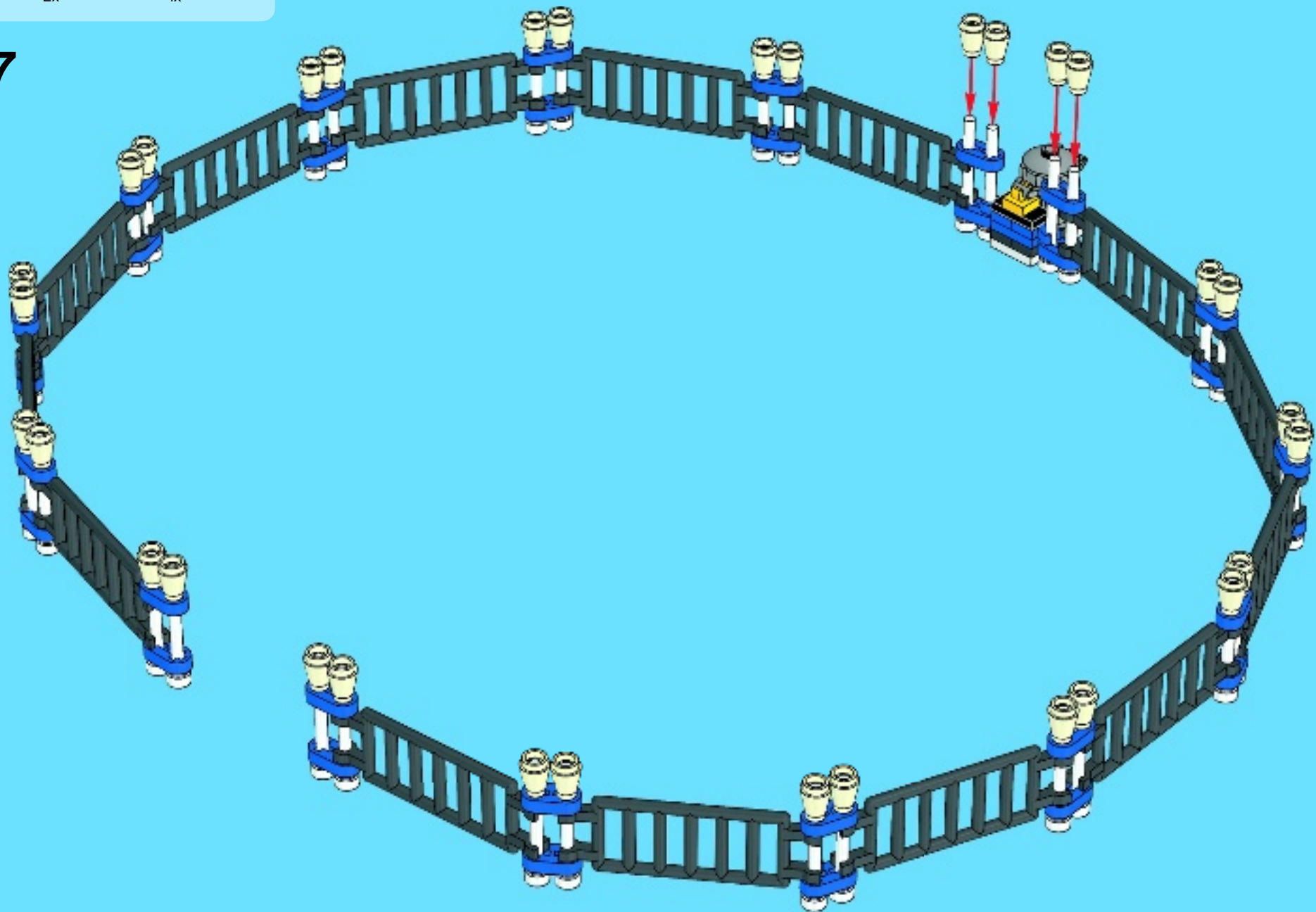

8

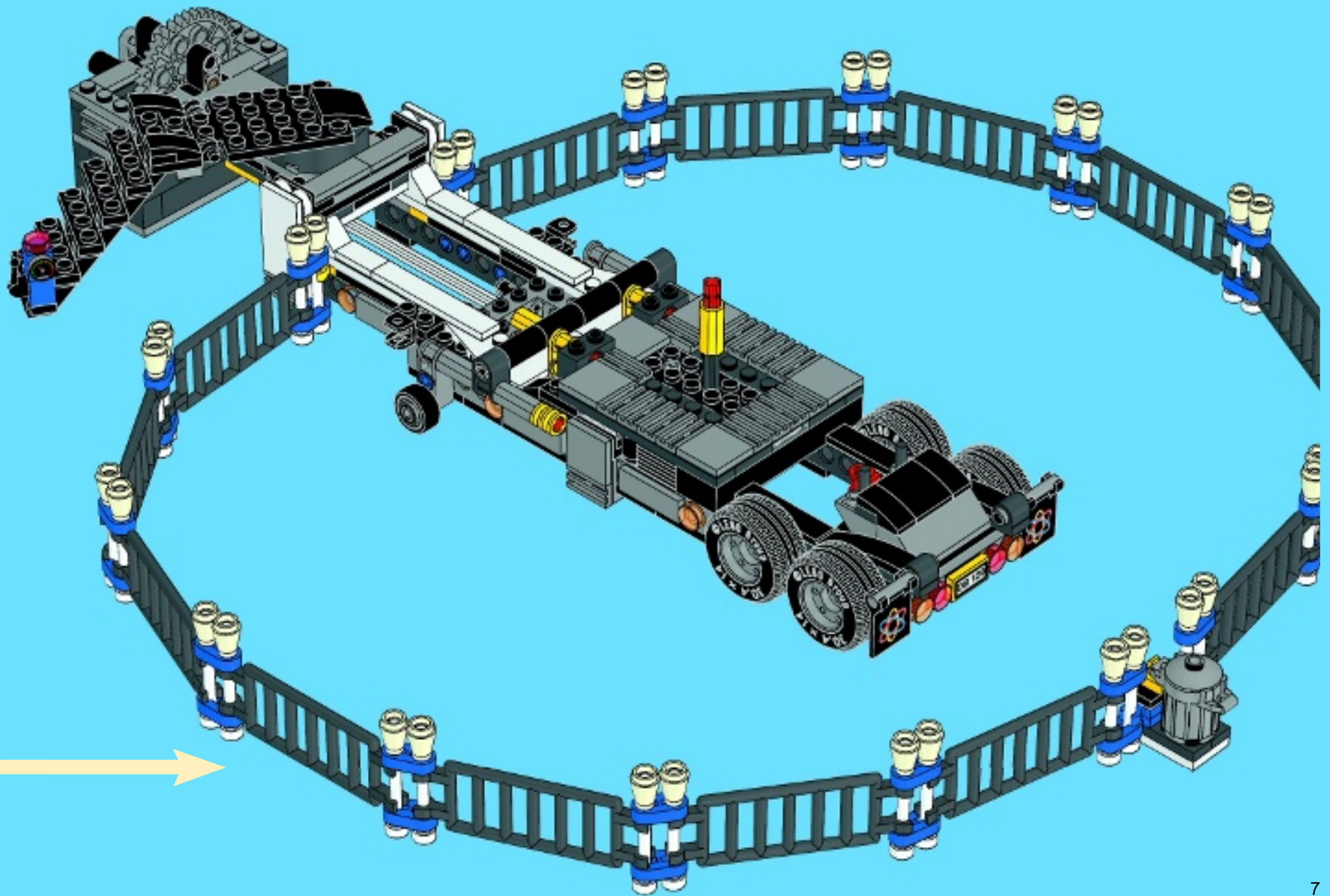

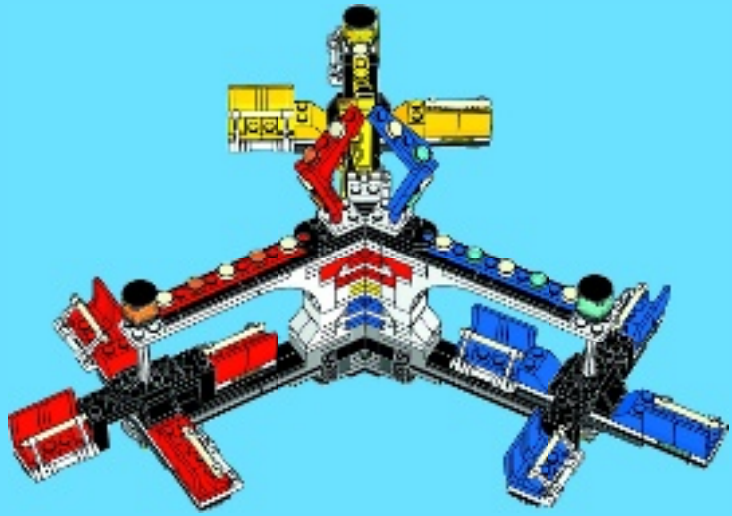

1x

1



1x

2



1x



1x

3

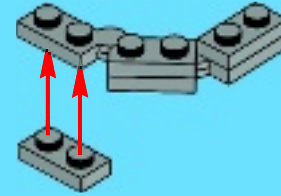

1x

4





1x

5

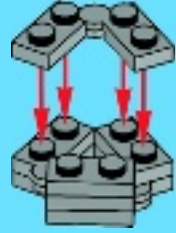

1x



2x

6



3x

7



3x

8

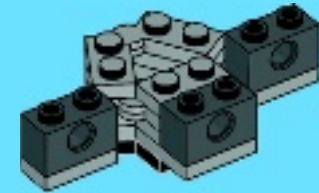



1x



2x



2x

9

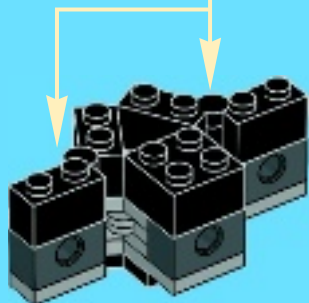
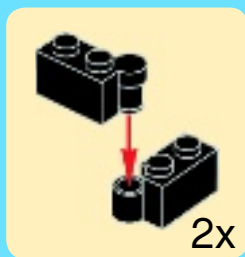

3x



1x

10

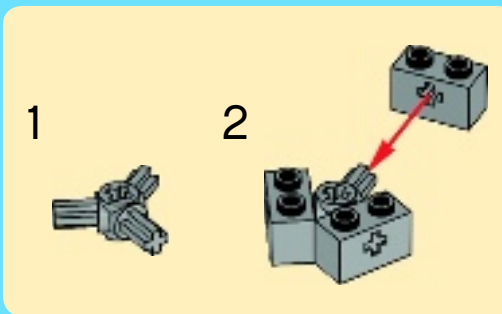

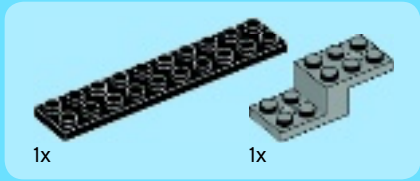
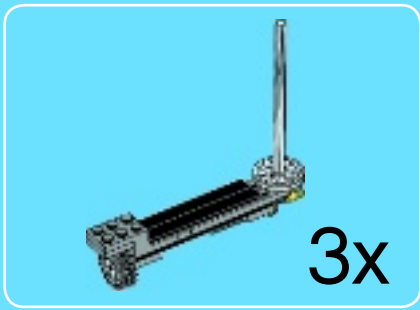

1

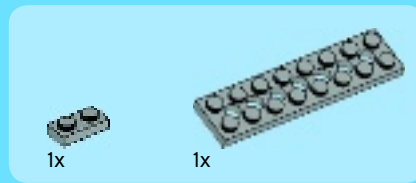
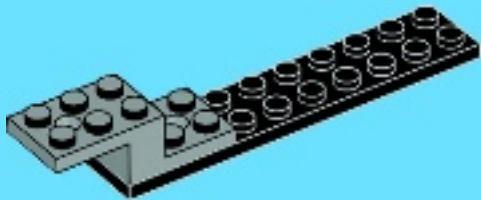

2

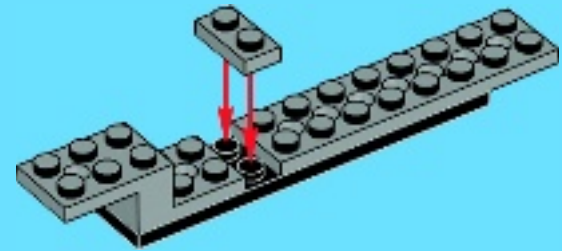

3

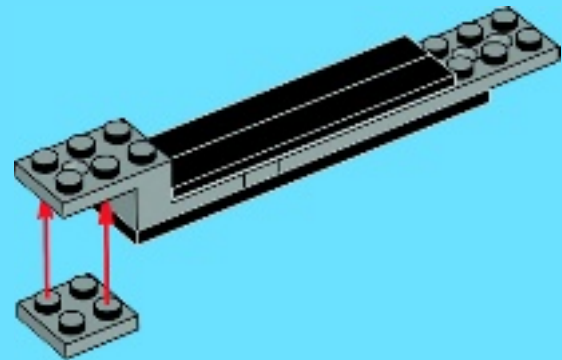

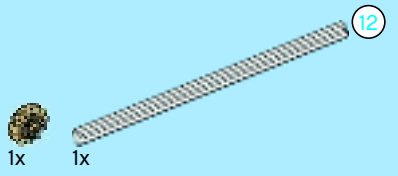

4

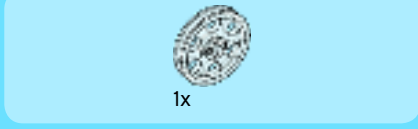
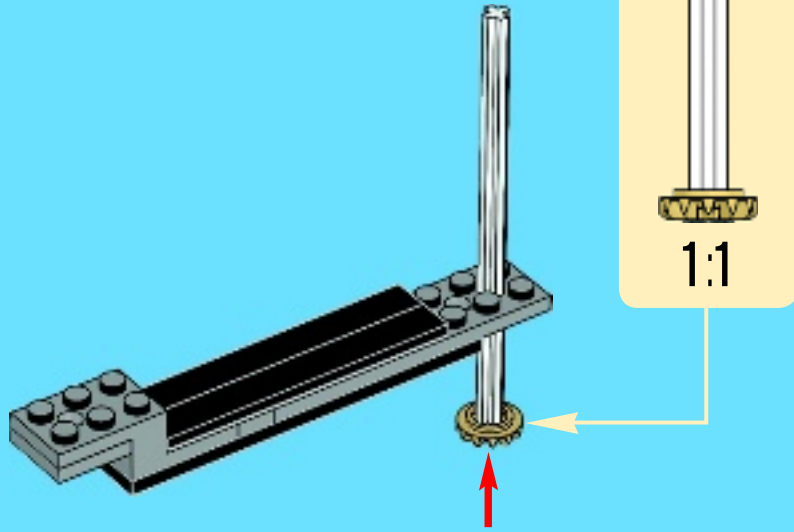

5

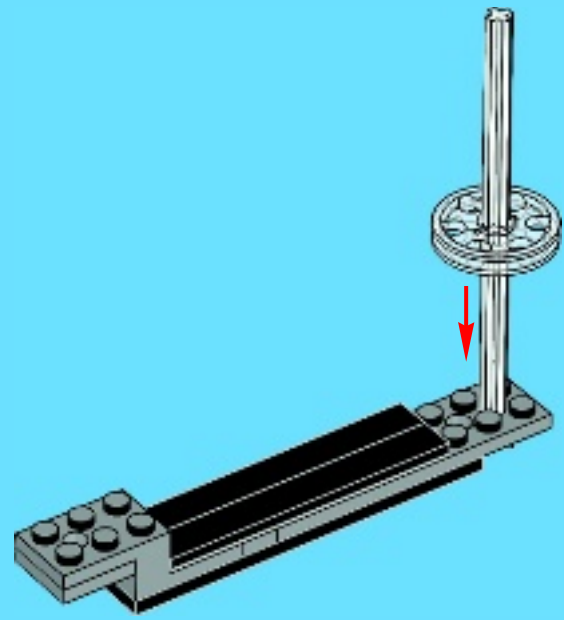



1



2

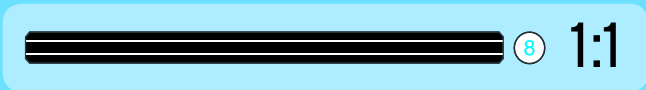
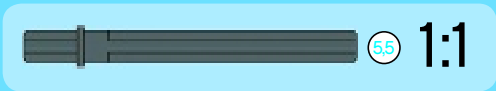
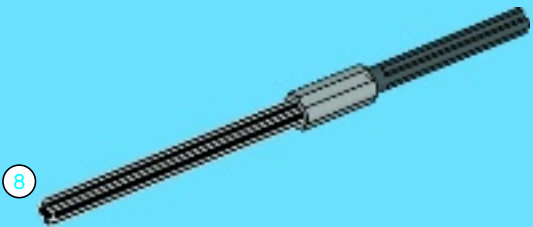

3

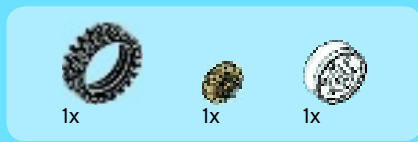
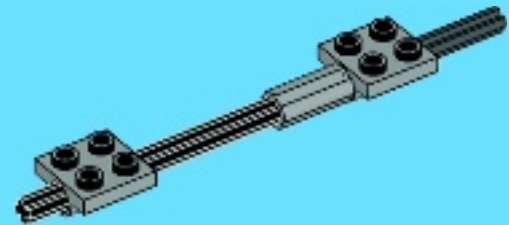

4

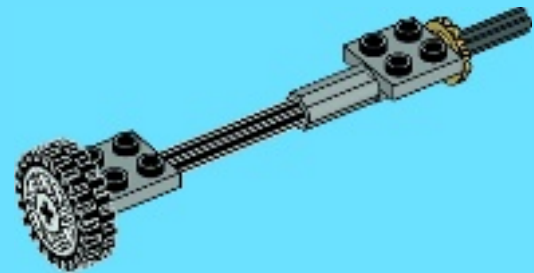



5

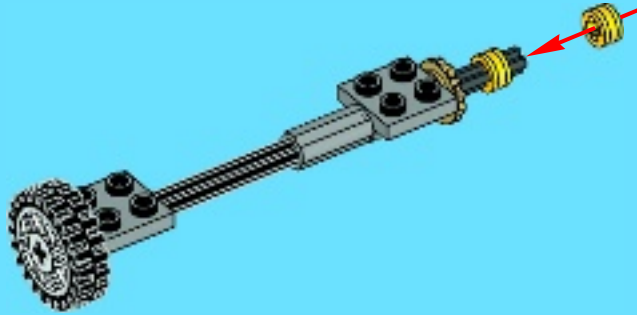

6

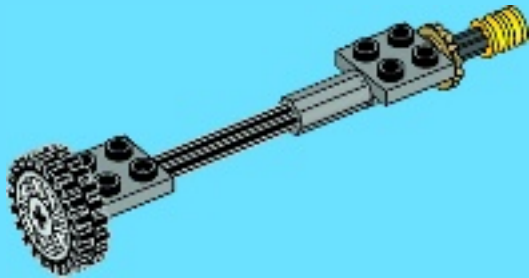

7

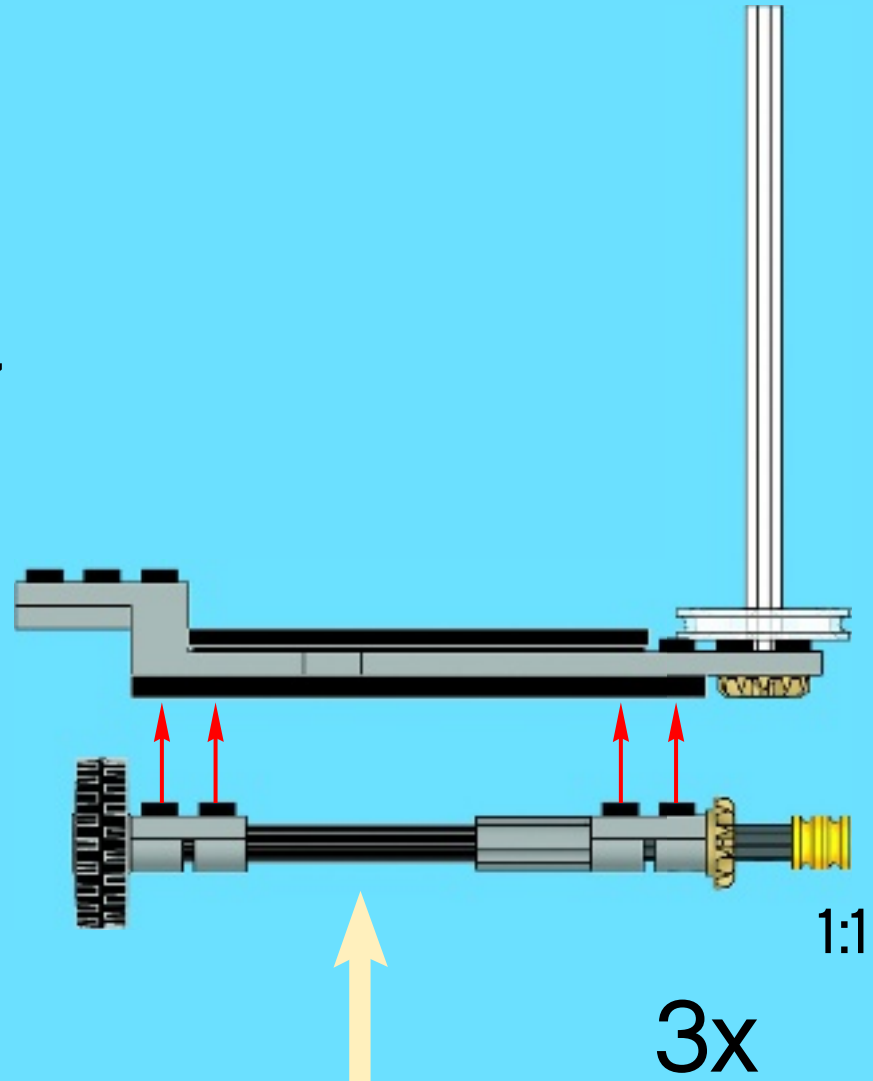

11

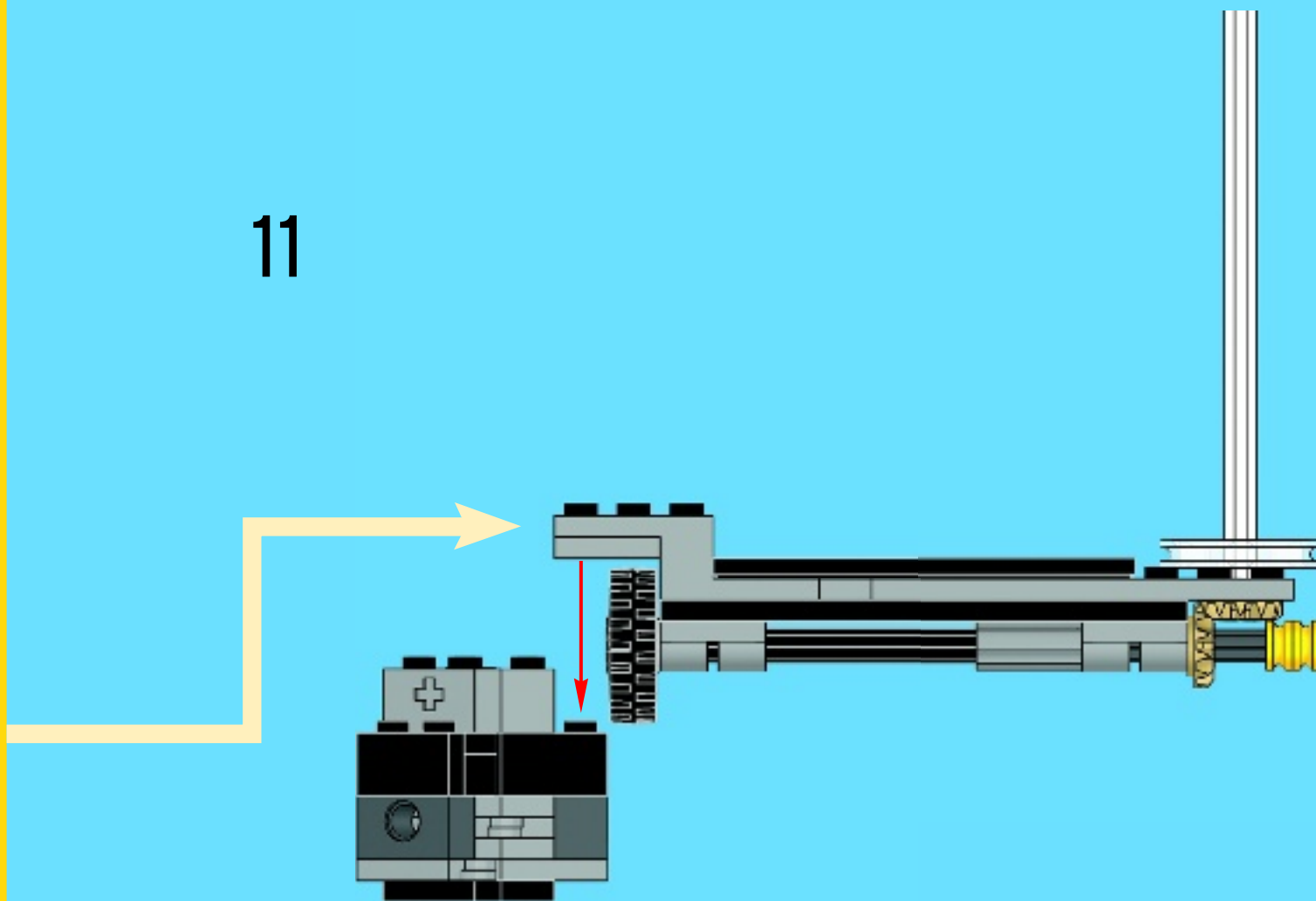

1:1

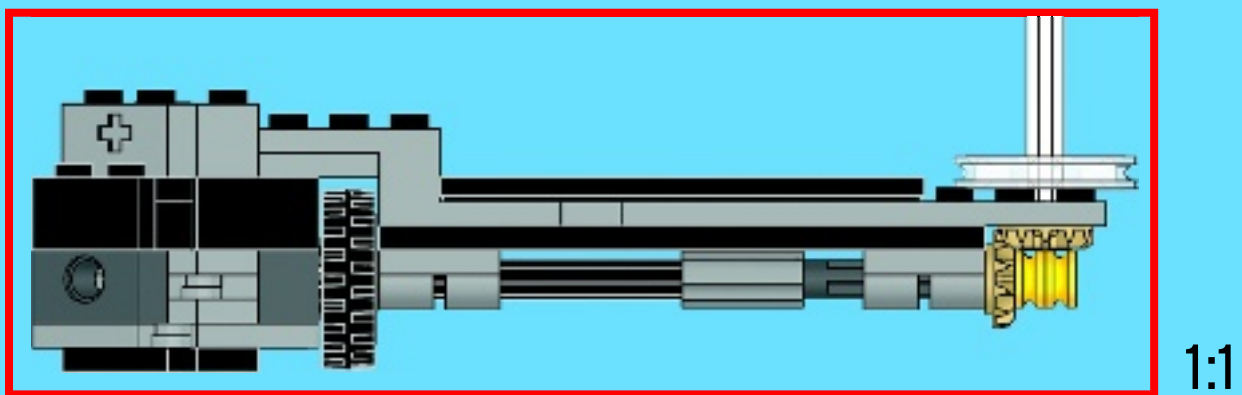
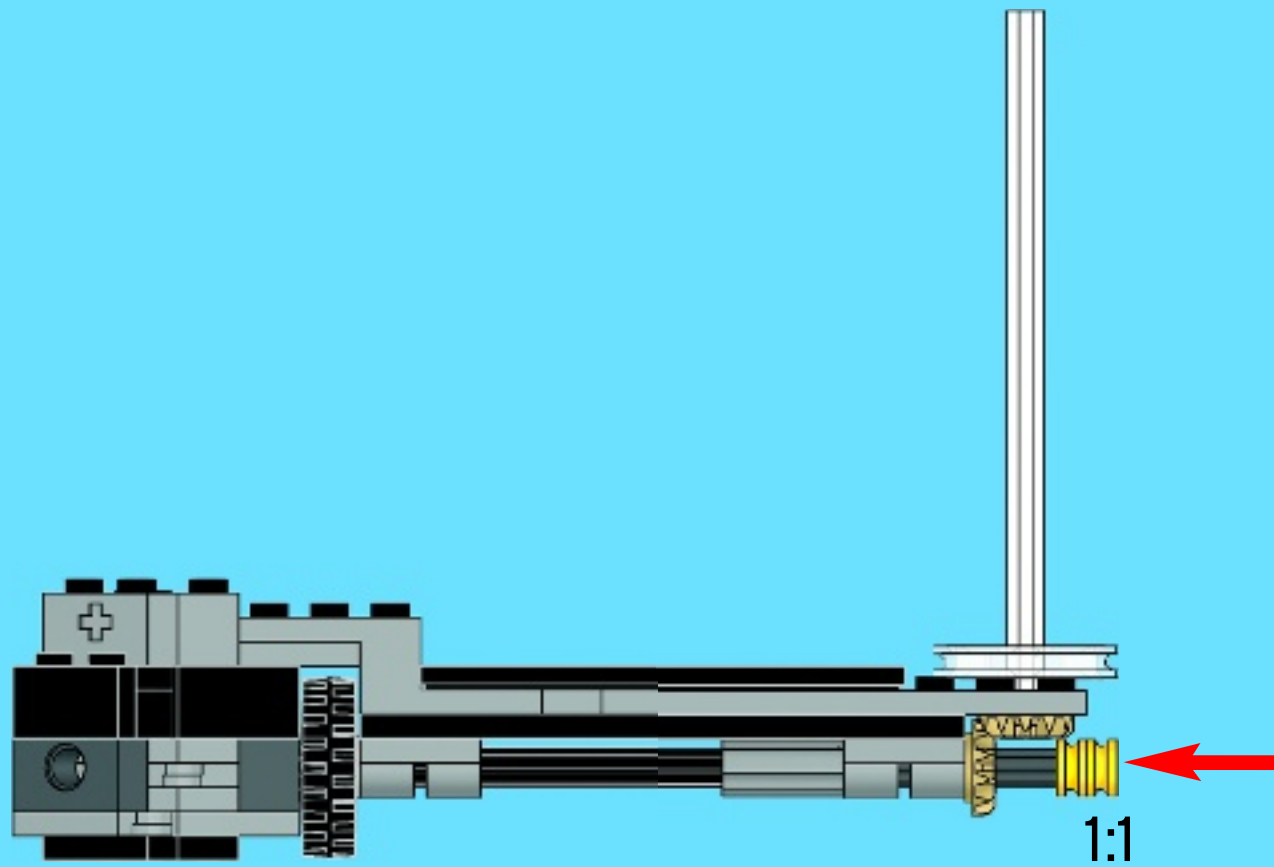

12

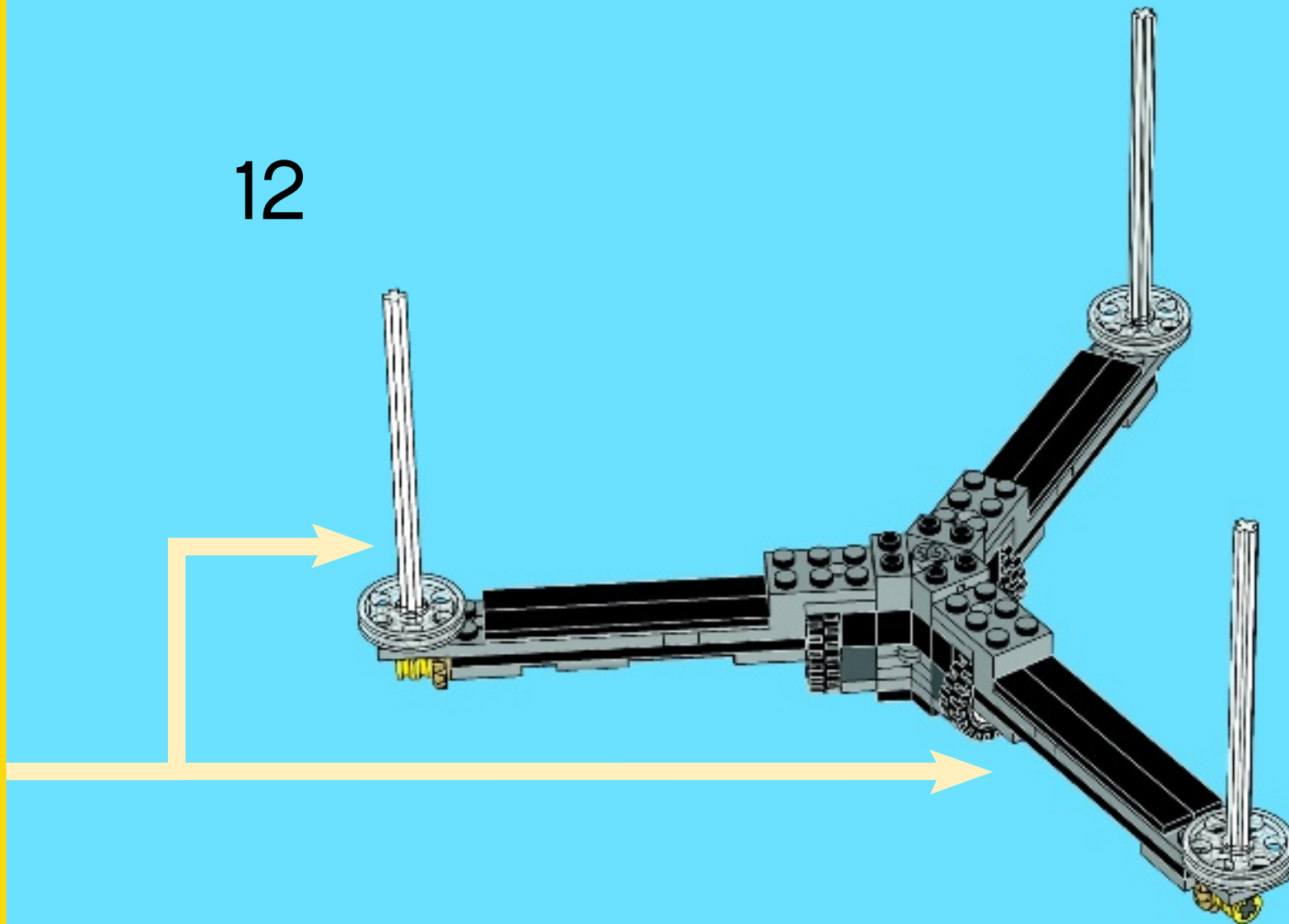



3x



6x

13

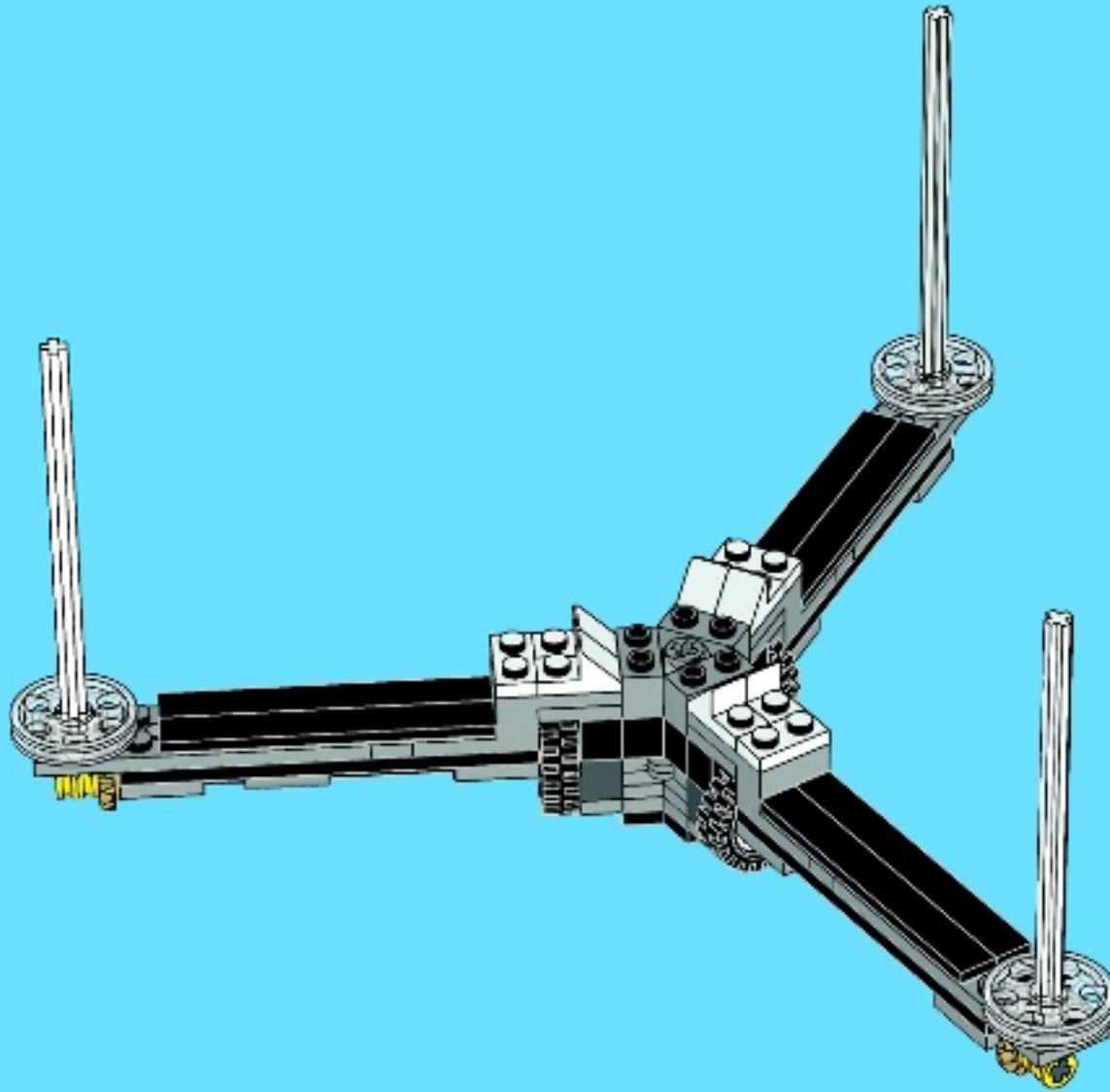



3x



6x

14

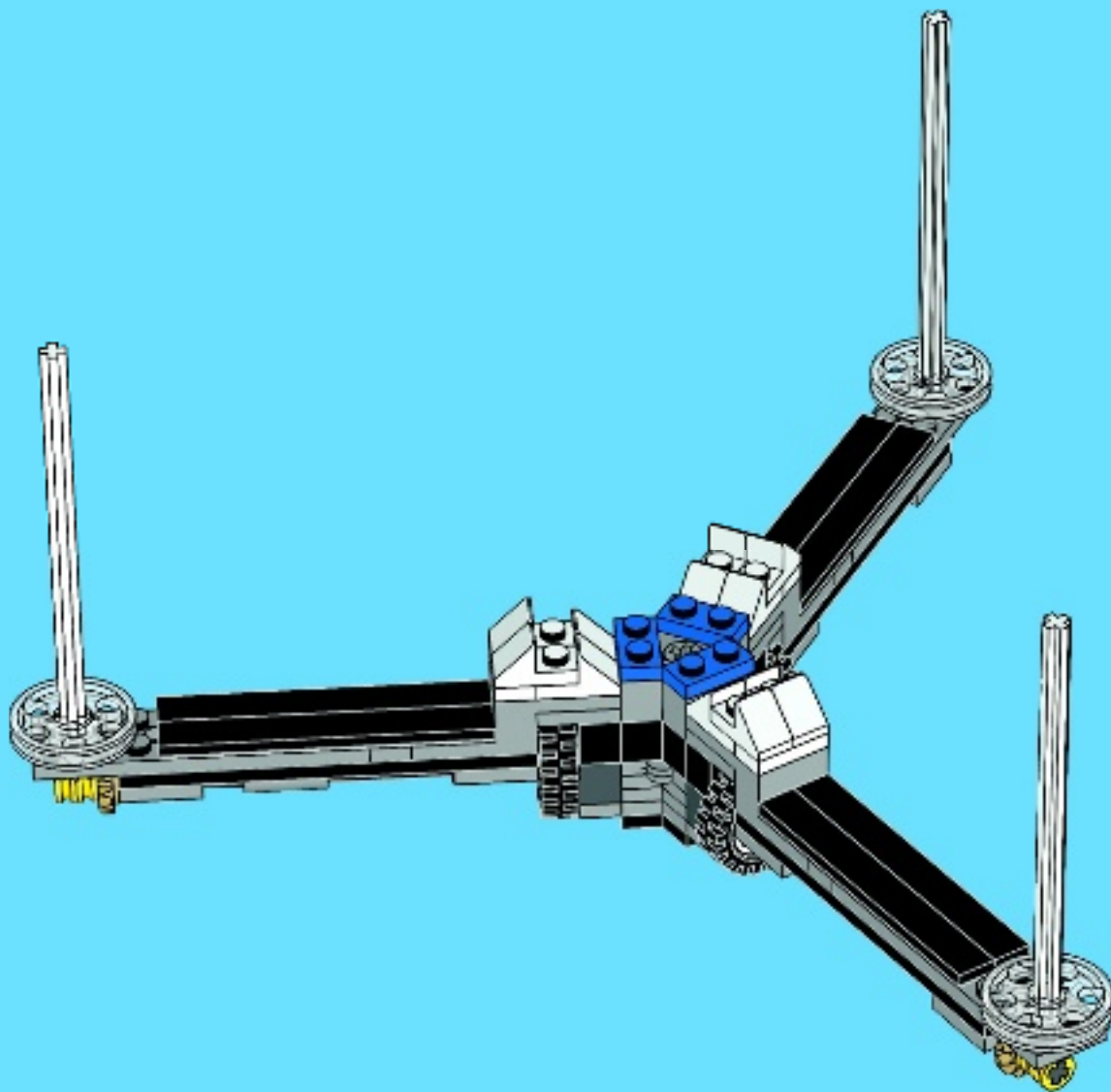



3x



3x

15

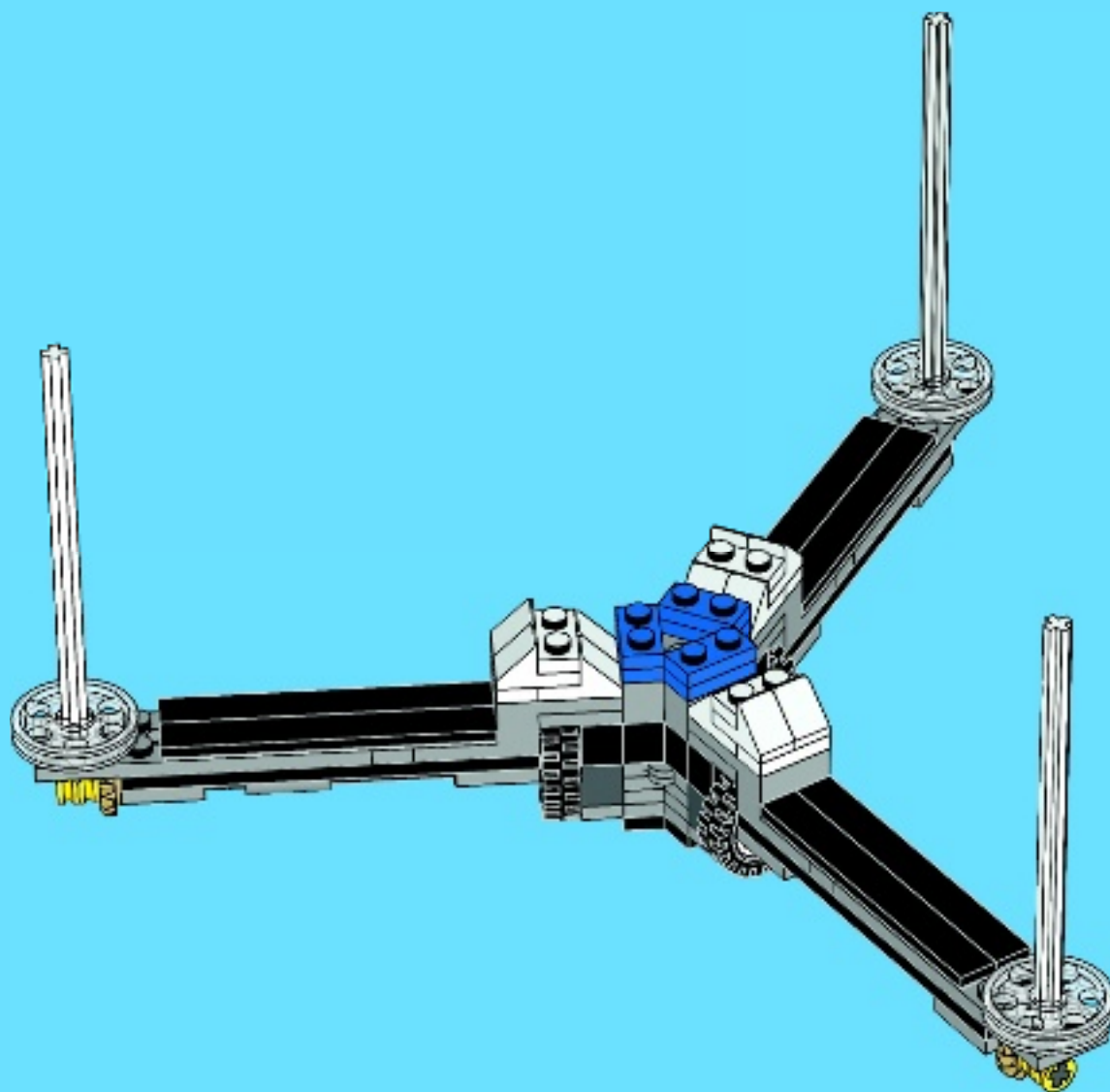



1x



2x



2x

16

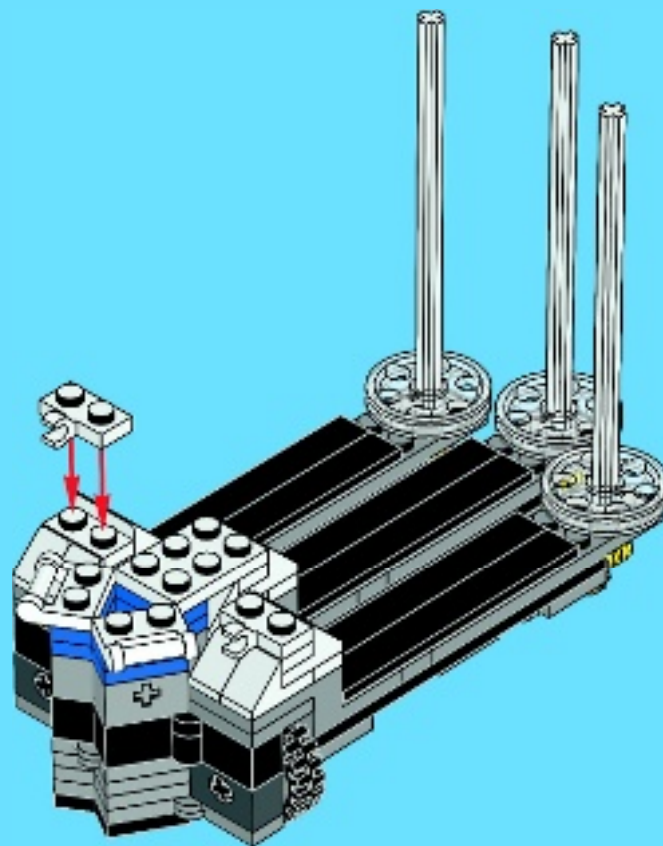



3x

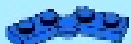

3x

17

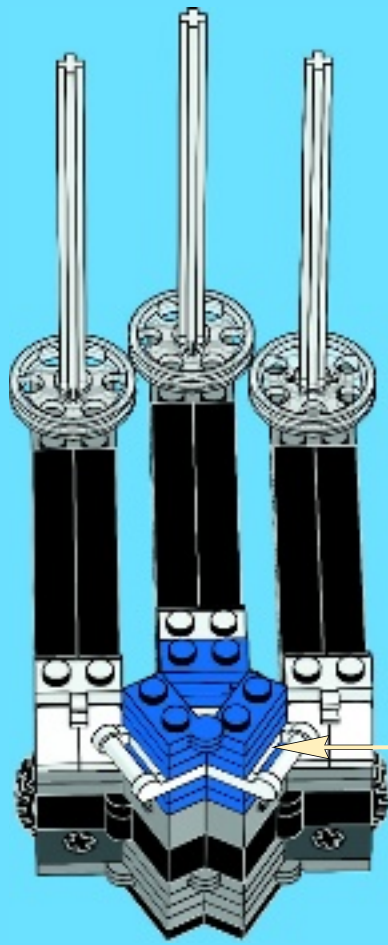

1



2



3

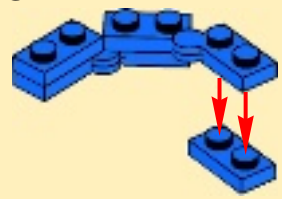

4



5





3x

18

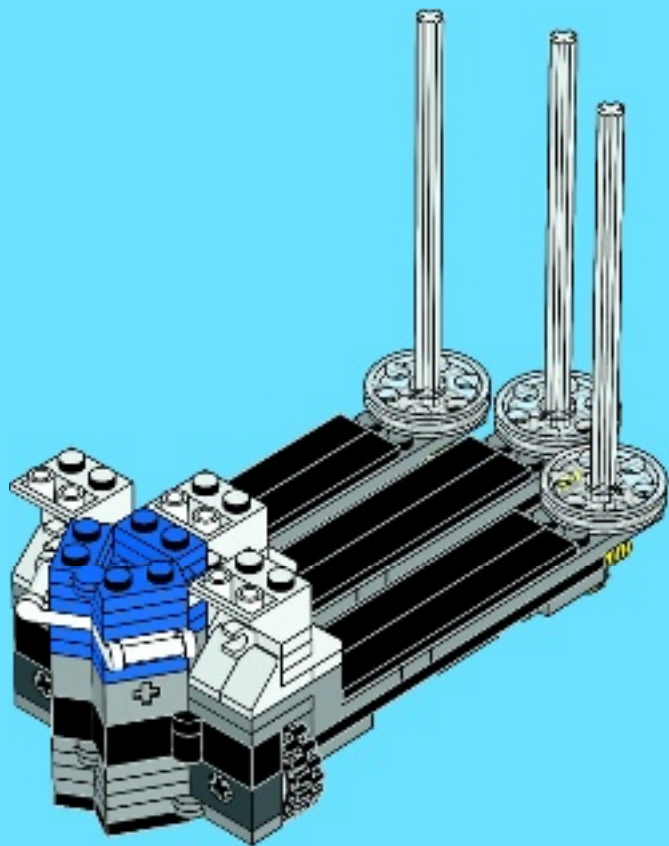

1x



2x

19

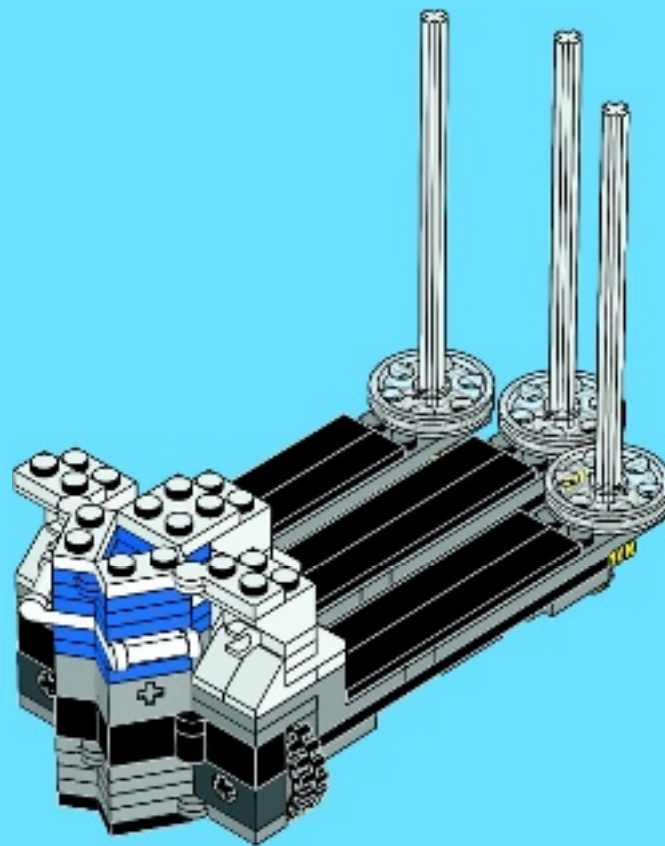



3x



6x



6x

20

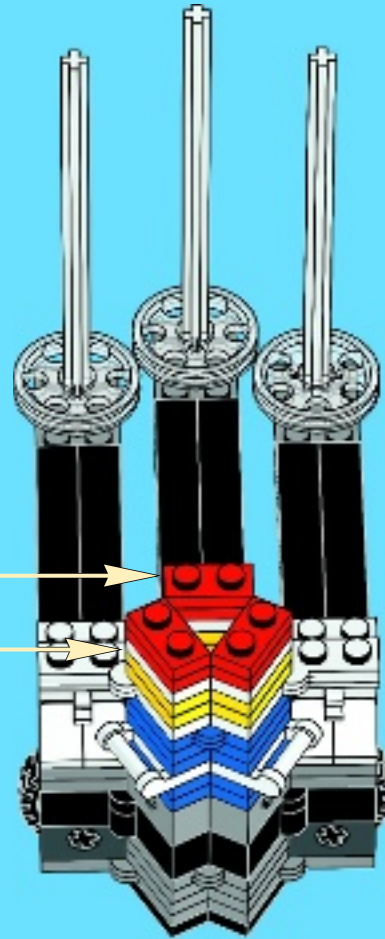
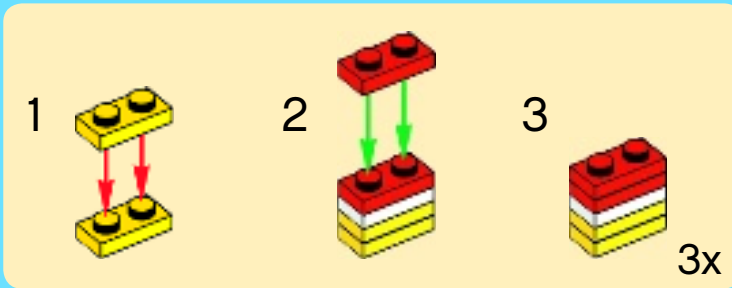



3x



3x

21

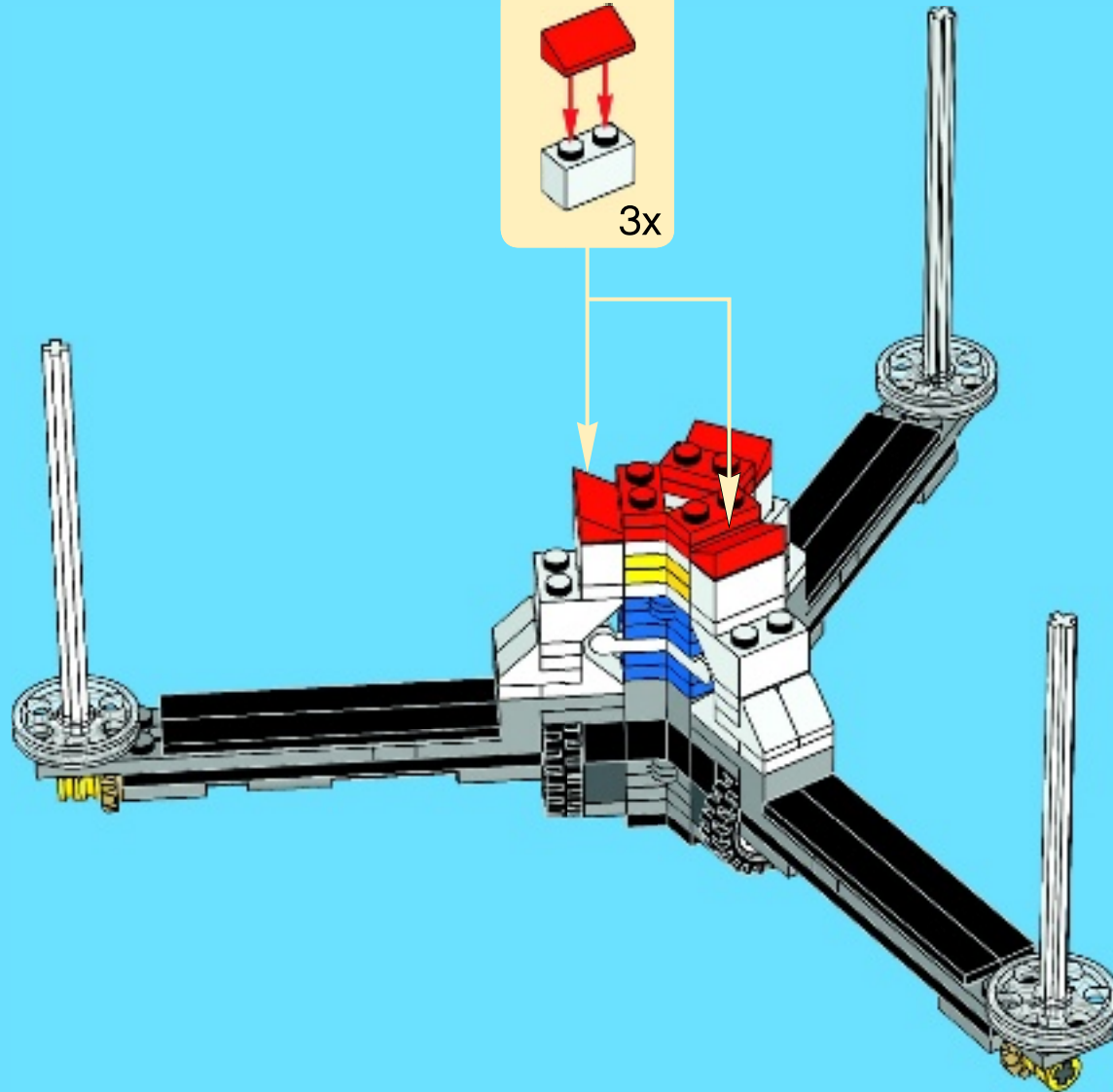

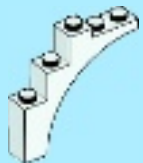

6x

22

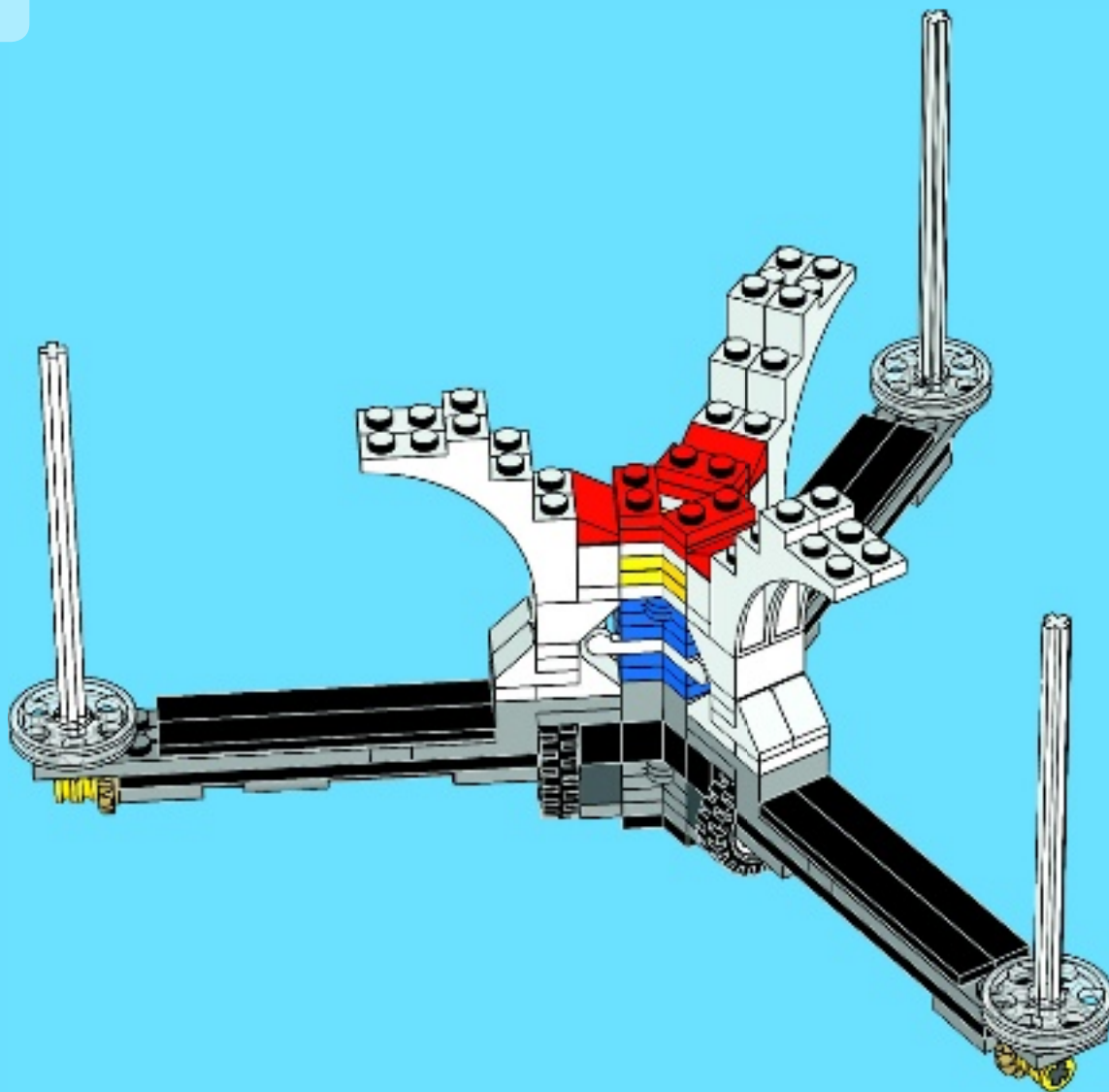



1x



2x



2x

23

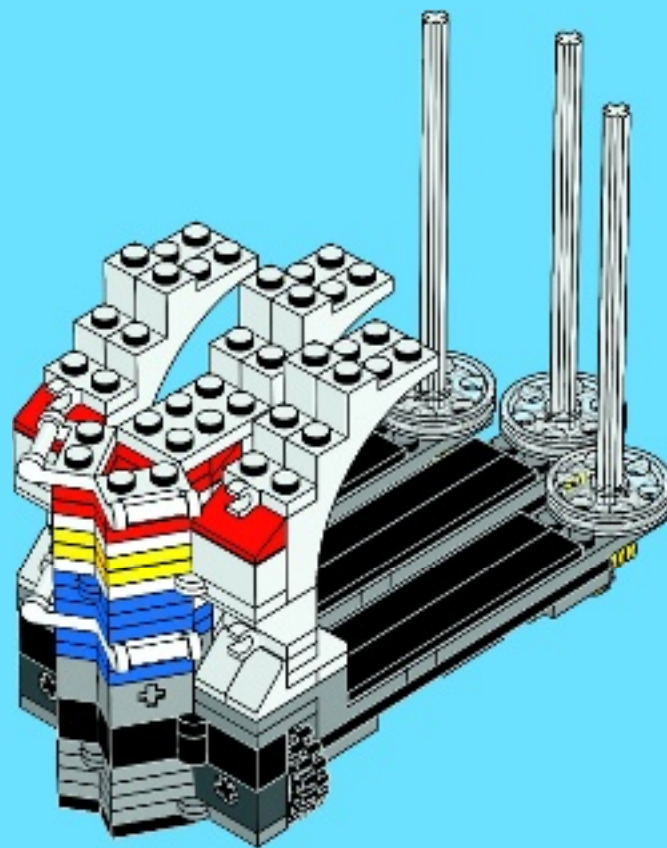



3x



3x

24

1



2



3

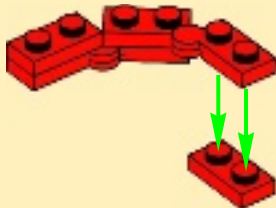

4



5

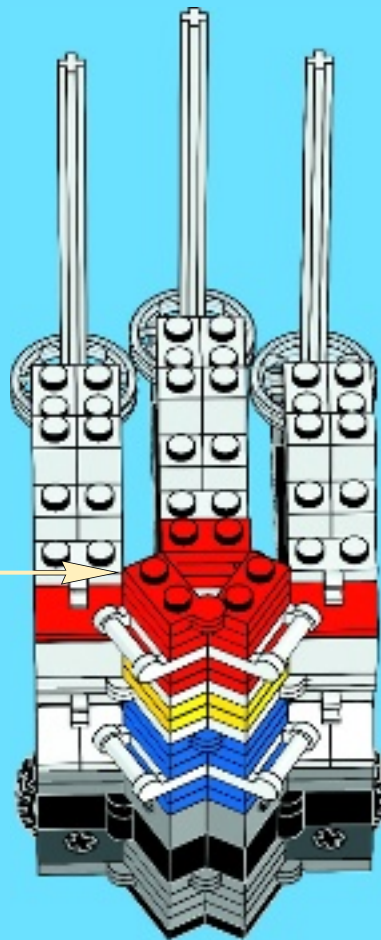



3x



3x

25

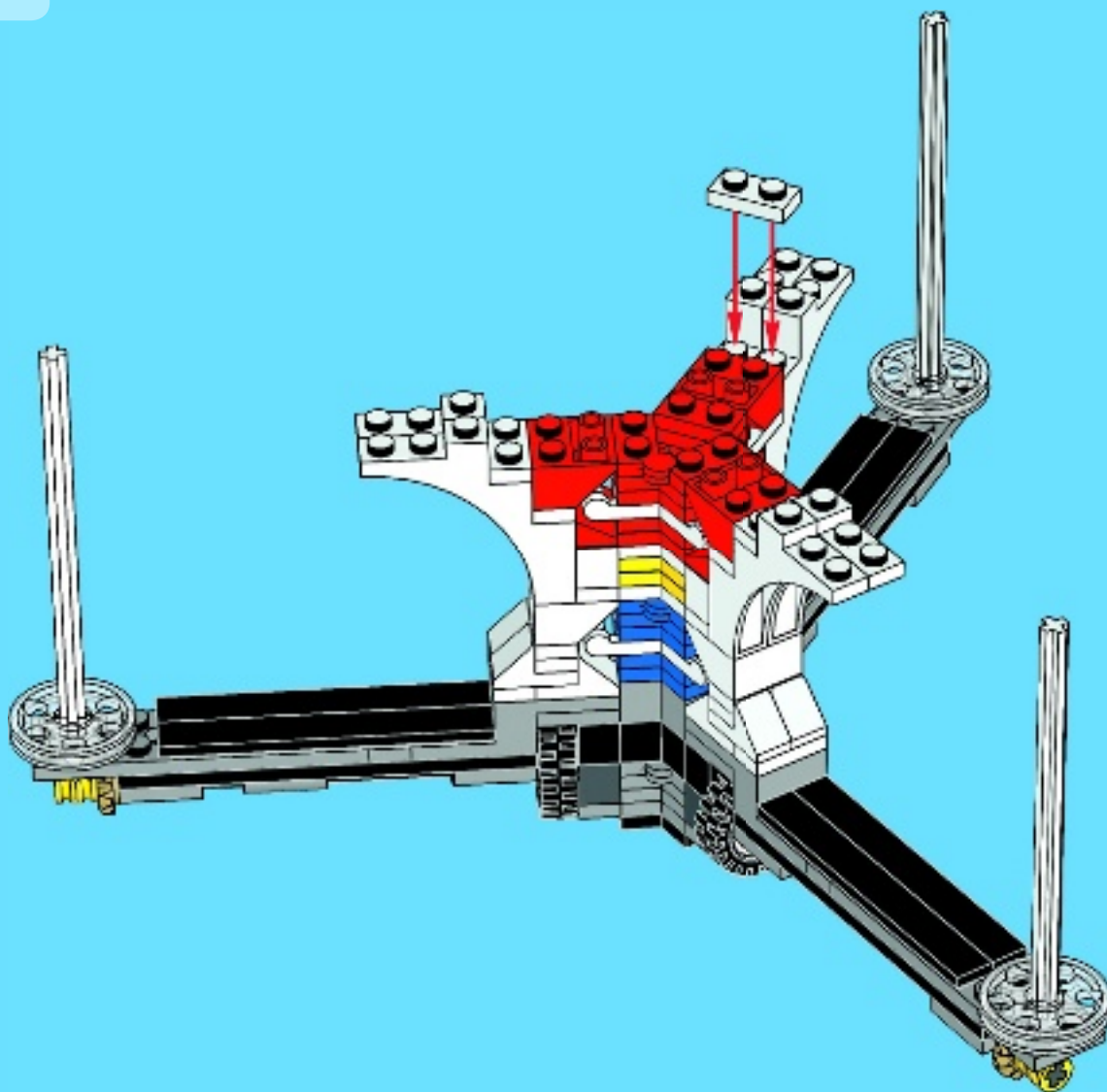



26

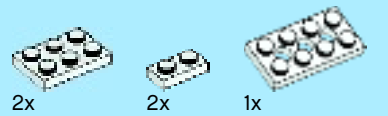
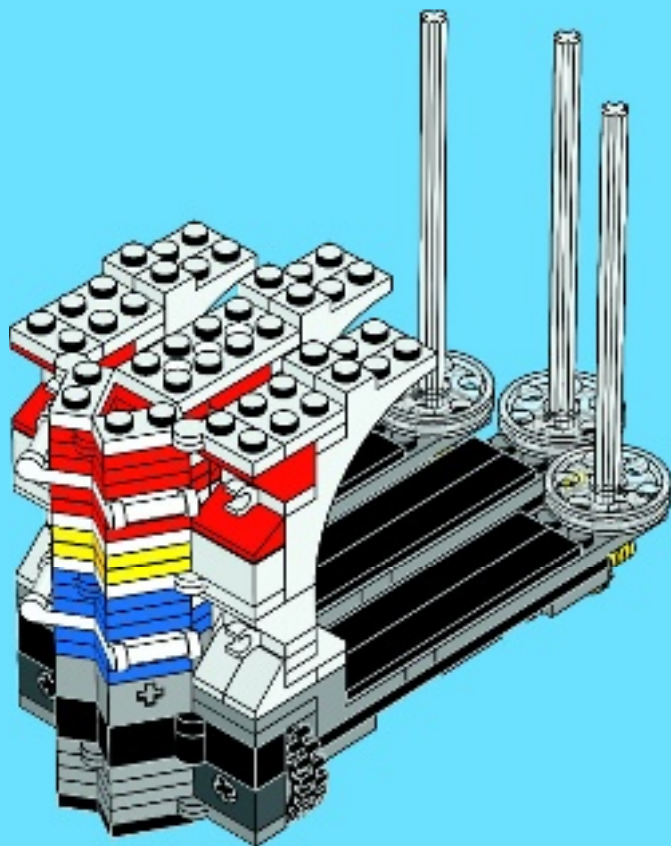

27

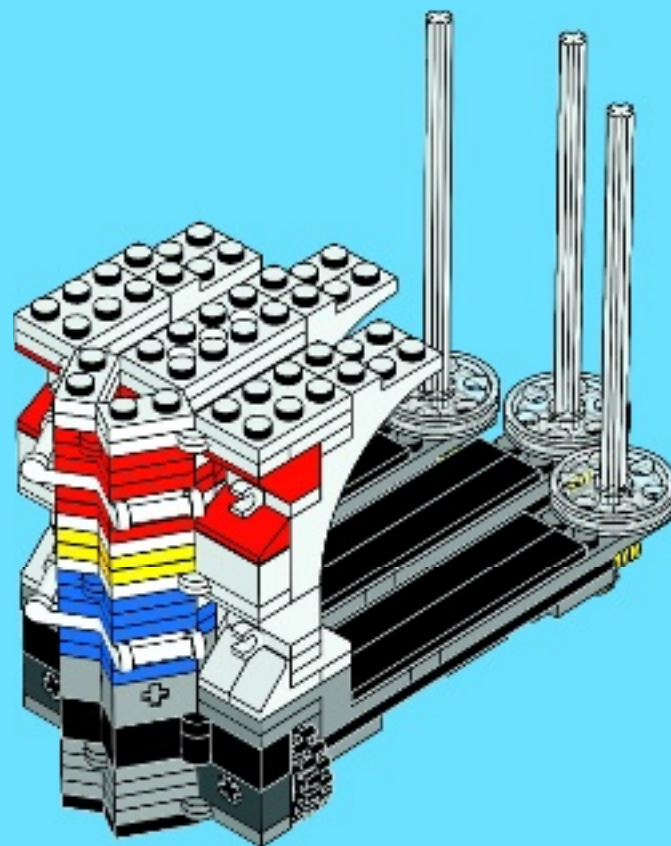



3x



3x



3x

28

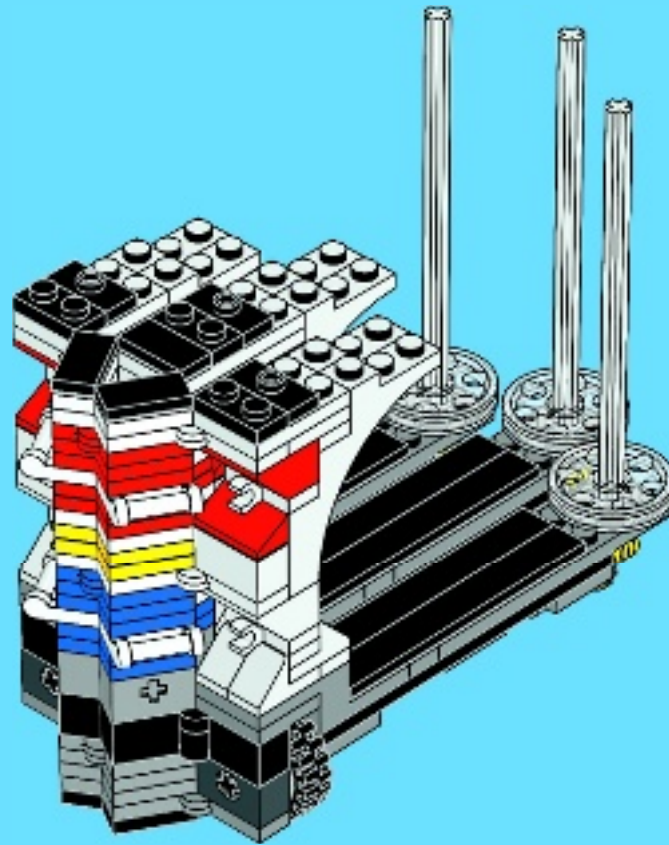



3x

29

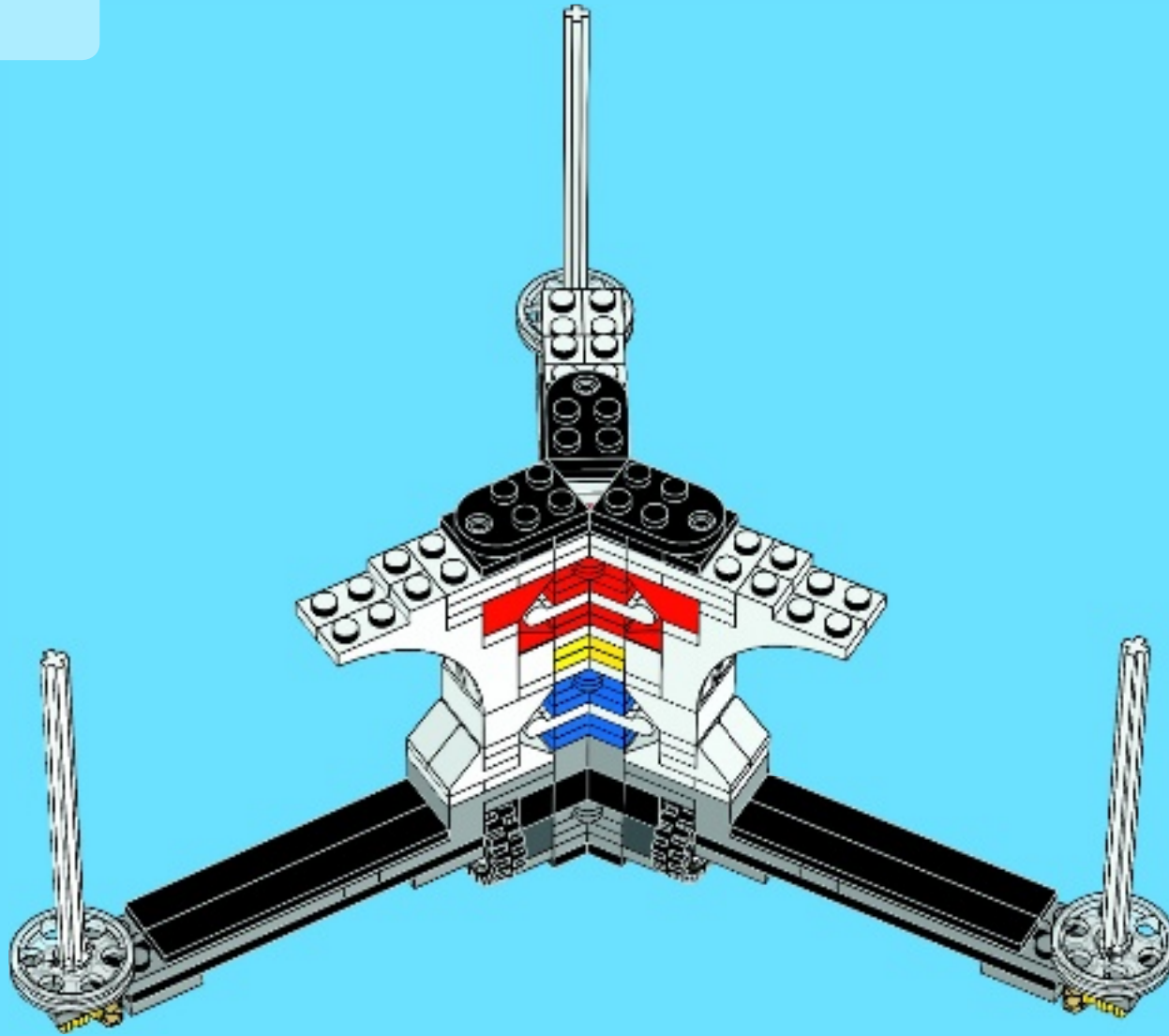

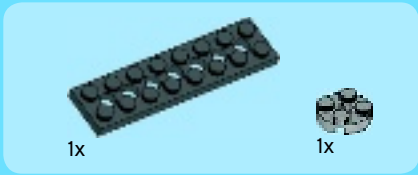

1

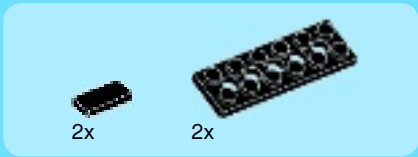
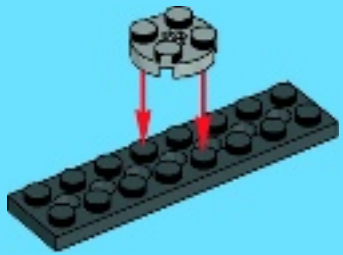

2

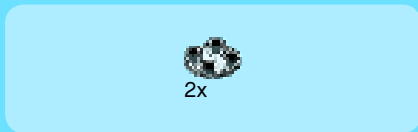
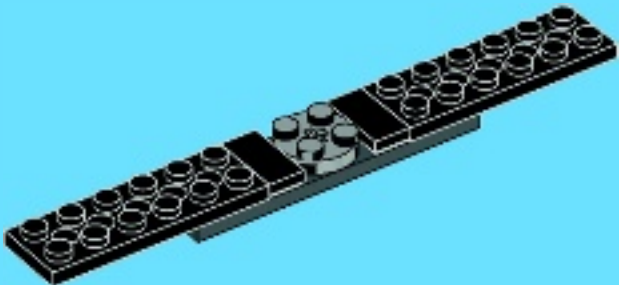

3

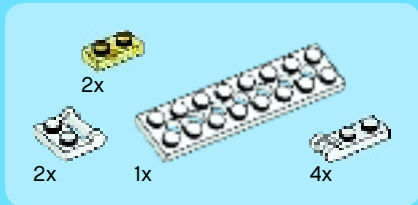

4

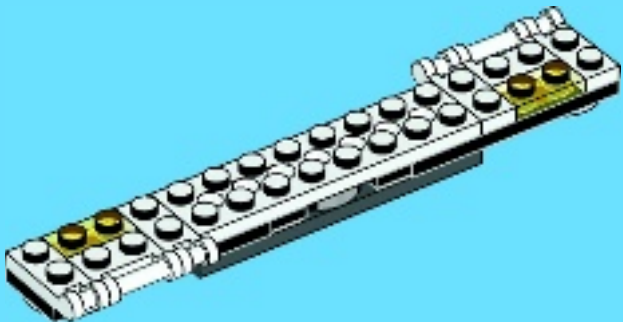



5

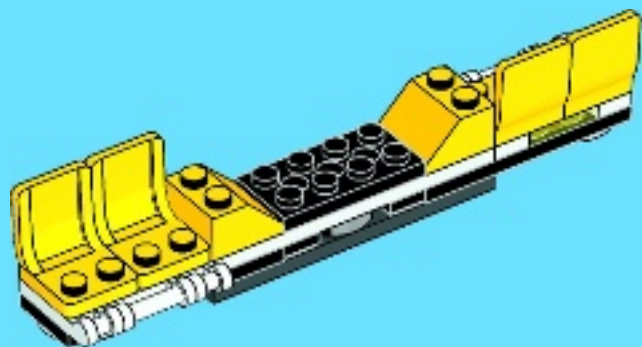

6

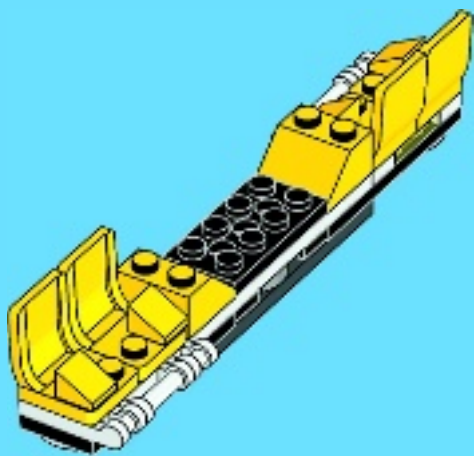

7

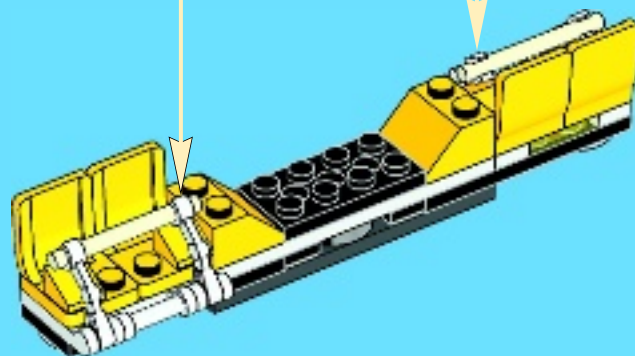
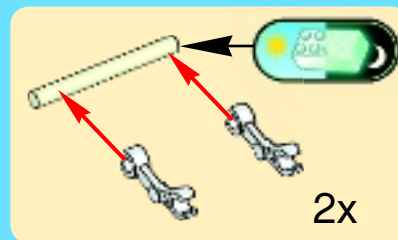

8

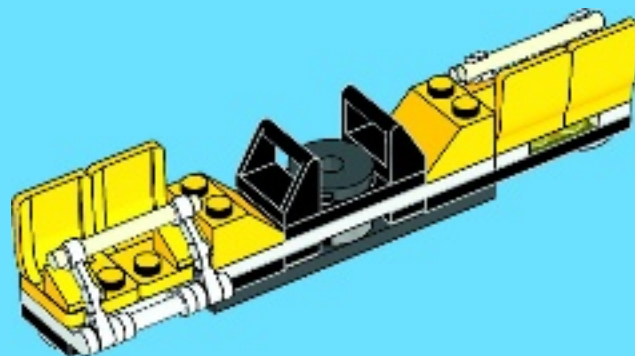

30

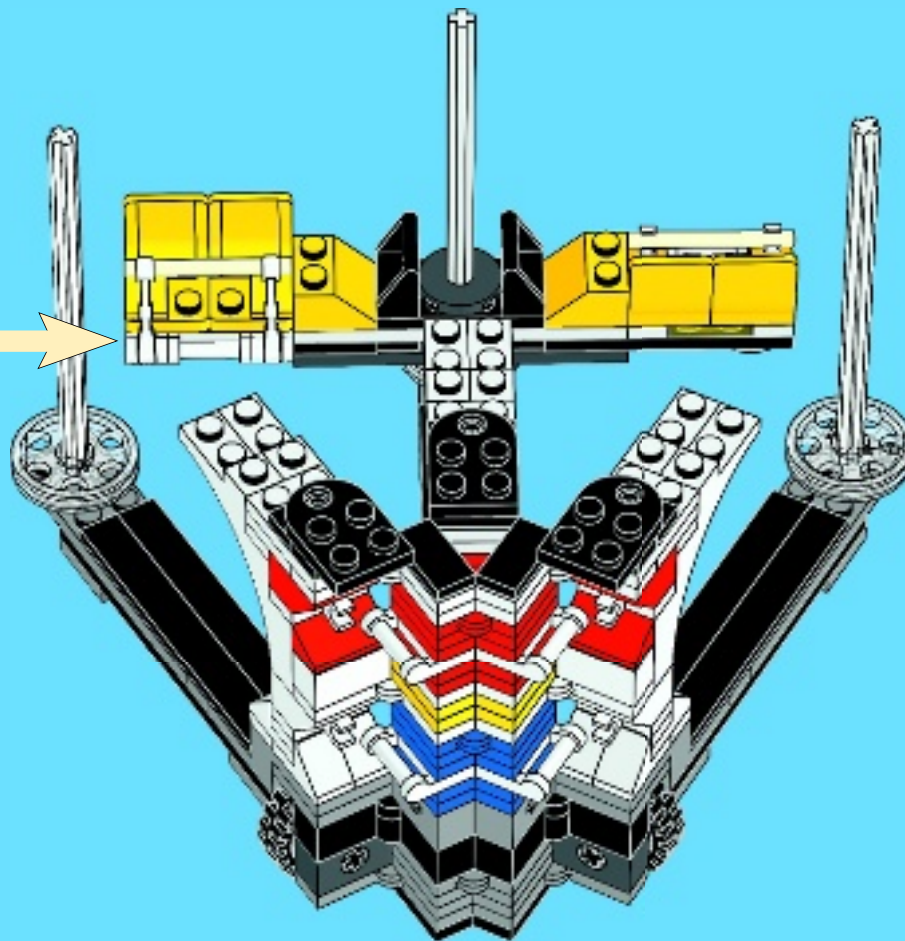

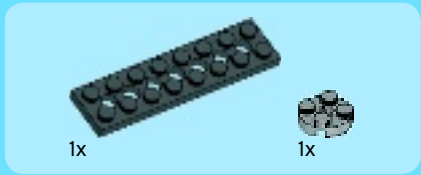

1

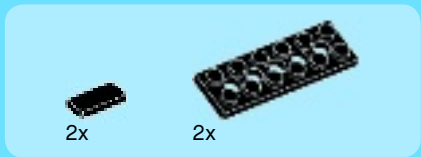

2

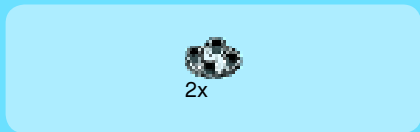
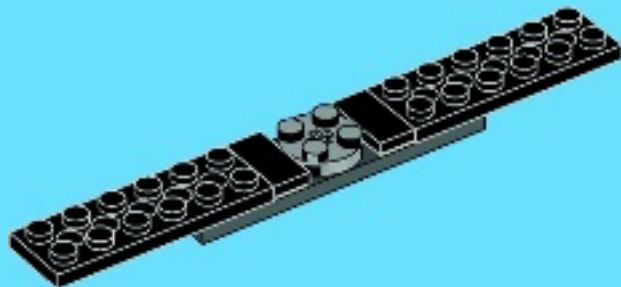

3

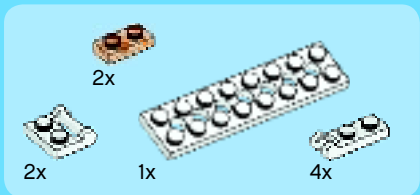

4





5

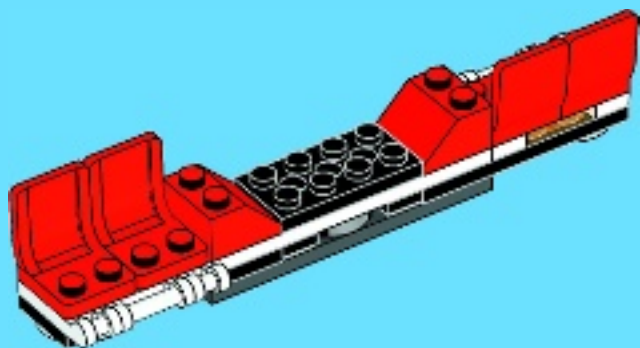

6

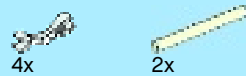
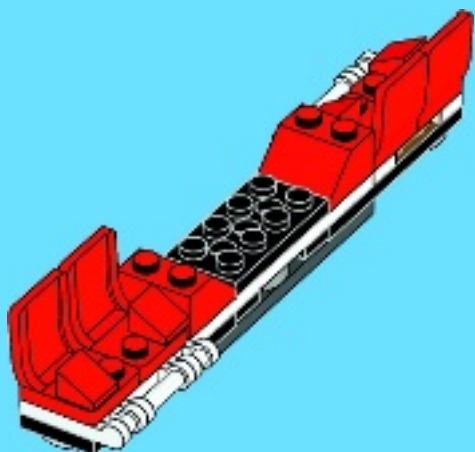

7

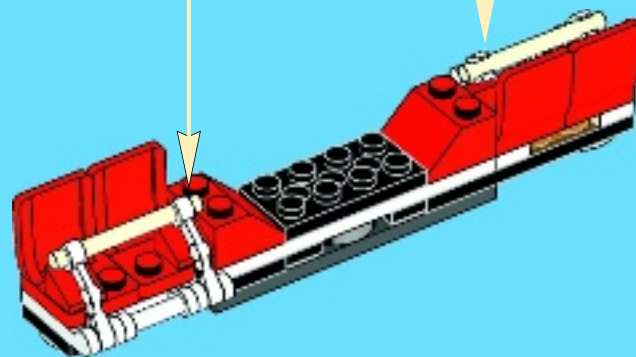
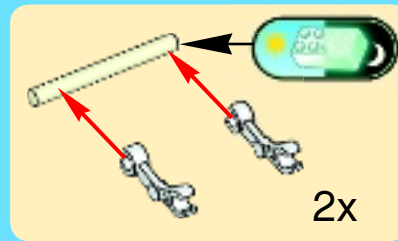

8

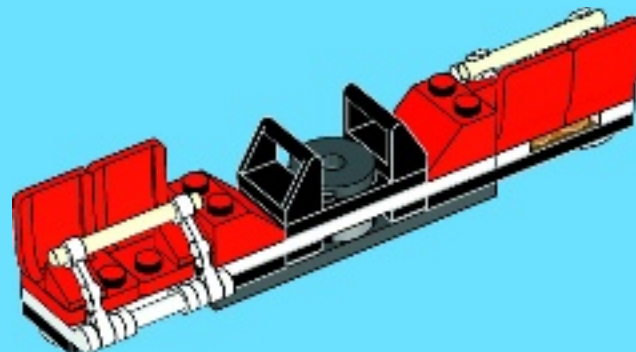

31

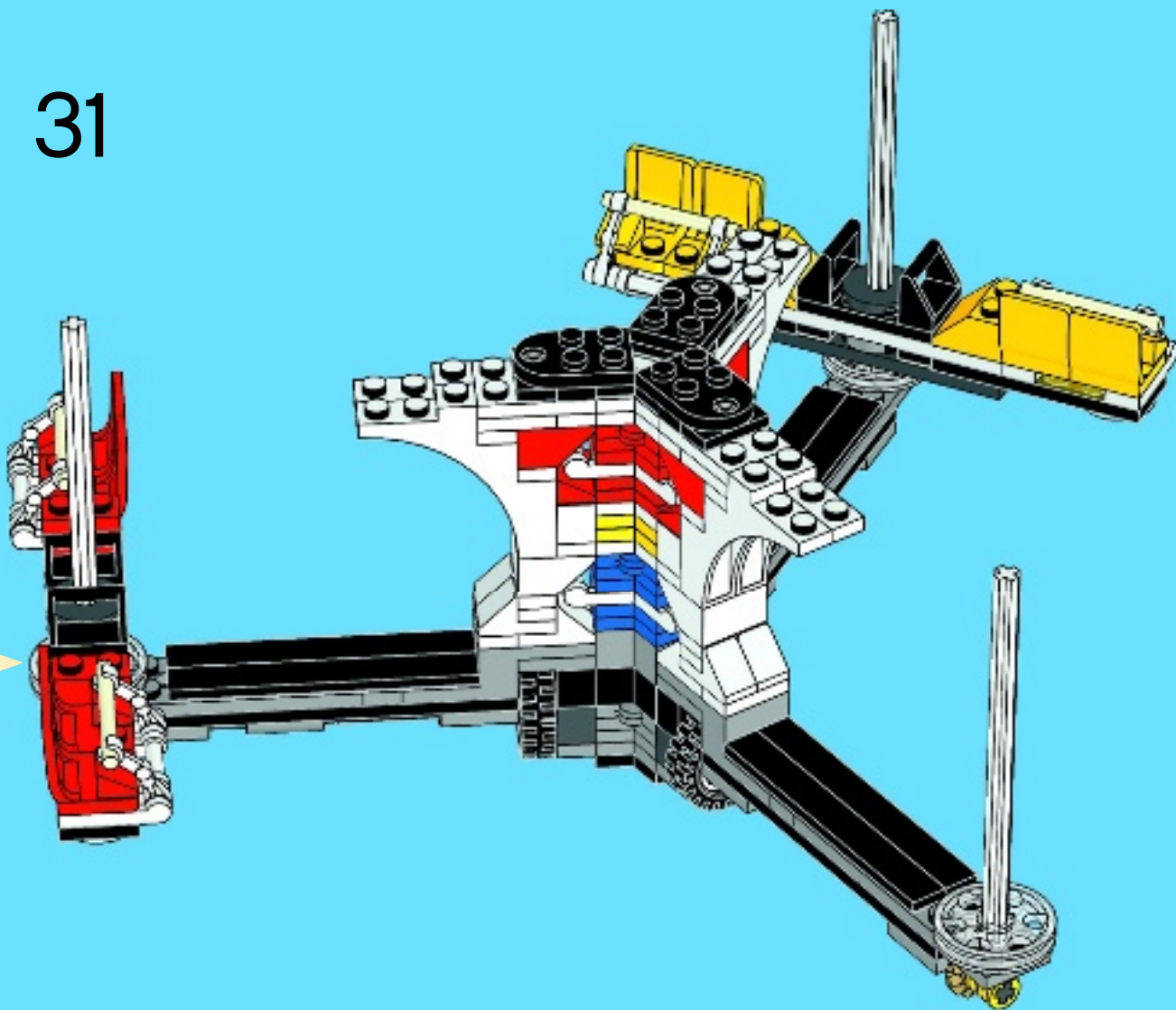



1

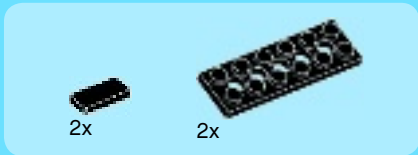
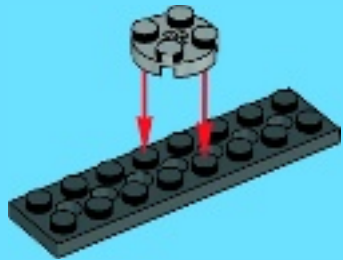

2

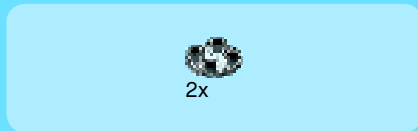
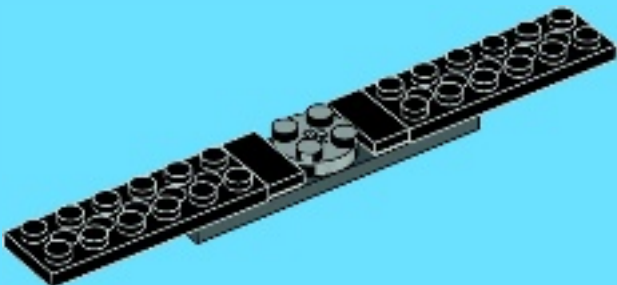

3

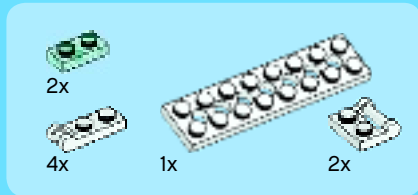

4

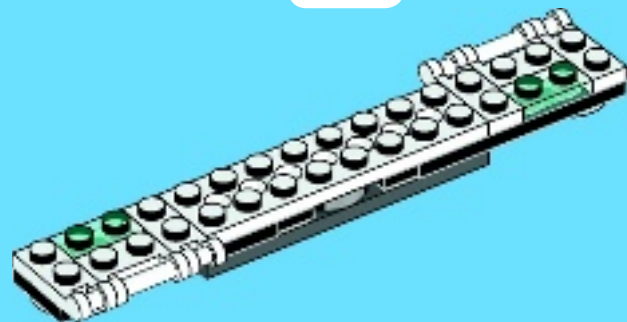



5

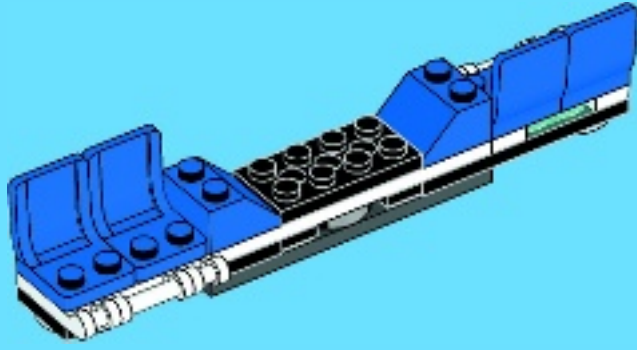

6

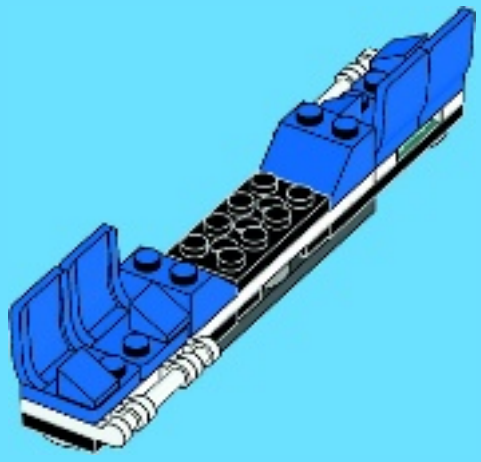

7

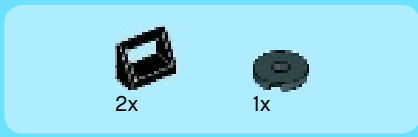
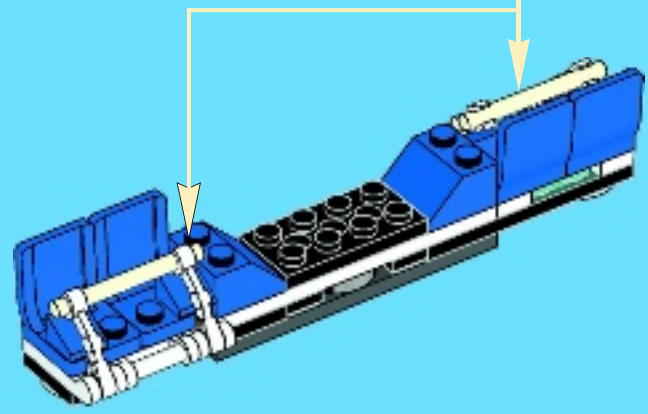
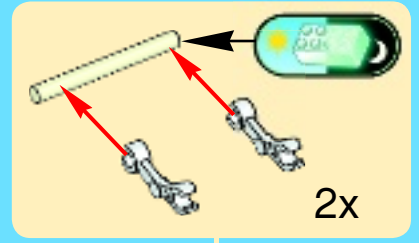

8

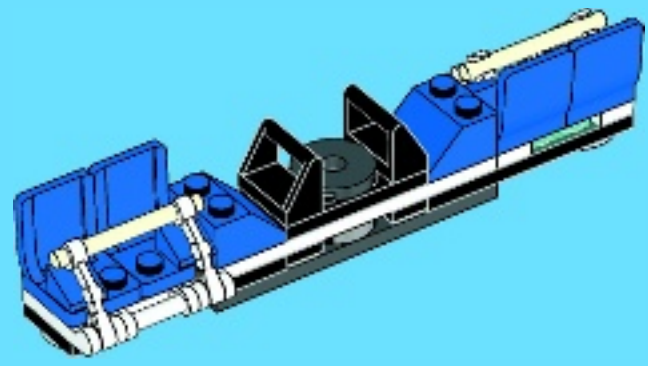

32

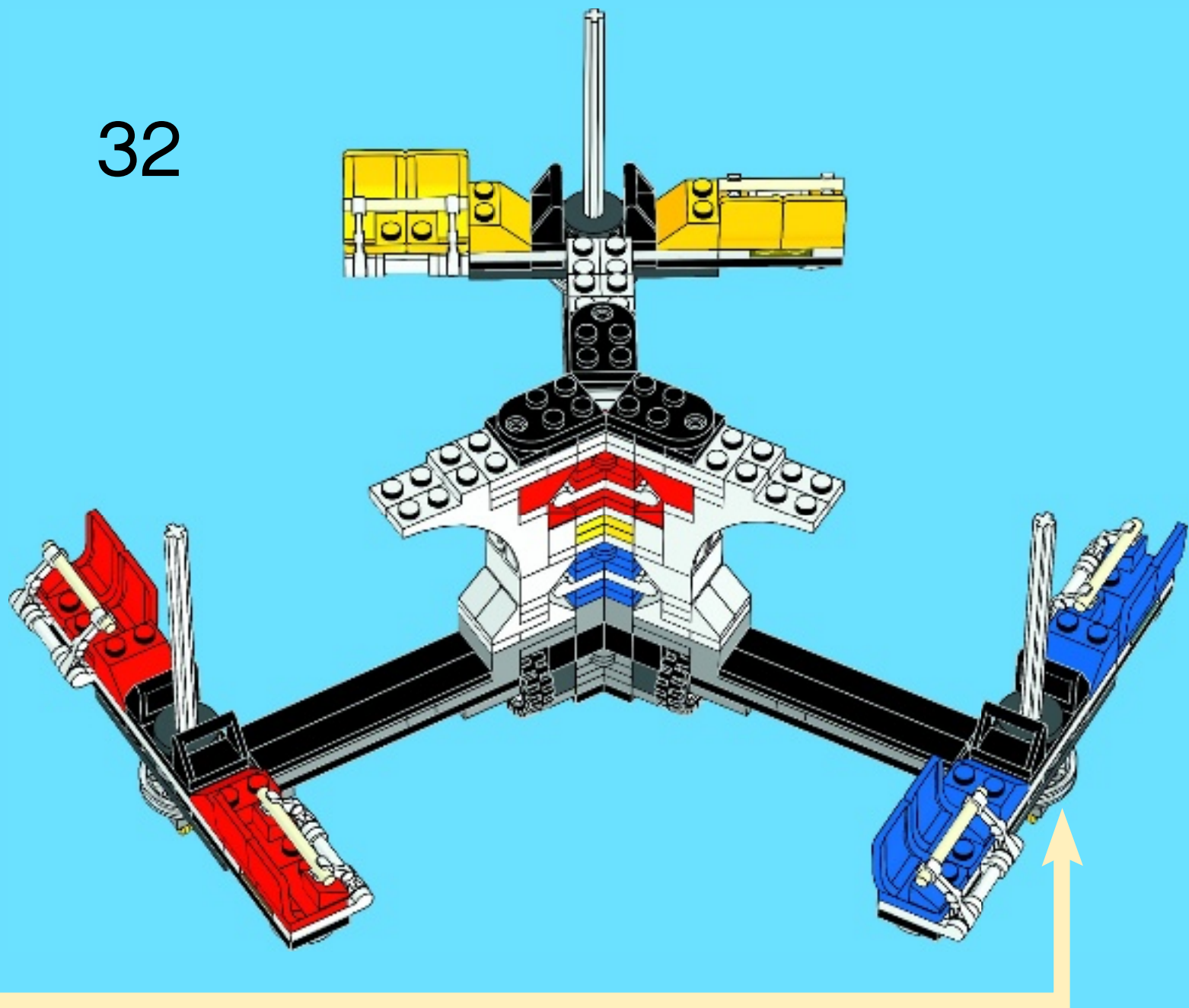



1x

1



2x

2

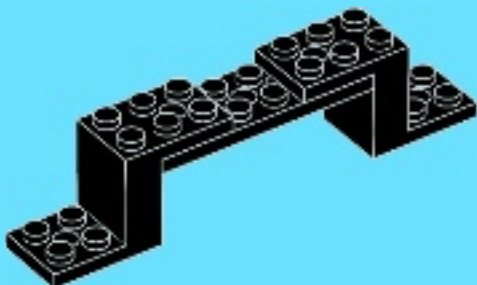

1x

3

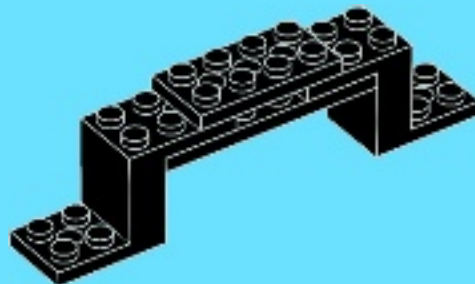



2x

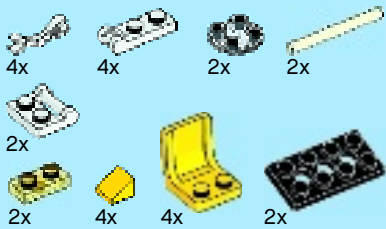

4

1



2



3



4



5

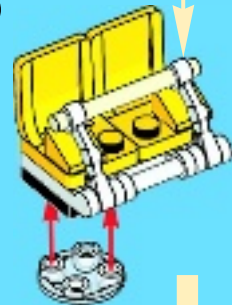

2x

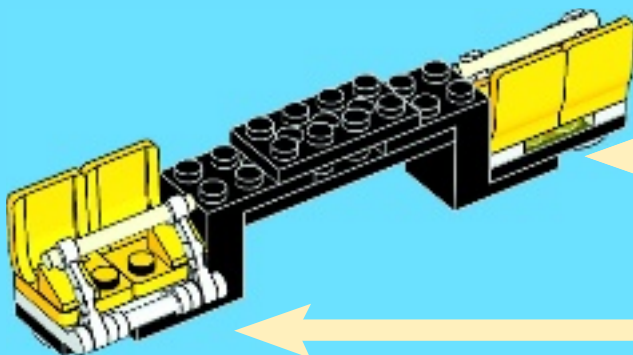
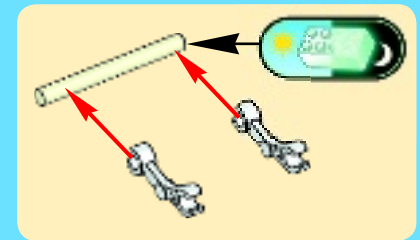

33

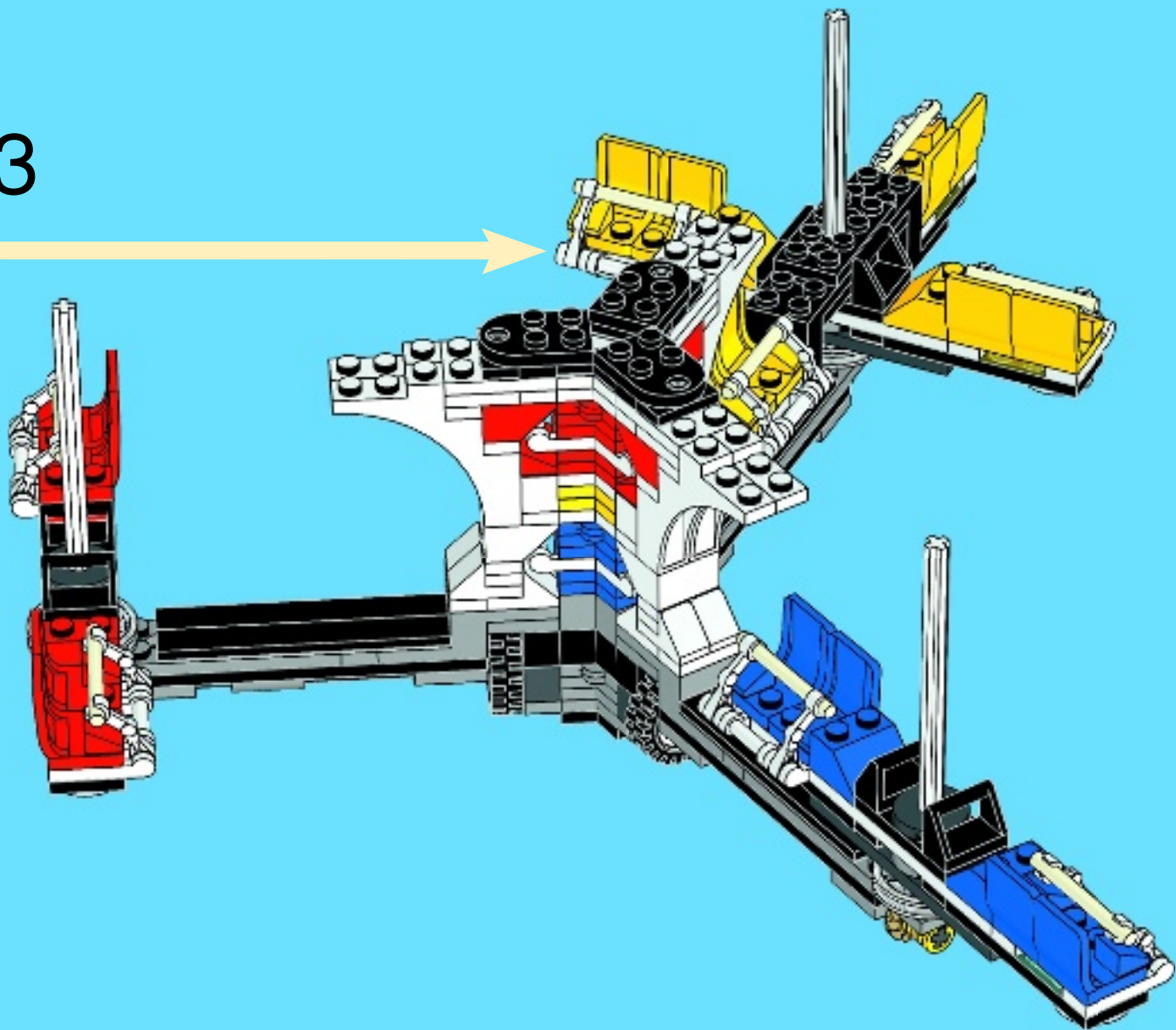



1

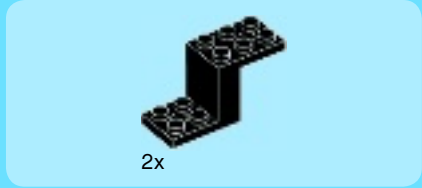

2

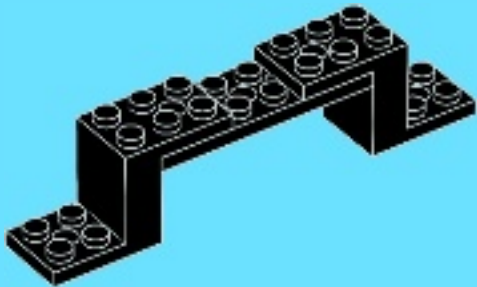

3

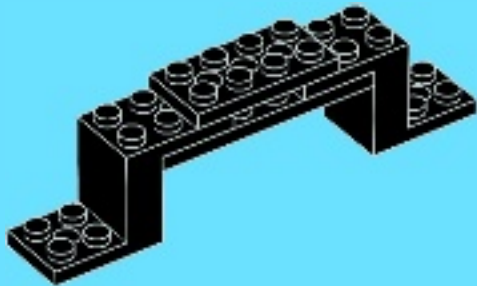



2x

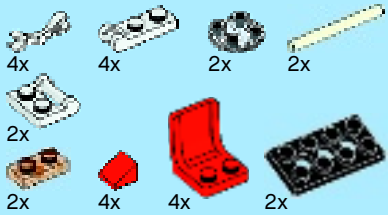

4

1



2



3



4



5

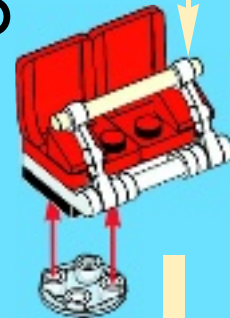

2x

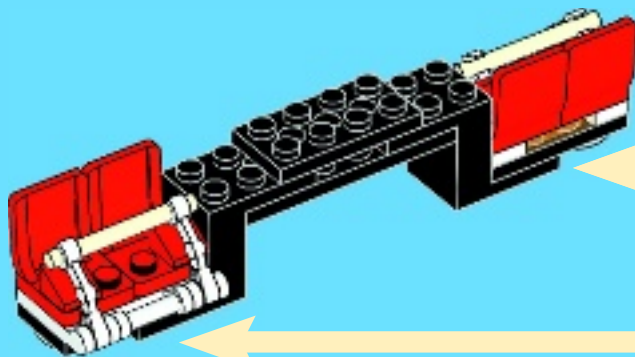
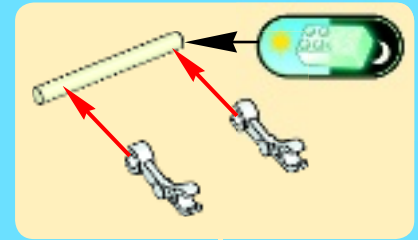

34

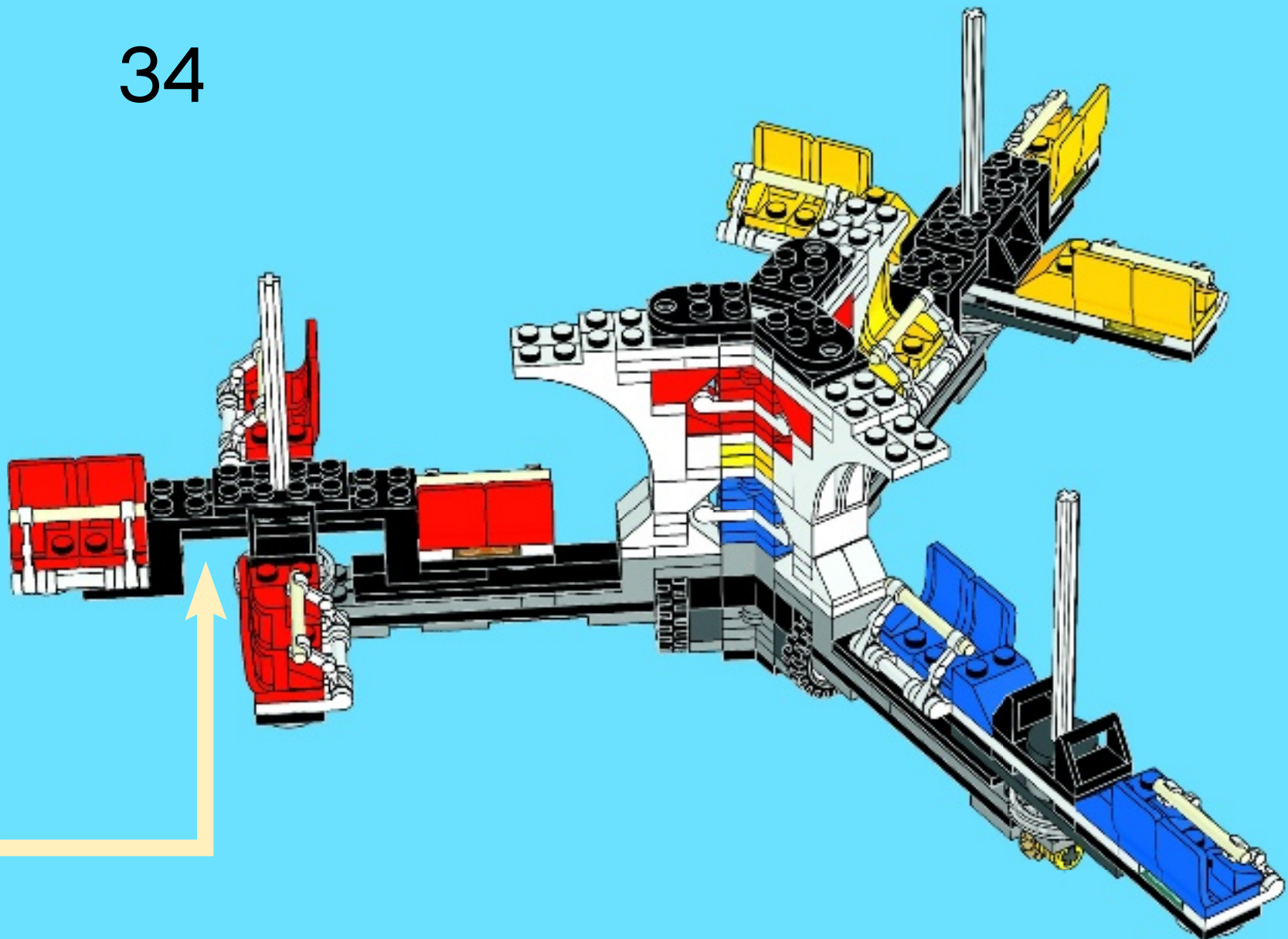



1x

1

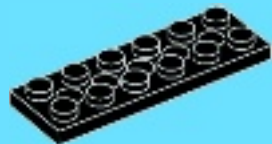

2x

2

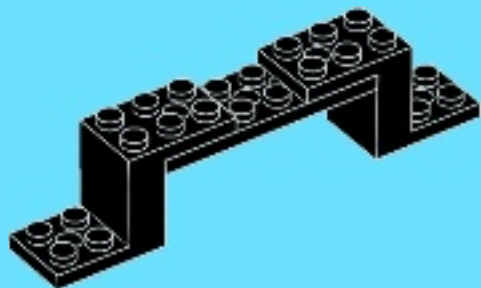

1x

3

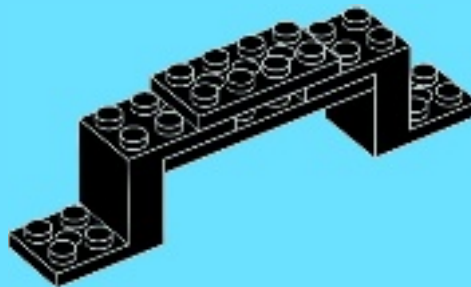

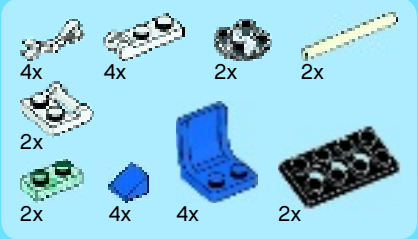

4

1



2



3



4



5

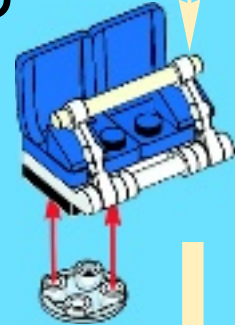

2x

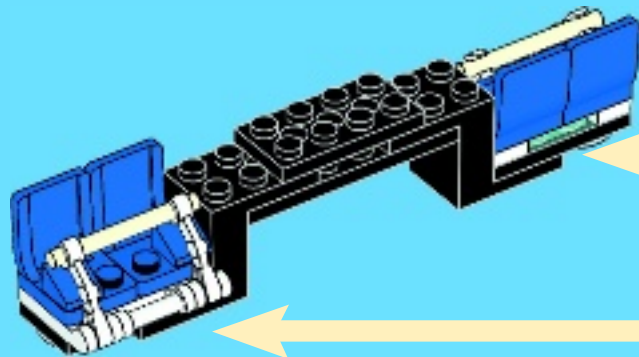
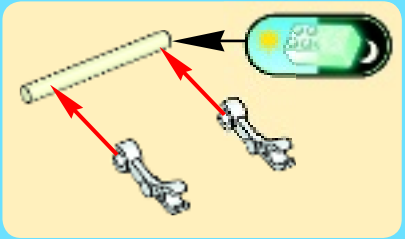

35

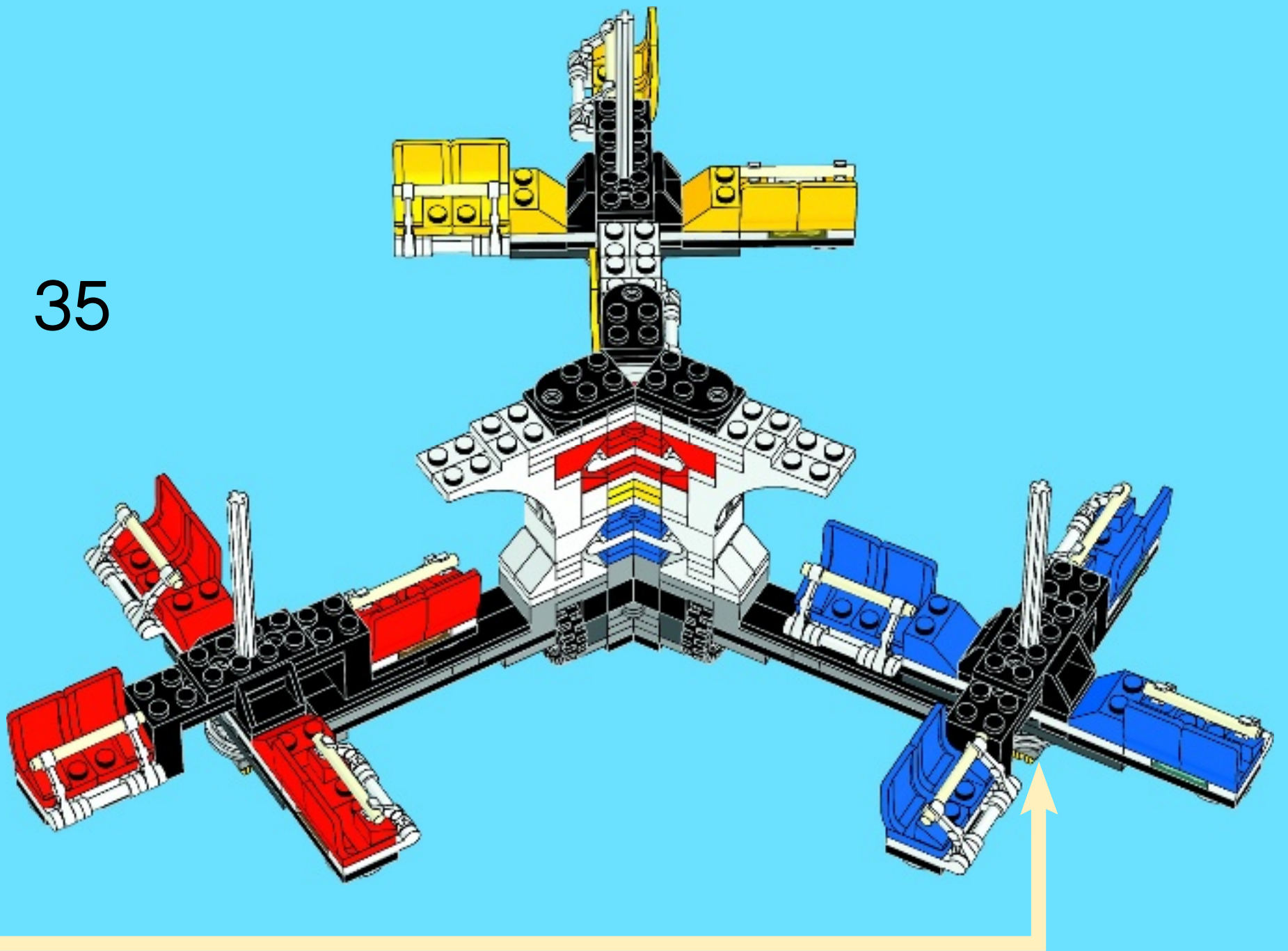

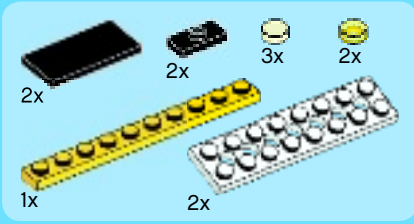

36

1

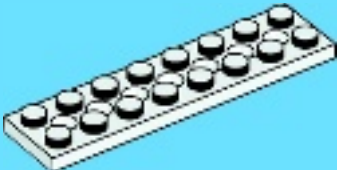

2

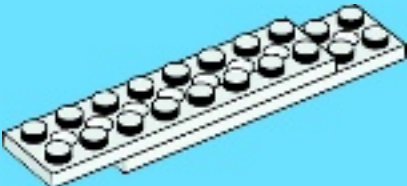

3

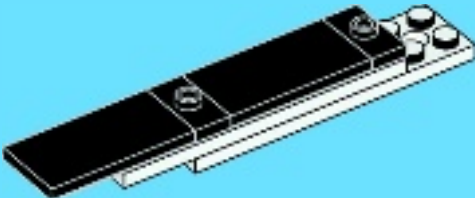

4

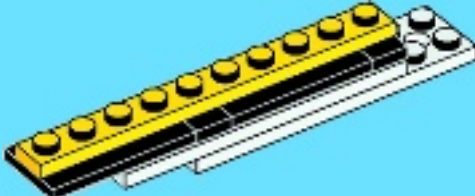

5

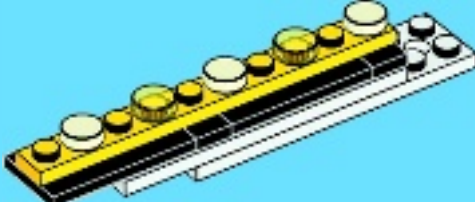

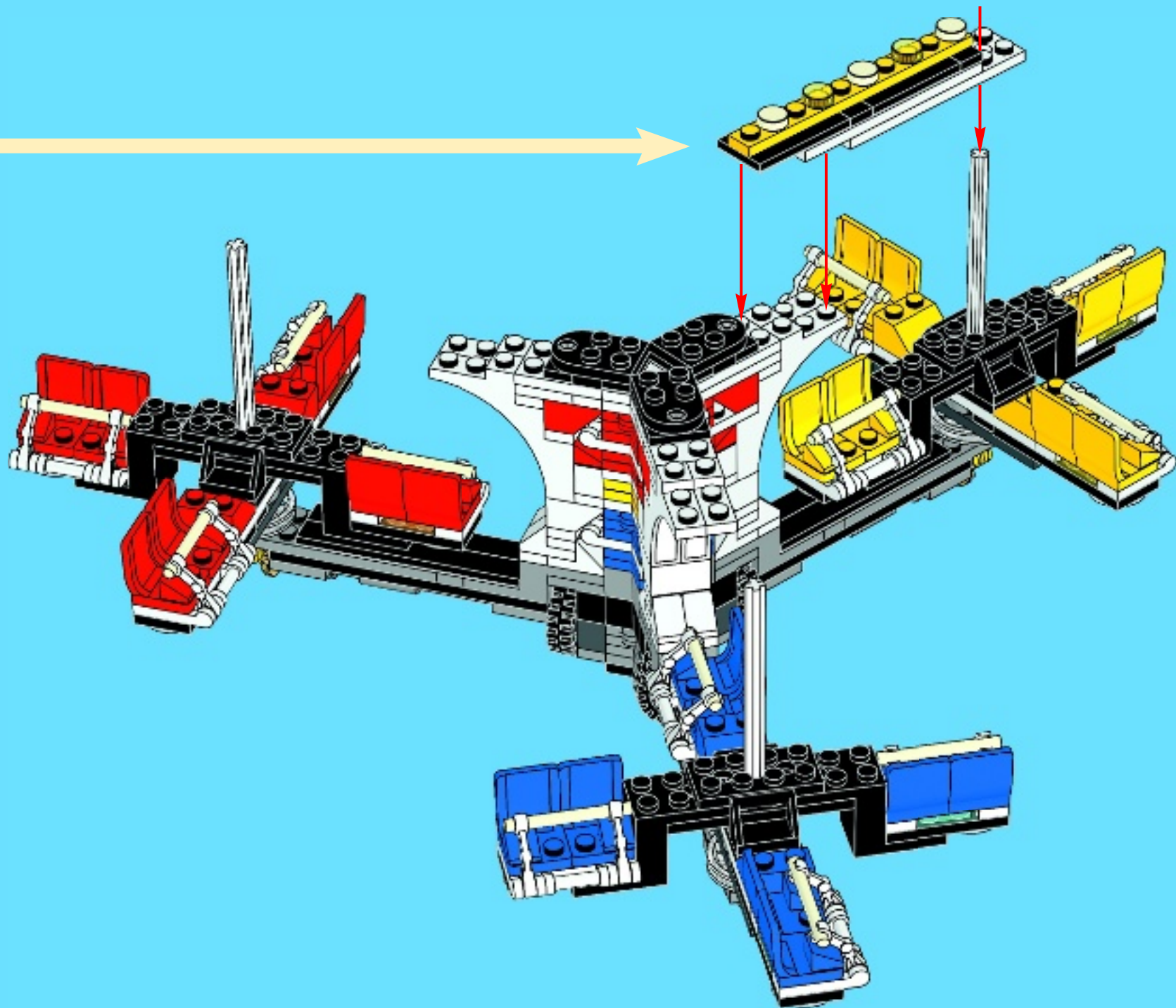

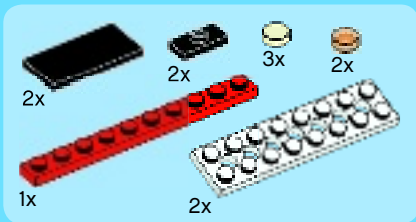

37

1

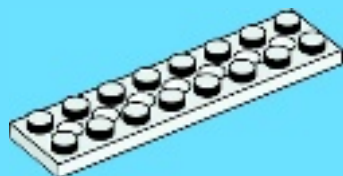

2

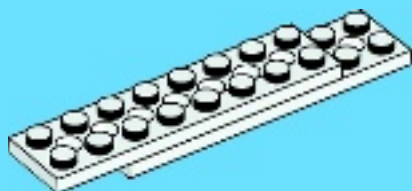

3

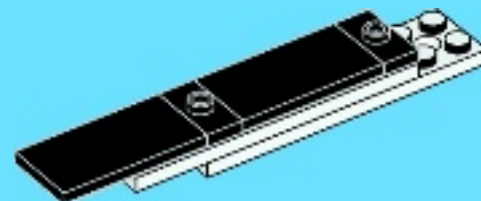

4

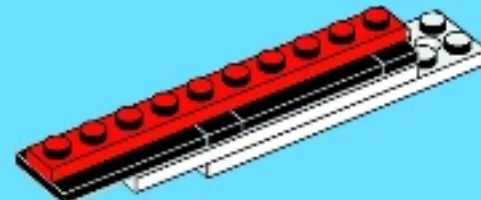

5

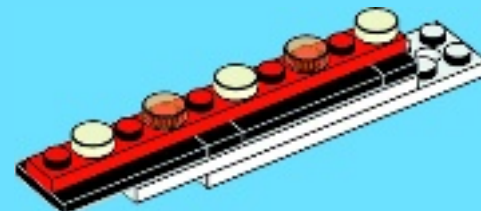

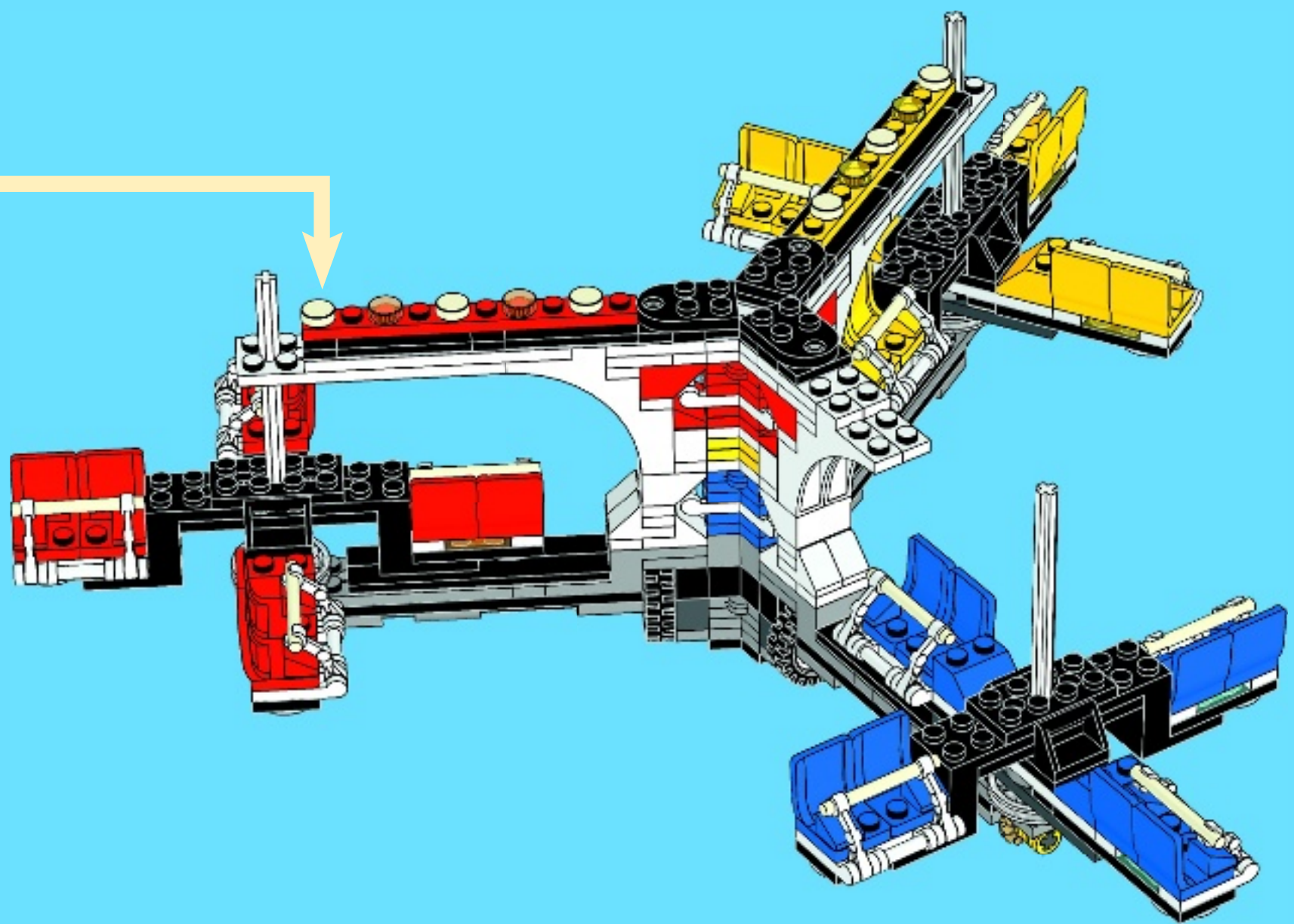

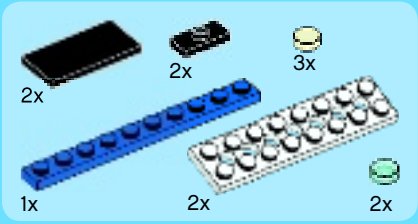

38

1



2

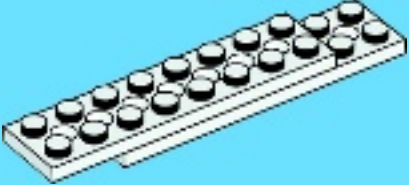

3

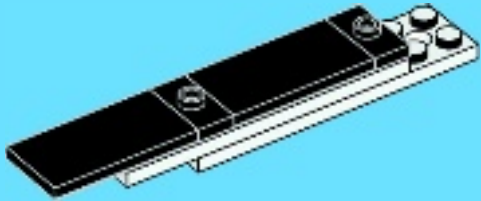

4

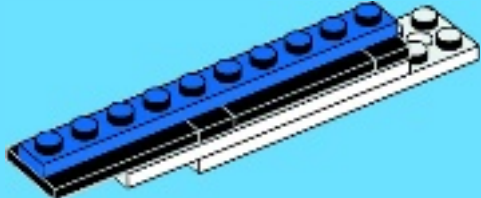

5

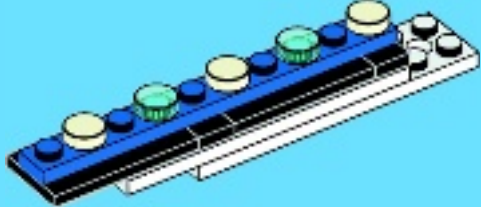

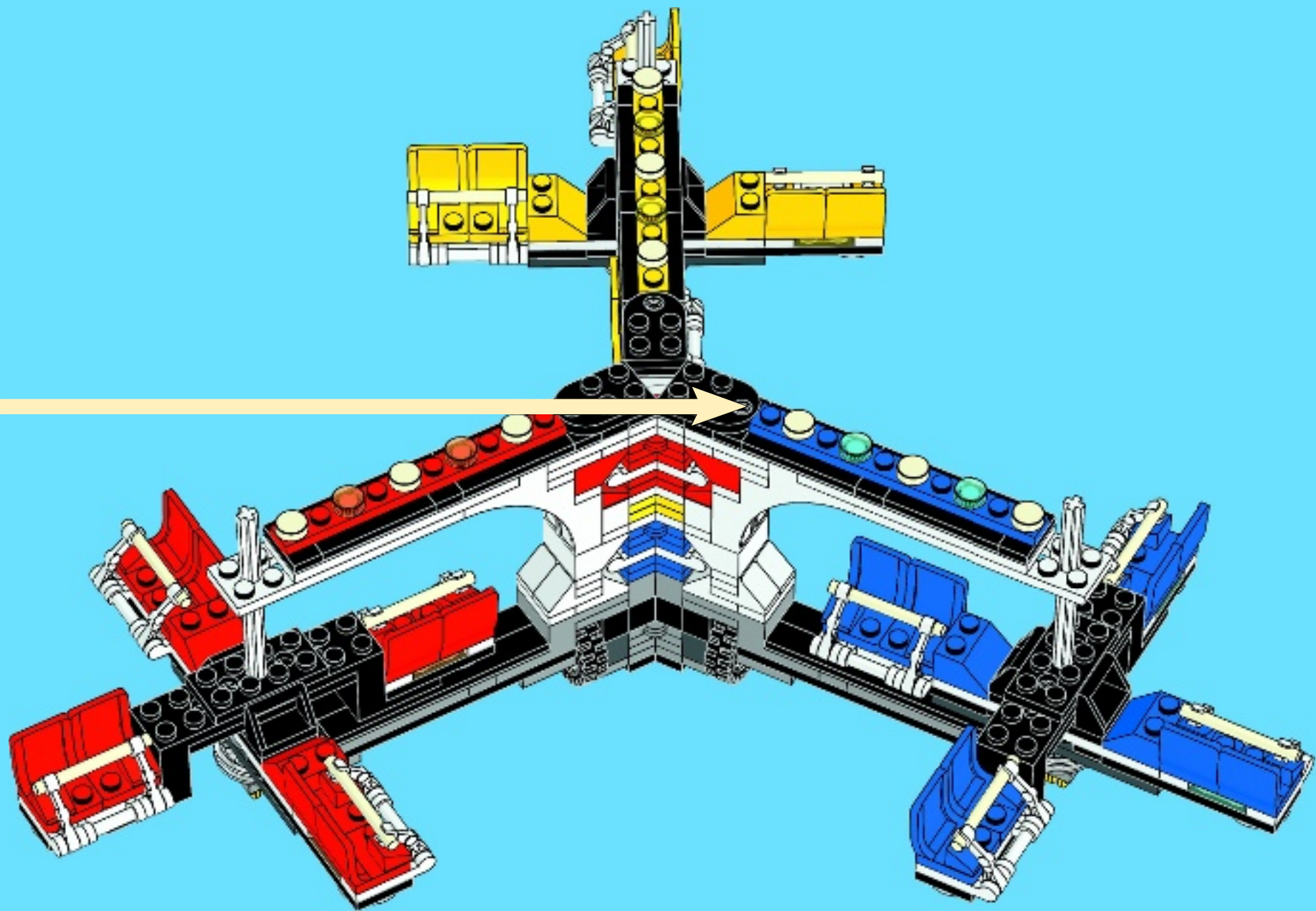



3x



3x



1x



1x



1x

39

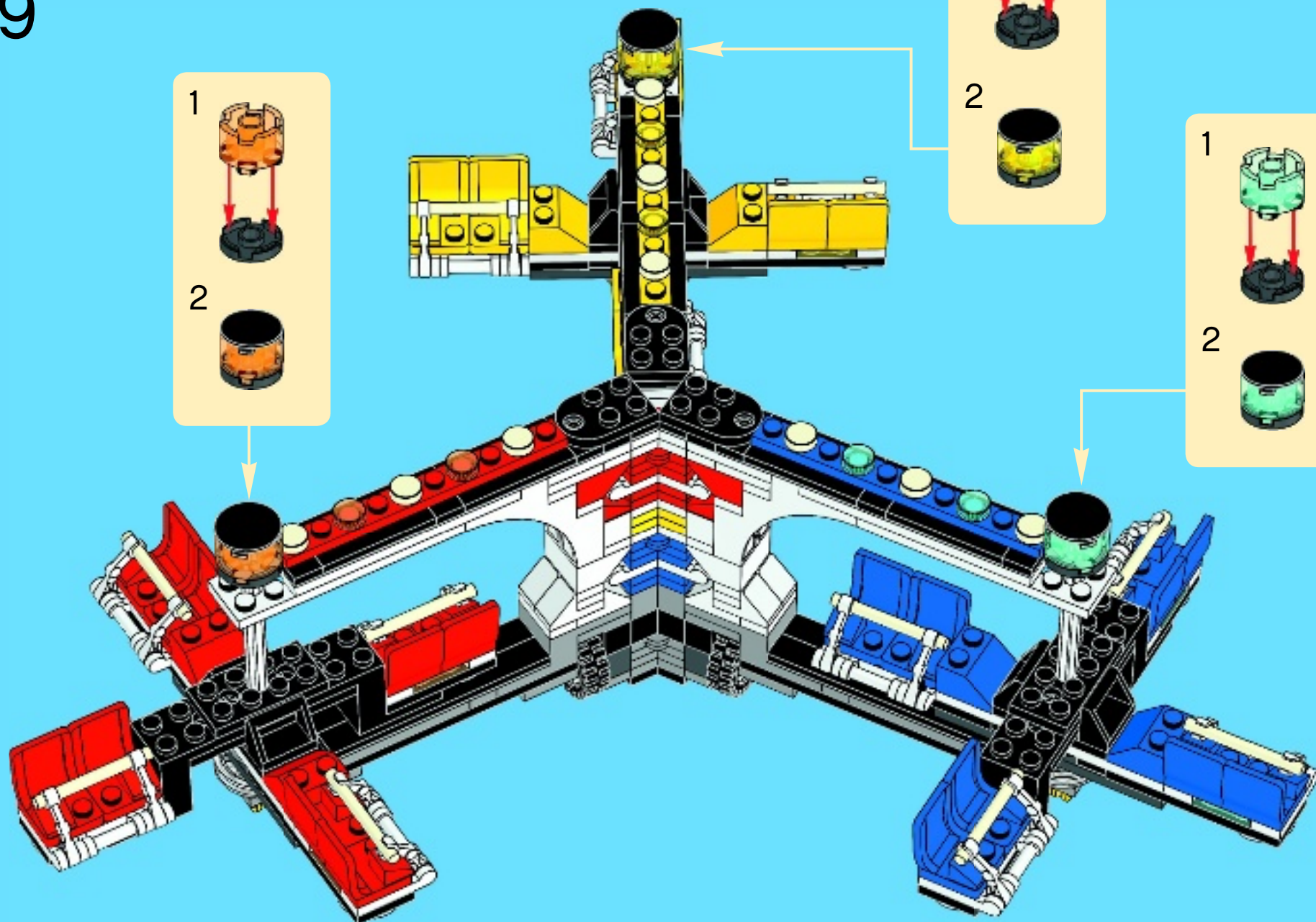



3x



3x

40

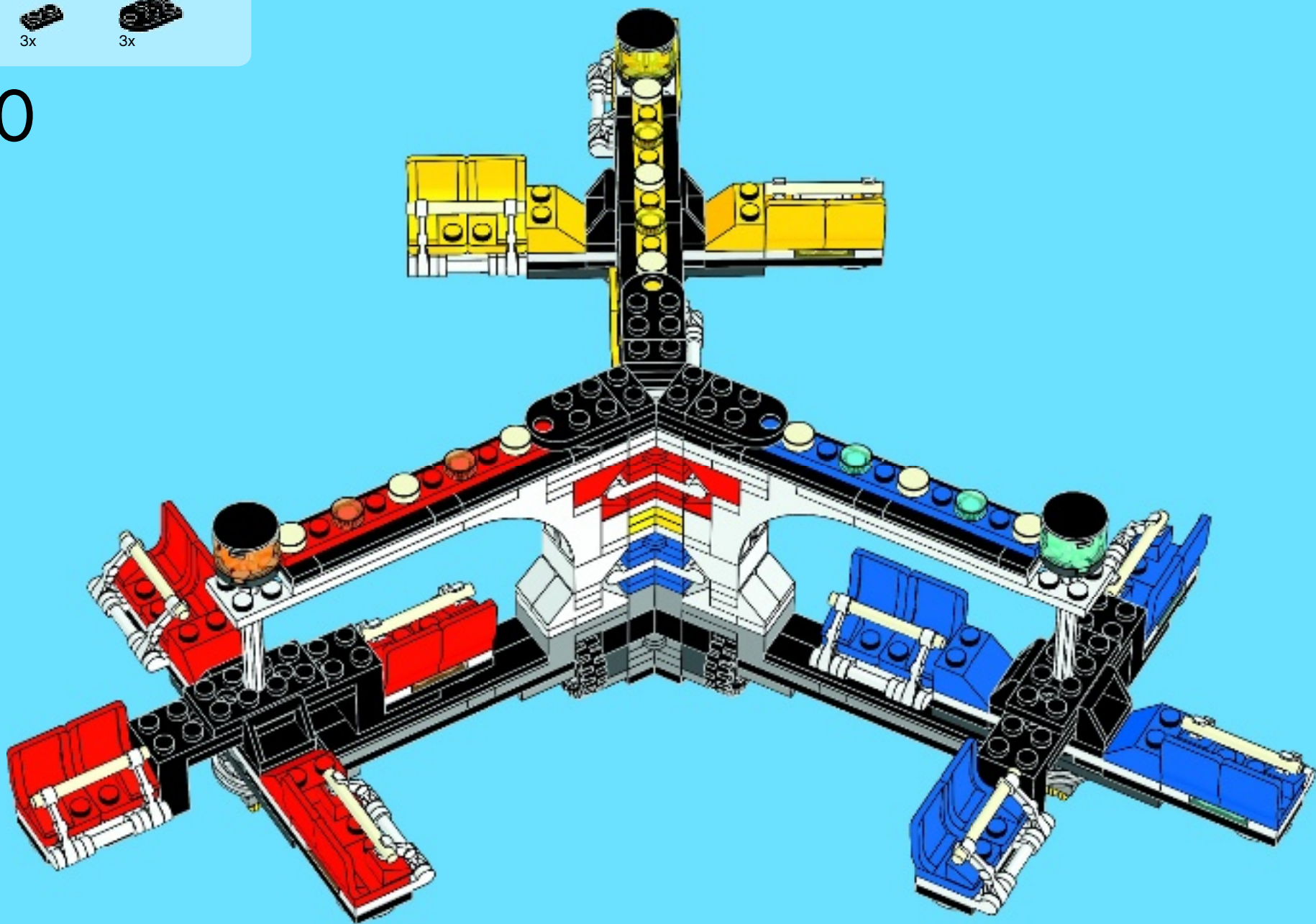



3x

41

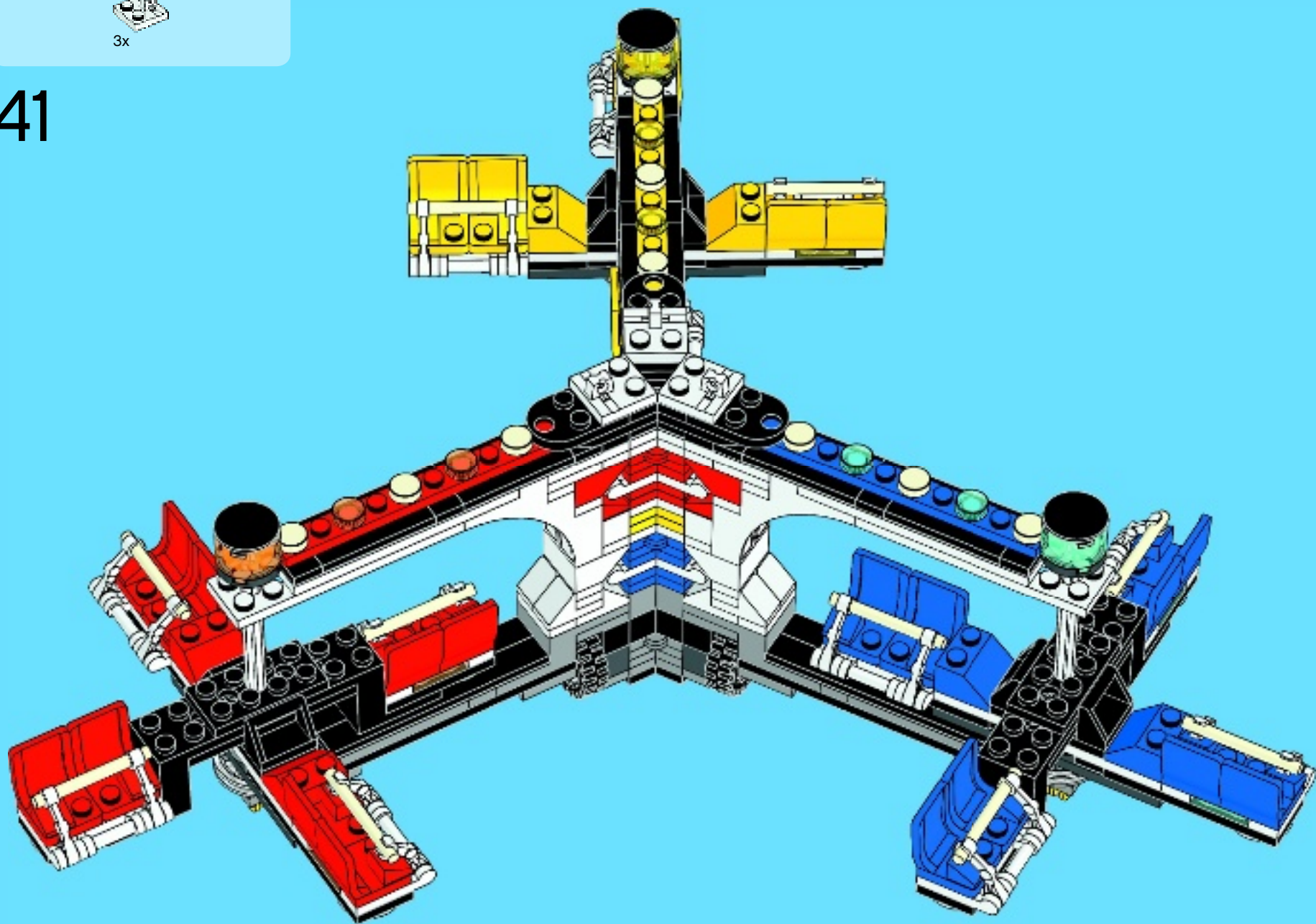

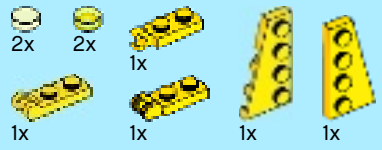

42

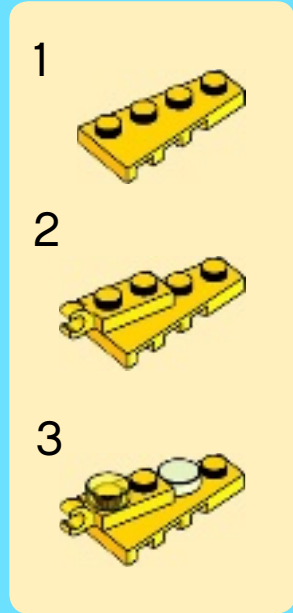
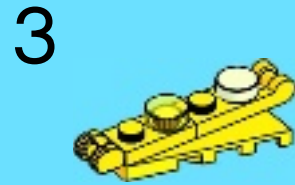
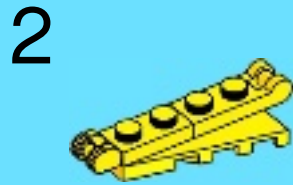
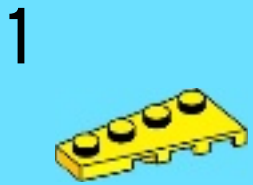

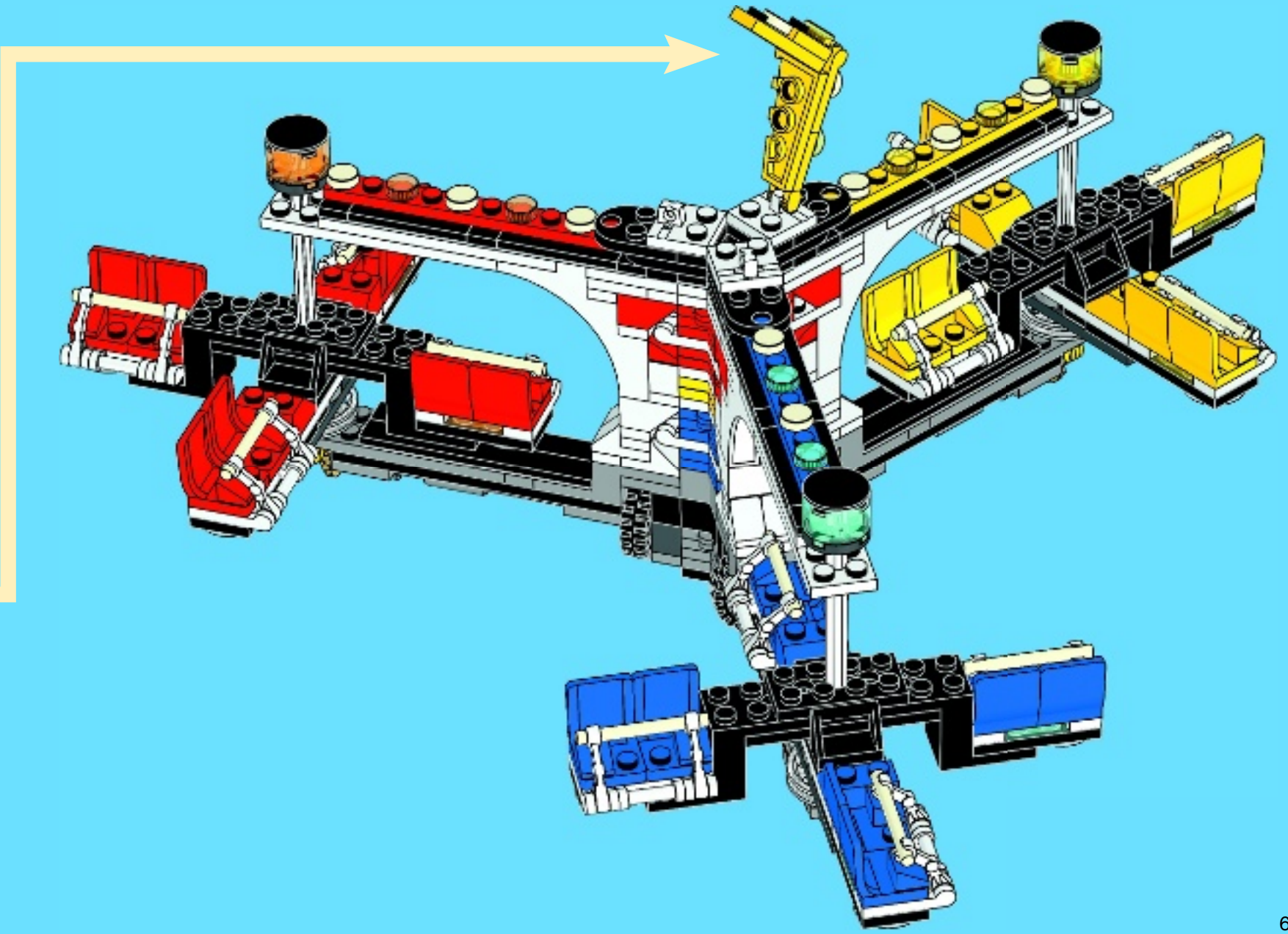

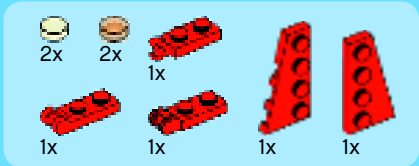

43

1



2



3

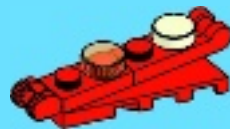

4

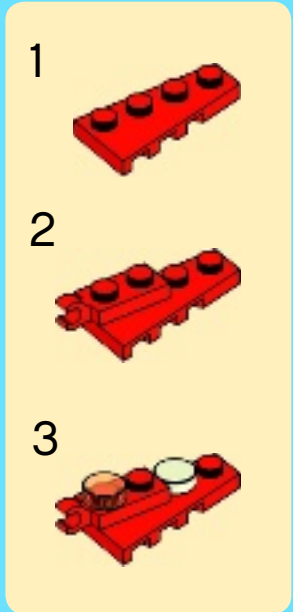

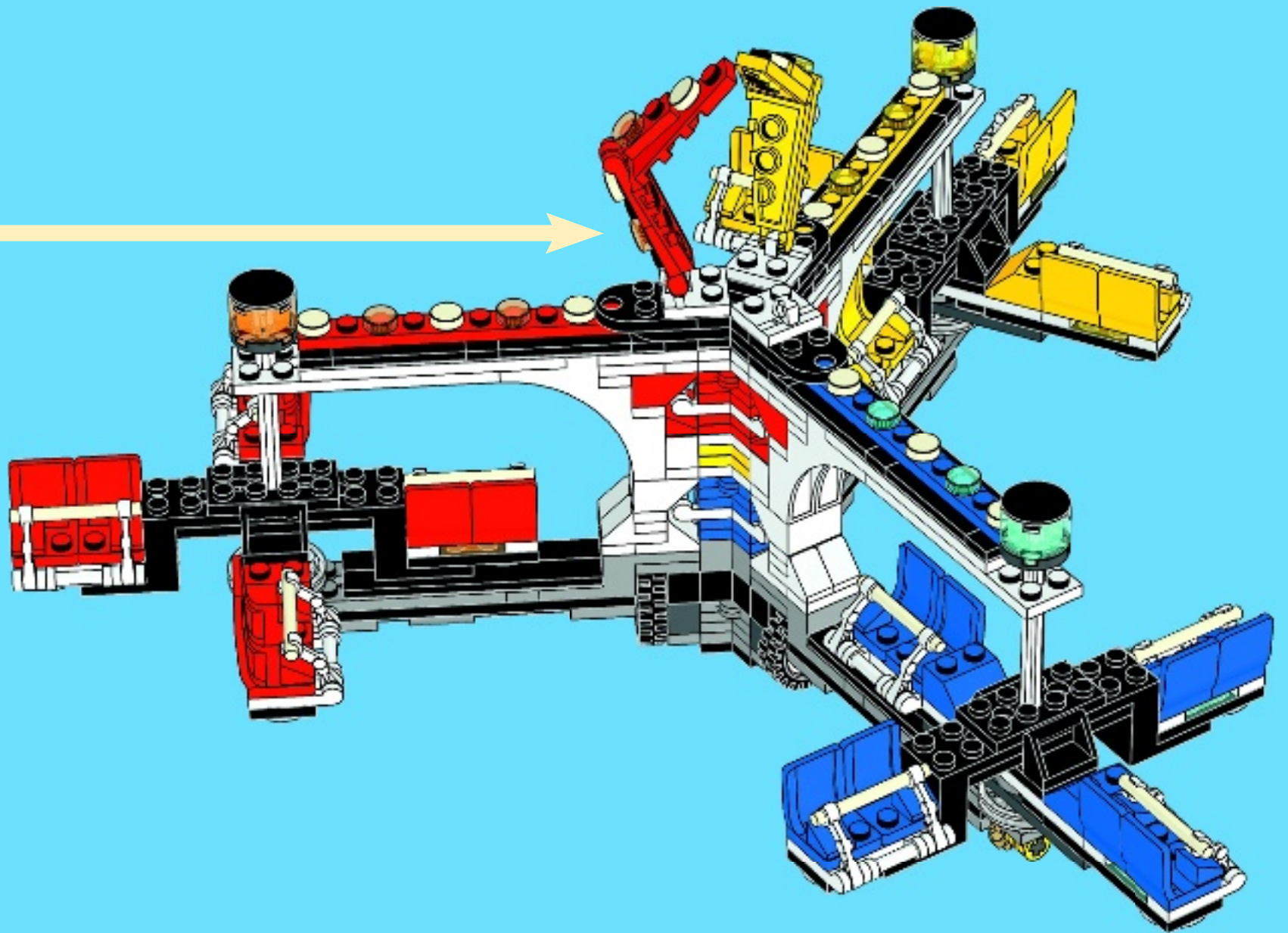

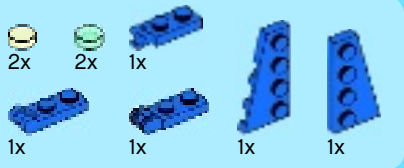

44

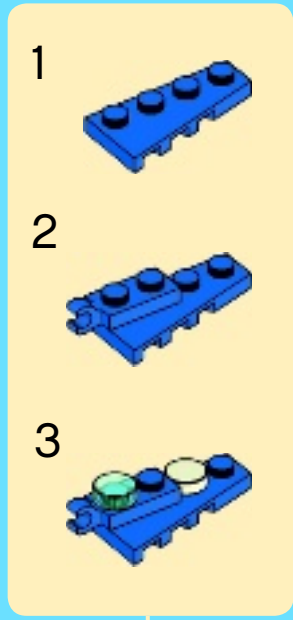
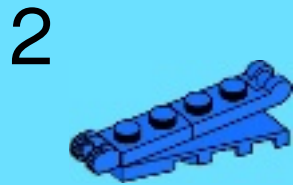
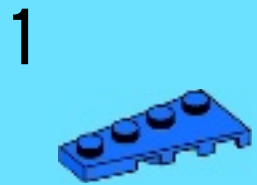

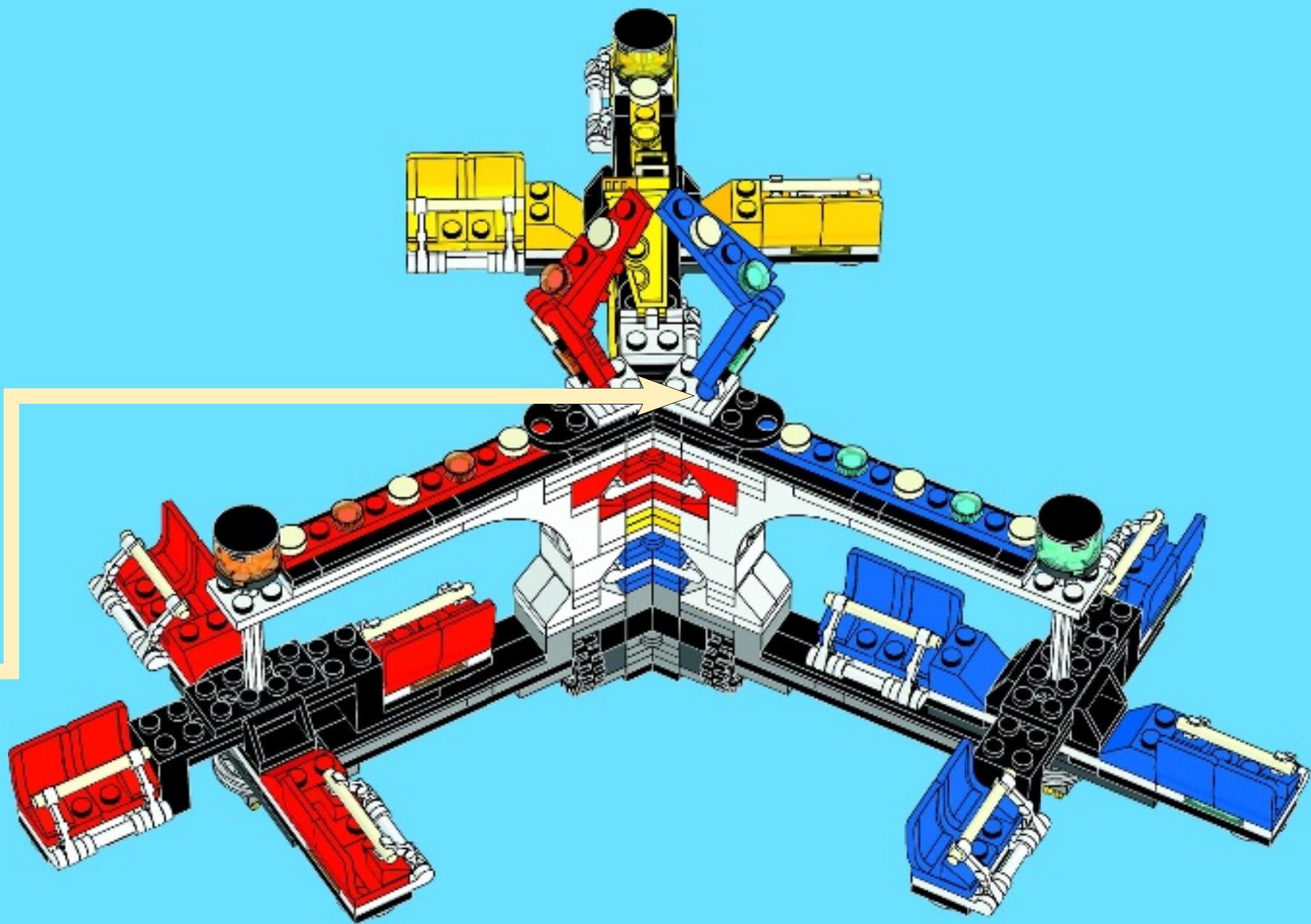

45

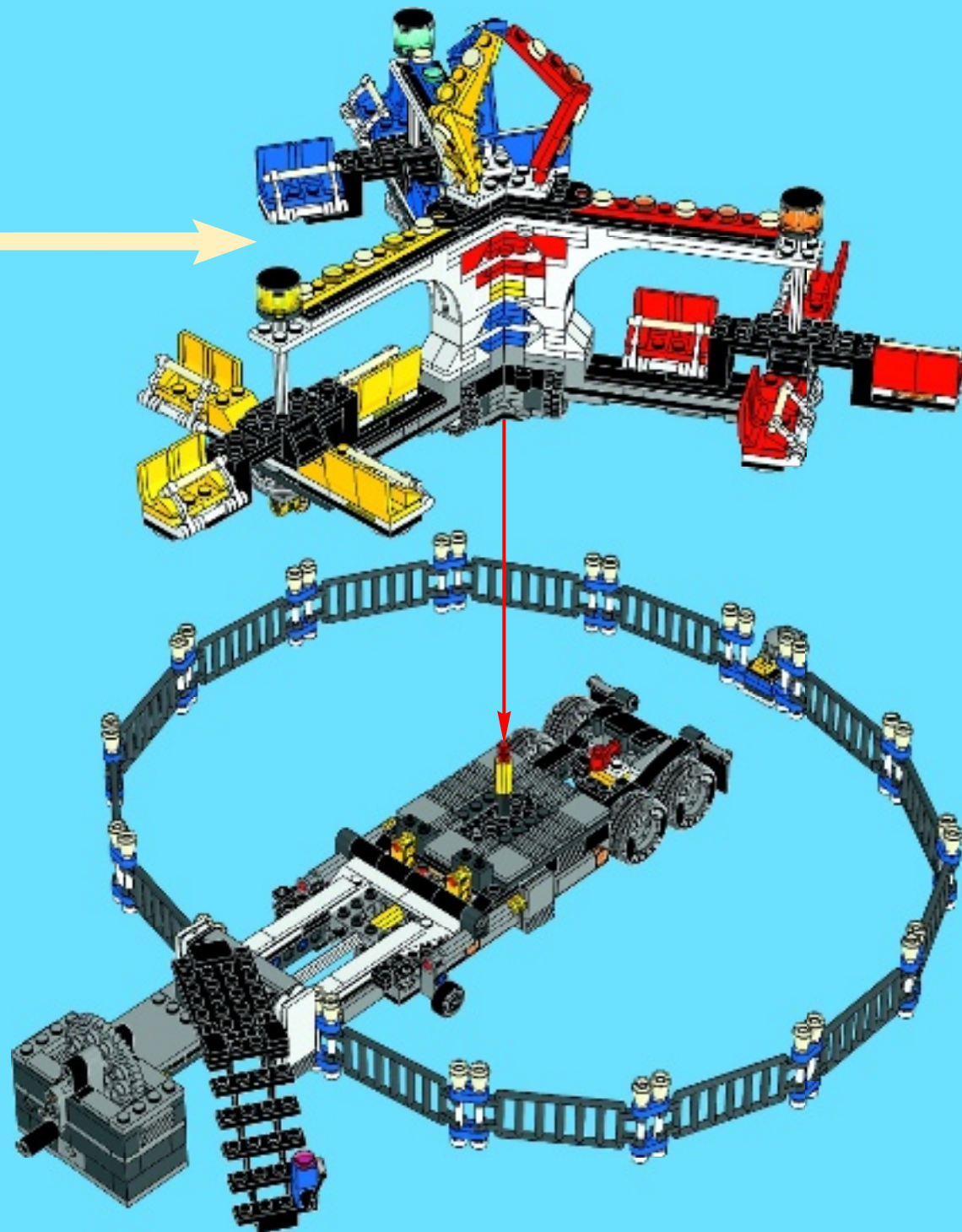

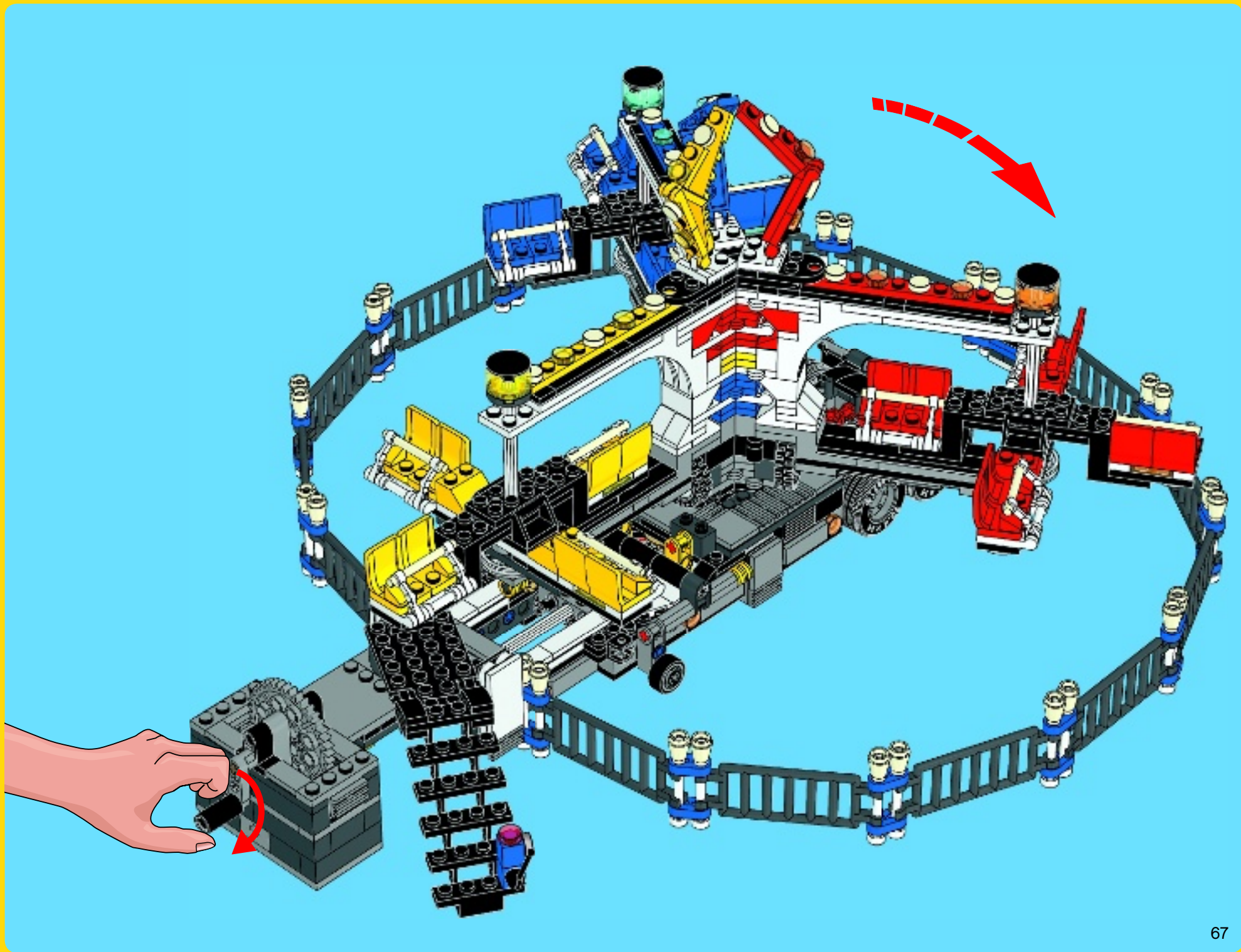

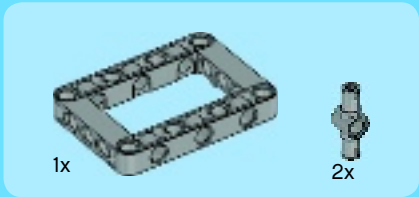
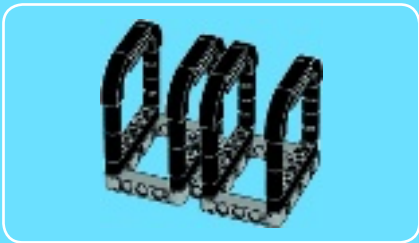

1

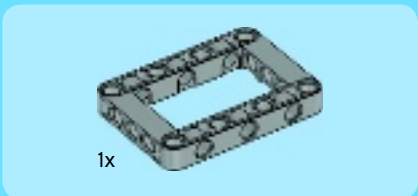
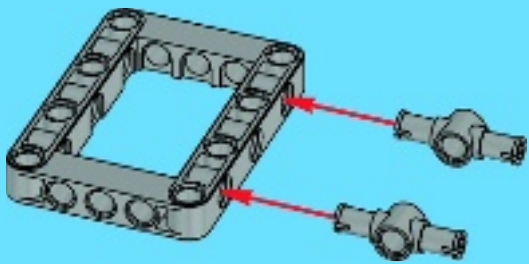

2

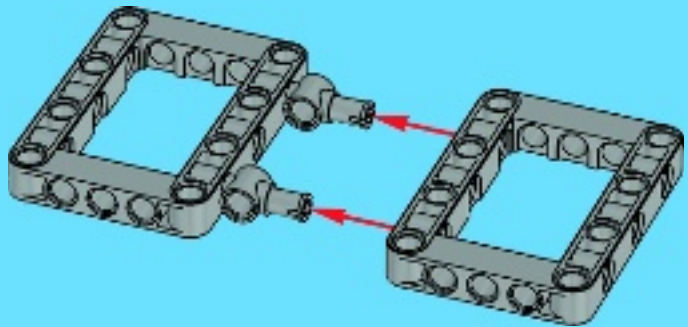

3

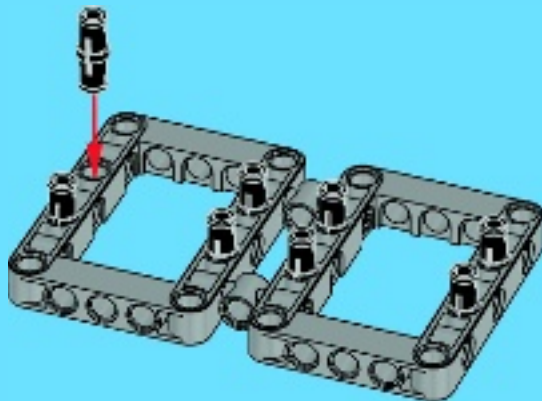



4

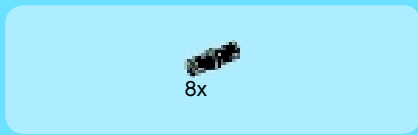
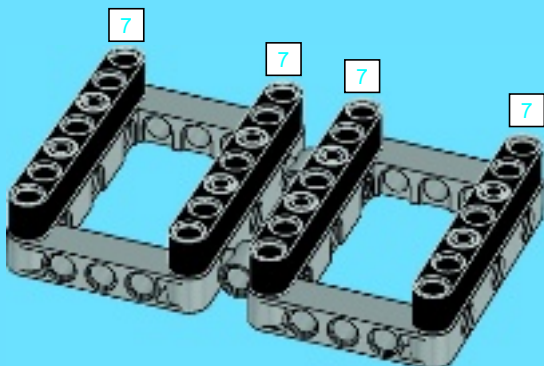

5

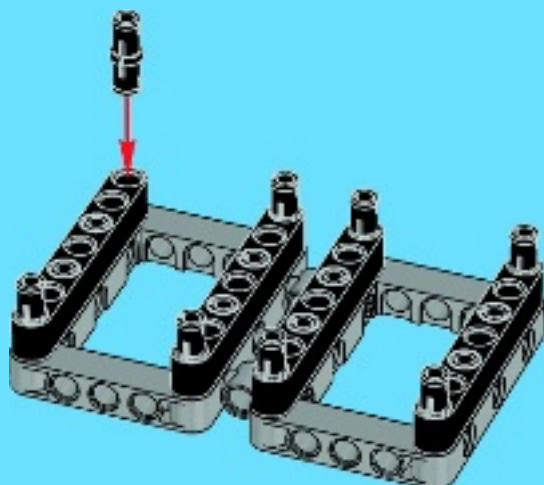

6

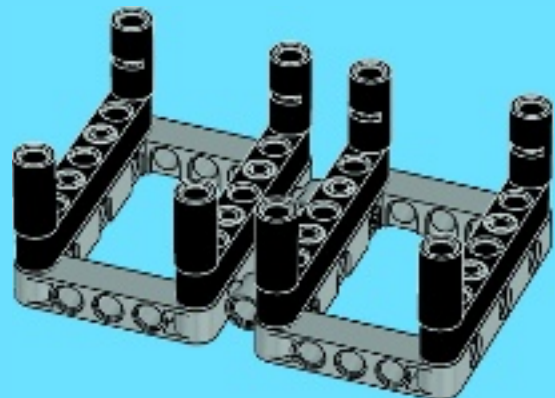

7

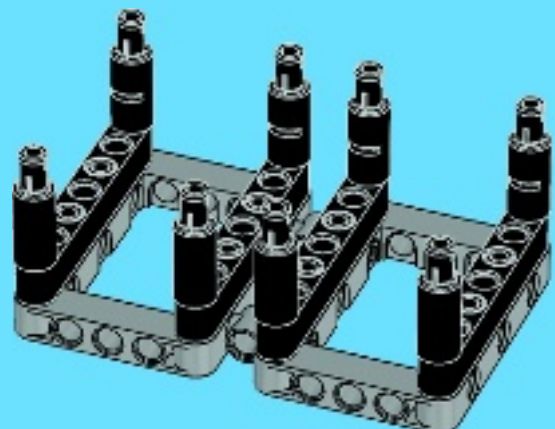



8x

8

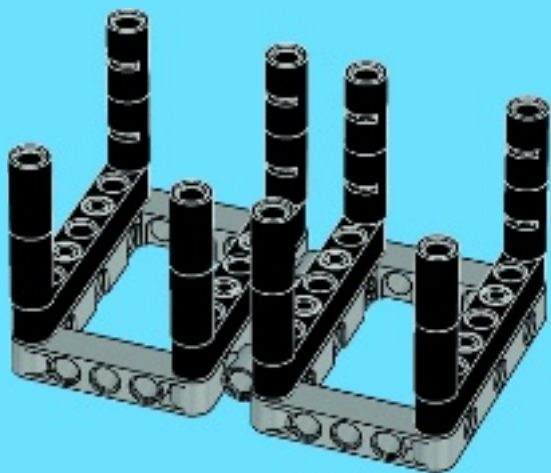

8x

9

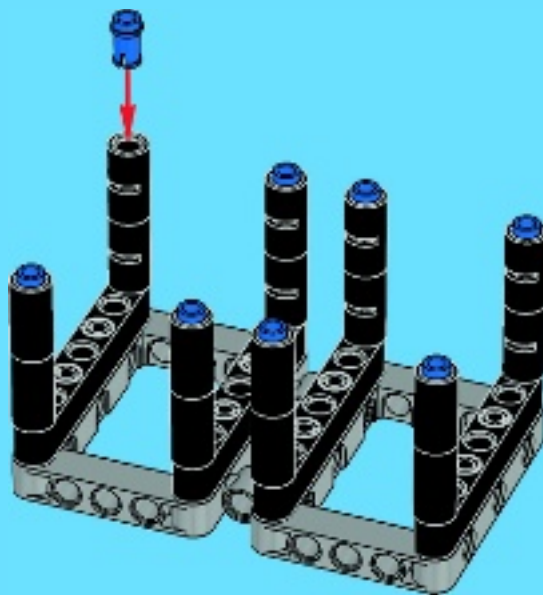

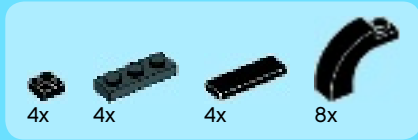

10

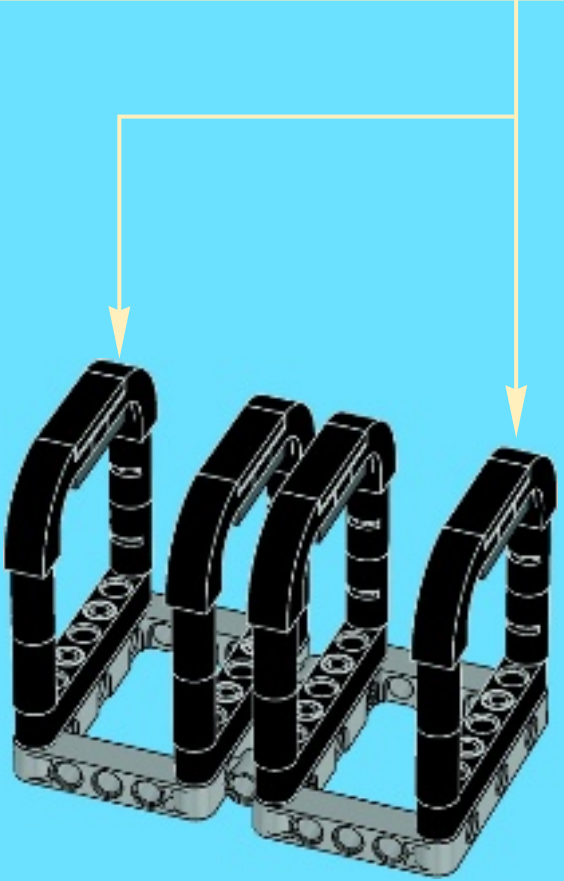
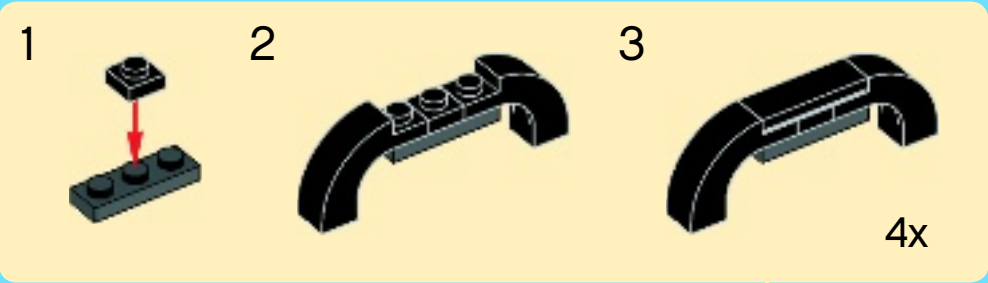





1

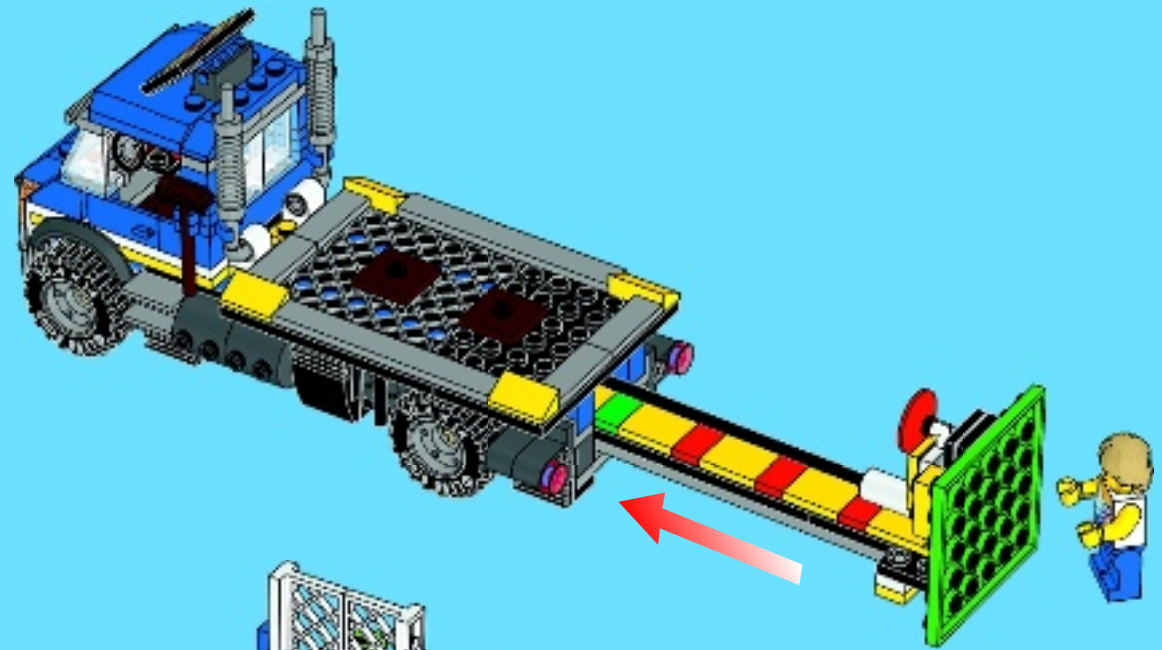

2

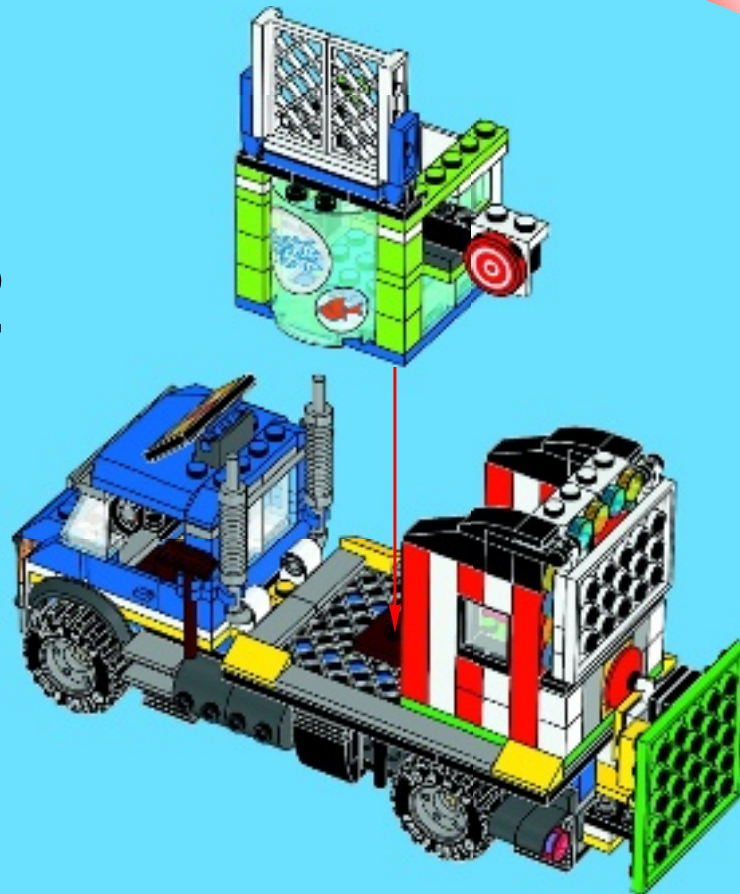

3



1

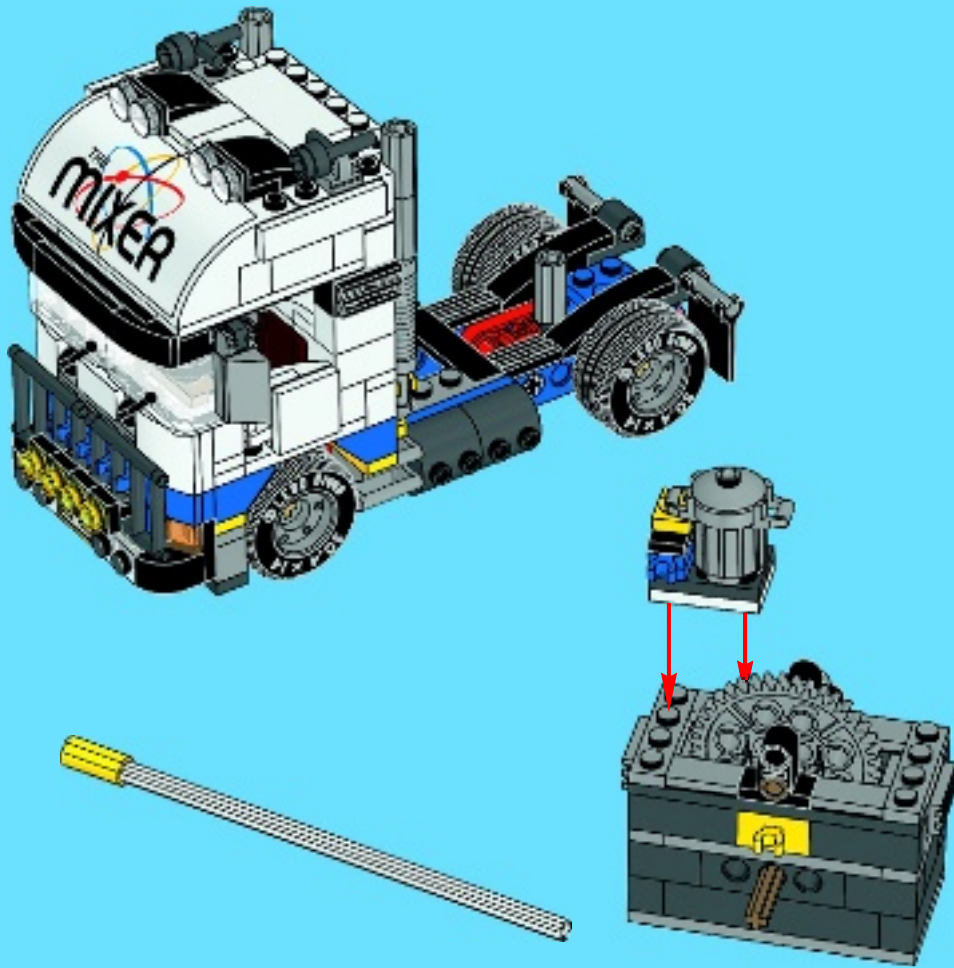

2

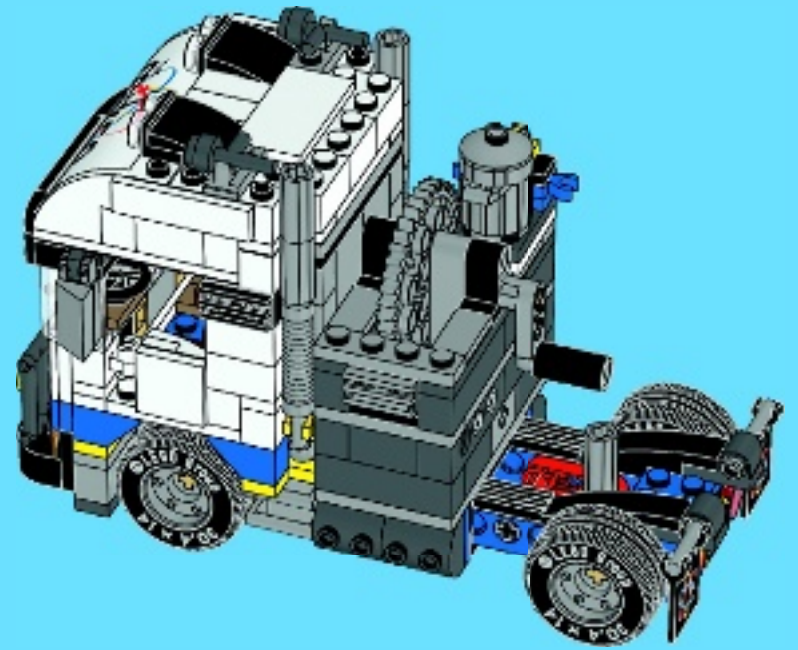

1

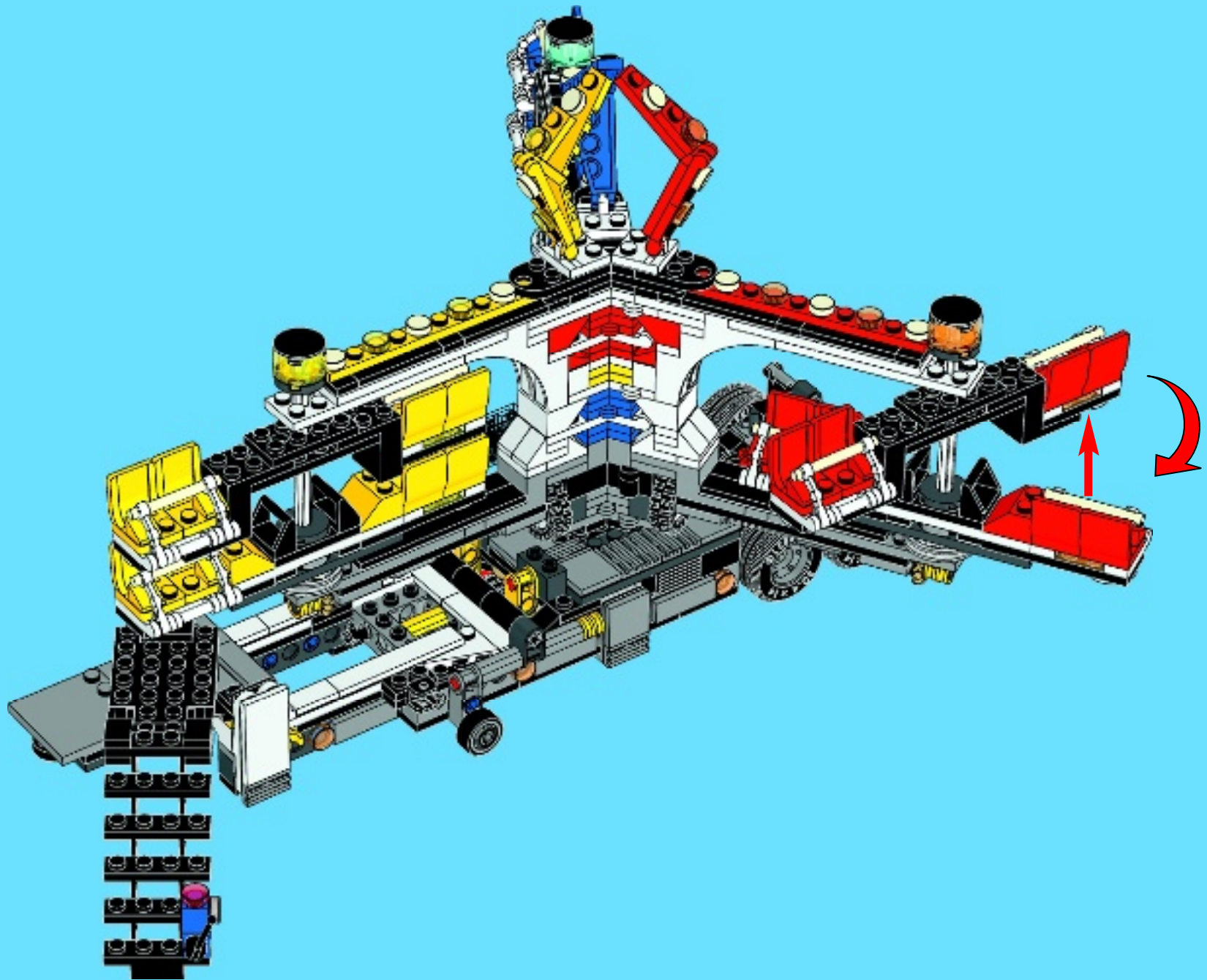

2

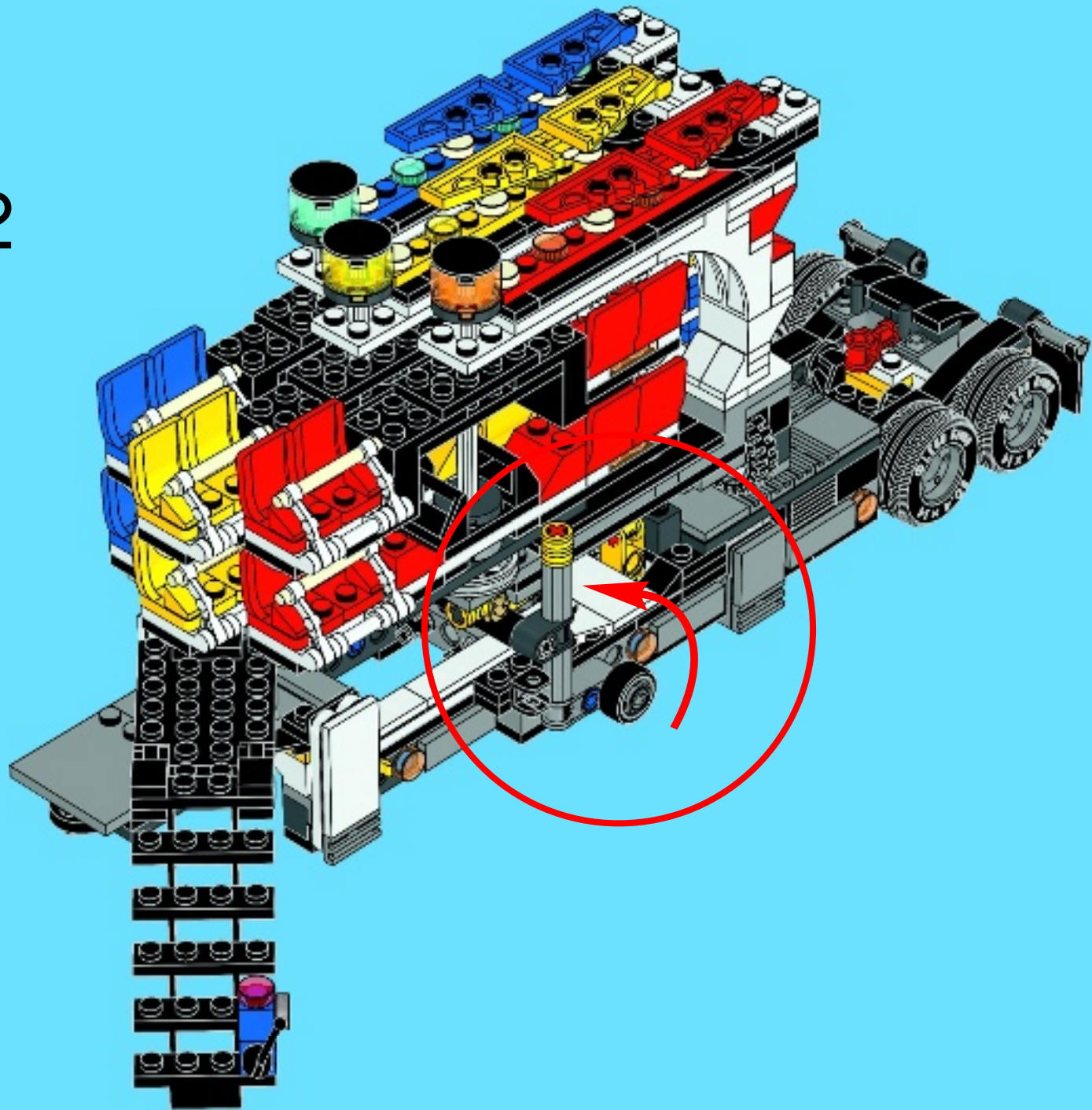

3

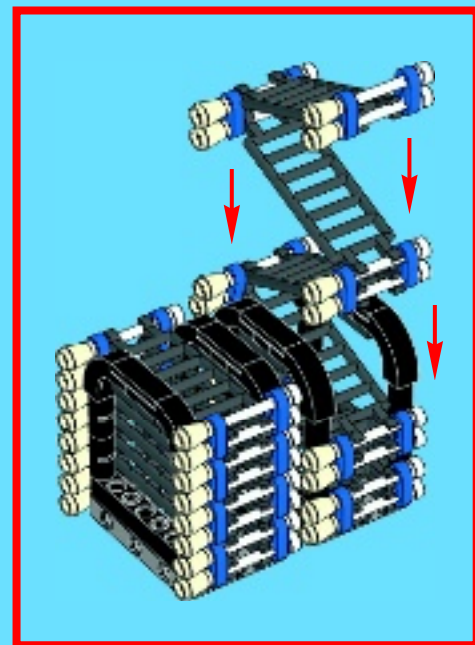
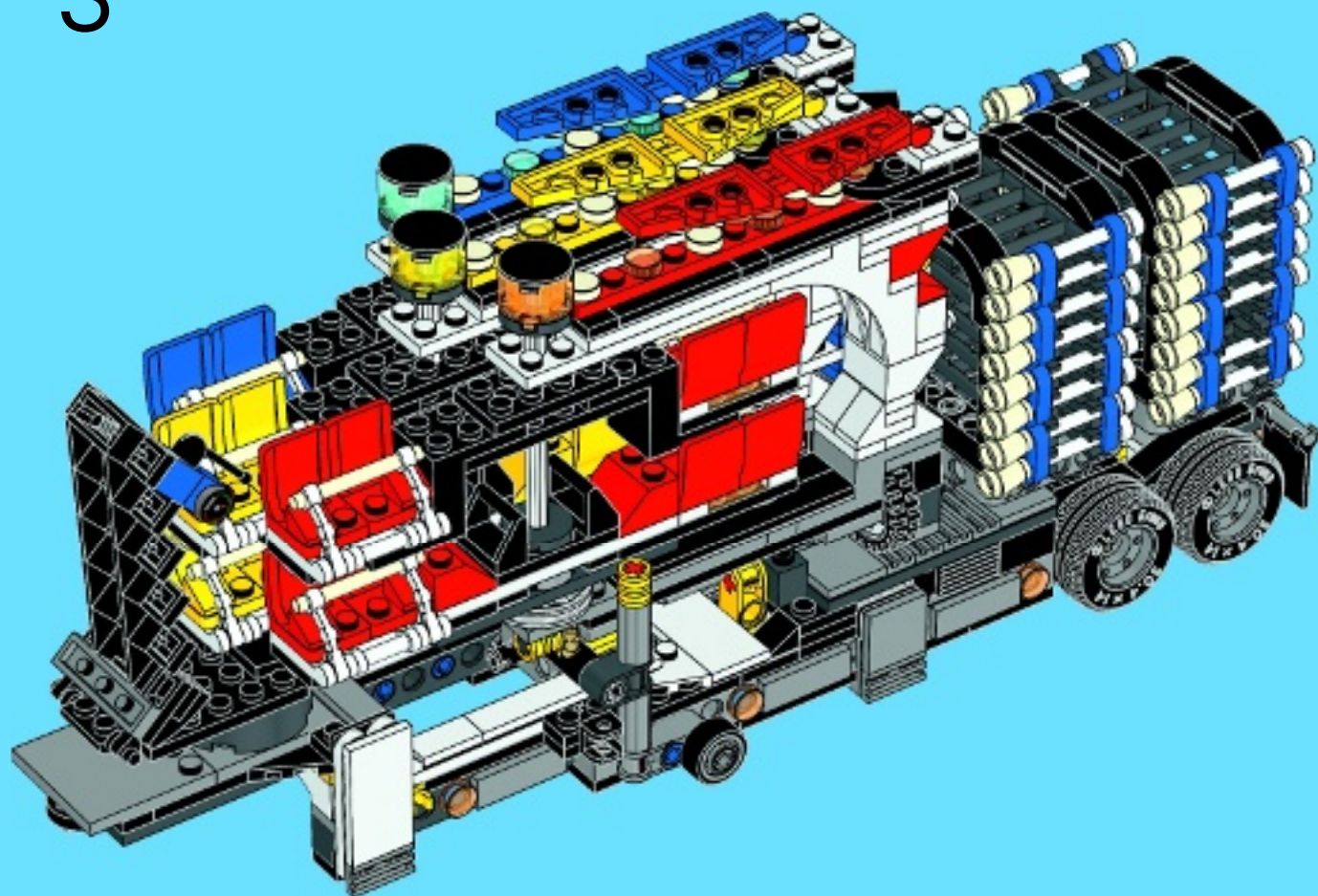

4

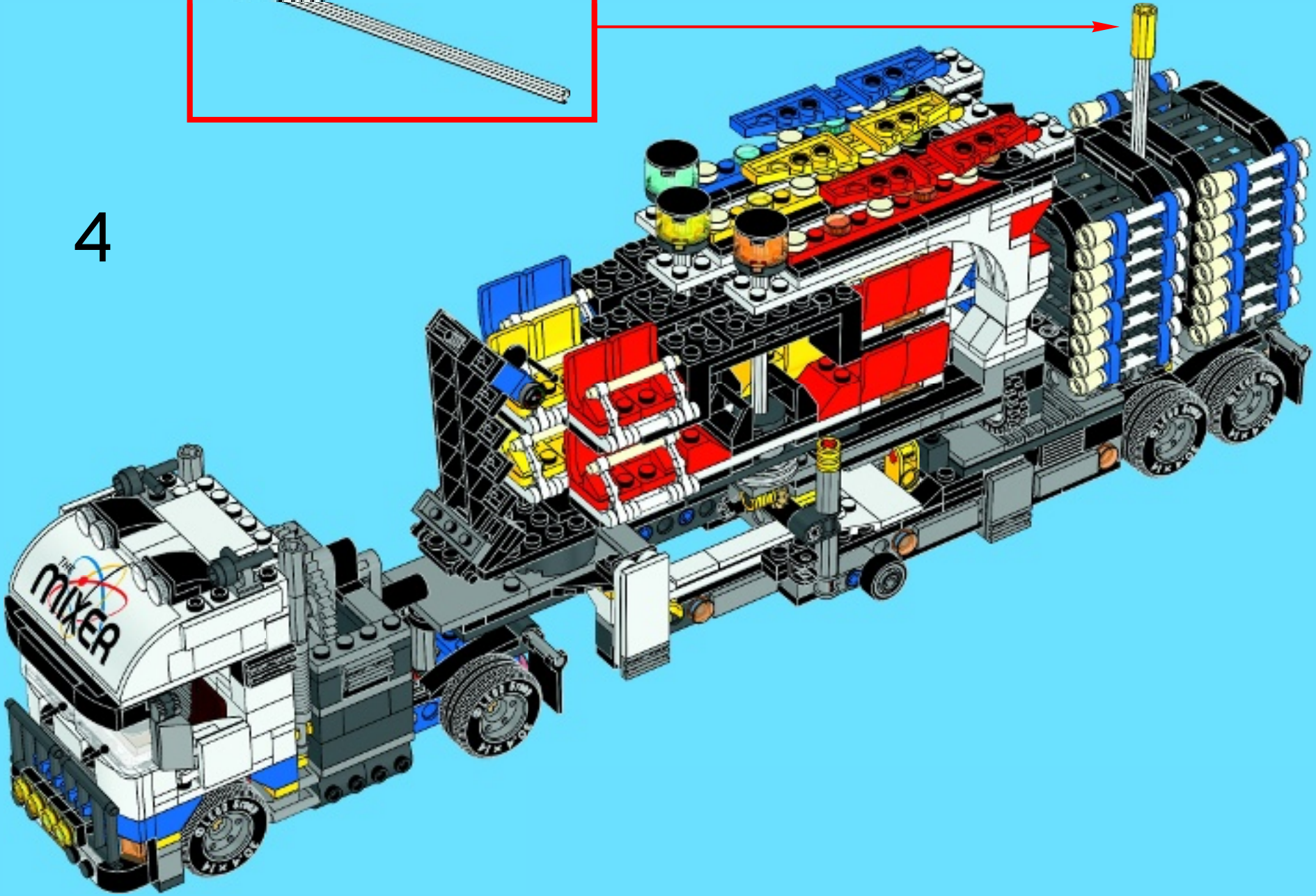
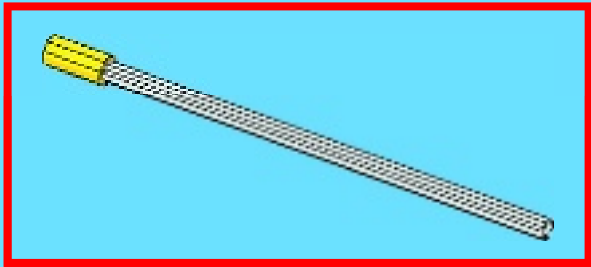

+ power functions™



10244

8883 + 88000 =

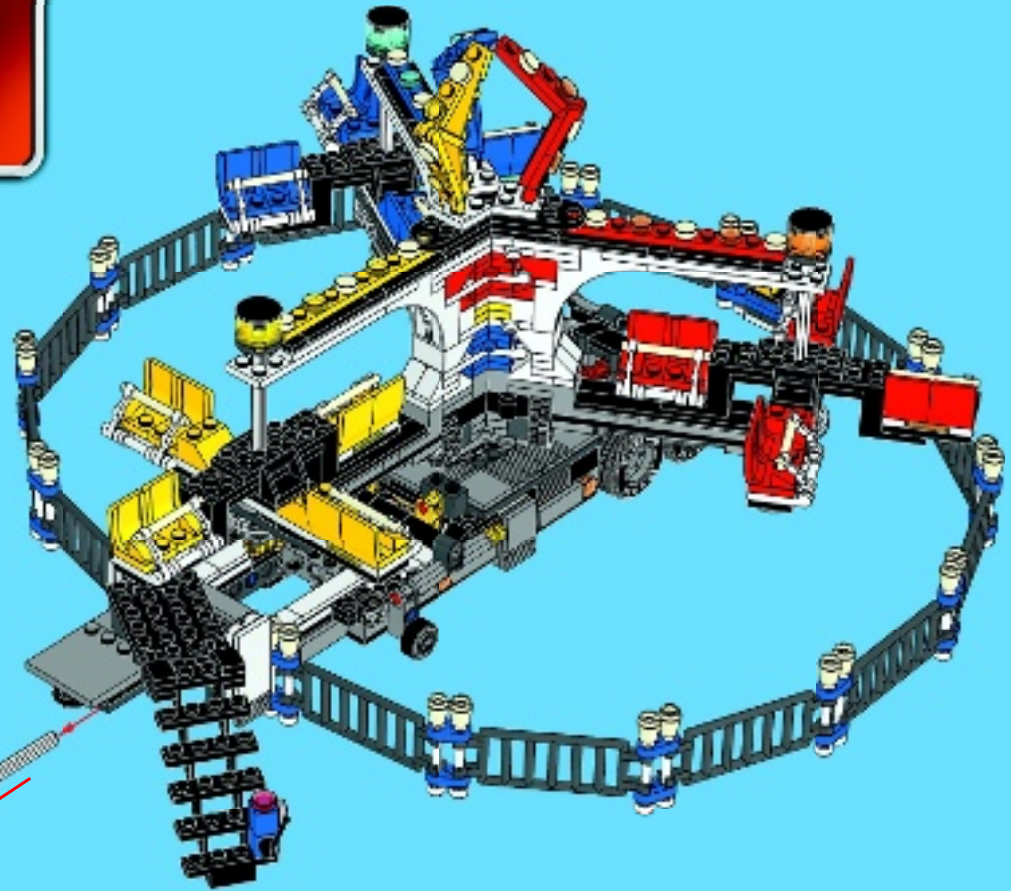

1

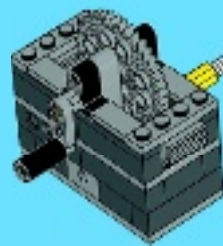

2

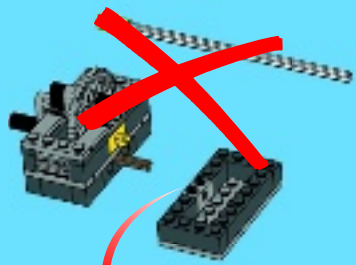

3

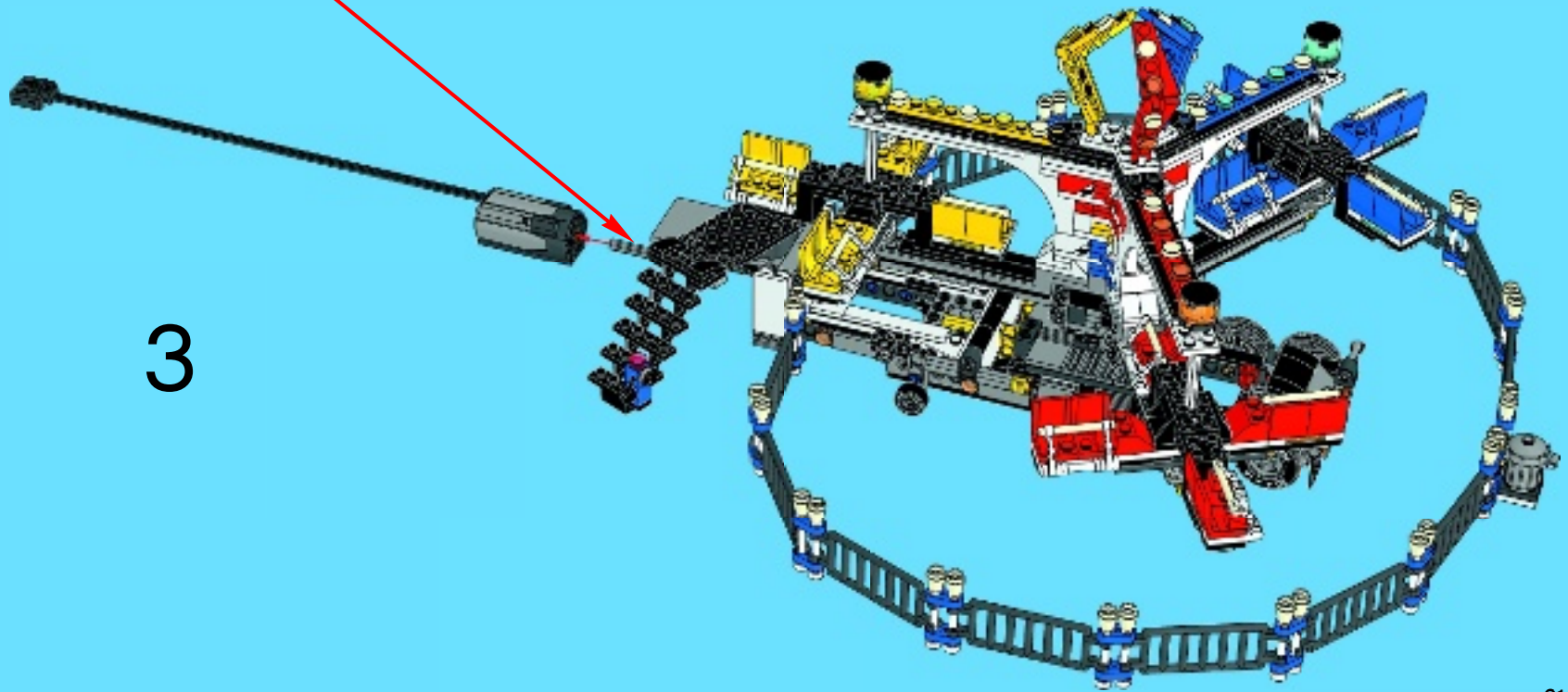

4

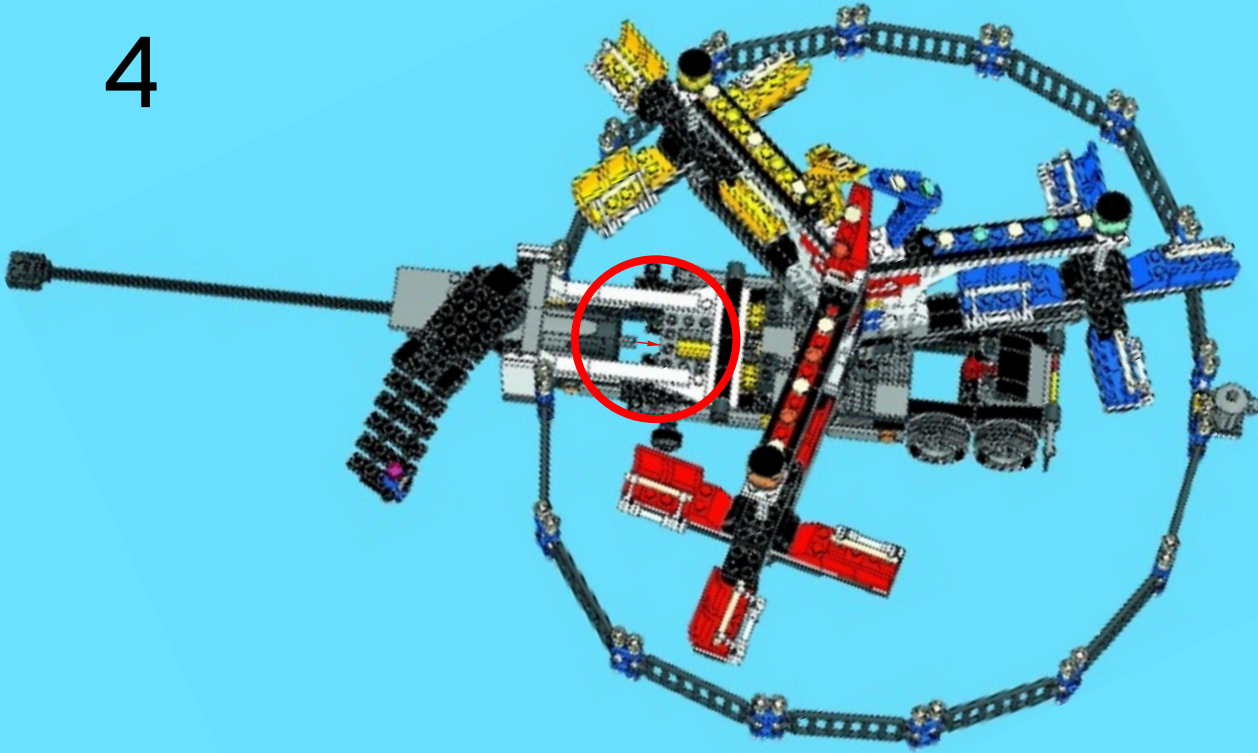

5

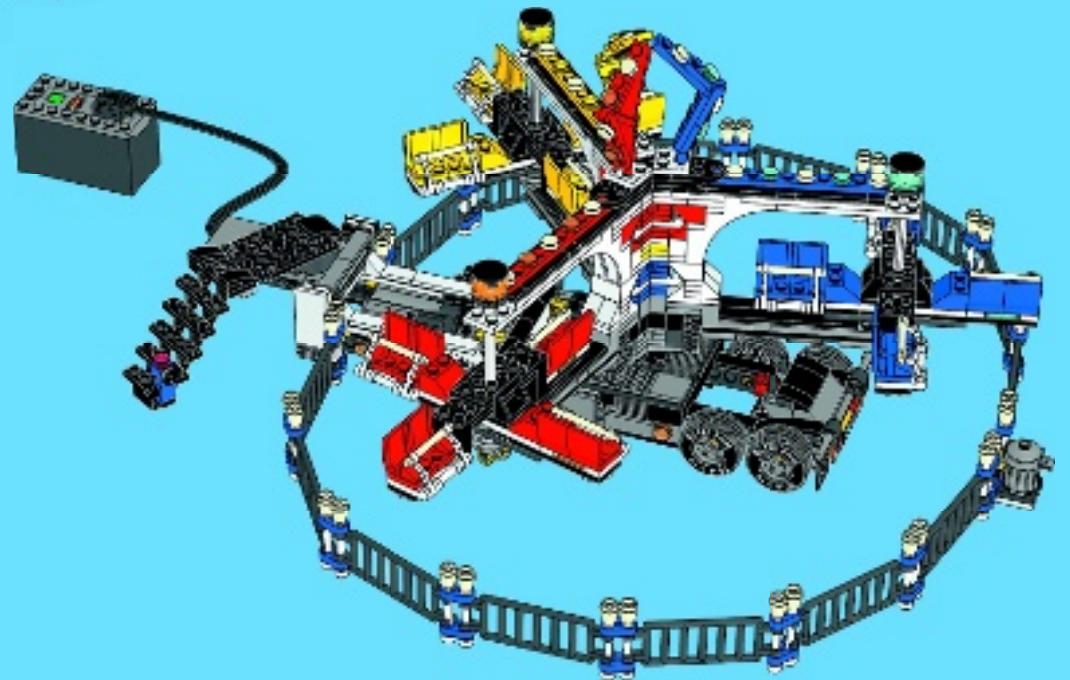

6

