

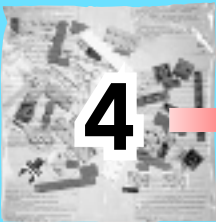

10230

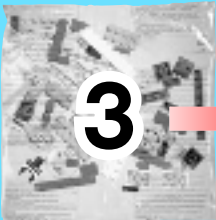

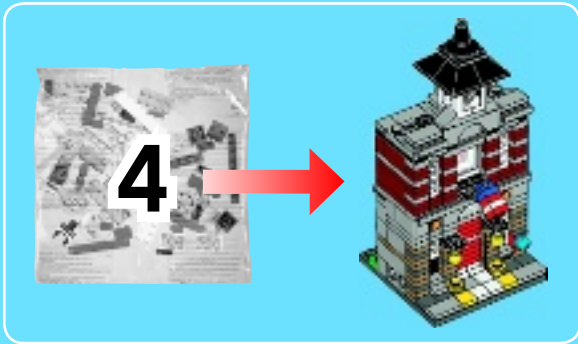



1

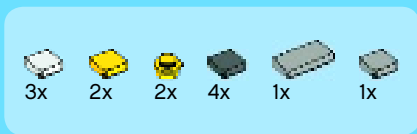

2

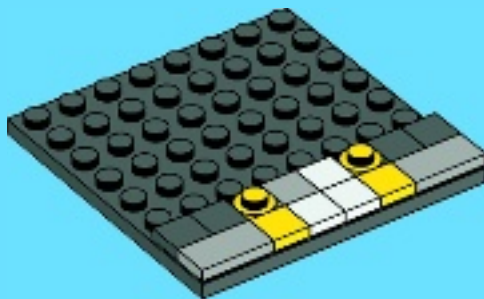



3



4

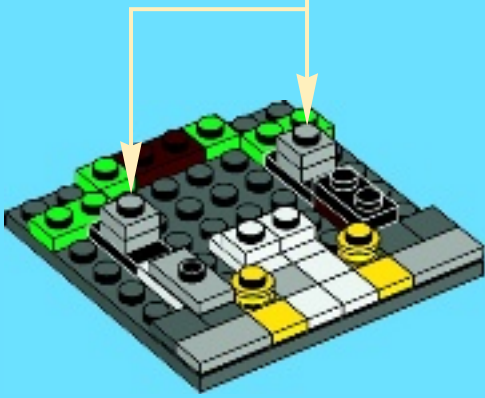
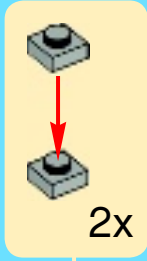

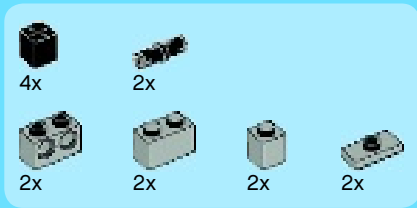

5

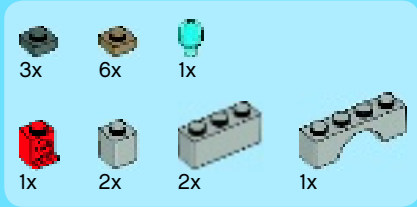
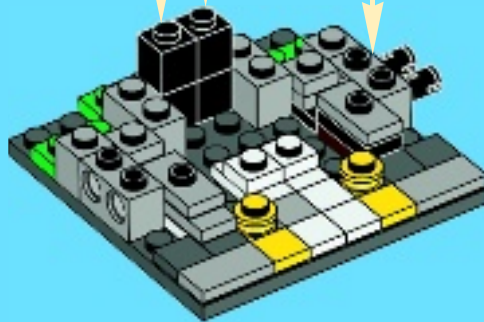
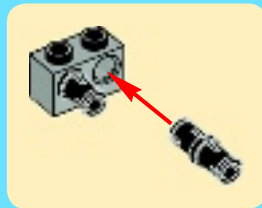
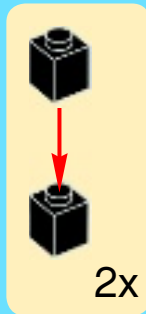

6

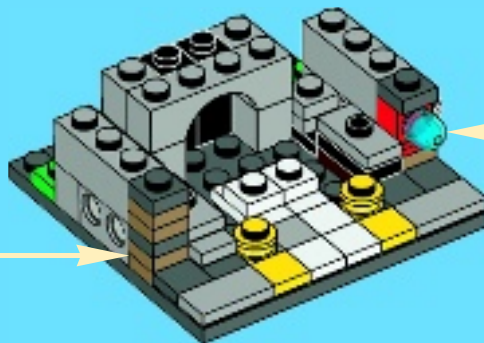
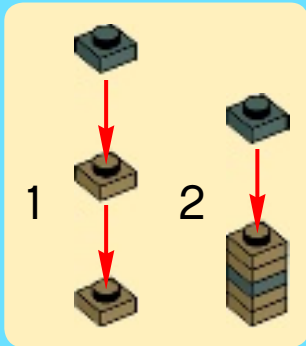
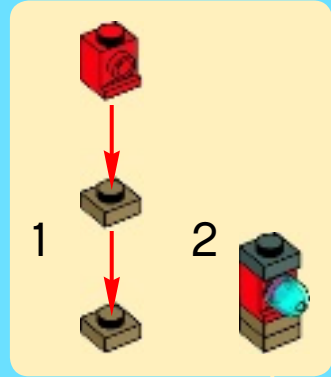

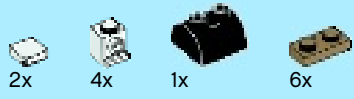

7

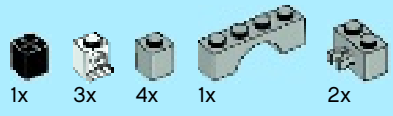
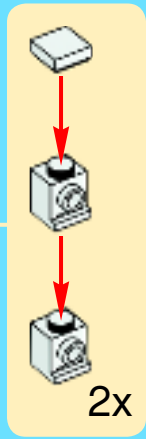
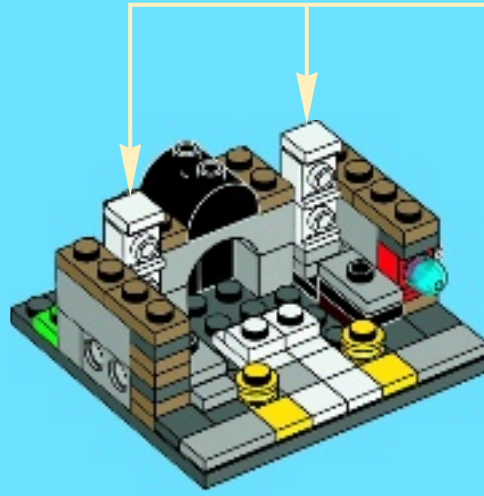

8

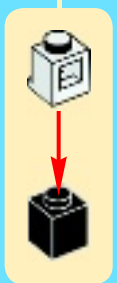
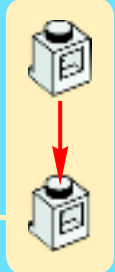
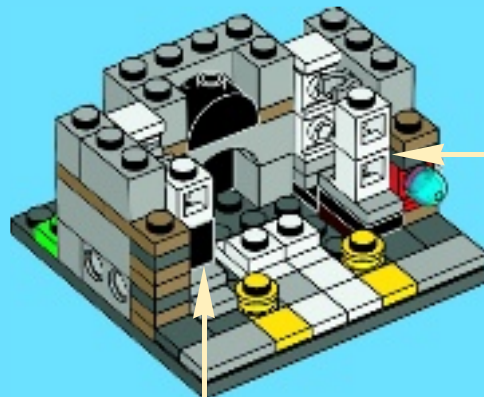

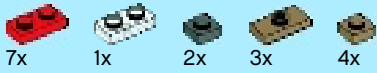

9

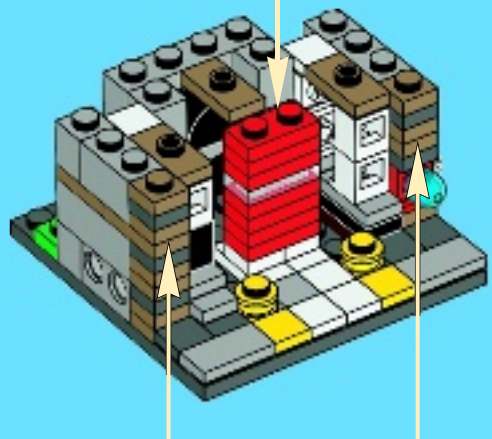
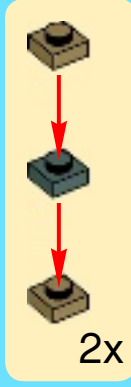
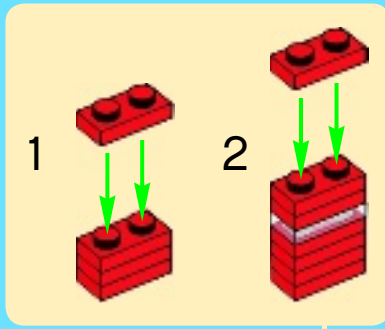

10

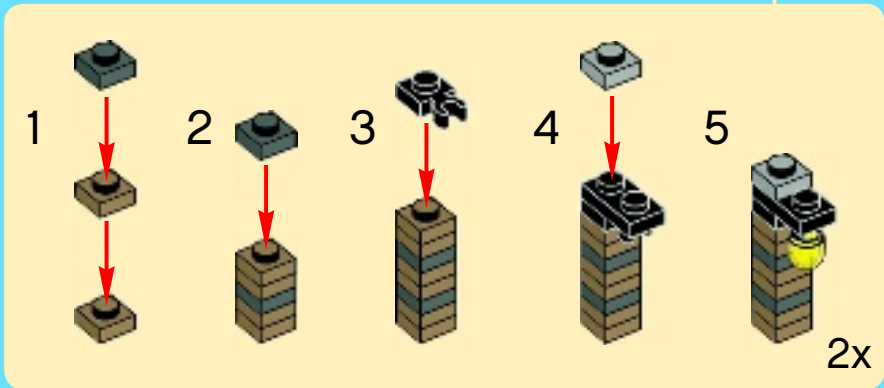
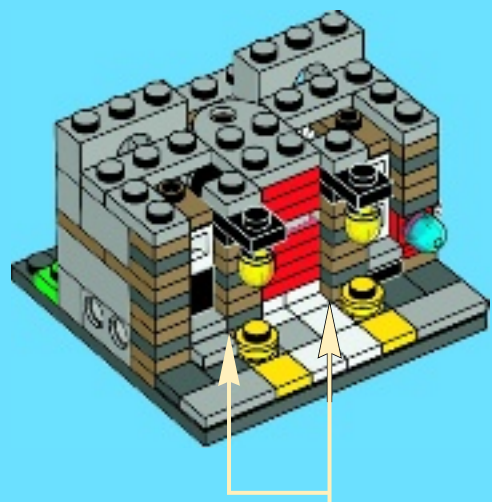

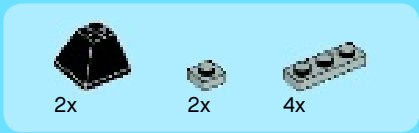

11

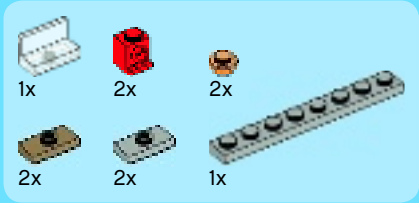
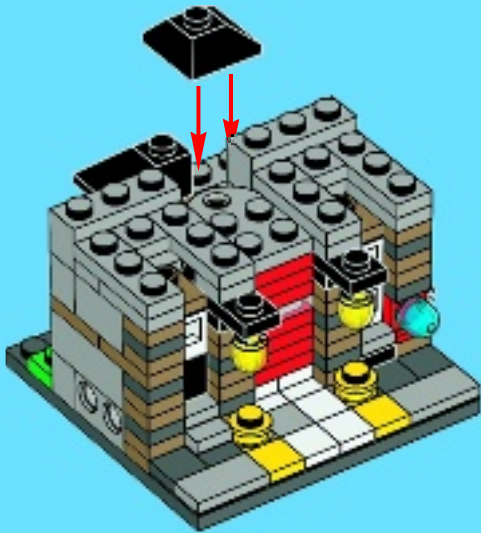

12

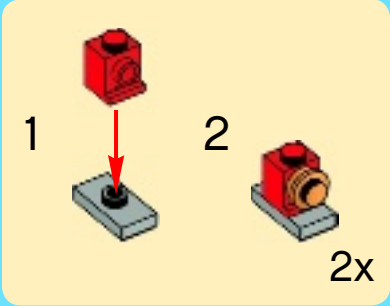
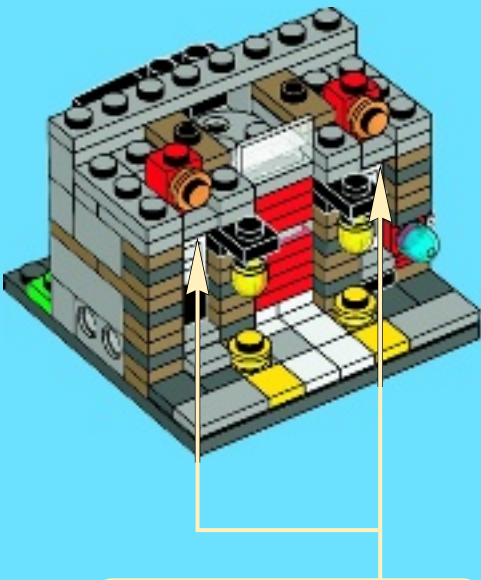

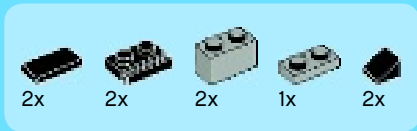

13

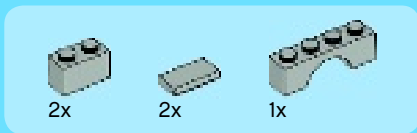
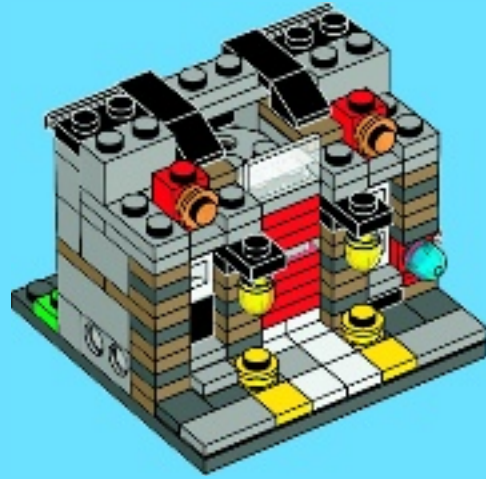

14

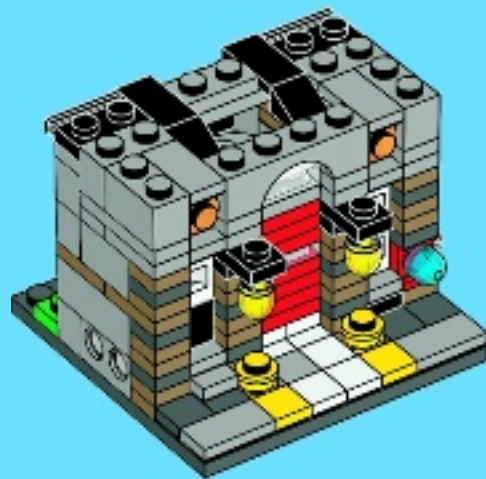

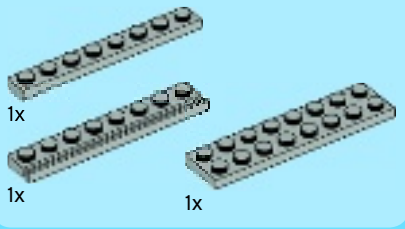

15

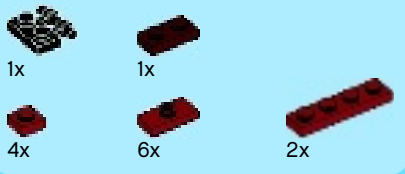
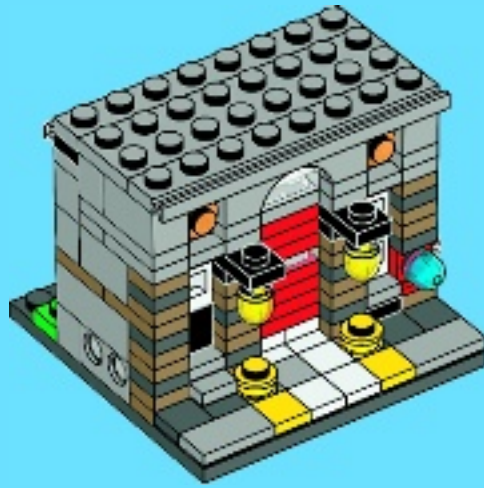

16

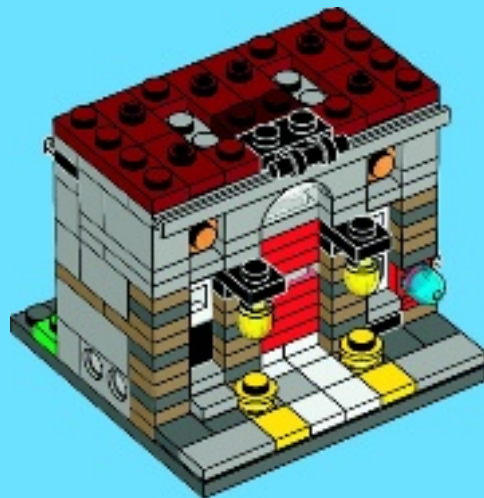



4x



2x

17

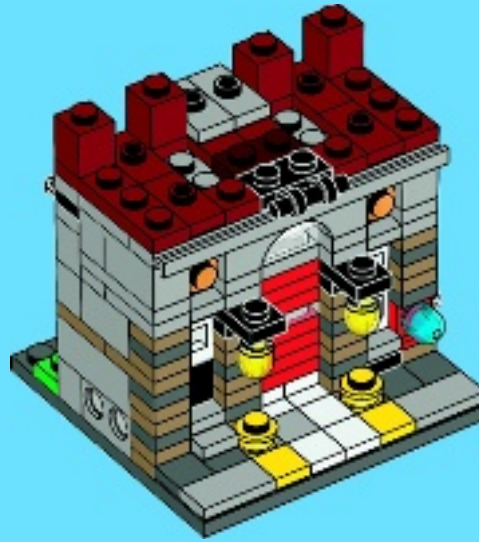

4x



2x



8x



2x

18

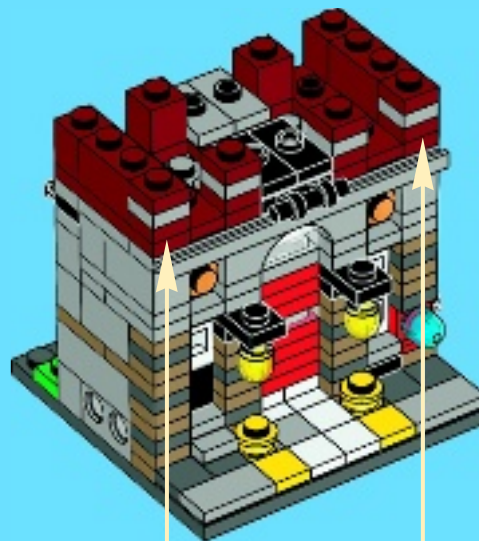

4x



2x



4x

19

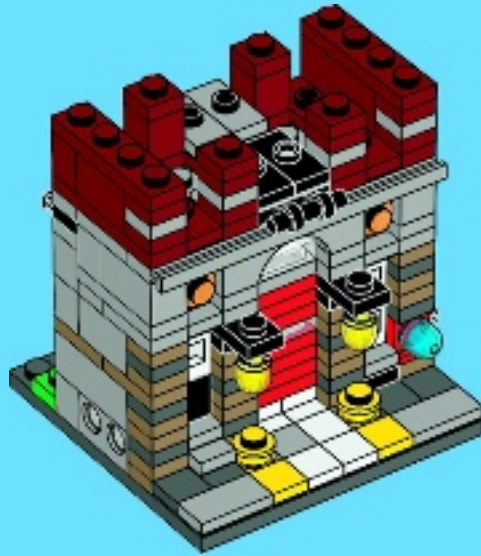

1x



2x



4x



1x



1x

20

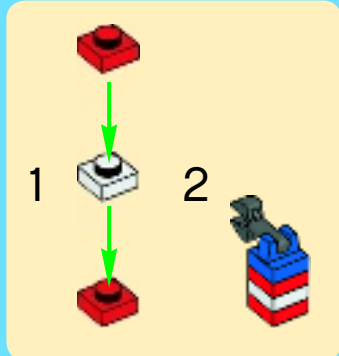
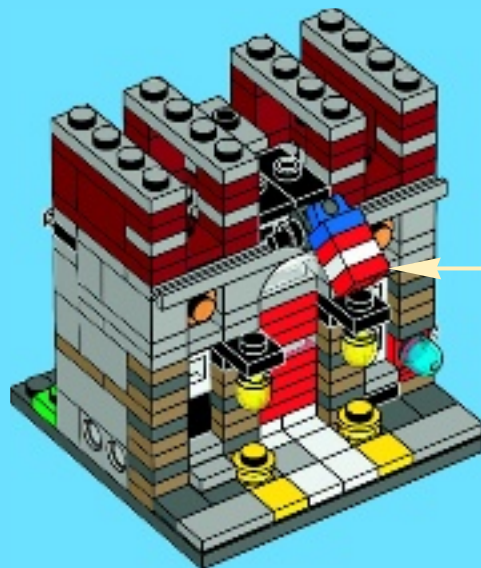

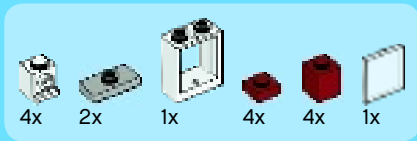

21

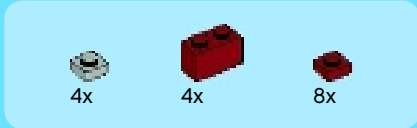
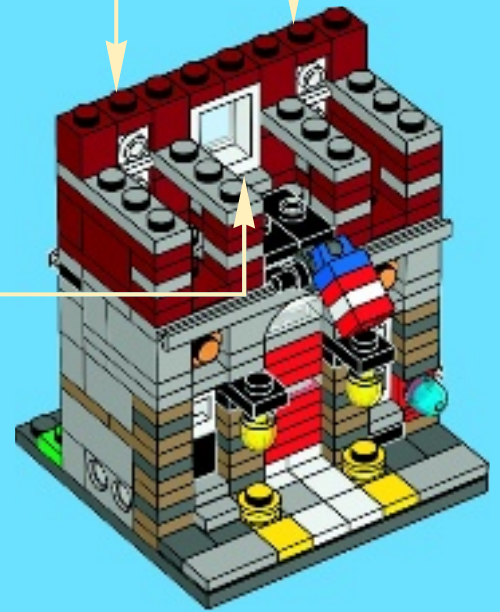
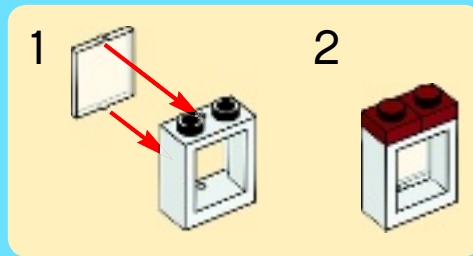
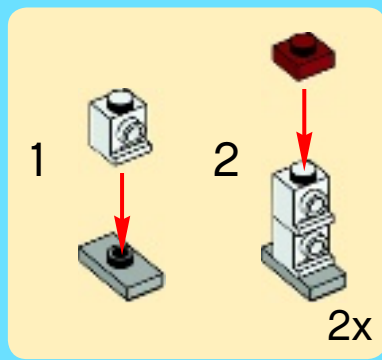

22

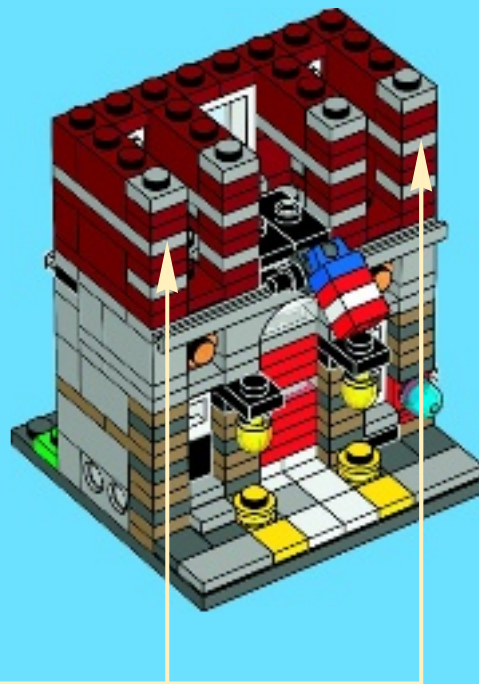
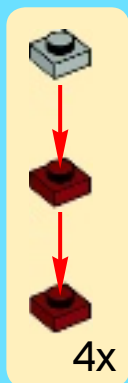

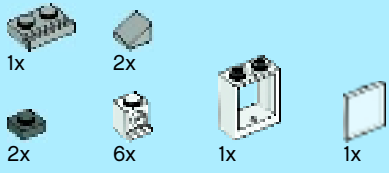

23

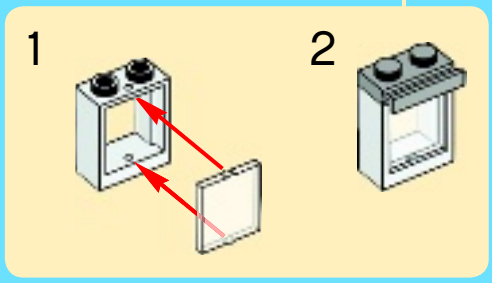
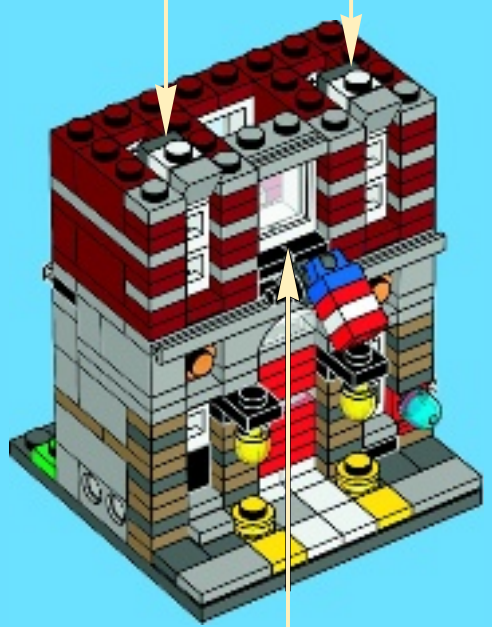
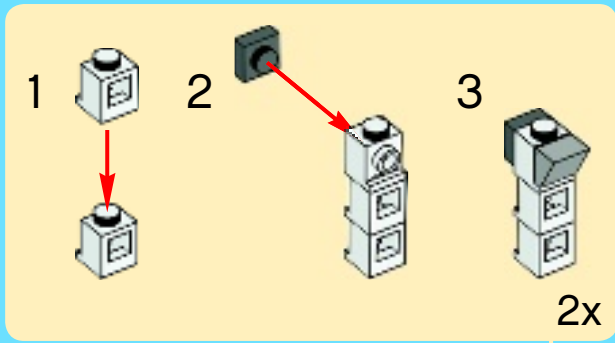



2x



4x



1x

24



1x



3x



2x

25

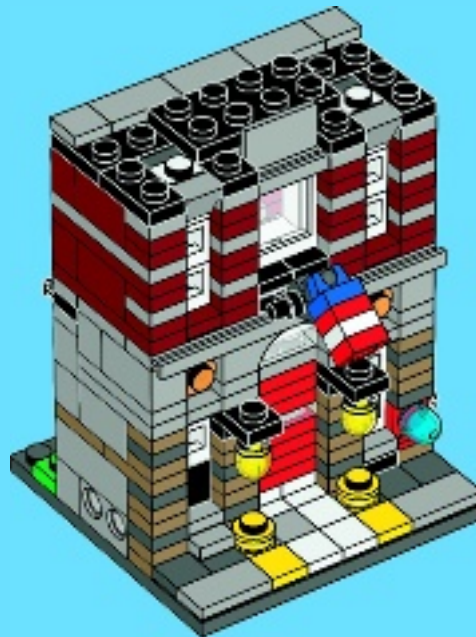



2x



2x



1x

26

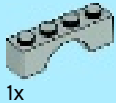
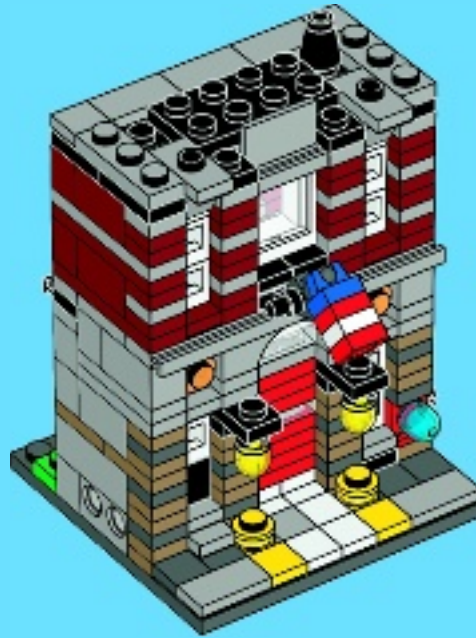

1x



2x

27

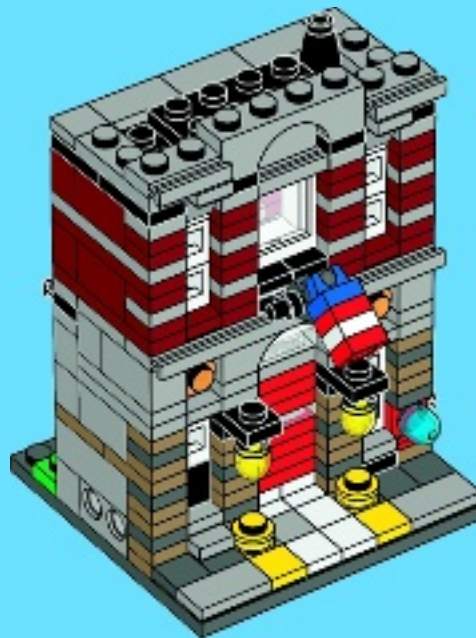



3x



1x

28

1

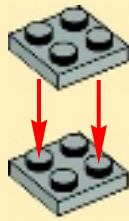

2

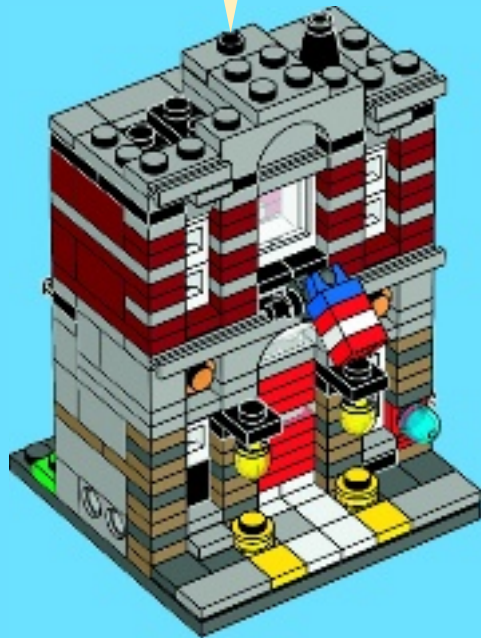
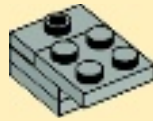

1x



1x



1x

29

1

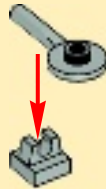

2

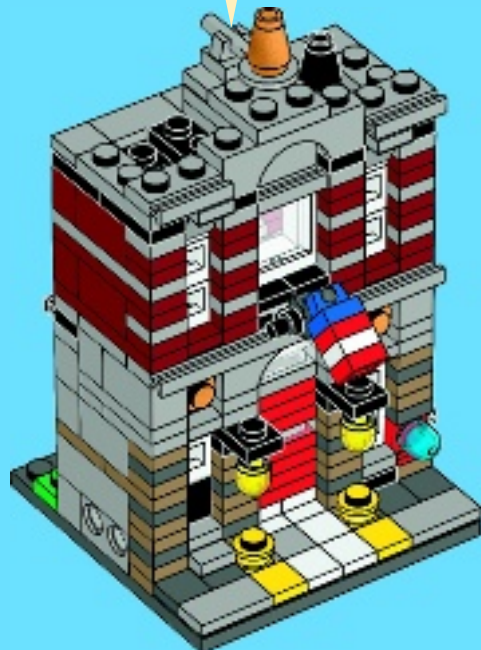



2x

30

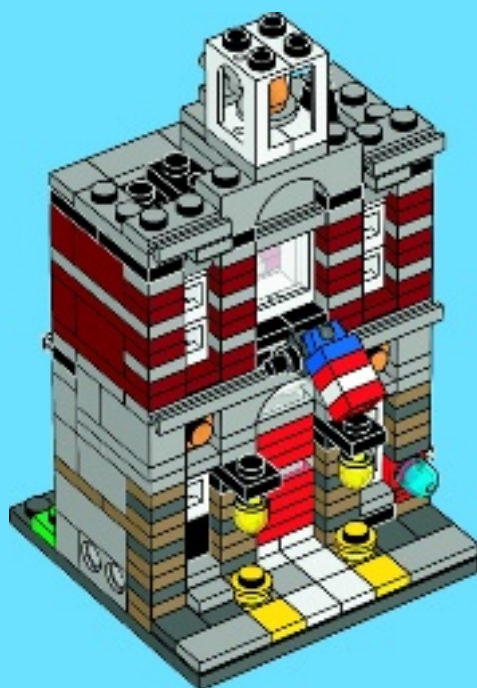

1x



2x



4x

31

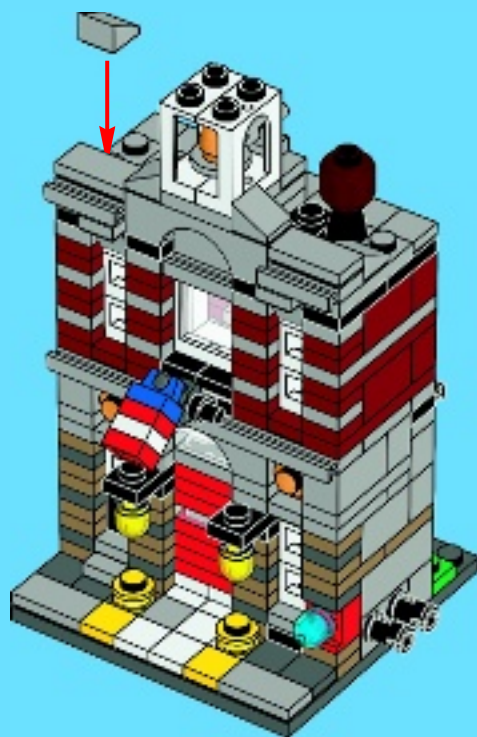



4x

32

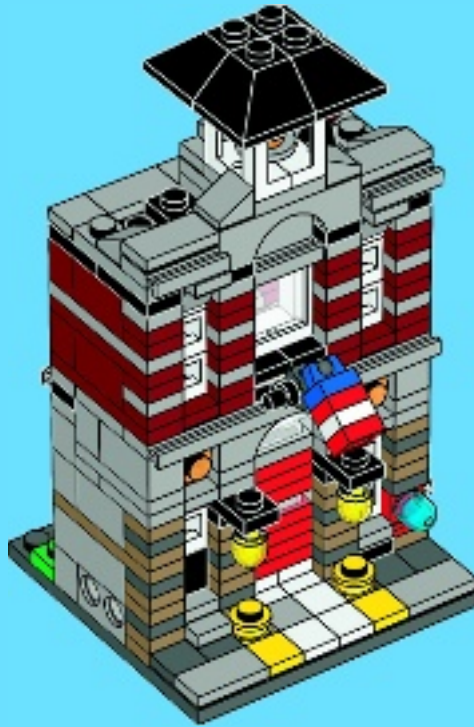

1x



1x



1x

33





5



1x

1x

1



2x

2x

6x

2x

2



9x

2x

2x

2x

3



2x

2x

2x

1x

4

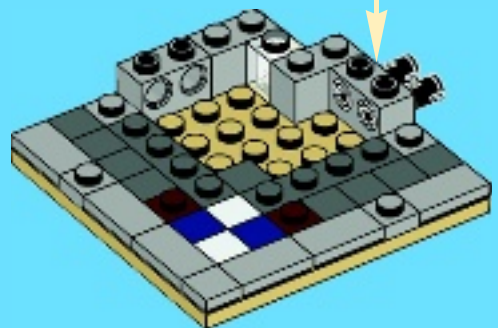
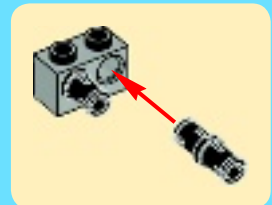



3x



2x

5

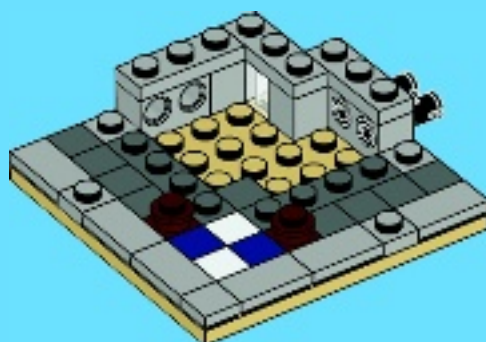

3x

6

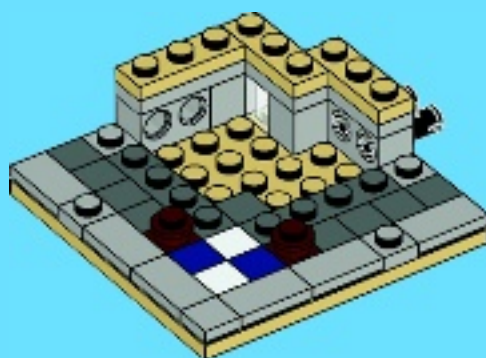



4x



2x



6x

7

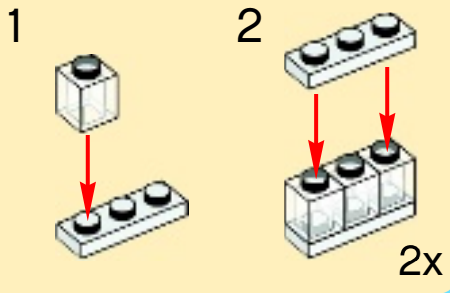

16x



4x

8

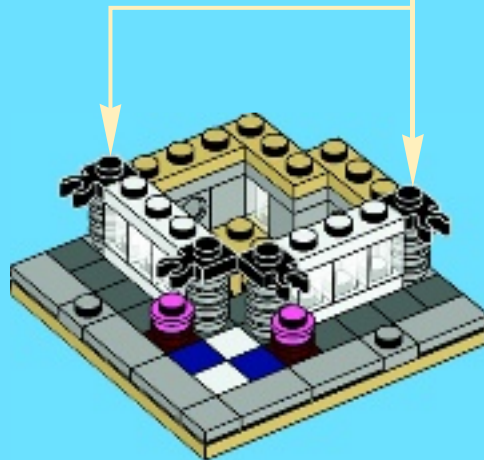
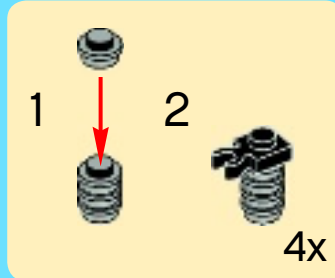

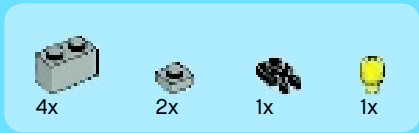

9

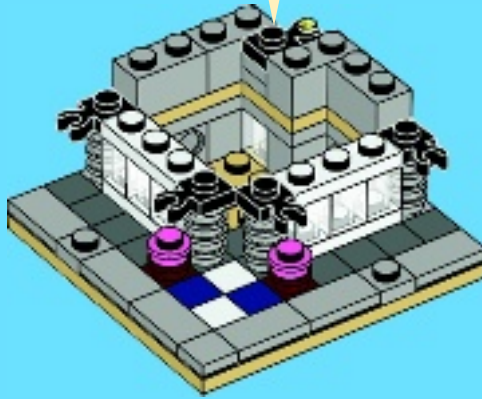
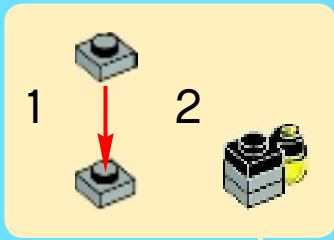

10

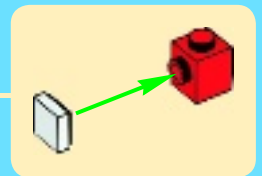
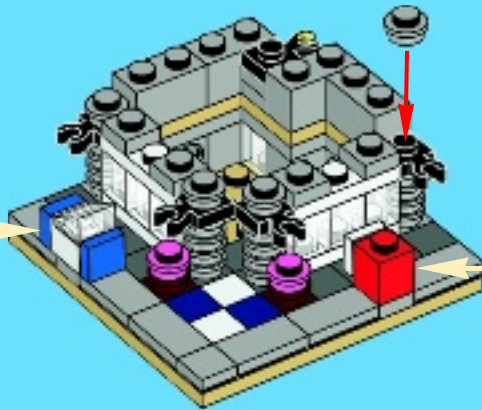
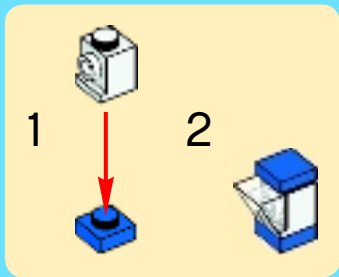



4x



2x



2x

11

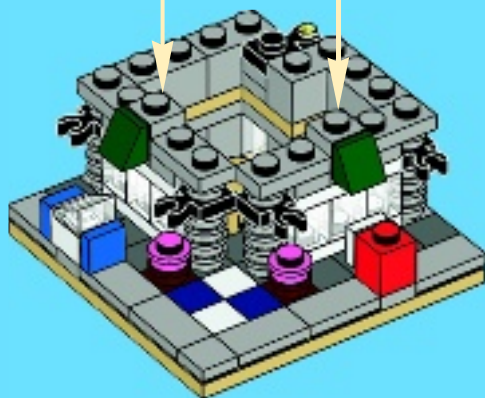
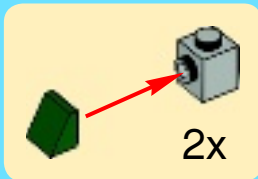

2x



4x

12



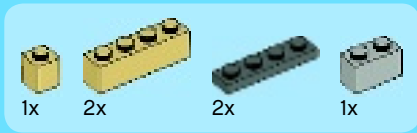

13

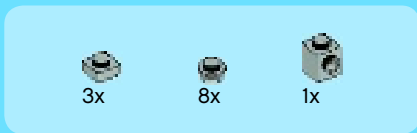

14

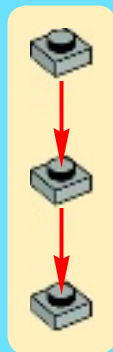



1x



4x

15

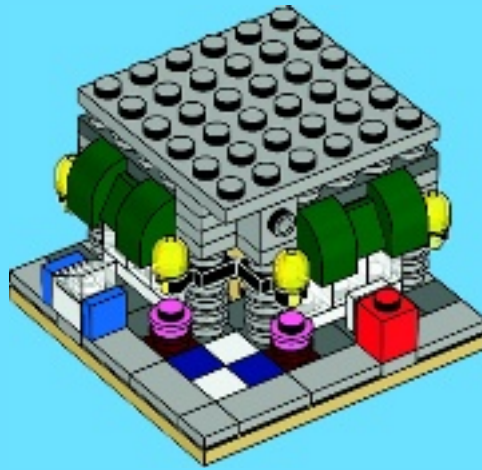

1x



1x



1x

16

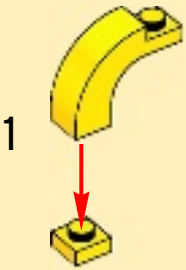

1

2

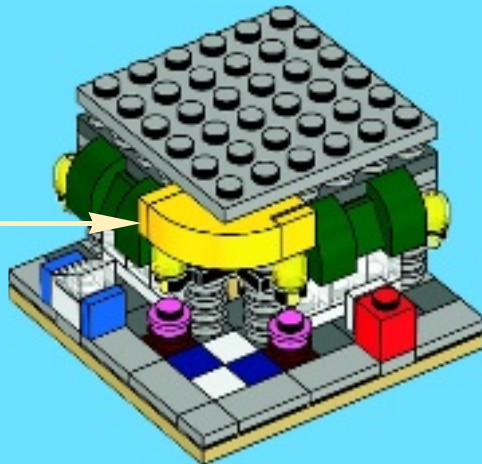
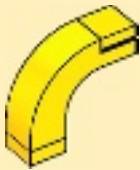



17

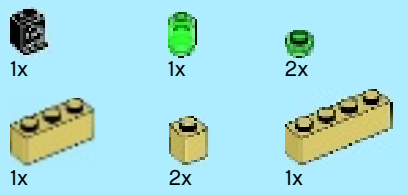
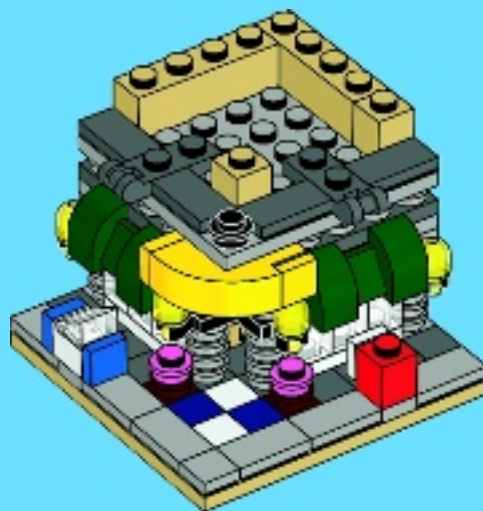

18

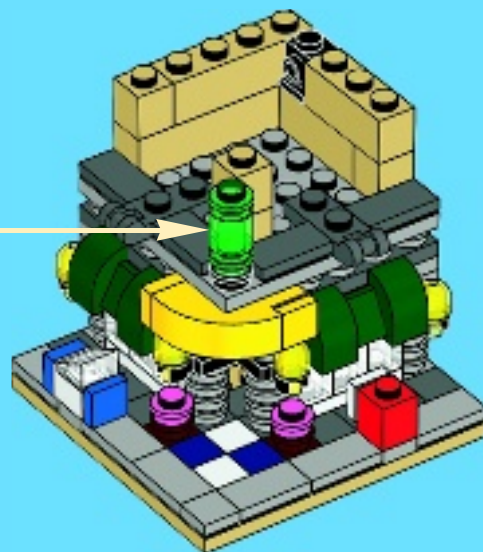



2x

1x

1



4x

2x

8x

2

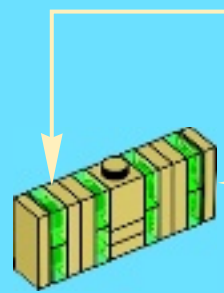
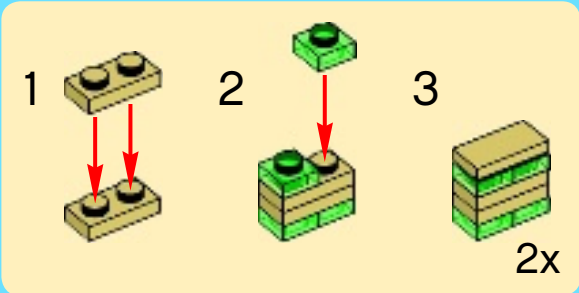

2x

19





20

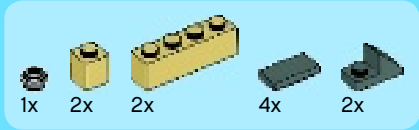
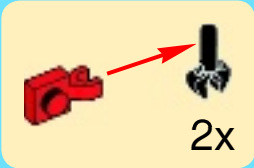

21





1x



1x



2x



1x



2x



1x

22

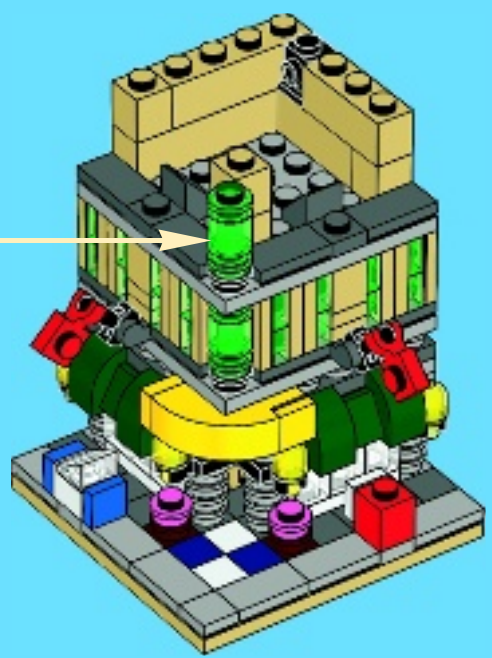



2x

1x



4x

2x

8x

1



2

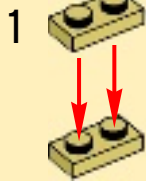

1

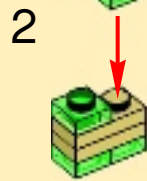

2



3

2x

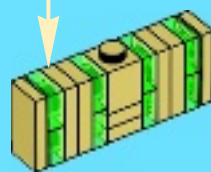

2x

23





1x

24



1x



2x



6x

25





4x



1x



1x



4x

26



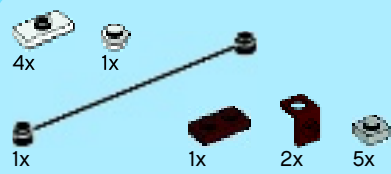

27

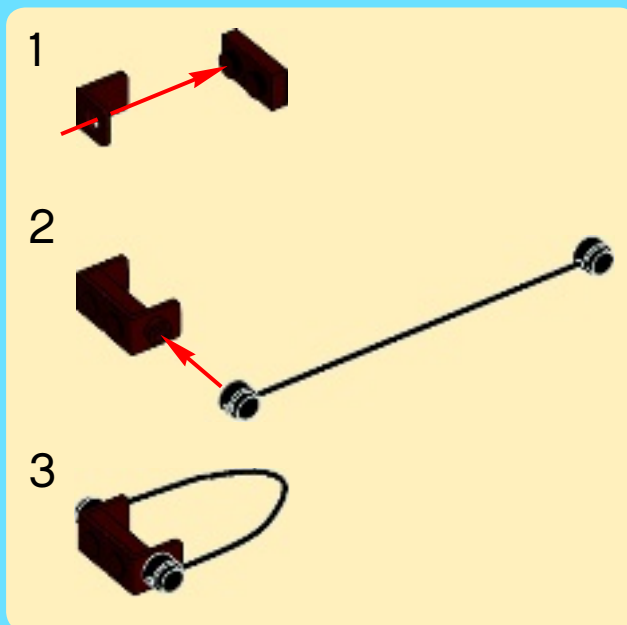



2x



1x

28



1x



6x



1x

29

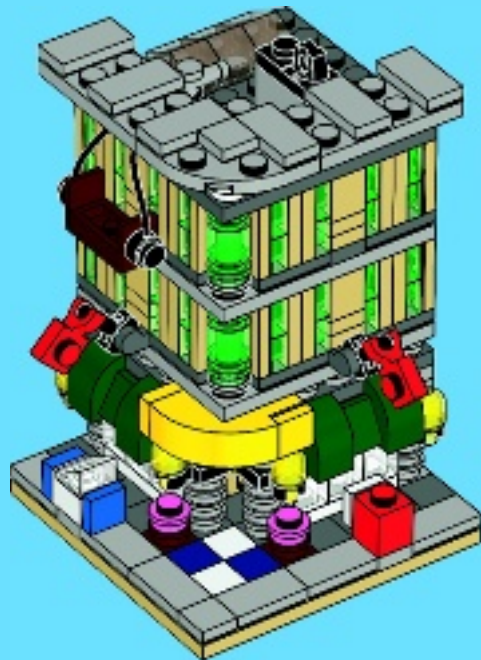

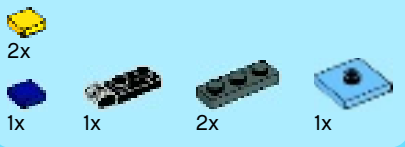

30

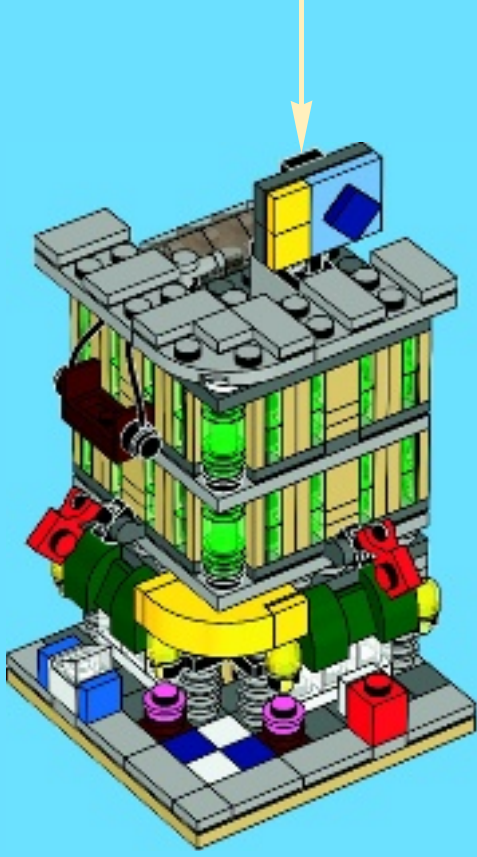
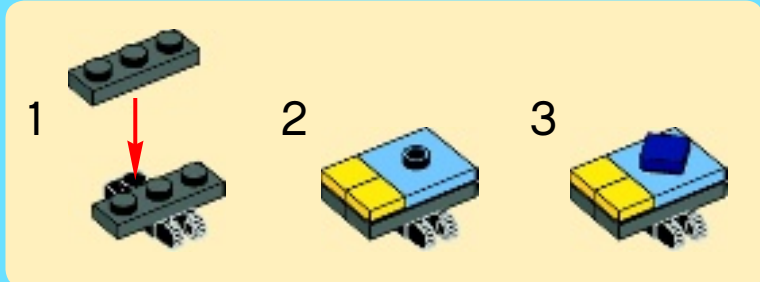

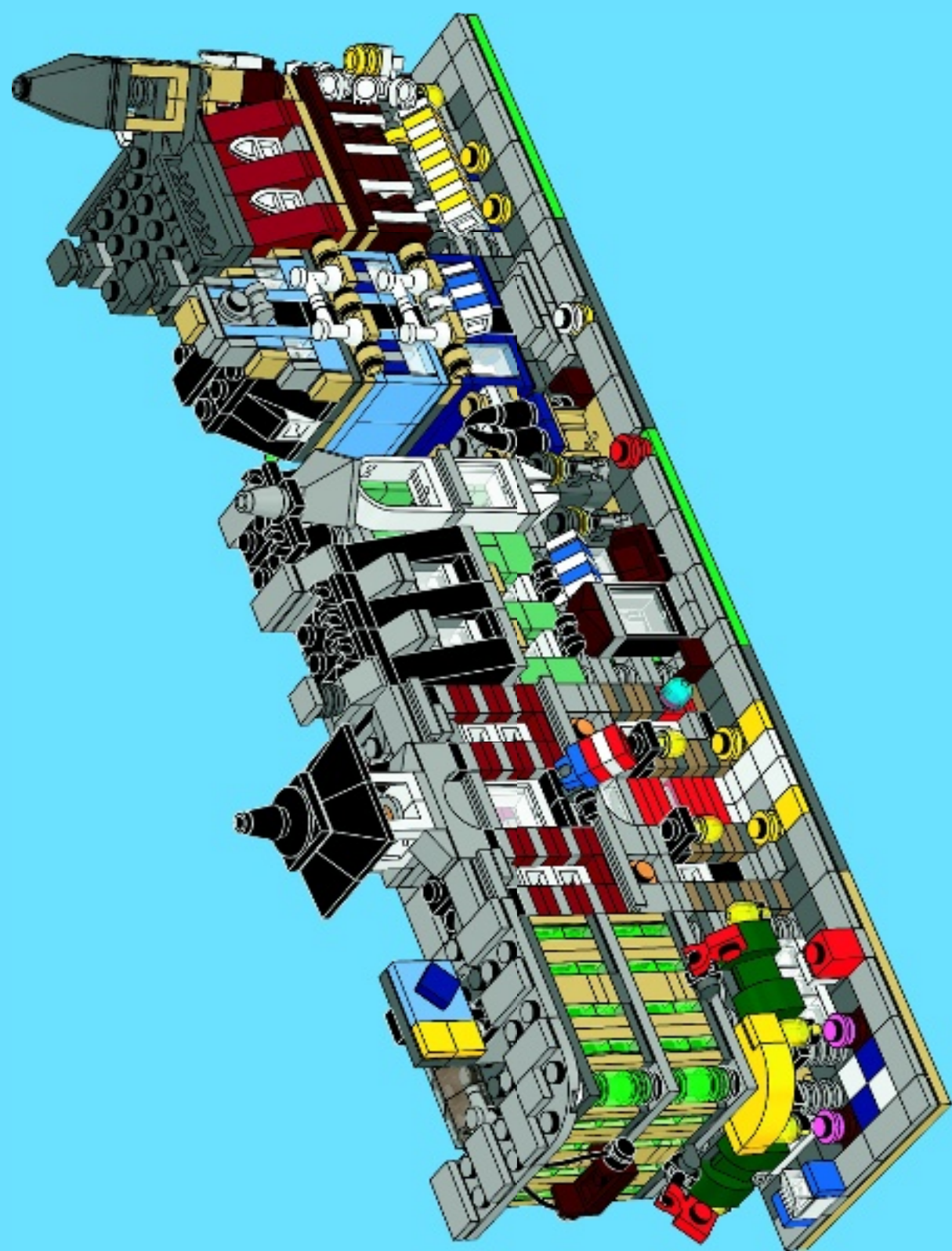

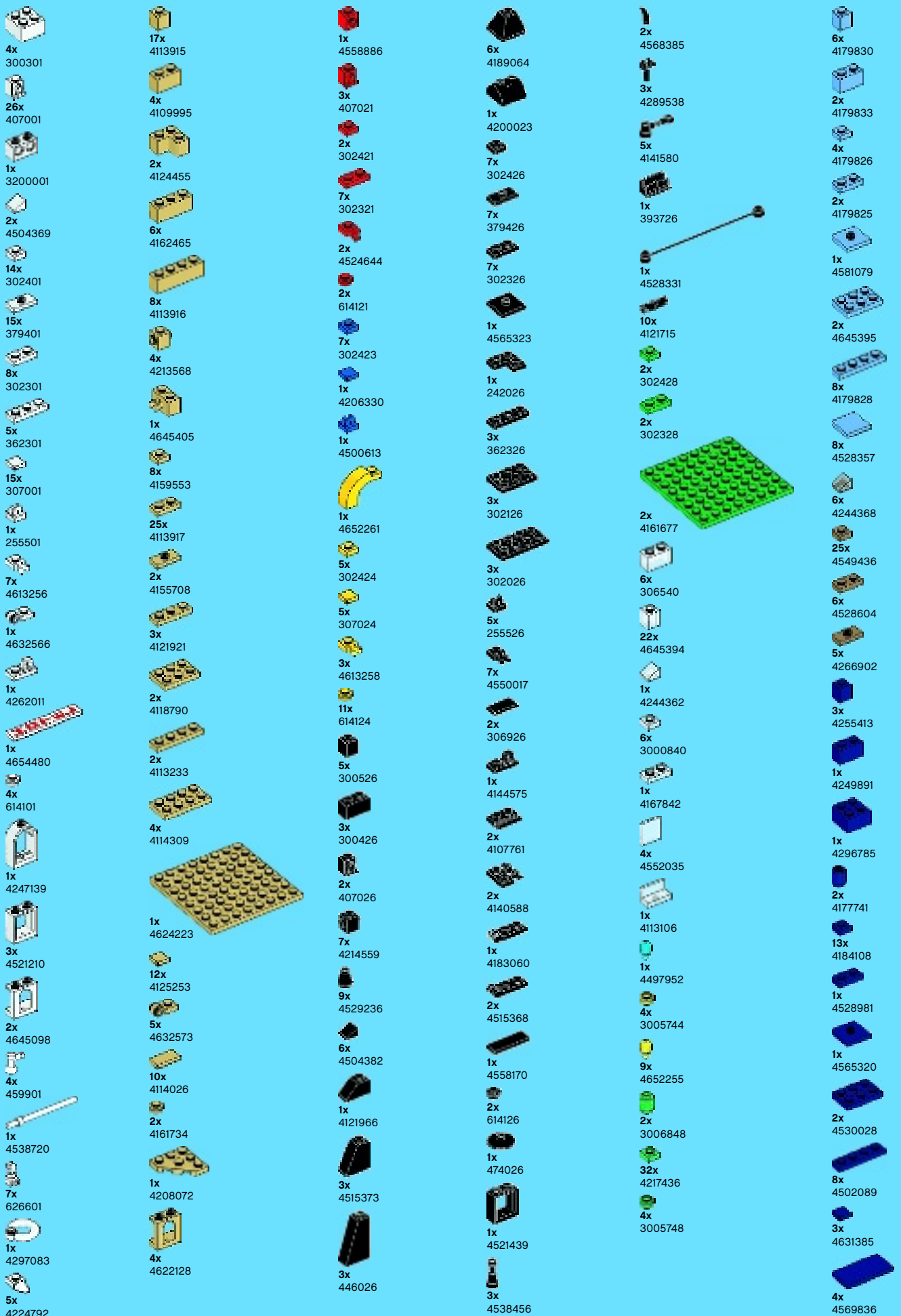

4x 300301
 26x 407001
 1x 3200001
 2x 4504369
 14x 302401
 15x 379401
 8x 302301
 5x 362301
 15x 307001
 1x 255501
 7x 4613256
 1x 4632566
 1x 4262011
 1x 4654480
 4x 614101
 1x 4247139
 3x 4521210
 2x 4645098
 4x 459901
 1x 4538720
 7x 626601
 1x 4297083
 5x 4224792

17x 4113915
 4x 4109995
 2x 4124455
 6x 4162465
 8x 4113916
 4x 4213568
 1x 4645405
 8x 4159553
 25x 4113917
 2x 4155708
 3x 4121921
 2x 4118790
 2x 4113233
 4x 4114309
 1x 4624223
 12x 4125253
 5x 4632573
 10x 4114026
 2x 4161734
 1x 4208072
 4x 4622128

1x 4558886
 3x 407021
 2x 302421
 7x 302321
 2x 4524644
 2x 614121
 7x 302423
 1x 4206330
 1x 4500613
 1x 4652261
 5x 302424
 5x 307024
 3x 4613258
 11x 614124
 5x 300526
 3x 300426
 2x 407026
 7x 4214559
 9x 4529236
 6x 4504382
 1x 4121966
 3x 4515373
 3x 446026

6x 4189064
 1x 4200023
 7x 302426
 7x 379426
 7x 302326
 1x 4565323
 1x 242026
 3x 362326
 3x 302126
 3x 302026
 5x 255526
 7x 4550017
 2x 306926
 1x 4144575
 2x 4107761
 2x 4140588
 1x 4183060
 2x 4515368
 1x 4558170
 2x 614126
 1x 474026
 1x 4521439
 3x 4538456

2x 4568385
 3x 4289538
 5x 4141580
 1x 393726
 1x 4528331
 10x 4121715
 2x 302428
 2x 302328
 2x 4161677
 6x 306540
 22x 4645394
 1x 4244362
 6x 3000840
 1x 4167842
 4x 4552035
 1x 4113106
 1x 4497952
 4x 3005744
 9x 4652255
 2x 3006848
 32x 4217436
 4x 3005748

6x 4179830
 2x 4179833
 4x 4179826
 2x 4179825
 1x 4581079
 2x 4645395
 8x 4179828
 8x 4528357
 6x 4244368
 25x 4549436
 6x 4528604
 5x 4266902
 3x 4255413
 1x 4249891
 1x 4296785
 2x 4177741
 13x 4184108
 1x 4528981
 1x 4565320
 2x 4530028
 8x 4502089
 3x 4631385
 4x 4569836

2x 4521915
 4x 4245570
 2x 4504375
 4x 4588024
 9x 4521948
 10x 4616581
 5x 4521950
 4x 4521947
 12x 4541376
 6x 4539102
 6x 4645101
 28x 4539114
 6x 4539063
 5x 4539097
 4x 4539061
 3x 4550169
 1x 4654448

2x 4211149
 2x 4211220
 2x 4211225
 2x 4211201
 2x 4645102
 1x 4211252
 2x 4504376
 6x 4221744
 4x 4211150
 4x 4211152
 2x 4211189
 1x 4243838
 4x 4211151
 6x 4645103
 20x 4216581
 1x 4616702
 4x 4645400
 1x 4211218
 2x 4611100

12x 4211389
 22x 4211388
 3x 4211387
 2x 4211349
 2x 4211428
 3x 4558953
 1x 4211511
 2x 4211598
 1x 4529241
 8x 4211541
 11x 4521921
 1x 4216250
 3x 4645397
 4x 4211435
 65x 4211399
 22x 4211398
 21x 4211451
 1x 4211353
 6x 4211397
 21x 4211429
 5x 4211396

12x 4211445
 7x 4211395
 2x 4211425
 3x 4211406
 2x 4211474
 1x 4211369
 22x 4211415
 1x 4515341
 39x 4211414
 5x 4211568
 2x 4515369
 1x 4211419
 1x 4211498
 46x 4211525
 1x 4645412
 1x 4211515
 1x 4211503
 1x 4211753
 2x 4581155
 1x 4211470

3x 4211104
 2x 4558955
 2x 4580437
 2x 4210636
 1x 4211128
 10x 4211090
 1x 4210762
 2x 4621917
 1x 4645099
 1x 4652259
 20x 4210719
 2x 4211119
 5x 4211063
 3x 4211094
 5x 4210635
 9x 4211133
 5x 4211043
 6x 4211001

2x 4211065
 2x 4539429
 1x 4211134
 2x 4210802
 27x 4210848
 10x 4211052
 2x 4543086
 3x 4210660
 1x 4211055
 5x 4521187
 1x 4225733
 20x 4210633
 2x 4219725
 1x 4289542
 2x 4243576
 1x 4529247
 2x 4523159

Customer Service
 Kundenservice
 Service Consommateurs
 Servicio Al Consumidor

www.lego.com/service or dial



: 00800 5346 5555
 : 1-800-422-5346



WIN!

Go to www.LEGOsurvey.com/product to fill out a survey for a chance to win a cool LEGO® Product. No purchase necessary. Open to all residents where not prohibited.



www.LEGO.com



www.LEGOsurvey.com/product

GEWINNE!

Nimm an der Umfrage auf www.LEGOsurvey.com/product teil und hab die Chance ein cooles LEGO® Produkt zu gewinnen! Die Teilnahme am Gewinnspiel führt zu keinerlei Kaufverpflichtungen. Teilnahme in allen nicht ausgeschlossenen Ländern möglich.

WIN!

Ga naar www.LEGOsurvey.com/product, vul een enquêteformulier in en maak kans op een cool LEGO® product. Geen aankoopverplichting. Iedereen mag deelnemen, uitgezonderd ingezetenden van landen waar een enquêteverbod geldt.

GAGNE!

Visite www.LEGOsurvey.com/product pour répondre à un questionnaire et avoir une chance de gagner un produit LEGO® très cool! Aucune obligation d'achat. Ouvert à tous les résidents des pays autorisés.

当てよう!

www.LEGOsurvey.com/product にアクセスして、アンケートにご記入ください。当選者にはレゴ®製品を差し上げます。お買い上げの必要はありません。禁止されていない限り、すべての皆様にご利用いただけます。