

10224









1

+

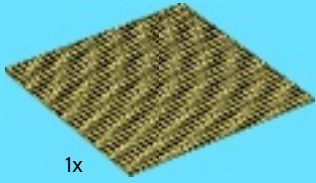

1x

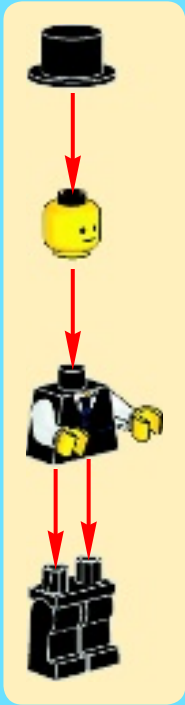



5x



2x

1

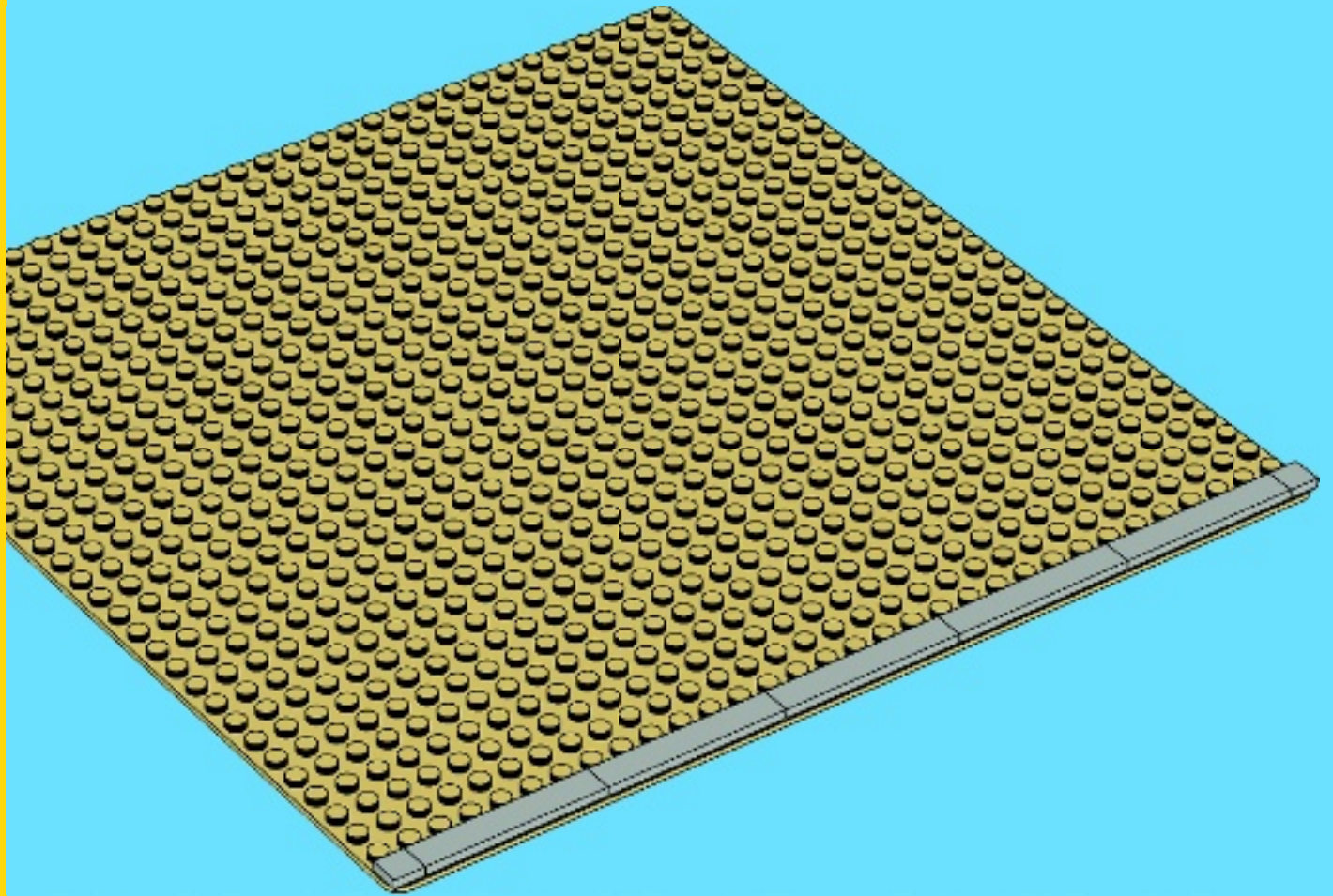



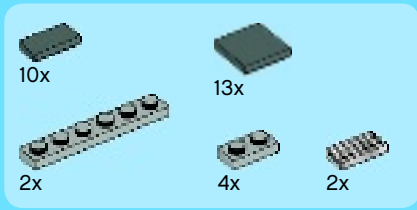

2

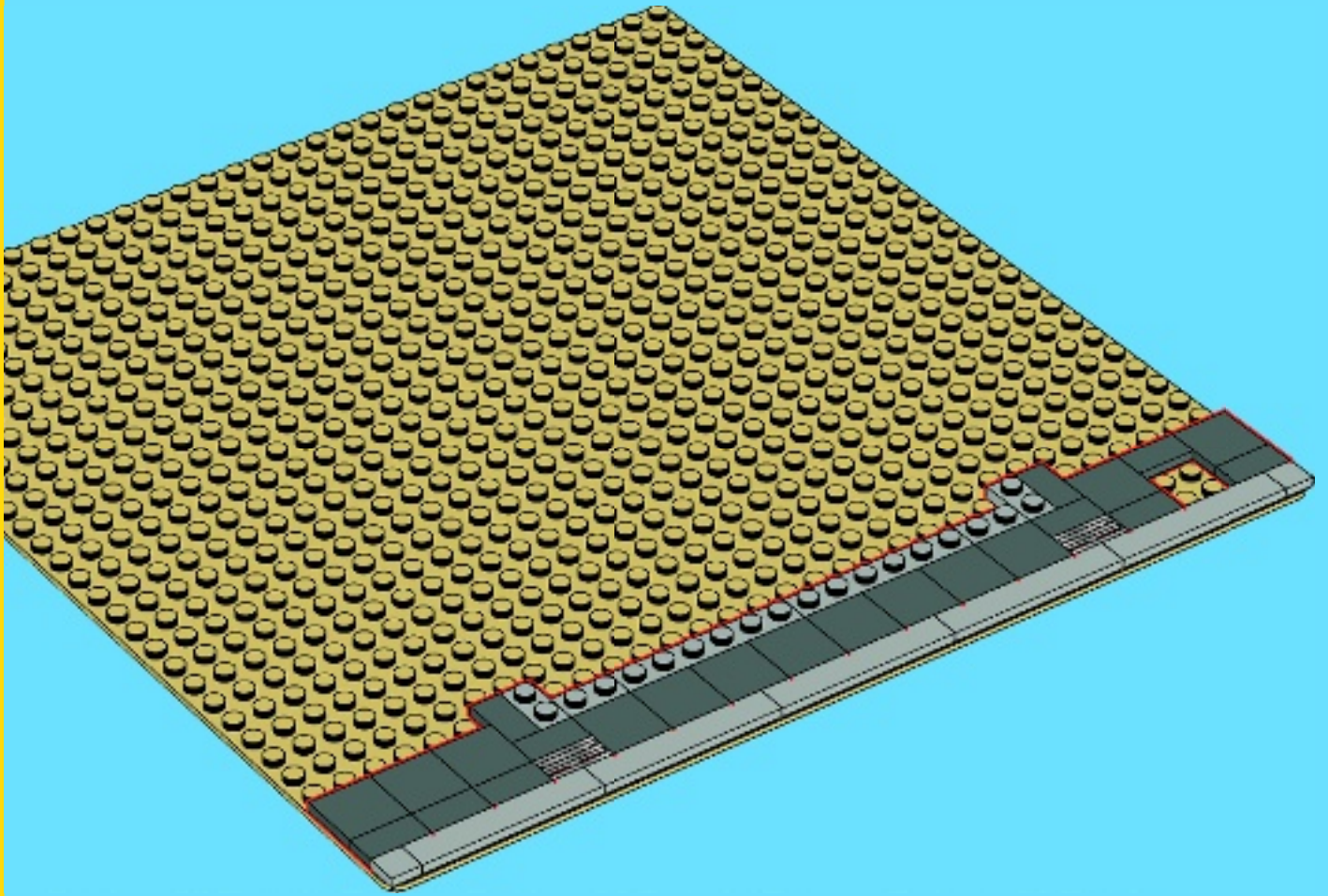



4x



6x



2x



2x



2x

# 3

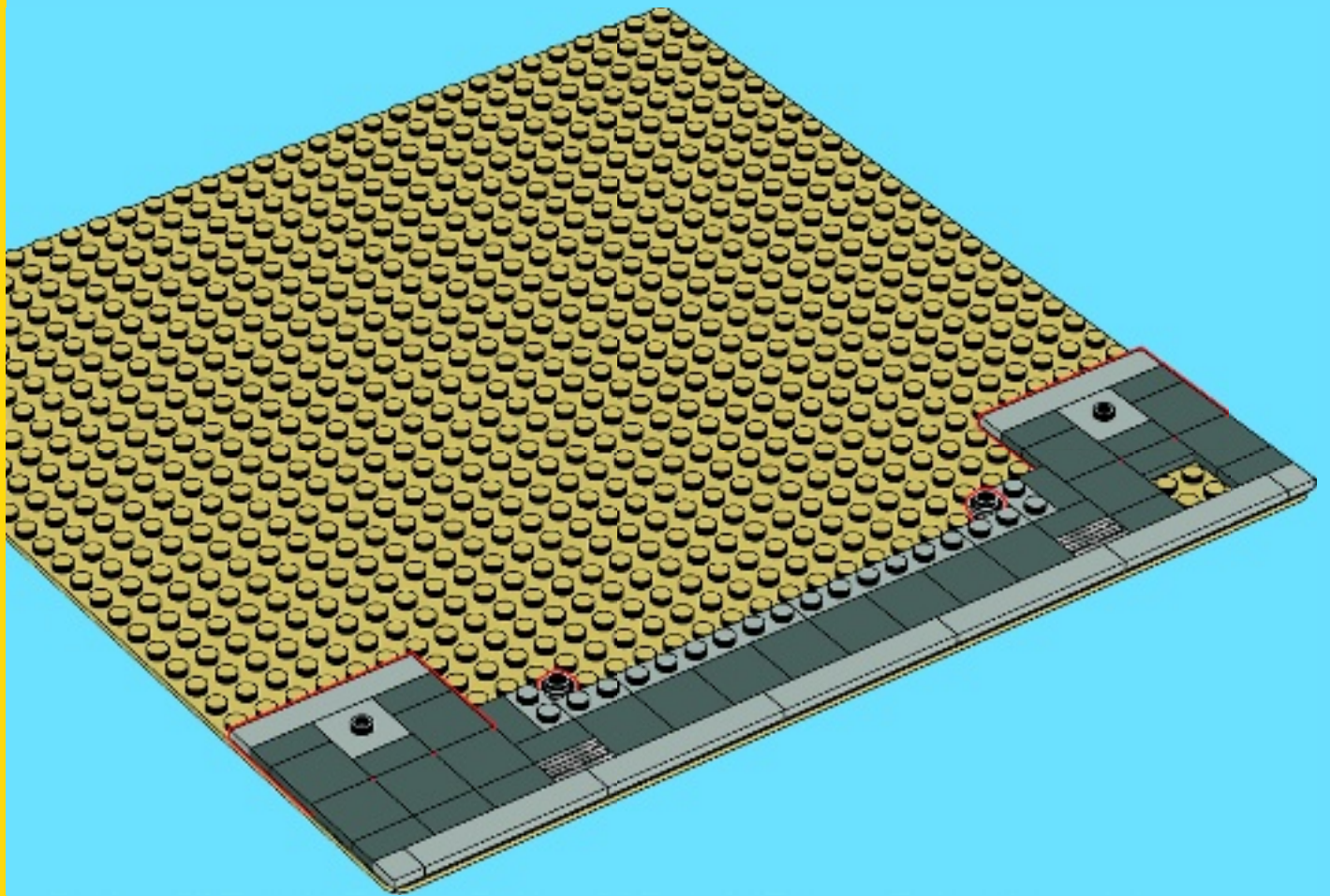



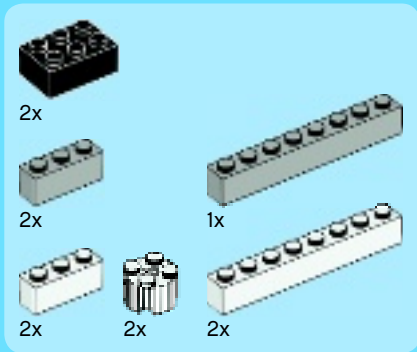

4

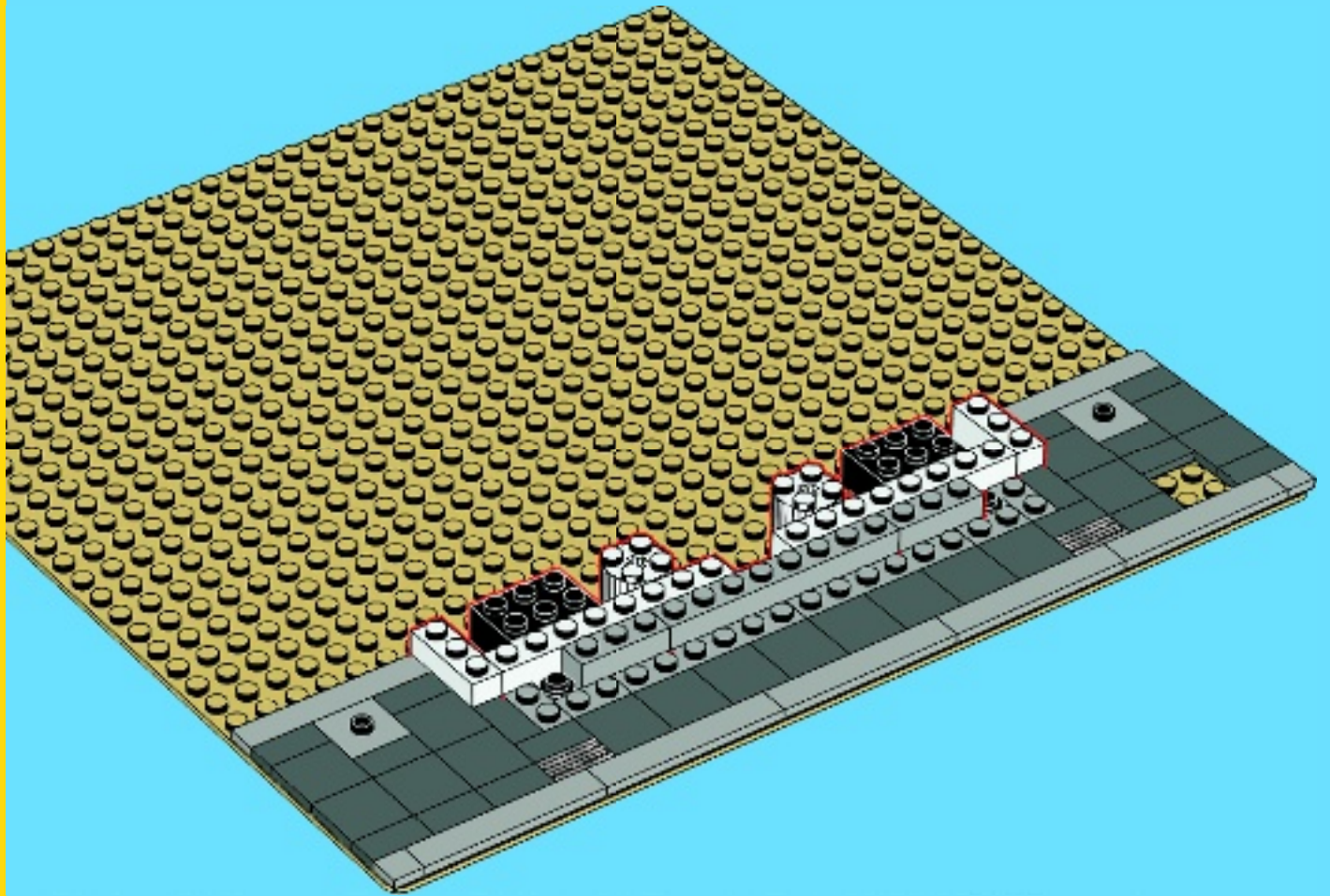

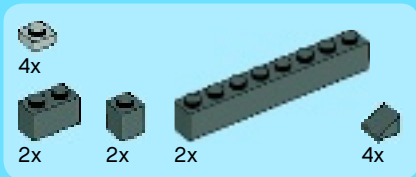

5

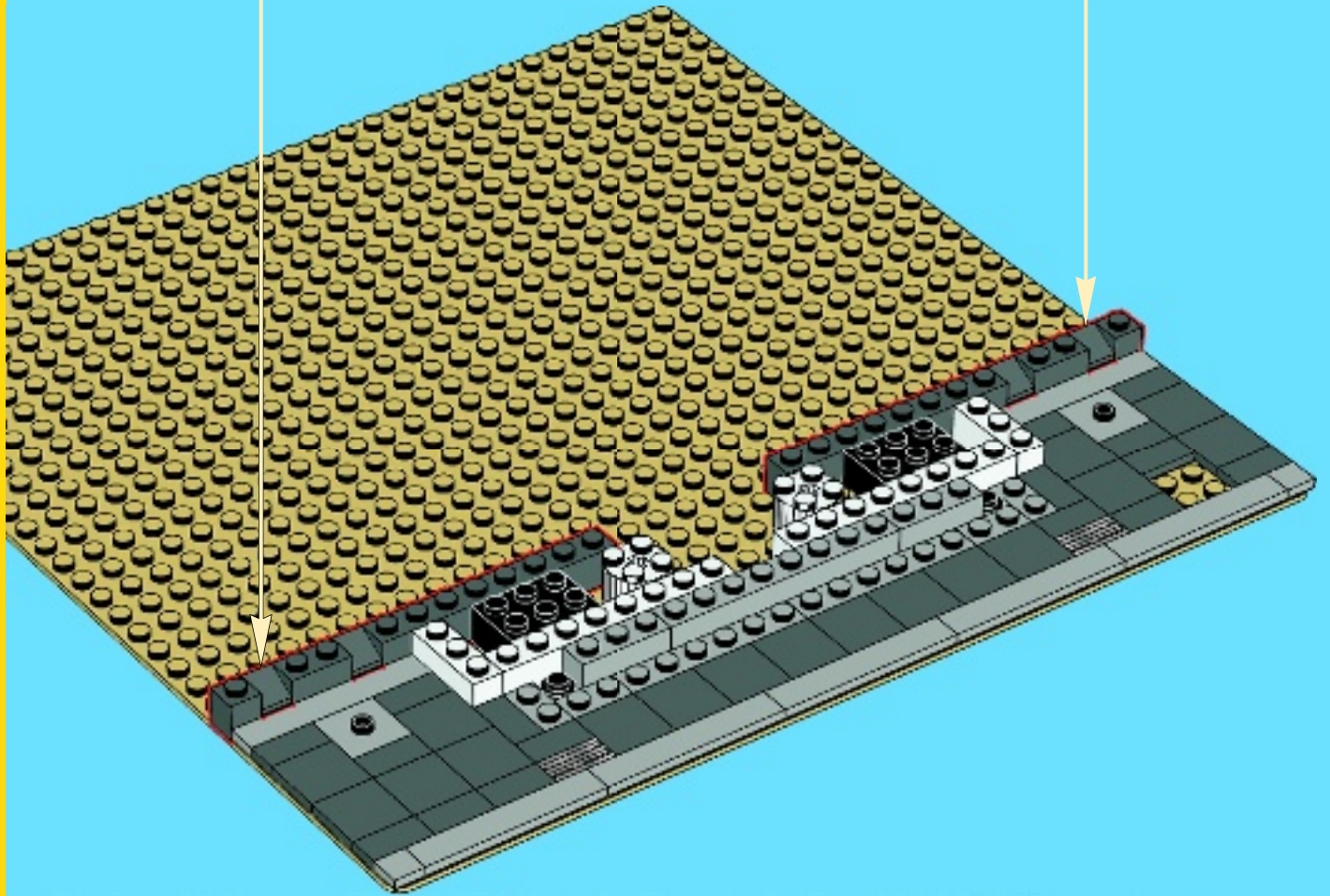
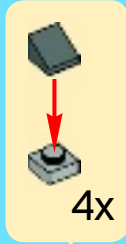



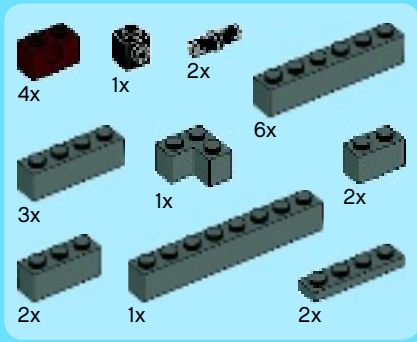

6

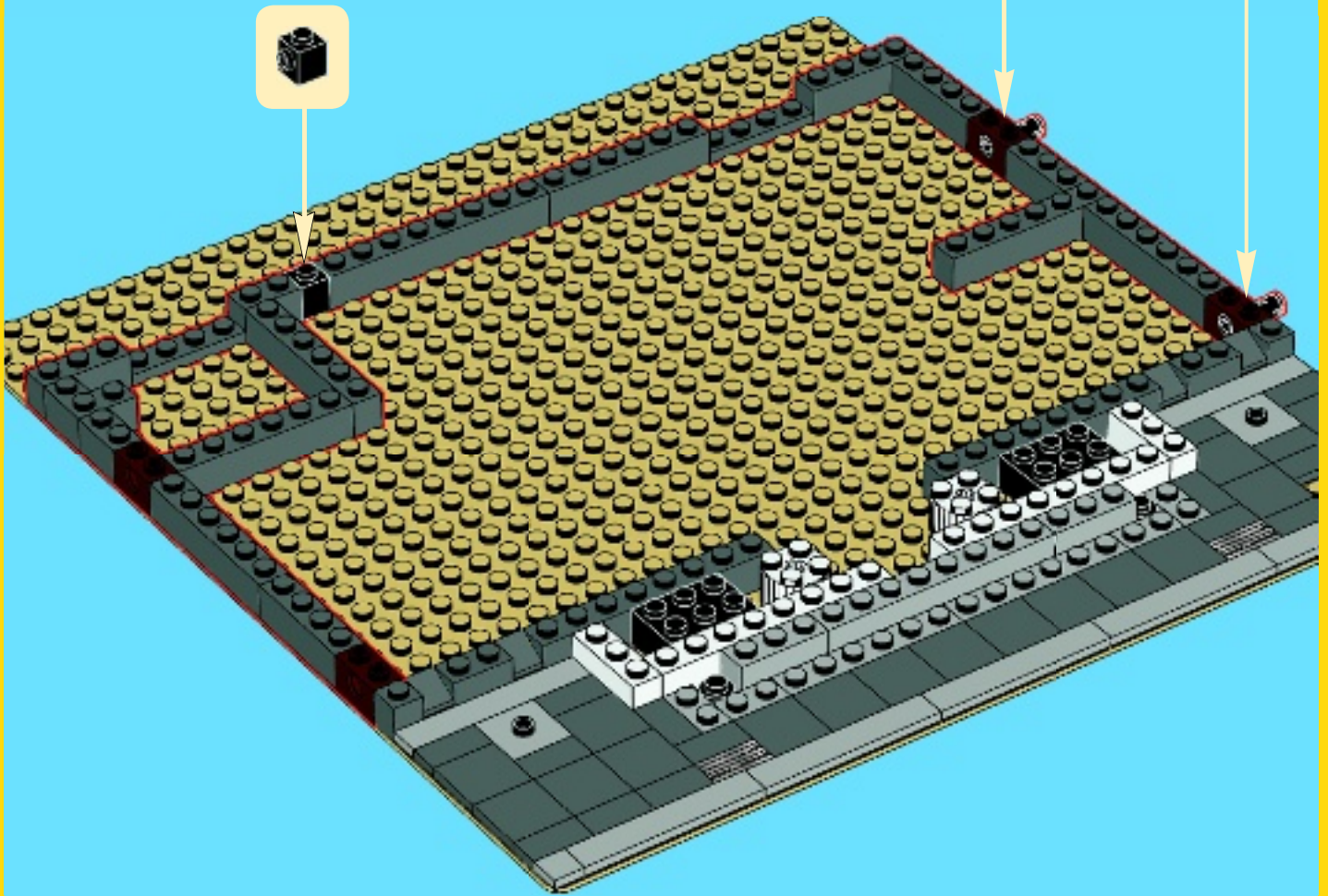
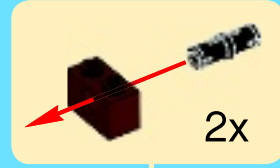

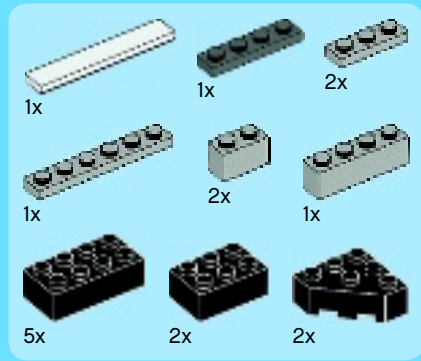

7

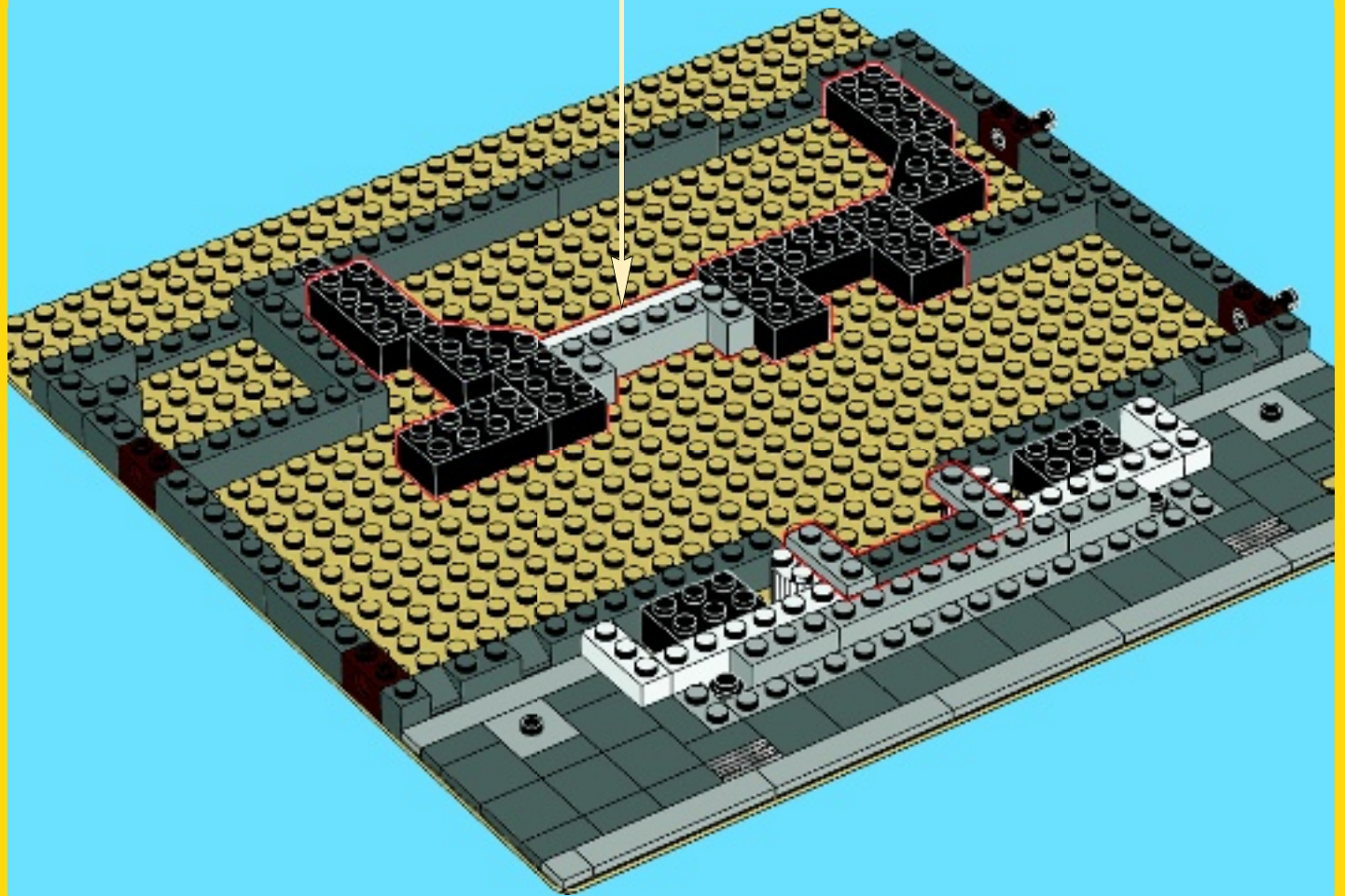
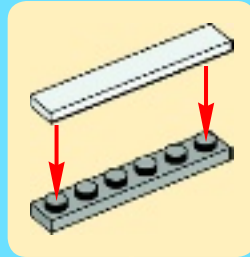



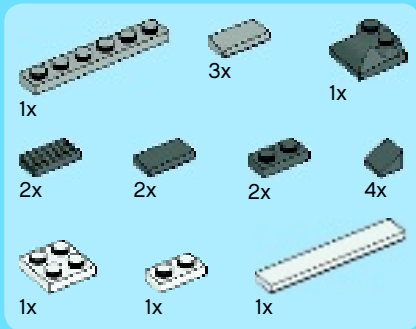

8

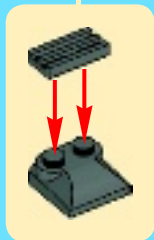
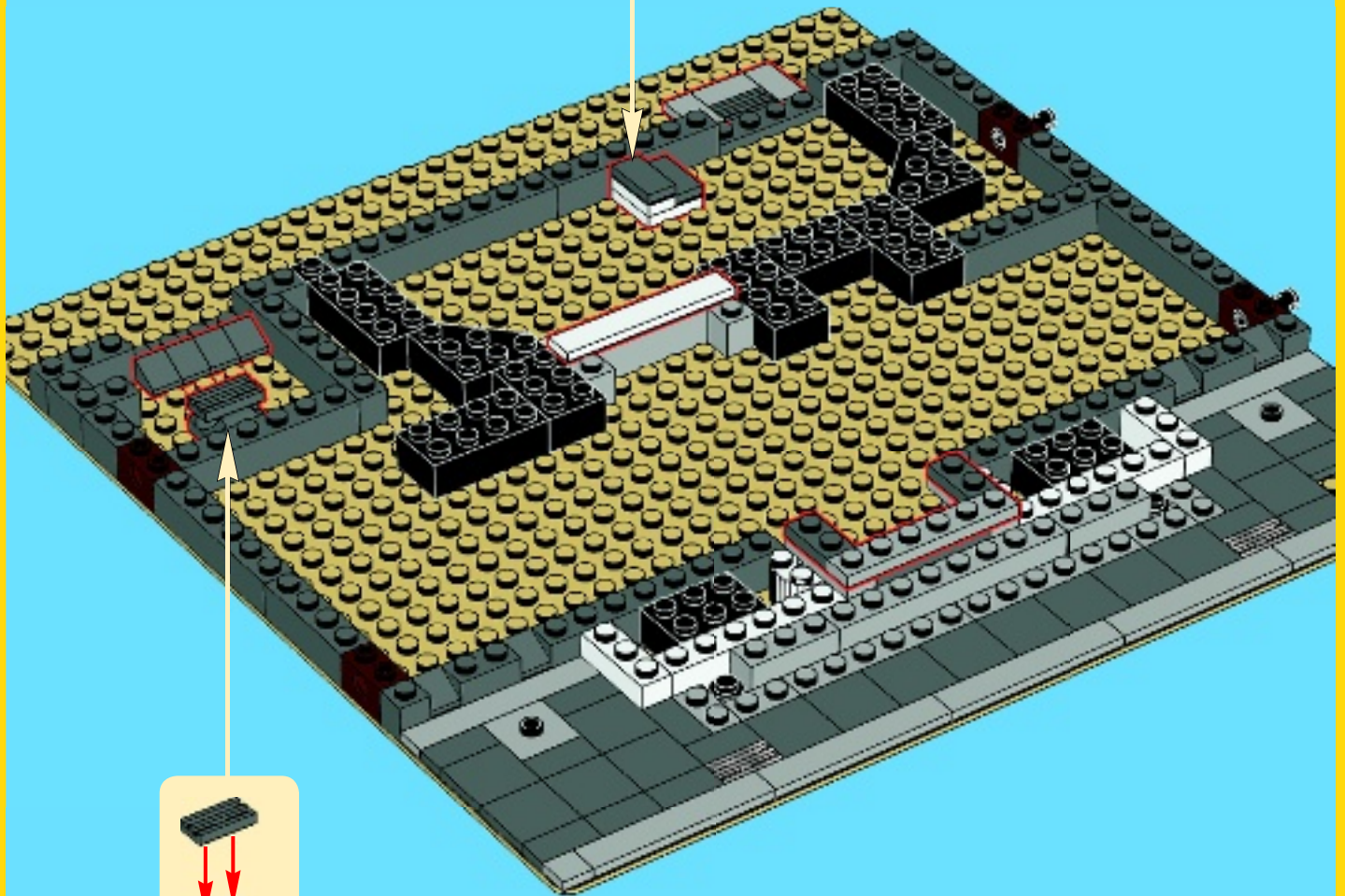
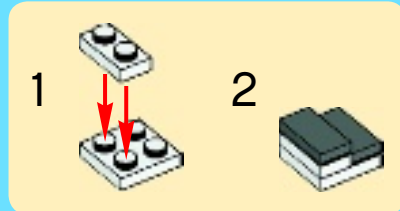

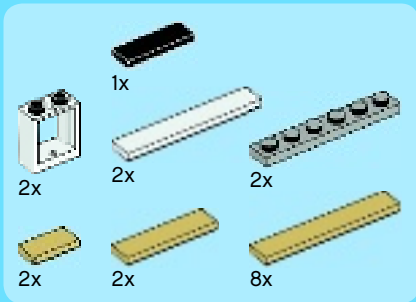

9

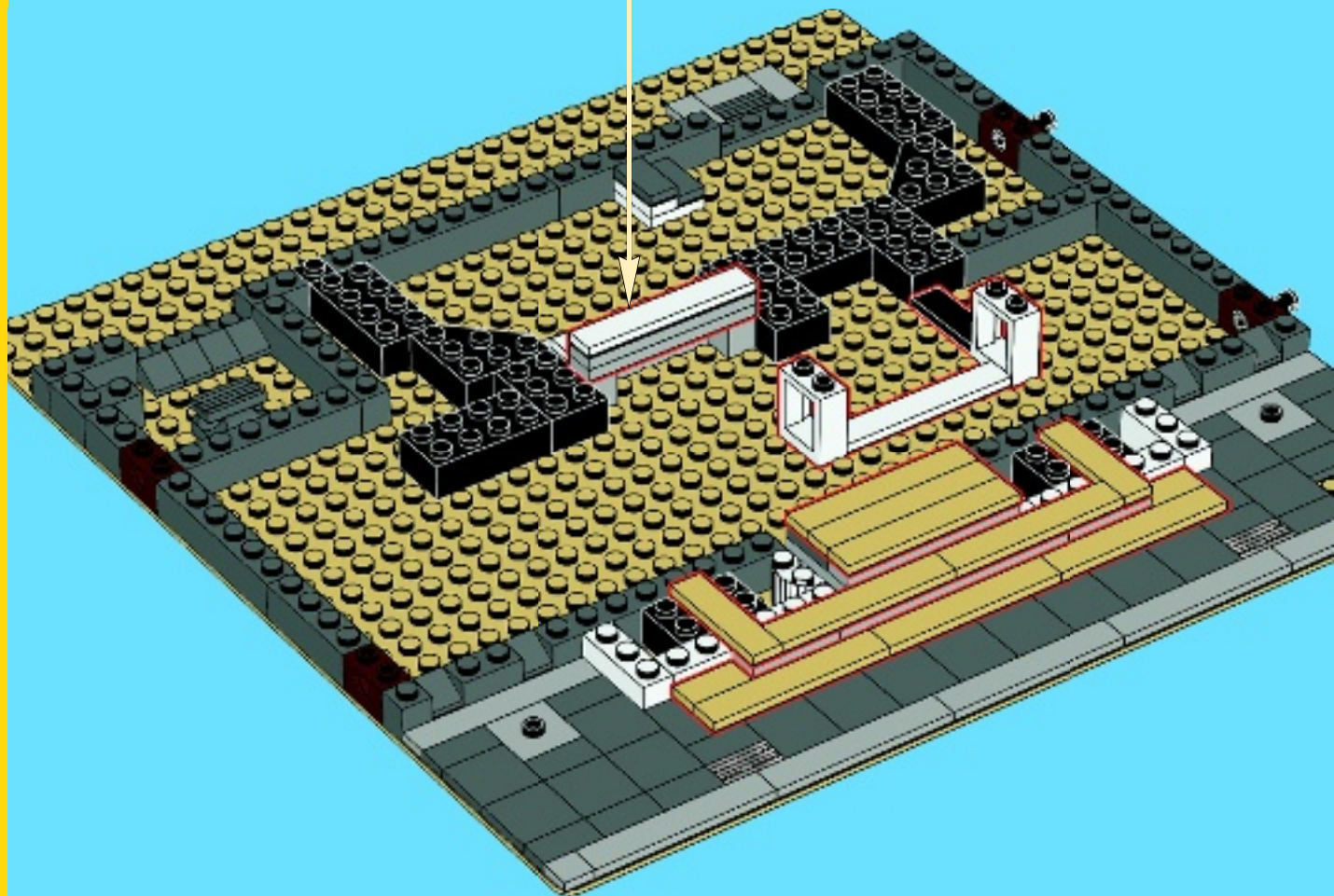
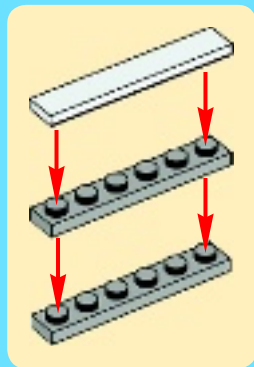



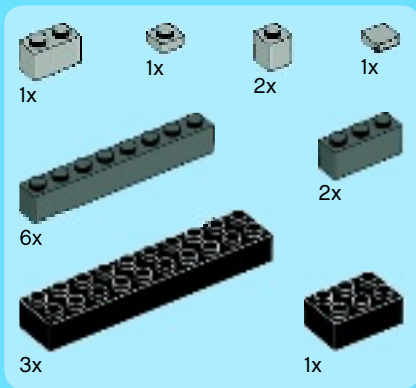

10

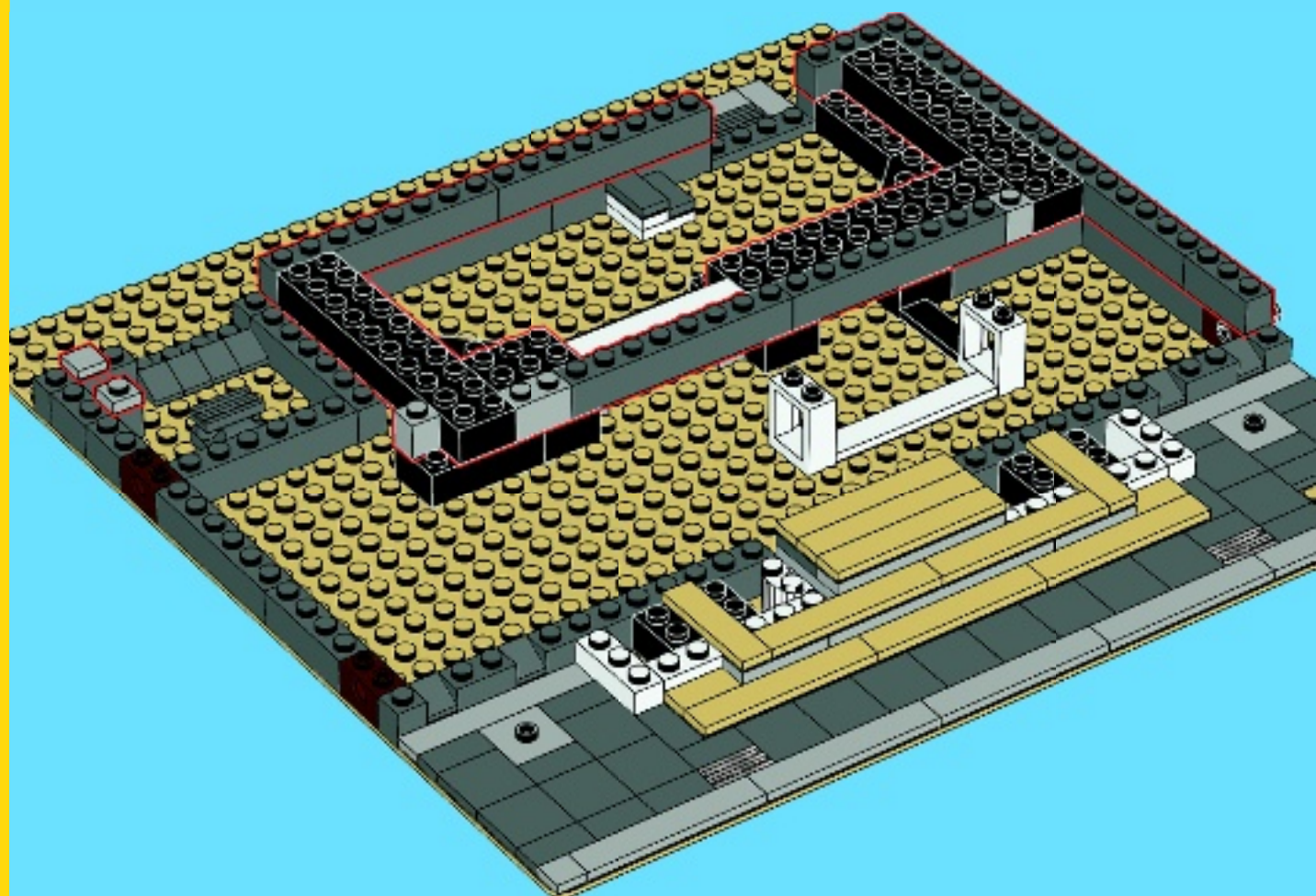

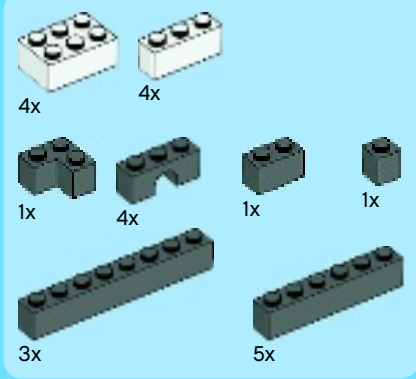

# 11

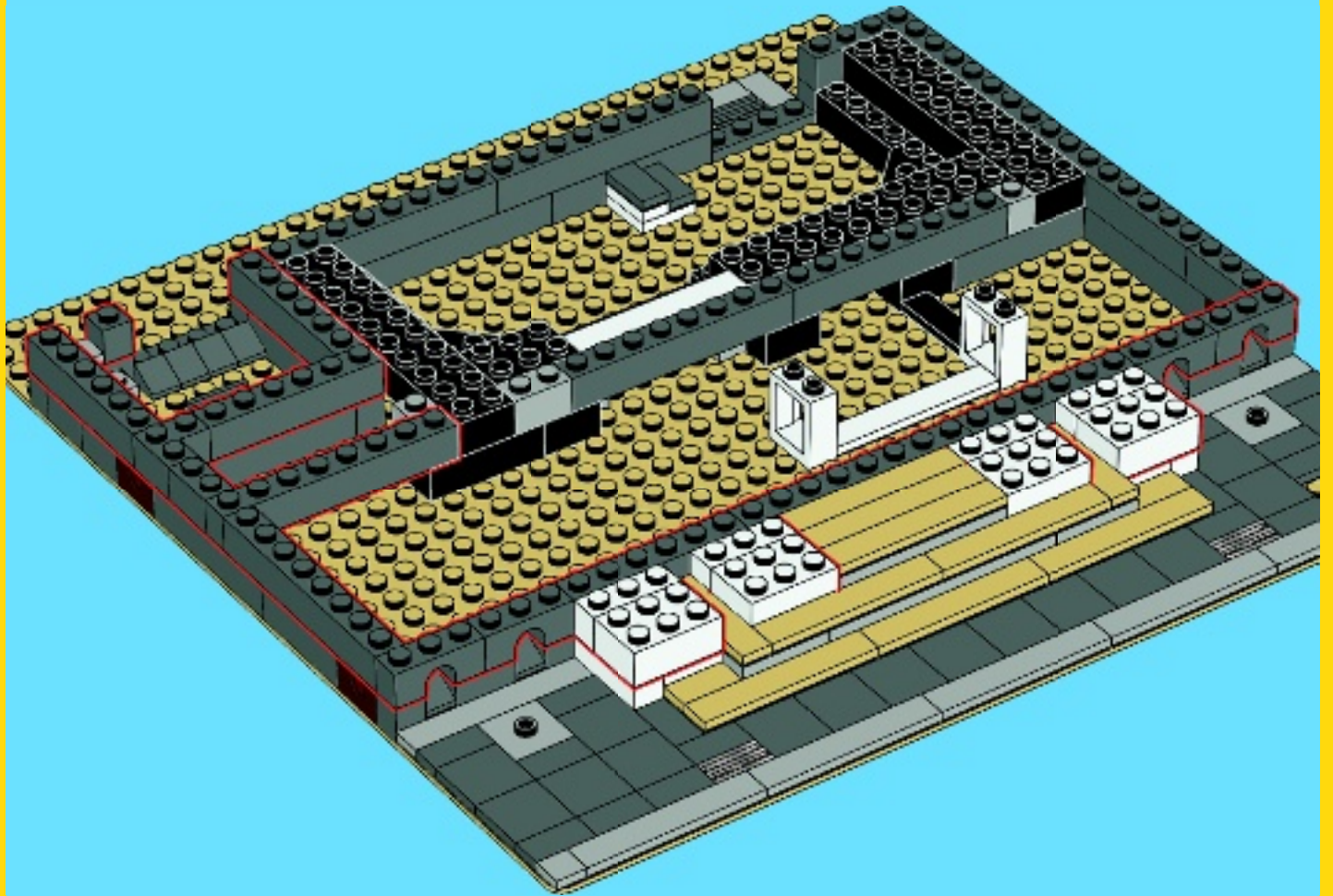



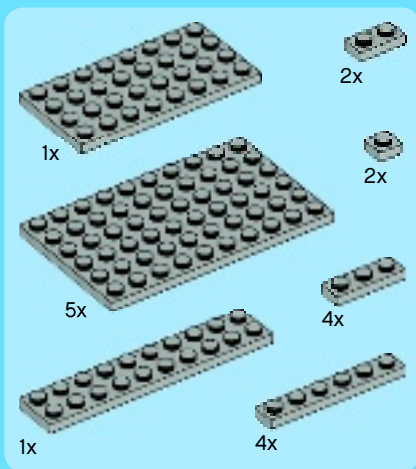

12

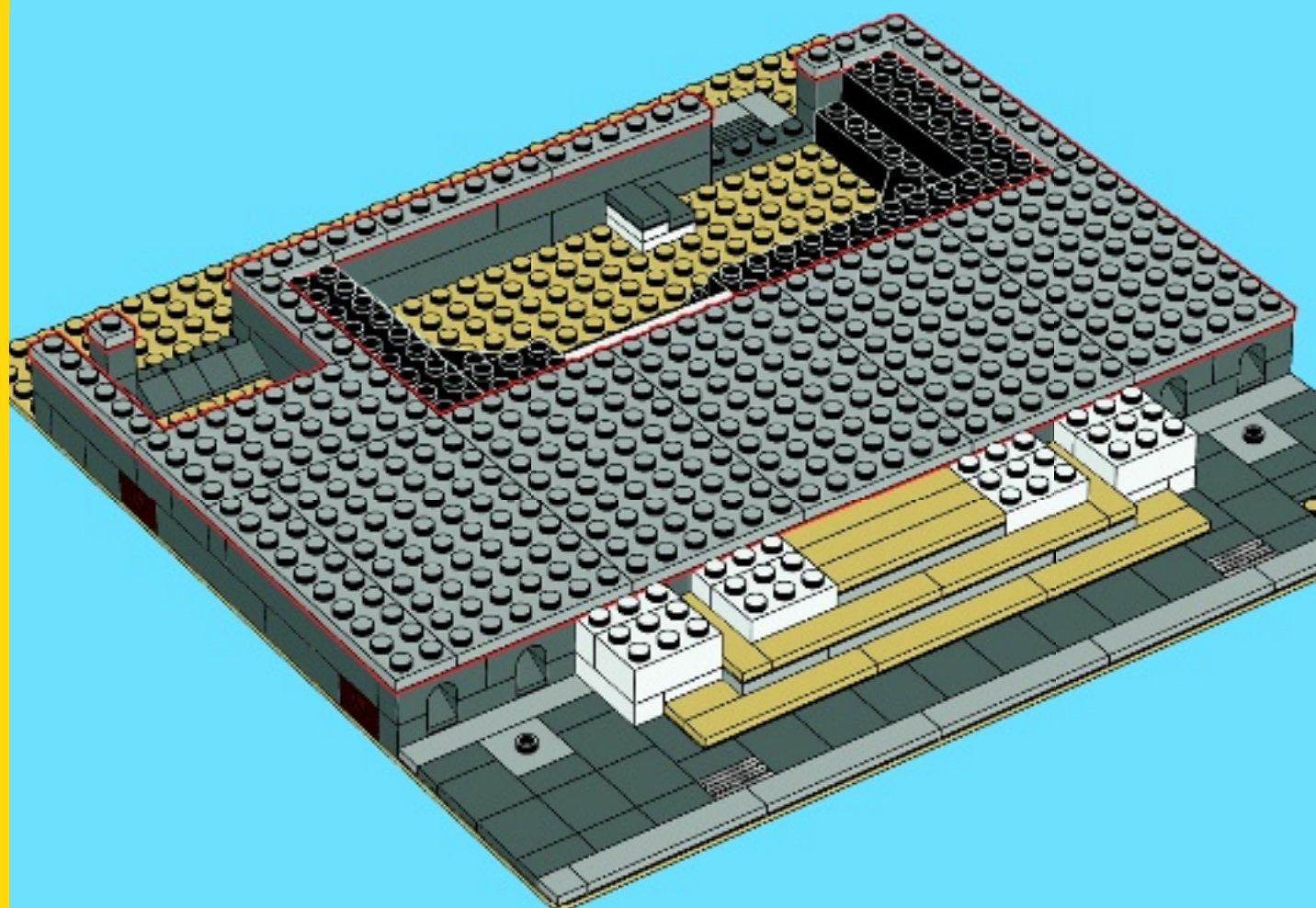

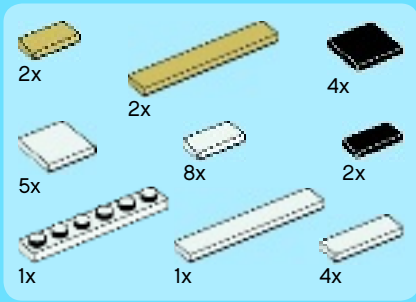

# 13

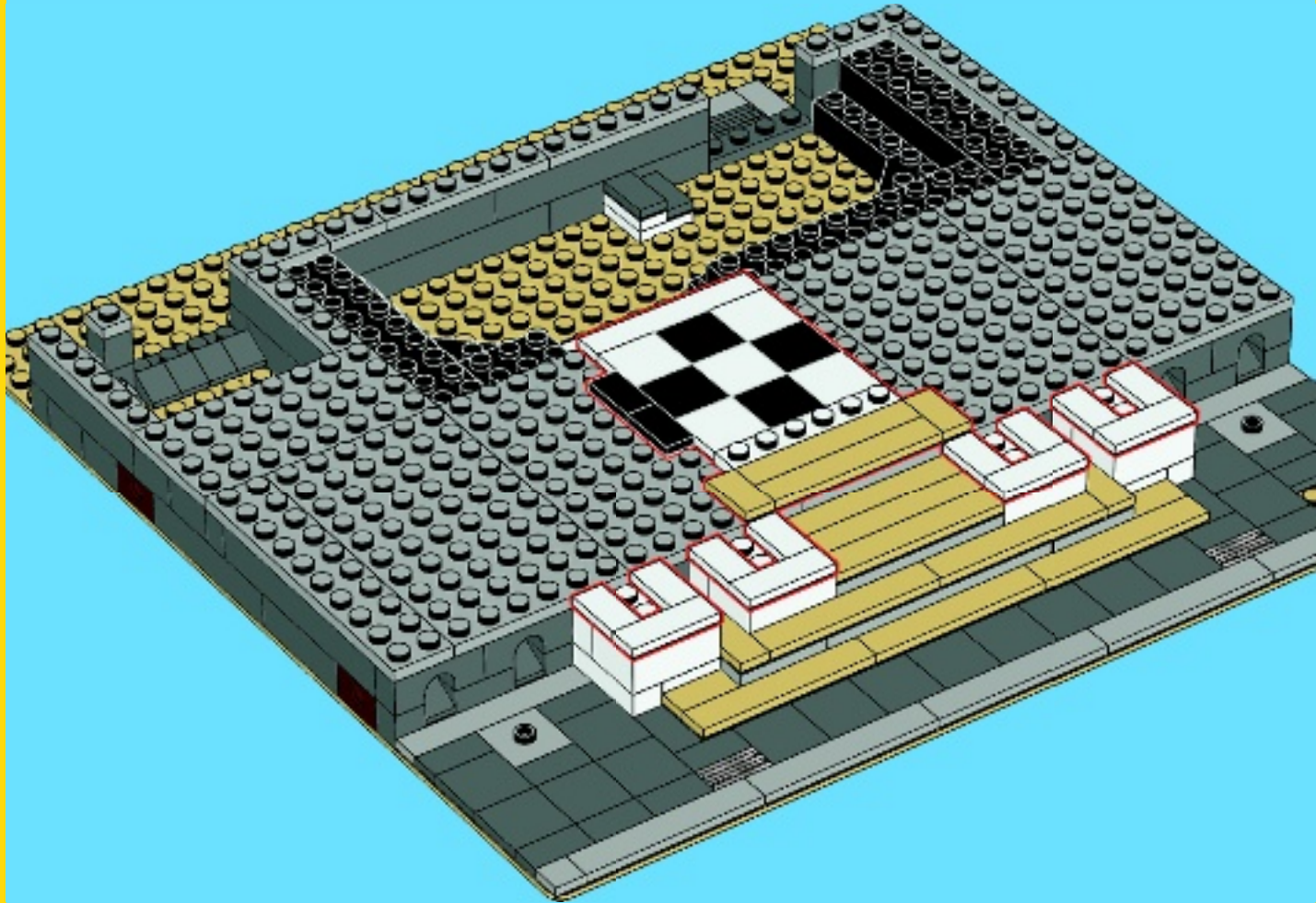



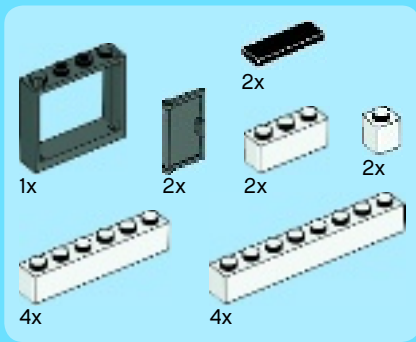

# 14

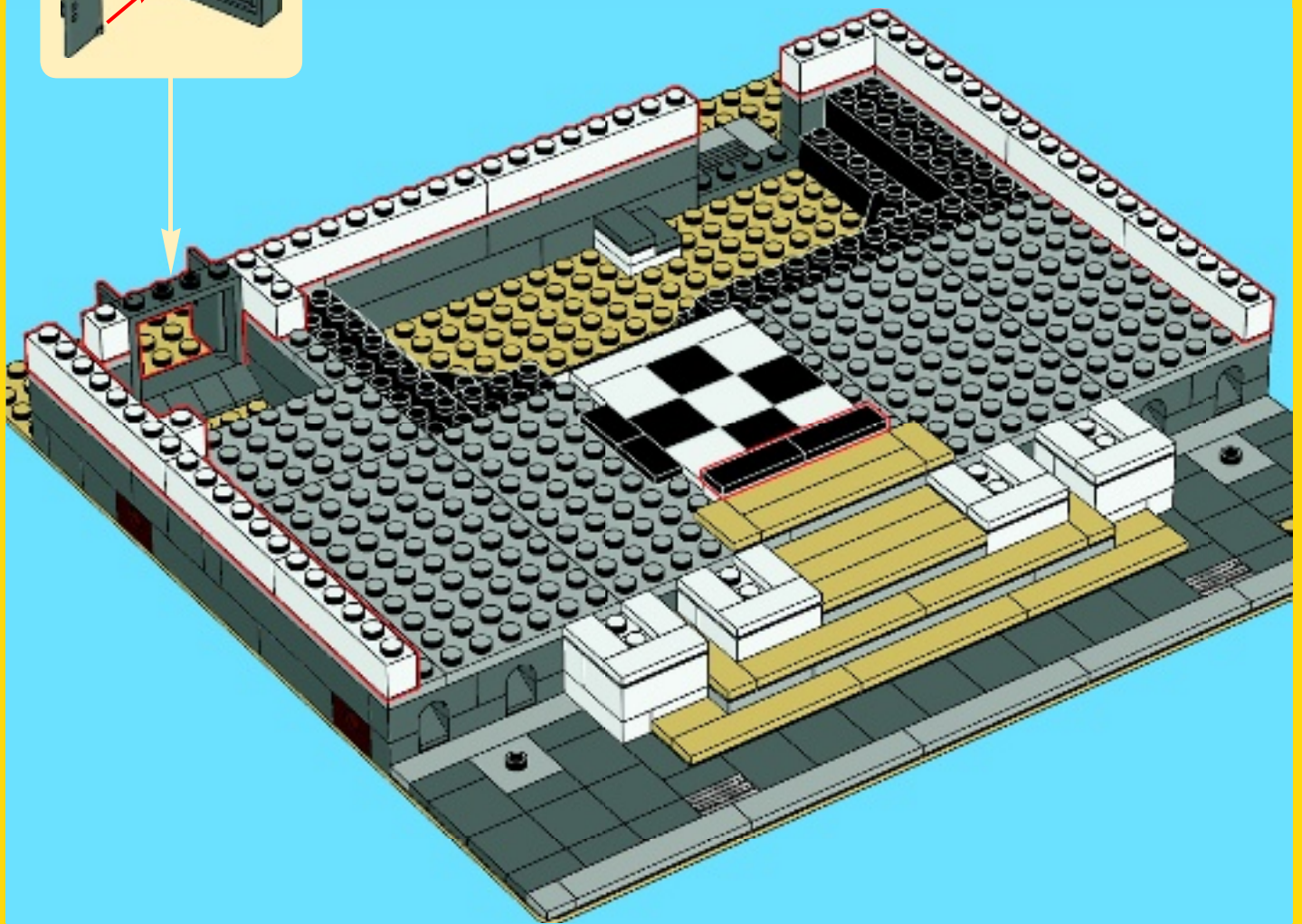
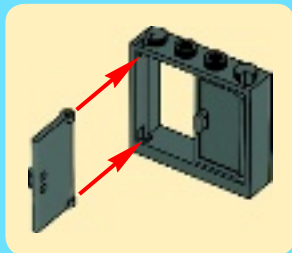

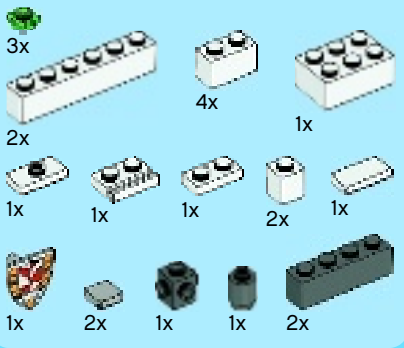

# 15

1

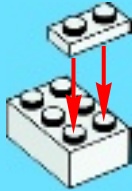

2

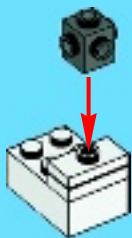

3

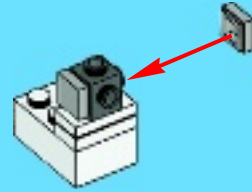

4

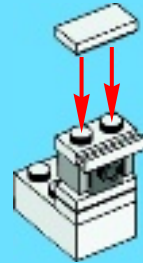

5





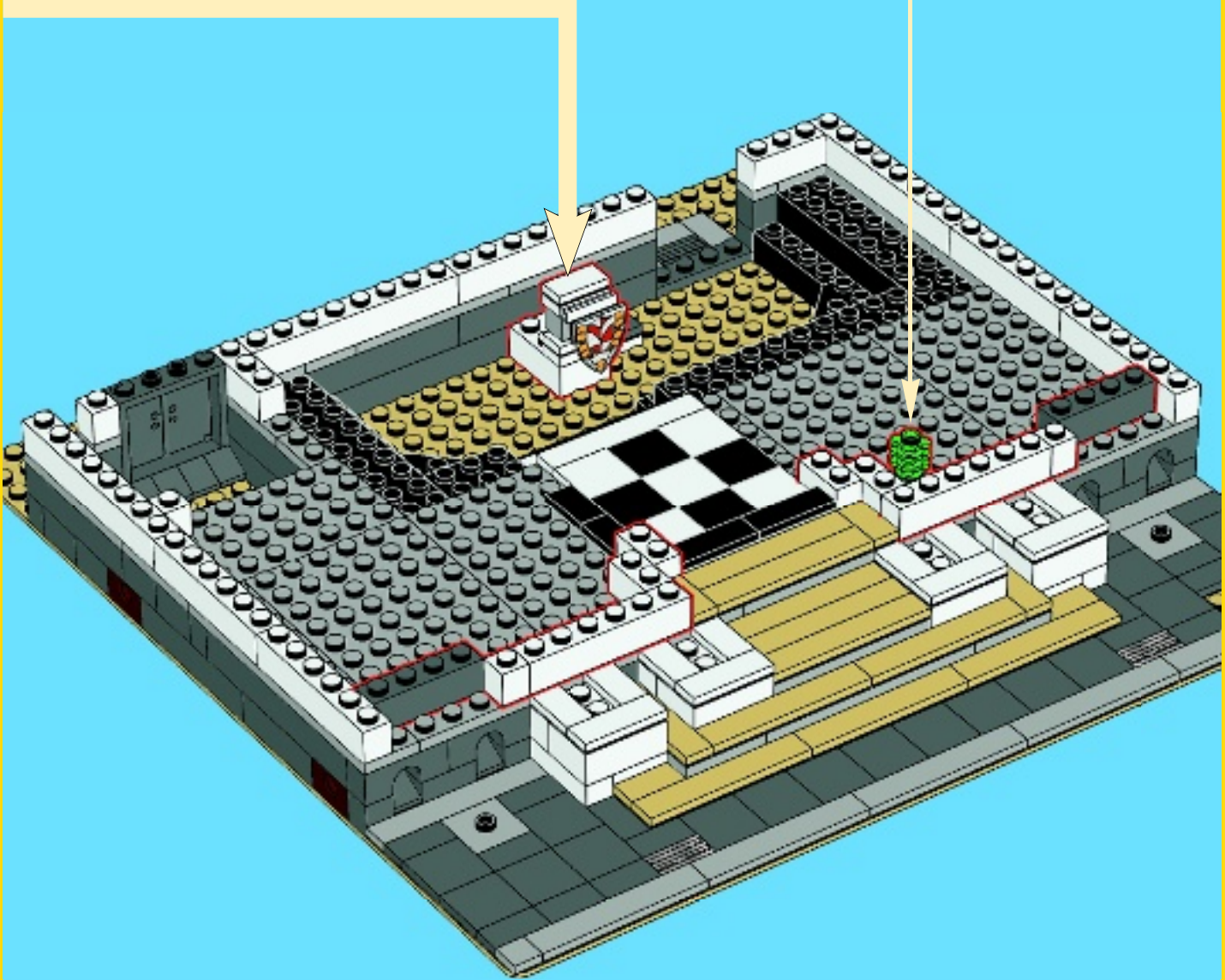
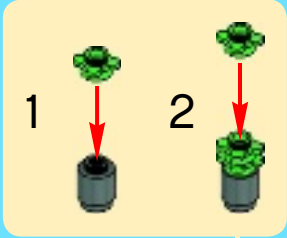

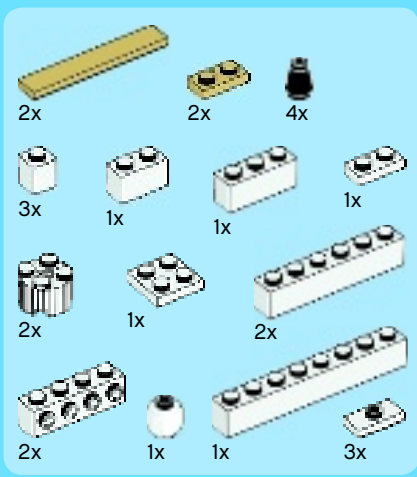

# 16

1

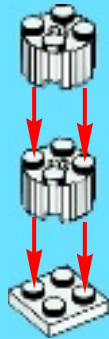

2

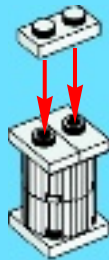

3

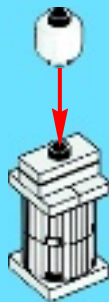



1

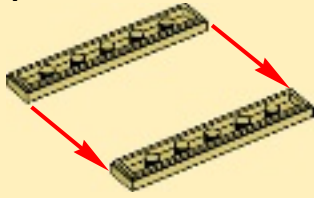

2

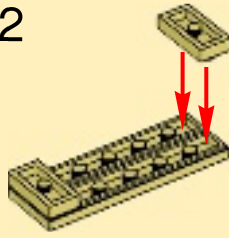

3

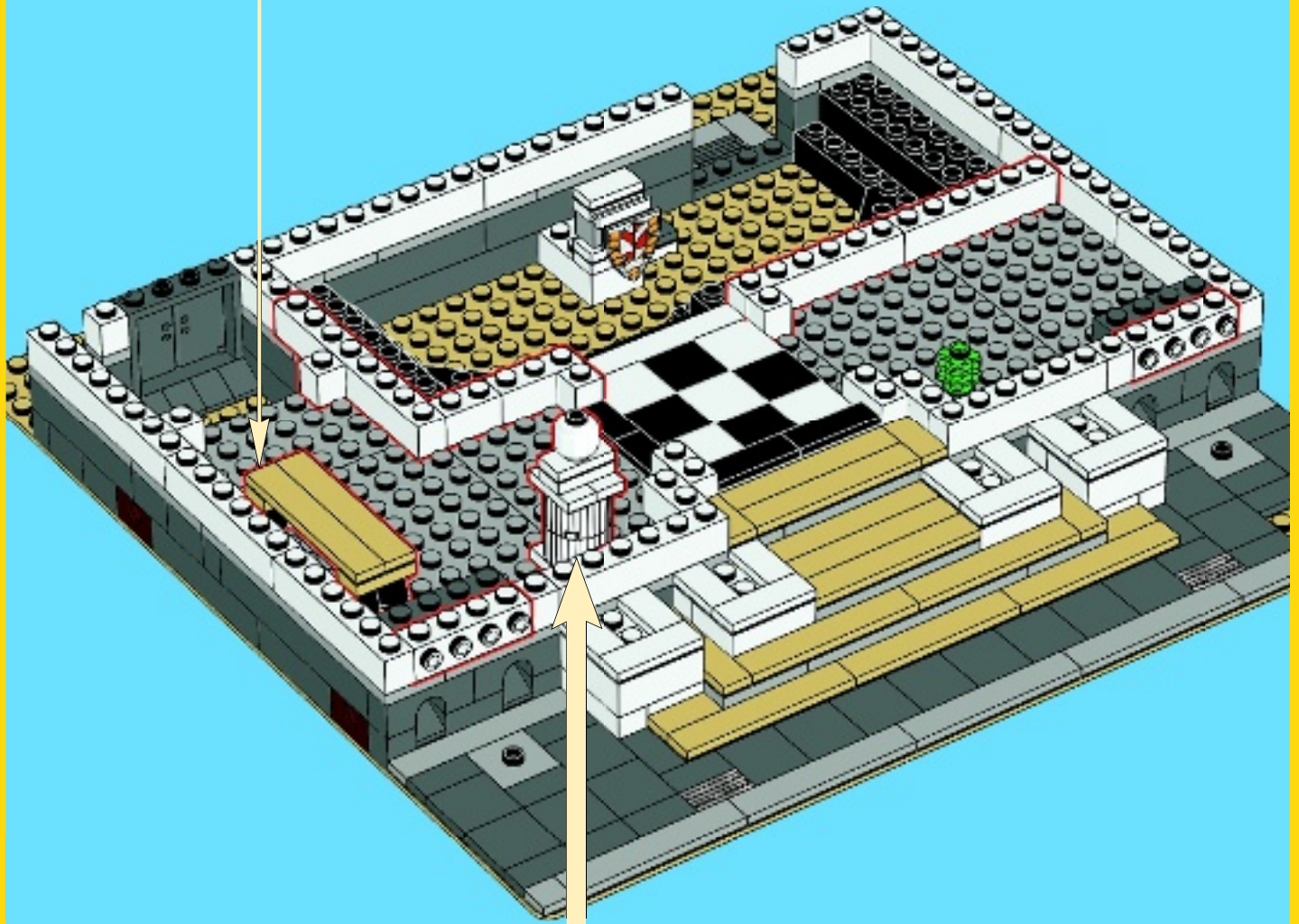

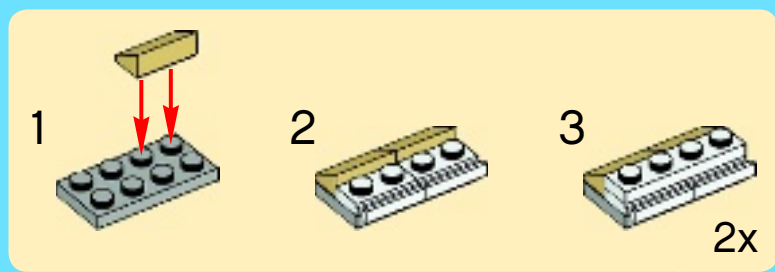
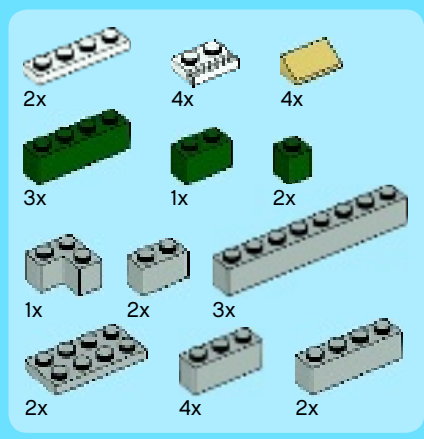

17

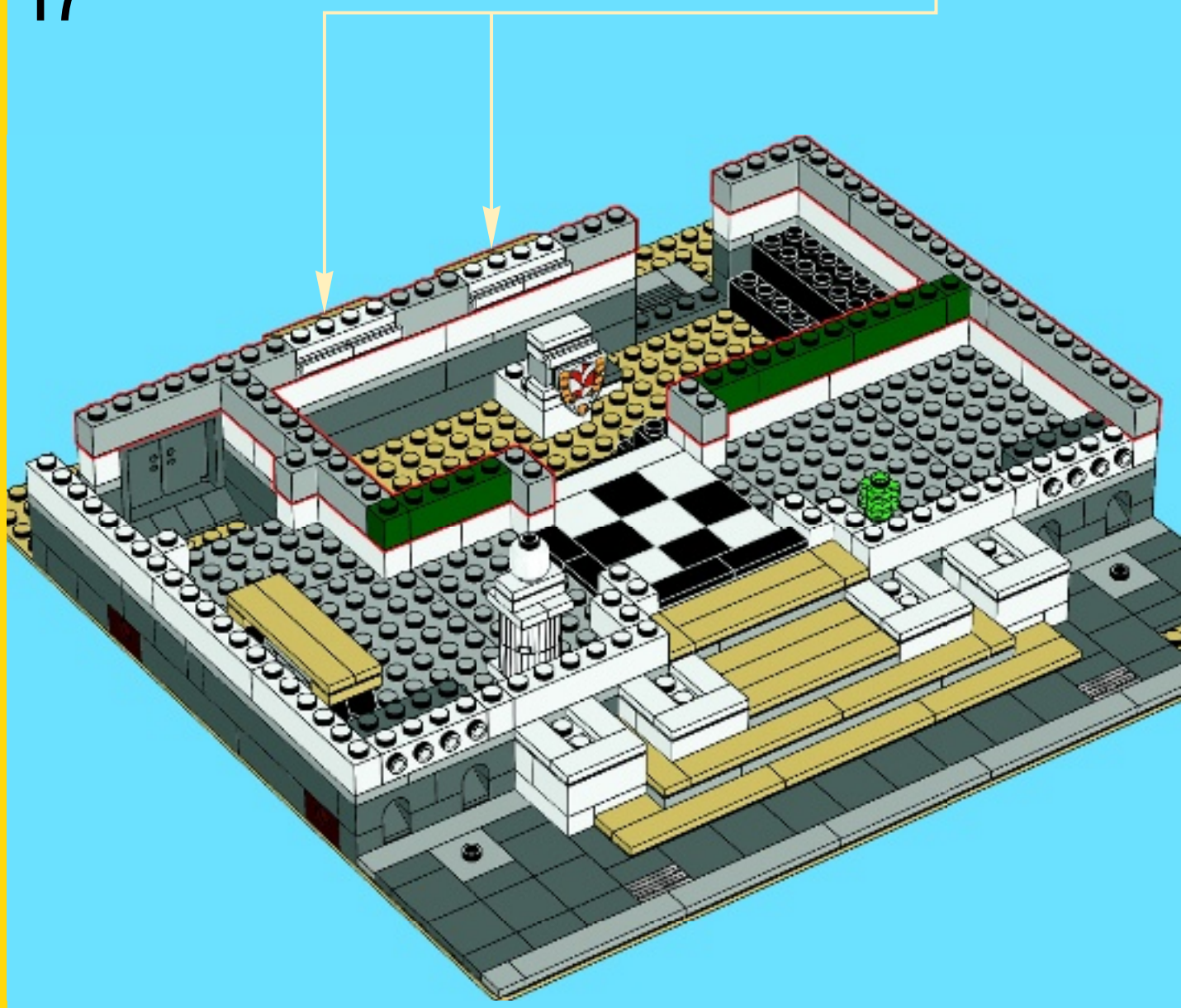



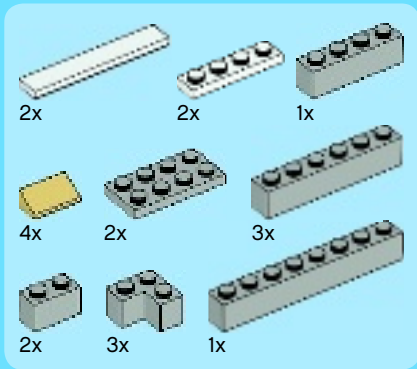

18

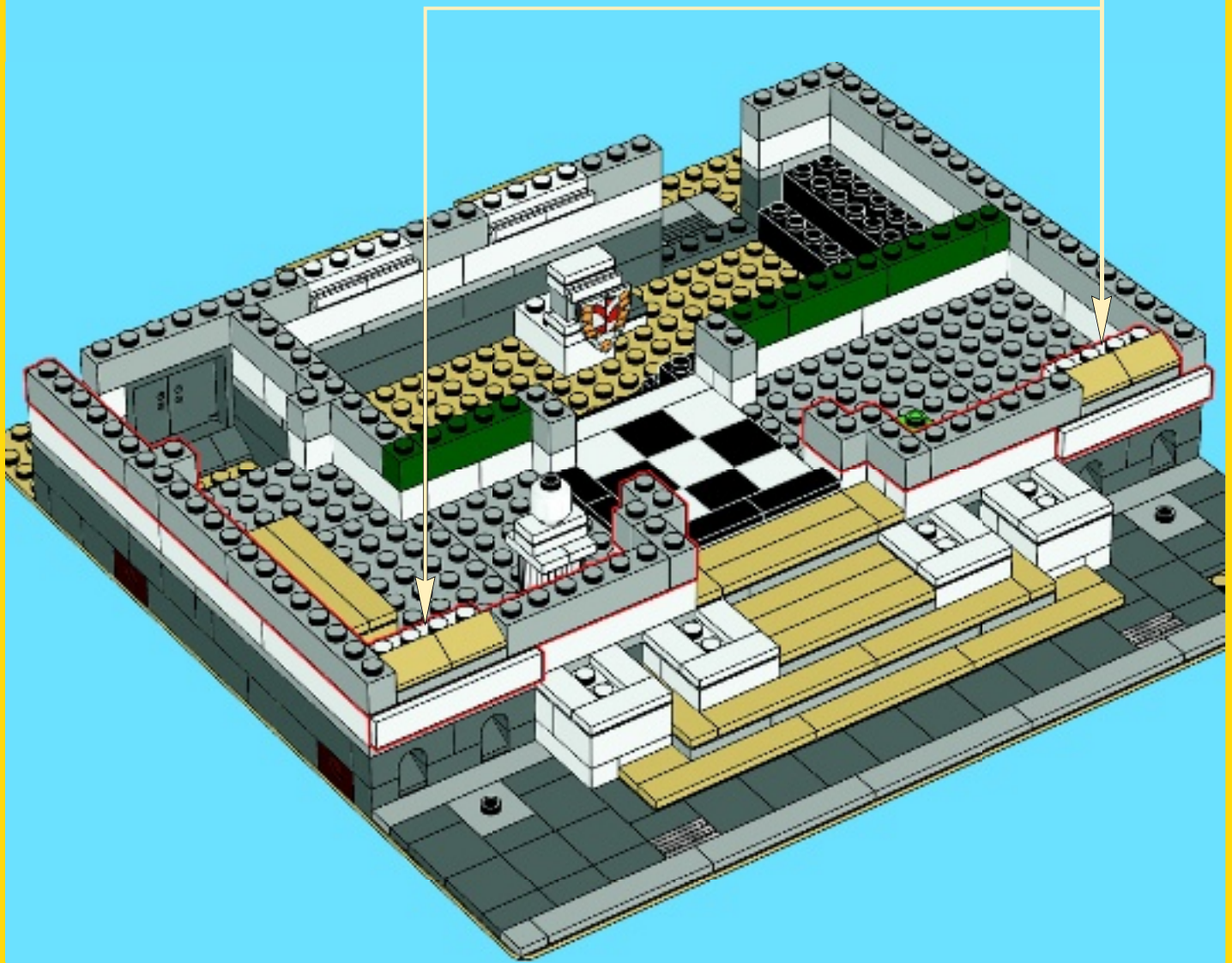
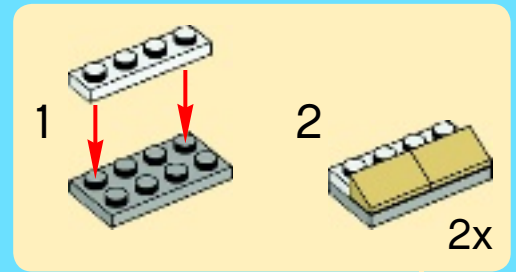

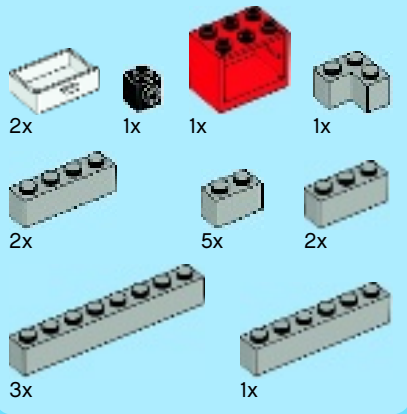

# 19

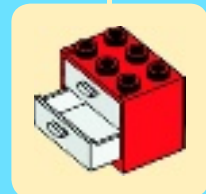
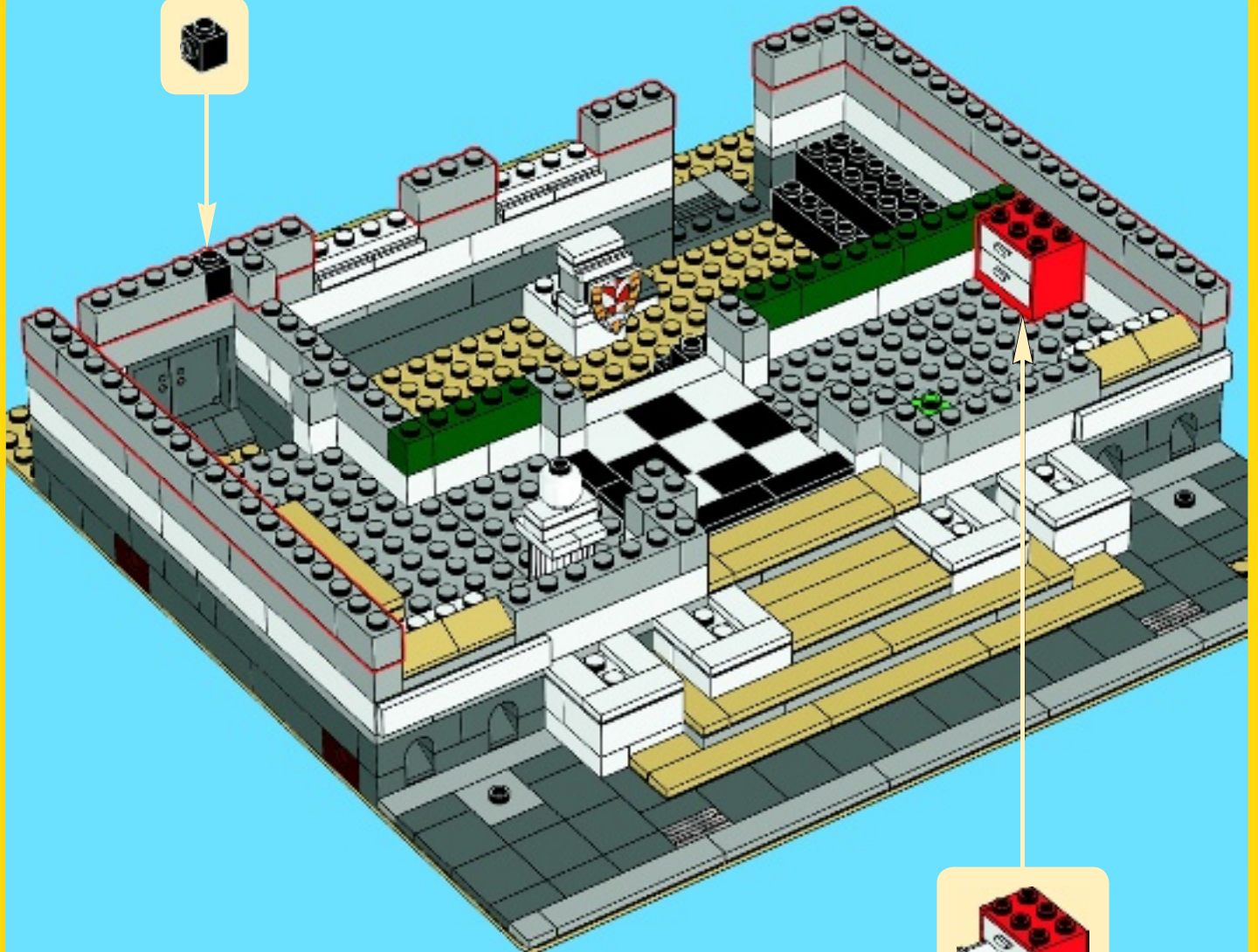



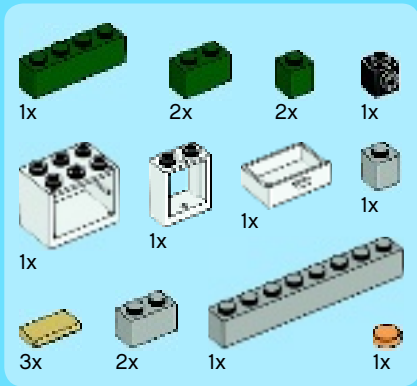

20

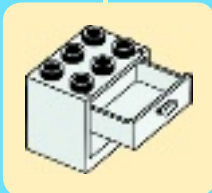
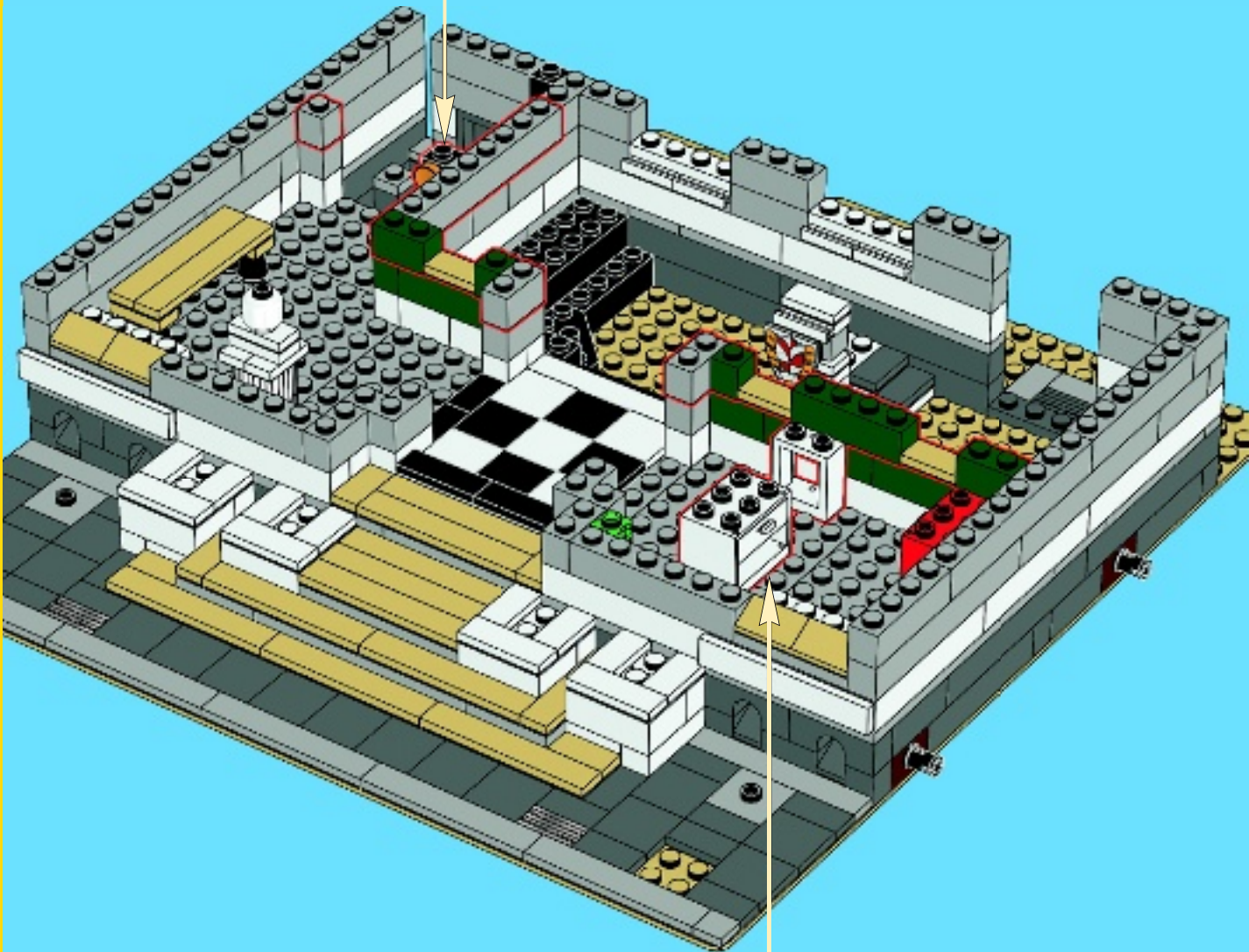

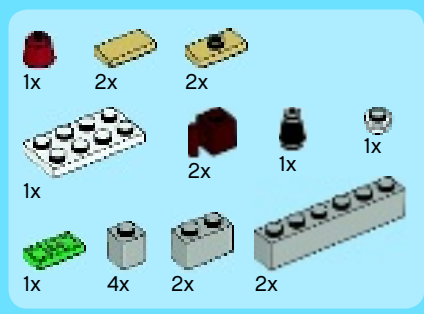

# 21

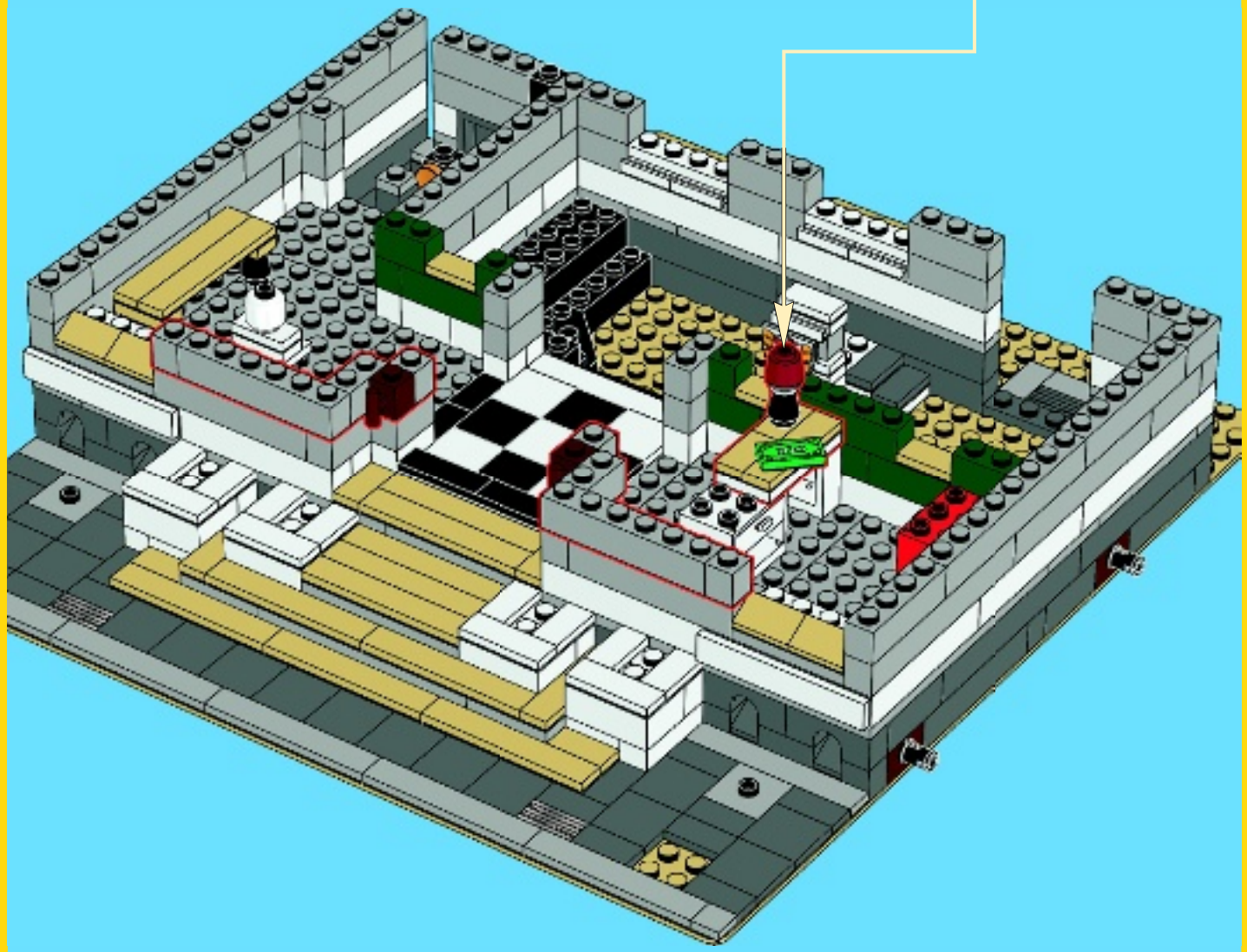
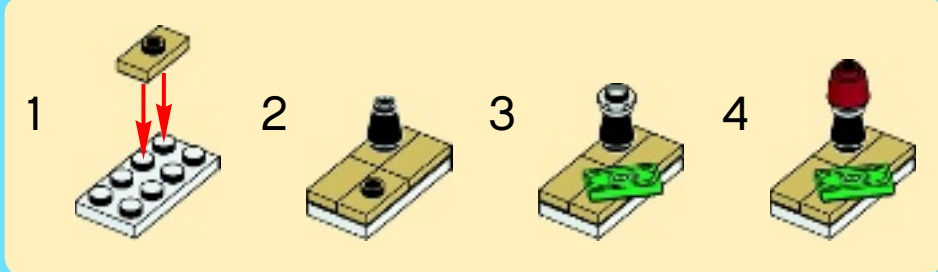



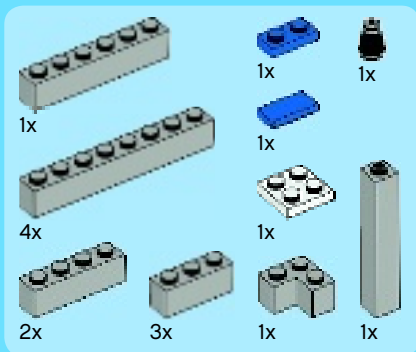

22

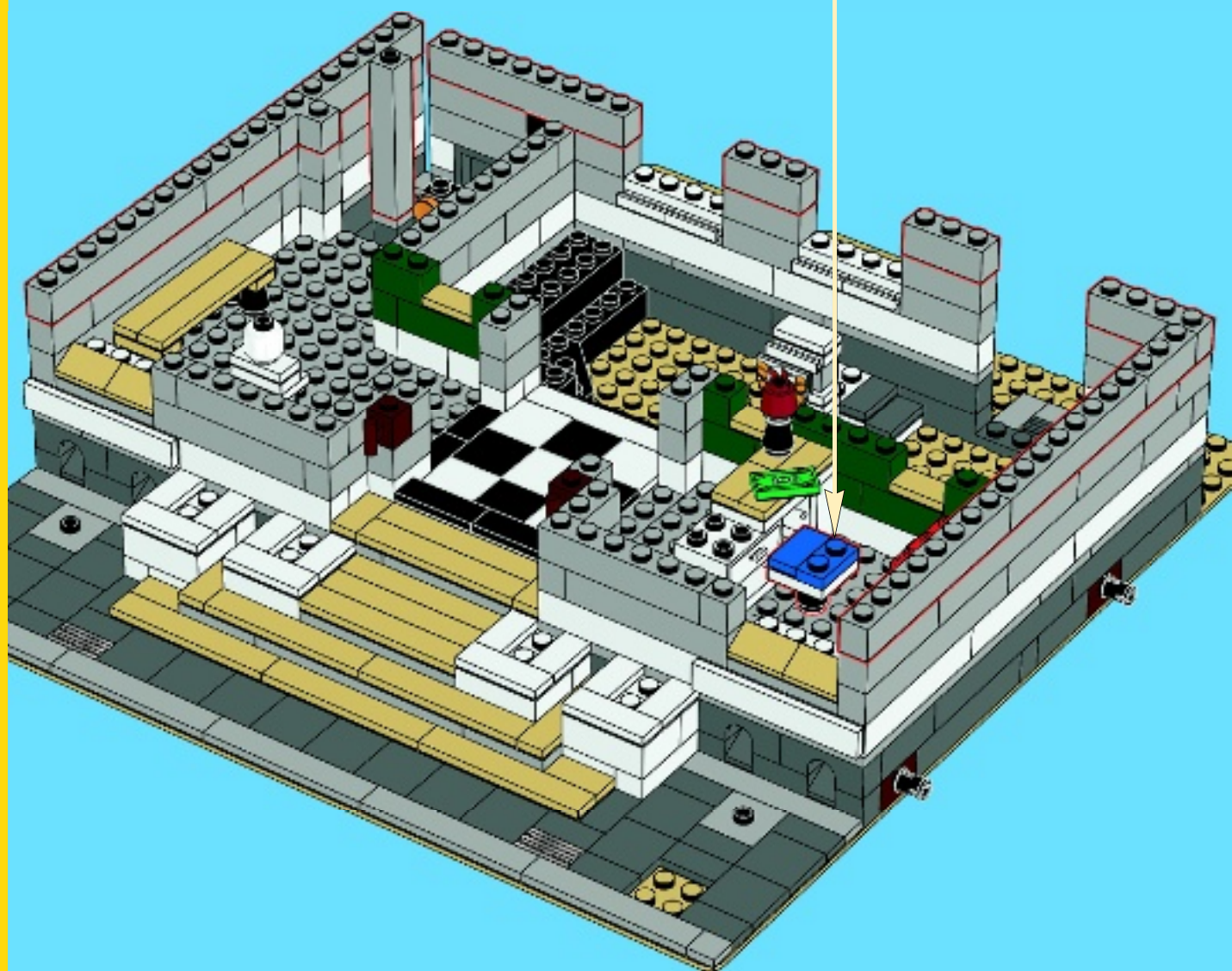
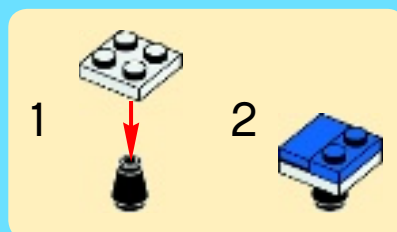

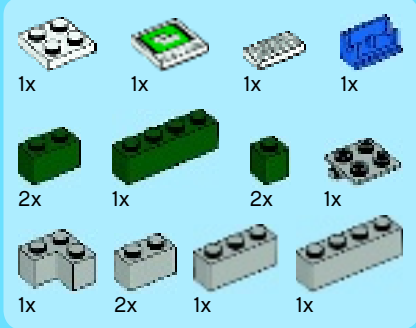

# 23

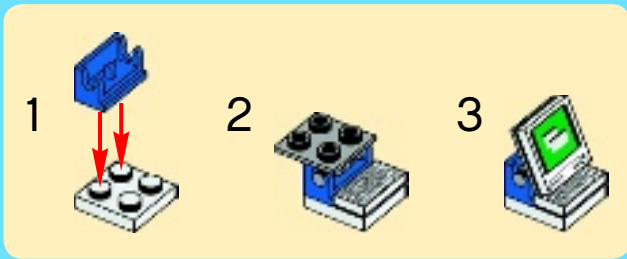
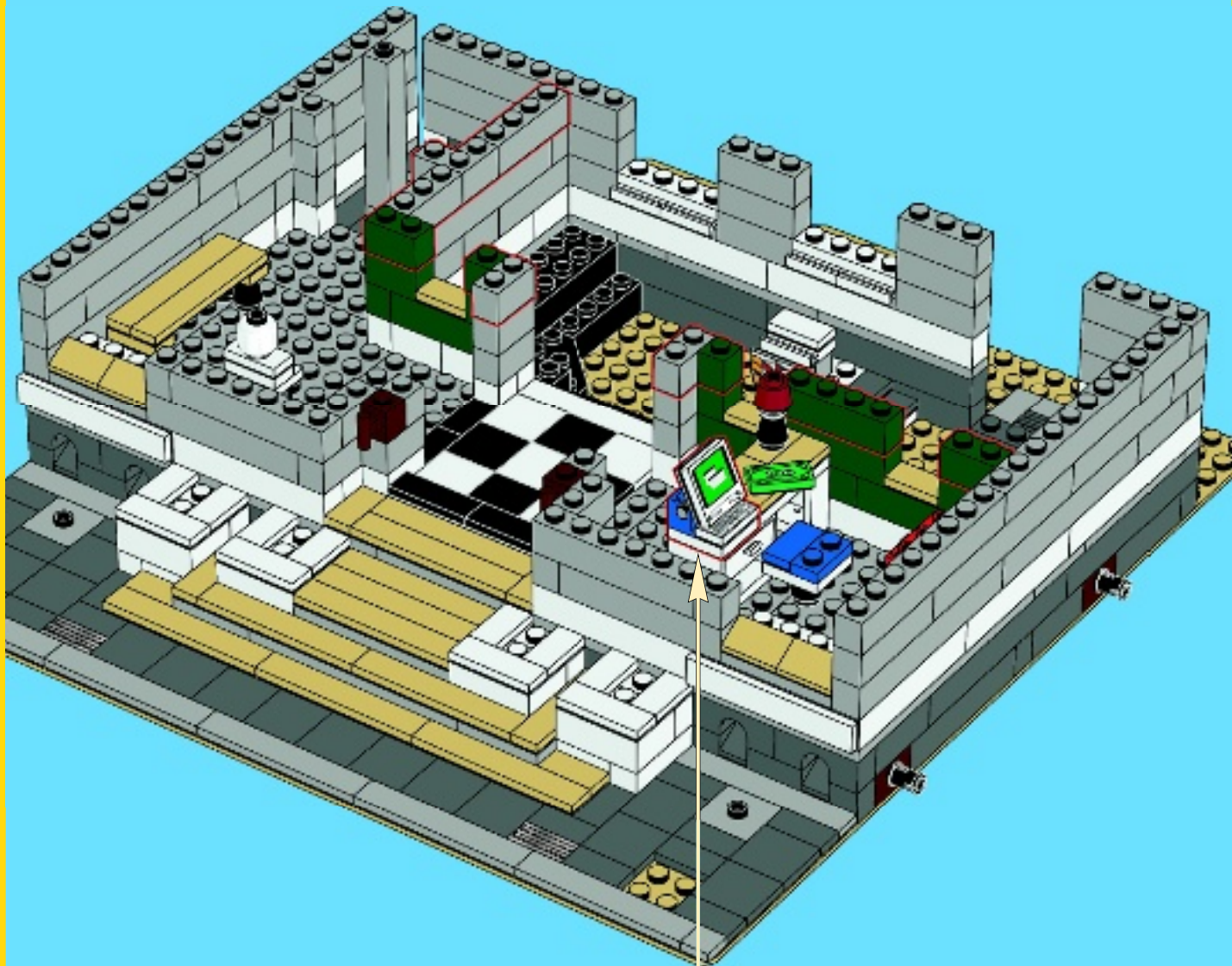



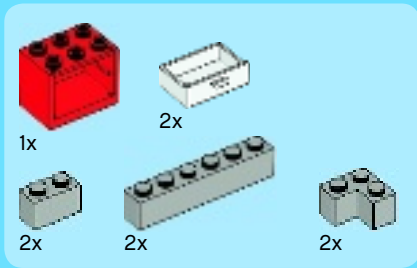

24



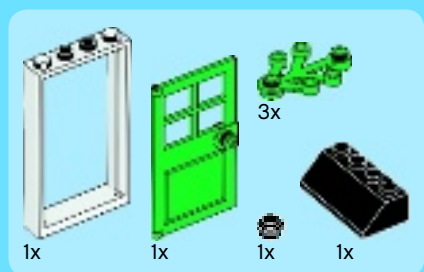

25

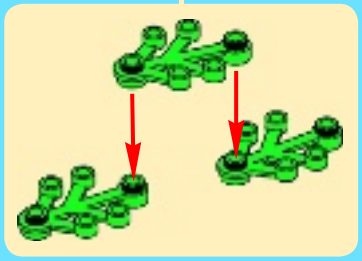
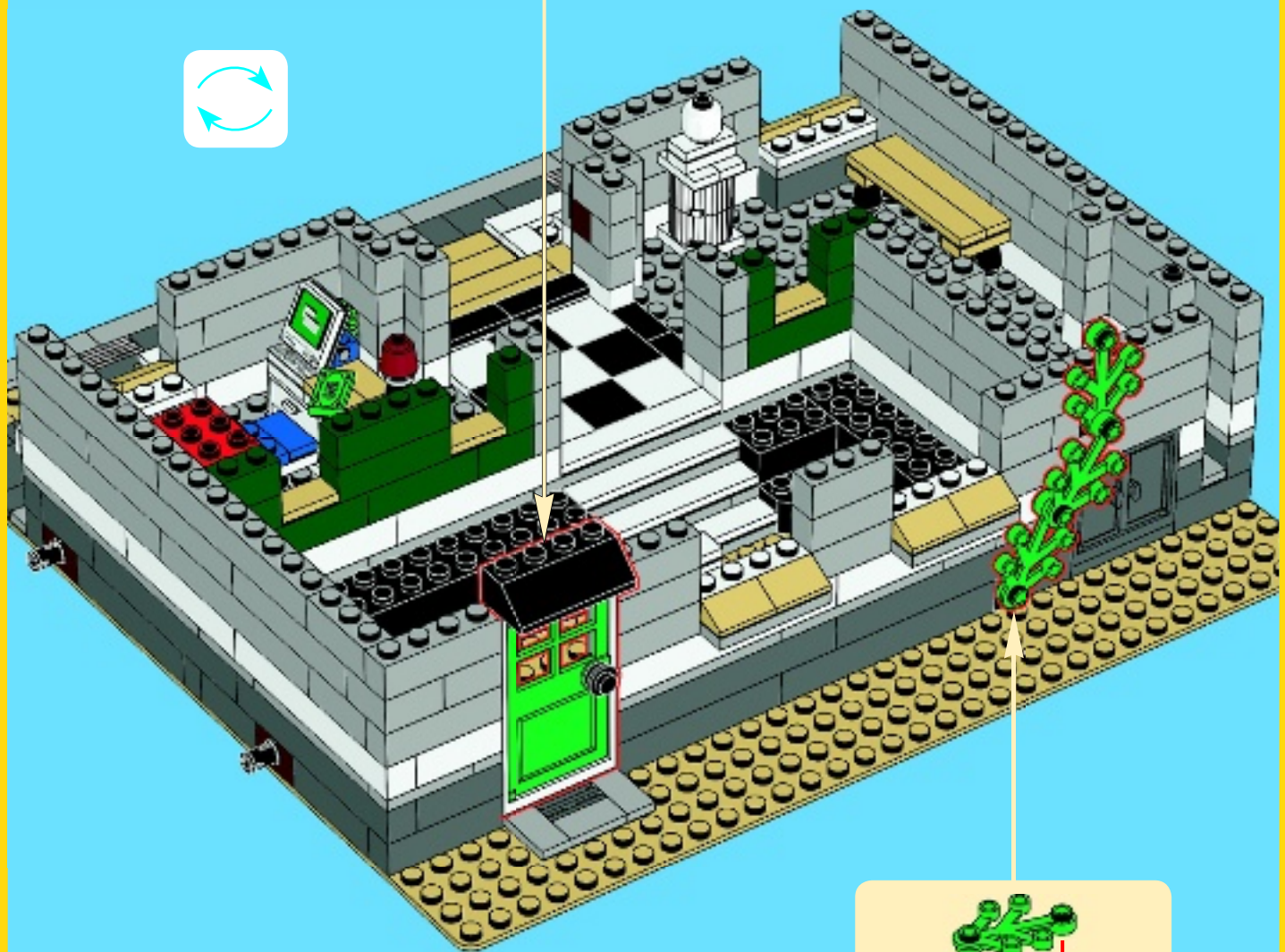
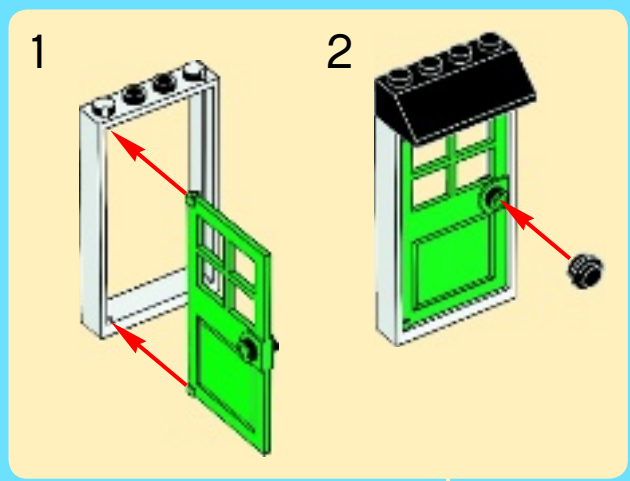



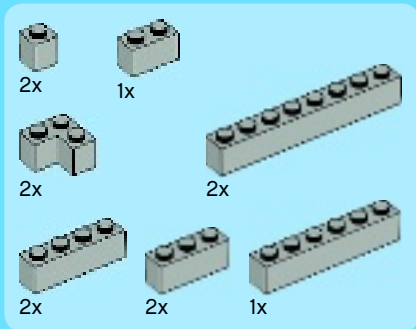

# 26

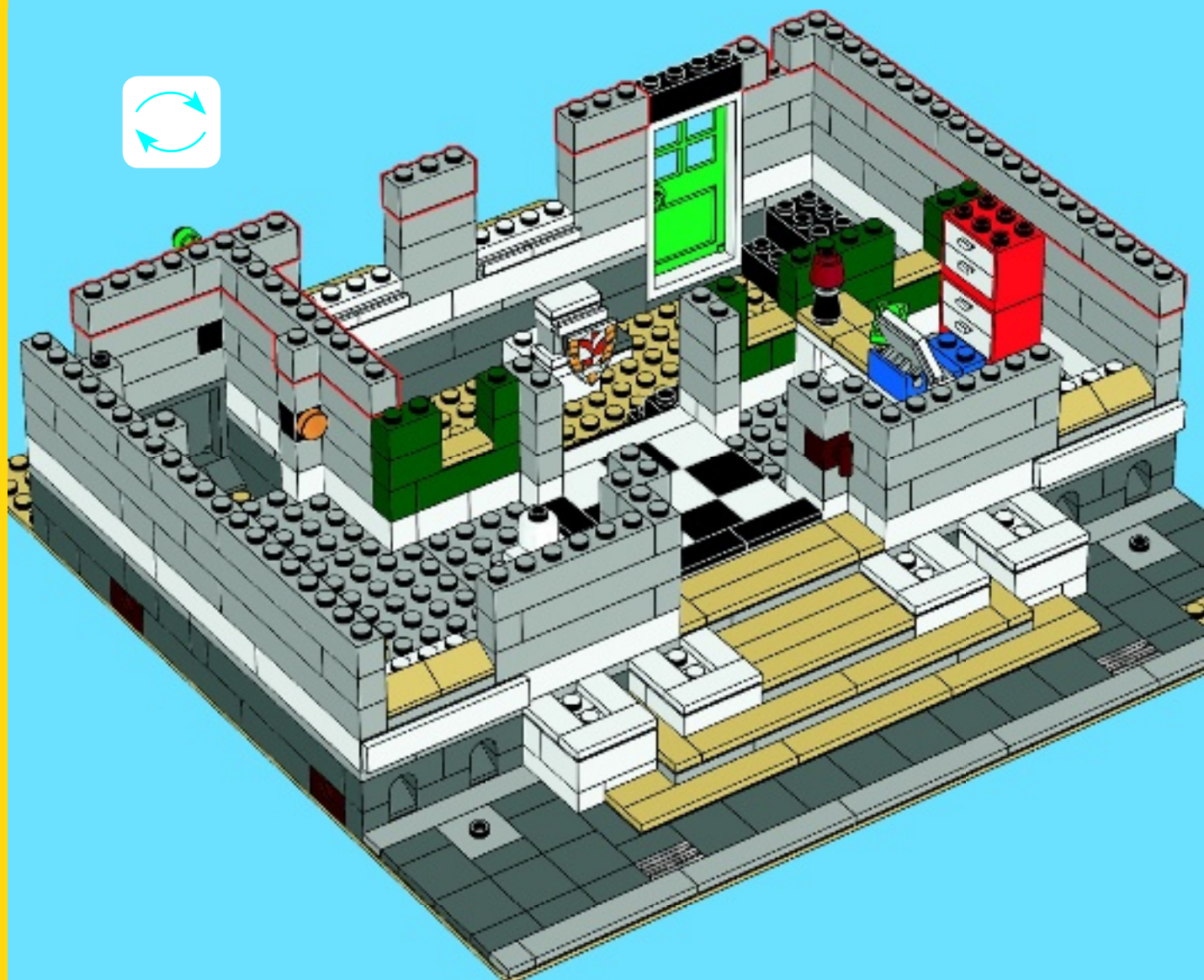

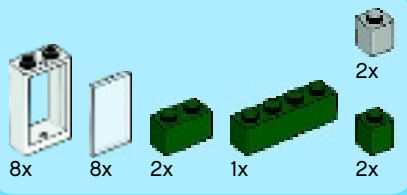

27

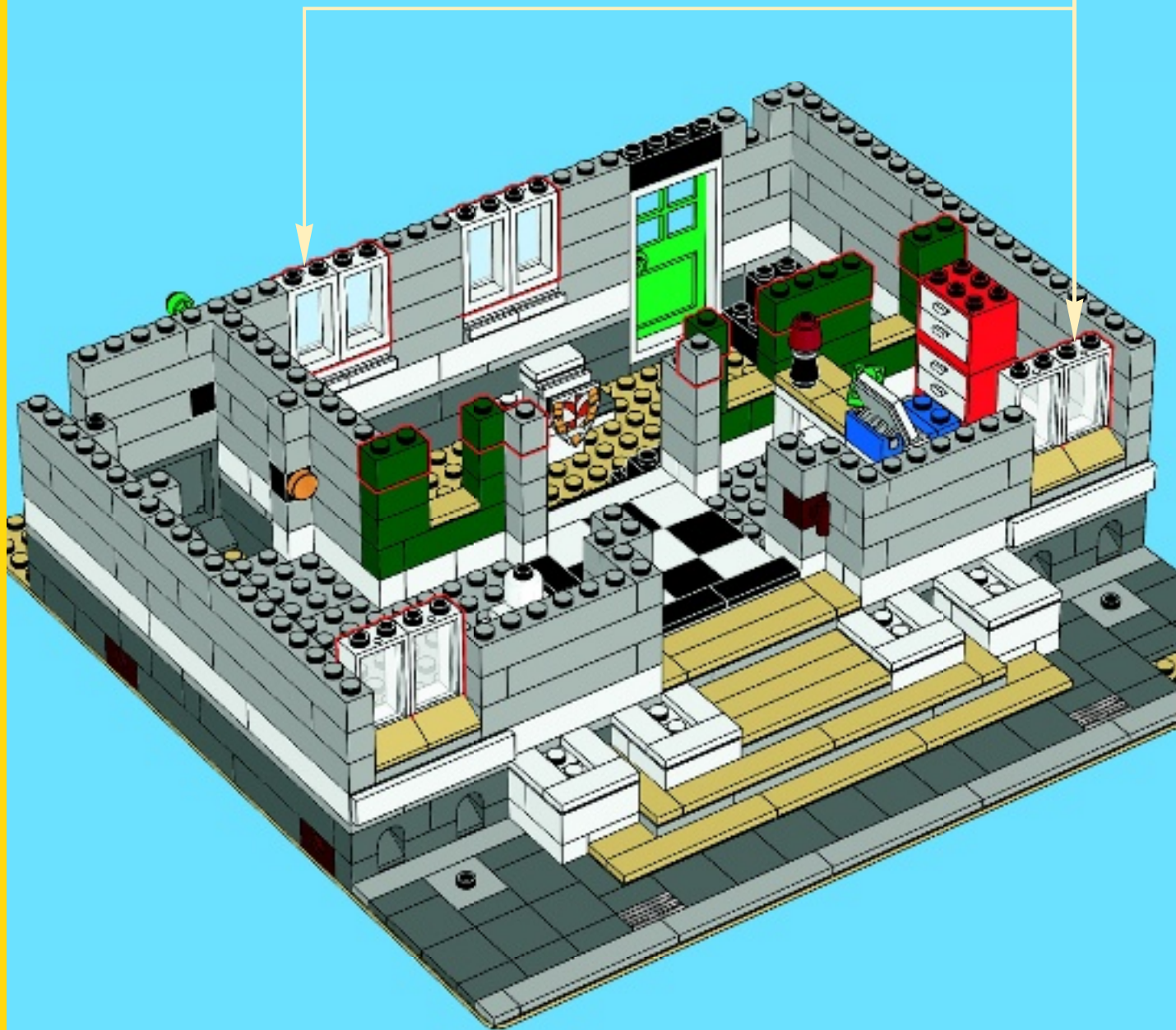
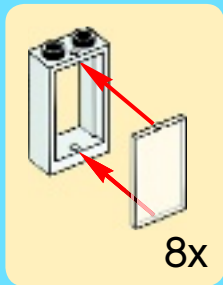



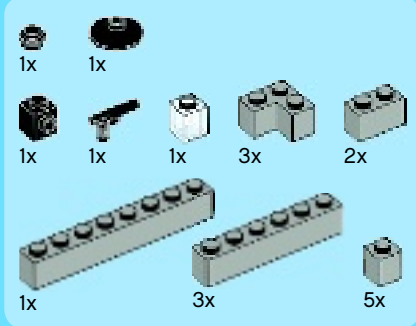

28

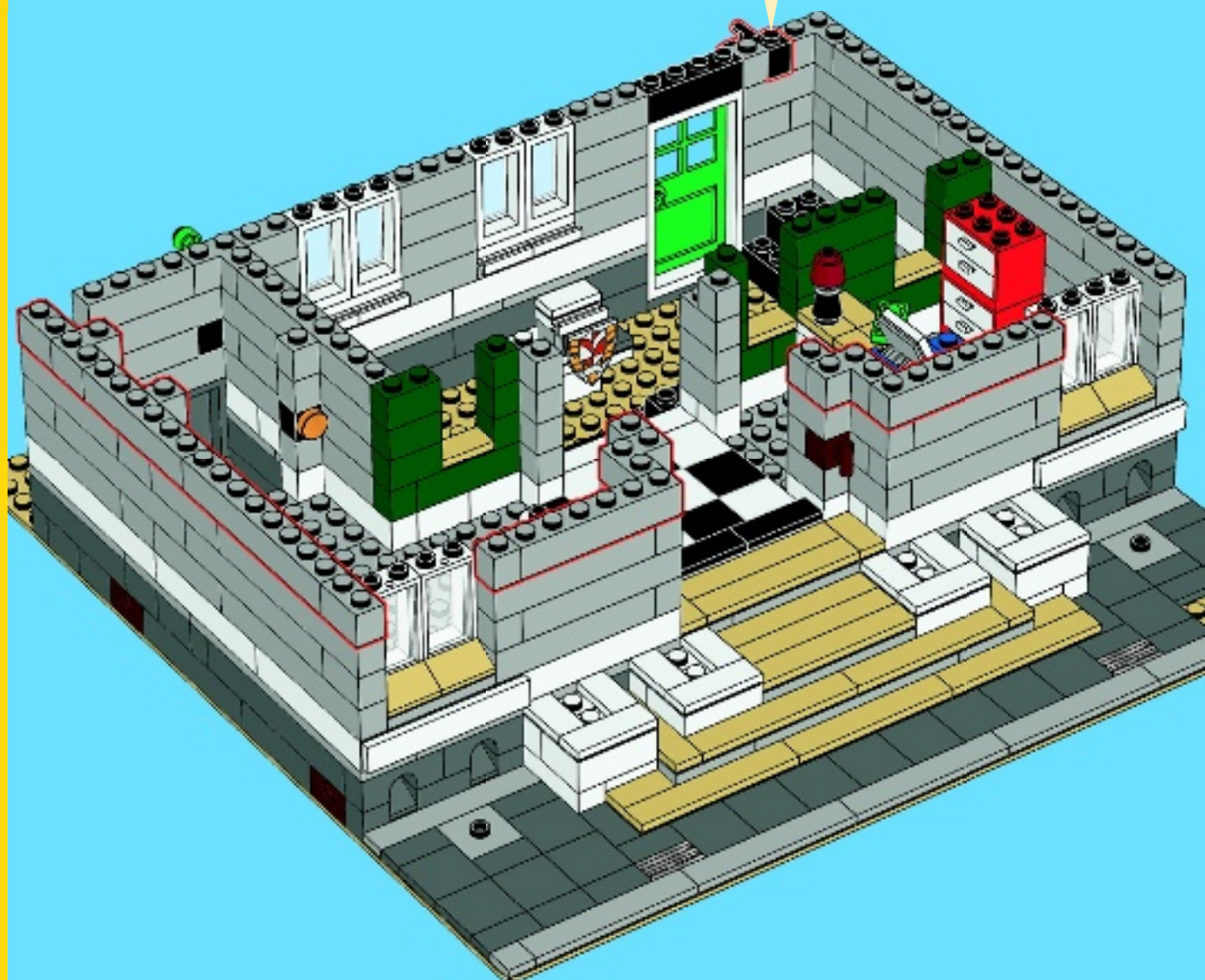
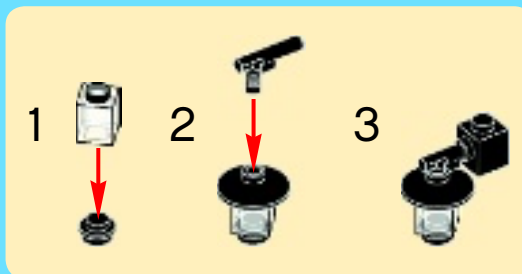

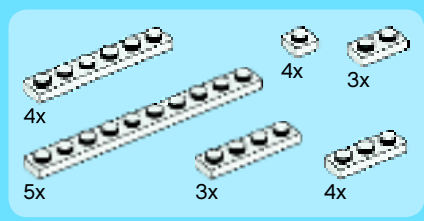

# 29

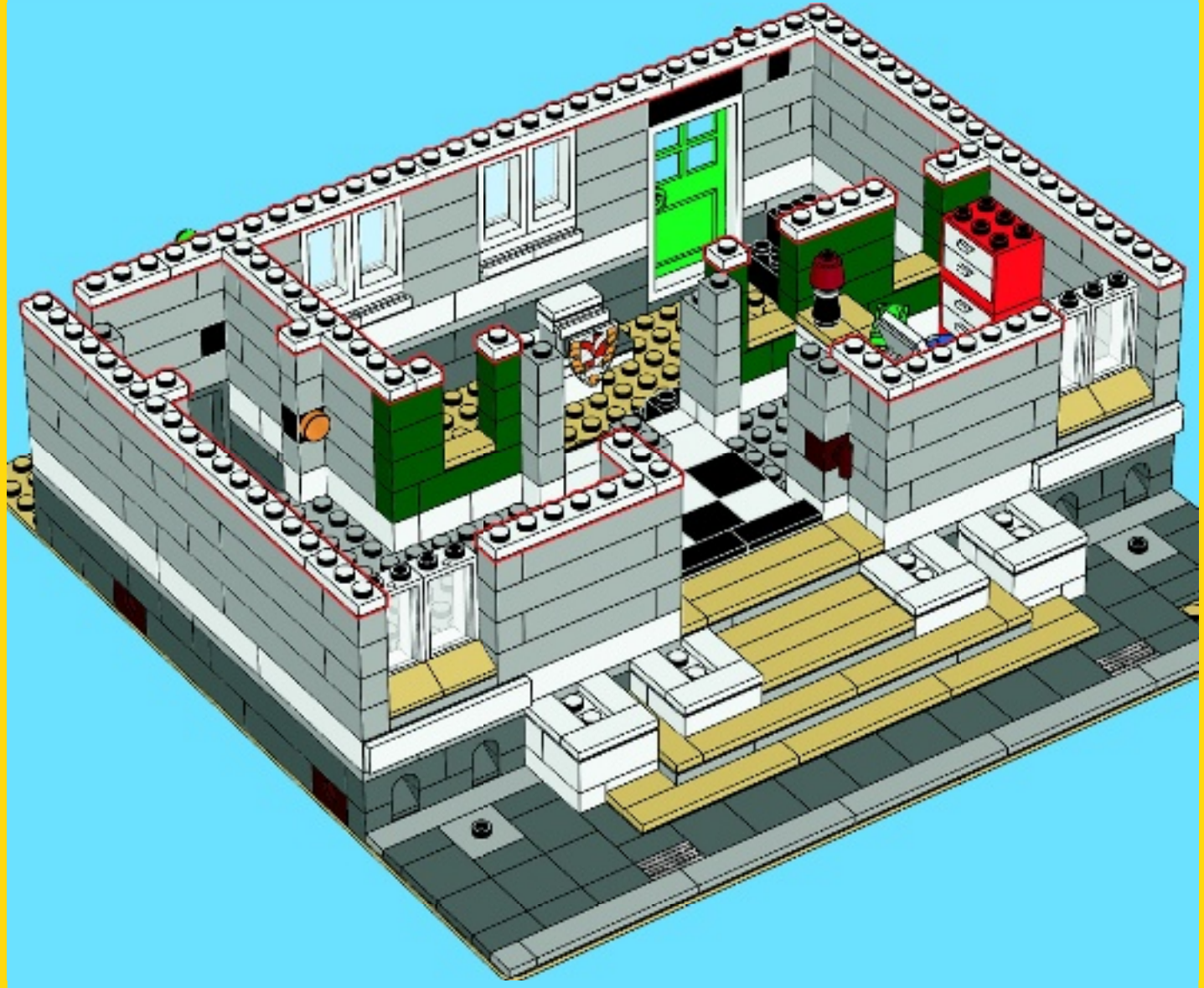



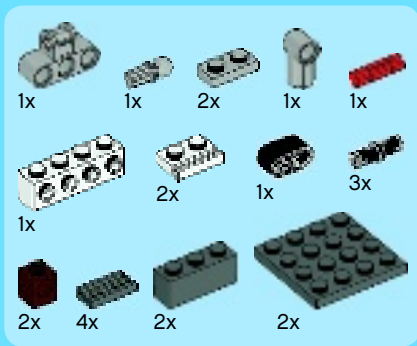

# 30

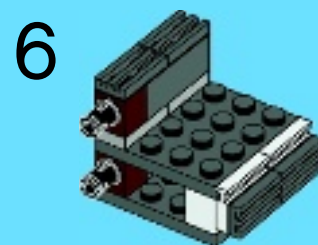
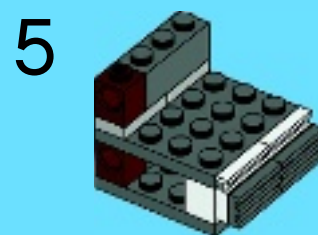
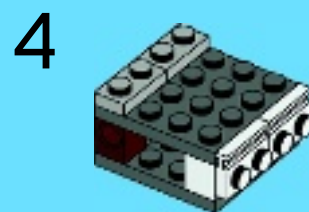
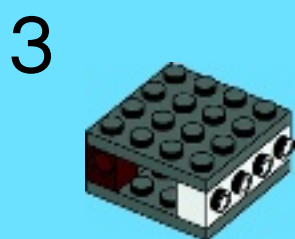
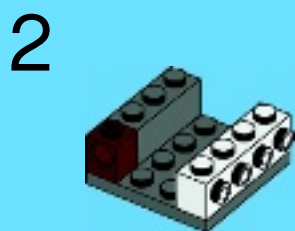
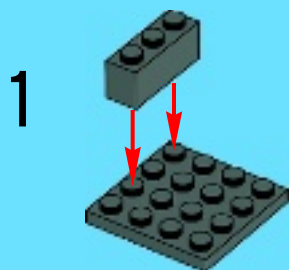

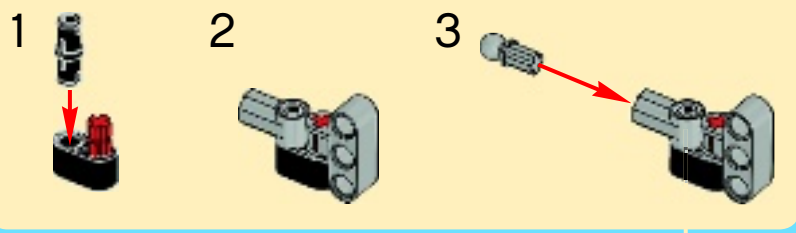

7

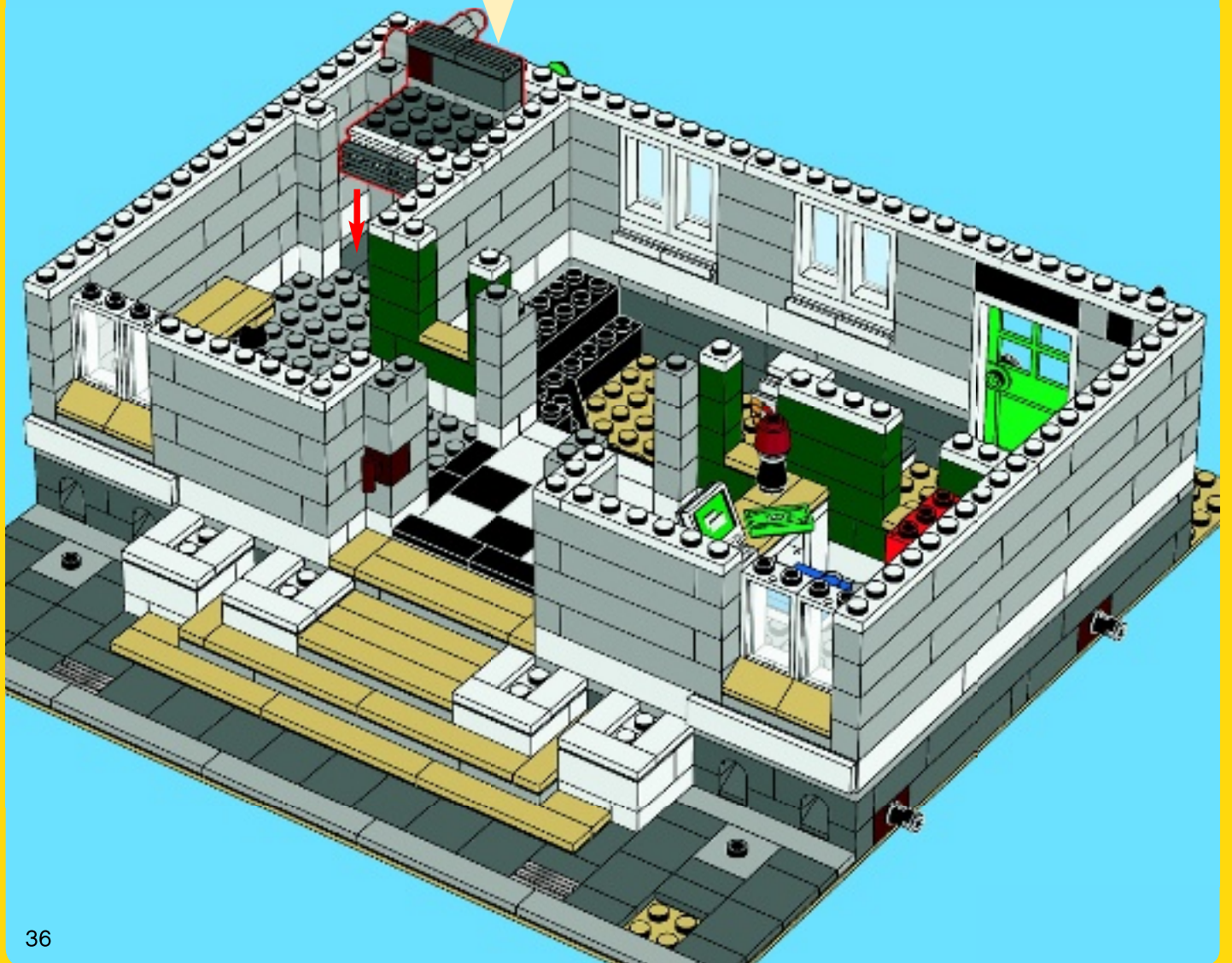
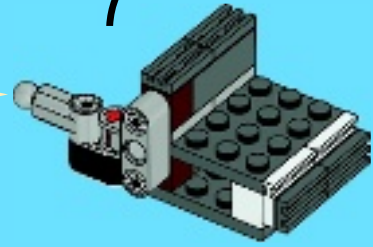



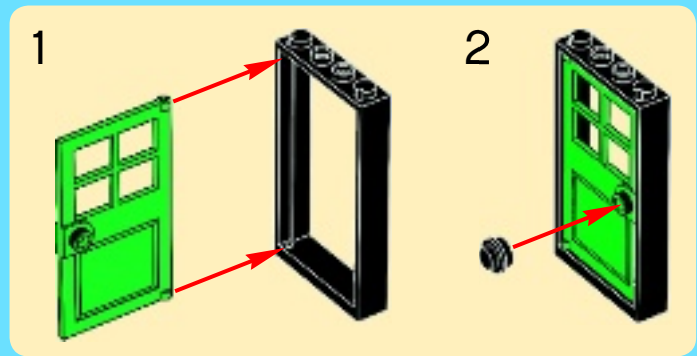
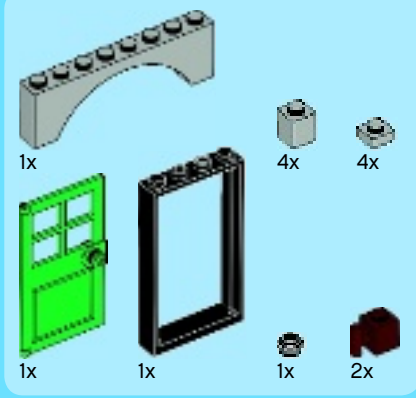

31

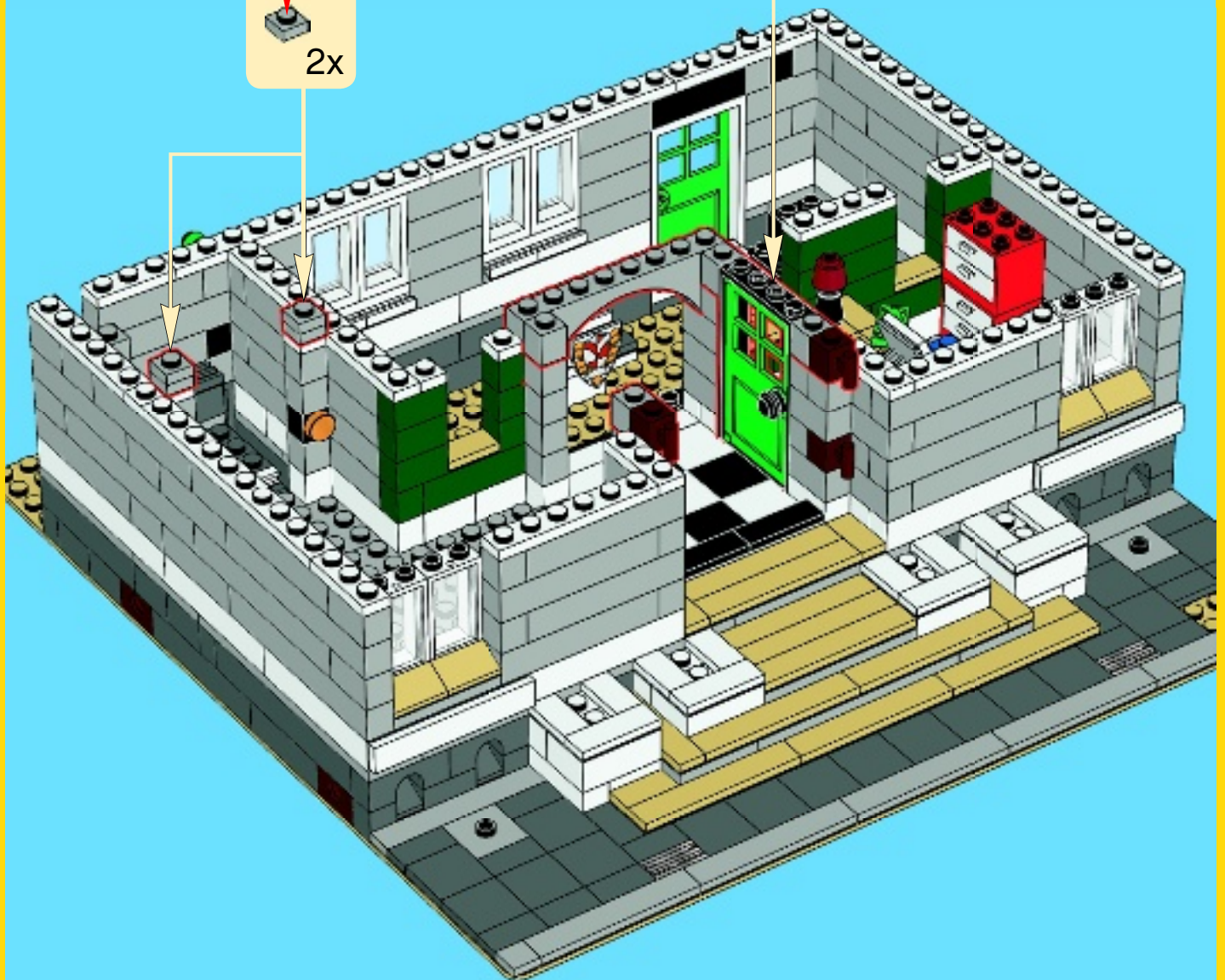
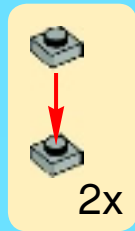

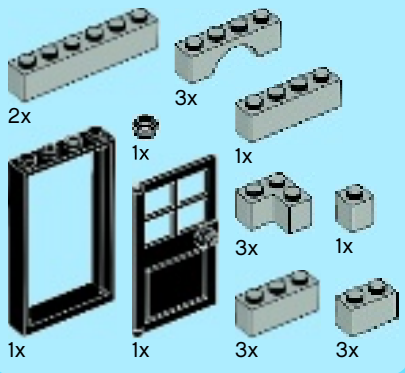

32

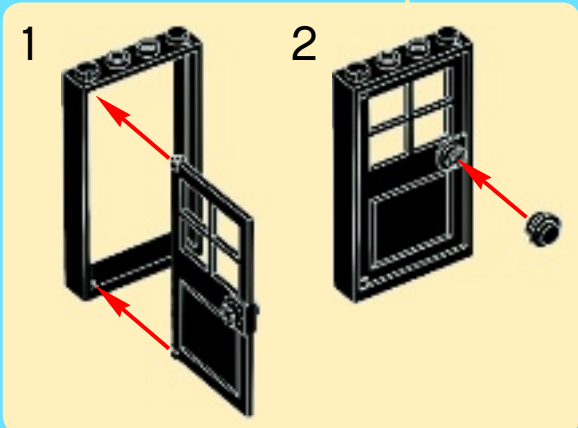
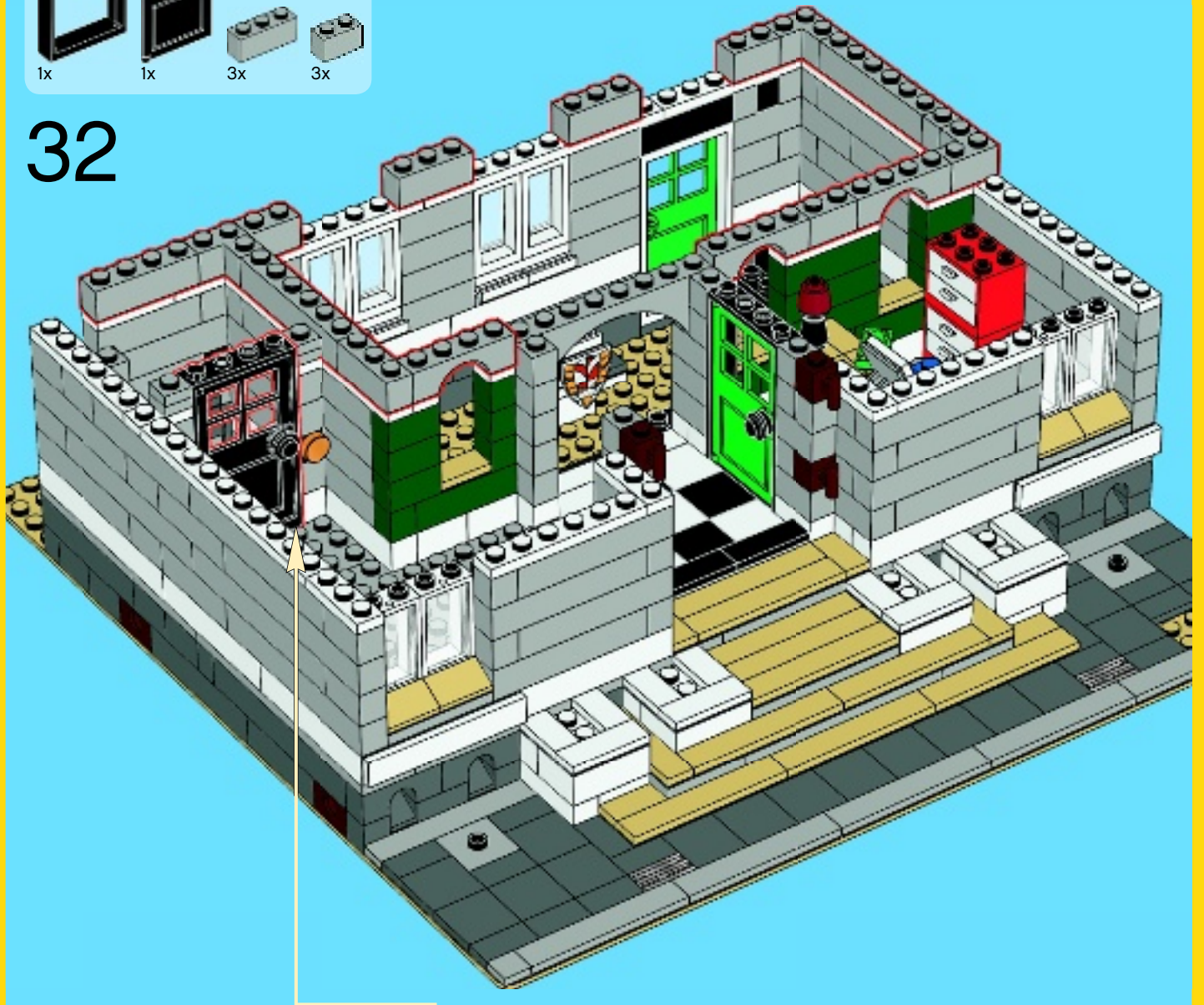



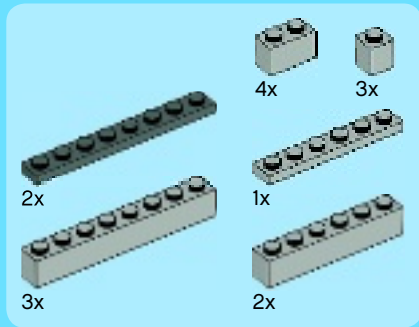

33

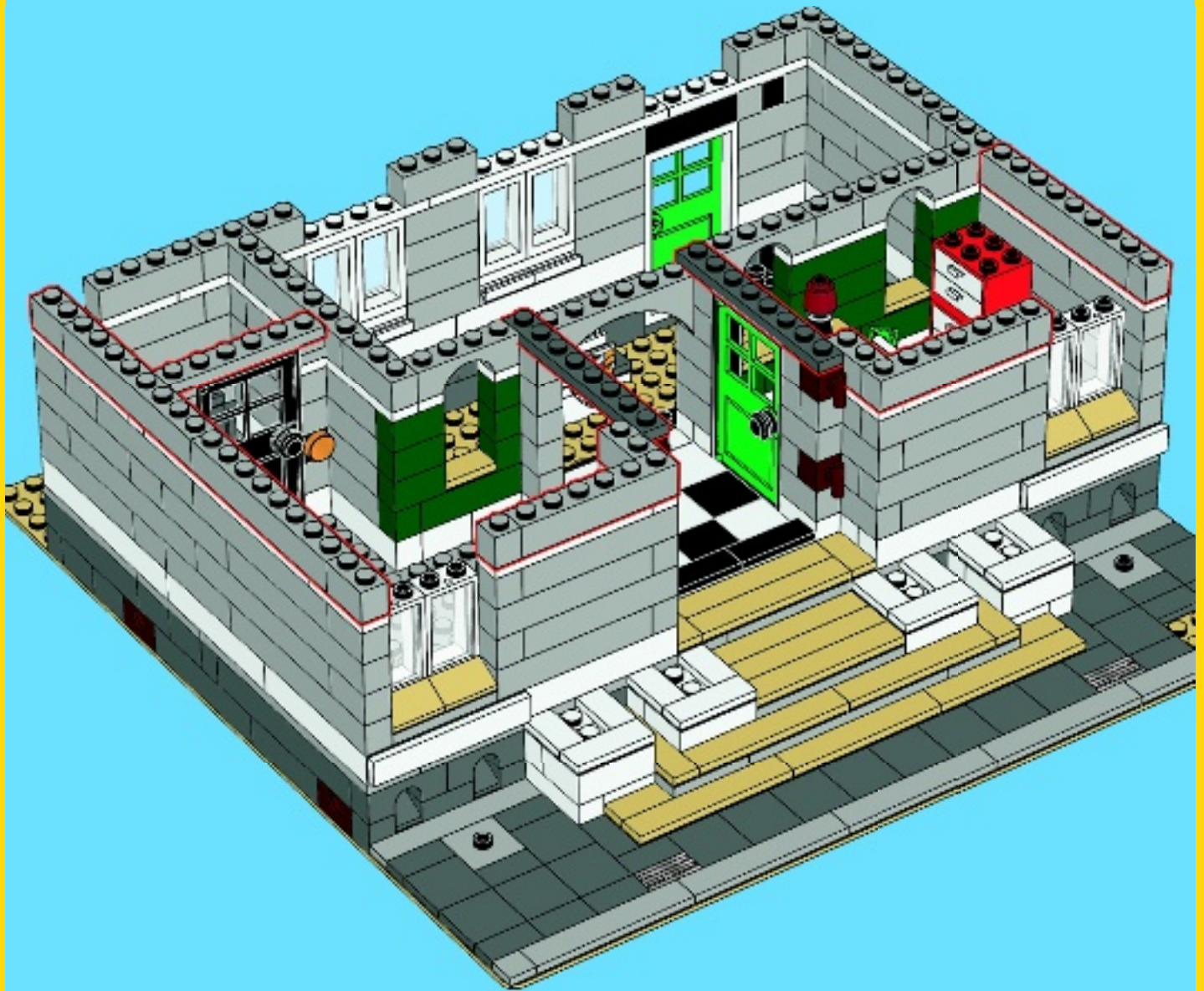

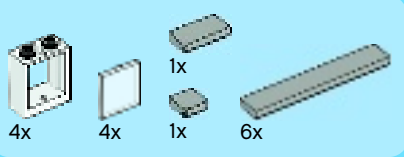

# 34

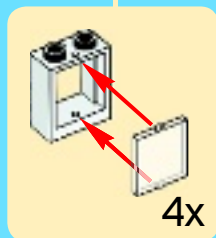
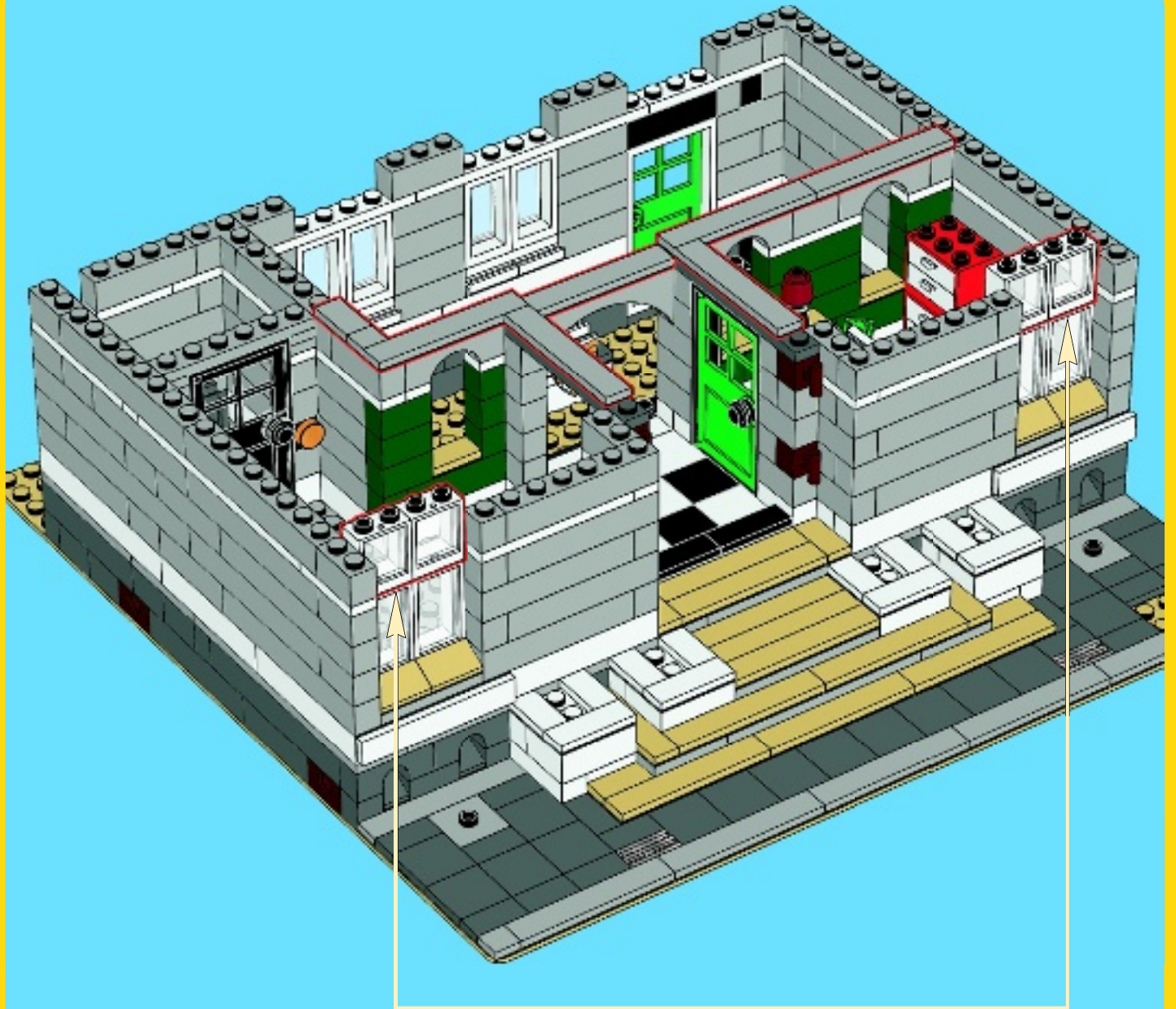



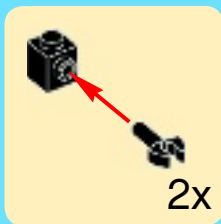
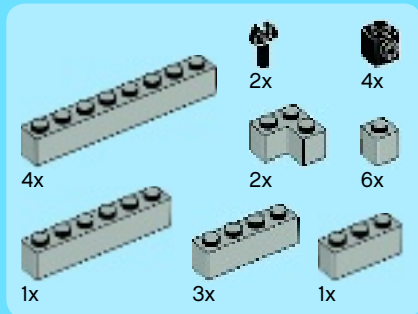

35

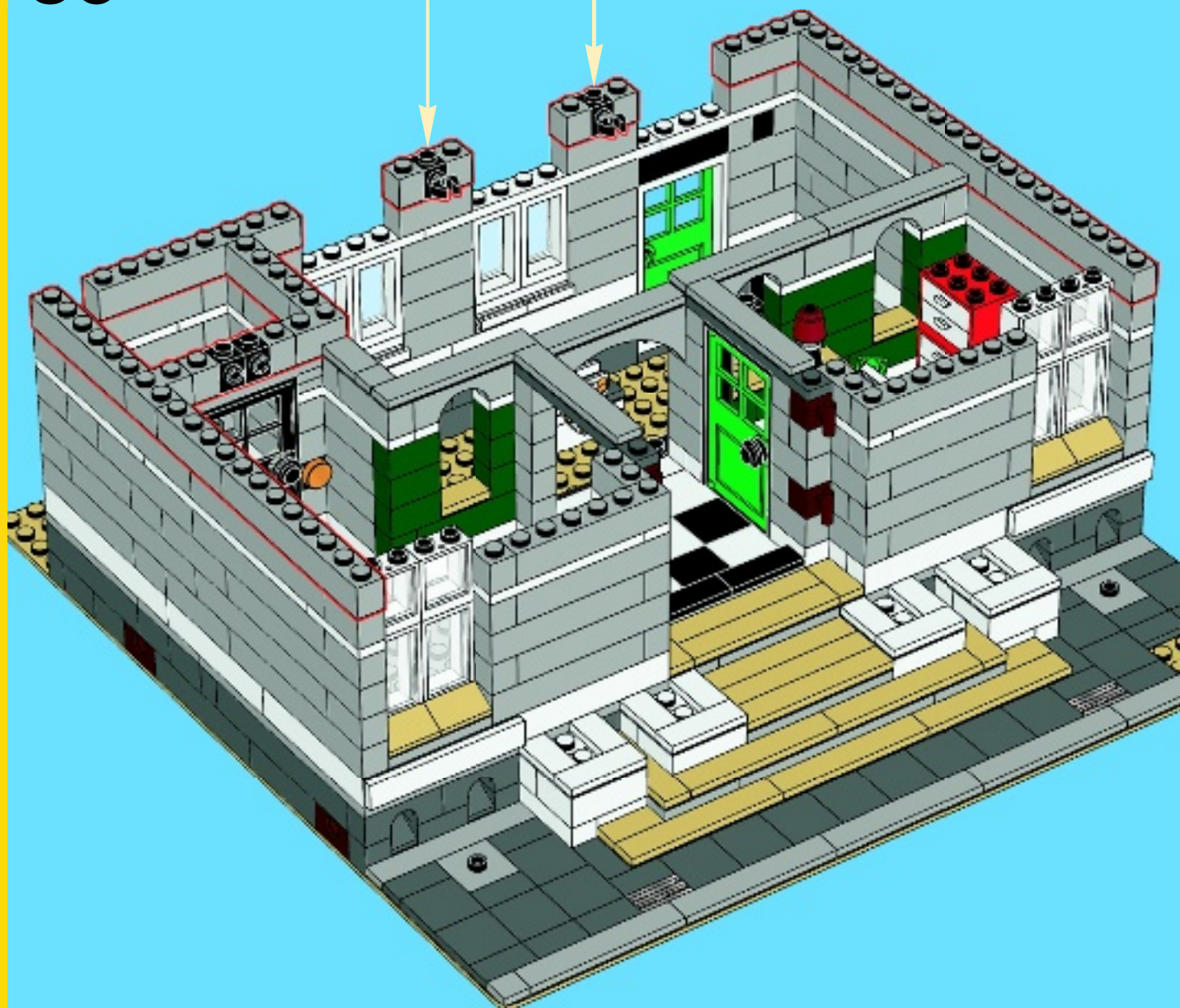

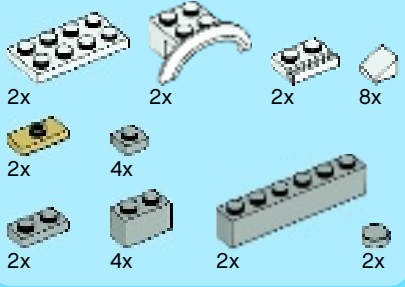

# 36

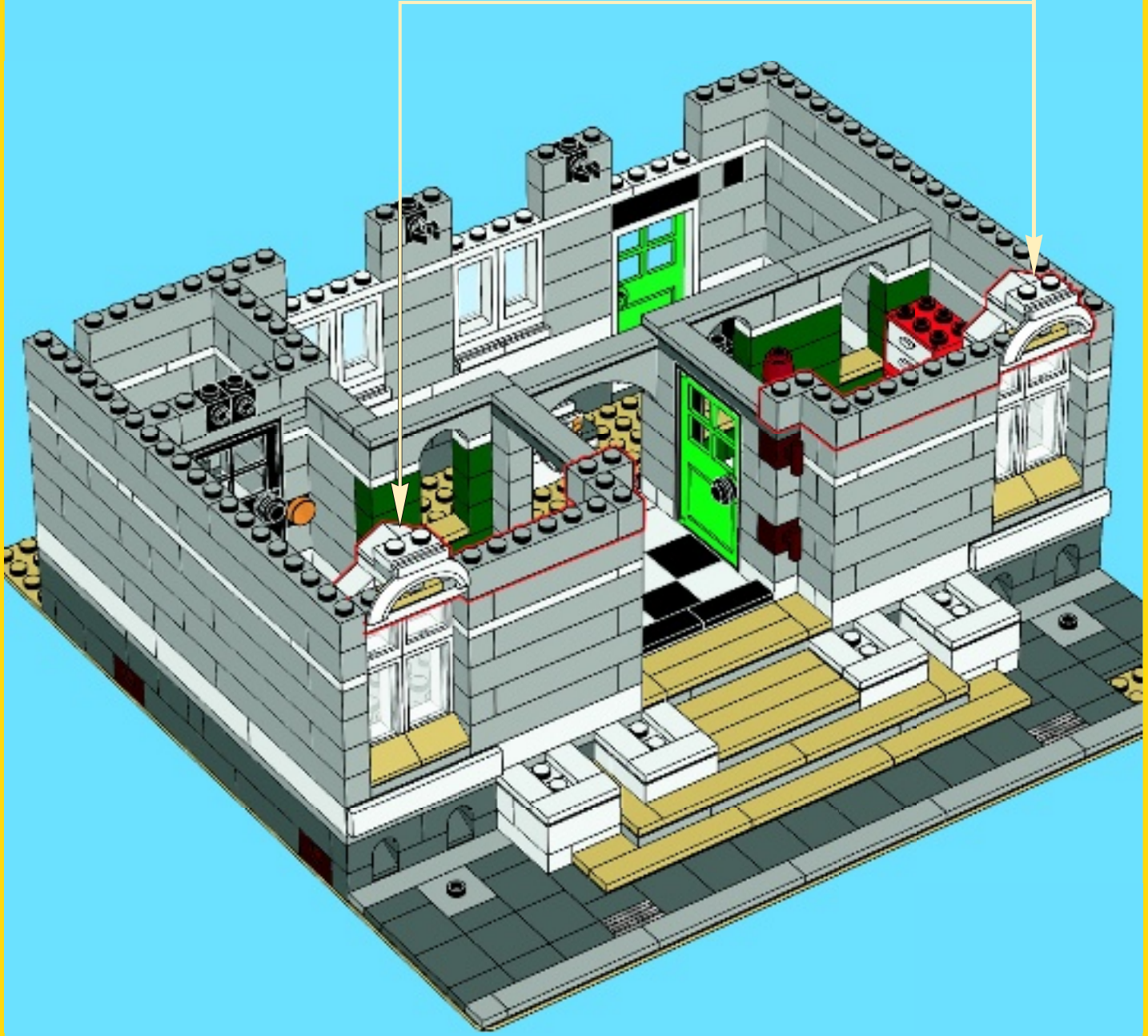
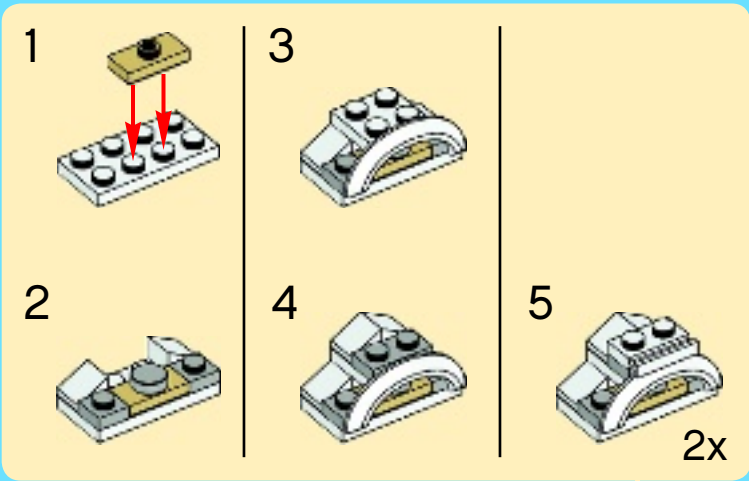



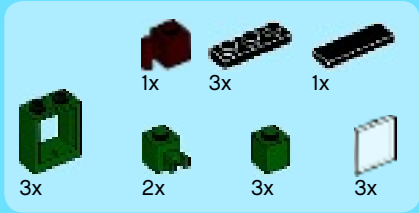
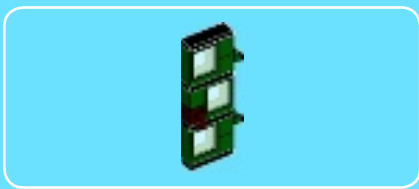

37

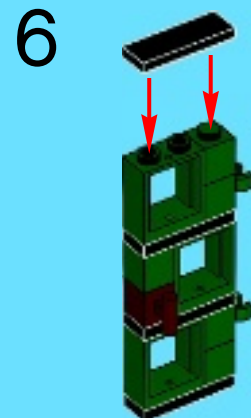
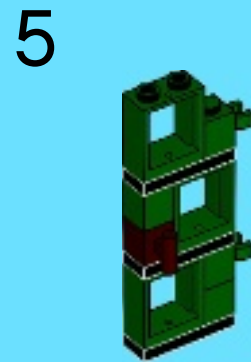
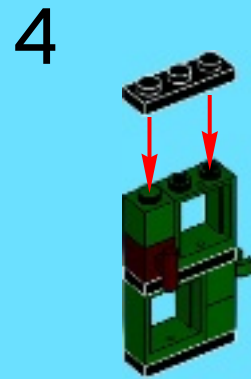
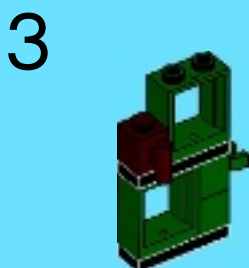
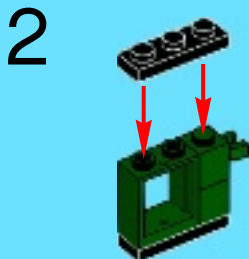
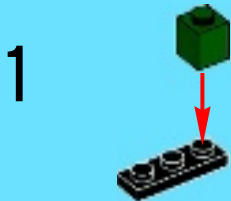

7

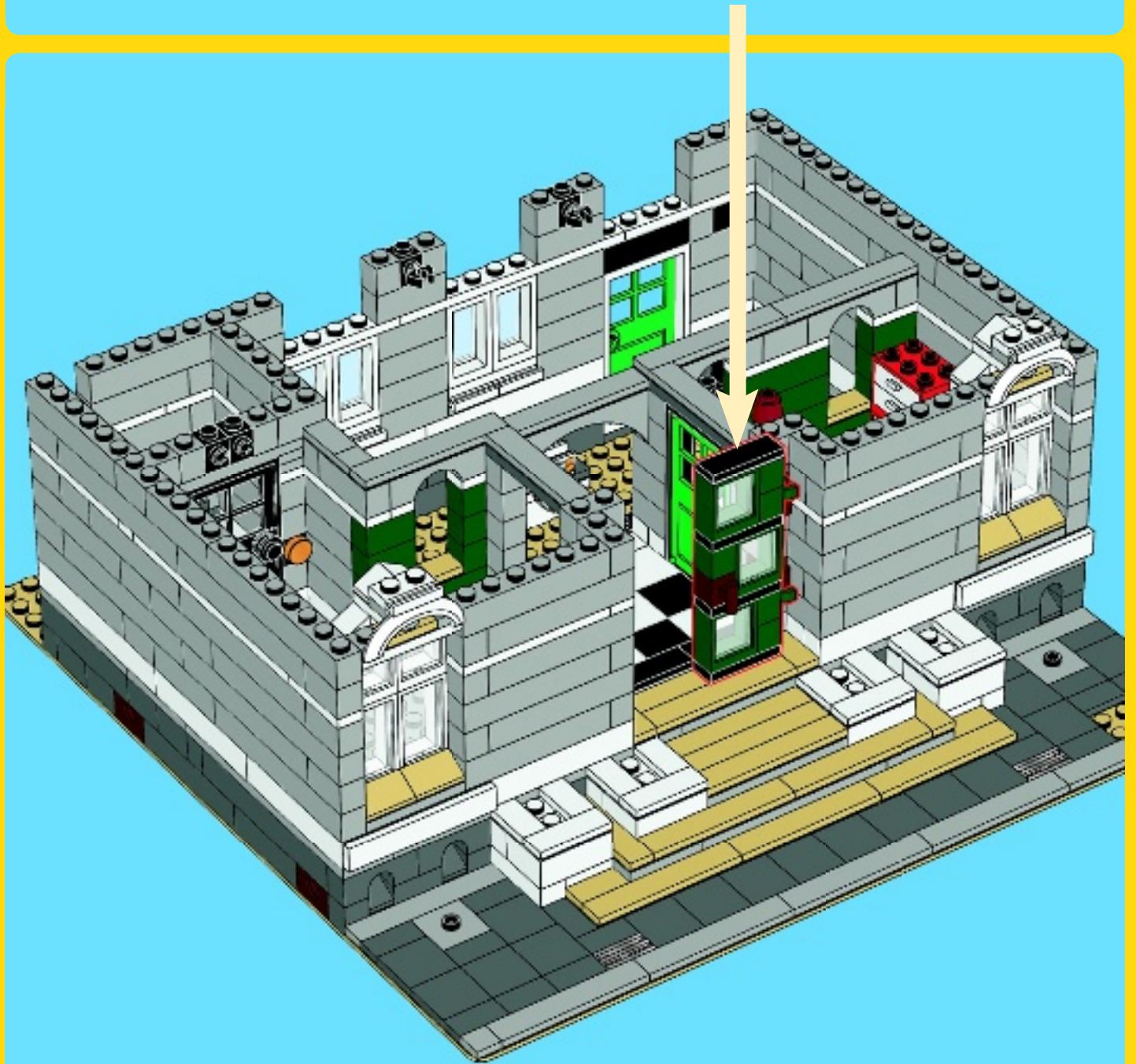
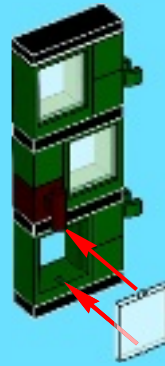



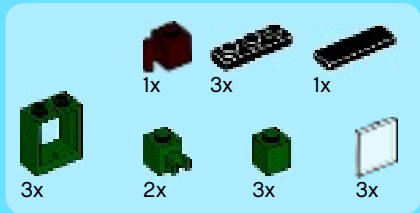
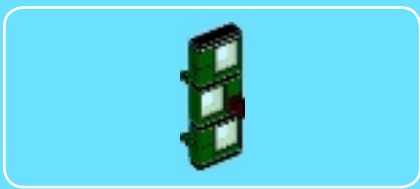

# 38

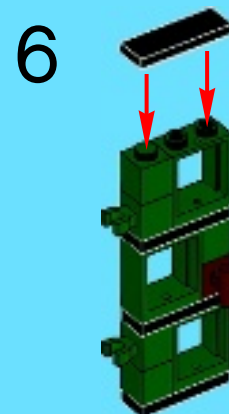
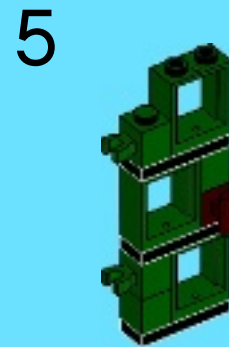
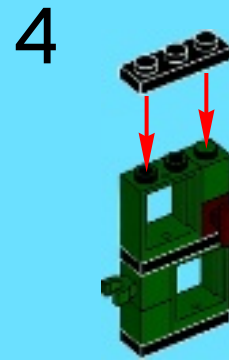
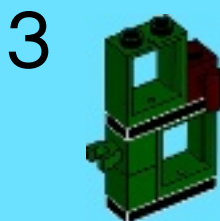
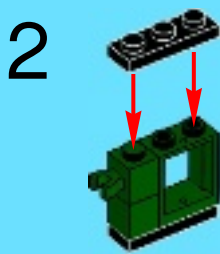
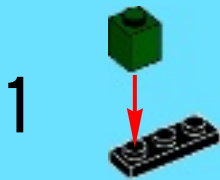

7

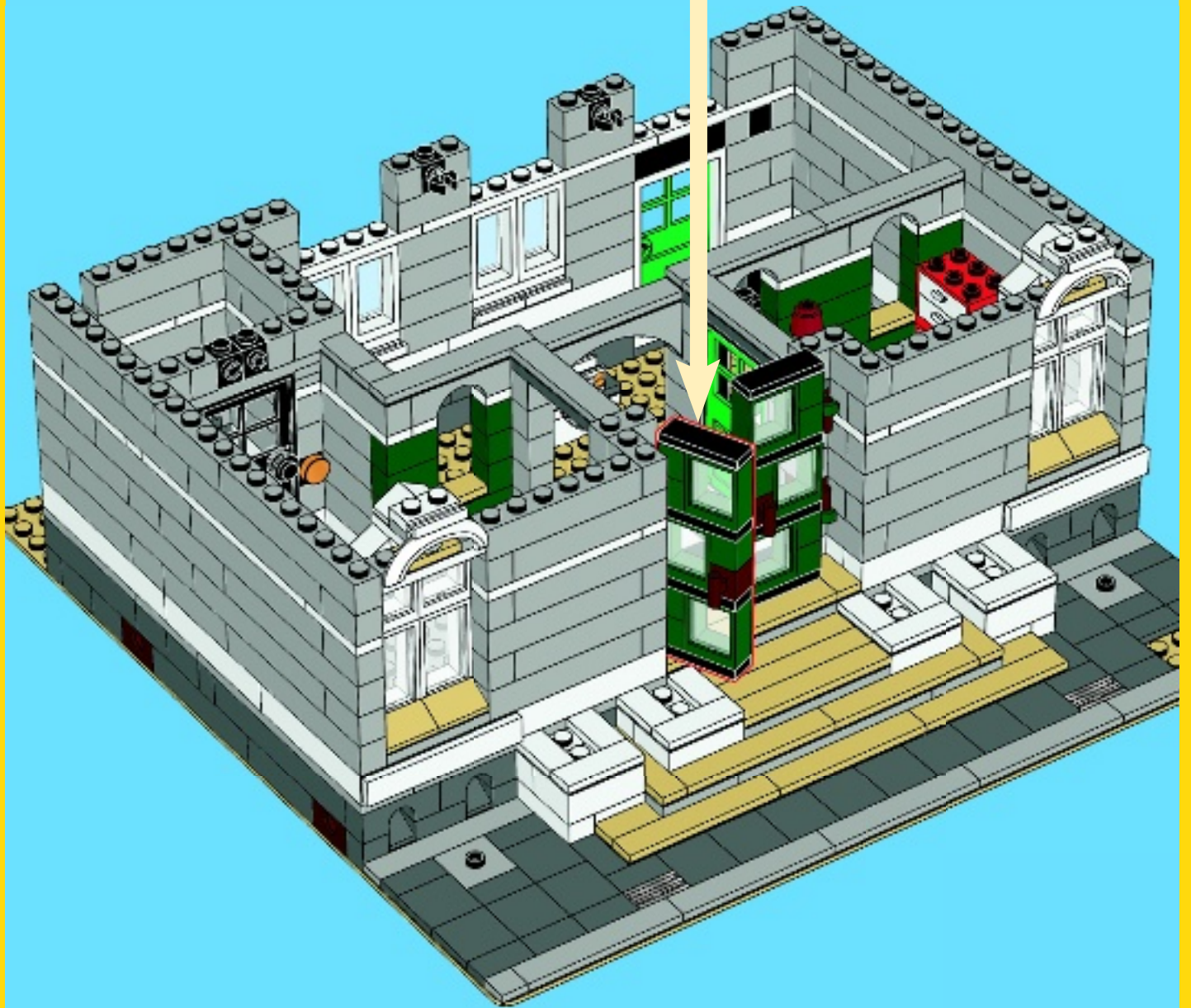
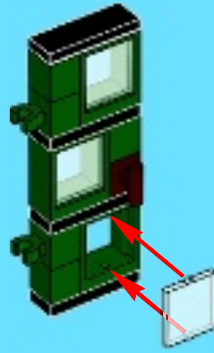



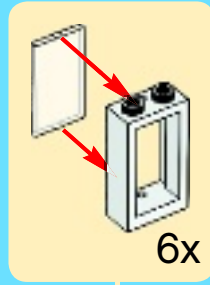
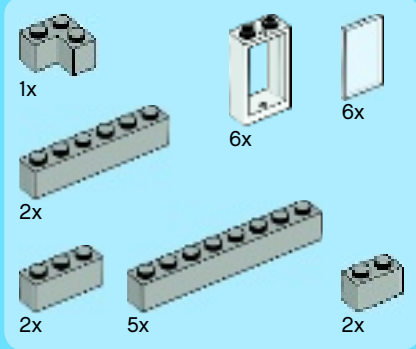

39

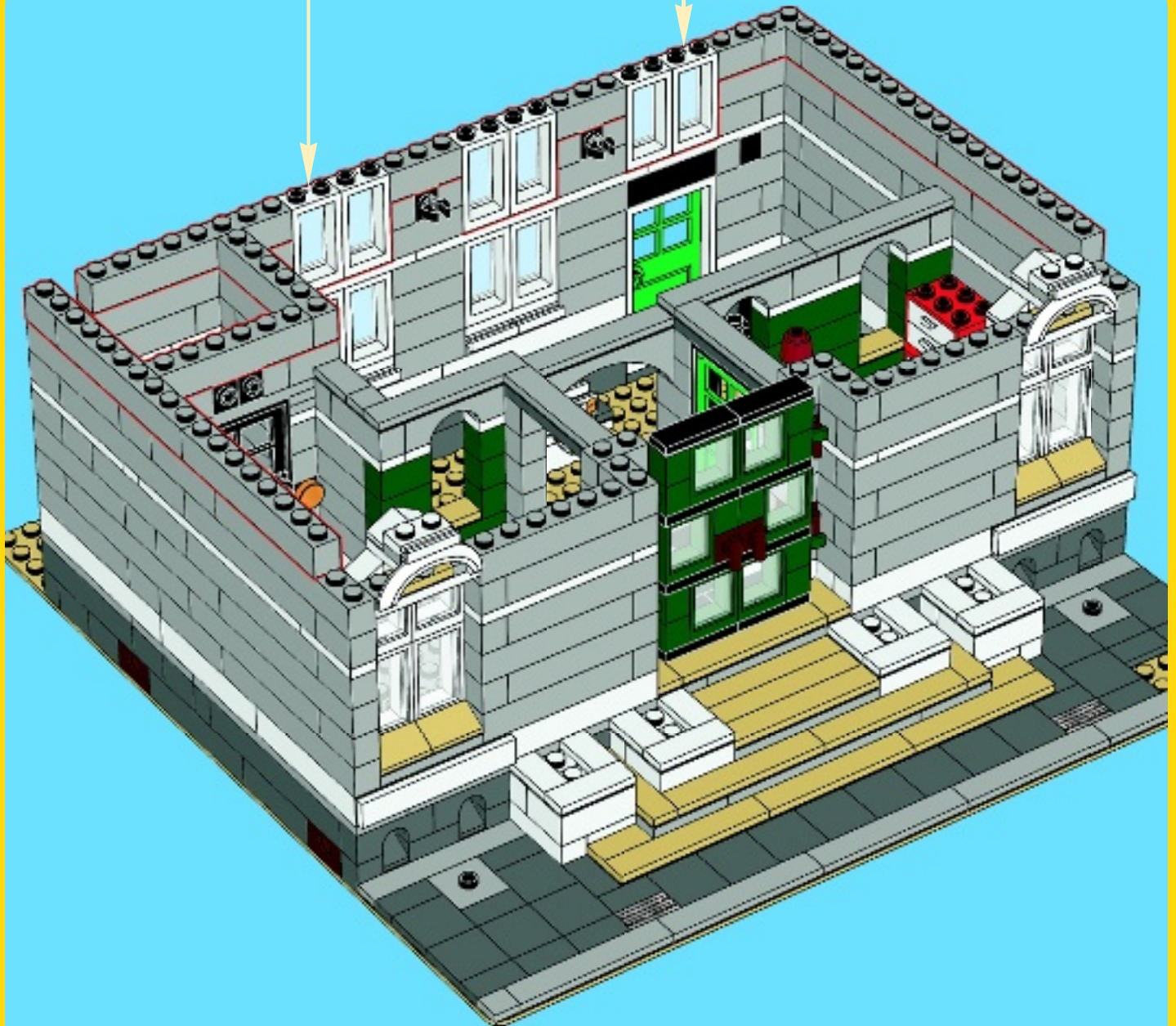

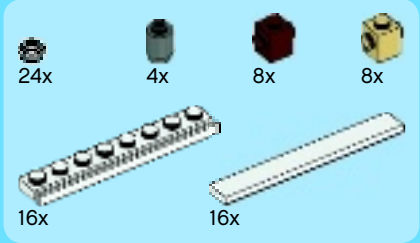

# 40

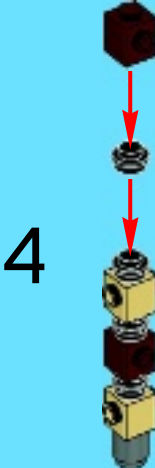
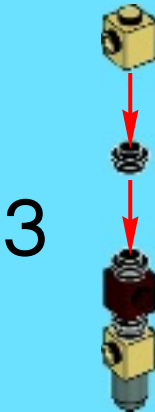
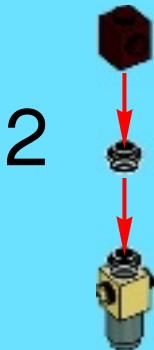
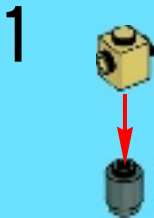



5

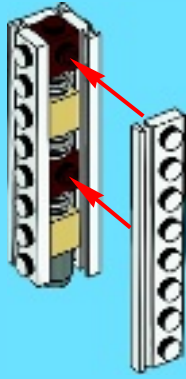

6



4x

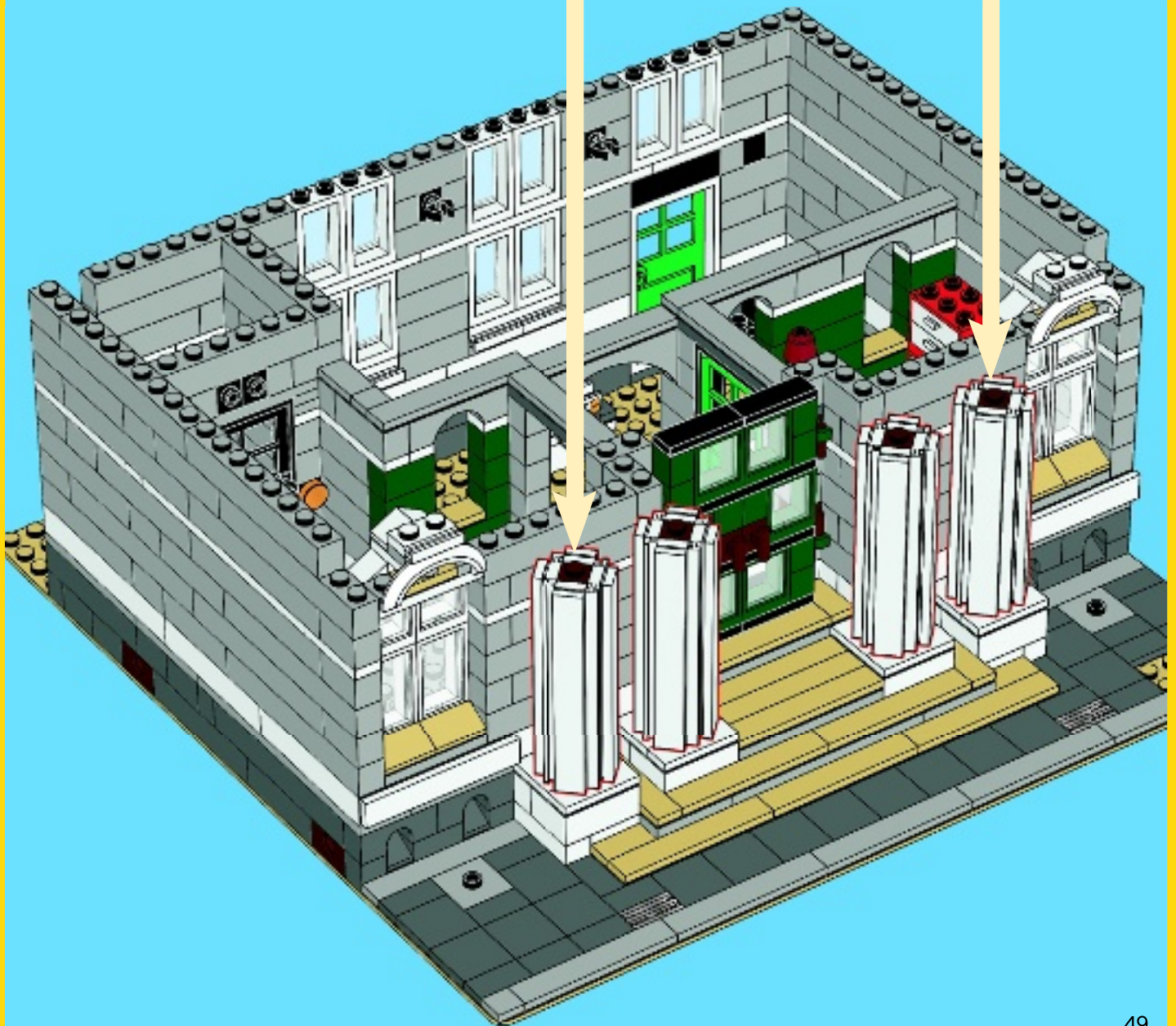



41

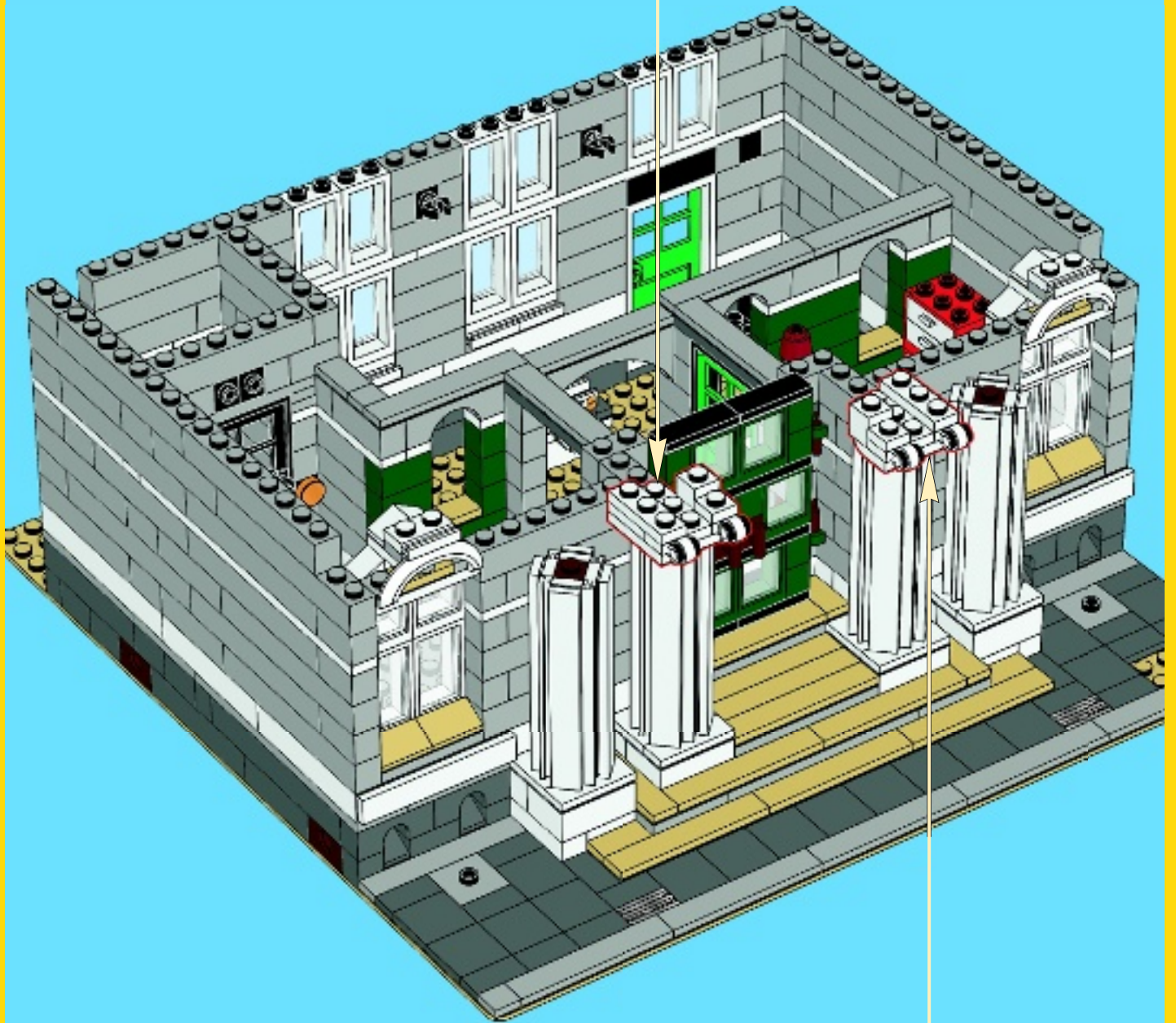





42

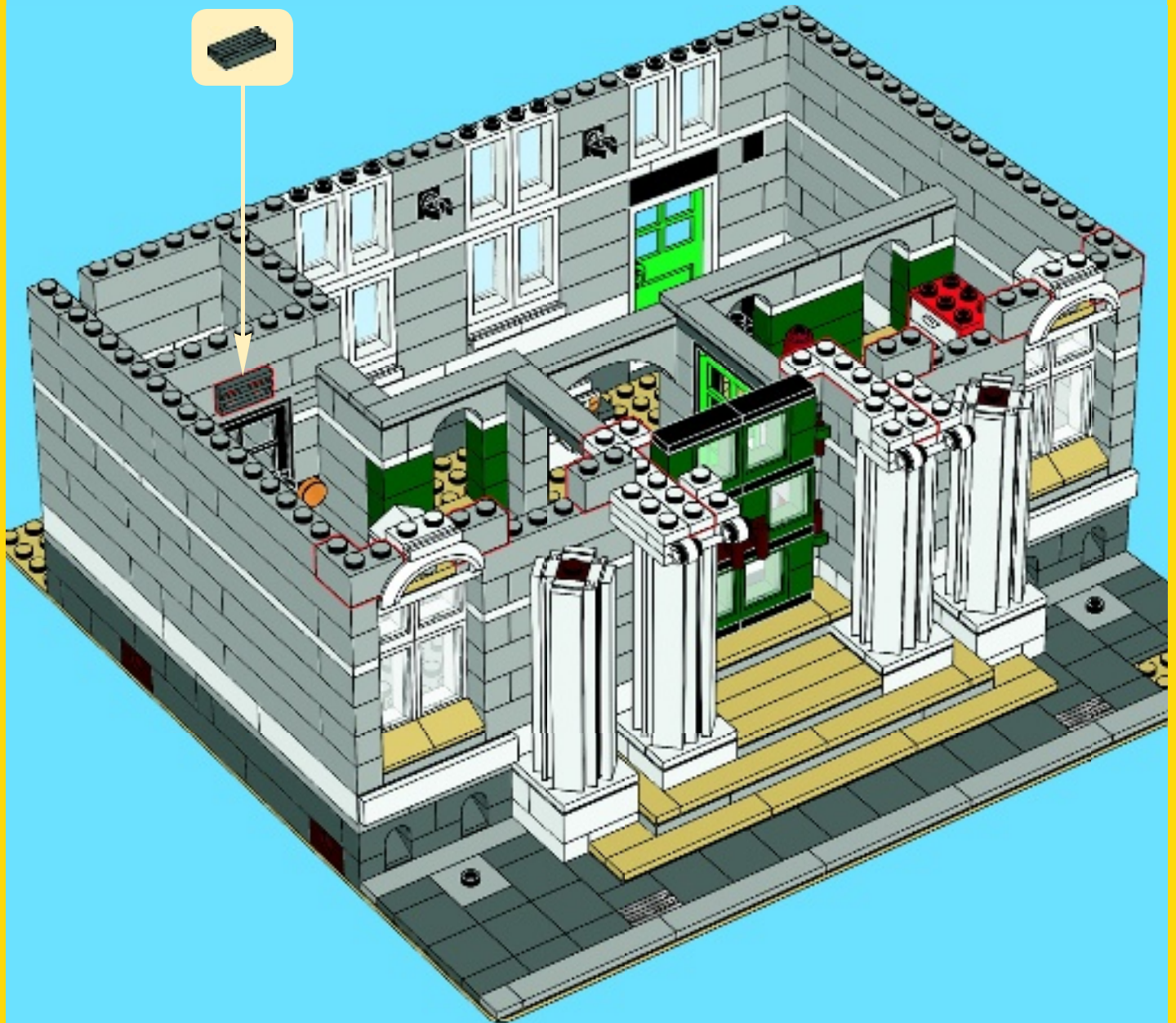

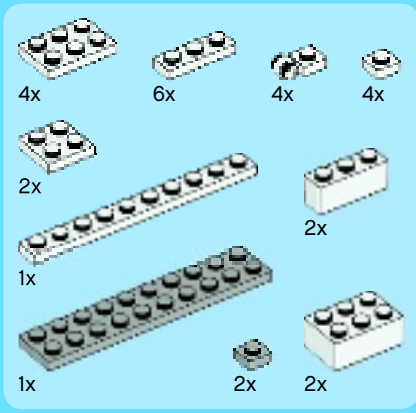

# 43

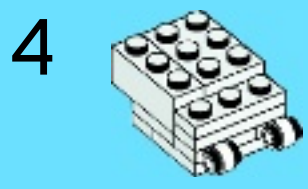
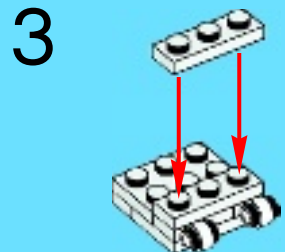
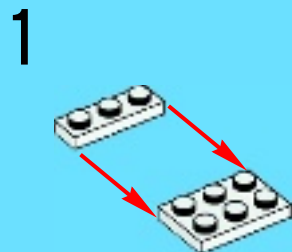

2x



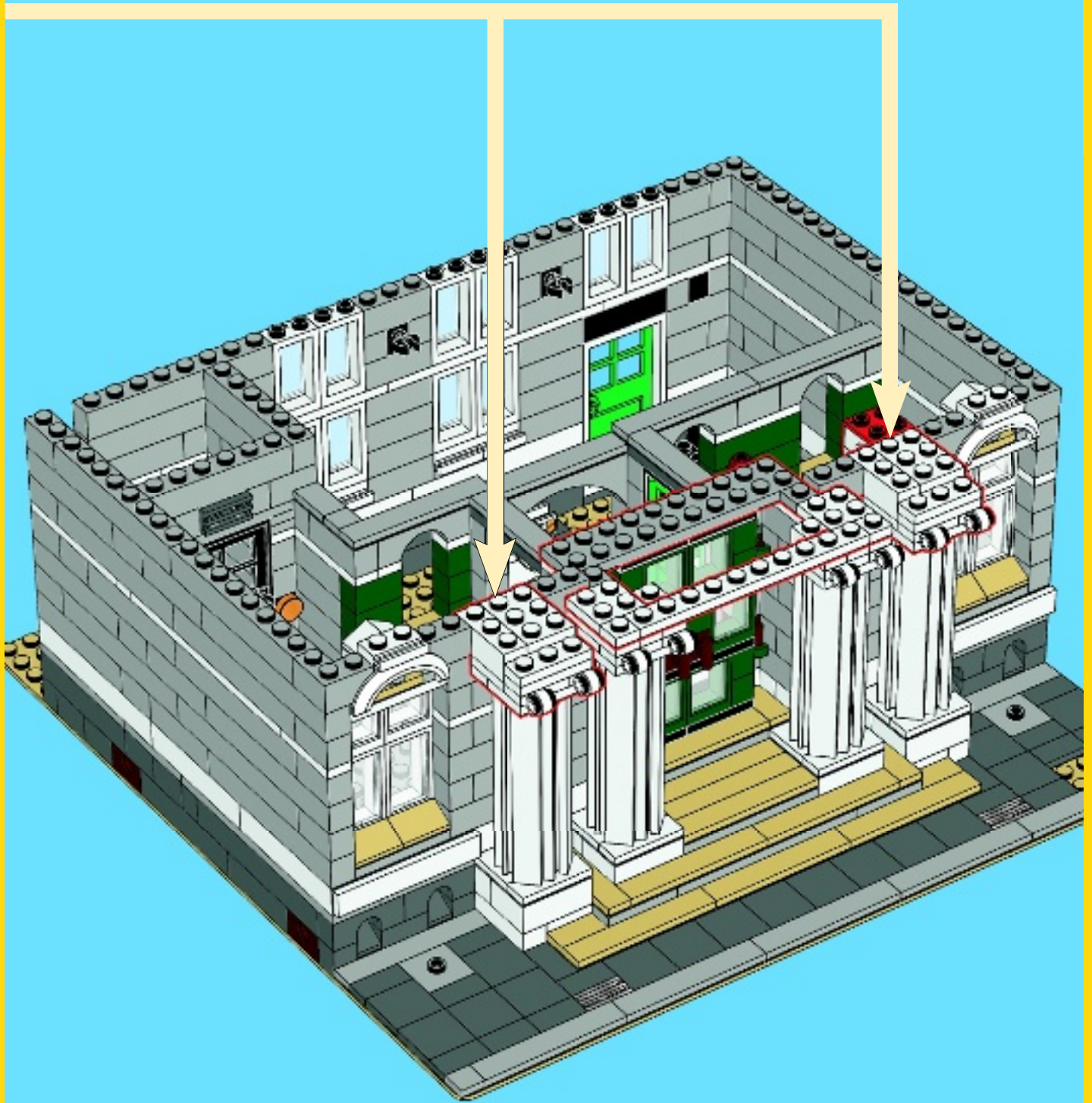

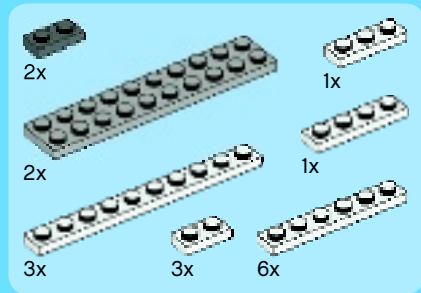

# 44

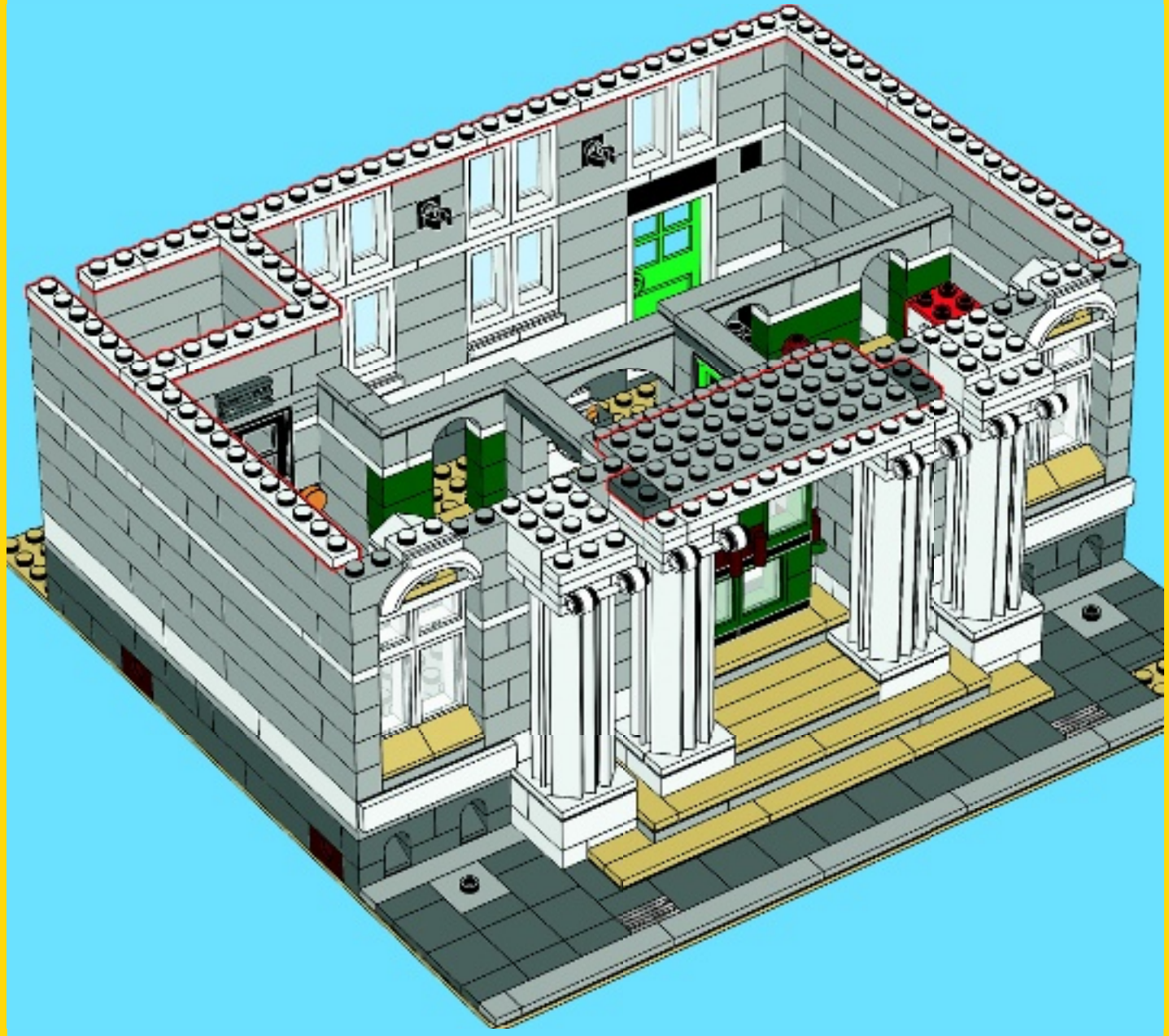



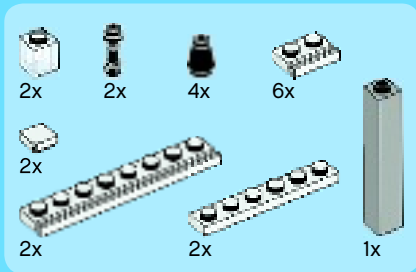

45

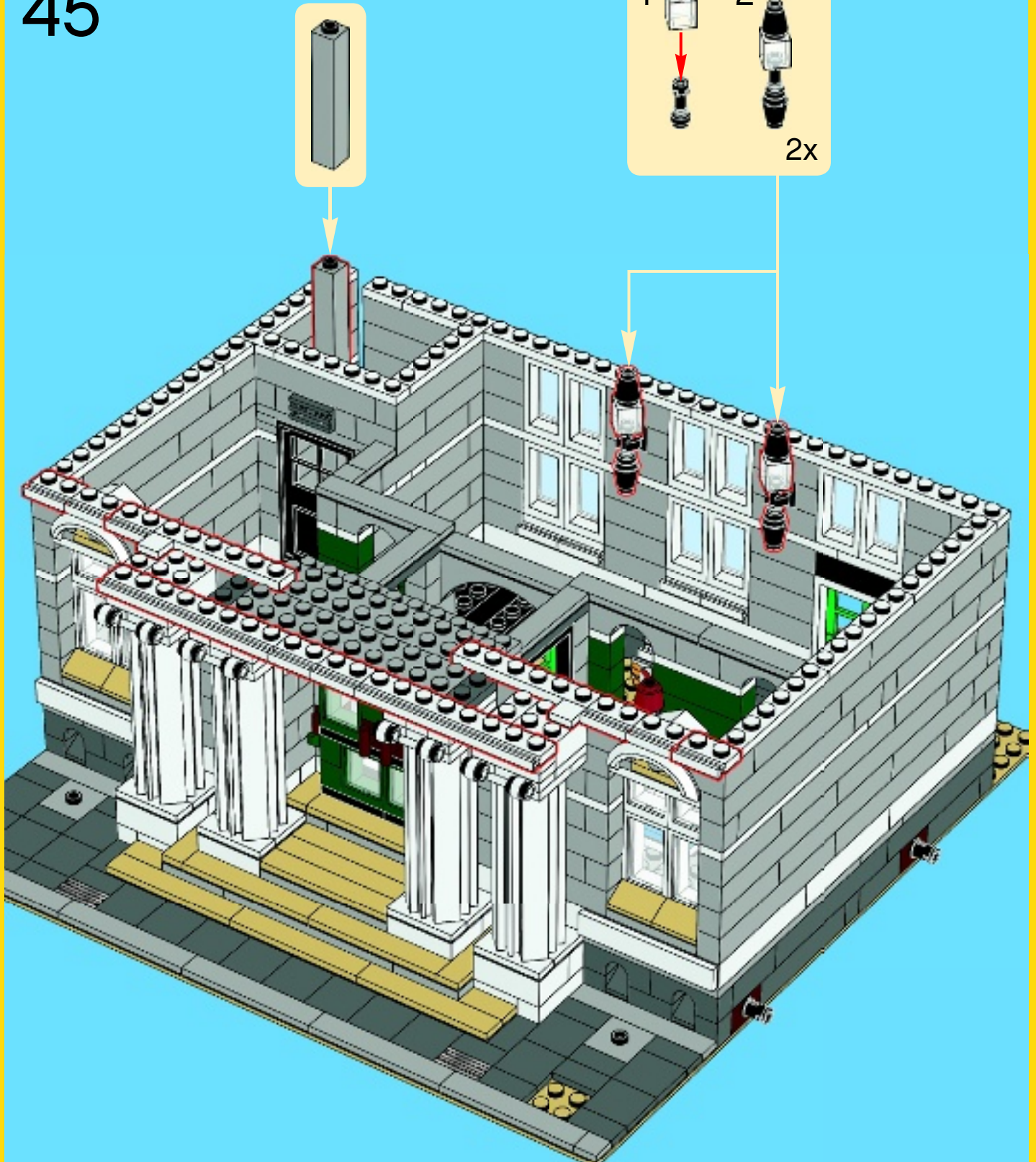
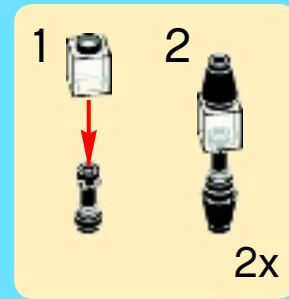

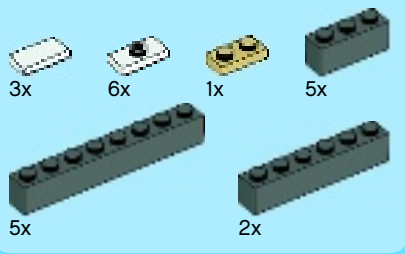

46

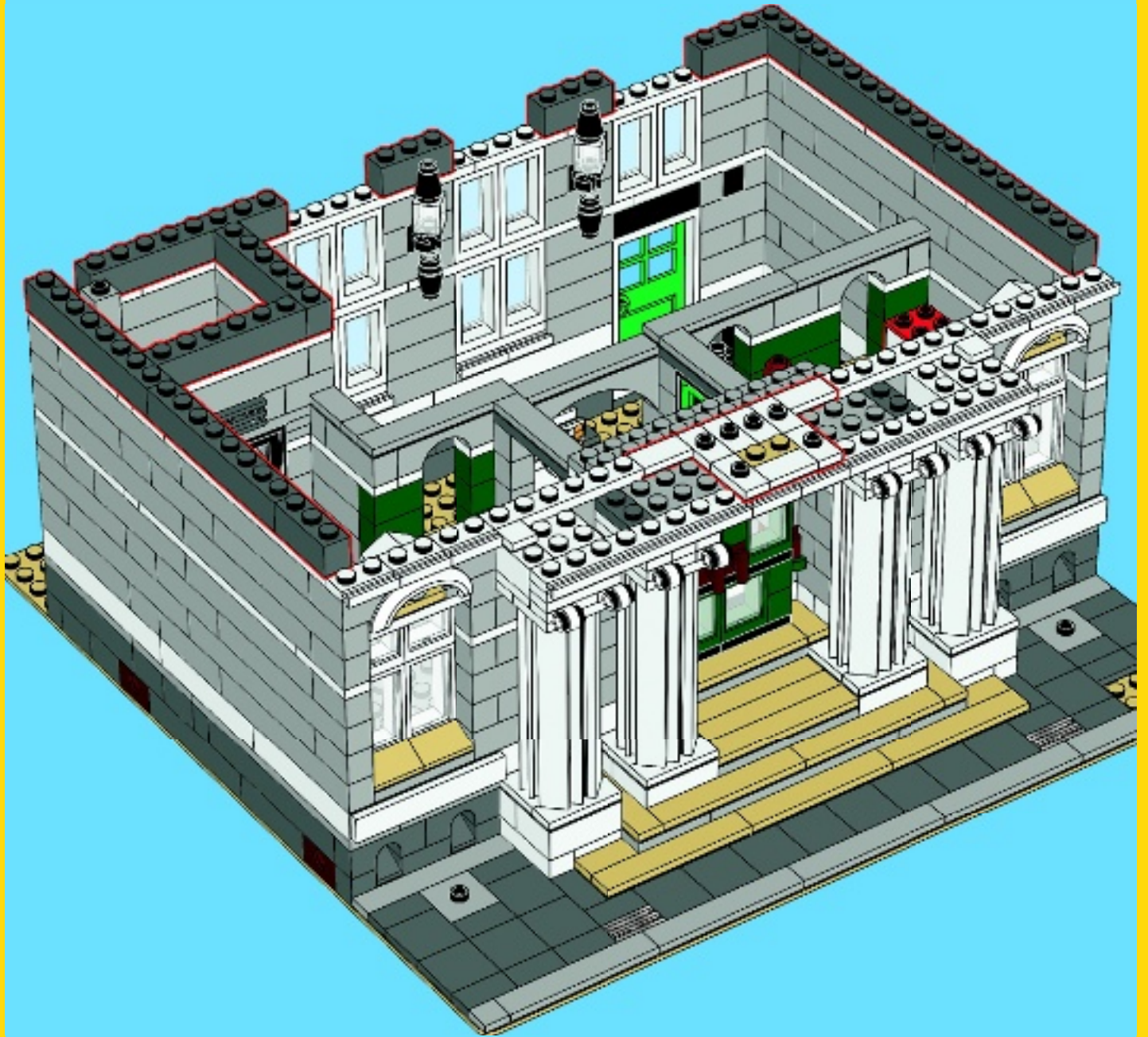



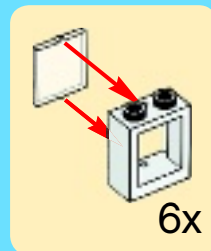
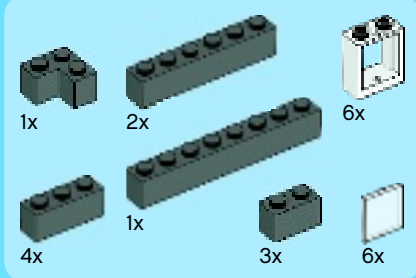

47

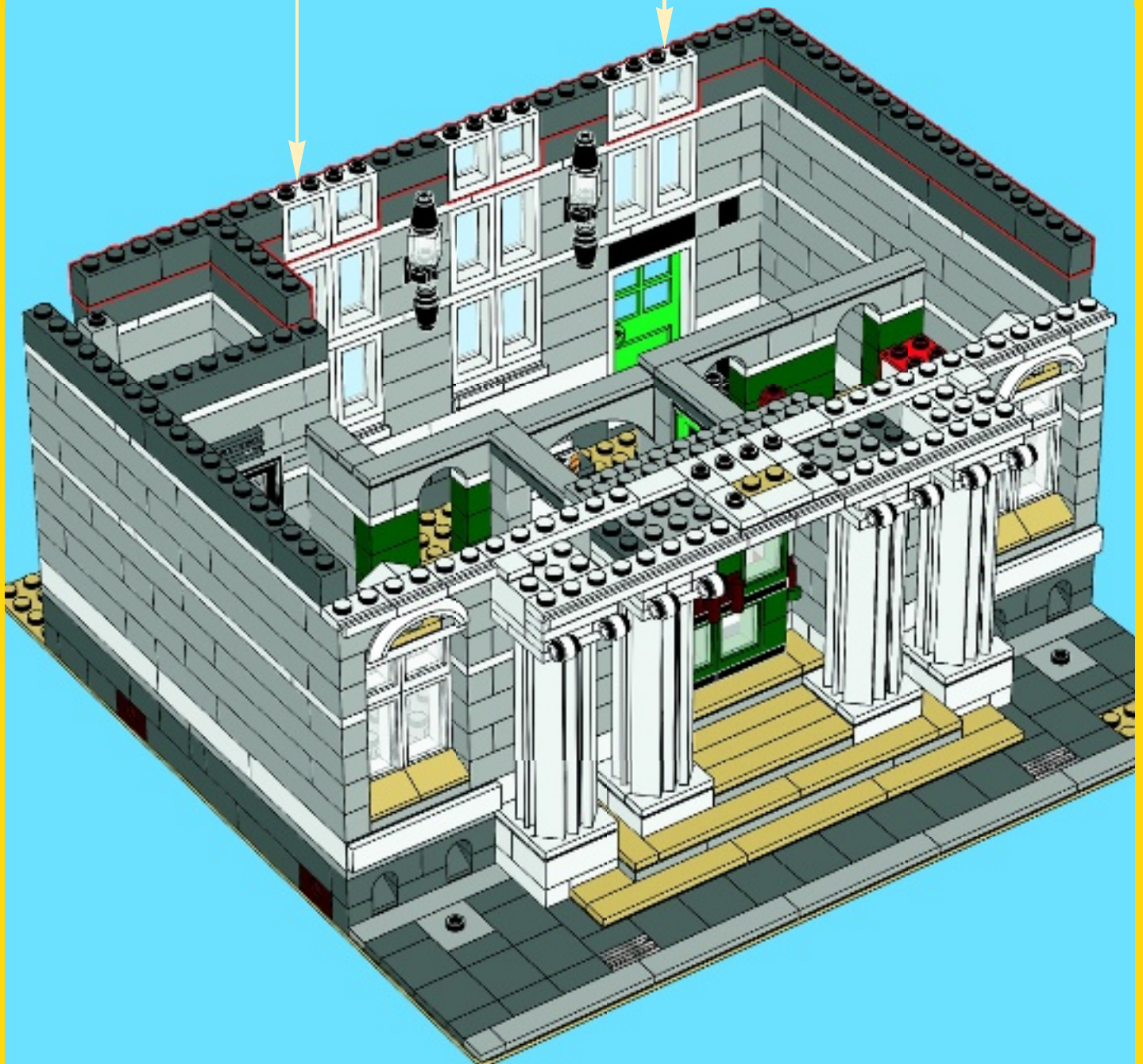

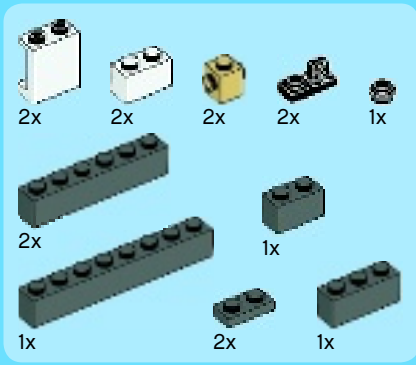

# 48

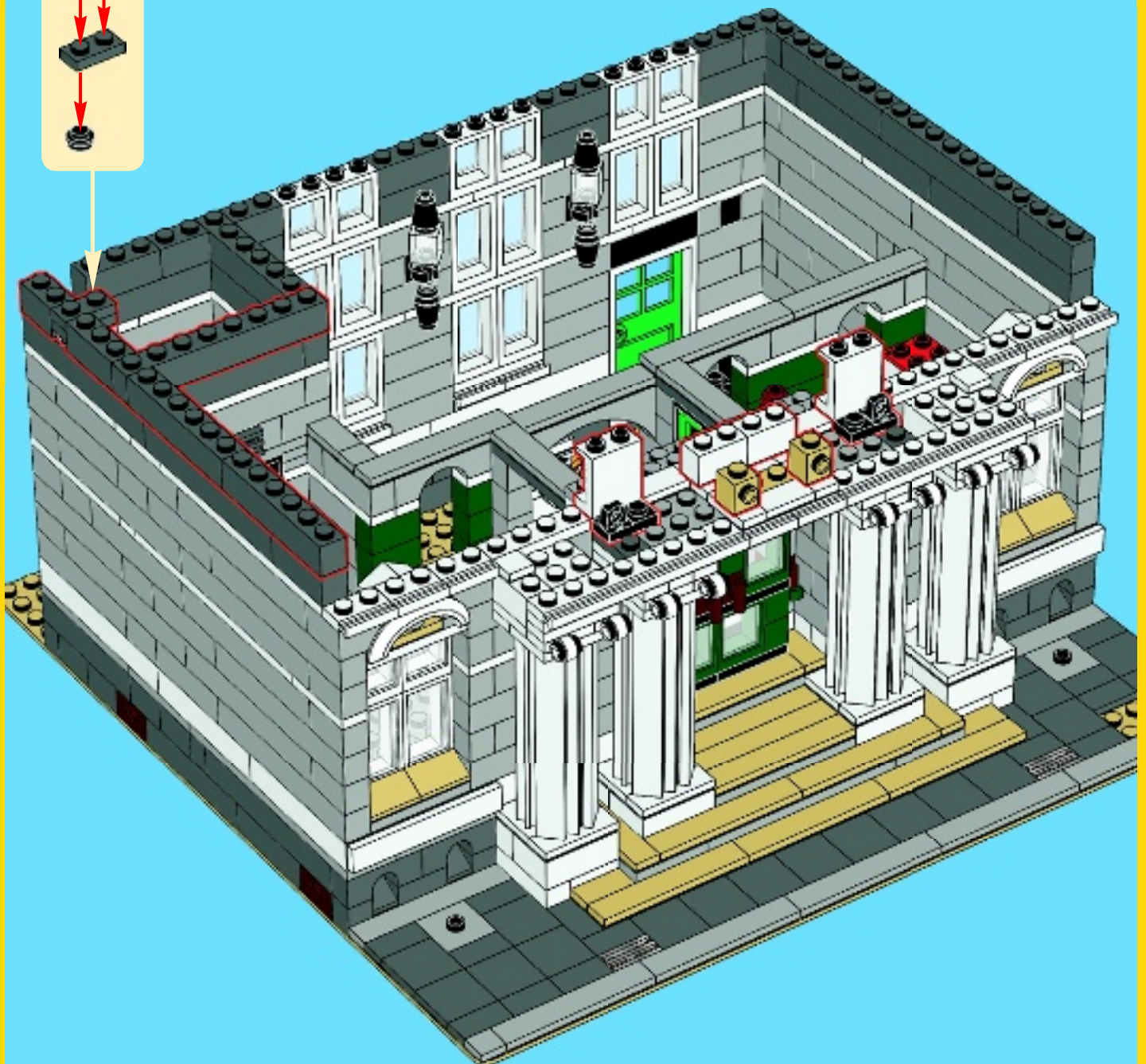
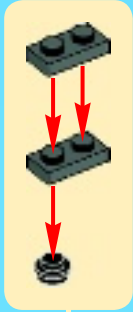



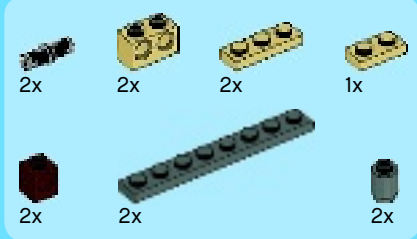

49

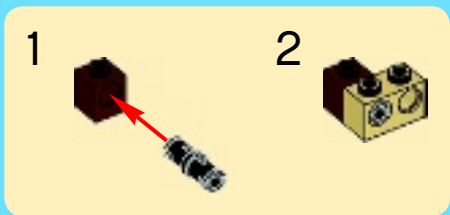
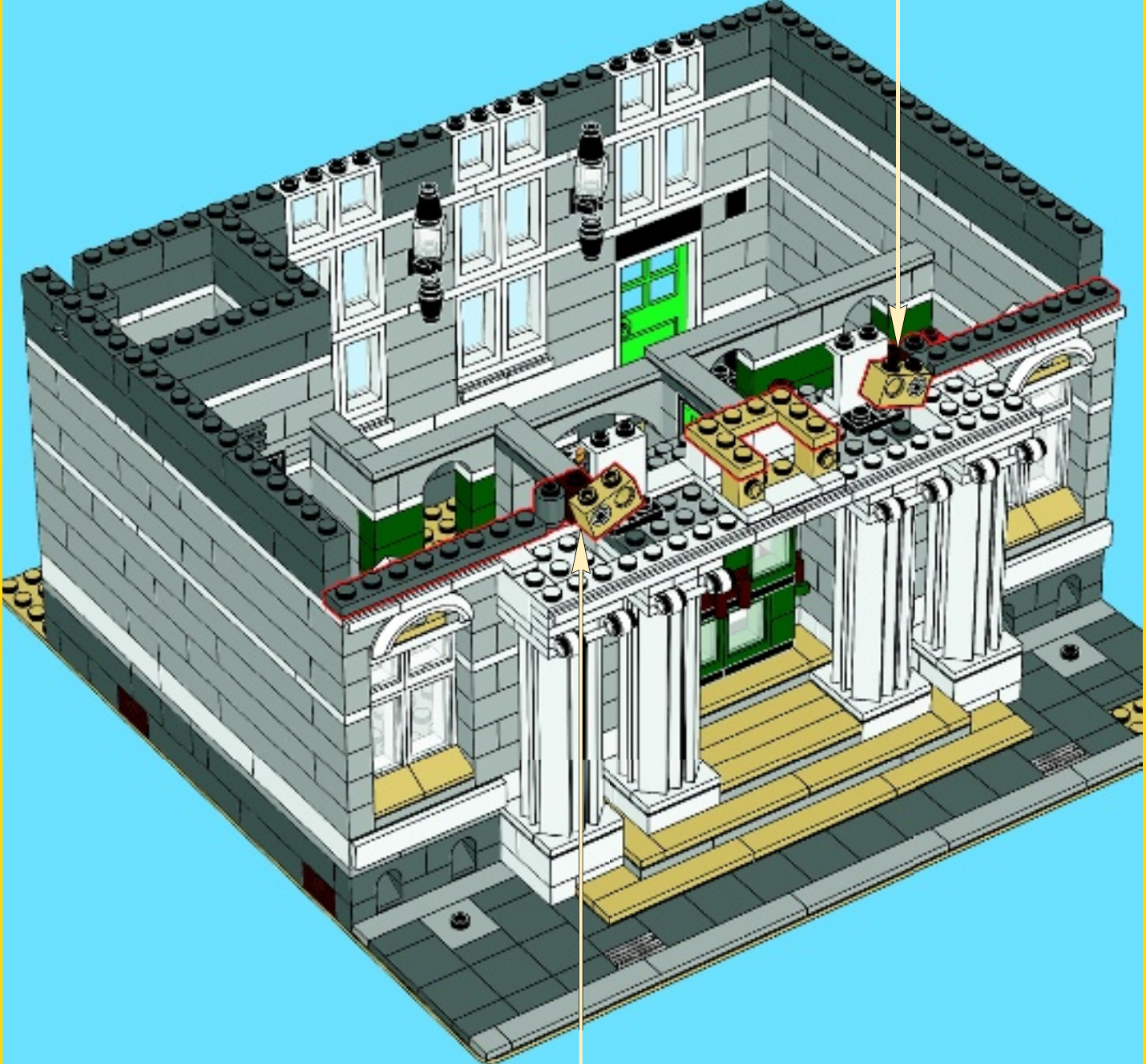

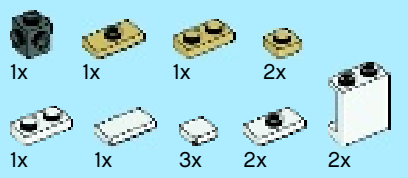

# 50

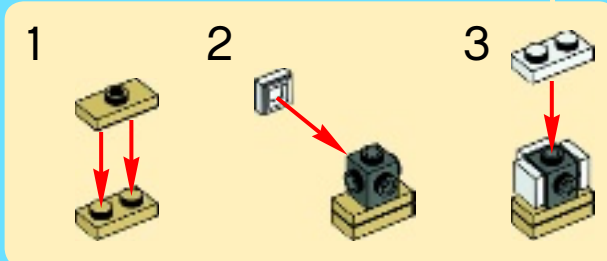
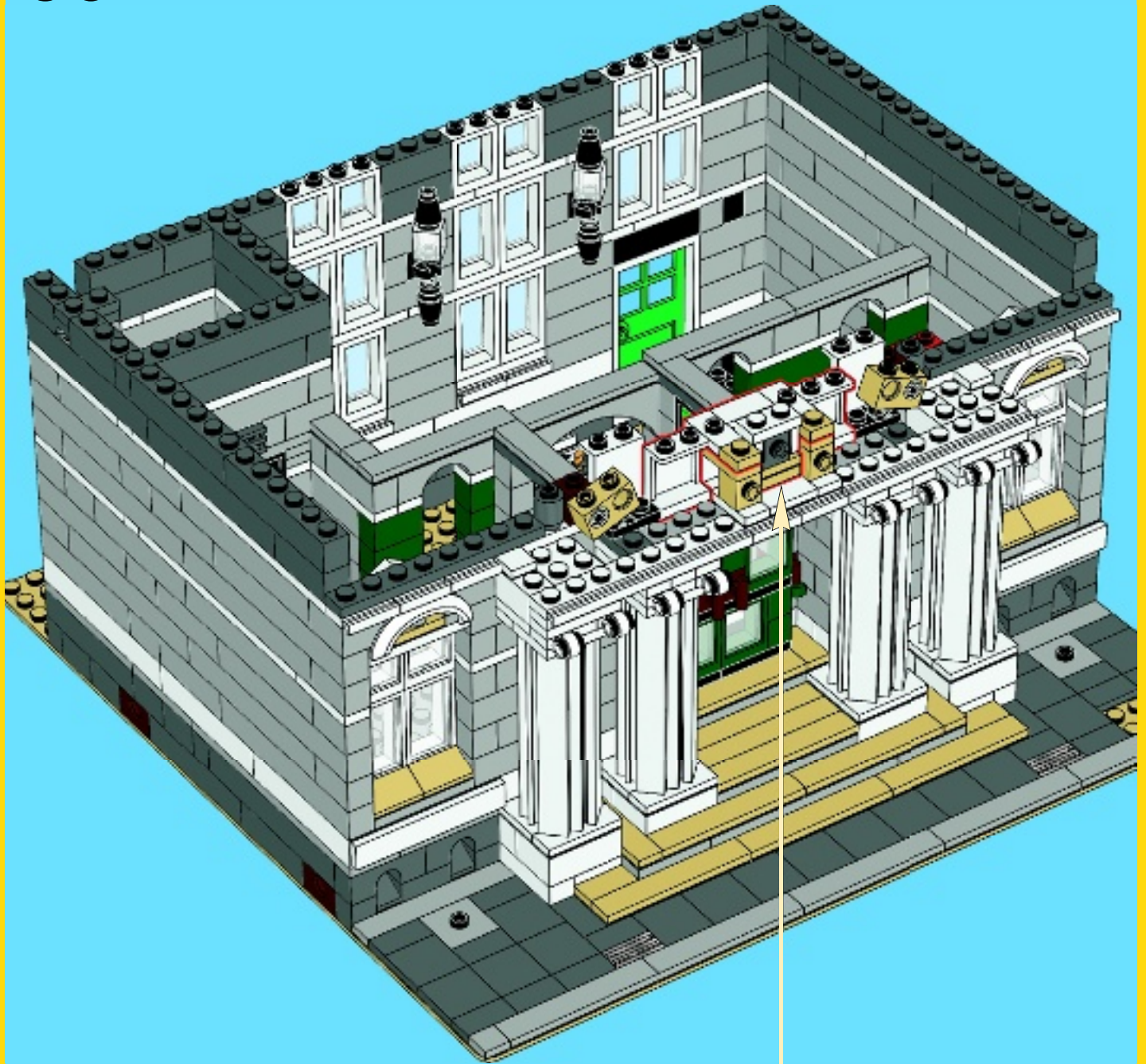



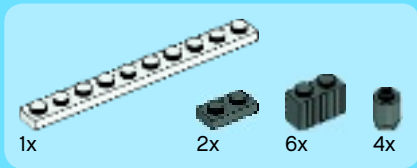

51

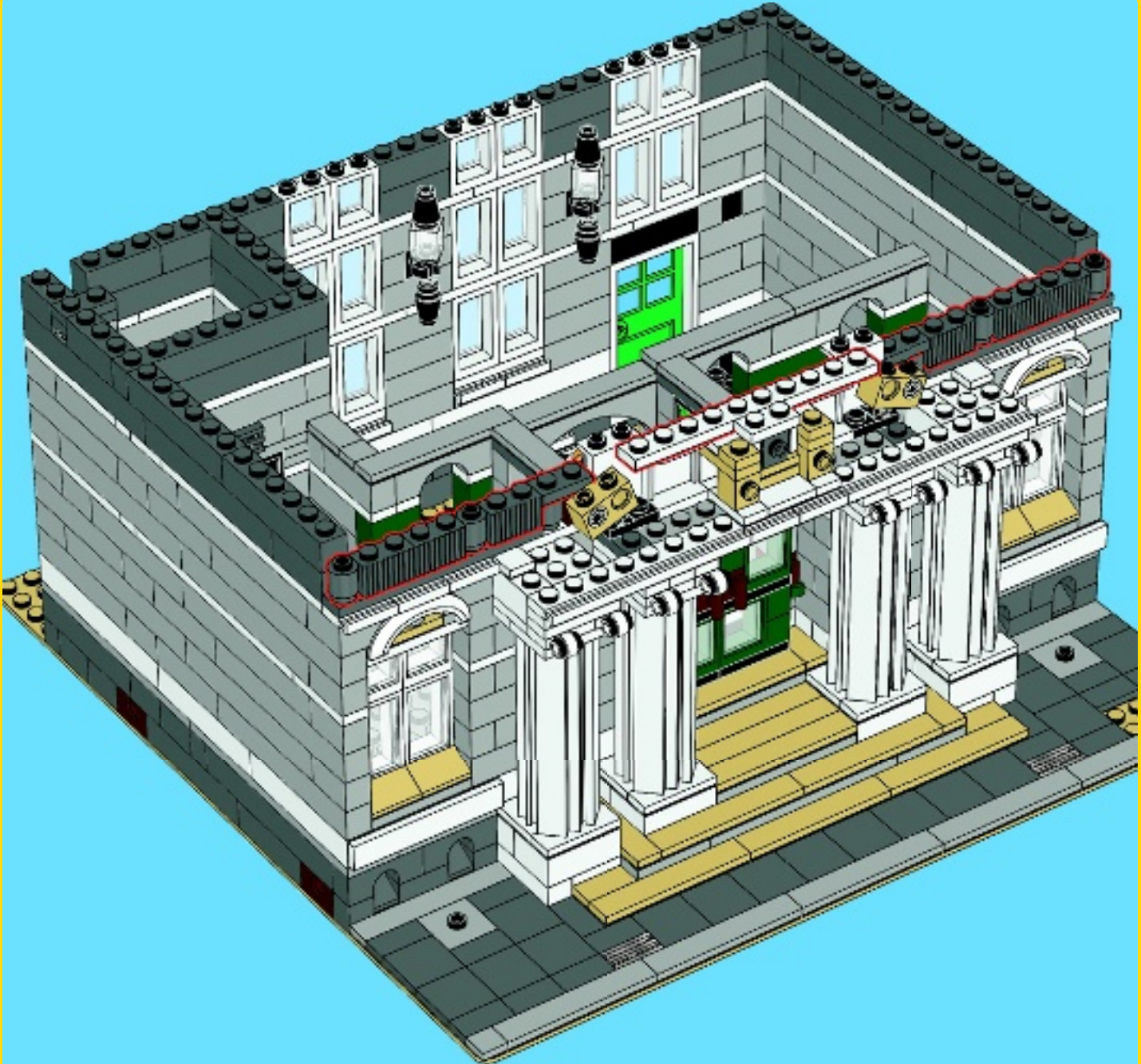

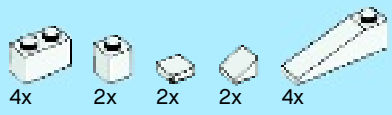

52

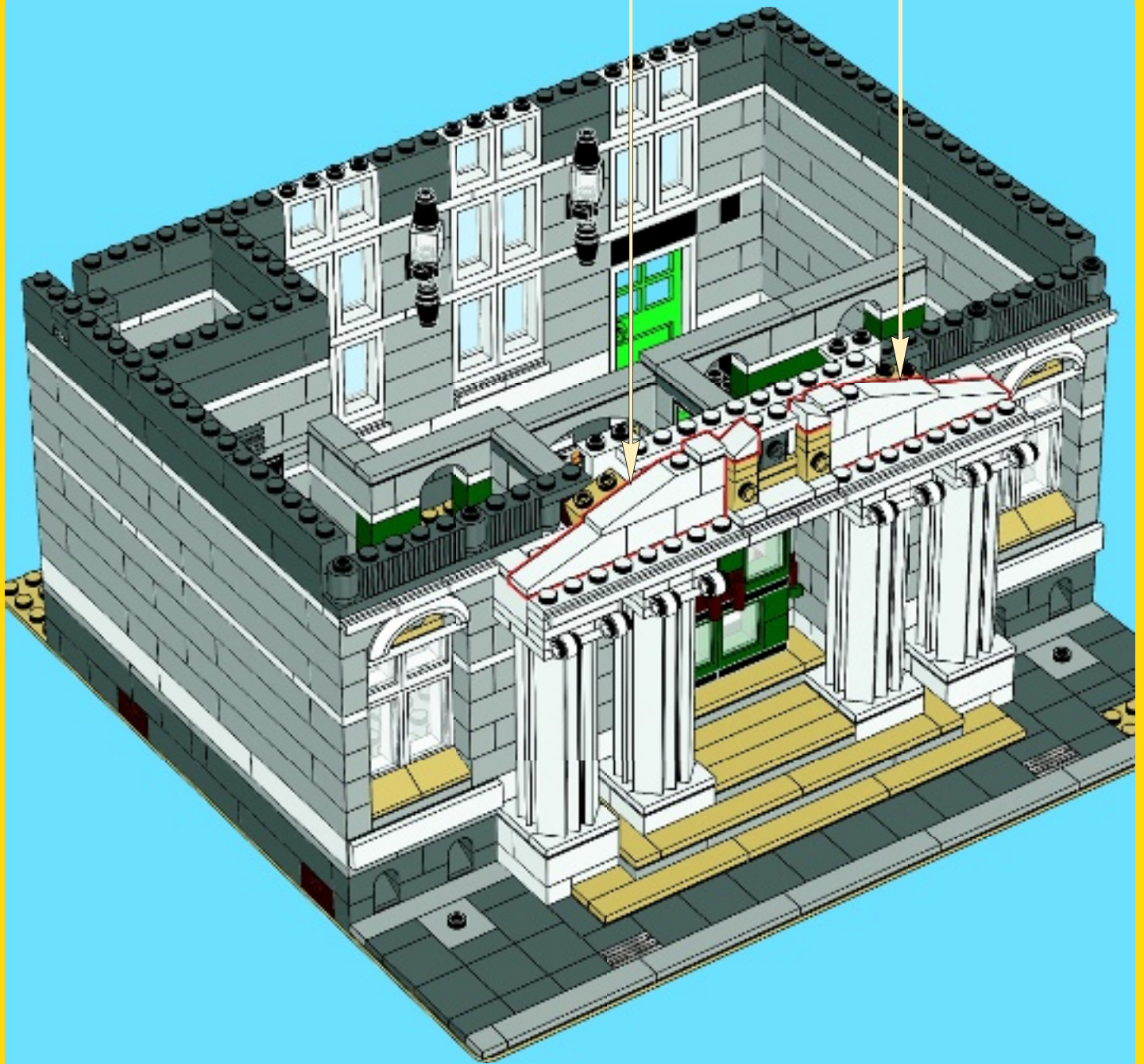
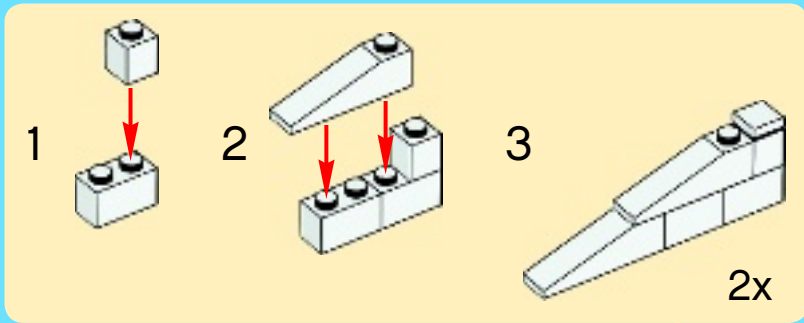



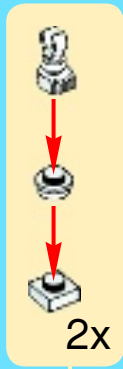
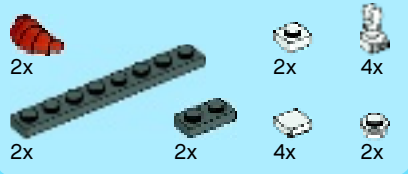

53

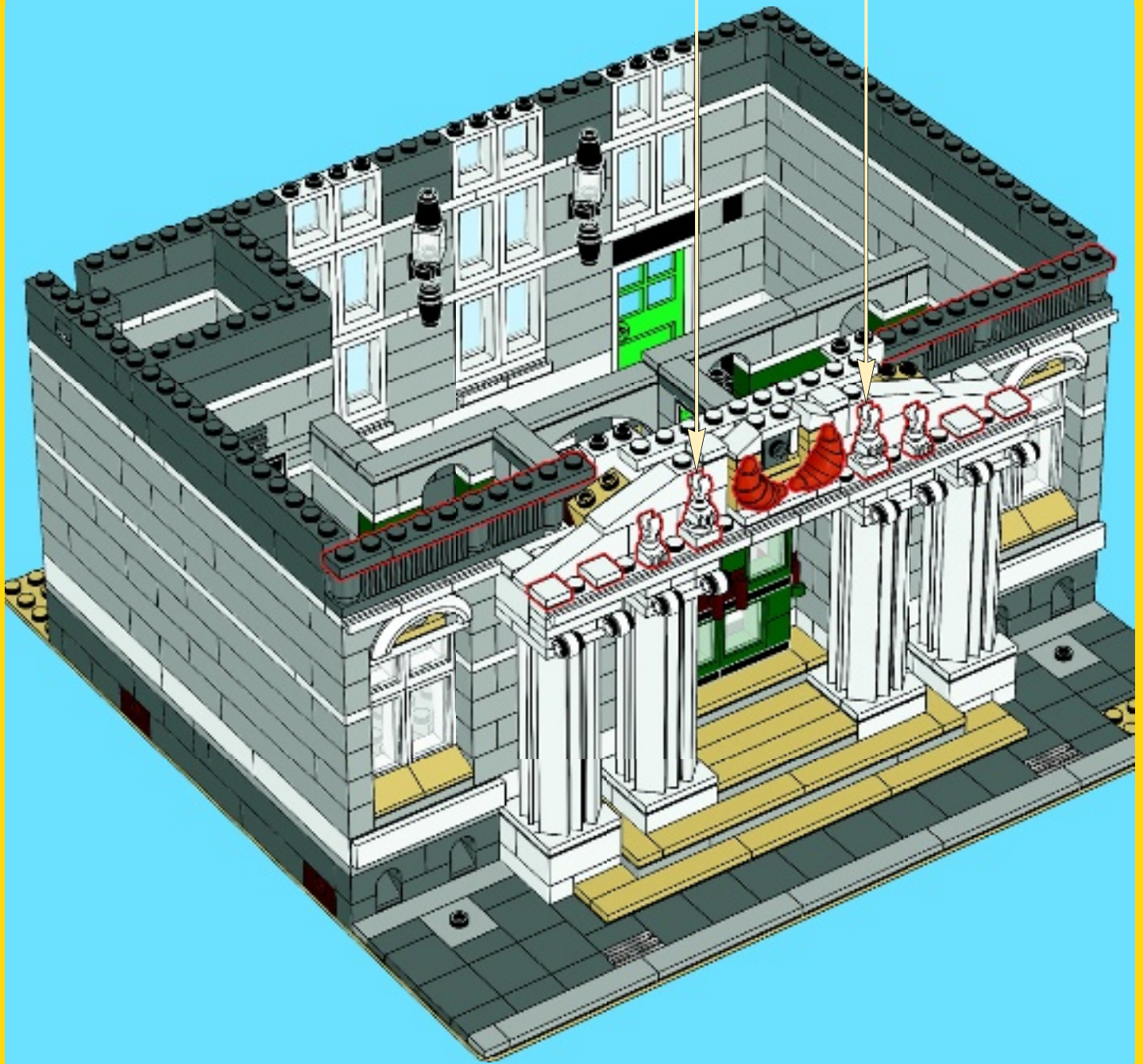

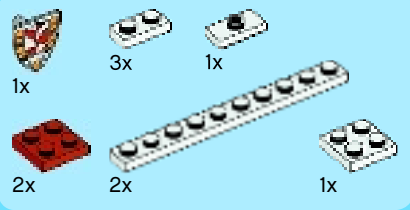

54

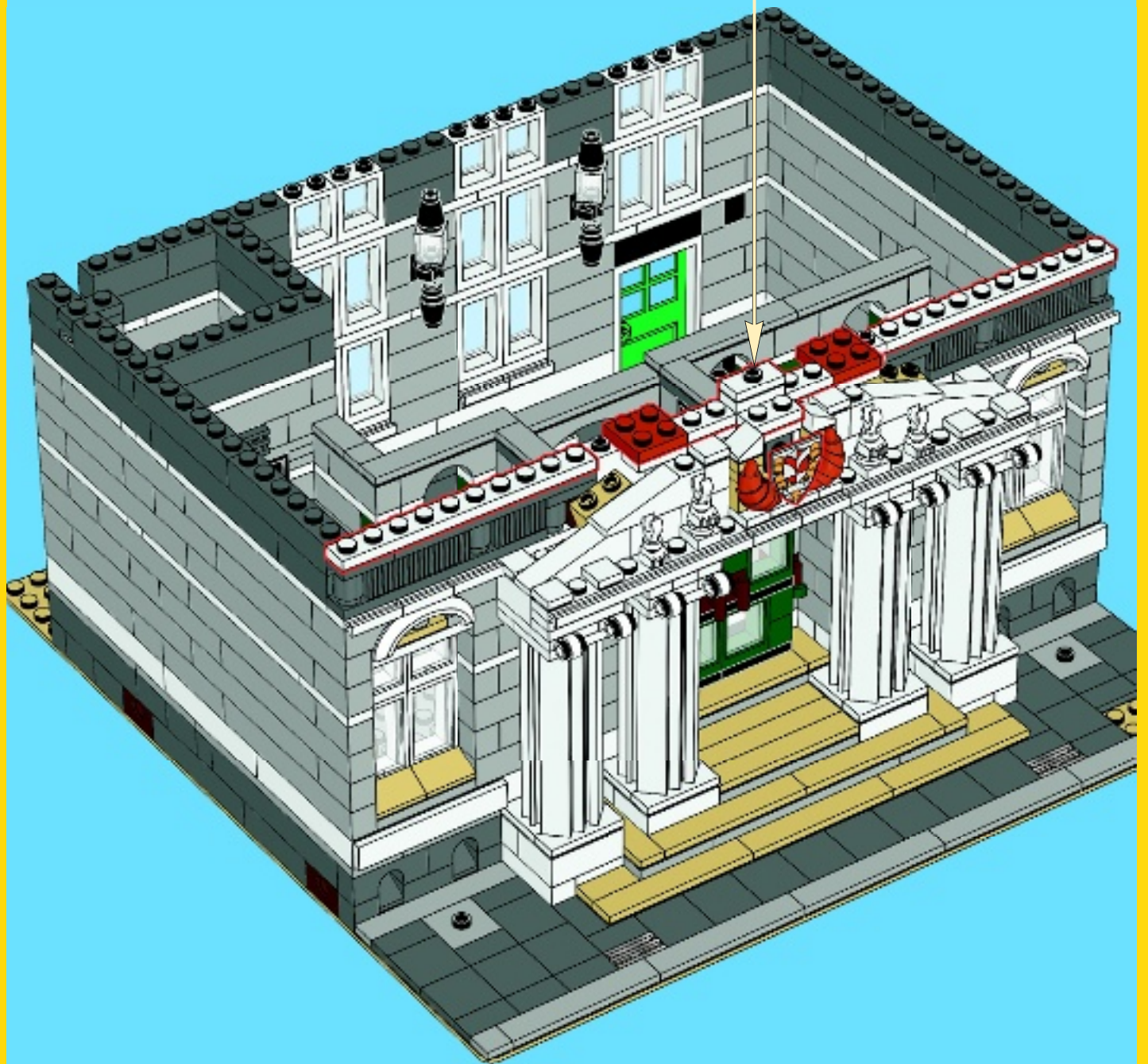
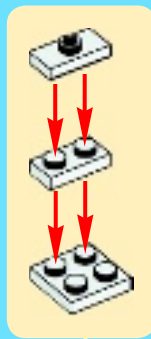



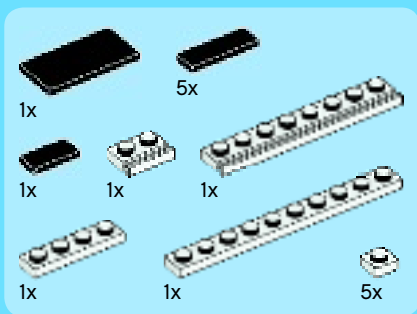

# 55

1

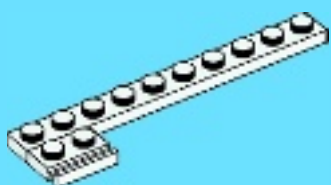

2

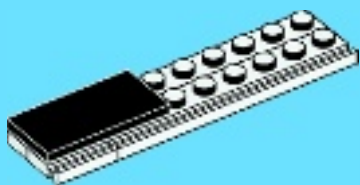

3

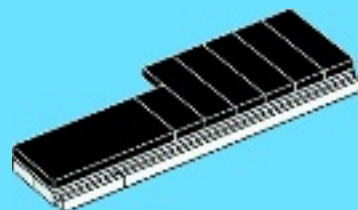

4

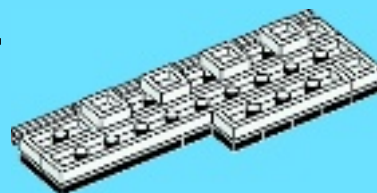

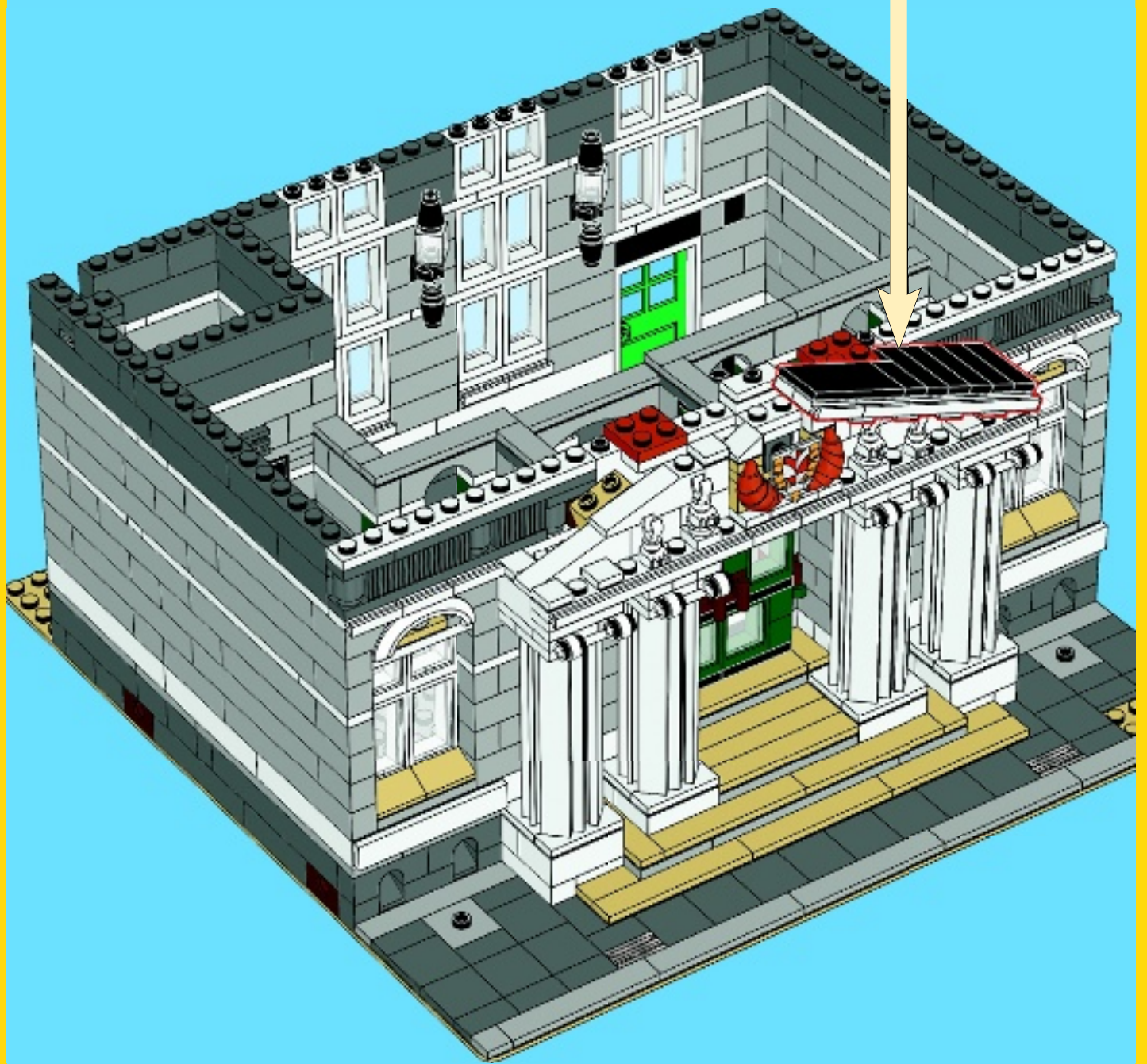



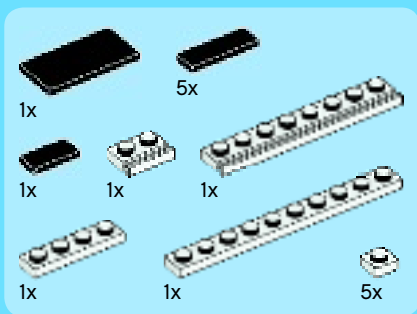

# 56

1

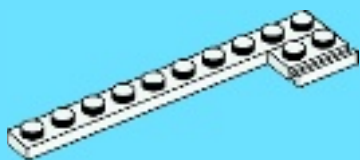

2



3

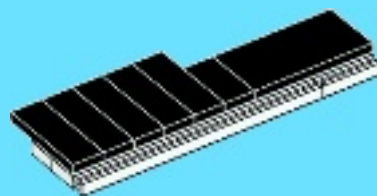

4

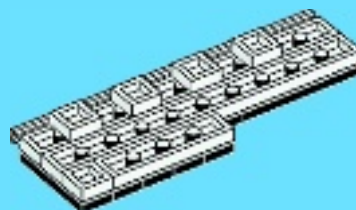

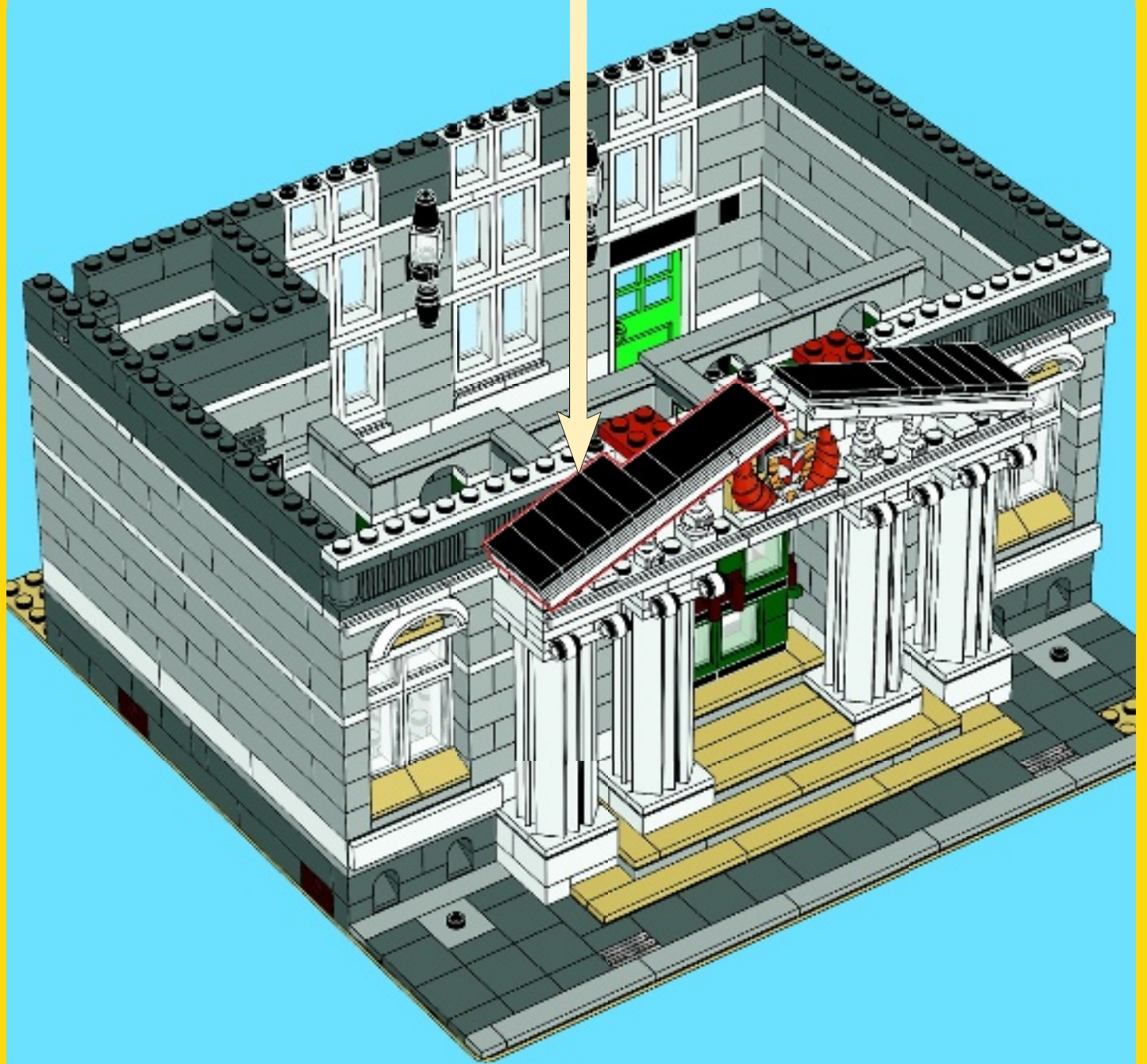



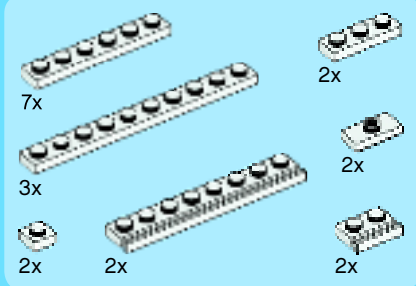

57

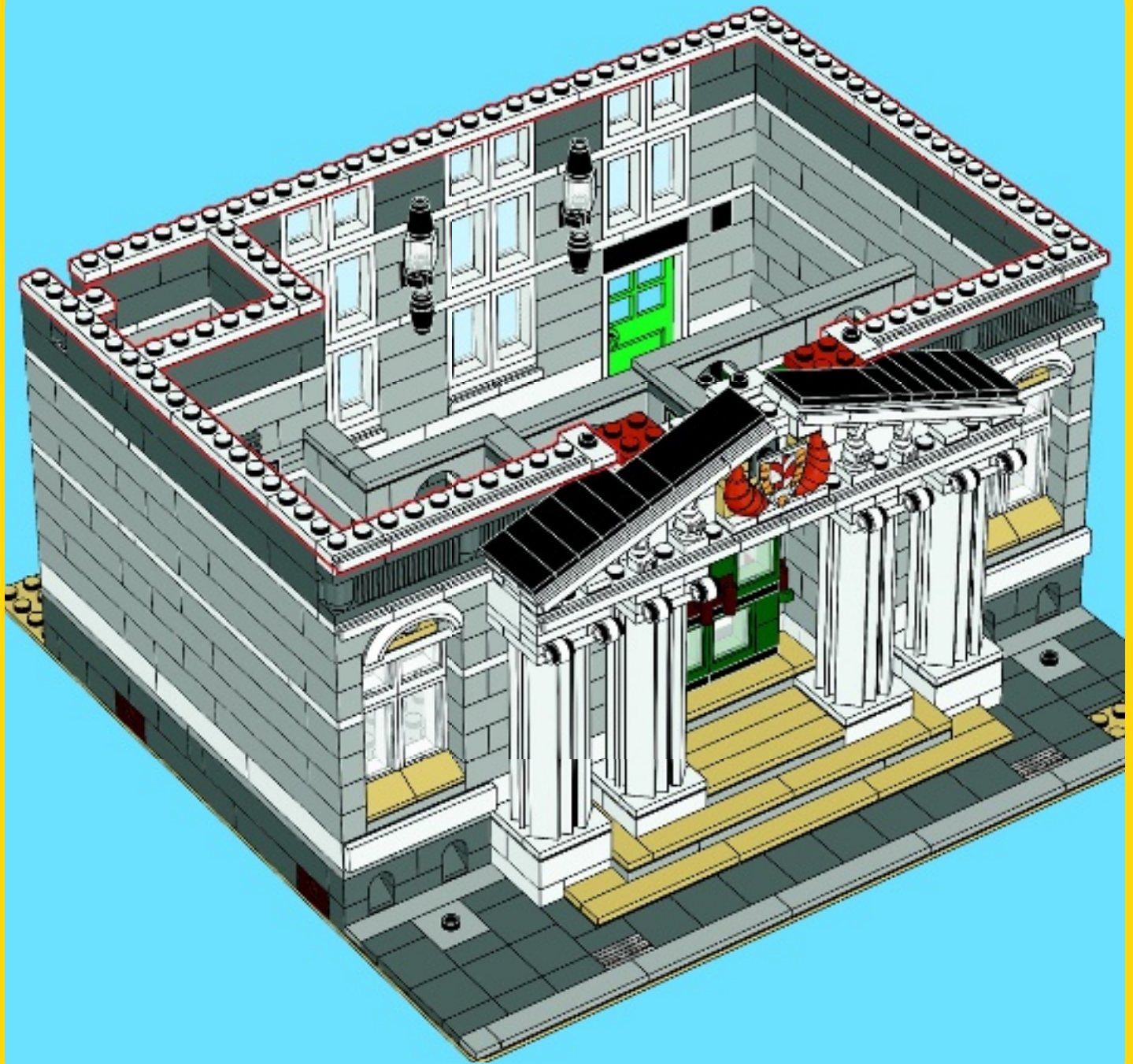



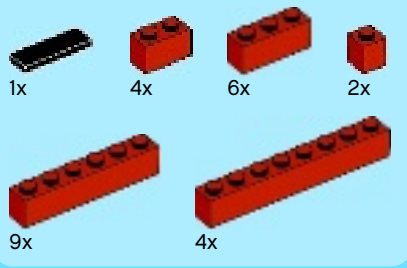

58

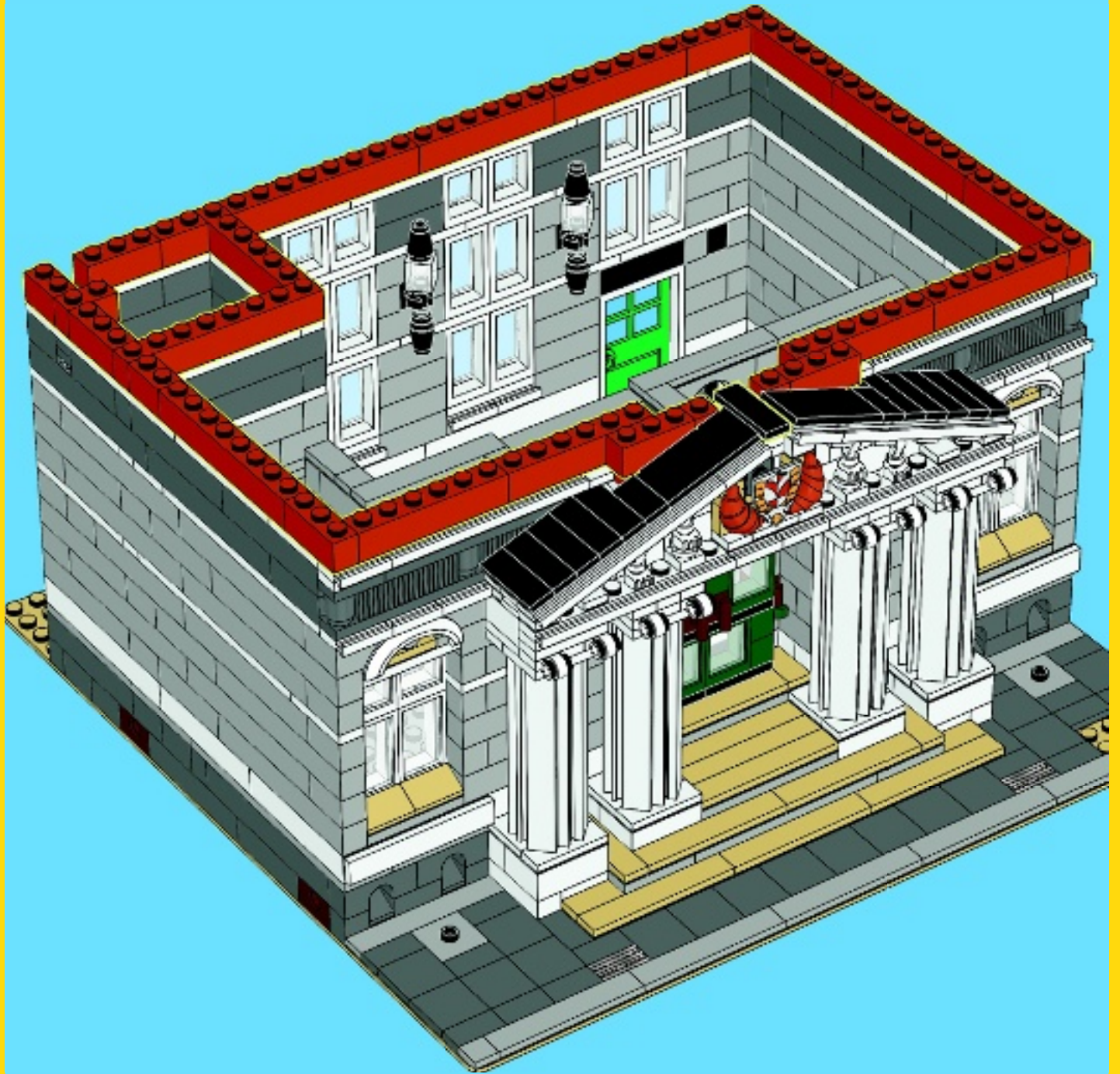



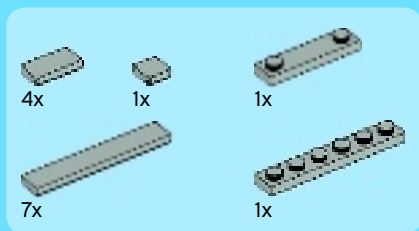

59

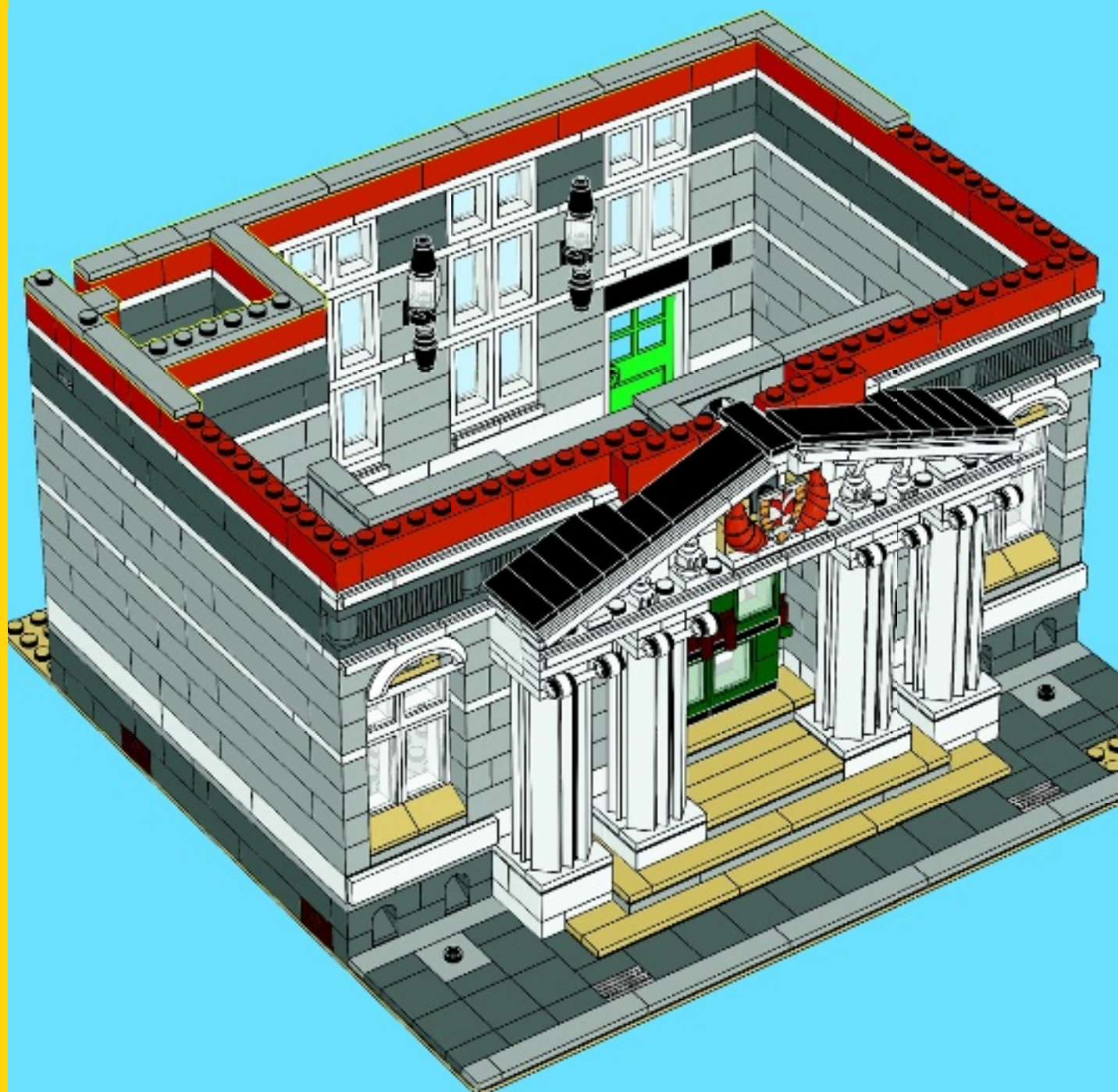



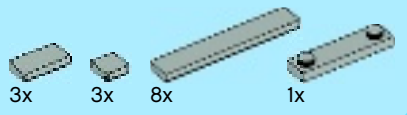

60

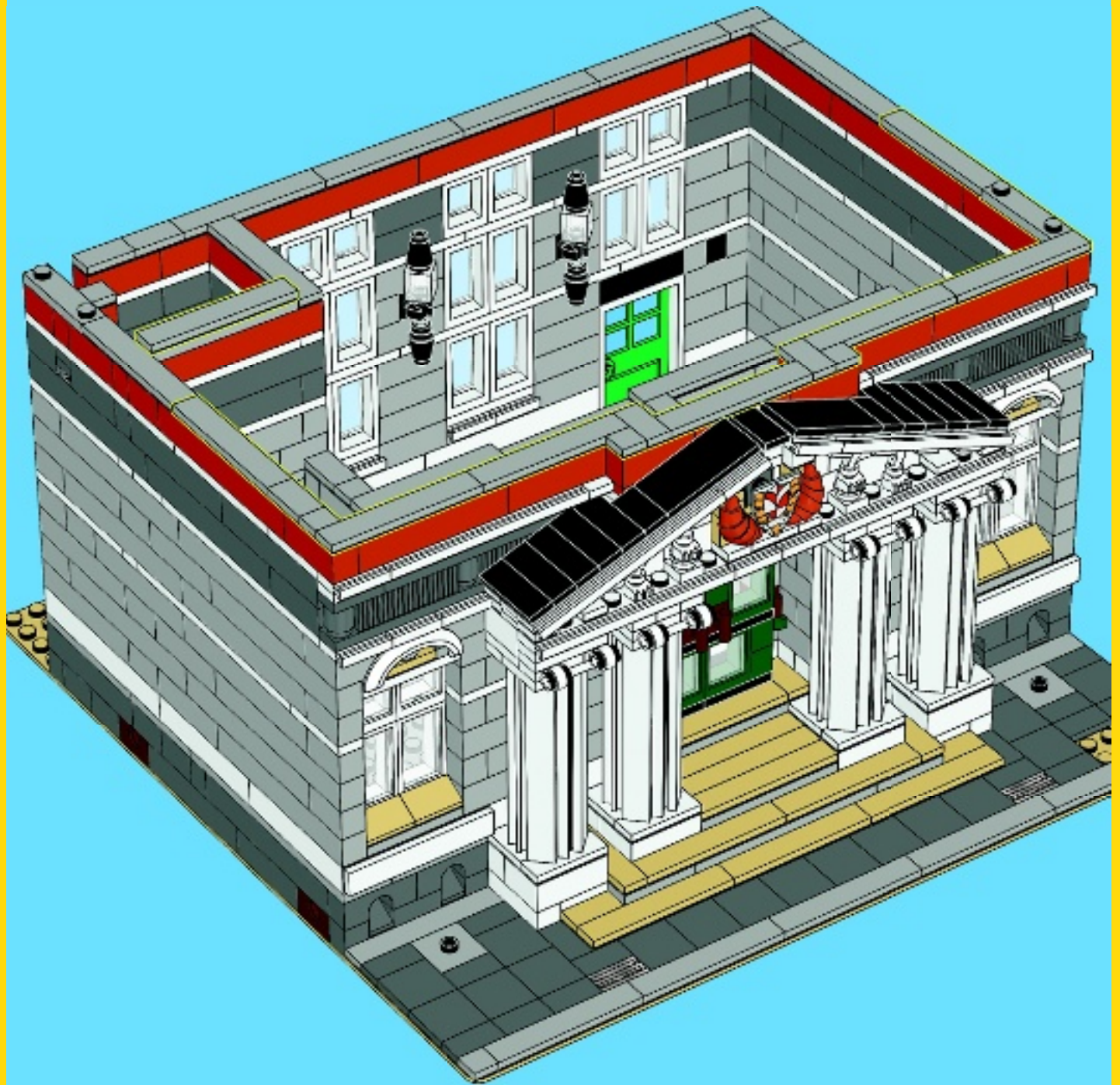



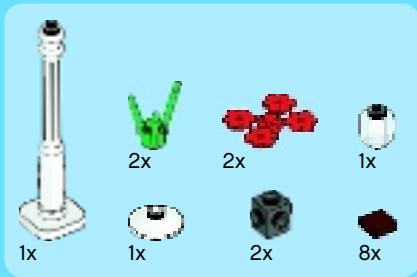

61

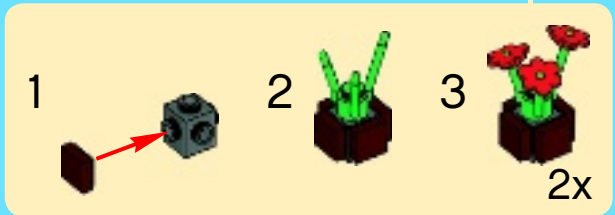
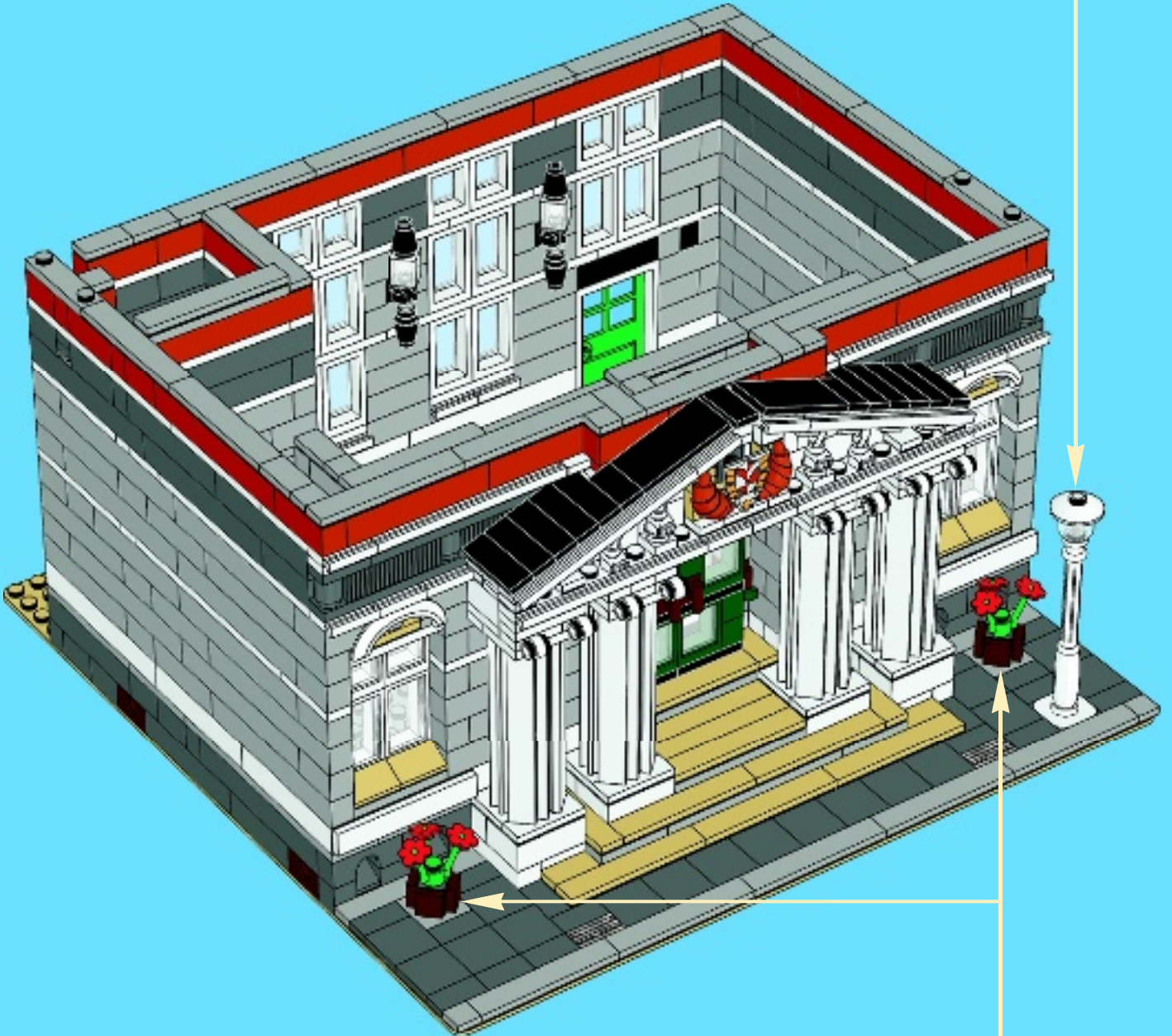
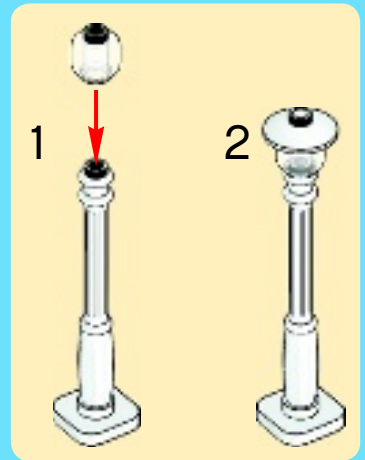



# 62

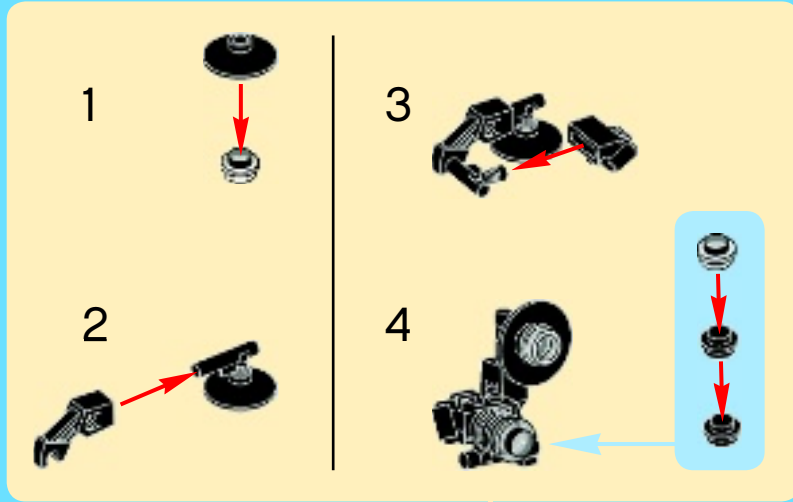



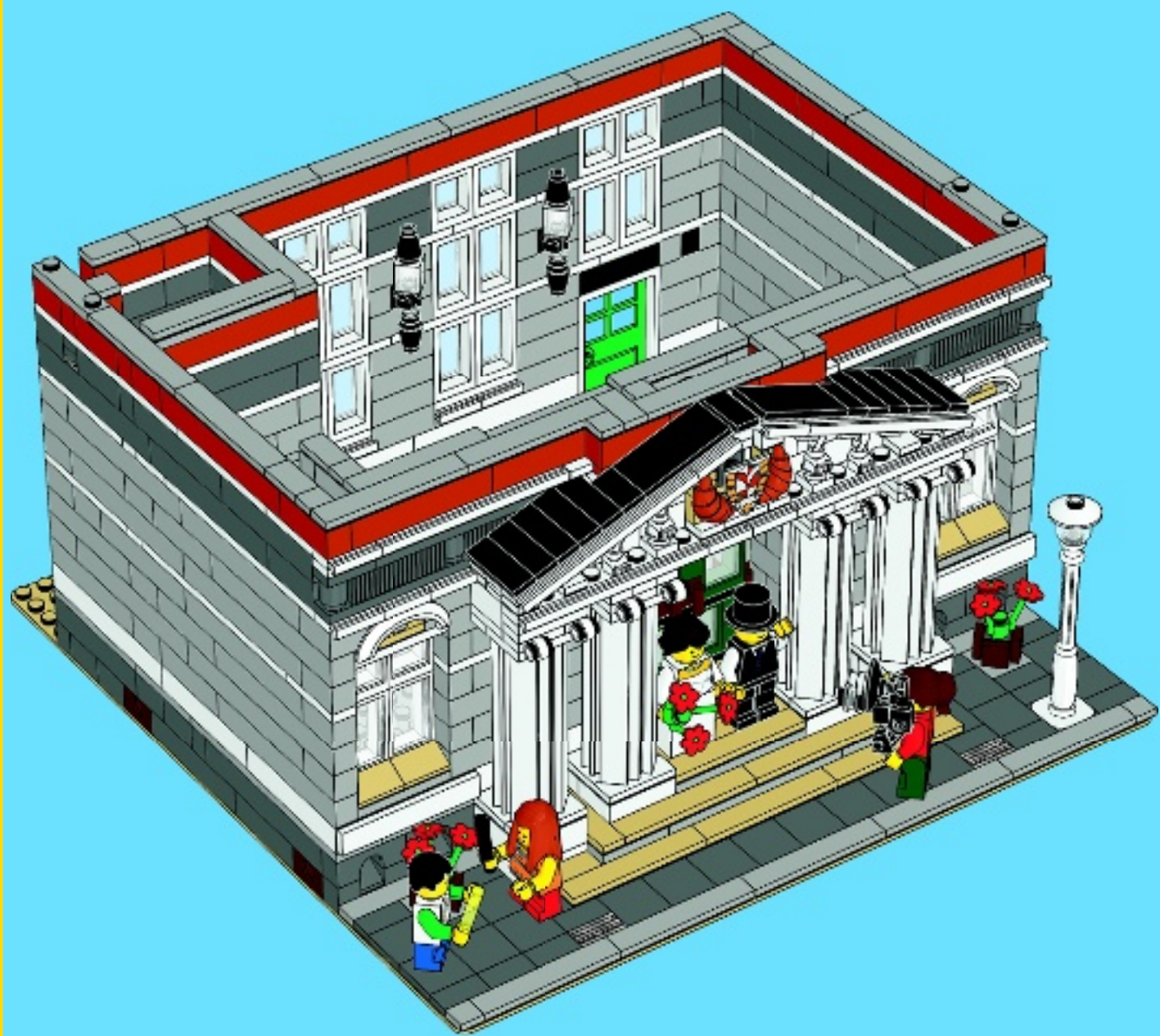



10211

10218

10224

