

TM

ENLIGHTEN

启蒙

®

Brick

TRAIN
SERIES

629

重型
客运机车

378pcs

AGES6+



Heavy Duty Passenger Locomotive

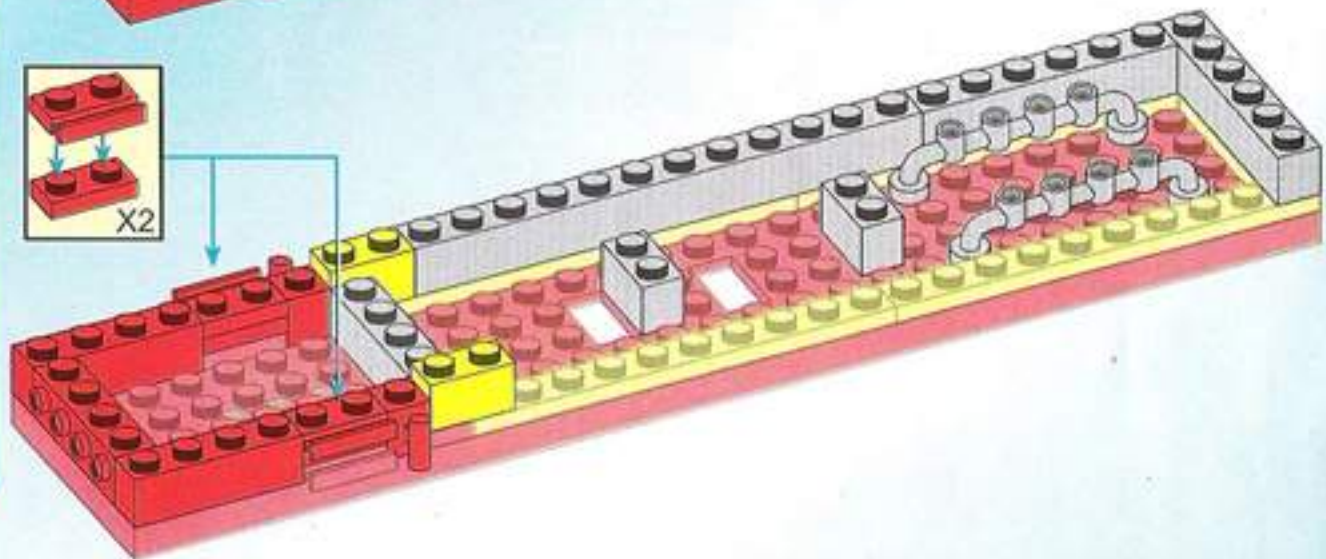
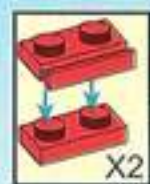
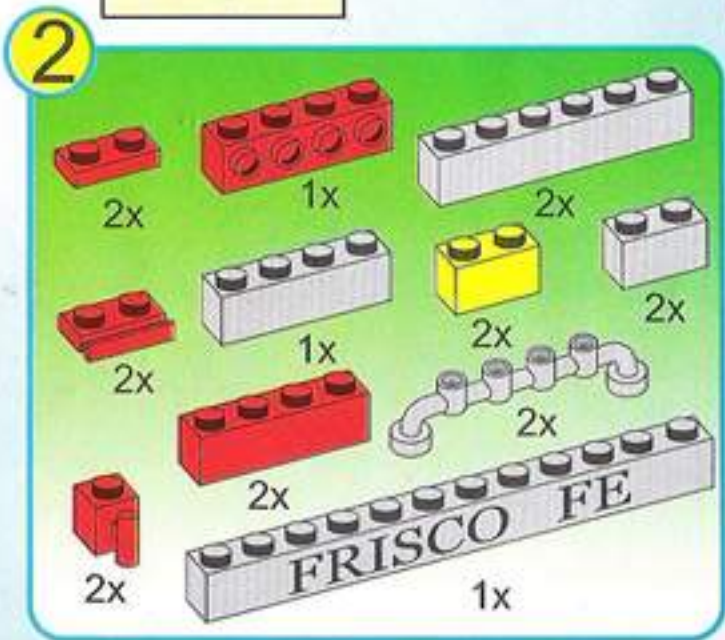
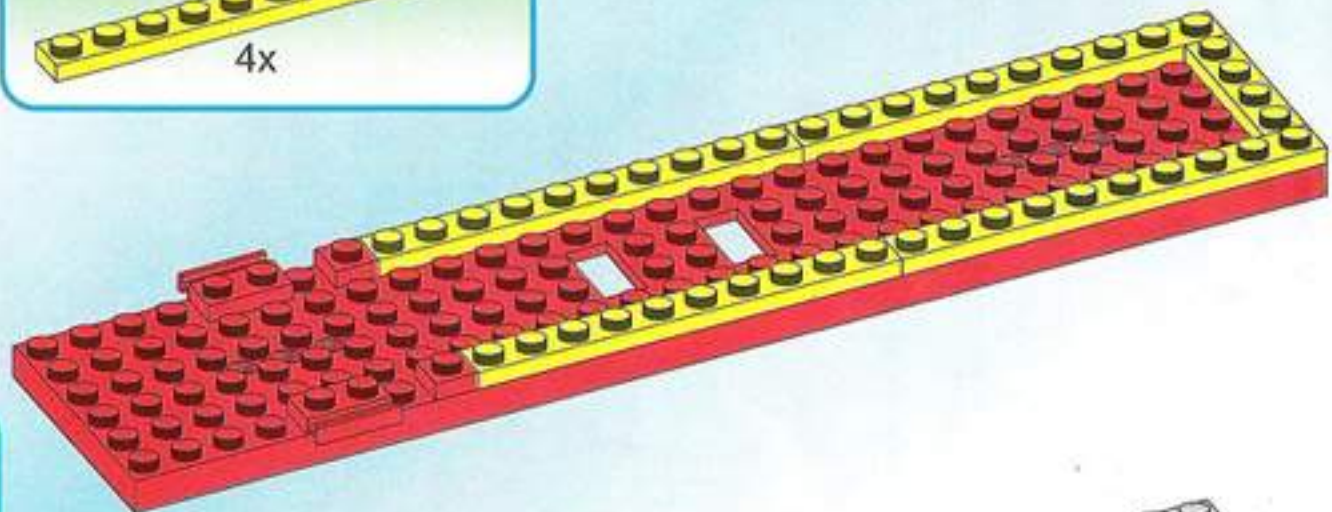
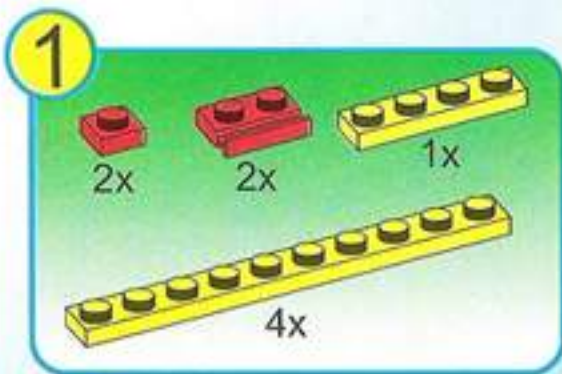
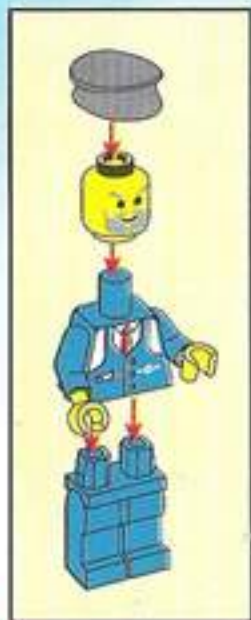

3

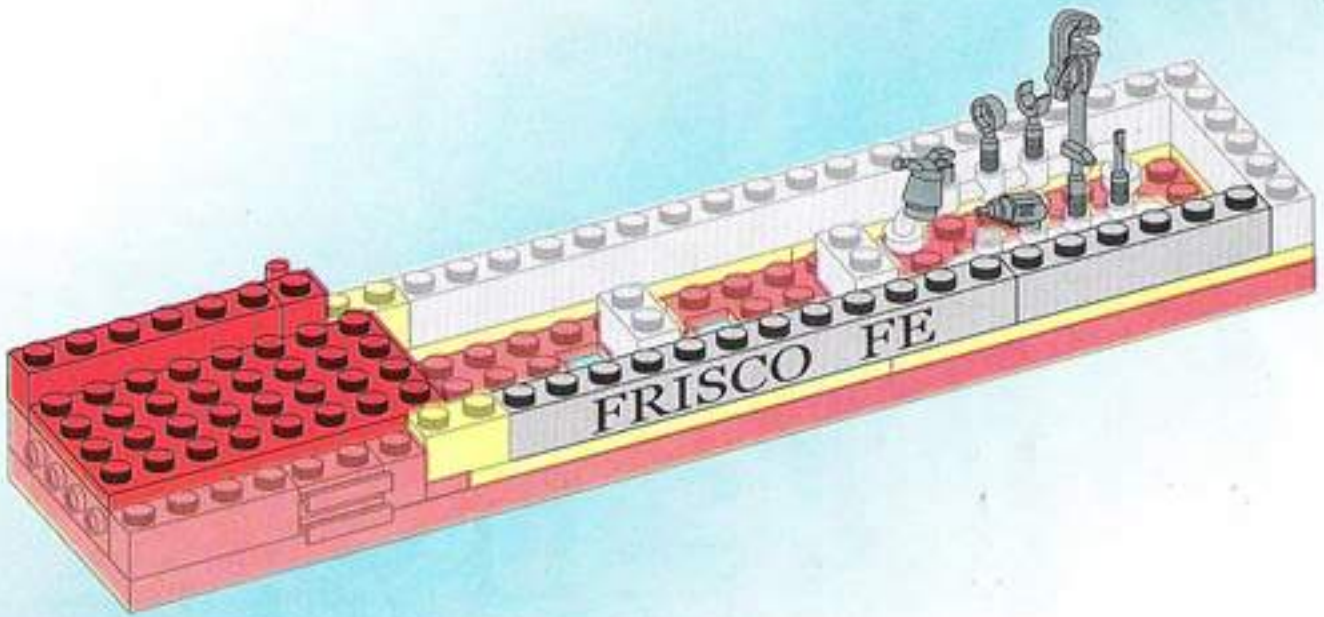
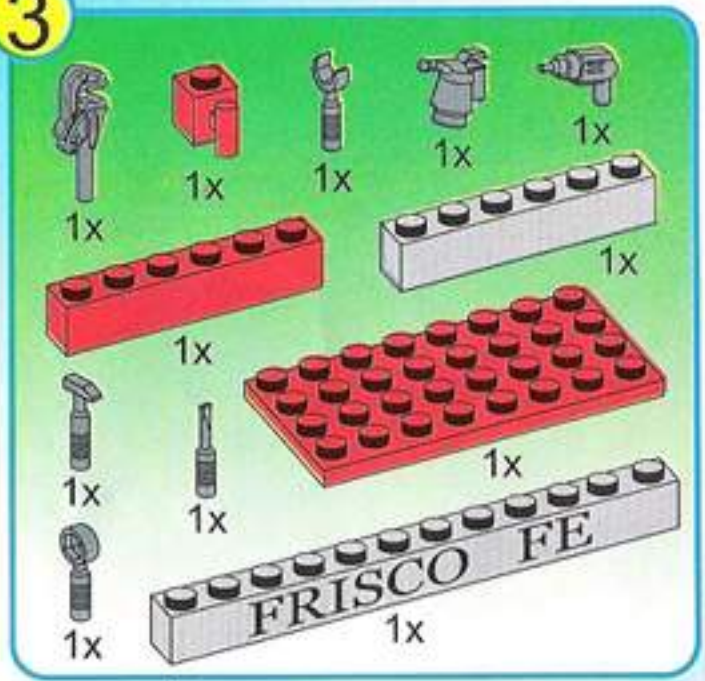

4

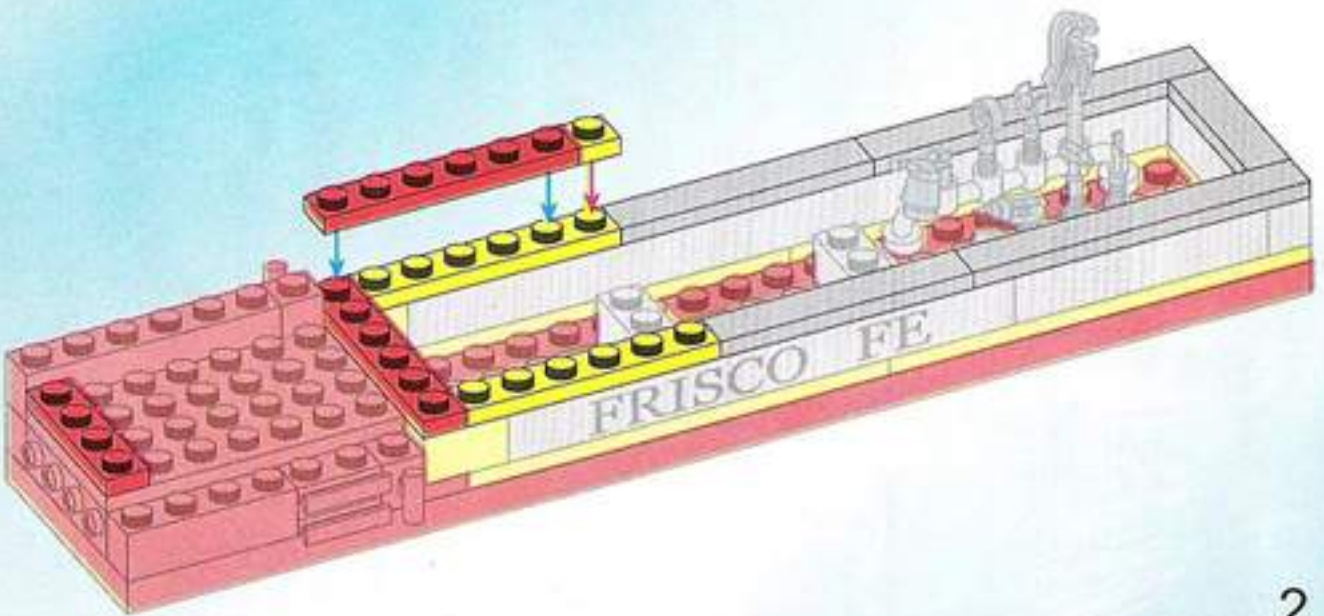
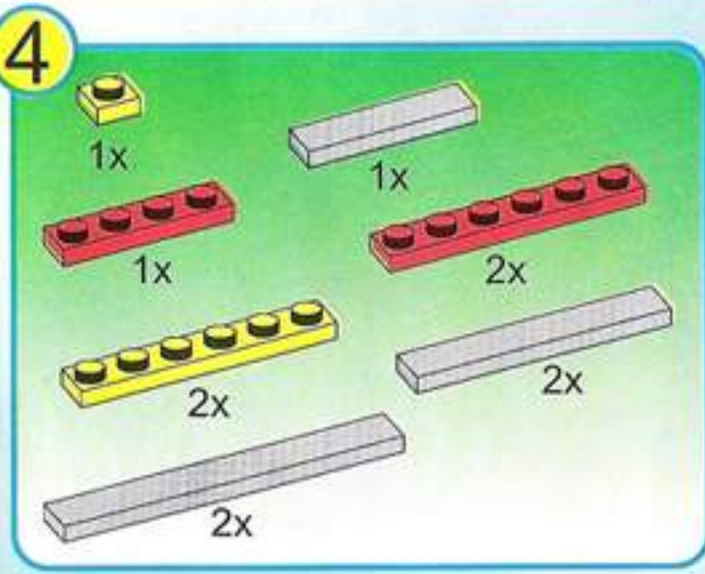

5

- 19x 2x 1x 1x
- 2x 2x 1x
- 3x 1x
- 4x 3x
- 4x 1x
- 1x 1x
- 1x 1x
- 1x 1x
- 1x 10

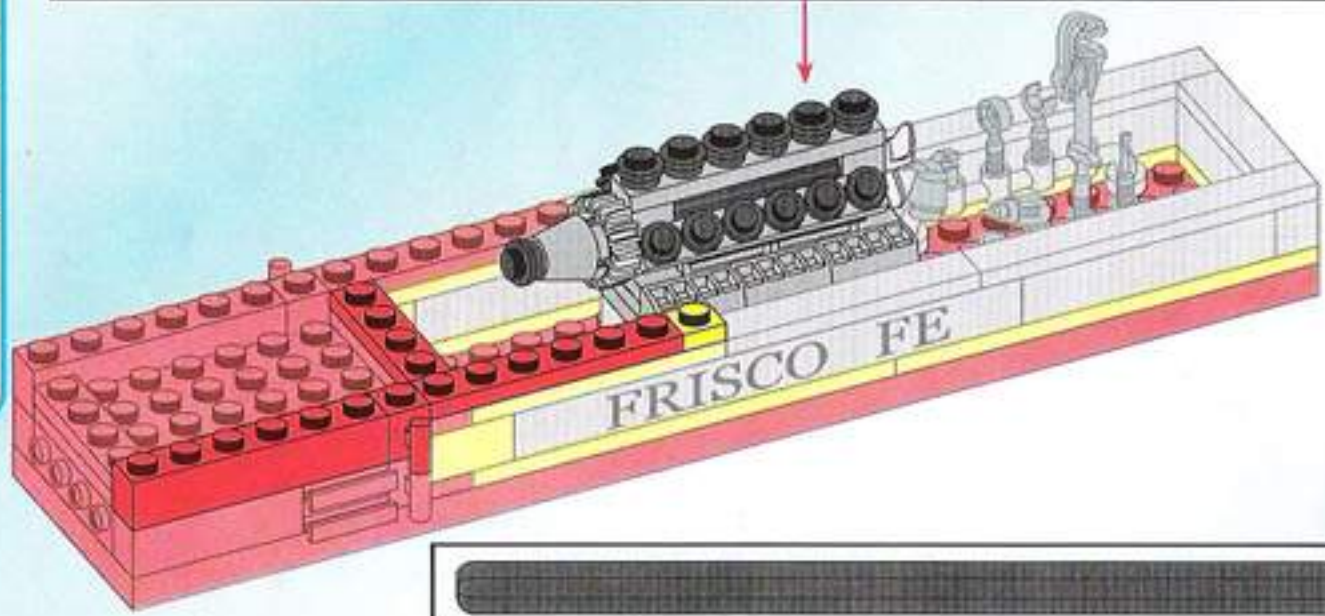
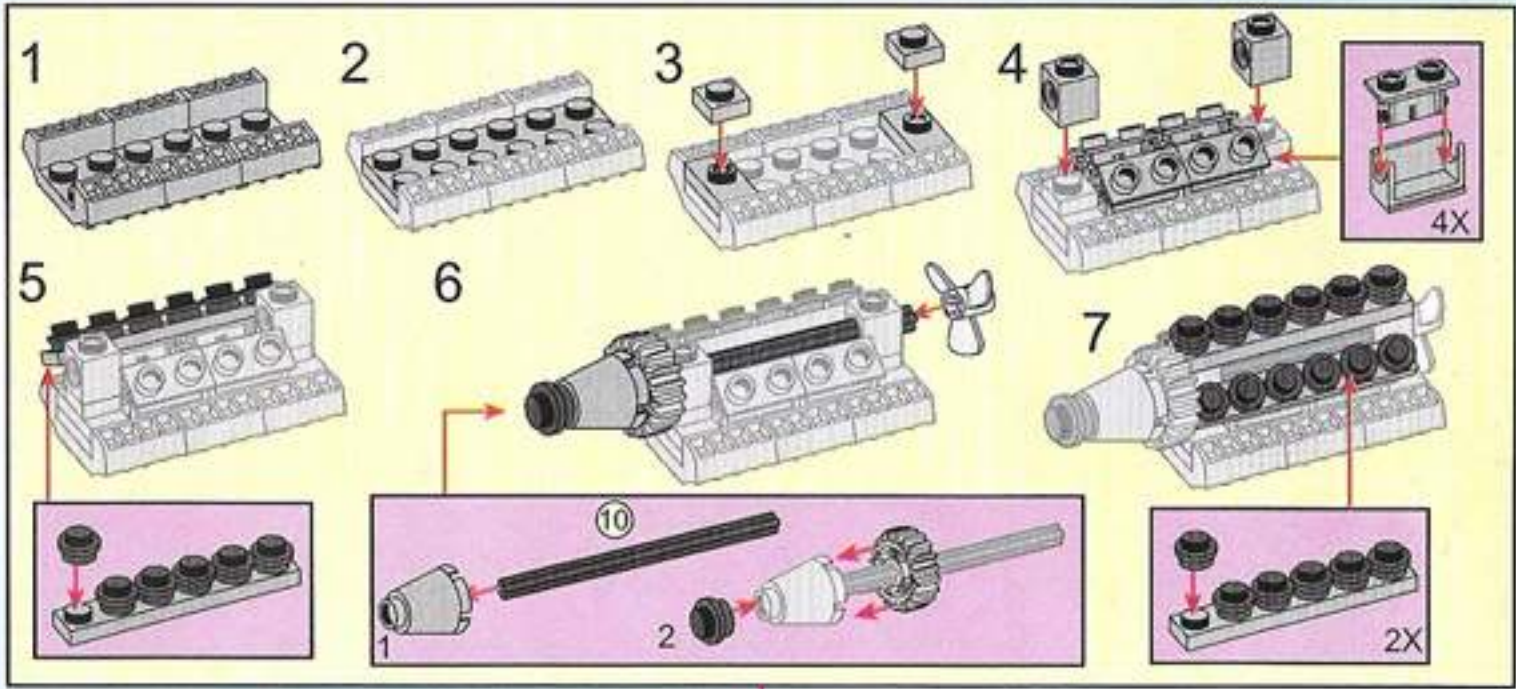

10 1:1

6

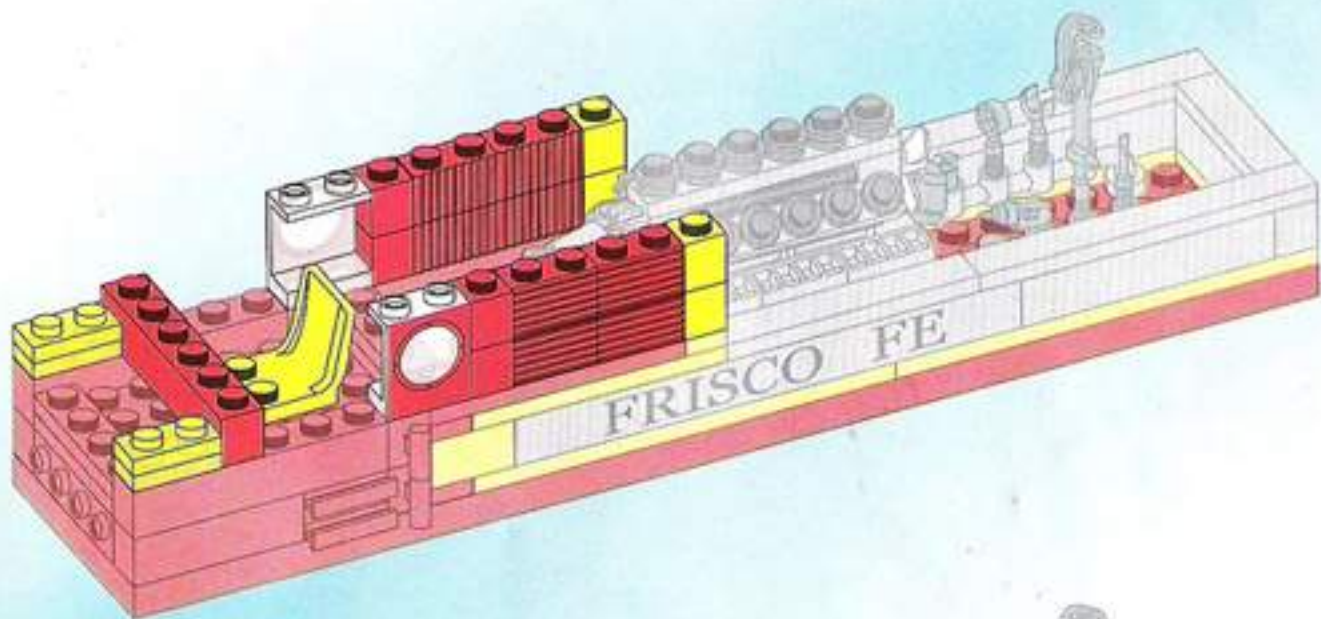
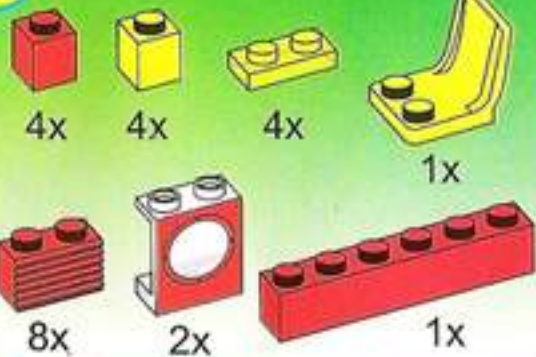

7

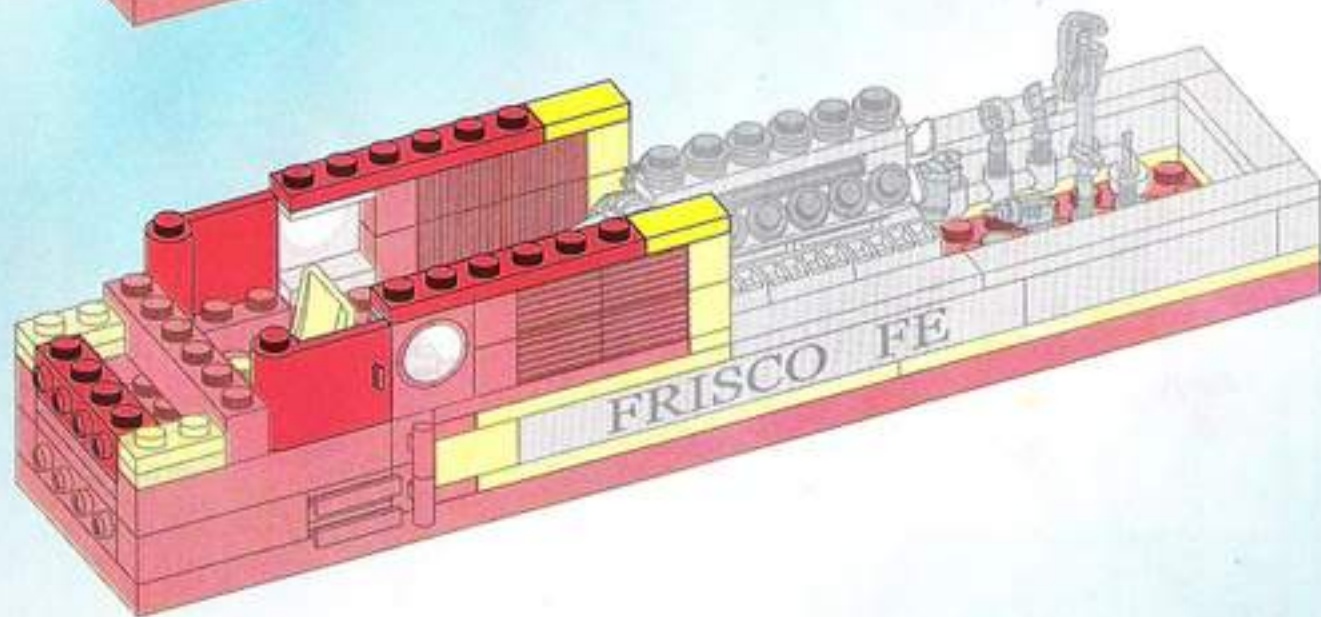
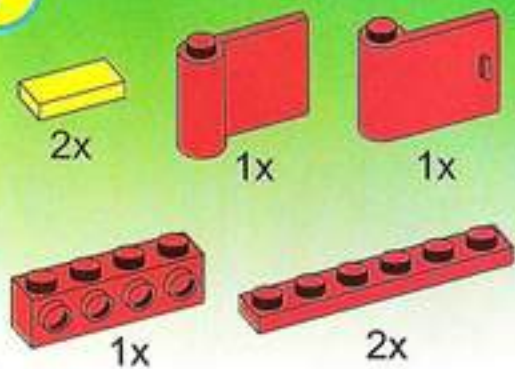

8

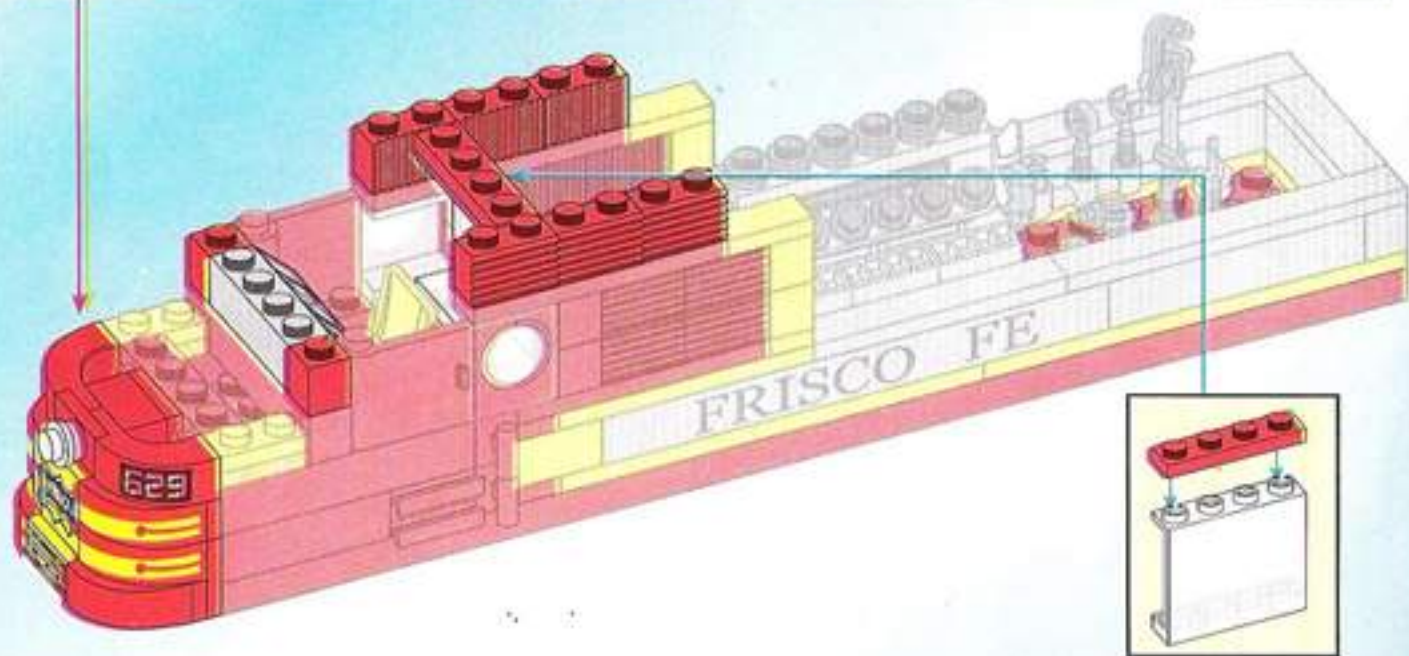
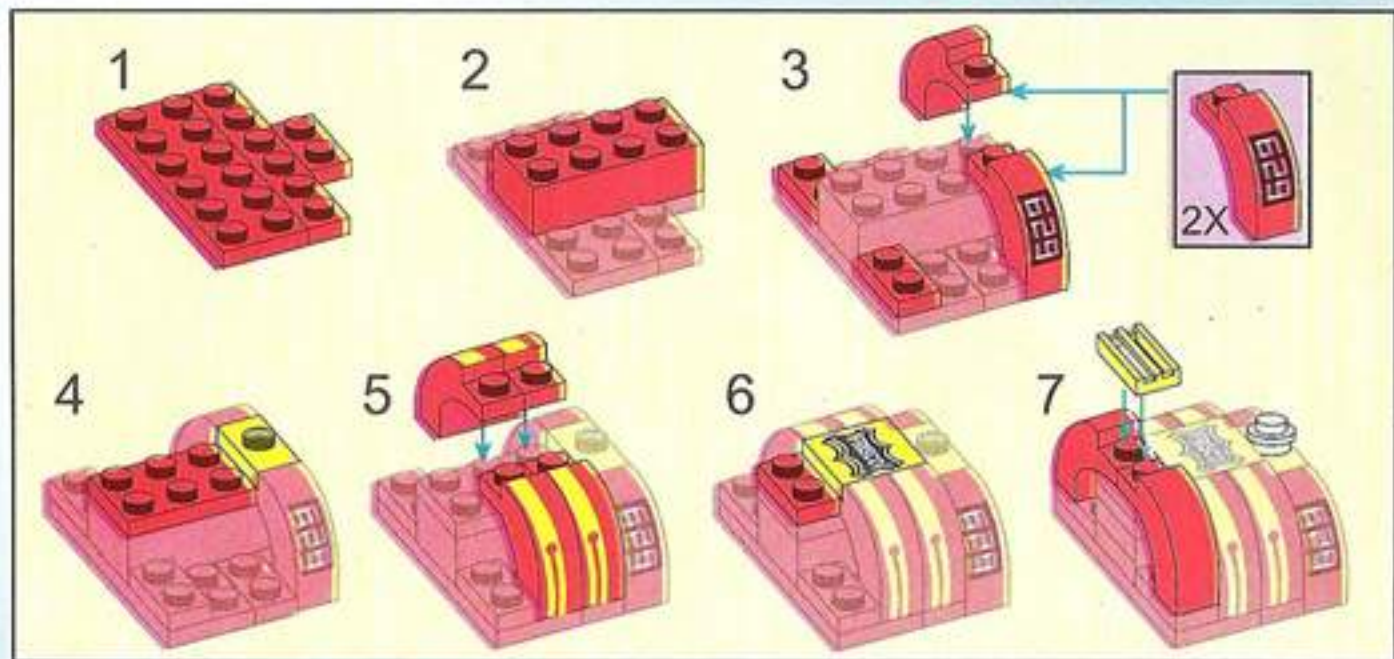
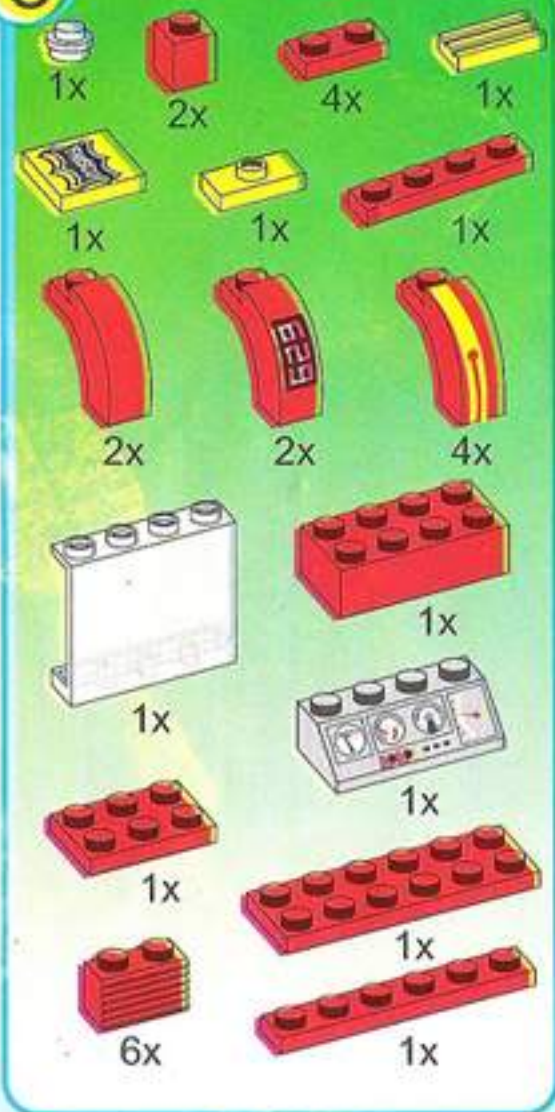

9

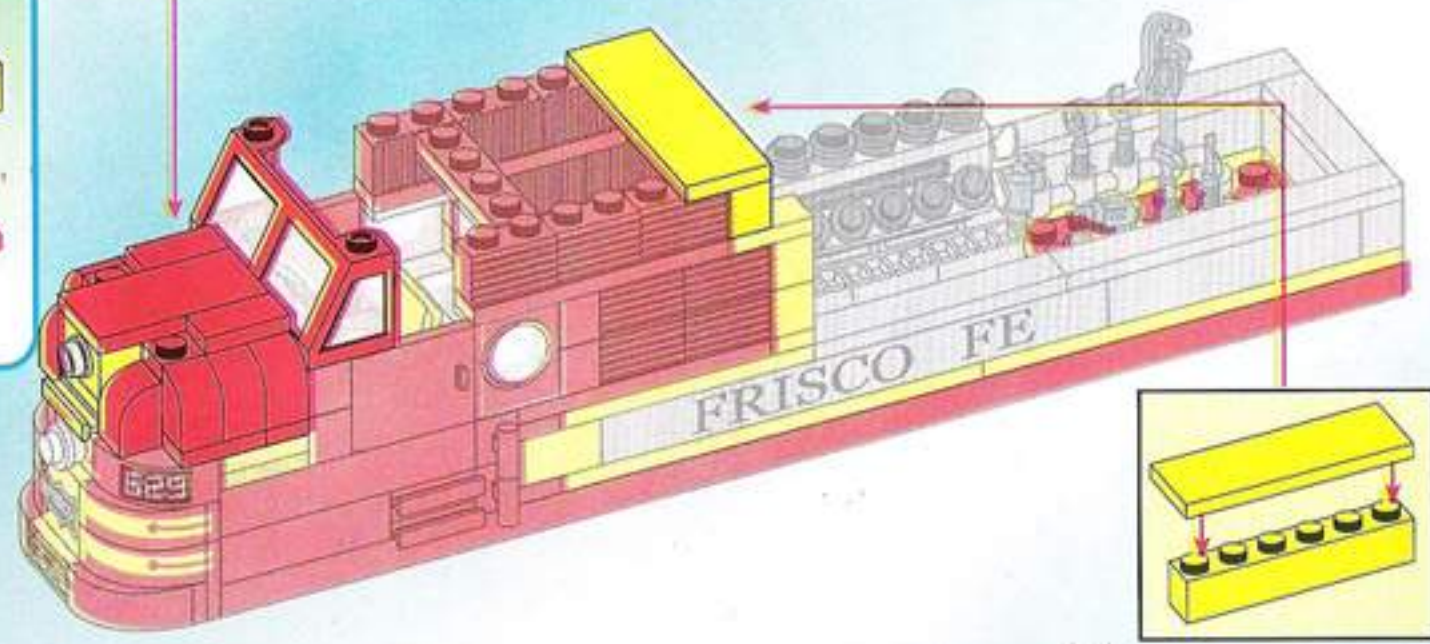
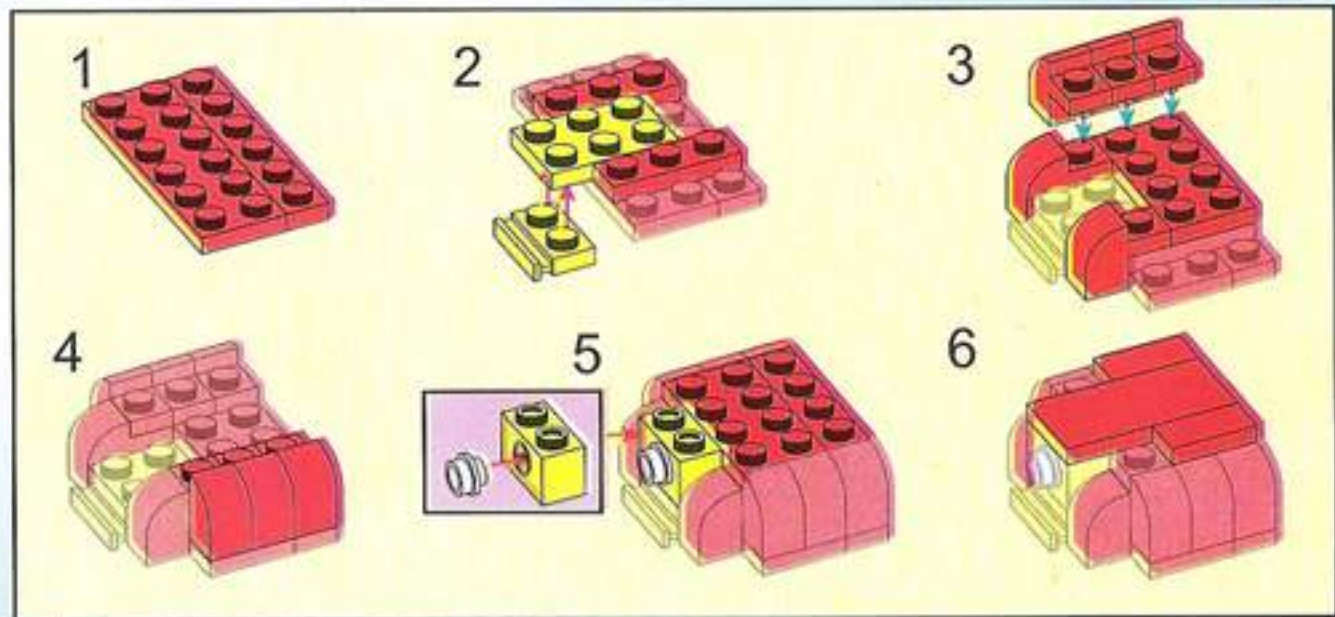
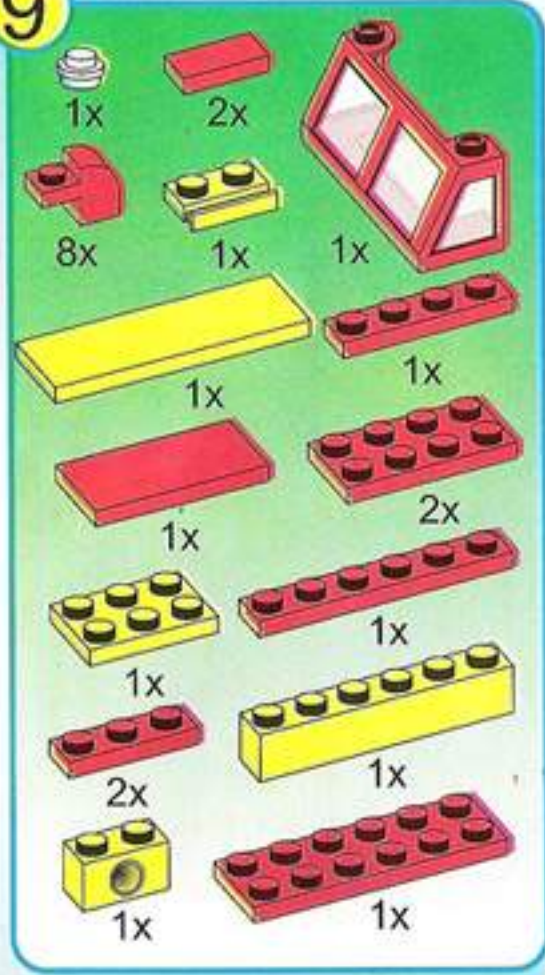

10

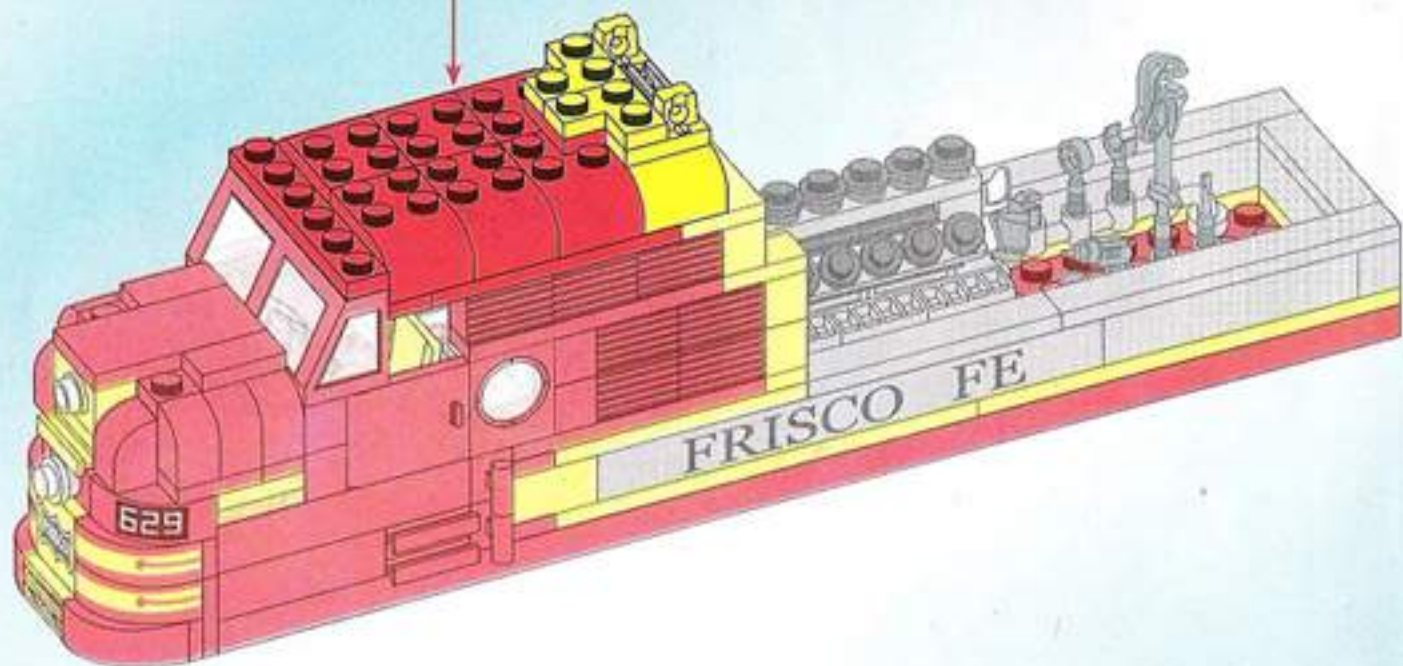
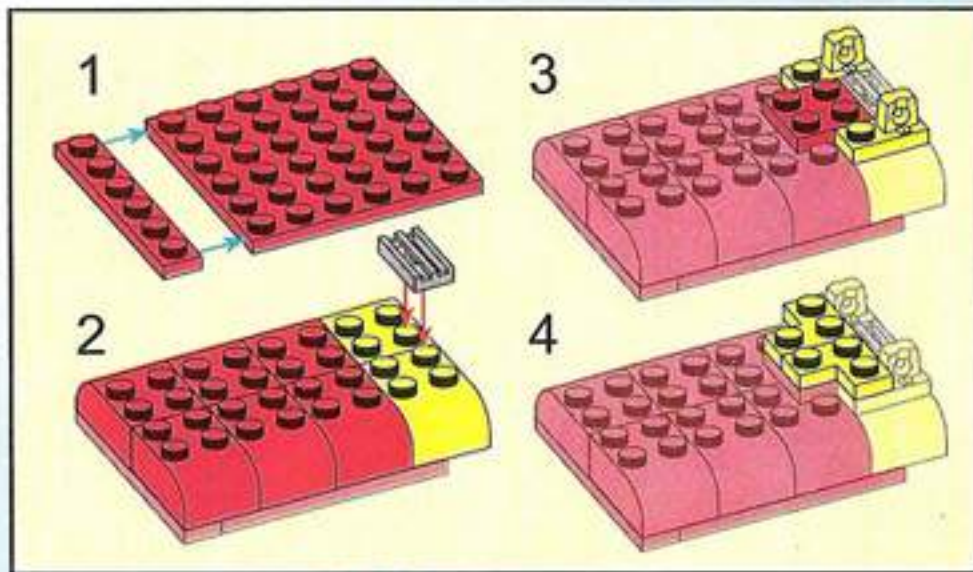
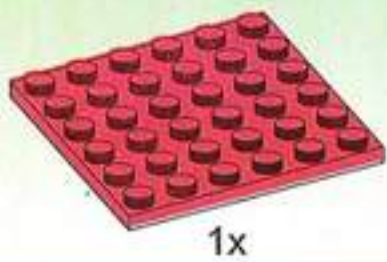
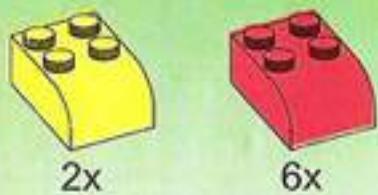

11

4x	2x	4x
10x	12x	2x
4x	4x	4x
8x		2x
4x		2x
		2x

1. A long grey 1x10 brick with a 1x2 hole at the right end.

2. A 1x4 brick with a hole is placed on top of the 1x10 brick, and a 1x2 brick is placed on top of the 1x4 brick.

3. A 1x10 brick with a hole is placed on top of the 1x4 brick, and a 1x2 brick is placed on top of the 1x10 brick.

4. A 1x10 brick with a hole is placed on top of the 1x10 brick, and a 1x2 brick is placed on top of the 1x10 brick.

5. A 1x10 brick with a hole is placed on top of the 1x10 brick, and a 1x2 brick is placed on top of the 1x10 brick.

6. A 1x10 brick with a hole is placed on top of the 1x10 brick, and a 1x2 brick is placed on top of the 1x10 brick.

7. A 1x10 brick with a hole is placed on top of the 1x10 brick, and a 1x2 brick is placed on top of the 1x10 brick.

8. A 1x10 brick with a hole is placed on top of the 1x10 brick, and a 1x2 brick is placed on top of the 1x10 brick.

9. A 1x10 brick with a hole is placed on top of the 1x10 brick, and a 1x2 brick is placed on top of the 1x10 brick.

10. A 1x10 brick with a hole is placed on top of the 1x10 brick, and a 1x2 brick is placed on top of the 1x10 brick.

12

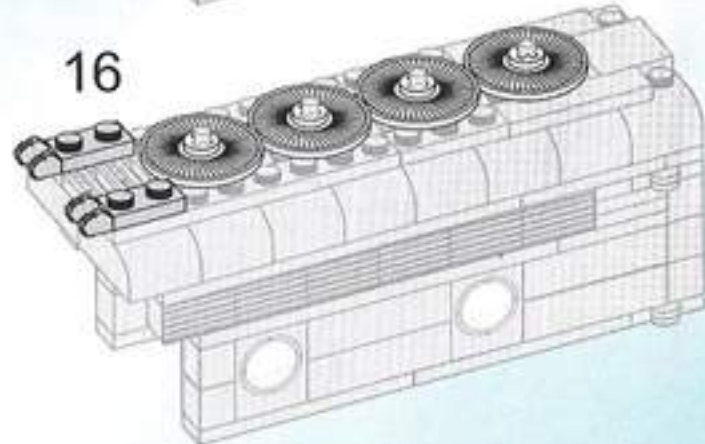
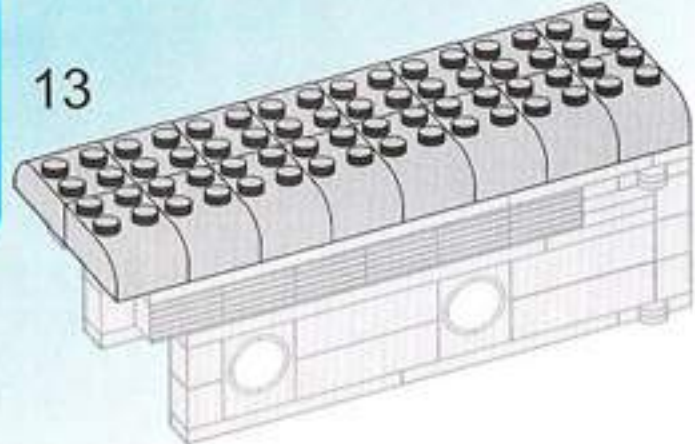
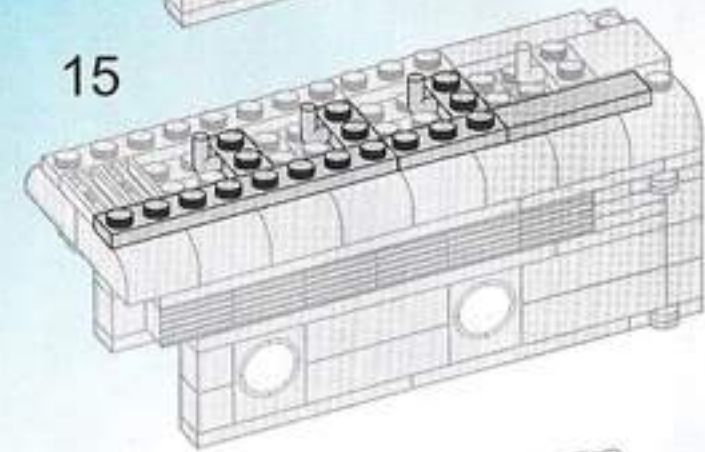
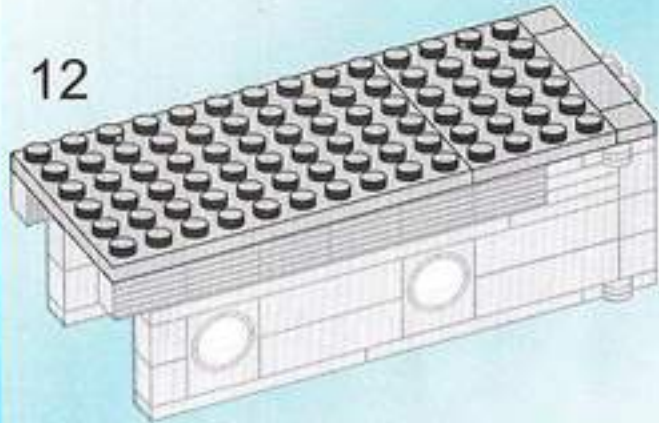
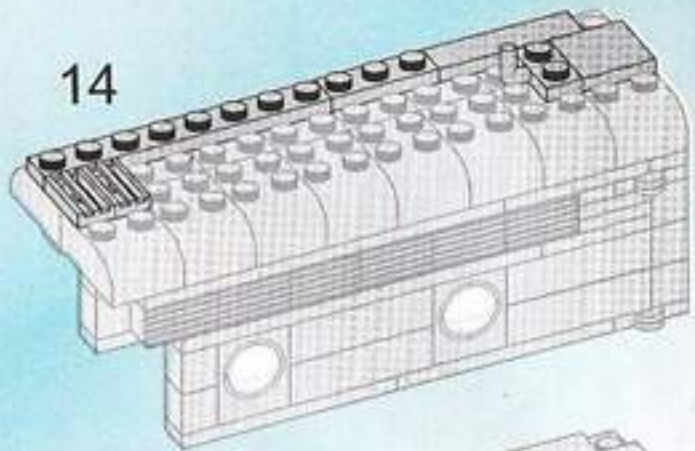
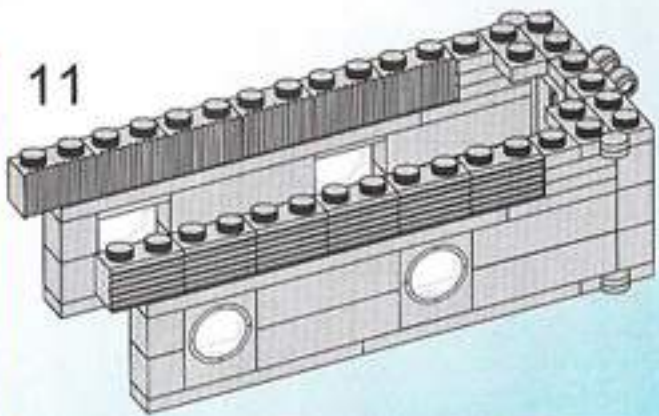
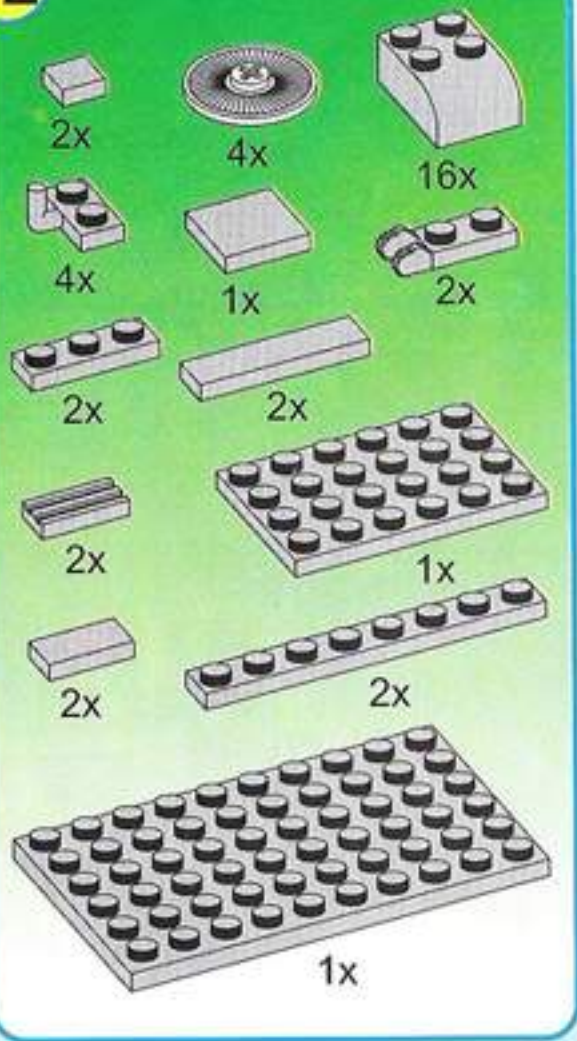

13



2x



1x



2x



1x

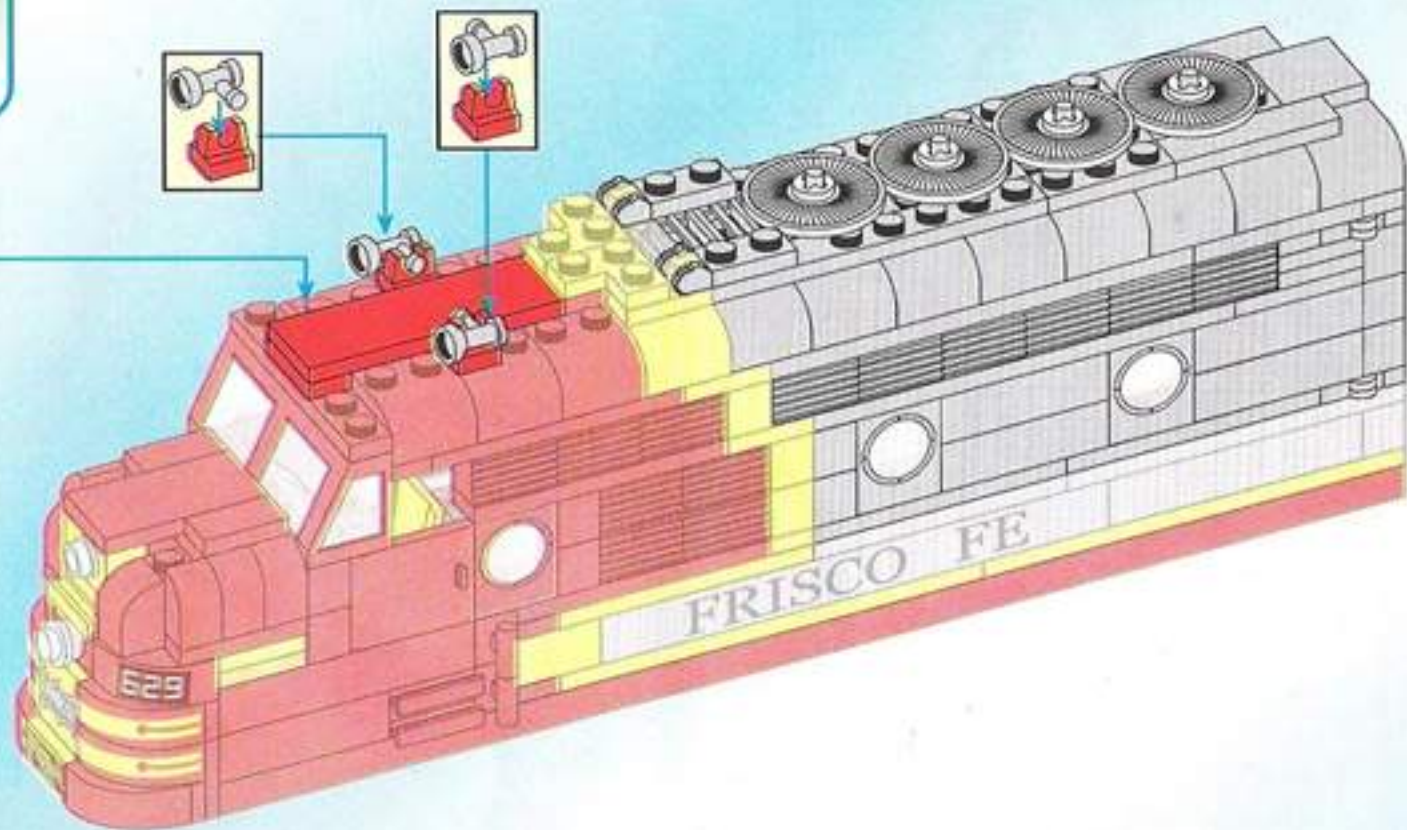
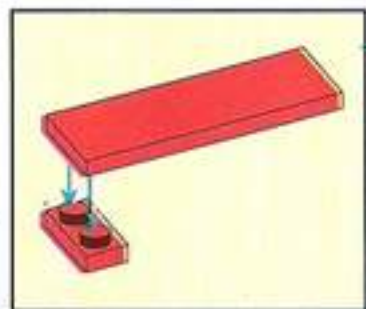

14

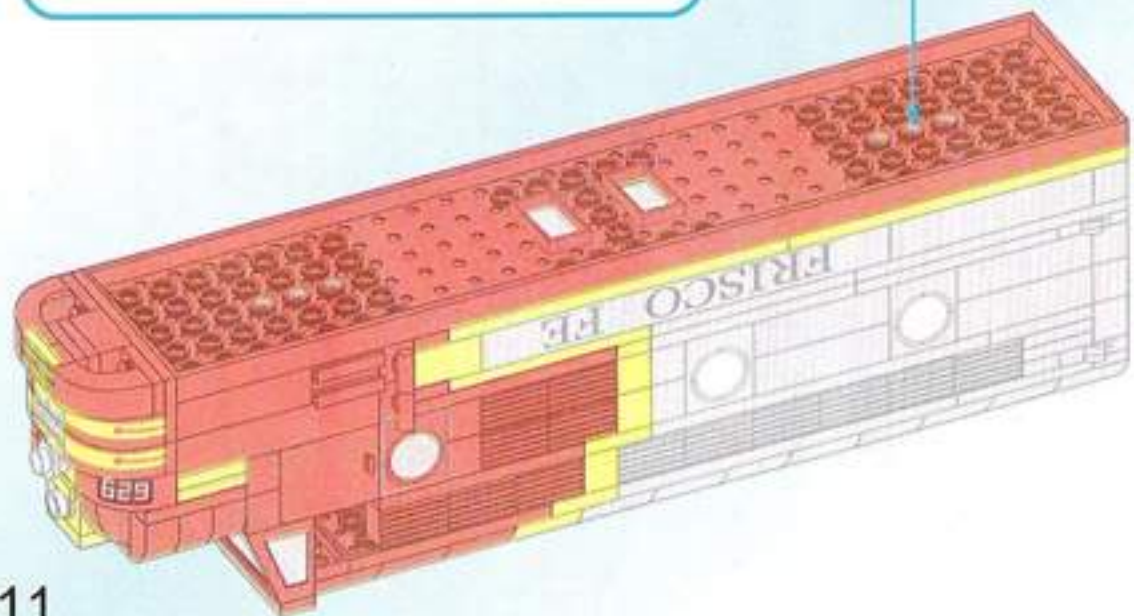
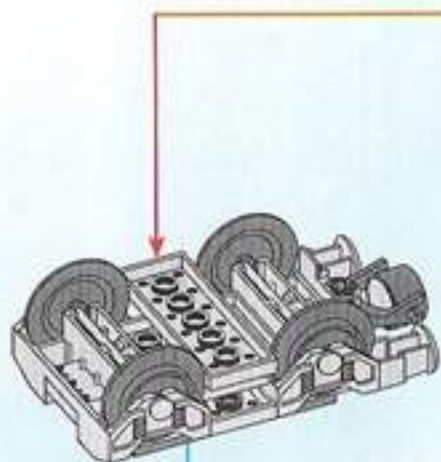
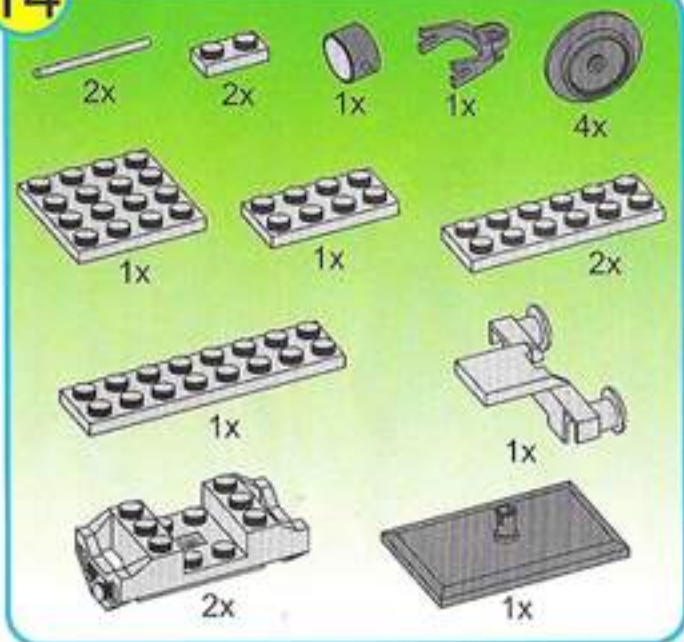

1



2



3



4



5

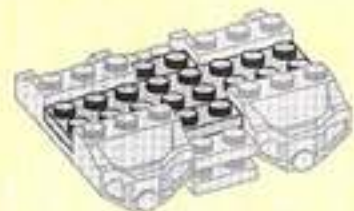

6

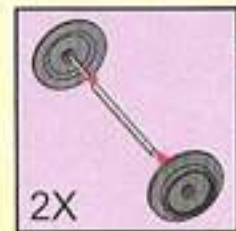
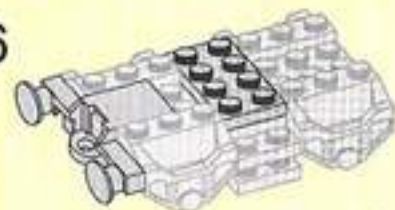

7

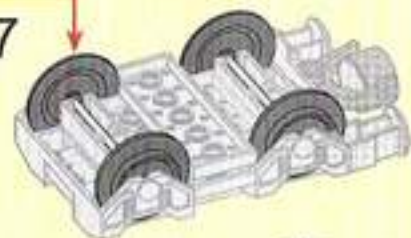

8



15

